



User Manual

SOM-DB5920

**Development Board for COM
Express Type 7 Pin-out**

ADVANTECH

Enabling an Intelligent Planet

Copyright

The documentation and the software included with this product are copyrighted 2018 by Advantech Co., Ltd. All rights are reserved. Advantech Co., Ltd. reserves the right to make improvements in the products described in this manual at any time without notice. No part of this manual may be reproduced, copied, translated or transmitted in any form or by any means without the prior written permission of Advantech Co., Ltd. Information provided in this manual is intended to be accurate and reliable. However, Advantech Co., Ltd. assumes no responsibility for its use, nor for any infringements of the rights of third parties, which may result from its use.

Acknowledgements

Intel and Pentium are trademarks of Intel Corporation.

Microsoft Windows and MS-DOS are registered trademarks of Microsoft Corp.

All other product names or trademarks are properties of their respective owners.

Product Warranty (2 years)

Advantech warrants to you, the original purchaser, that each of its products will be free from defects in materials and workmanship for two years from the date of purchase.

This warranty does not apply to any products which have been repaired or altered by persons other than repair personnel authorized by Advantech, or which have been subject to misuse, abuse, accident or improper installation. Advantech assumes no liability under the terms of this warranty as a consequence of such events.

Because of Advantech's high quality-control standards and rigorous testing, most of our customers never need to use our repair service. If an Advantech product is defective, it will be repaired or replaced at no charge during the warranty period. For out-of-warranty repairs, you will be billed according to the cost of replacement materials, service time and freight. Please consult your dealer for more details.

If you think you have a defective product, follow these steps:

1. Collect all the information about the problem encountered. (For example, CPU speed, Advantech products used, other hardware and software used, etc.) Note anything abnormal and list any onscreen messages you get when the problem occurs.
2. Call your dealer and describe the problem. Please have your manual, product, and any helpful information readily available.
3. If your product is diagnosed as defective, obtain an RMA (return merchandise authorization) number from your dealer. This allows us to process your return more quickly.
4. Carefully pack the defective product, a fully-completed Repair and Replacement Order Card and a photocopy proof of purchase date (such as your sales receipt) in a shippable container. A product returned without proof of the purchase date is not eligible for warranty service.
5. Write the RMA number visibly on the outside of the package and ship it prepaid to your dealer.

Part No. 2006592000

Printed in Taiwan

Edition 1

March 2018

Declaration of Conformity

CE

This product has passed the CE test for environmental specifications. Test conditions for passing included the equipment being operated within an industrial enclosure. In order to protect the product from being damaged by ESD (Electrostatic Discharge) and EMI leakage, we strongly recommend the use of CE-compliant industrial enclosure products.

FCC Class B

Note: This equipment has been tested and found to comply with the limits for a Class B digital device, pursuant to part 15 of the FCC Rules. These limits are designed to provide reasonable protection against harmful interference in a residential installation. This equipment generates, uses and can radiate radio frequency energy and, if not installed and used in accordance with the instructions, may cause harmful interference to radio communications. However, there is no guarantee that interference will not occur in a particular installation. If this equipment does cause harmful interference to radio or television reception, which can be determined by turning the equipment off and on, the user is encouraged to try to correct the interference by one or more of the following measures:

- Reorient or relocate the receiving antenna.
- Increase the separation between the equipment and receiver.
- Connect the equipment into an outlet on a circuit different from that to which the receiver is connected.
- Consult the dealer or an experienced radio/TV technician for help.

FM

This equipment has passed the FM certification. According to the National Fire Protection Association, work sites are classified into different classes, divisions and groups, based on hazard considerations. This equipment is compliant with the specifications of Class I, Division 2, Groups A, B, C and D indoor hazards.

Technical Support and Assistance

1. Visit the Advantech website at <http://support.advantech.com> where you can find the latest information about the product.
2. Contact your distributor, sales representative, or Advantech's customer service center for technical support if you need additional assistance. Please have the following information ready before you call:
 - Product name and serial number
 - Description of your peripheral attachments
 - Description of your software (operating system, version, application software, etc.)
 - A complete description of the problem
 - The exact wording of any error messages

Warnings, Cautions and Notes

Warning! Warnings indicate conditions, which if not observed, can cause personal injury!



Caution! Cautions are included to help you avoid damaging hardware or losing data. e.g.



There is a danger of a new battery exploding if it is incorrectly installed. Do not attempt to recharge, force open, or heat the battery. Replace the battery only with the same or equivalent type recommended by the manufacturer. Discard used batteries according to the manufacturer's instructions.

Note! Notes provide optional additional information.



Document Feedback

To assist us in making improvements to this manual, we would welcome comments and constructive criticism. Please send all such - in writing to: support@advantech.com

Selection Guide w/ P/N

Part No.	Description
SOM-DB5920-00A1	COM Express Development Board for T7 Pin-out, support 10GBASE-T
SOM-DB5920-F0A1	COM Express Development Board for T7 Pin-out, support SFP+ I/O

Packing List

Before setting up the system, check that the items listed below are included and in good condition. If any item does not accord with the table, please contact your dealer immediately.

Part No.	Description	Quantity
SOM-DB5920	COM Express Development Board	1
SOM-EA60	Mezzanine Card with 2 Ports RJ45 for 10GBase-T (for SOM-DB5920-00A1)	1
SOM-EA61	Mezzanine Card with 2 Ports SFP+ for 10G (for SOM-DB5920-F0A1)	1
SOM-EA10	PCIex4 to 4 PCIex1 Riser Card	1
1700008941	Serial ATA Cable 7P/7P 32cm	2
1960046435T	100 I/O Bracket for SOM-DB5900	1

1931000590	Screw M2.5* L: 5mm (for OCP assembly)	4
1930006864-01	Screw M3* L: 8mm	9
1910000035-01	Copper M3* L: 15mm	9

Safety Instructions

1. Read these safety instructions carefully.
2. Keep this User Manual for later reference.
3. Disconnect this equipment from any AC outlet before cleaning. Use a damp cloth. Do not use liquid or spray detergents for cleaning.
4. For plug-in equipment, the power outlet socket must be located near the equipment and must be easily accessible.
5. Keep this equipment away from humidity.
6. Put this equipment on a reliable surface during installation. Dropping it or letting it fall may cause damage.
7. The openings on the enclosure are for air convection. Protect the equipment from overheating. **DO NOT COVER THE OPENINGS.**
8. Make sure the voltage of the power source is correct before connecting the equipment to the power outlet.
9. Position the power cord so that people cannot step on it. Do not place anything over the power cord.
10. All cautions and warnings on the equipment should be noted.
11. If the equipment is not used for a long time, disconnect it from the power source to avoid damage by transient overvoltage.
12. Never pour any liquid into an opening. This may cause fire or electrical shock.
13. Never open the equipment. For safety reasons, the equipment should be opened only by qualified service personnel.
14. If one of the following situations arises, get the equipment checked by service personnel:
 - The power cord or plug is damaged.
 - Liquid has penetrated into the equipment.
 - The equipment has been exposed to moisture.
 - The equipment does not work well, or you cannot get it to work according to the user's manual.
 - The equipment has been dropped and damaged.
 - The equipment has obvious signs of breakage.
15. **DO NOT LEAVE THIS EQUIPMENT IN AN ENVIRONMENT WHERE THE STORAGE TEMPERATURE MAY GO BELOW -20° C (-4° F) OR ABOVE 60° C (140° F). THIS COULD DAMAGE THE EQUIPMENT. THE EQUIPMENT SHOULD BE IN A CONTROLLED ENVIRONMENT.**
16. **CAUTION: DANGER OF EXPLOSION IF BATTERY IS INCORRECTLY REPLACED. REPLACE ONLY WITH THE SAME OR EQUIVALENT TYPE RECOMMENDED BY THE MANUFACTURER, DISCARD USED BATTERIES ACCORDING TO THE MANUFACTURER'S INSTRUCTIONS.**

The sound pressure level at the operator's position according to IEC 704-1:1982 is no more than 70 dB (A).

DISCLAIMER: This set of instructions is given according to IEC 704-1. Advantech disclaims all responsibility for the accuracy of any statements contained herein.

Safety Precaution - Static Electricity

Follow these simple precautions to protect yourself from harm and the products from damage.

- To avoid electrical shock, always disconnect the power from your PC chassis before you work on it. Don't touch any components on the CPU card or other cards while the PC is on.
- Disconnect power before making any configuration changes. The sudden rush of power as you connect a jumper or install a card may damage sensitive electronic components.

Acronyms

Term	Define
AC'97	Audio CODEC (Coder-Decoder)
ACPI	Advanced Configuration Power Interface – standard to implement power saving modes in PC-AT systems
BIOS	Basic Input Output System – firmware in PC-AT system that is used to initialize system components before handing control over to the operating system
CAN	Controller-area network (CAN or CAN-bus) is a vehicle bus standard designed to allow microcontrollers to communicate with each other within a vehicle without a host computer
DDI	Digital Display Interface – containing DisplayPort, HDMI/DVI, and SDVO
EAPI	Embedded Application Programmable Interface Software interface for COM Express [®] specific industrial function <ul style="list-style-type: none"> ■ System information ■ Watchdog timer ■ I2C Bus ■ Flat Panel brightness control ■ User storage area ■ GPIO
GbE	Gigabit Ethernet
GPIO	General purpose input output
HDA	Intel High Definition Audio (HD Audio) refers to the specification released by Intel in 2004 for delivering high definition audio that is capable of playing back more channels at higher quality than AC'97
I2C	Inter Integrated Circuit – 2 wire (clock and data) signaling scheme allowing communication between integrated circuit, primarily used to read and load register values
ME	Management Engine
PC-AT	“Personal Computer – Advanced Technology” – an IBM trademark term used to refer to Intel based personal computer in 1990s
PEG	PCI Express Graphics
RTC	Real Time Clock – battery backed circuit in PC-AT systems that keeps system time and date as well as certain system setup parameters
SPD	Serial Presence Detect – refers to serial EEPROM on DRAMs that has DRAM Module configuration information
TPM	Trusted Platform Module, chip to enhance the security features of a computer system
UEFI	Unified Extensible Firmware Interface
WDT	Watch Dog Timer

Contents

Chapter 1	General Information	1
1.1	Introduction	2
1.2	Functional Block Diagram	2
1.2.1	Pin Description.....	3
Chapter 2	Mechanical Information	5
2.1	Board Information.....	6
	Figure 2.1 Board image - Front.....	6
2.2	Mechanical Drawing.....	7
	Figure 2.2 SOM-DB5920 Board Mechanical Drawing - Front.....	7
	Figure 2.3 SOM-DB5920 Board Mechanical Drawing - Side.....	7
	Figure 2.4 SOM-EA60 Board Mechanical Drawing - Front.....	8
	Figure 2.5 SOM-EA60 Board Mechanical Drawing - Side	8
2.3	Assembly Drawing	9
	Figure 2.6 Assembly Drawing - COM Express to SOM-DB5920.	9
	Figure 2.7 Assembly Drawing - 10G OCP card to SOM-DB5920	9
Chapter 3	Connectors and Jumper Settings	11
3.1	SOM-DB5920 Connectors and Jumper Settings	12
3.1.1	SOM-DB5920 Connector Location	12
3.1.2	SOM-DB5920 Connector Pin Definition.....	12
	Table 3.1: GPIO1 GPIO Pin Header.....	12
	Table 3.2: LPC_PH1 Low Pin Count Pin Header	13
	Table 3.3: SYS_FAN1 System Fan Connector	13
	Table 3.4: CPU_FAN1 Smart Fan Connector	13
	Table 3.5: I2C1 I2C Wafer Box.....	14
	Table 3.6: SMB1 SMBus Wafer Box	14
	Table 3.7: BH1 RTC Battery Connector	14
	Table 3.8: DCIN1 Wide Range DC Input Connector1	15
	Table 3.9: USB2_45 USB2.0 Port4 & Port5 Connector.....	15
	Table 3.10: DCIN2 Wide Range DC Input Connector2	15
	Table 3.11: SPI_CN1 SPI BIOS Pin Header	16
3.1.3	I/O Connector Location.....	16
3.1.4	Button Location	16
3.1.5	Jumper and Switch Location.....	17
	Table 3.12: BIOS_DIS0/IOS_DIS1 BIOS Disable0, BIOS Disable1	17
	Table 3.13: J8, J9 SOM-D5900 Voltage Input (VIN) Selection... 17	
	Table 3.14: J14 ATX / AT Mode Selection	18
	Table 3.15: J11 COMe Module +V5SB Supply	18
	Table 3.16: J15 Carrier Board SPI power supply	18
	Table 3.17: J20 COMe Module TPM Disable	18
	Table 3.18: J21 Carrier Board TPM Disable.....	19
	Table 3.19: J16 Front Panel Connector.....	19
	Table 3.20: J18 Normal Operation / Clear COMS Selection	19
	Table 3.21: CB_PWROK Power ok signal Pull Down/Floating Se-	19
	lection	19
	Table 3.22: J19 BMC Software Enable Disable Selection.....	20
	Table 3.23: J100 10G PHY SEL Selection	20
	Table 3.24: J102 PCIE0 to slot or BMC SEL.....	20
	Table 3.25: J103 PCIE4 to slot or BMC SEL.....	20

	Table 3.26: J1 GPIO_SDIO_SEL	20
	Table 3.27: J104 USB2.0 port to BMC or connector SEL	21
	Table 3.28: J106 ESPI Reset SEL	21
	Table 3.29: J107 ESPI EN & Disable SEL	21
	Table 3.30: J108 COM Module 10G PHY SEL	21
	Table 3.31: J101 OCP MDIO I2C SEL	21
	Table 3.32: J116 Type7 Select SEL	22
	Table 3.33: J117 BATLOW#	22
	Table 3.34: J118 SMB_ALT#	22
	Table 3.35: SW_LPC_TPM1 & SW_LPC_TPM2 TPM Enable/Disable Switch	23
3.1.6	LED Location	23
3.1.7	LED Function List	23
	Table 3.36: LED Function List	23
3.1.8	Connector List	24
	Table 3.37: Connector List	24
3.1.9	Jumper, Switch, Button List	24
	Table 3.38: Jumper, Switch, Button List	24

Chapter 1

General Information

This chapter gives background information of the SOM-DB5920 Type 7 compatible carrier board

Sections include:

- Introduction
- Functional Block Diagram
- Product Specification

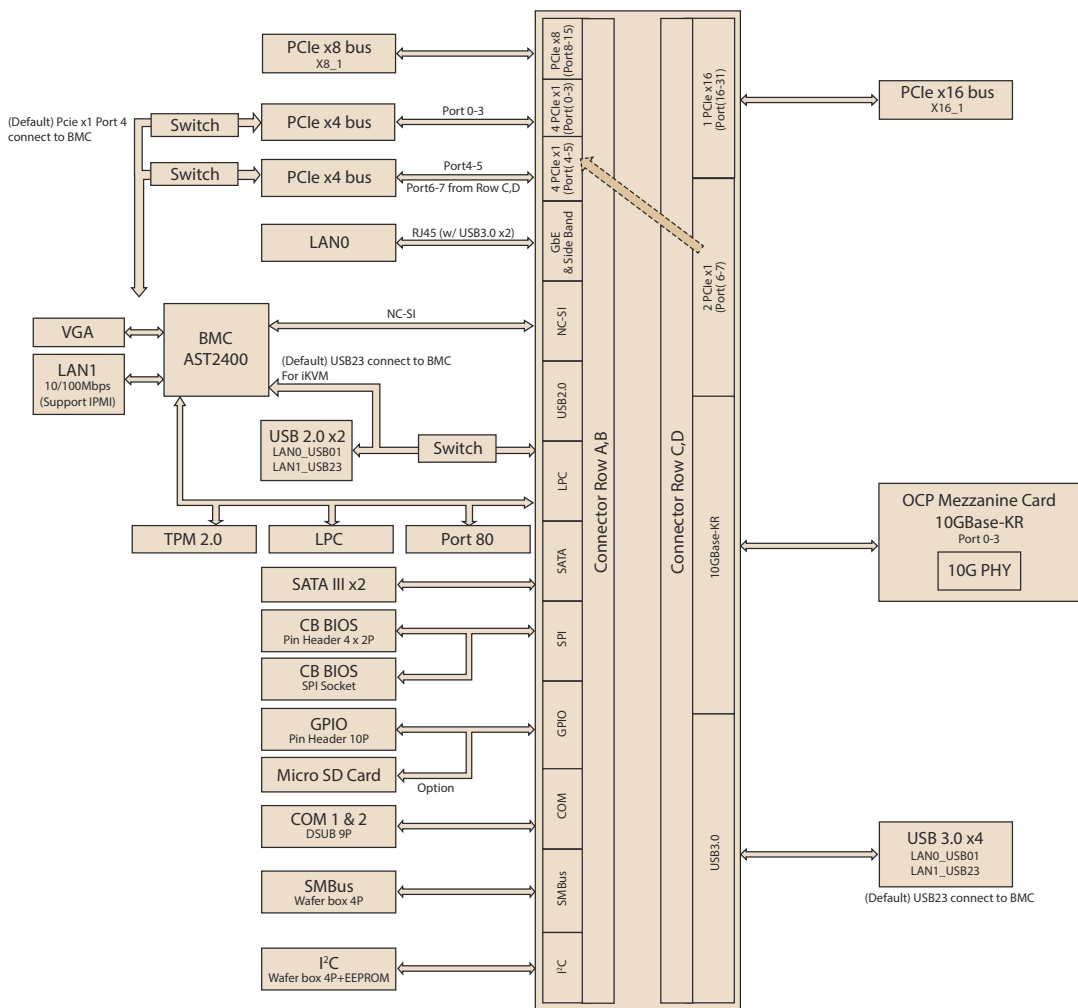
1.1 Introduction

SOM-DB5920 is a new development carrier board for COM Express Type 7 Pin-out modules. It complies with PICMG COM.0 R 3.0 and supports 10GB Ethernet I/O SOM-EA60 series OCP cards designed with 10GB PHY chips. SOM-DB5920 has a built in BMC controller which supports IPMI and iKVM for server application environments, so users can connect to the system from external computers for remote management, power on or off under DOS, or BIOS upgrades without entering the OS. With the VGA function on the BMC, users can easily test or monitor the system status directly without any external graphics card. Customers can emulate and test any required functions on SOM-DB5920 as a reference design board, or sometimes customers may want to integrate the SOM-DB5920 directly into their product as an application board.

Note! *Server grade processors often come without graphics support. For instance, COM Express SOM-5992 is designed by Intel Xeon-D, this platform does not offer graphics.*



1.2 Functional Block Diagram



1.2.1 Pin Description

Advantech provides useful checklists for schematic design and layout routing. The schematic checklist will specify details about each pin's electrical properties and how to connect for different purposes. The layout checklist will specify the layout constraints and recommendations for trace length, impedance, and other necessary information during design.

Please contact your nearest Advantech branch office or call to get your hands on the design documents and further advanced support.

Chapter 2

Mechanical Information

This chapter gives mechanical information on the SOM-DB5920 Type 7 compatible Carrier Board

Sections include:

- Board Information
- Mechanical Drawing
- Assembly Drawing

2.1 Board Information

The figures below indicate the main COM Express module locations on this carrier board. 10GB LAN cards are designed as an OCP mezzanine card. There are two types of 10GB LAN cards with different 10G PHY chips by part number, one supports copper cable via RJ45 connectors and the other supports fiber cable by SFP+ connectors. Users can test LAN functions by different mediums via the corresponding OCP card of this carrier board.

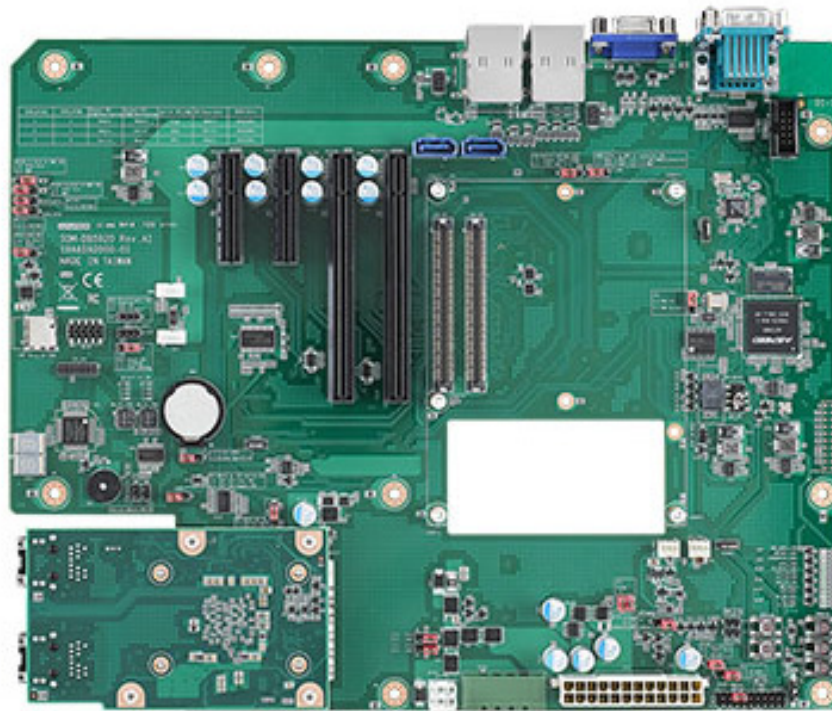


Figure 2.1 Board image - Front

2.2 Mechanical Drawing

For more detail about 2D/3D models, please find on Advantech COM support service website <http://com.advantech.com>.

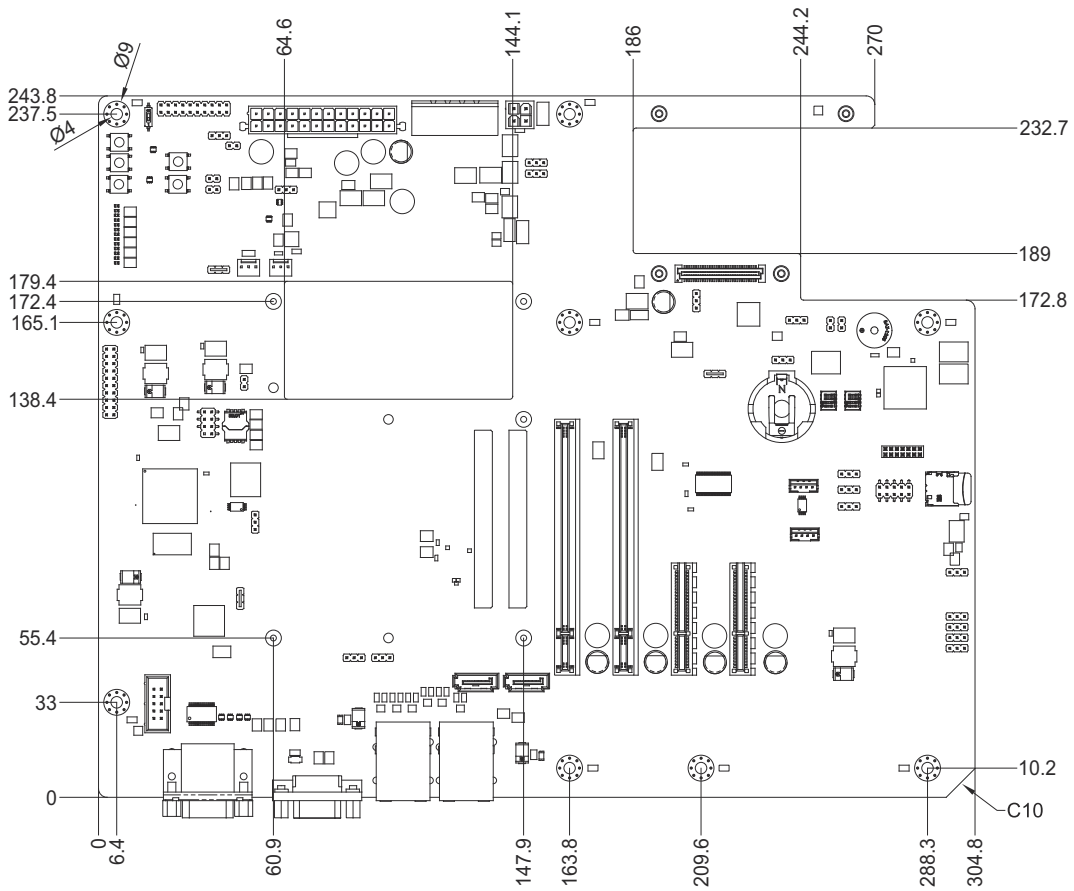


Figure 2.2 SOM-DB5920 Board Mechanical Drawing - Front

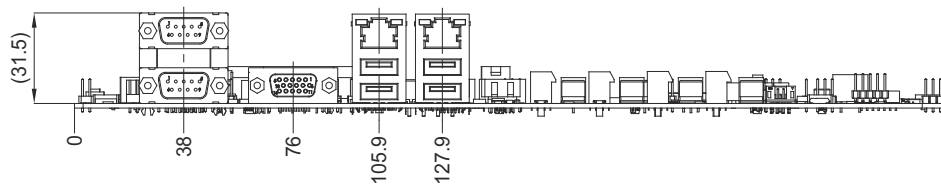


Figure 2.3 SOM-DB5920 Board Mechanical Drawing - Side

2.3 Assembly Drawing

These figures demonstrate the assembly order of the thermal module, and COM Express Basic module to the carrier board.

For the 10GB LAN OCP card (SOM-EA60/SOM-EA61), the heat sink of the 10G PHY will be assembled on the board before shipment. Please attach the OCP card to SOM-DB5920 directly via the onboard connectors and four standoffs as shown in figure 2.7.

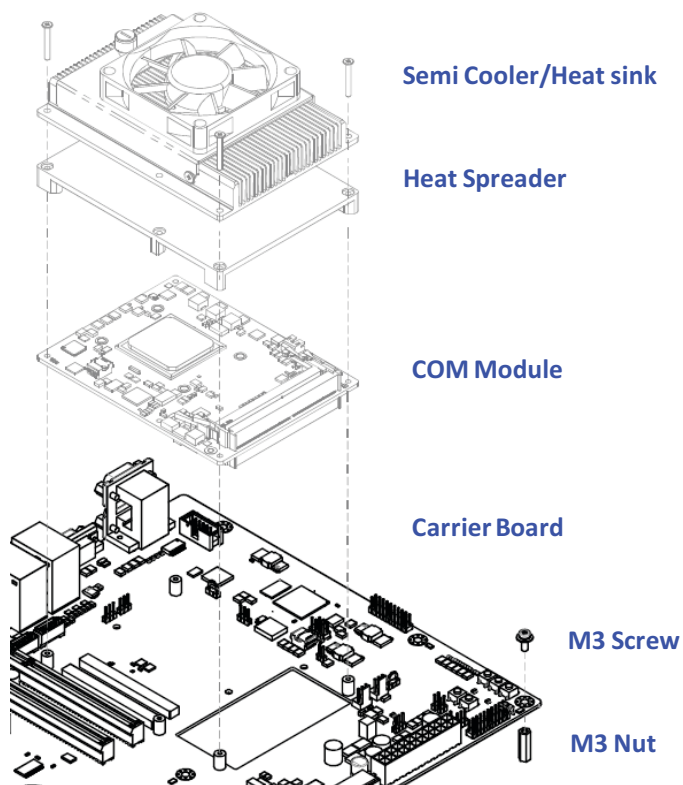


Figure 2.6 Assembly Drawing - COM Express to SOM-DB5920

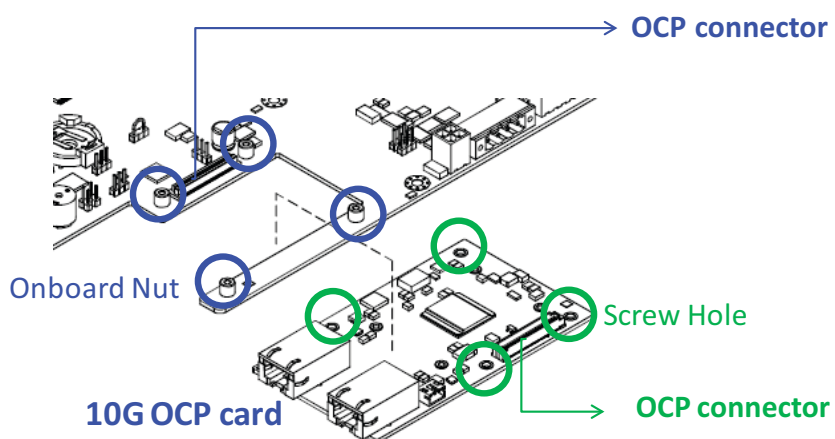


Figure 2.7 Assembly Drawing - 10G OCP card to SOM-DB5920

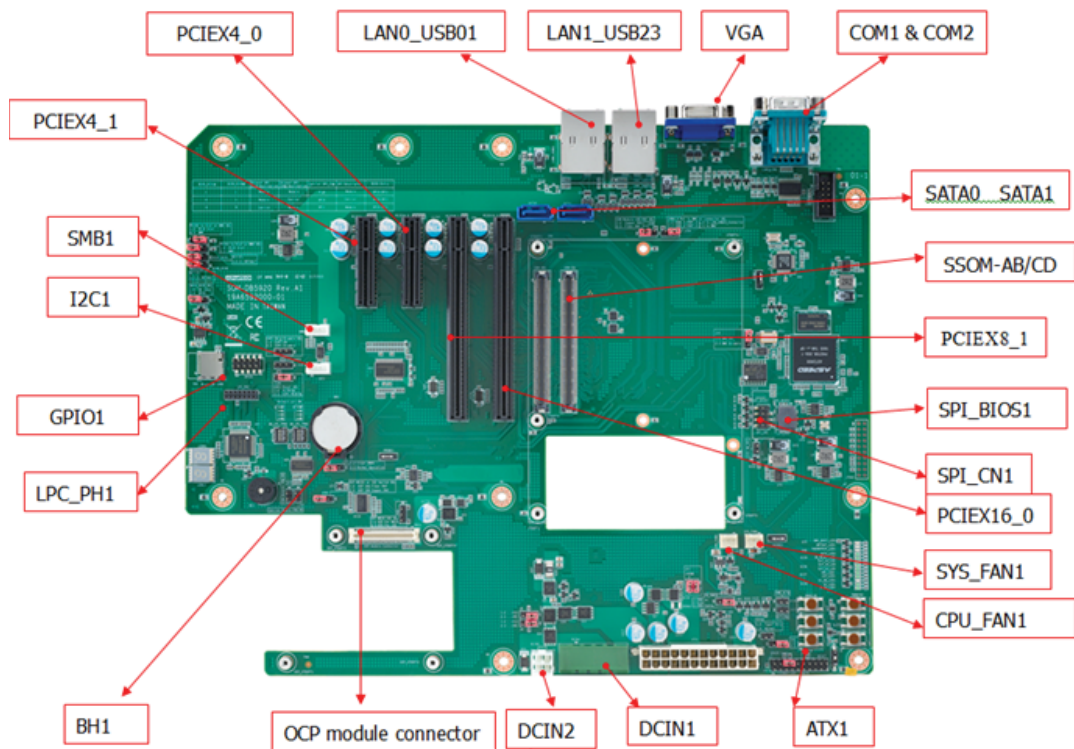
Chapter 3

Connectors and Jumper Settings

This chapter info connectors and jumper settings on the SOM-DB5920 Type 7 compatible Carrier Board.

3.1 SOM-DB5920 Connectors and Jumper Settings

3.1.1 SOM-DB5920 Connector Location



3.1.2 SOM-DB5920 Connector Pin Definition

Table 3.1: GPIO1 GPIO Pin Header

Pin	Signal	Pin	Signal
1	GPIO0	2	GPO0
3	GPI1	4	GPO1
5	GPI2	6	GPO2
7	GPI3	8	GPO3
9	GND	10	GND

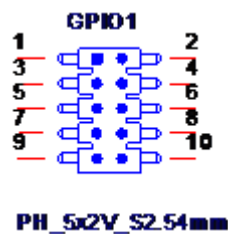
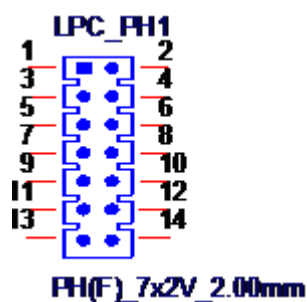
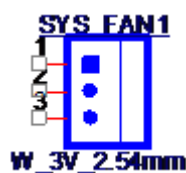


Table 3.2: LPC_PH1 Low Pin Count Pin Header

Pin	Signal	Pin	Signal
1	CLK33M_PH	2	LPC_AD1
3	PLTRST#	4	LPC_AD0
5	LPC_FRAME#	6	+V3.3
7	LPC_AD3	8	GND
9	LPC_AD2	10	Pull-up via 10K ohm to +V3.3
11	SERIRQ	12	PLTRST#
13	+V5_DUAL	14	+V5

**Table 3.3: SYS_FAN1 System Fan Connector**

Pin	Signal
1	GND
2	+V12
3	SYSFAN_IN

**Table 3.4: CPU_FAN1 Smart Fan Connector**

Pin	Signal
1	GND
2	+V_FAN
3	FANTACH_R1

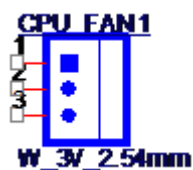


Table 3.5: I2C1 I2C Wafer Box

Pin	Signal
1	GND
2	I2C_DAT
3	I2C_CLK
4	+V3.3_DUAL

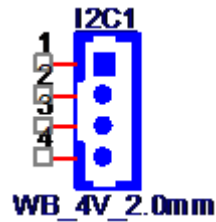


Table 3.6: SMB1 SMBus Wafer Box

Pin	Signal
1	GND
2	SMB_DAT
3	SMB_CLK
4	+V3.3_DUAL

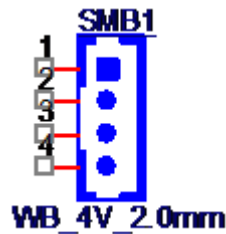


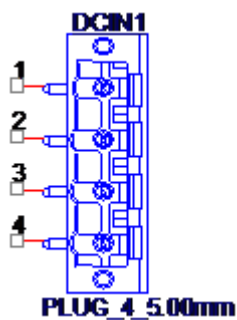
Table 3.7: BH1 RTC Battery Connector

Pin	Signal
1	+VBAT_BH
2	GND

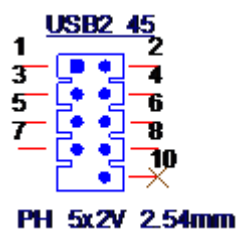


Table 3.8: DCIN1 Wide Range DC Input Connector1

Pin	Signal
1	GND
2	+VDC
3	+VDC
4	GND

**Table 3.9: USB2_45 USB2.0 Port4 & Port5 Connector**

Pin	Signal	Pin	Signal
1	+V5_USB_4_5	2	+V5_USB_4_5
3	USB4_Z_P-	4	USB5_Z_P-
5	USB4_Z_P+	6	USB5_Z_P+
7	GND	8	GND
		10	NC

**Table 3.10: DCIN2 Wide Range DC Input Connector2**

Pin	Signal	Pin	Signal
1	GND	3	+VDC
2	GND	4	+VDC

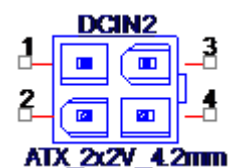
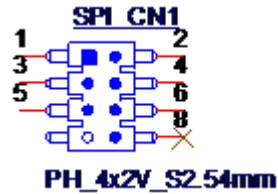
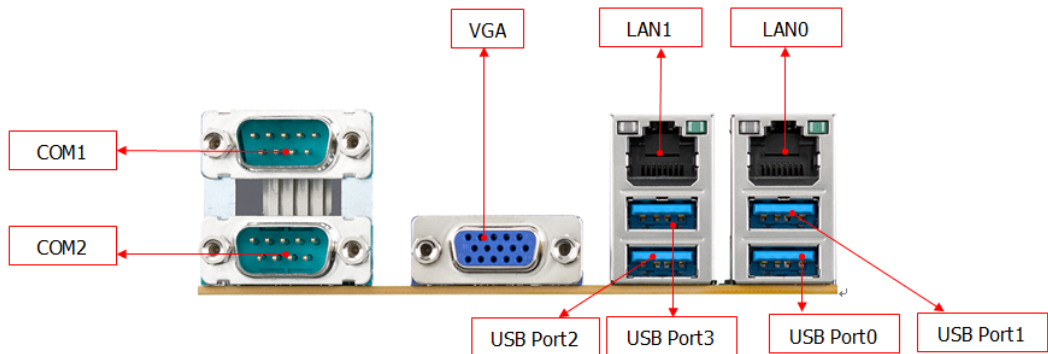


Table 3.11: SPI_CN1 SPI BIOS Pin Header

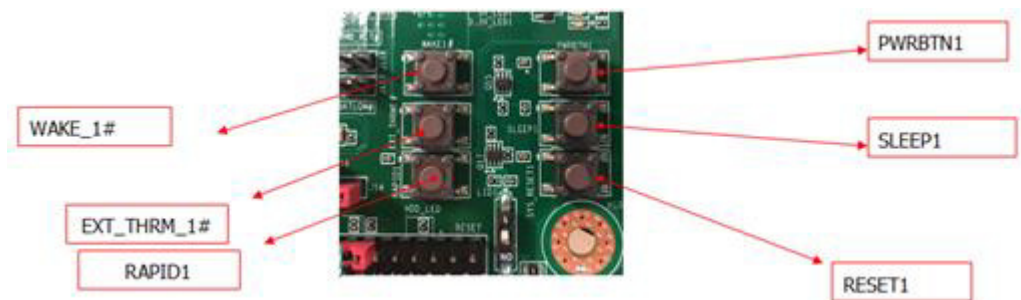
Pin	Signal	Pin	Signal
1	+V3.3M_SPI_J	2	GND
3	Q_SPI_CB_CS#	4	Q_SPI_CB_CLK
5	Q_SPI_CB_MISO	6	Q_SPI_CB_MOSI
X		8	NC



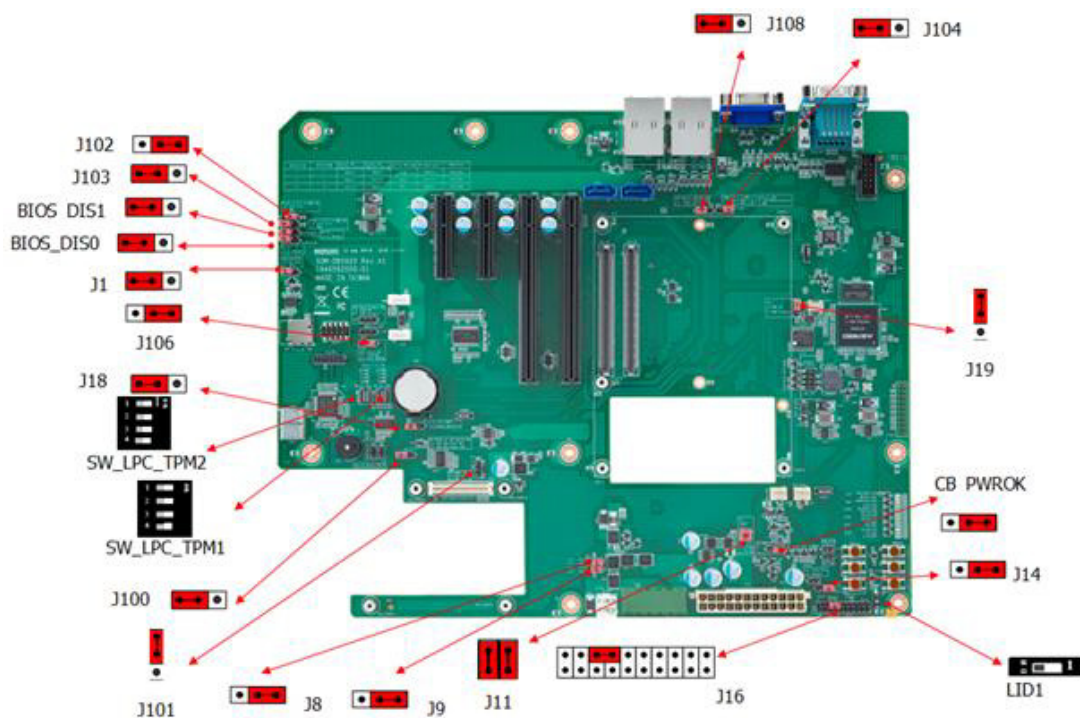
3.1.3 I/O Connector Location



3.1.4 Button Location



3.1.5 Jumper and Switch Location



3.1.5.1 Jumper Setting

Table 3.12: BIOS_DIS0/IOS_DIS1 BIOS Disable0, BIOS Disable1						
BIOS_DIS1# (J3)	BIOS_DIS0# (J2)	Chipset SPI CS1# Destination	Chipset SPI CS0# Destination	Carrier SPI_CS#	SPI Descriptor	BIOS Entry
2-3 (1)	2-3 (1)	Module	Module	High	Module	SPI0/SPI1 [Default]
1-2 (0)	2-3 (1)	Module	Carrier	SPI0	Carrier	SPI0/SPI1
1-2 (0)	1-2 (0)	Carrier	Module	SPI1	Module	SPI0/SPI1



Table 3.13: J8, J9 SOM-D5900 Voltage Input (VIN) Selection	
Pin	Function
J8 1-2 J9 1-2	Supply ATX (+V12) to VIN [Default]
J8 2-3 J9 2-3	Supply DCIN (+VDC) to VIN



Table 3.14: J14 ATX / AT Mode Selection

Pin	Function
1-2	AT Mode
2-3	ATX Mode [Default]

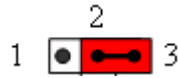


Table 3.15: J11 COMe Module +V5SB Supply

Pin	Function
1-X 3-X	Not supply +V5SB to COMe Module
1-2 3-4	Supply +V5SB to COMe Module [Default]



Table 3.16: J15 Carrier Board SPI power supply

Pin	Function
1-2	Carrier Board SPI power supply [Default]
1-X	Carrier Board SPI no power



Table 3.17: J20 COMe Module TPM Disable

Pin	Function
1-X	COMe Module TPM Enable [Default]
1-2	COMe Module TPM Disable

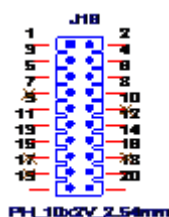


Table 3.18: J21 Carrier Board TPM Disable

Pin	Function
1-X	Carrier Board TPM Enable [Default]
1-2	Carrier Board TPM Disable

**Table 3.19: J16 Front Panel Connector**

Pin	Function
3-5	Power LED (Pin1 is positive)
6-8	Buzzer Enable
12-14	HDD LED (Pin14 is positive)
11-13	Power Button
18-20	Reset Button

**Table 3.20: J18 Normal Operation / Clear COMS Selection**

Pin	Function
1-2	Clear CMOS
2-3	Normal Operation [Default]

**Table 3.21: CB_PWROK Power ok signal Pull Down/Floating Selection**

Pin	Function
1-2	POWROK Signal Pull Down
2-3	POWROK Signal connect to Module [Default]
2-X	POWROK Signal Floating



Table 3.22: J19 BMC Software Enable Disable Selection

Pin	Function
1-2	BMC Software Enable [Default]
2-3	BMC Software Disable



Table 3.23: J100 10G PHY SEL Selection

Pin	Function
1-2	OCP 10G Fiber PHY
2-3	OCP 10G Copper PHY [Default]

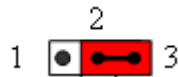


Table 3.24: J102 PCIE0 to slot or BMC SEL

Pin	Function
1-2	PCIE1X0 to PCIEX4 Slot [Default]
2-3	PCIE1X0 to BMC



Table 3.25: J103 PCIE4 to slot or BMC SEL

Pin	Function
1-2	PCIE1X4 to PCIEX4 Slot
2-3	PCIE1X4 to BMC [Default]



Table 3.26: J1 GPIO_SDIO_SEL

Pin	Function
1-2	SD card
2-3	GPIO [Default]



Table 3.27: J104 USB2.0 port to BMC or connector SEL

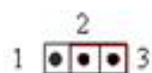
Pin	Function
1-2	USB2&3 Port to LAN_USB_23 Connector
2-3	USB2&3 Port to BMC [Default]

**Table 3.28: J106 ESPI Reset SEL**

Pin	Function
1-2	PLRST# [Default]
2-3	ESPI RESET#

**Table 3.29: J107 ESPI EN & Disable SEL**

Pin	Function
1-2	ESPI EN
2-3	ESPI Disable

**Table 3.30: J108 COM Module 10G PHY SEL**

Pin	Function
1-2	Copper PHY [Default]
2-3	Fiber PHY

**Table 3.31: J101 OCP MDIO I2C SEL**

Pin	Function
1-2	OCP for MDIO [Default]
2-3	OCP for I2C



Table 3.32: J116 Type7 Select SEL

Pin	Function
1-2	Type7 only [Default]
1-X	Normal



Table 3.33: J117 BATLOW#

Pin	Function
1-2	Battery Low
1-X	Normal [Default]



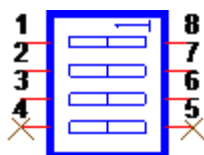
Table 3.34: J118 SMB_ALT#

Pin	Function
1-2	SMBus Alert
1-X	Normal [Default]

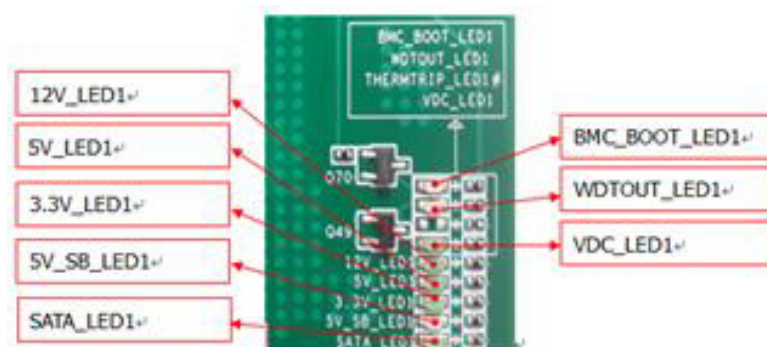


3.1.5.2 Switch Setting

Table 3.35: SW_LPC_TPM1 & SW_LPC_TPM2 TPM Enable/Disable Switch					
Dip Switch	1-8	2-7	3-6	4-5	Function
SW_LPC_TPM1 ~ SW_LPC_TPM2	ON	ON	ON	ON	TPM Enable [Default]
	OFF	OFF	OFF	OFF	TPM Disable



3.1.6 LED Location



3.1.7 LED Function List

Table 3.36: LED Function List	
Location	Function
BMC_BOOT_LED1	BMC Boot Indicate.
WDTOUT_LED1	Watch Dog Time Out Indicate.
TERMTRIP_LED1	Module Board Thermal Trip Indicate
SATA_LED1	SATA Signal Connect Indicate.
CB_RESET_LED	Carrier Board Reset Indicate.
SLP_S3_LED	SLP_S3 Signal Ready Indicate.
SLP_S4_LED	SLP_S4 Signal Ready Indicate.
SLP_S5_LED	SLP_S5 Signal Ready Indicate.
VDC_LED1	VDC Power Input Indicate.
12V_LED1	Carrier Board ATX 12V ready Indicate.
5V_LED1	Carrier Board ATX 5V ready Indicate.
3.3V_LED1	Carrier Board ATX 3.3V ready Indicate.
5V_SB_LED1	Carrier Board ATX 5V_SB ready Indicate.

3.1.8 Connector List

Table 3.37: Connector List

Label	Function	Label	Function
ATX1	ATX Connector	BH1	RTC Battery Connector
CN1	COM Express Connector	CPU_FAN1	Smart Fan Connector
COM1	UART Connector (Tx, Rx)	SMB1	SMBus Wafer Box
COM2	UART Connector (Tx, Rx)	SYS_FAN1	System Fan Connector
DCIN1	Wide Range DC Input Connector1	SPI_CN1	SPI BIOS PIN HEADER
GPIO1	GPIO Pin Header	OCP module connector	OCP module connector
I2C1	I2C Wafer Box	SPI_BIOS1	SPI BIOS Socket
LAN0_USB01	LAN0, USB3.0/2.0 Port0 and Port1 Connector	DCIN2	Wide Range DC Input Connector2
LAN1_USB23	LAN1, USB3.0/2.0 Port2 and Port3 Connector	PCIEX4_1	PCIe x4 slot
LPC_PH1	Low Pin Count Pin Header	SATA0	SATA Connector
PCIEX16_0	PCIe x16 slot	SATA1	SATA Connector
PCIEX8_1	PCIe x8 slot	VGA	CRT Connector
PCIEX4_0	PCIe x4 slot		

3.1.9 Jumper, Switch, Button List

Table 3.38: Jumper, Switch, Button List

Label	Function	Label	Function
J8, J9	SOM-DB5920 Voltage Input (VIN) Selection	SW_LPC_TPM1	TPM Enable/Disable Switch
J11	COMe Module +V5SB supply	SW_LPC_TPM2	TPM Enable/Disable Switch
J14	ATX / AT Mode Selection	CB_PWROK	PWROK Signal Pull Down or Floating Selection
J15	Carrier Board SPI power supply	PWRBTN1	Power Button
J16	Front Panel Connector	RESET1	Reset Button
J18	Normal Operation / Clear COMS Selection	SLEEP1	Sleep Button
J19	BMC software Enable Disable Selection	EXT_THRM_1#	External Thermal Trip Button
J100	OCP 10G Fiber & Copper SEL	WAKE_1#	Wake Button
J101	OCP I2C & MDIO SEL	LID1	LID Button
J102	PCIEX1X0 to PCIEX4 slot & BMC SEL	RAPID1	Rapid shutdown button
J103	PCIEX1X4 to PCIEX4 slot & BMC SEL		
J104	USB2&3 Port to LAN_USB_23 & BMC SEL		
J106	LPC Pin Header Reset SEL		

Table 3.38: Jumper, Switch, Button List

J1	GPIO & SDIO SEL
J108	COM Module 10G PHY SEL
BIOS_DIS0	BIOS Disable0
BIOS_DIS1	BIOS Disable1

ADVANTECH

Enabling an Intelligent Planet

www.advantech.com

Please verify specifications before quoting. This guide is intended for reference purposes only.

All product specifications are subject to change without notice.

No part of this publication may be reproduced in any form or by any means, electronic, photocopying, recording or otherwise, without prior written permission of the publisher.

All brand and product names are trademarks or registered trademarks of their respective companies.

© Advantech Co., Ltd. 2018

Free Manuals Download Website

<http://myh66.com>

<http://usermanuals.us>

<http://www.somanuals.com>

<http://www.4manuals.cc>

<http://www.manual-lib.com>

<http://www.404manual.com>

<http://www.luxmanual.com>

<http://aubethermostatmanual.com>

Golf course search by state

<http://golfingnear.com>

Email search by domain

<http://emailbydomain.com>

Auto manuals search

<http://auto.somanuals.com>

TV manuals search

<http://tv.somanuals.com>