

Contents

Vehicle Safety P. 2

Operation Guide P. 18

Maintenance P. 121

Troubleshooting P. 185

Information P. 203

Specifications P. 233

Welcome

Congratulations on your purchase of a new Honda vehicle. Your selection of a Honda makes you part of a worldwide family of satisfied customers who appreciate Honda's reputation for building quality into every product.

To ensure your safety and riding pleasure:

- Read this owner's manual carefully.
- Follow all recommendations and procedures contained in this manual.
- Pay close attention to safety messages contained in this manual and on the vehicle.

To protect your investment, we urge you to take responsibility for keeping your vehicle well serviced and maintained. Also, observe the break-in guidelines, and always perform the pre-ride inspection and other periodic checks in this manual.

When service is required, remember that your Honda dealer knows your vehicle best. If you have the required mechanical "know-how" and tools, you can purchase an official Honda Service Manual to help you perform many maintenance and repair tasks. ➔ P. 225

Read the warranty information thoroughly so that you understand the warranty coverage and that you are aware of your rights and responsibilities. ➔ P. 226

You may also want to visit our website at www.powersports.honda.com.

Canada www.honda.ca.

Happy riding!

A Few Words About Safety

Your safety, and the safety of others, is very important. Operating this vehicle safely is an important responsibility.

To help you make informed decisions about safety, we have provided operating procedures and other information on safety labels and in this manual. This information alerts you to potential hazards that could hurt you or others.

Of course, it is not practical or possible to warn you about all hazards associated with operating or maintaining a vehicle. You must use your own good judgment.

You will find important safety information in a variety of forms, including:

- Safety labels on the vehicle
- Safety Messages preceded by a safety alert symbol  and one of three signal words: DANGER, WARNING, or CAUTION.

These signal words mean:

DANGER

You **WILL** be **KILLED** or **SERIOUSLY HURT** if you don't follow instructions.

WARNING

You **CAN** be **KILLED** or **SERIOUSLY HURT** if you don't follow instructions.

CAUTION

You **CAN** be **HURT** if you don't follow instructions.

Other important information is provided under the following titles:

NOTICE Information to help you avoid damage to your vehicle, other property, or the environment.

Vehicle Safety

This section contains important information for safe riding of your vehicle.
Please read this section carefully.

Safety Guidelines	P. 3
Safety Labels	P. 7
Safety Precautions	P. 9
Riding Precautions	P. 11
Accessories & Modifications	P. 16
Loading	P. 17

Safety Guidelines

Follow these guidelines to enhance your safety:

- Perform all routine and regular inspections specified in this manual.
- Stop the engine and keep sparks and flame away before filling the fuel tank.
- Do not run the engine in enclosed or partly enclosed areas. Carbon monoxide in exhaust gases is toxic and can kill you.

Always Wear a Helmet

It's a proven fact: helmets and protective apparel significantly reduce the number and severity of head and other injuries. So always wear an approved helmet and protective apparel. ➤ P. 9

Before Riding

Make sure that you are physically fit, mentally focused and free of alcohol and drugs. Check that you and your passenger are both wearing an approved helmet and protective apparel. Instruct your passenger on holding onto the seat strap or your waist, leaning with you in turns, and keeping their feet on the footpegs, even when the vehicle is stopped.

Take Time to Learn & Practice

Even if you have ridden other vehicles, practice riding in a safe area to become familiar with how this vehicle works and handles, and to become accustomed to the vehicle's size and weight.

Safety Guidelines

We recommend that all riders take a certified course approved by the Motorcycle Safety Foundation (MSF) or a state approved training course. New riders should start with the basic course, and even experienced riders will find the advanced course beneficial.

For information about the MSF training course nearest you, call the national toll-free number: (800) 446-9227.

USA Other riding tips can be found in the You and Your Motorcycle Riding Tips booklet that came with your vehicle.

Ride Defensively

Always pay attention to other vehicles around you, and do not assume that other drivers see you. Be prepared to stop quickly or perform an evasive maneuver.

Make Yourself Easy to See

Make yourself more visible, especially at night, by wearing bright reflective clothing, positioning yourself so other drivers can see you, signaling before turning or changing lanes, and using your horn when necessary.

Ride within Your Limits

Never ride beyond your personal abilities or faster than conditions warrant. Fatigue and inattention can impair your ability to use good judgment and ride safely.

Don't Drink or Use Drugs and Ride

Alcohol or drugs and riding don't mix. Even one alcoholic drink can reduce your ability to respond to changing conditions, and your reaction time gets worse with every additional drink. The same is true for drug use. Don't drink or use and ride, and don't let your friends do it either.

Keep Your Honda in Safe Condition

It's important to keep your vehicle properly maintained and in safe riding condition. Inspect your vehicle before every ride and perform all recommended maintenance. Never exceed load limits (➤ P. 17), and do not modify your vehicle or install accessories that would make your vehicle unsafe (➤ P. 16).

If You are Involved in a Crash

Personal safety is your first priority. If you or anyone else has been injured, take time to assess the severity of the injuries and whether it is safe to continue riding. Call for emergency assistance if needed. Also follow applicable laws and regulations if another person or vehicle is involved in the crash.

If you decide to continue riding, first turn the electrical system off, and evaluate the condition of your vehicle. Inspect for fluid leaks, check the tightness of critical nuts and bolts, and check

the handlebars, control levers, brakes, and wheels. Ride slowly and cautiously. Your vehicle may have suffered damage that is not immediately apparent. Have your vehicle thoroughly checked at a qualified service facility as soon as possible.

Lithium-Ion (Li-Ion) Battery

CBR1000SP

If you smell an unusual odor coming from the lithium-ion (li-ion) battery, park your vehicle in a safe place outside and away from flammable objects, then turn the electrical system off. Have your vehicle inspected by your dealer immediately.

Carbon Monoxide Hazard

Exhaust contains poisonous carbon monoxide, a colorless, odorless gas. Breathing carbon monoxide can cause loss of consciousness and may lead to death.

If you run the engine in confined or even partly enclosed area, the air you breathe could contain a dangerous amount of carbon monoxide.

Never run your vehicle inside a garage or other enclosure.

WARNING

Running the engine of your vehicle while in an enclosed or even partially enclosed area can cause a rapid build-up of toxic carbon monoxide gas.

Breathing this colorless, odorless gas can quickly cause unconsciousness and lead to death.

Only run your vehicle's engine when it is located in a well ventilated area outdoors.

Safety Labels

Safety and information labels on your vehicle provide important safety information and may warn you of potential hazards that could cause serious injury. Read these labels carefully and don't remove them.

If a label comes off or becomes hard to read, contact your dealer for a replacement.

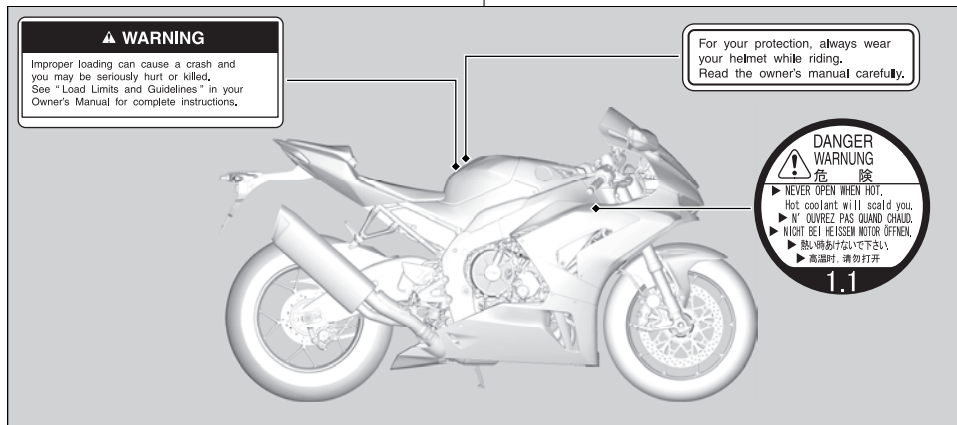

UNLEADED FUEL ONLY
PREMIUM RECOMMENDED

TIRE INFORMATION				
Cold tire pressures		kPa	kgf/cm ²	psi
Up to maximum weight capacity	Front	250	2,50	36
	Rear	290	2,90	42
Up to 90kg(200lbs) load	Front	250	2,50	36
	Rear	290	2,90	42
Tire size	Front	120/70ZR17M/C(58W)		
	Rear	200/55ZR17M/C(78W)		
Minimum recommend tire center tread depth.	Front	1,5mm (0,06in.)		
	Rear	2,0mm (0,08in.)		
Maximum weight capacity	166kg(366lbs)			

DRIVE CHAIN

Keep chain adjusted and lubricated.
30 mm (1 1/4 in.) Freeplay



Read owner's manual.

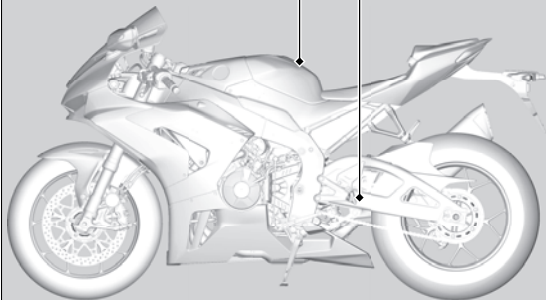

Safety Precautions

- Ride cautiously and keep your hands on the handlebars and feet on the footpegs.
- Keep passenger's hands onto the seat strap or your waist, passenger's feet on the footpegs while riding.
- Always consider the safety of your passenger, as well as other drivers and riders.

Protective Apparel

Make sure that you and any passenger are wearing an approved helmet, eye protection, and high-visibility protective clothing. Avoid wearing loose clothes that could get caught on any part of the vehicle. Ride defensively in response to weather and road conditions.

■ Helmet

Should be safety-standard certified, high-visibility, and correct size for your head

- Must fit comfortably but securely, with the chin strap fastened.
- Face shield with unobstructed field of vision or other approved eye protection

USA Look for a DOT (Department of Transportation) certification label on any helmet you buy.

WARNING

Not wearing a helmet increases the chance of serious injury or death in a crash.

Make sure that you and any passenger always wear an approved helmet and protective apparel.

Safety Precautions

| Gloves

Full-finger leather gloves with high abrasion resistance

| Boots or Riding Shoes

Sturdy boots with non-slip soles and ankle protection

| Jacket and Pants

Protective, highly visible, long-sleeved jacket and durable long pants for riding (or a protective suit)

Riding Precautions

Break-in Period

During the first 300 miles (500 km) of running, follow these guidelines to ensure your vehicle's future reliability and performance.

- Avoid full-throttle starts and rapid acceleration.
- Avoid hard braking and rapid down-shifts.
- Ride conservatively.

Brakes

Observe the following guidelines:

- Avoid excessively hard braking and downshifting.
 - ▶ Sudden braking can reduce the vehicle's stability.
 - ▶ Where possible, reduce speed before turning; otherwise you risk sliding out.

- Exercise caution on low traction surfaces.
 - ▶ The tires slip more easily on such surfaces and braking distances are longer.
- Avoid continuous braking.
 - ▶ Repeated braking, such as when descending long, steep slopes can seriously overheat the brakes, reducing their effectiveness. Use engine braking with intermittent use of the brakes to reduce speed.
- For full braking effectiveness, operate both the front and rear brakes together.

■ Anti-lock Brake System (ABS)

This model is equipped with an Anti-lock Brake System (ABS) designed to help prevent the brakes from locking up during hard braking. The ABS functions with information provided by the IMU (Inertial Measurement Unit).

- ABS does not reduce braking distance. In certain circumstances, ABS may result in a longer stopping distance.
- ABS does not function at speeds below 4 mph (6 km/h).
- The brake lever and pedal may recoil slightly when applying the brakes. This is normal.
- Always use the recommended front/rear tires and sprockets to ensure correct ABS operation.

■ Engine Braking

Engine braking helps slow your vehicle down when you release the throttle. For further slowing action, downshift to a lower gear. Use engine braking with intermittent use of the brakes to reduce speed when descending long, steep slopes.

■ Wet or Rainy Conditions

Road surfaces are slippery when wet, and wet brakes further reduce braking efficiency. Exercise extra caution when braking in wet conditions.

If the brakes get wet, apply the brakes while riding at low speed to help them dry.

Parking

- Park on a firm, level surface.
- If you must park on a slight incline or loose surface, park so that the vehicle cannot move or fall over.
- Make sure that high-temperature parts cannot come into contact with flammable materials.
- Do not touch the engine, muffler, brakes and other high-temperature parts until they cool down.
- To reduce the likelihood of theft, always lock the handlebars (➡ P. 98), and leave your vehicle while taking the Honda SMART Key with you.

Deactivate the Honda SMART Key system if necessary. ➡ P. 101

Use of an anti-theft device is also recommended.

Parking with the Side Stand

1. Stop the engine.
2. Push the side stand down.
3. Slowly lean the vehicle to the left until its weight rests on the side stand.
4. Turn the handlebars fully to the left.
 - ▶ Turning the handlebars to the right reduces stability and may cause the vehicle to fall.
5. Lock the steering. ➡ P. 98
Then, leave your vehicle while taking the Honda SMART Key with you. Deactivate the Honda SMART Key system if necessary.
➡ P. 101

Refueling and Fuel Guidelines

Follow these guidelines to protect the engine, fuel system and catalytic converter:

- Use only unleaded gasoline.
- Use recommended octane number. Using lower octane gasoline will result in decreased engine performance.
- Do not use fuels containing a high concentration of alcohol. ➤ P. 224
- Do not use stale or contaminated gasoline or an oil/gasoline mixture.
- Avoid getting dirt or water in the fuel tank.

Honda selectable torque control

When the Honda selectable torque control (Torque Control) detects rear wheel spin during acceleration, the system will limit the amount of torque applied to the rear wheel based on the Torque Control level selected.

Additionally, the system eases the rapid motion during accelerating based on the Wheelie Control level selected.

Torque Control will allow some wheel spin during acceleration at the lower Torque Control levels settings. Select a level that is appropriate for your skill and riding conditions.

Torque Control does not work during deceleration and will not prevent the rear wheel from skidding due to engine braking. Do not close the throttle suddenly, especially when riding on slippery surfaces.

Torque Control may not compensate for rough road conditions or rapid throttle operation.

Always consider road and weather conditions, as well as your skills and condition, when applying throttle.

If your vehicle gets stuck in mud, snow or sand, it may be easier to free it by turning off the Torque Control temporarily.

Temporarily turning off Torque Control also may help you maintain control and balance when riding on off-road terrain.

Always use the recommended tires and sprockets to ensure correct Torque Control operation.

Accessories & Modifications

We strongly advise that you do not add any accessories that were not specifically designed or approved for your vehicle by Honda or make modifications to your vehicle from its original design. Doing so can make it unsafe. Modifying your vehicle may also void your warranty and make your vehicle illegal to operate on public roads. Before deciding to install accessories on your vehicle be certain the modification is safe and legal.

WARNING

Improper accessories or modifications can cause a crash in which you can be seriously hurt or killed.

Follow all instructions in this owner's manual regarding accessories and modifications.

Do not pull a trailer with, or attach a sidecar to, your vehicle. Your vehicle was not designed for these attachments, and their use can seriously impair your vehicle's handling.

Loading

- Carrying extra weight affects your vehicle's handling, braking and stability.
Always ride at a safe speed for the load you are carrying.
- Avoid carrying an excessive load and keep within specified load limits.
Maximum weight capacity ➤ P. 233
- Tie all luggage securely, evenly balanced and close to the center of the vehicle.
- Do not place objects near the lights or the muffler.

WARNING

Overloading or improper loading can cause a crash and you can be seriously hurt or killed.

Follow all load limits and other loading guidelines in this manual.

Parts Location

CBR1000ST

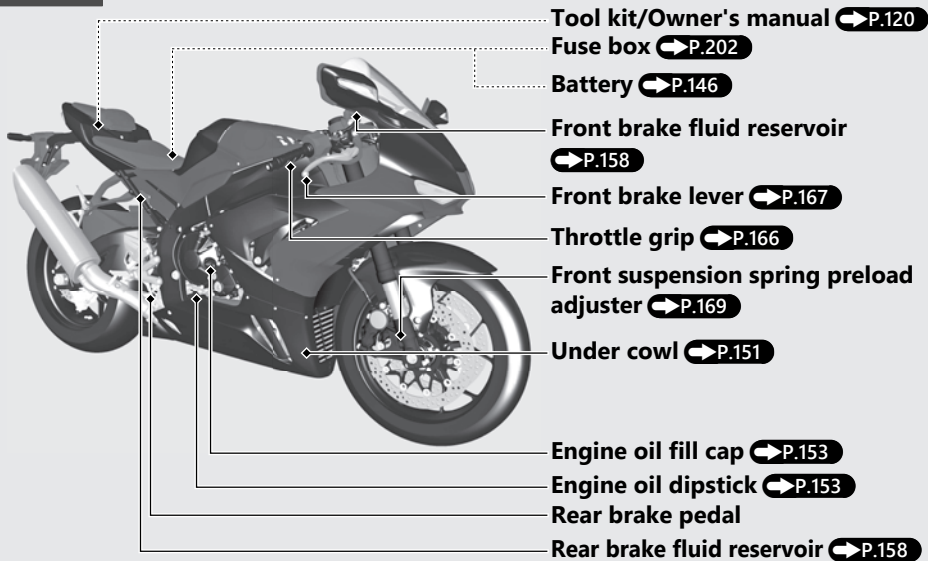

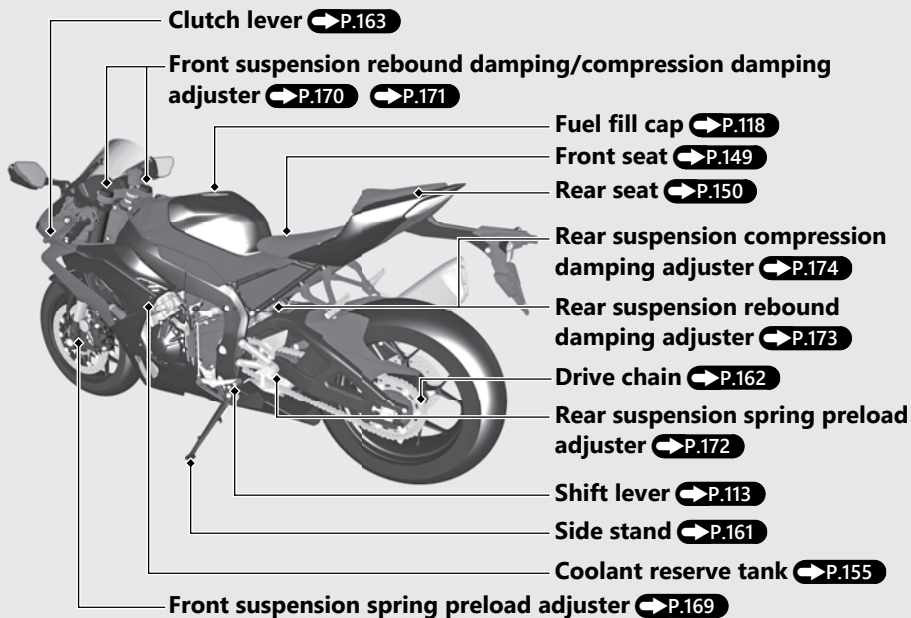

Parts Location *(Continued)*

CBR1000SP

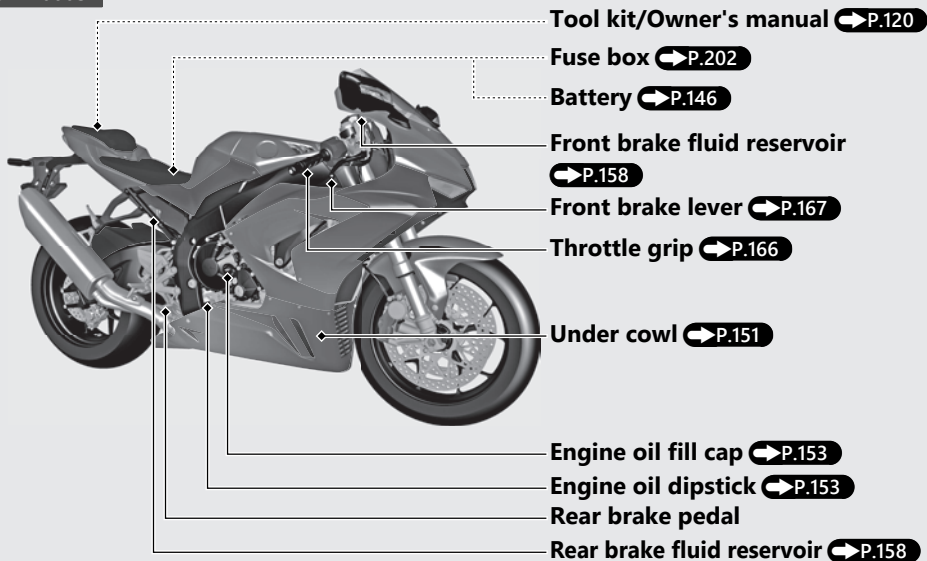

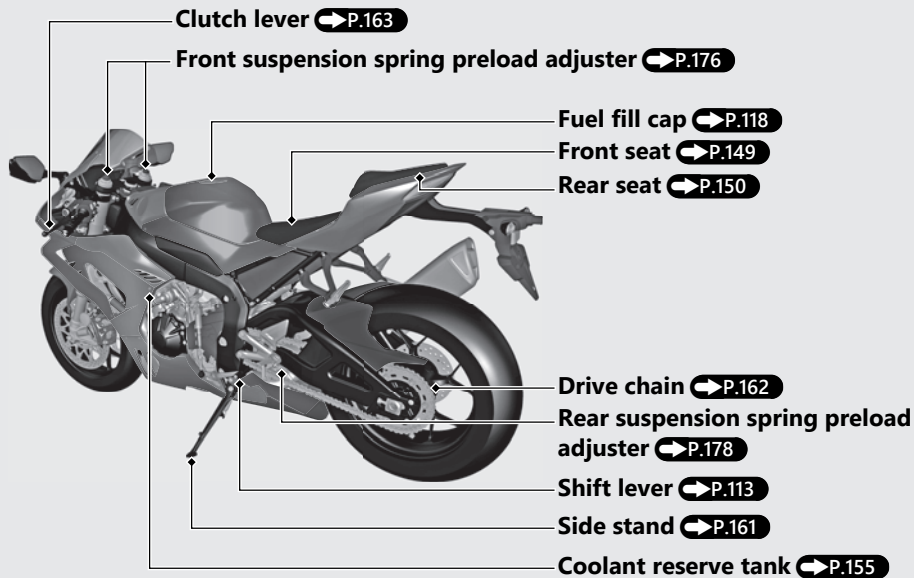

Instruments

The display type consists of the following 5 patterns.

- ANALOG ➔P.23
- DIGITAL ➔P.24
- BAR ➔P.25
- NO REV ➔P.26
- PRACTICE ➔P.27

To change the display type: ➔P.60 ➔P.72

Each display type has the SPORT mode. ➔P.28

The operation of the instrument is mainly explained in the ANALOG display type.

Factory default setting is ANALOG.

Do not operate the display functions for a long time with the engine stopped. It may result in a low (or dead) battery.

STD mode display

Display type: ANALOG (Factory default setting)

 **Low oil pressure indicator**  P.52

Clock
To set the clock:
 P.60  P.81

HESD (Honda Electronic Steering Damper) indicator
 P.52

 **Coolant temperature gauge**  P.48

INFO area  P.31

Gear position indicator  P.52

ABS mode indicator  P.52

 **High beam indicator**

 **High coolant temperature indicator**  P.52

Tachometer

NOTICE

Do not operate the engine in the tachometer red zone. Excessive engine speed can adversely affect engine life.

Tachometer red zone
(excessive engine rpm range)

Current riding mode
 P.105

Speedometer

Reserve fuel mode  P.45

Pop-up information  P.49

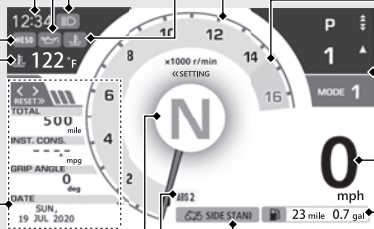

Instruments (Continued)

Display type: DIGITAL

Pop-up information P.49

ABS mode indicator

P.52

High beam indicator

Clock To set the clock:

P.60 P.81

Coolant temperature gauge

P.48

Current riding mode P.105

INFO area P.31

Tachometer

NOTICE

Do not operate the engine in the tachometer red zone. Excessive engine speed can adversely affect engine life.

HESD (Honda Electronic Steering Damper) indicator P.52

Low oil pressure indicator P.52

Speedometer

Tachometer red zone (excessive engine rpm range)

High coolant temperature indicator

P.52

Gear position indicator

P.52

Reserve fuel mode P.45

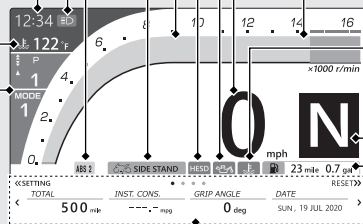

Display type: BAR

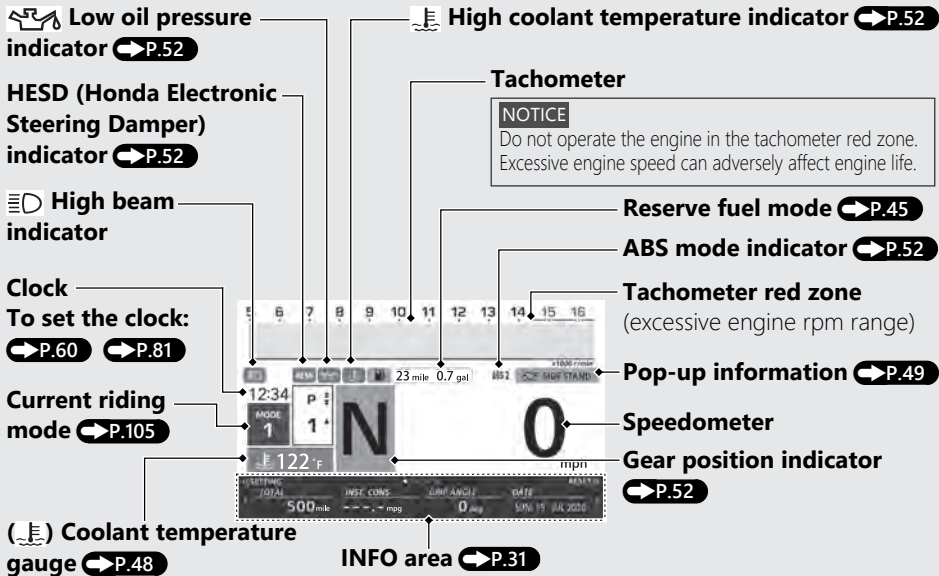

Instruments (Continued)

Display type: NO REV

Clock
To set the clock:

➔ P.60 ➔ P.81

Current riding mode

➔ P.105

 **Coolant temperature gauge**
➔ P.48

 **High beam indicator**

HESD (Honda Electronic Steering Damper) indicator ➔ P.52

 **Low oil pressure indicator** ➔ P.52

 **High coolant temperature indicator** ➔ P.52

ABS mode indicator ➔ P.52

Gear position indicator ➔ P.52

Reserve fuel mode
➔ P.45

Speedometer

INFO area ➔ P.31

Pop-up information ➔ P.49

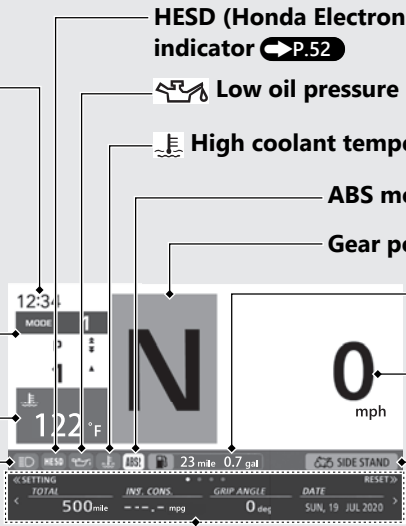

The tachometer is not displayed when NO REV is selected.

Display type: PRACTICE

Reserve fuel mode  P.45

Tachometer

NOTICE

Do not operate the engine in the tachometer red zone. Excessive engine speed can adversely affect engine life.

Current riding mode  P.105

Equalizer  P.44

Clock

To set the clock:

 P.60  P.81

ABS mode indicator

 P.52

Pop-up information  P.49

INFO area  P.31

 High beam indicator

HESD (Honda Electronic Steering Damper) indicator  P.52

 Low oil pressure indicator  P.52

Tachometer red zone (excessive engine rpm range)

 High coolant temperature indicator  P.52

 Coolant temperature gauge  P.48

Speedometer

Gear position indicator  P.52

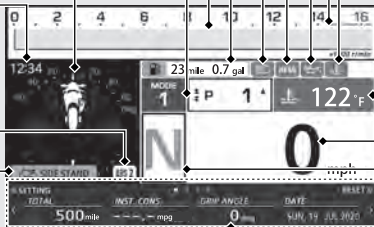

Instruments *(Continued)*

SPORT mode display

To change to the SPORT mode display: Set the "LAP" to "ON" in setting mode.  **P.60**

 **P.72**

▶ To return to the STD mode display, set the "LAP" to "OFF" in setting mode.

When switching to SPORT mode display, the following message appears on the screen for a few seconds then the lap timer is displayed.

When in the SPORT mode, the PASSING/LAP switch functions as a LAP switch.

▶ If the SPORT mode has been set, this message will also appear when the electrical system is turned on.

Lap timer  **P.54**



Display type:
ANALOG

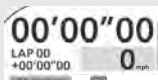

Display type:
DIGITAL



Display type:
BAR



Display type:
NO REV



Display type:
PRACTICE

Basic Operations

You can operate and set the various functions of the display using the switches on the left handlebar.

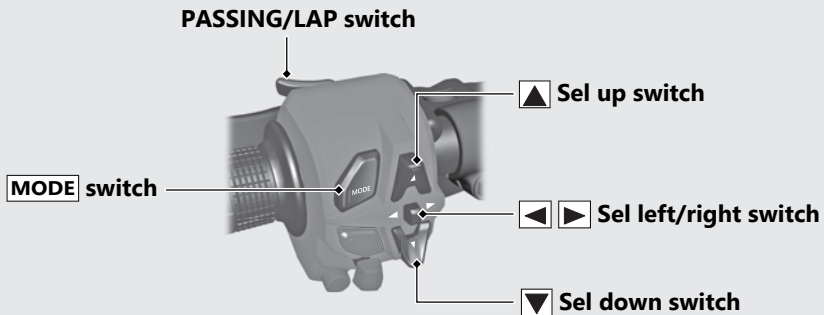

Instruments (Continued)

When switching or setting the display, refer to the switch operation guide is displayed.

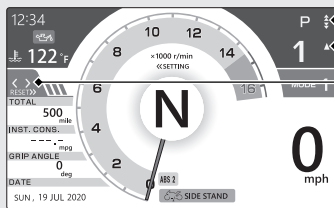

Switch operation guide

Type of the switch operation guide:

- ▲ or ^ : Press the ▲ sel up switch
- ▼ or v : Press the ▼ sel down switch
- < : Push the ◀ of the ◀ ▶ sel left/right switch
- > : Push the ▶ of the ◀ ▶ sel left/right switch
- ▲▲ or ^^ : Press and hold the ▲ sel up switch
- ▼▼ or vv : Press and hold the ▼ sel down switch
- << : Push and hold the ◀ of the ◀ ▶ sel left/right switch
- >> : Push and hold the ▶ of the ◀ ▶ sel left/right switch

INFO area

To switch the INFO area

To change the page of the INFO area, push the ◀ ▶ sel left/right switch.
 You can change the information items to be displayed on the pages 1-3 (INFO 1-3).
 You can also change the number of items to be displayed in the information area.

To select the FAVORITE INFORMATION ➡P.60 ➡P.78

To change the number of information items are displayed ➡P.60 ➡P.72

Page 4 displays the current riding mode settings.

Riding mode ➡P.105

Quick Shifter indicator ➡P.53

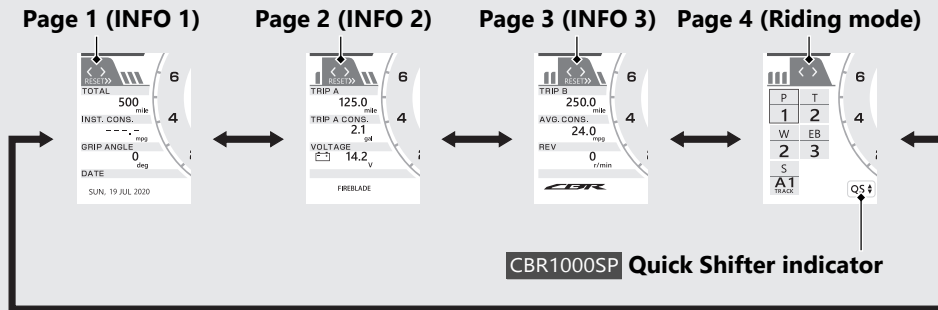

Instruments *(Continued)*

The following items are types of information that can be displayed on pages 1-3 (INFO 1-3).

TOTAL → P.33

TRIP A → P.33

TRIP A CONS. → P.34

TRIP B → P.33

INST. CONS. → P.34

AVG. CONS. → P.35

AVG. SPD. → P.35

ELAPSED → P.36

REV → P.36

GRIP ANGLE → P.36

VOLTAGE → P.37

DATE → P.37

User letter → P.37

CBR logo → P.37

SHIFT POINT → P.38

LAP CONS. → P.38

LAP AVG. CONS. → P.39

LAP AVG. SPD. → P.39

MAX ACC. → P.40

MAX DEC. → P.40

MAX LEAN ANGLE R → P.40

MAX LEAN ANGLE L → P.40

FUEL CONS. → P.41

AVG. CONS. |→ → P.41

AVG. SPD. |→ → P.42

ELAPSED |→ → P.42

Blank → P.43

Odometer [TOTAL]

Total distance ridden.

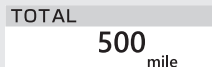

When "-----" is displayed, go to your dealer for service.

Tripmeter A/B [TRIP A/B]

Distance ridden since the tripmeter was reset.



When "----.-" is displayed, go to your dealer for service.

To reset the tripmeter:  **P.43**

Instruments *(Continued)*

Tripmeter A fuel consumption [TRIP A CONS.]

Displays the tripmeter A fuel consumption since the tripmeter A was reset.

Display range: 0.0 to 299.9 gal (gallon) or 0.0 to 299.9 L (litres)

- Above 299 gal (gallon) or 299 L (litres): "299.9" is displayed.
- When the tripmeter A fuel consumption is reset: "0.0" is displayed.



When "---.-" is displayed go to your dealer for service.

Tripmeter A fuel consumption is reset when you reset tripmeter A.

To reset the tripmeter A: **P.43**

Current fuel mileage [INST. CONS.]

Displays the current instant fuel mileage.

Display range: 0.0 to 299.9 mpg (L/100km or km/L)

- When your speed is less than 5 mph (7 km/h): "---.-" is displayed.
- Below 0.1 mpg (L/100km or km/L): "0.0" is displayed.
- Above 299.9 mpg (L/100km or km/L): "299.9" is displayed.



When "---.-" is displayed except for the above-mentioned cases, go to your dealer for service.

Average fuel mileage [AVG. CONS.]

Displays the average fuel mileage since the average fuel mileage was reset.

Display range: 0.0 to 299.9 mpg (L/100km or km/L)

- Below 0.1 L/100km: "---.-" is displayed.
- Below 0.1 mpg (km/L): "0.0" is displayed.
- Above 299.9 mpg (L/100km or km/L): "299.9" is displayed.
- When the average fuel mileage is reset: "---.-" is displayed.

AVG. CONS.

24.0
mpg

When "---.-" is displayed except for the above-mentioned cases, go to your dealer for service.

To reset the average fuel mileage

➡ P.43

Average speed [AVG. SPD.]

Displays the average speed since the average speed was reset.

Display range: 0 to 218 mph (0 to 350 km/h)

- Initial display: "---" is displayed.
- When your vehicle has traveled less than 0.12 mile (0.2 km) since the engine was started: "---" is displayed.
- When your vehicle operating time is less than 16 seconds since the engine was started: "---" is displayed.

AVG. SPD.

37
mph

When "---" is displayed except for the above-mentioned cases, go to your dealer for service.

To reset the average speed ➡ P.43

Instruments *(Continued)*

Elapsed time [ELAPSED]

Displays the engine operating time since the elapsed time was reset.

Display range: 00:00 to 99:59 (hours:minutes)

- Above 99:59: back to 00:00

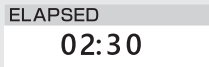

When "--:--" is displayed, go to your dealer for service.

To reset the elapsed time **P.43**

Numerical tachometer display [REV]

Displays the engine revolutions per minutes.

Display range: 0 to 16,500 r/min

Above 16,500 r/min (rpm): "16500" is displayed.



Throttle grip angle [GRIP ANGLE]

Displays the throttle grip angle during operation.

Display range: 0 to 90 deg



When "--" is displayed, go to your dealer for service.

Battery voltage [VOLTAGE]

Displays the current voltage.

**Date [DATE]**

Show the date of today.

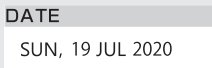

Display range:

Day of the week: MON to SUN

DAY: 1 to 31

MONTH: JAN to DEC

YEAR: 2019 to 2119

To set the date: P.60 P.81

User letter

Displays the characters of user's choice.



To set the USER LETTER: P.60 P.79

CBR logo

Displays the CBR logo.



Instruments *(Continued)*

Shift indicator set value [SHIFT POINT]

Displays the shift indicator set value.

Display range: 5,000 - 16,500 r/min

- When the brightness setting of the REV INDICATOR is selected to off: "-----" is displayed.
- When the gear position is Neutral (N) or 6th: "-----" is displayed.

SHIFT POINT
14500
r/min

To set the shift indicator:  P.60  P.70

Lap fuel consumption [LAP CONS.]

Displays the fuel consumption of the latest lap.

Display range: 0.0 to 50.0 gal (gallon) or 0.0 to 50.0 L (litres)

- Above 50 gal (gallon) or 50 L (litres): "50.0" is displayed.
- Below 0.1 gal (0.1 L): "0.0" is displayed.
- When there is no lap data: "--.-" is displayed.

LAP CONS.
0.2
gal

When "--.-" is displayed except for the above-mentioned cases, go to your dealer for service.

Lap average fuel mileage [LAP AVG. CONS.]

Displays the average fuel mileage of the latest lap.

Display range: 0.0 to 299.9 mpg (L/100km or km/L)

- Below 0.1 L/100km: "---.-" is displayed.
- Below 0.1 mpg (km/L): "0.0" is displayed.
- Above 299.9 mpg (L/100km or km/L): "299.9" is displayed.
- When there is no lap data: "---.-" is displayed.

LAP AVG. CONS.
32.7
mpg

When "---.-" is displayed except for the above-mentioned cases, go to your dealer for service.

Lap average speed [LAP AVG. SPD.]

Displays the average speed of the latest lap.

Display range: 0 to 218 mph (0 to 350 km/h)

- When there is no lap data: "---" is displayed.

LAP AVG. SPD.
74
mph

When "---" is displayed except for the above-mentioned cases, go to your dealer for service.

Instruments *(Continued)*

Maximum acceleration in this time [MAX ACC.]

Displays the maximum acceleration since the electrical system was turned on.

Display range: 0 to 1.5 G

- Until detects the acceleration: "--" is displayed.

MAX ACC.
0.5
G

Maximum deceleration in this time [MAX DEC.]

Displays the maximum deceleration since the electrical system was turned on.

Display range: 0 to 1.5 G

- Until detects the deceleration: "--" is displayed.

MAX DEC.
0.4
G

Maximum right lean angle in this time [MAX LEAN ANGLE R]

Displays the maximum lean angle of right side since the electrical system was turned on.

Display range: 0 to 60 deg

- Until detects the lean angle: "--" is displayed.

MAX LEAN ANGLE R
30
deg

Maximum left lean angle in this time [MAX LEAN ANGLE L]

Displays the maximum lean angle of left side since the electrical system was turned on.

Display range: 0 to 60 deg

- Until detects the lean angle: "--" is displayed.

MAX LEAN ANGLE L
32
deg

Fuel consumption in this time [FUEL CONS.]

Displays the fuel consumption since the electrical system was turned on.

Display range: 0.0 to 50.0 gal (gallon) or 0.0 to 50.0 L (litres).

- Below 0.04 gal (0.04 L): "0.0" is displayed.
- Above 50 gal (gallon) or 50 L (litres): "50.0" is displayed.
- Until detects the fuel consumption: "--.-" is displayed.

FUEL CONS.
0.7
gal

When "--.-" is displayed except for the above-mentioned cases, go to your dealer for service.

Average fuel mileage in this time [AVG. CONS.]

Displays the average fuel mileage since the electrical system was turned on.

Display range: 0.0 to 299.9 mpg (L/100km or km/L).

- Below 0.1 L/100km: "---.-" is displayed.
- Below 0.1 mpg (km/L): "0.0" is displayed.
- Above 299.9 mpg (L/100km or km/L): "299.9" is displayed.
- Until detects the fuel mileage: "---.-" is displayed.

AVG. CONS.]
11.5
mpg

When "---.-" is displayed except for the above-mentioned cases, go to your dealer for service.

Instruments *(Continued)*

Average speed in this time [AVG. SPD. ↗]



Displays the average speed since the electrical system was turned on.

Display range: 0 to 218 mph (0 to 350 km/h).

- Initial display: "---" is displayed.
- When your vehicle has traveled less than 0.12 mile (0.2 km) since the engine was started: "---" is displayed.
- When your vehicle operating time is less than 16 seconds since the engine was started: "---" is displayed.



When "---" is displayed except for the above-mentioned cases, go to your dealer for service.

Elapsed time in this time [ELAPSED ↗]

Displays the engine operating time since the electrical system was turned on.

Display range: 00:00 to 99:59 (hours:minutes)

- Above 99:59: back to 00:00.
- Until detects the elapsed time: "--:--" is displayed.

When the electrical system is turned off, the elapsed time is reset.

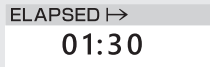

When "--:--" is displayed except for the above-mentioned cases, go to your dealer for service.

Blank display

Display the blank.

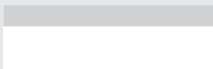

To Reset the Information

Select the page (INFO1, 2, 3) of INFO area that contains the item you want to reset with the ◀ ▶ sel left/right switch.

Push and hold the ▶ of the ◀ ▶ sel left/right switch until the RESET turns to red.

- ▶ If there are no items on the page that can be reset, there is no response to the operation.

Select the item with the ◀ ▶ sel left/right switch.

- ▶ If the display type is ANALOG, select the item with ▲ sel up switch or ▼ sel down switch.

Push and hold the ▶ of the ◀ ▶ sel left/right switch until the item is reset.

To exit the reset mode, push and hold the ◀ of the ◀ ▶ sel left/right switch.

Instruments *(Continued)*

EQUALIZER

Displays the current lean angle of left/right side.

Displays the current acceleration/ deceleration.

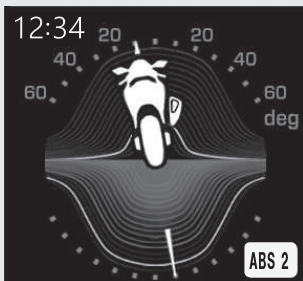

Reserve Fuel Mode

When the low fuel indicator appears the available driving distance and amount of remaining fuel displayed.

You should refill the tank as soon as possible.

Remaining fuel amount turned to the reserve fuel mode: 0.9 US gal (0.7 Imp gal, 3.5 L)

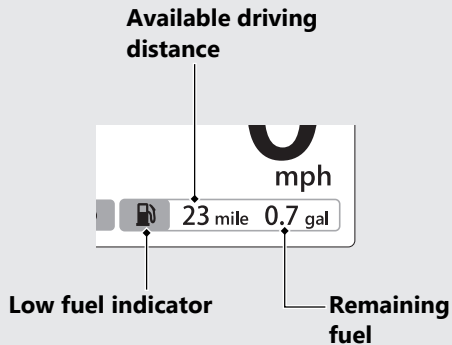

After refueling more than the reserve amount, the display returns to normal when the electrical system has been on for about a minute.

Instruments *(Continued)*

Available driving distance (Only reserve fuel mode)

When the low fuel indicator lights, the estimated available driving distance is indicated.

Display range: 99 to 3 mile (5 km)

- Above 99 mile (km): "99" is displayed.
- Below 3 mile (5 km): "--" is displayed.

- **USA**

Below 0.3 gal (1.0 L): "--" is displayed.

- **Canada**

Below 0.2 gal (1.0 L): "--" is displayed.

- Until detects the available driving distance: "--" is displayed.

The indicated available driving distance is calculated based on the driving states, and the indicated figure may not always be the actual allowable distance.

When "--" is displayed except for the above-mentioned cases, go to your dealer for service.

Amount of remaining fuel (Only reserve fuel mode)

When the low fuel indicator lights, the estimated amount of remaining fuel can be selected.

Display range:

USA 0.9 to 0.3 gal (gallon) or 3.5 to 1.0 L (litres)

Canada 0.7 to 0.2 gal (gallon) or 3.5 to 1.0 L (litres)

- **USA**

Below 0.3 gal (1.0 L): “-.-” is displayed.

- **Canada**

Below 0.2 gal (1.0 L): “-.-” is displayed.

The amount of remaining fuel is calculated based on the driving states. The indicated amount of remaining fuel may be different from the actual amount.

When “-.-” is displayed except for the above-mentioned cases, go to your dealer for service.

Instruments *(Continued)*

Coolant temperature gauge ()

Display range: 94°F (35°C) to 269°F (132°C)

- 93°F (34°C) or less: "---" is displayed.
- Between 251°F (122°C) and 268°F (131°C):
 - High coolant temperature indicator lights.
 - Coolant temperature digits flash.
- Above 269°F (132°C):
 - High coolant temperature indicator lights.
 - "269°F (132°C)" flashes.
- Even if the engine coolant temperature is low, the cooling fan may start running when you rev up the engine. This is normal.

Pop-up information

In the following cases, pop-up information is displayed.

- Maintenance information:
When the inspection time of your vehicle is approaching.
- Helpful information:
When your vehicle has helpful information.
- Start Mode Information:
When in the Start Mode.
- Failure information:





CBR1000SP

When your vehicle has a problem with the ÖHLINS Smart EC system.

When your vehicle has multiple pieces of information, the high-priority pop-up information display will appear.



If the priorities are the same, pop-up information display appears alternately.

The priority order is as follows:



Priority	Pop-up information items
1	
2	
3	START MODE
4	 SIDE STAND  60 ^{miles} JUL / 2020  300 ^{miles} JUL / 2020

Instruments *(Continued)*





Maintenance Information

Indication	Explanation	Remedy
 300 mile JUL/2020	When the periodic inspection time of your vehicle is approaching.	Have your vehicle inspected by your dealer.
 60 mile JUL/2020	When the oil change time of your vehicle is approaching.	Change the engine oil.

Helpful Information

Indication	Explanation	Remedy
 SIDE STAND	When the side stand is down.	Raise the side stand.
	CBR1000SP When the suspension initialization is waiting.	Stop your vehicle. Wait for a few seconds until the indication turns off. If the indication does not turn off, contact your dealer.

Start Mode Information

Indication	Explanation	Remedy
	When the background color is: Orange: Start Mode is allowed. Green: Limiting the engine revolution. Gray: Start Mode is not allowed.	To use the Start Mode  P.60  P.71  P.115

Failure Information

Indication	Explanation	Remedy
	CBR1000SP When your vehicle has a problem with the ÖHLINS Smart EC system.	Reduce speed and have your vehicle inspected by your dealer as soon as possible.

Instruments *(Continued)*

Gear position indicator

The gear position is shown in the gear position indicator.

- ▶ "-" appears when the transmission is not shifted properly.

ABS mode indicator [ABS 1/2]

Displays the current ABS mode.

ABS 1 is suitable for track riding.

ABS 2 is suitable for street riding or winding roads.

When the indicator flashes, go to your dealer for service.

To select the ABS mode:  **P.60**

 **P.69**



Low oil pressure indicator

- Comes on when the electrical system is turned on.
- Goes off when the engine starts.

If it comes on while engine is running:

 **P.188**

HESD (Honda Electronic Steering Damper) indicator

If it comes on while engine is running:

 **P.189**



High coolant temperature indicator





If it comes on while riding:  **P.187**

Quick Shifter indicator

CBR1000SP

Displays the current status of the Quick Shifter.

This indicator is displayed when the INFO area is in page 4 (Riding mode).

-  Quick Shifter system is disabled.
-  Quick Shifter upshifting is enabled.
-  Quick Shifter downshifting is enabled.
-  Quick Shifter upshifting and downshifting are both enabled.

QUICK SHIFTER:  **P.60**  **P.67**  **P.114**

Instruments *(Continued)*

Lap Timer

You can record lap time in the SPORT mode. P.60 P.72

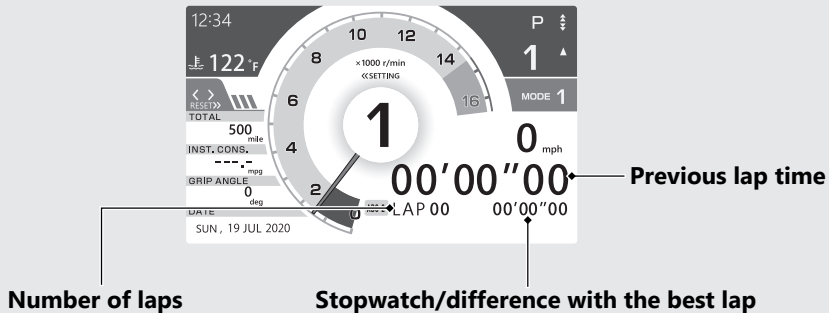

You can check and clear the recorded lap data in the setting mode. ← P.60 ← P.80

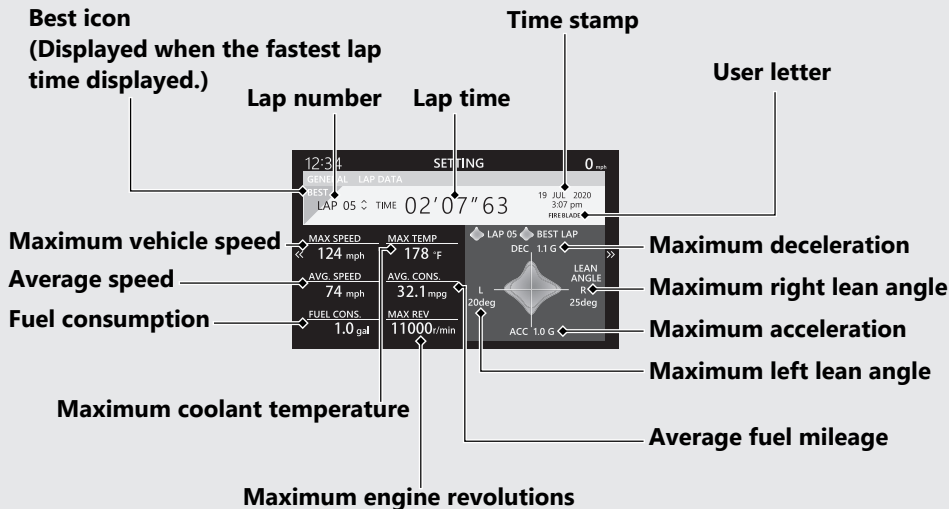

Instruments *(Continued)*

The lap data include the following:

	Lap data	Display range
Number of lap	0 to 99 ▶ Exceeds 99, repeats the "99"	
Previous lap time	00'00"00 to 99'59"99	
Stopwatch	00'00"00 to 99'59"99	
Difference with the best lap	-99'59"99 to 00'00"00 to +99'59"99	
Maximum vehicle speed	0 to 218 mph (0 to 350 km/h)	
Average speed	0 to 218 mph (0 to 350 km/h)	
Fuel consumption	0.0 to 299.9 gal (gallon) or 0.0 to 299.9 L (litres)	
Maximum coolant temperature	94°F (35°C) to 269°F (132°C)	
Average fuel mileage	0.0 to 299.9 mpg (L/100km or km/L)	
Maximum engine revolutions	0 to 16500 r/min (rpm)	
Maximum acceleration	0 to 1.5 G	
Maximum deceleration	0 to 1.5 G	
Maximum right lean angle	0 to 60 deg	
Maximum left lean angle	0 to 60 deg	

To Measure the Lap Time

- 1 Set the "LAP" to "ON" in setting mode.
 ➔ P.60 ➔ P.72
- 2 To start measuring, press the PASSING/LAP switch.
 ▶ The stopwatch starts measurement.

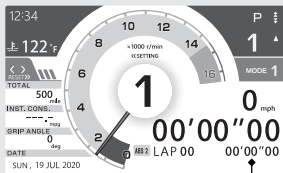
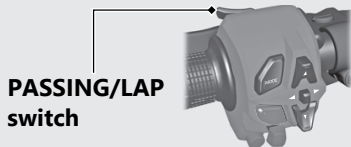

Stopwatch

- 3 To record lap time, press the PASSING/LAP switch at each lap.
 - ▶ The stopwatch changes to display of the difference with the best lap. After 10 seconds, the display will return to the stopwatch.
 - ▶ The previous lap time change to the information of the previous lap.
 - ▶ If you press the PASSING/LAP switch again within 10 seconds, lap time is not recorded.
 - ▶ When exceeds 99 lap, the lap number repeats the "LAP 99".

Instruments (Continued)

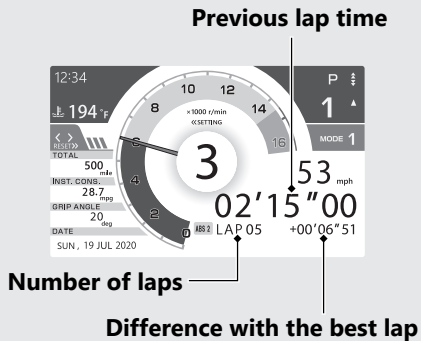

- 4 To end measurement, press and hold the PASSING/LAP switch.

To restart the measurement

Press the PASSING/LAP switch again. The stopwatch restarts measurement.



- ▶ Measurement starts from the next lap.

To Check or Clear the Lap Time

Select the "LAP DATA" menu in the setting mode. **➡P.60** **➡P.80**

Setting mode

To shift to the setting mode

Push and hold the  of the   sel left/right switch.

To select the desired setting menu, operate the  sel up switch,  sel down switch,   sel left/right switch on the left handle.

- ▶ When switching to setting mode, the clock, indicator and speed are displayed at the top of the screen.

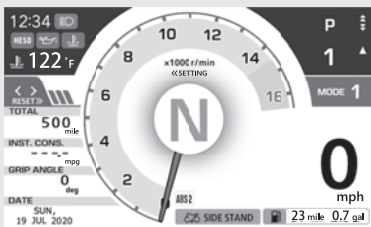

Ordinary display

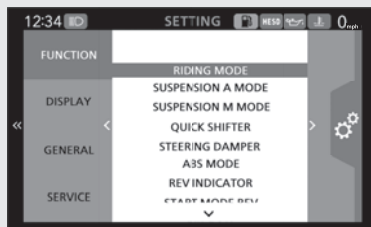

Setting mode



To complete the setting:

- Push and hold the  of the   sel left/right switch, return to the upper hierarchy.
- Push and hold the **MODE** switch, return to the ordinal display.

Instruments (Continued)

Setting flow

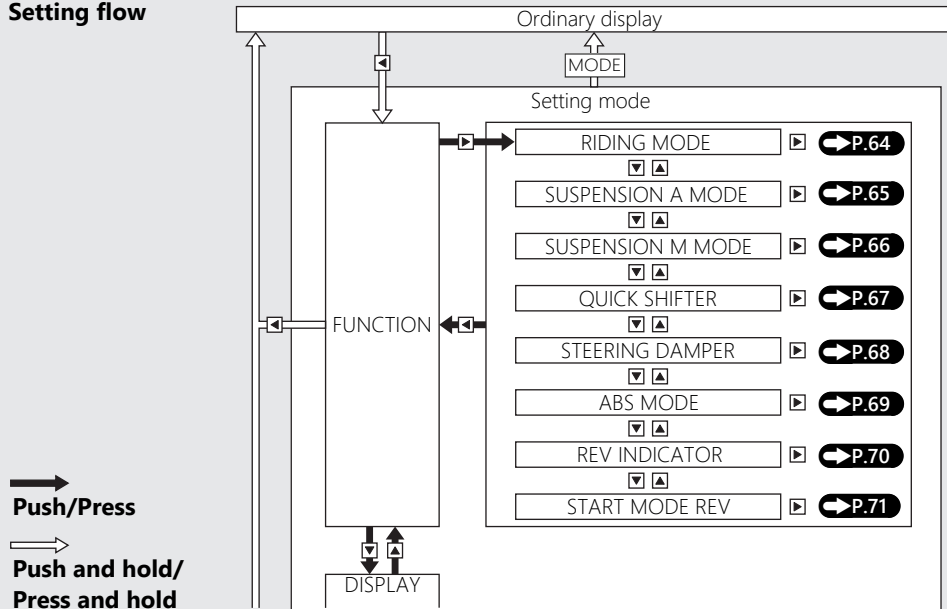

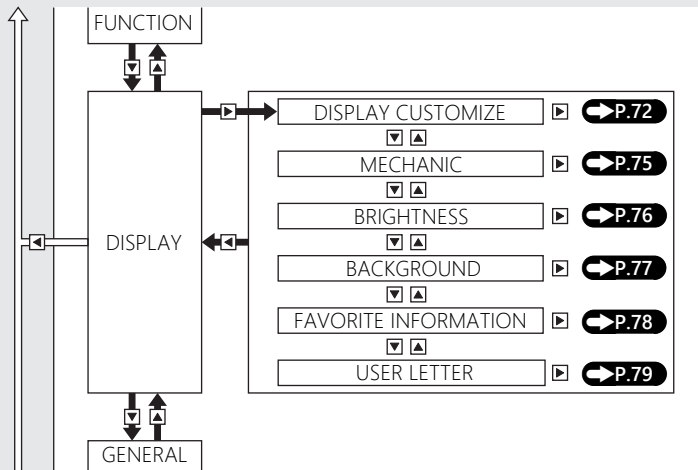



 **Push/Press**

 **Push and hold/
Press and hold**

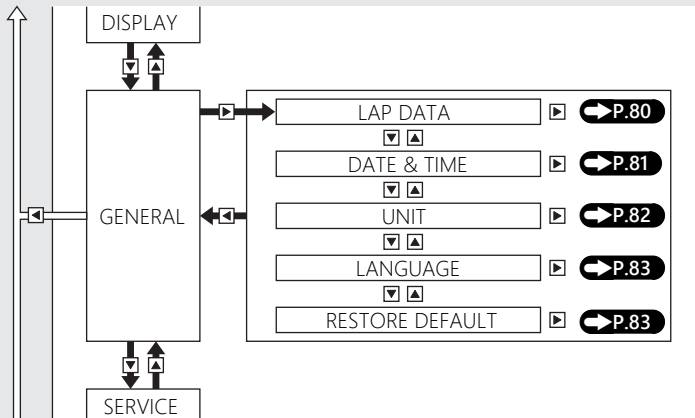
Instruments *(Continued)*



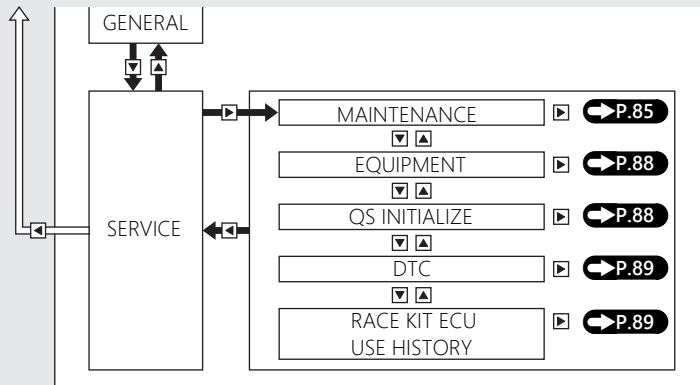

Push/Press

**Push and hold/
Press and hold**





 **Push/Press**

 **Push and hold/
Press and hold**

Instruments (Continued)

RIDING MODE P.105

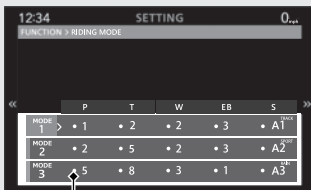

You can select the RIDING MODE.

- 1 Select the "MODE 1", "MODE 2" or "MODE 3" using the  sel up or  sel down switch.
- 2 Select to the desired setting according to the switch operation guide.
 - ▶ **CBR1000ST**
"S" (suspension mode) is not displayed.
- 3 Return to the ordinary display or upper hierarchy to complete the setting.



Default setting mark

To return to the initialize settings:

- 1 Push and hold the  of the   sel left/right switch.
- 2 Reset the setting according to the switch operation guide.







SUSPENSION A MODE P.179

CBR1000SP

You can change the levels of OBTi support items.

Adjusting the ÖHLINS Smart EC system

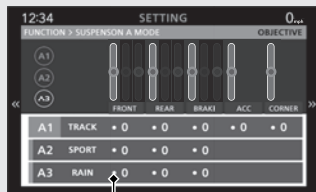

P.175

- 1 Select the "A 1", "A 2" or "A 3" using the  sel up or  sel down switch.
- 2 Push the  of the   sel left/right switch.
- 3 Select to the desired setting according to the switch operation guide.
 - ▶ When you select the "TRACK", you can select the "ACC" and "CORNER" levels.
- 4 Return to the ordinary display or upper hierarchy to complete the setting.



Default setting mark

To return to the initialize settings:

- 1 Push and hold the  of the   sel left/right switch.
- 2 Reset the setting according to the switch operation guide.

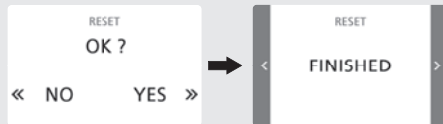

Instruments (Continued)



SUSPENSION M MODE P.182

CBR1000SP

You can adjust the compression and rebound damping of the front and rear suspension electronically.

Adjusting the ÖHLINS Smart EC system

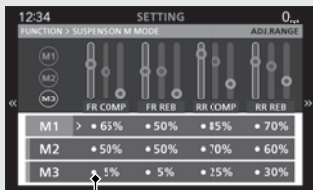

 P.175

- 1 Select the "M 1", "M 2" or "M 3" using the  sel up or  sel down switch.
- 2 Select to the desired setting according to the switch operation guide.
- 3 Return to the ordinary display or upper hierarchy to complete the setting.



Default setting mark

To return to the initialize settings:

- 1 Push and hold the  of the   sel left/right switch.
- 2 Reset the setting according to the switch operation guide.

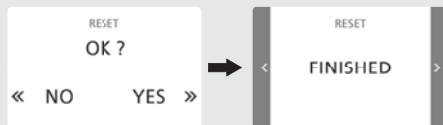

QUICK SHIFTER

CBR1000SP

You can change the setting of the Quick Shifter.



UP: Change the setting for upshifting.

DOWN: Change the setting for downshifting.

OFF	Deactivate
SOFT	Activate
MEDIUM	
HARD	

SOFT, MEDIUM or HARD indicate the load level of the shift pedal.

To use the Quick Shifter:  **P.114**

- 1 Select the "UP" or "DOWN" using the  sel up or  sel down switch.
- 2 Select to the desired setting according to the switch operation guide.
- 3 Return to the ordinary display or upper hierarchy to complete the setting.

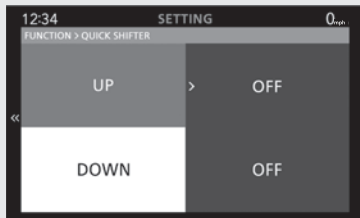

Instruments *(Continued)*

STEERING DAMPER

You can change the damping level of the steering damper.

The steering damping level can be selected from "SOFT", "MEDIUM" or "HARD".

Each level's characteristics

SOFT: More agile steering feel. (Default setting level)

MEDIUM: Medium steering damping level between "SOFT" and "HARD".

HARD: More stable steering feel on high speed riding.

- 1 Select the steering damping level from "SOFT", "MEDIUM" or "HARD" using the ▲ sel up or ▼ sel down switch.
- 2 Return to the ordinary display or upper hierarchy to complete the setting.
 - ▶ You can also complete the setting by pressing the ◀ of the ◀ ▶ sel left/right switch.

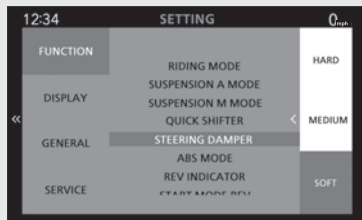

ABS MODE

You can change the ABS mode.

The ABS mode can be selected from the "ABS1 (TRACK)" or "ABS2 (SPORT)".

- 1 Select the "ABS1 (TRACK)" or "ABS2 (SPORT)" using the ▲ sel up or ▼ sel down switch.
- 2 Return to the ordinary display or upper hierarchy to complete the setting.
 - ▶ You can also complete the setting by pressing the ◀ of the ◀ ▶ sel left/right switch.

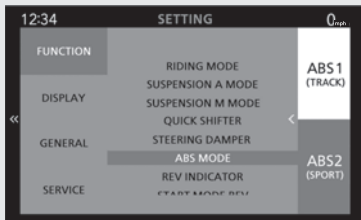

Instruments (Continued)

REV INDICATOR

You can change the setting of the shift indicators.

INTERVAL

You can adjust the interval of lighting the shift indicator.

- ▶ Available setting range: 0 - 500 r/min (rpm)

SHIFT POINT

You can adjust the shift point.

- ▶ When "FOR EACH GEAR" is selected, the gear position number is displayed, and the shift point can be selected for each gear.



- ▶ Available setting range: 5,000 - 16,500 r/min (rpm)

BRIGHTNESS

You can adjust the shift indicator brightness.

- ▶ Available setting range: OFF or 1 - 8
 - ▶ When "OFF" is selected, the shift indicator is deactivated.
- 1 Select the "INTERVAL", "SHIFT POINT" or "BRIGHTNESS" using the ▲ sel up or ▼ sel down switch.
 - 2 Select to the desired setting according to the switch operation guide.
 - 3 Return to the ordinary display or upper hierarchy to complete the setting.



Information of the Shift Indicator:



➡ P.93

START MODE REV

You can change the engine revolutions when using the Start Mode.

To use the Start Mode: P.115

▶ Available setting range: OFF or 6,000 - 9,000 r/min (rpm)

1 Select the engine revolutions using the  sel up or  sel down switch.

2 Return to the ordinary display or upper hierarchy to complete the setting.

▶ You can also complete the setting by pressing the  of the   sel left/right switch.

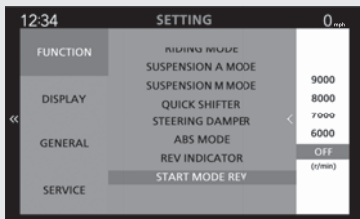

Instruments *(Continued)*

DISPLAY CUSTOMIZE

You can register 3 patterns of display settings and use them as ordinary displays.

You can select and combine your favorite styles from "DISPLAY STYLE", "REV STYLE", "LAP" and "INFO" settings.

DISPLAY TYPE : You can change the display type.

REV STYLE : You can change the tachometer style.

LAP : You can switch between STD mode and SPORT mode.

INFO : You can change the number of items to be displayed in the information area.

To use a registered display setting as the ordinary display:

- 1 Select the desired screen setting from the "01", "02" or "03" using the ▲ sel up or ▼ sel down switch.
- 2 Return to the ordinary display or upper hierarchy to complete the setting.
 - ▶ The date appears when you register the display settings or use the registered screen as an ordinary display.

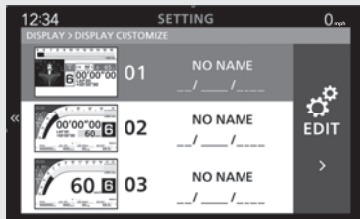

To edit and register the display:

- 1 Select the "EDIT" according to the switch operation guide.
- 2 Select the "DISPLAY TYPE", "REV STYLE", "LAP" or "INFO" using the ▲ sel up or ▼ sel down switch.
- 3 Select to the desired setting according to the switch operation guide.
 - ▶ You can check the current display settings with thumbnail.
 - ▶ To switch to the SPORT mode, select the "ON" from the "LAP" menu.
- 4 Return to the ordinary display or upper hierarchy to complete the setting.
 - ▶ The date appears when you register the display settings or use the registered screen as an ordinary display.

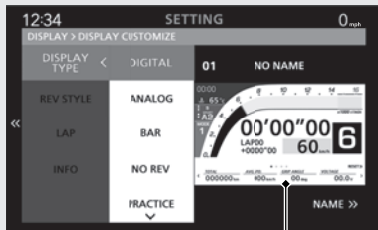







Thumbnail

Instruments *(Continued)*

To edit the display name:

You can edit the display name with up to 10 characters.

- 1 Select the "EDIT" according to the switch operation guide.
- 2 Push and hold the  of the   sel left/right switch.
- 3 Edit the display name.
 - ▶ To select the character using the  sel up switch,  sel down switch, and   sel left/right switch.
 - ▶ To set the character using the mode switch.
- 4 Select the "OK", and then press the MODE switch.

Display name



MECHANIC

Displays the current information of the vehicle.

Displays the following information:

- Tachometer
- Gear position
- Throttle grip position
- Coolant temperature
- Battery voltage

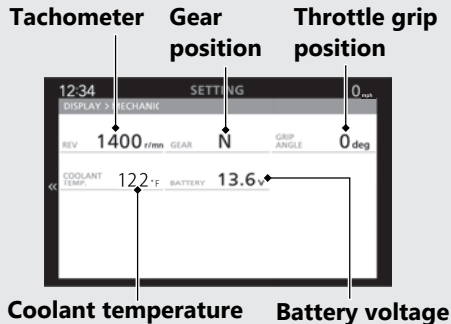

Instruments *(Continued)*

BRIGHTNESS

You can adjust the backlight brightness to one of the eight levels or select the auto adjustment.

Automatic brightness control: ➡ P.210

The display can become dark when the display is very hot. If it does not restore the original brightness, contact your dealer.

- 1 Select the backlight brightness using the ▲ sel up or ▼ sel down switch.
- 2 Return to the ordinary display or upper hierarchy to complete the setting.
 - ▶ You can also complete the setting by pressing the ◀ of the ◀ ▶ sel left/right switch.

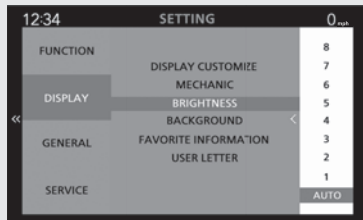

BACKGROUND

You can change the setting of the background to one of the two categories or select the auto adjustment.

Automatic Background Control:

➡ P.210

- 1 Select the "AUTO", "BLACK" or "WHITE" using the ▲ sel up or ▼ sel down switch.
- 2 Return to the ordinary display or upper hierarchy to complete the setting.
 - ▶ You can also complete the setting by pressing the ◀ of the ◀ ▶ sel left/right switch.

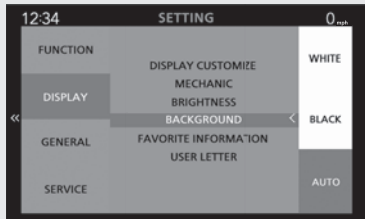

Instruments *(Continued)*

FAVORITE INFORMATION

You can change the types of information displayed in "INFO1", "INFO2", and "INFO3" of the INFO area.

If the number of items to be displayed on the INFO area is set to "NONE", "FAVORITE INFORMATION" cannot be usable. **➡P.60**

➡P.72

- 1 Select the "INFO1", "INFO2" or "INFO3" using the ▲ sel up or ▼ sel down switch.
- 2 Select to the desired setting according to the switch operation guide.
 - ▶ If you select the item that is already selected in another area, the previously selected item will automatically turn the "BLANK".
- 3 Return to the ordinary display or upper hierarchy to complete the setting.

The number of items displayed on the INFO area changes according to the "DISPLAY CUSTOMIZE" setting. **➡P.60** **➡P.72**

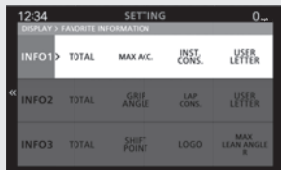



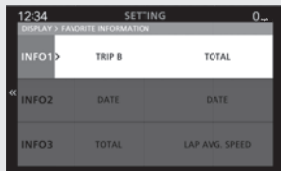

Or



USER LETTER

You can edit the USER LETTER with up to 10 characters.

- 1 Select the "USER LETTER".
- 2 Edit the USER LETTER.
 - ▶ To select the character using the  sel up switch,  sel down switch, and  sel left/right switch.
 - ▶ To set the character using the mode switch.
- 3 Select the "OK", and then press the  switch.

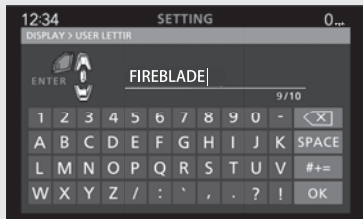

Instruments *(Continued)*

LAP DATA

You can check and clear the recorded lap data.

If there is no lap data, "LAP DATA" cannot be selected.

To display the other lap information, press the ▲ sel up switch or ▼ sel down switch.

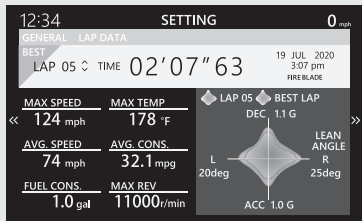

To use the lap timer: ➡ P.54

To clear the recorded lap data:

- 1 Push and hold the ► of the ◀► sel left/right switch.
- 2 Reset the lap data according to the switch operation guide.



DATE & TIME

- 1 Select the "24h or 12h", "YEAR", "MONTH / DAY", "HOUR / MINUTE" or "am / pm" using the ▲ sel up or ▼ sel down switch.
- 2 Select to the desired setting according to the switch operation guide.
 - ▶ When "24 / 12" is set to 24-hour indication, "am / pm" cannot be usable.
- 3 Return to the ordinary display or upper hierarchy to complete the setting.

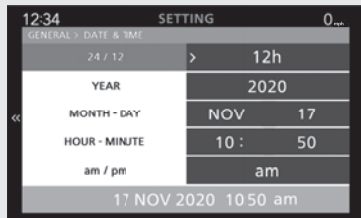

Instruments *(Continued)*

UNIT

You can change the speed and mileage, and fuel mileage meter units.

- 1 Select the "SPEED", "TEMP" or "FUEL CONS." using the ▲ sel up or ▼ sel down switch.
- 2 Select to the desired setting according to the switch operation guide.
- 3 Return to the ordinary display or upper hierarchy to complete the setting.

If you want to select "mile/gal" for fuel consumption, "mph" must be selected in the "SPEED" menu in advance.

When "km/h" for speed is selected, "L/100km" or "km/L" can be selected.

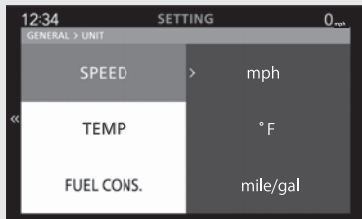

LANGUAGE

Changes the system language.

- 1 Select the "English" or "Turkish" using the ▲ sel up or ▼ sel down switch.
- 2 Return to the ordinary display or upper hierarchy to complete the setting.
 - ▶ You can also complete the setting by pressing the ◀ of the ◀ ▶ sel left/right switch.

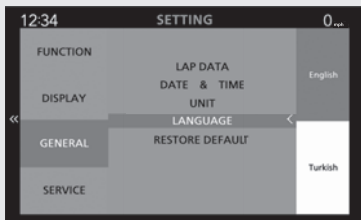

RESTORE DEFAULT

The set values can be returned to the default settings.

Reset the settings according to the switch operation guide.



Instruments *(Continued)*

The following items are restored to their default values:

- **CBR1000SP**
QUICK SHIFTER
- **CBR1000SP**
SUSPENSION A/M MODE
- LAP DATA
- DISPLAY CUSTOMIZE
- REV INDICATOR
- BRIGHTNESS
- BACKGROUND
- USER LETTER
- FAVORITE INFORMATION
- DATE & TIME
- UNIT
- START MODE REV
- RIDING MODE
- STEERING DAMPER
- FAVORITE selection
- INFO selection page
- ABS MODE
- LANGUAGE

MAINTENANCE

You can check the next inspection time and change the setting of next inspection.

Next periodic inspection

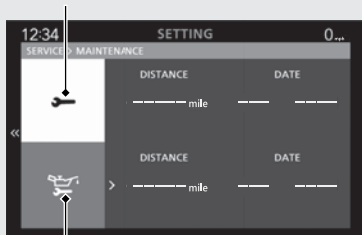

Next engine oil change

To return to the upper level hierarchy, press and hold the **MODE** switch.

Display range:

DISTANCE:

Next periodic inspection:

-----, 8,000 to -99,999 mile (12,875 to -99,999 km)

Next engine oil change:

-----, 8,000 to -99,999 mile (12,875 to -99,999 km)

▶ Pass 0 mile (km): "-" mark is displayed.

DATE:

Month: ---, JAN to DEC

Year: ----, 2019 to 2119

Instruments *(Continued)*

When reaching any of the following, the pop-up information is appears in the ordinary display. **➡ P.49**





- "300 mile" or "500 km" from the next periodic inspection.
- "60 mile" or "100 km" from the next engine oil change.
- One month before the set month.

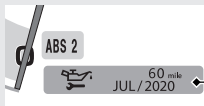



**Maintenance
pop-up
information**



Next inspection setting

- 1 Select “” (periodic inspection) or “” (engine oil change) using the  sel up or  sel down switch.



- 2 Select to the desired setting according to the switch operation guide.
 - ▶ If you press and hold the  sel up or  sel down switch while setting the “DISTANCE”, it will move every 1000.
 - ▶ Available setting range of the DISTANCE:
 - Periodic inspection
-----, 100 to 4,000 mile (100 to 6,400 km)
 - Engine oil change
-----, 100 to 8,000 mile (100 to 12,800 km)
- 3 Return to the ordinary display or upper hierarchy to complete the setting.

Instruments *(Continued)*

EQUIPMENT

"EQUIPMENT" is displayed but not selectable.

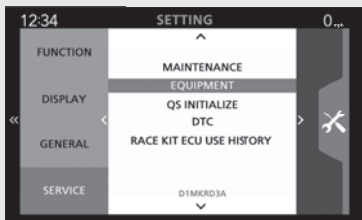

QS INITIALIZE

"QS INITIALIZE" is displayed but not selectable.

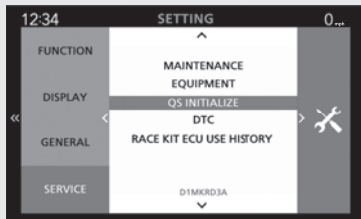

DTC

Displays a current problem with the vehicle. If your vehicle has problem, DTC index is displayed.

Reduce speed and have your vehicle inspected by your dealer as soon as possible.

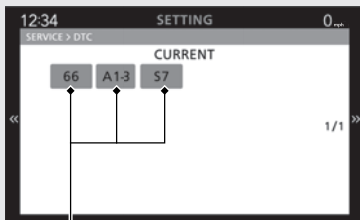

DTC indexes

RACE KIT ECU USE HISTORY

"RACE KIT ECU USE HISTORY" is displayed but not usable.



Indicators

If one of these indicators does not come on when it should, have your dealer check for problems.

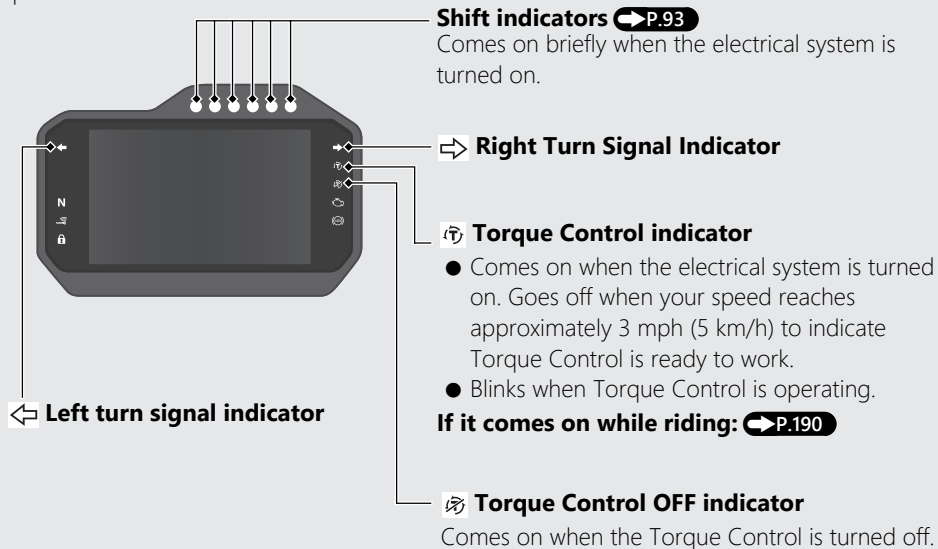

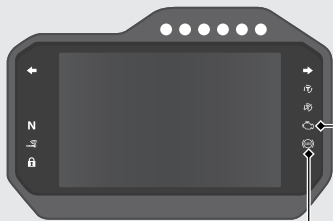

 **PGM-FI (Programmed Fuel Injection) malfunction indicator lamp (MIL)**

Comes on briefly when the electrical system is turned on.

If it comes on while engine is running:

 **P.188**

 **ABS (Anti-lock Brake System) indicator**

Comes on when the electrical system is turned on. Goes off when your speed reaches approximately 6 mph (10 km/h).

If it comes on while riding:  **P.189**

Indicators *(Continued)*

N Neutral indicator

Comes on when the transmission is in Neutral.

Honda SMART Key indicator

Comes on briefly when the electrical system is turned on.

When the Honda SMART Key Indicator Flashes:

 **P.191**

Steering lock indicator

Comes on briefly while the steering lock is activating.

Steering lock:  **P.98**



Shift Indicators

The shift indicators light or blink by the engine revolutions.

The timing and brightness of the indicators light/blink depend on the "REV INDICATOR" setting.

Setting of the Shift Indicators **P.60** **P.70**

The indicator colors are as follows.

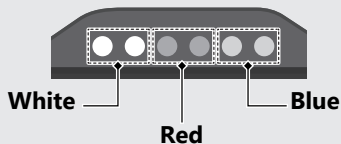





Definition:

	Engine revolutions	<	$A - (B \times 6)$	
$A - (B \times 6) \cong$	Engine revolutions	<	$A - (B \times 5)$	
$A - (B \times 5) \cong$	Engine revolutions	<	$A - (B \times 4)$	
$A - (B \times 4) \cong$	Engine revolutions	<	$A - (B \times 3)$	
$A - (B \times 3) \cong$	Engine revolutions	<	$A - (B \times 2)$	
$A - (B \times 2) \cong$	Engine revolutions	<	$A - (B \times 1)$	
$A - (B \times 1) \cong$	Engine revolutions	<	A	
A	Engine revolutions			

A: SHIFT POINT value
B: INTERVAL value

Switches

Headlight dimmer switch/PASSING/LAP switch

-  : High beam
-  : Low beam
-  /LAP: Flashes the high beam headlight.
Also use lap timer. 

Horn button

Hazard switch

Switchable when the electrical system is on. Can be turned to off regardless of whether the electrical system is on or off.

- ▶ The signals continue flashing with turn the electrical system is off after the hazard switch is on.

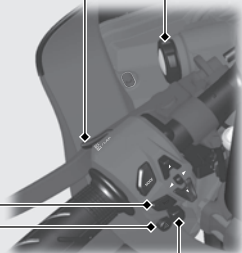

Turn signal switch

The turn signal will automatically stop when you complete the turn. (You can manually cancel the lights by pressing the switch in.) When used for a lane change, the turn signal will automatically stop in about 7 seconds or after riding 164 yards (150 m). In some cases, the timing at which the turn signal stops could be less or more. Always use the recommended tires to ensure correct automatic cancellation operation.



Ignition Switch

Switches the electrical system on/off, locks the steering.

- ▶ Make sure that the Honda SMART Key is activated  **P.101** and enter the operating range.  **P.102**

Ignition switch knob OFF/ (Lock)

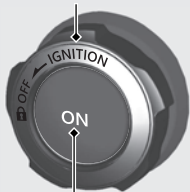

Ignition ON switch



 **(Lock)** Locks steering.  **P.98**









OFF Turns engine off.



ON Turns electrical system on for starting/riding.

  Push the ignition ON switch.

  Turn the ignition switch knob OFF/ (Lock) counterclockwise.

  Turn and hold the ignition switch knob OFF/ (Lock) counterclockwise.

Switches *(Continued)*

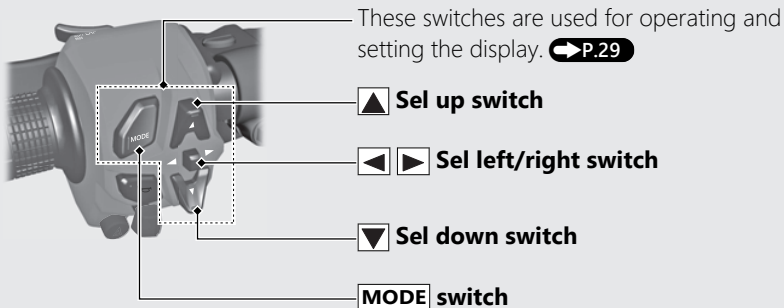

Engine stop switch/ ⚡ Start button

Should normally remain in the ⌚ (Run) position.

- ▶ In an emergency, switch to the ⓧ (Stop) position to stop the engine.

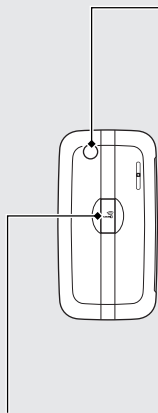

ON/OFF button

This button is used to activate or deactivate the Honda SMART Key system and also to confirm the activation status.  **P.101**

Release button

This button is used to release the mechanical key.

The mechanical key is used when refueling or removing the rear seat.

Avoid contact with the key whenever it extends or retracts.

To release the mechanical key

Press the release button to release the mechanical key.

▶ Make sure to fully extend the key.

To retract the mechanical key

Push the key into the key case while pressing the release button.

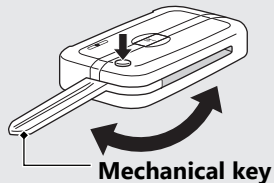

Switches *(Continued)*

Steering Lock

Lock the steering when parking to help prevent theft.

A U-shaped wheel lock or similar device is also recommended.

- ▶ When using a U-shaped wheel lock or similar device, be careful not to damage the wheels.

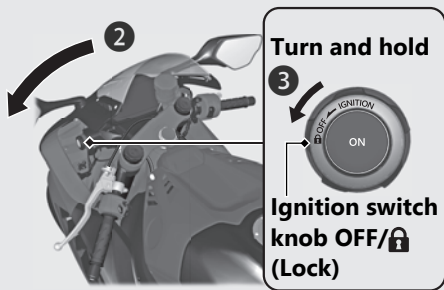

Locking

- 1 Turn the ignition switch knob OFF/LOCK (Lock) counterclockwise to turn off the electrical system.
- 2 Turn the handlebars all the way to the left.

- ③ Turn and hold the ignition switch knob OFF/

 (Lock) counterclockwise.



- ▶ The steering lock indicator comes on briefly and the steering is automatically locked.
- ▶ If the steering lock indicator blinks, the steering has not been locked completely because the steering was not positioned all the way to the left.

If this occurs, reposition the handlebars all the way to the left, then turn and hold the ignition switch counterclockwise (The steering can also be locked by positioning it all the way to the left within seconds after the steering lock indicator start blinking). Make sure the steering is locked.

Steering lock indicator



Unlocking

- ① Make sure that the Honda SMART Key is activated  **P.101** and enter the operating range.  **P.102**
- ② Push the ignition ON switch.
 - ▶ The steering is unlocked automatically.
 - ▶ If the steering lock indicator blinks, the steering is not unlocked because of excessive force on the steering. If this occurs, reposition the handlebars all the way to the left, then push the ignition ON switch. (The steering can also be unlocked by positioning it all the way to the left within seconds after the steering lock indicator starts blinking).

Honda SMART Key System

The Honda SMART Key system allows you to operate the main switch without inserting a key into a keyhole.

The system runs a two-way authentication between the vehicle and the Honda SMART Key to verify if it is the registered Honda SMART Key.

The Honda SMART Key system uses low-intensity radio waves. It may affect medical equipment such as a cardiac pacemaker.

Switching the Honda SMART Key System

To switch the Honda SMART Key system to activation or deactivation

Press the ON/OFF button until the Honda SMART Key LED changes color.

To check the Honda SMART Key system status

Lightly press the ON/OFF button.
The Honda SMART Key LED will show the status.

When the Honda SMART Key LED is:

Green: Honda SMART Key system authentication can be performed.

Red: Honda SMART Key system authentication cannot be performed.

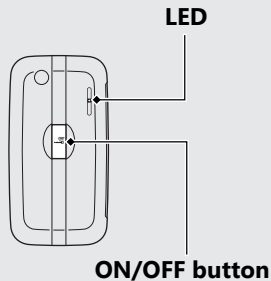

Honda SMART Key System *(Continued)*

Operating Range

The Honda SMART Key system uses low-intensity radio waves. Therefore, the operating range may be wider or narrower, or the Honda SMART Key system may not work properly in the following situations:

- When the Honda SMART Key battery is depleted.
- When there are facilities nearby that generate strong radio waves or noise, such as TV towers, power stations, radio stations, or airports.
- When you carry the Honda SMART Key with a laptop or wireless communication device such as a radio or mobile phone.
- When the Honda SMART Key comes into contact with or is covered by metal objects.

The system can be operated when the Honda SMART Key is within the shaded area shown in the illustration.

- ▶ Placing the Honda SMART Key on the fuel tank may cause communication failure.

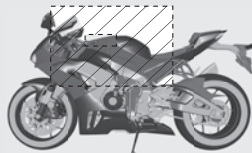
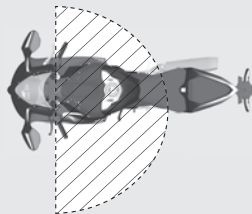

Anyone can operate the ignition switch and start the engine if your Honda SMART Key is within operating range of your vehicle, even if you are on the other side of a wall or window. If you are away from your vehicle but your Honda SMART Key will still be within the system's operating range, deactivate the Honda SMART Key system.

Activate or deactivate the Honda SMART Key system ➔ P.101

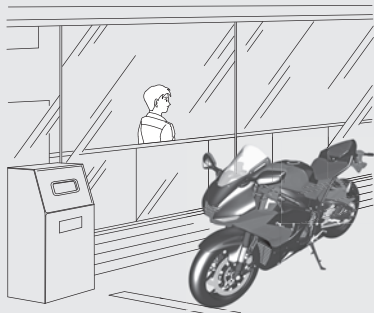

Anyone in possession of the Honda SMART Key can perform the following operations if the Honda SMART Key is within operating range:

- Starting the engine
- Unlocking the steering lock

You should always keep the Honda SMART Key on your person after you get on and off the vehicle or while riding.

Do not place the Honda SMART Key in the under the rear seat.

Honda SMART Key System *(Continued)*

If the electrical system is on, the vehicle can be operated even by a person who does not have a verified Honda SMART Key.

Whenever you leave your vehicle, turn off the electrical system and lock the steering.

➡ P.98

Operating the Ignition Switch

To Activate the Electrical System

- 1 Make sure that the Honda SMART Key is activated and enter the operating range for the vehicle. ➡ P.101
- 2 Push the ignition ON switch. ➡ P.95
 - ▶ The electrical system activates and the engine can be started.

Honda SMART Key

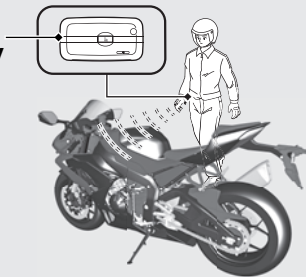

To turn Off the Electrical System

- 1 Turn the ignition switch knob OFF/🔒 (Lock) counterclockwise
- 2 Leave the operating range with the Honda SMART Key ➡ P.102 or switch the Honda SMART Key system to deactivation. ➡ P.101

When the Honda SMART Key system does not work properly ➡ P.192

Riding mode

You can change the riding mode.
The riding mode consists of the following parameters.

P: Engine output level

T: Torque control level

W: Wheelie control level

EB: Engine brake level

CBR1000SP

S: Suspension mode

When "-" is displayed, go to your dealer for service.

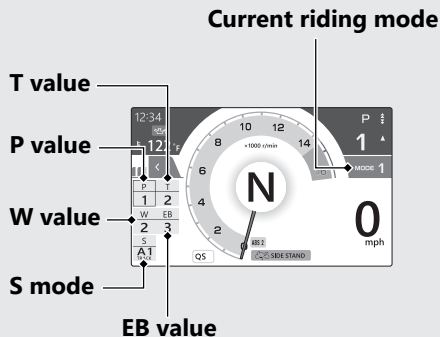

Riding mode *(Continued)*

Riding mode has three modes.

Available riding mode: MODE 1, MODE 2 or MODE 3.

Each value can be changed.

CBR1000SP

Setting of S mode can be changed.

Initial setting

Riding modes	P value	T value	W value	EB value	S mode
					CBR1000SP
MODE 1	1	2	2	3	A1 (TRACK)
MODE 2	2	5	2	3	A2 (SPORT)
MODE 3	5	8	3	1	A3 (RAIN)

P value (Engine output level)

P value has five setting levels.

Available setting range: 1 to 5

- ▶ Level 1 has the most power.
- ▶ Level 5 has the least power.

T value (Torque control level)

T value has ten setting levels.

Available setting range: 0 to 9

- ▶ Level 1 is the minimum Torque Control level.
- ▶ Level 9 is the maximum Torque Control level.
- ▶ Level 0 deactivates the Torque Control.
- ▶ When the T value is set to 0, the W value automatically changes 0.
- ▶ If the electrical system is turned from off to on while the T value is set to 0, the T value is automatically set to 1. W value returns to the level before T value was set to 0.

W value (Wheelie control level)

W value has four setting levels.

Available setting range: 1 to 3

- ▶ Level 1 is the minimum Wheelie Control level.
- ▶ Level 3 is the maximum Wheelie Control level.
- ▶ Level 0 deactivates the Wheelie Control.

EB value (Engine brake level)

EB value has three setting levels.

Available setting range: 1 to 3

- ▶ Level 1 has the strongest engine braking effect.
- ▶ Level 3 has the weakest engine braking effect.

S mode (Suspension mode)

CBR1000SP

S mode has six modes.

Available modes: A1, A2, A3, M1, M2 and M3

Adjusting the ÖHLINS Smart EC system

➔ **P.175**

Riding mode *(Continued)*

Selecting the riding mode

The riding mode changes each time the **MODE** switch is pressed.

- ▶ When the riding mode is changed the P, T, W, and EB values appear briefly in the INFO area.

CBR1000SP

The S value also appears.

MODE switch

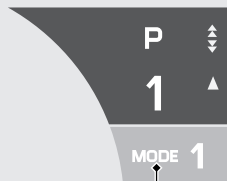
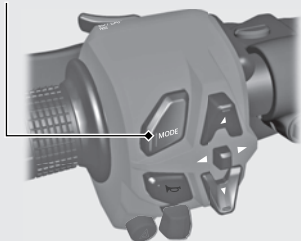

Current riding mode

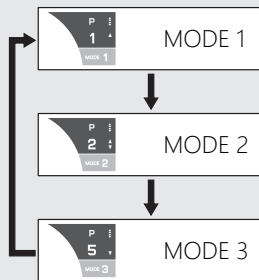

➔ Press the **MODE** switch

Setting the riding mode

CBR1000ST

You can change the P, T, W and EB values.

CBR1000SP

You can change the P, T, W, EB values and S mode.

You can change the riding mode setting from the setting mode of display. ➔P.60

➔P.64

The value displayed in FAVORITE can be changed without shifting to the setting mode of display.

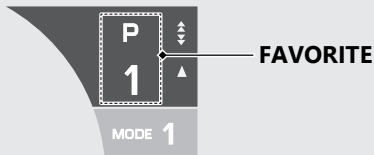

- 1 Select the riding mode you want to set.

➔P.108

- 2 **To change the type of parameter displayed in FAVORITE**

Press and hold the sel up switch or sel down switch to select the parameter.

- 2 **To change the value of parameter displayed in FAVORITE**

Press the sel up or sel down switch to select the value.

- ▶ The T value cannot be set to 0 in FAVORITE.

To set the T value to 0, set in the setting mode of the display. ➔P.60

➔P.64

Riding mode *(Continued)*

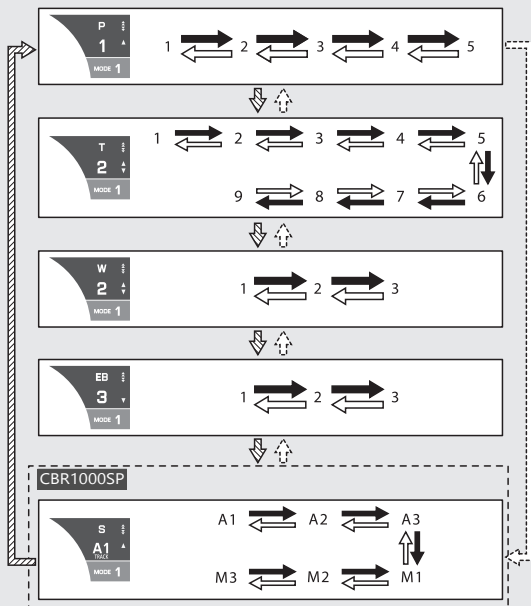

Sel up switch

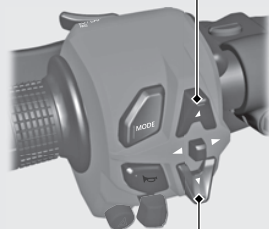

Sel down switch

- Press and hold the sel up switch
- Press and hold the sel down switch
- Press the sel up switch
- Press the sel down switch

Starting the Engine

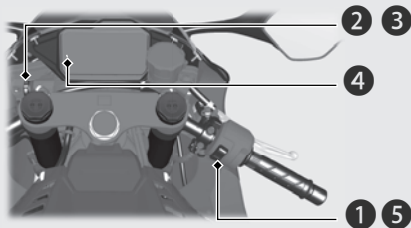

Start your engine using the following procedure, regardless of whether the engine is cold or warm.

This vehicle is equipped with a Honda SMART Key system. Always keep Honda SMART Key on you when you ride the vehicle. **➡P.100**



NOTICE

- If the engine does not start within 5 seconds, turn the electrical system off and wait 10 seconds before trying to start the engine again to recover battery voltage.
- Extended fast idling and rewing the engine can damage the engine, and the exhaust system.
- Snapping the throttle or fast idling for more than about 5 minutes may cause exhaust pipe discoloration.
- The engine will not start if the throttle is fully open.

- 1 Make sure the engine stop switch is in the  (Run) position.
- 2 Unlock the steering. **➡P.99**
- 3 Activate the electrical system. **➡P.104**
- 4 Shift the transmission to Neutral ( indicator comes on). Alternatively, pull in the clutch lever to start your vehicle with the transmission in gear so long as the side stand is raised.
- 5 Press the start button with the throttle completely closed.

Starting the Engine *(Continued)*

If the engine does not start:

- ① Open the throttle fully and press the start button for 5 seconds.
- ② Repeat the normal starting procedure.
- ③ If the engine starts, open the throttle slightly if idling is unstable.
- ④ If the engine does not start, wait 10 seconds before trying steps ① & ② again.

If Engine Will Not Start ➡ P.186

Shifting Gears

Your vehicle transmission has 6 forward gears in a one-down, five-up shift pattern.

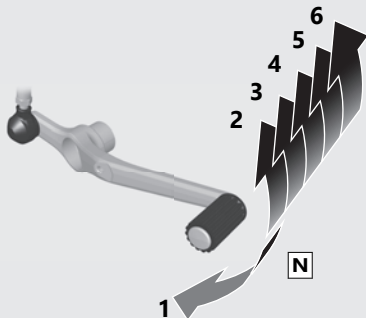

If you put the vehicle in gear with the side stand down, the engine will shut off.

Recommended Shift Points

Shifting Up

From 1st to 2nd	12 mph (20 km/h)
From 2nd to 3rd	19 mph (30 km/h)
From 3rd to 4th	25 mph (40 km/h)
From 4th to 5th	31 mph (50 km/h)
From 5th to 6th	37 mph (60 km/h)

Shifting Down

From 6th to 5th	28 mph (45 km/h)
From 5th to 4th	22 mph (35 km/h)
From 4th to 3rd	16 mph (25 km/h)

NOTICE

Improper shifting can damage the engine, transmission, and drive train. Also, coasting or towing the vehicle for long distances with the engine off can damage the transmission.

Shifting Gears *(Continued)*

Quick Shifter

CBR1000SP

This system enables very quick up and down shifting without clutch and throttle operations.

- ▶ This system does not function when upshifting with the throttle closed.
 - ▶ This system functions when the engine speed is more than 1,500 r/min (rpm) on upshifting or more than the idle speed on downshifting.
 - ▶ This system does not function when the clutch lever is being operated.
- If “-” is displayed on the gear position indicator, the Quick Shifter system does not operate.
 - If the Quick Shifter does not operate normally, the clutch can be used to complete the shift operation.

- The Quick Shifter can be individually turned ON (active) and OFF (deactivate), also the shift pedal load level for activating the Quick Shifter can be adjusted during up and down shifting.
- If the PGM-FI malfunction indicator lamp comes on or the gear position indicator flashes “-” in the current gear position, the Quick Shifter system may not operate. If either of the above occurs, contact your dealer as soon as possible.

To Change the Setting of Quick Shifter

➡ P.60

➡ P.67

Start Mode

Your vehicle controls the engine torque to support optimal acceleration from standstill.

⚠️ WARNING

Using the Start Mode on public roads can lead to a crash in which you, pedestrians and other road users could be seriously hurt or killed.

Only use the Start Mode on a closed course.

The system puts a tremendous load on the clutch. Frequent use of this system may lead to reduced engine life. Have your dealer check the clutch for wear and replace if necessary.

To set the Start Mode

- 1 Start the engine. ➡️ **P.111**
- 2 Stop the vehicle completely with the transmission in Neutral.
- 3 Set to SPORT mode. ➡️ **P.60** ➡️ **P.72**
- 4 Press and hold the ▲ sel up or ▼ sel down switch and PASSING/LAP switch until the "START MODE" message appears in the display.









Start Mode *(Continued)*

If a "START MODE" pop-up with a gray background appears in the display, Start Mode cannot be engaged due to one of the following conditions:

- The vehicle is moving.
- Torque Control is off.
- The gear position is not Neutral or 1st gear.
- The side stand is down.
- The throttle is not completely closed.
- The coolant temperature is low.
- The "START MODE REV" setting is "OFF".



➡ P.60 ➡ P.71

- 5 Press and hold the  sel up or  sel down switch and PASSING/LAP switch until the "START MODE" pop-up information with orange background appears in the display.
 - ▶ To cancel the Start Mode, press and hold the  sel up or  sel down switch and PASSING/LAP switch.
- 6 Shift the transmission to 1st gear.

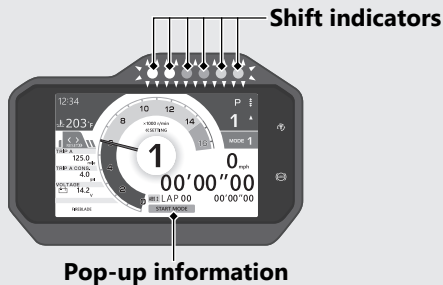
- 7 Fully open the throttle.
- ▶ Engine RPMs will be limited by the set value of "START MODE REV" The "START MODE" pop-up information background will change from orange to green and all shift indicators will flash. To set the "START MODE REV"  
 - ▶ Gradually engage the clutch.
 - ▶ After engaging the clutch, Start Mode controls the torque.



After the vehicle starts moving, it will deactivate when any one of the following conditions occurs:

- The transmission is shifted into 3rd gear.
- The RPMs reach the shift indicator limit value in 1st gear.  
- A lean angle greater than 20 degrees occurs.
- The throttle is closed.

NOTICE

To prevent clutch damage, always wait at least 3 minutes between each Start Mode activation.

Refueling

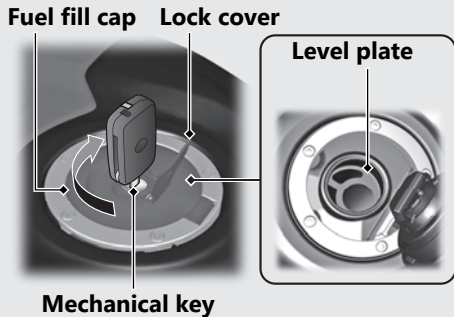

Do not fill with fuel above the level plate.

Fuel type: Unleaded gasoline only

Recommended fuel octane number:
Pump Octane Number (PON) 91 or higher.

Tank capacity: 4.25 US gal (16.1 L)

Refueling and Fuel Guidelines ➔ P.14

Opening the Fuel Fill Cap

Open the lock cover, insert the mechanical key, and turn it clockwise to open the fuel fill cap.

Closing the Fuel Fill Cap

- 1 After refueling, push the fuel fill cap closed until it locks.
- 2 Remove the mechanical key and close the lock cover.
 - ▶ The mechanical key cannot be removed if the fuel fill cap is not locked.

⚠ WARNING

Gasoline is highly flammable and explosive. You can be burned or seriously injured when handling fuel.

- Stop the engine, and keep heat, sparks, and flame away.
- Handle fuel only outdoors.
- Wipe up spills immediately.

Storage Equipment

Helmet Holder

The helmet holders are located underside of the rear seat.

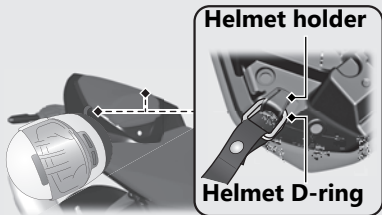

► Use the helmet holder only when parked.

Removing the Rear Seat ➔ P.150

⚠ WARNING

Riding with a helmet attached to the holder can interfere with your ability to safely operate the vehicle and could lead to a crash in which you can be seriously hurt or killed.

Use the helmet holder only while parked. Do not ride with a helmet secured by the holder.

Storage Equipment *(Continued)*

Tool kit/Owner's manual

The tool kit is located under the rear seat.

The owner's manual is stored in the tool bag.

Tool kit

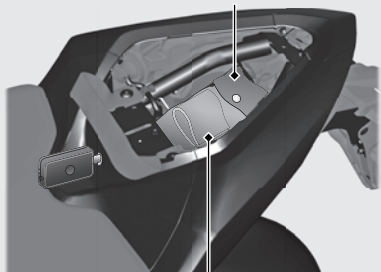

Owner's manual

Removing the Rear Seat P.150

Maintenance

Please read "Importance of Maintenance" and "Maintenance Fundamentals" carefully before attempting any maintenance. Refer to "Specifications" for service data.

An optional larger tool kit may be available.
Check with your Honda dealer's parts department.

Importance of Maintenance	P. 122	Side Stand	P. 161
Maintenance Schedule	P. 124	Drive Chain	P. 162
Maintenance Record	P. 127	Clutch	P. 163
Maintenance Fundamentals	P. 128	Throttle	P. 166
Removing & Installing Body		Other Adjustments	P. 167
Components	P. 146	Adjusting the Brake Lever	P. 167
Battery	P. 146	Adjusting the Front Suspension	P. 169
Clip	P. 148	Adjusting the Rear Suspension	P. 172
Front Seat.....	P. 149	Adjusting the ÖHLINS Smart EC System....	P. 175
Rear Seat	P. 150	Other Replacement	P. 183
Under Cowl.....	P. 151	Replacing the Honda SMART Key Battery ..	P. 183
Engine Oil	P. 153		
Coolant	P. 155		
Brakes	P. 158		

Importance of Maintenance

Importance of Maintenance

Keeping your vehicle well-maintained is absolutely essential to your safety and to protect your investment, obtain maximum performance, avoid breakdowns, and reduce air pollution. Maintenance is the owner's responsibility. Be sure to inspect your vehicle before each ride, and perform the periodic checks specified in the Maintenance Schedule.

➤ P. 124

⚠ WARNING

Improperly maintaining your vehicle or failing to correct a problem before you ride can cause a crash in which you can be seriously hurt or killed.

Always follow the inspection and maintenance recommendations and schedules in this owner's manual.

For information about the exhaust emission and noise emission requirements of the U.S. Environmental Protection Agency (EPA), the California Air Resources Board (CARB), and the Environment and Climate Change Canada (ECCC). ➤ P. 219

USA

Maintenance, replacement or repair of the emission control devices and systems may be performed by any vehicle repair establishment or individual using parts that are "certified" to EPA standards.

Maintenance Safety

Always read the maintenance instructions before you begin each task, and make sure that you have the tools, parts, and skills required. We cannot warn you of every conceivable hazard that can arise in performing maintenance. Only you can decide whether or not you should perform a given task.

Follow these guidelines when performing maintenance.

- Stop the engine and keep the electrical system off.
- Place your vehicle on a firm, level surface using the side stand or a maintenance stand to provide support.
- Allow the engine, muffler, brakes, and other high-temperature parts to cool before servicing as you can get burned.
- Run the engine only when instructed, and do so in a well-ventilated area.







































Maintenance Schedule

The maintenance schedule specifies the maintenance requirements necessary to ensure safe, dependable performance, and proper emission control.

Maintenance work should be performed in accordance with Honda's standards and specifications by properly trained and equipped technicians. Your dealer meets all of these requirements. All scheduled maintenance is considered a normal owner operating cost and will be charged to you by your dealer. Keeping an accurate maintenance record will help ensure your vehicle is properly maintained.

➤ P. 127

Make sure whoever performs the scheduled maintenance completes the maintenance record. Retain all service documents. If you sell your vehicle, these service documents should be transferred with the vehicle to the new owner.

Items	Frequency*1								Regular Replace	Refer to page	
	× 1,000 mi	0.6	4	8	12	16	20	24			
	× 1,000 km	1.0	6.4	12.8	19.2	25.6	32.0	38.4			
Fuel Line										-	
Throttle Operation										166	
Air Cleaner *2										-	
Spark Plug		Every 16,000 mi (25,600 km):  Every 32,000 mi (51,200 km): 									-
Valve Clearance										-	
Engine Oil									1 Year	-	
Engine Oil Filter										-	
Engine Idle Speed										-	
Radiator Coolant *4									3 Years	155	
Cooling System										-	
Secondary Air Supply System										-	
Evaporative Emission Control System *3										-	
Exhaust Gas Control Actuator Cable										-	

Maintenance Level

 : Intermediate. We recommend service by your dealer, unless you have the necessary tools and are mechanically skilled. Procedures are provided in an official Honda Service Manual (P. 225).

 : Technical. In the interest of safety, have your vehicle serviced by your dealer.





Maintenance Legend

 : Inspect (clean, adjust, lubricate, or replace, if necessary)

 : Replace

 : Lubricate

Maintenance Schedule

Items	Frequency*1								Regular Replace	Refer to page	
	× 1,000 mi	0.6	4	8	12	16	20	24			
	× 1,000 km	1.0	6.4	12.8	19.2	25.6	32.0	38.4			
Drive Chain	Every 600 mi (1,000 km): I, L									162	
Brake Fluid *4			I	I	I	I	I	I	2 Years	158	
Brake Pads Wear			I	I	I	I	I	I		159	
Brake System				I		I		I		128	
Brake light Switch				I		I		I		160	
Headlight Aim				I		I		I		–	
Clutch System			I	I	I	I	I	I		163	
Side Stand				I		I		I		161	
Suspension				I		I		I		169	
Front Fork Oil (CBR1000SP)		Every 10,000 mi (15,000 km): R								2 Years	–
Nuts, Bolts, Fasteners				I		I		I		–	
Wheels/Tires				I		I		I		142	
Steering Head Bearings				I		I		I		–	

Notes:

*1 : At higher odometer reading, repeat at the frequency interval established here.

*2 : Service more frequently when riding in unusually wet or dusty areas.

*3 : 50 STATE (meets California).

*4 : Replacement requires mechanical skill.

Maintenance Record

Distance	Odometer	Date	Performed By:	Notes
600 miles (1,000 km)				
4,000 miles (6,400 km)				
8,000 miles (12,800 km)				
12,000 miles (19,200 km)				
16,000 miles (25,600 km)				
20,000 miles (32,000 km)				
24,000 miles (38,400 km)				
28,000 miles (44,800 km)				
32,000 miles (51,200 km)				
36,000 miles (57,600 km)				
40,000 miles (64,000 km)				
44,000 miles (70,400 km)				
48,000 miles (76,800 km)				
52,000 miles (83,200 km)				
56,000 miles (89,600 km)				
60,000 miles (96,000 km)				
64,000 miles (102,400 km)				
68,000 miles (108,800 km)				

Pre-ride Inspection

To ensure safety, it is your responsibility to perform a pre-ride inspection and make sure that any problem you find is corrected. A pre-ride inspection is a must, not only for safety, but because having a breakdown, or even a flat tire, can be a major inconvenience.

Check the following items before you get on your vehicle:

- Tire tread wear and air pressures are within limits. ➔ P. 142
- Lights, horn, and turn signals operate normally.
- Check the condition of the drive chain. Adjust slack and lubricate as needed. ➔ P. 140

Check the following items if you are carrying a passenger or cargo:

- Combined weight is within load limits. ➔ P. 233
- Cargo is secured properly.
- Suspension is adjusted to suit load. ➔ P. 169, ➔ P. 172

Check the following items after you get on your vehicle:

- Throttle action moves smoothly without binding. ➔ P. 166
- Brake lever and pedal operate normally.
- Refuel when needed. ➔ P. 14, ➔ P. 118
- Engine stop switch functions properly. ➔ P. 94

Check the following items at regular intervals:

- Oil level is between the upper and lower level marks. ➔ P. 153
- Brake fluid level is
CBR1000ST
Front: between the UPPER and LOWER level marks. ➔ P. 158
Rear: between the UPPER and LOWER level marks. ➔ P. 158
CBR1000SP
Front: between the MAX and MIN level marks. ➔ P. 158
Rear: between the UPPER and LOWER level marks. ➔ P. 158
- Engine coolant level is between the UPPER and LOWER level marks. ➔ P. 155
- Side stand functions properly. ➔ P. 161

Periodic Checks

You should also perform other periodic maintenance checks at least once a month regardless of how often you ride, or more often if you ride frequently.

Also, check the odometer reading against the Maintenance Schedule and perform all maintenance that is due. ➔ P. 124

Tires and wheels

Check the air pressure (➔ P. 142), examine tread for wear and damage (➔ P. 142), and check the wheels for damage.

Fluid levels

Check the engine oil level (➔ P. 153), engine coolant level (➔ P. 155), and brake fluid level (➔ P. 158).

Lights

Check that the headlight, position light, brake light, taillight, turn signals and license plate light are working properly.

Controls

Check the freeplay of the clutch lever (➔ P. 163) and throttle grip (➔ P. 166).

Drive chain

Check the slack (➔ P. 162) and lubricate (➔ P. 140) as needed.

Fuses

Check that you have a full supply of spare fuses.

Nuts & bolts

Check the major nuts and bolts, and tighten as needed.

Replacing Parts

Always use Honda Genuine Parts or their equivalents to ensure reliability and safety. When ordering colored components, specify the model name, color, and code mentioned on the color label.

The color label is attached on the under the rear seat.

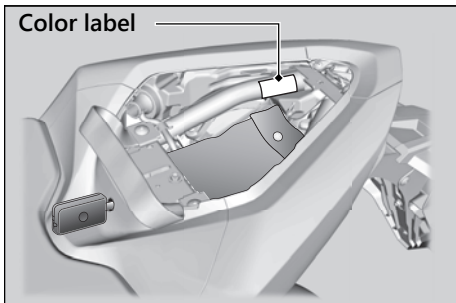

⚠️ WARNING

Installing non-Honda parts may make your vehicle unsafe and cause a crash in which you can be seriously hurt or killed.

Always use Honda Genuine Parts or equivalents that have been designed and approved for your vehicle.

Battery

CBR1000SP

Your vehicle has a lithium-ion (li-ion) battery.

➔ P. 134

CBR1000ST

Your vehicle has a maintenance-free type battery. You do not have to check the battery electrolyte level or add distilled water. Clean the battery terminals if they become dirty or corroded.

Do not remove the battery cap seals. There is no need to remove the cap when charging.

NOTICE

An improperly disposed of battery can be harmful to the environment and human health. Always confirm local regulations for proper battery disposal instruction.

What to do in an emergency

If any of the following occur, immediately see your doctor.

- Electrolyte splashes into your eyes:
 - ▶ Wash your eyes repeatedly with cool water for at least 15 minutes. Using water under pressure can damage your eyes.
- Electrolyte splashes onto your skin:
 - ▶ Remove affected clothing and wash your skin thoroughly using water.

- Electrolyte splashes into your mouth:
 - ▶ Rinse mouth thoroughly with water, and do not swallow.

⚠ WARNING

The battery gives off explosive hydrogen gas during normal operation.

A spark or flame can cause the battery to explode with enough force to kill or seriously hurt you.

Wear protective clothing and a face shield, or have a skilled mechanic do the battery servicing.

WARNING: Battery posts, terminals, and related accessories contain lead and lead compounds.

Wash your hands after handling.

■ Cleaning the Battery Terminals

1. Remove the battery. ➤ P. 146
2. If the terminals are starting to corrode and are coated with a white substance, wash with warm water and wipe clean.
3. If the terminals are heavily corroded, clean and polish the terminals with a wire brush or sandpaper. Wear safety glasses.

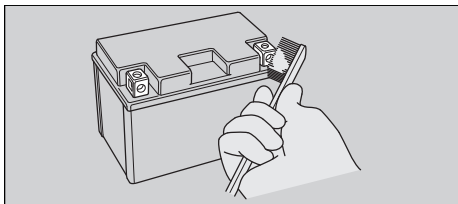

4. After cleaning, reinstall the battery.

The battery has a limited life span. Consult your dealer about when you should replace the battery. Always replace the battery with another maintenance-free battery of the same type.

| Charging

If you use electrical accessories that drain the battery or you do not ride frequently, we recommend that you charge the battery every 30 days using a charger designed specifically for your Honda, which can be purchased from your dealer. Read the information that came with your battery charger and follow the instructions on the battery. Avoid using an automobile-type battery charger, as these can overheat a motorcycle battery and cause permanent damage.

Make sure the electrical system is off before charging the battery.

NOTICE

Improper charging can damage the battery. If you can't charge the battery or it appears unable to hold a charge, contact your dealer.

NOTICE

Jump starting using an automobile battery can damage your vehicle's electrical system and is not recommended. Bump starting is also not recommended.

NOTICE

Installing non-Honda electrical accessories can overload the electrical system, discharging the battery and possibly damaging the system.

Lithium-Ion (Li-Ion) Battery

CBR1000SP

Your vehicle has a lithium-ion (li-ion) battery. Clean the battery terminals if they become dirty or corroded.

NOTICE

An improperly disposed of battery can be harmful to the environment and human health. Always confirm local regulations for proper battery disposal instruction.

What to do in an emergency

If any of the following occurs, immediately see your doctor.

- Electrolyte splashes into your eyes:
 - ▶ Wash your eyes repeatedly with cool water for at 15 minutes. Using water under pressure can damage your eyes.
- Electrolyte splashes onto your skin:
 - ▶ Remove affected clothing and wash your skin thoroughly using water.
- Electrolyte splashes into your mouth
 - ▶ Rinse mouth thoroughly with water, and do not swallow.

⚠ WARNING

The battery contains flammable organic solvent as electrolyte.

You can be burned or seriously injured if the battery is handled improperly.

- Keep the battery away from heat, sparks, and flame.
- Keep the battery out of the reach of children.
- Do not disassemble or modify the battery or battery terminals.
- Do not short-circuit the battery with metal tools or other metal objects.
- Do not subject the battery to impacts.

| Cleaning the Battery Terminals

1. Remove the battery. ➤ P. 146
2. If the terminals are starting to corrode and are coated with a white substance, wash with warm water and wipe clean.
3. If the terminals are heavily corroded, clean and polish the terminals with a wire brush or sandpaper. Wear safety glasses.

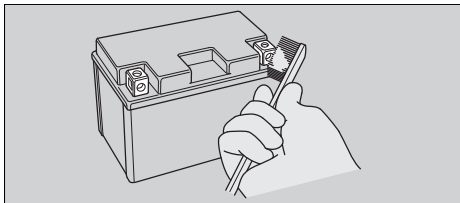

4. After cleaning, reinstall the battery.

The battery has a limited life span. Consult your dealer about when you should replace the battery. Always replace the battery with another lithium-ion (li-ion) battery of the same type.

Charging

If you use electrical accessories that drain the battery or you do not ride frequently, we recommend that you charge the battery every 30 days using a charger recommended by your lithium-ion (li-ion) battery manufacturer. Contact your dealer before charging the battery.

Make sure the electrical system is off before charging the battery.

NOTICE

Only use a charger recommended by your lithium-ion (li-ion) battery manufacturer. Using a battery charger that is not recommended can cause permanent damage to your battery.

NOTICE

Improper charging can damage the battery. If you can't charge the battery or it appears unable to hold a charge, contact your dealer.

NOTICE

Do not jump-start, as this can damage your vehicle's electrical system and battery. Bump starting is not recommended.

NOTICE

Installing non-Honda electrical accessories can overload the electrical system, discharging the battery and possibly damaging the system.

Fuses

Fuses protect the electrical circuits on your vehicle. If something electrical on your vehicle stops working, check for and replace any blown fuses. ➤ P. 202

Inspecting and Replacing Fuses

Turn off the electrical system to remove and inspect fuses. If a fuse is blown, replace with a fuse of the same rating. For fuse ratings, see "Specifications." ➤ P. 235

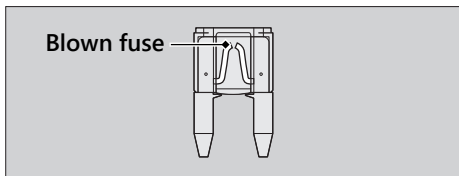

NOTICE

Replacing a fuse with one that has a higher rating greatly increases the chance of damage to the electrical system.

If a fuse fails repeatedly, you likely have an electrical fault. Have your vehicle inspected by your dealer.

Engine Oil

Engine oil consumption varies and oil quality deteriorates according to riding conditions and time elapsed.

Check the engine oil level regularly, and add the recommended engine oil if necessary. Dirty oil or old oil should be changed as soon as possible.

Selecting the Engine Oil

For recommended engine oil, see "Specifications." ➤ P. 234

If you use non-Honda engine oil, check the label to make sure that the oil satisfies all of the following standards:

- JASO T 903 standard*¹: MA
- SAE standard*²: 10W-30
- API classification*³: SG or higher

- *1. The JASO T 903 standard is an index for engine oils for 4-stroke motorcycle engines. There are two classes: MA and MB. For example, the following label shows the MA classification.

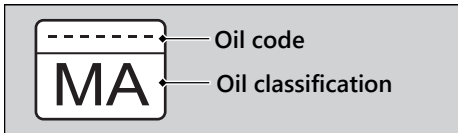

- *2. The SAE standard grades oils by their viscosity.
- *3. The API classification specifies the quality and performance rating of engine oils. Use SG or higher oils, excluding oils marked as "Energy Conserving" or "Resource Conserving" on the circular API service symbol.

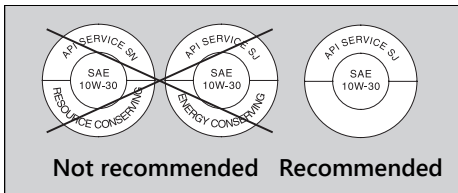

Brake Fluid

Do not add or replace brake fluid, except in an emergency. Use only fresh brake fluid from a sealed container. If you do add fluid, have the brake system serviced by your dealer as soon as possible.

NOTICE

Brake fluid can damage plastic and painted surfaces. Wipe up spills immediately and wash thoroughly.

Recommended brake fluid:

Honda DOT 4 Brake Fluid or equivalent

⚠ WARNING

Clean filler cap before removing. Use only DOT 4 fluid from a sealed container.

Drive Chain

The drive chain must be inspected and lubricated regularly. Inspect the chain more frequently if you often ride on bad roads, ride at high speed, or ride with repeated fast acceleration. 📄 P. 162

If the chain does not move smoothly, makes strange noises, has damaged rollers, has loose pins, has missing O-rings, or kinks, have the chain inspected by your dealer.

Also inspect the drive sprocket and driven sprocket. If either has worn or damaged teeth, have the sprocket replaced by your dealer.

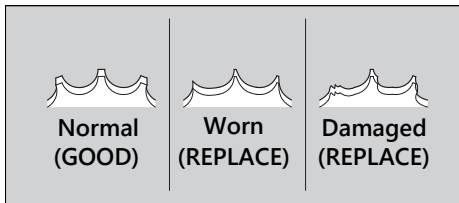

NOTICE

Use of a new chain with worn sprockets will cause rapid chain wear.

Cleaning and Lubricating

After inspecting the slack, clean the chain and sprockets while rotating the rear wheel. Use a dry cloth with chain cleaner designed specifically for O-ring chains, or neutral detergent. Use a soft brush if the chain is dirty.

After cleaning, wipe dry and lubricate with the recommended lubricant.

Recommended lubricant:

Pro Honda HP Chain Lube or equivalent

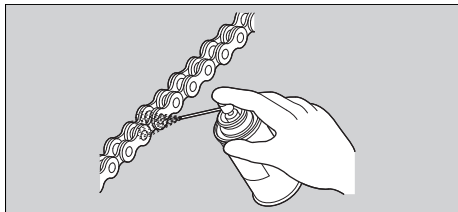

Do not use a steam cleaner, a high pressure cleaner, a wire brush, volatile solvent such as gasoline and benzene, abrasive cleaner, chain cleaner or lubricant NOT designed specifically for O-ring chains as these can damage the rubber O-ring seals.

Avoid getting lubricant on the brakes or tires.

Avoid applying excess chain lubricant to prevent spray onto your clothes and the vehicle.

Recommended Coolant

Pro Honda HP Coolant is a pre-mixed solution of antifreeze and distilled water.

Concentration:

50% antifreeze and 50% distilled water

A concentration of antifreeze below 40% will not provide proper corrosion and cold temperature protection.

A concentration of up to 60% will provide better protection in colder climates.

NOTICE

Using coolant not specified for aluminum engines or tap/mineral water can cause corrosion.

Tires (Inspecting/Replacing)

Checking the Air Pressure

Visually inspect your tires and use an air pressure gauge to measure the air pressure at least once a month or any time you think the tires look low. Always check air pressure when your tires are cold.

Even if the direction of the valve stem is changed, do not return it to the original position. Have your vehicle inspected by your dealer.

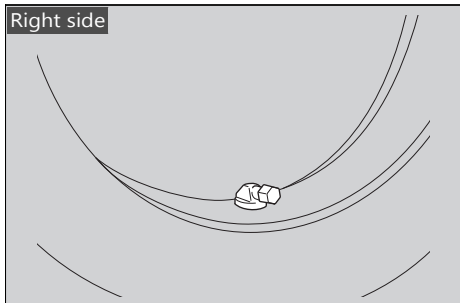

Inspecting for Damage

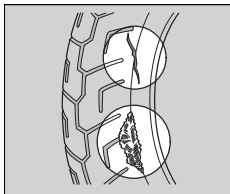

Inspect the tires for cuts, slits, or cracks that exposes fabric or cords, or nails or other foreign objects embedded in the side of the tire or the tread.

Also inspect for any unusual bumps or bulges in the side walls of the tires.

Inspecting for Abnormal Wear

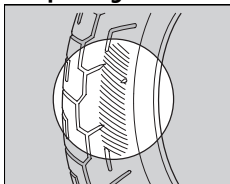

Inspect the tires for signs of abnormal wear on the contact surface.

Inspecting Tread Depth

Inspect the tread wear indicators. If they become visible, replace the tires immediately. For safe riding, you should replace the tires when the minimum tread depth is reached.

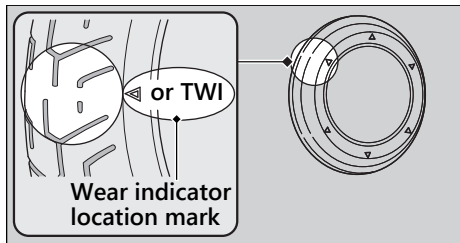

⚠WARNING

Riding on tires that are excessively worn or improperly inflated can cause a crash in which you can be seriously hurt or killed.

Follow all instructions in this owner's manual regarding tire inflation and maintenance.

Maintenance Fundamentals

Have your tires replaced by your dealer. For recommended tires, air pressure and minimum tread depth, see "Specifications."

➤ P. 234

Follow these guidelines whenever you replace tires.

- Use the recommended tires or equivalents of the same size, construction, speed rating, and load range.
- Have the wheel balanced with Honda Genuine balance weights or equivalent after the tire is installed.
- Do not install a tube inside a tubeless tire on this vehicle. Excessive heat build-up can cause the tube to burst.
- Use only tubeless tires on this vehicle. The rims are designed for tubeless tires, and during hard acceleration or braking, a tube-type tire could slip on the rim and cause the tire to rapidly deflate.

WARNING

Installing improper tires on your vehicle can adversely affect handling and stability, and can cause a crash in which you can be seriously hurt or killed.

Always use the size and type of tires recommended in this owner's manual.

Tire Service Life

The service life of your tires is dependent on many factors, including, but not limited to, riding habits, road conditions, vehicle loading, tire air pressure, maintenance history, speed, and environmental conditions (even when the tires are not in use).

In addition to your regular inspections and maintenance, it is recommended that you have annual inspections performed once the tires reach 5 years old. It is also recommended that all tires be removed from service after 10 years from the date of manufacture, regardless of their condition or state of wear.

The last four digits of the TIN (tire identification number) indicate the date of manufacture.

Tire Identification Number (TIN)

The tire identification number (TIN) is a group of numbers and letters located on the sidewall of the tire.

① ② ③

DOT XXXX XXXX 22 09

DOT: This indicates that the tire meets all requirements of the U.S. Department of Transportation.

- ① XXXX: Factory code
- ② XXXX: Tire type code
- ③ 22 09: Date of manufacture (week & year).
Example: week 22 in year 09.

Tire Labeling Example

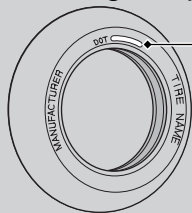

Tire identification number (TIN)

Removing & Installing Body Components

Battery

CBR1000ST

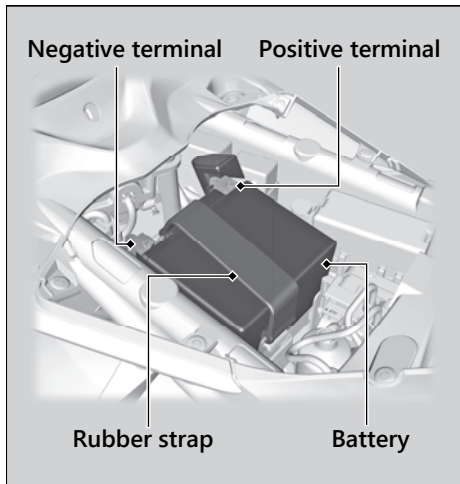

CBR1000SP

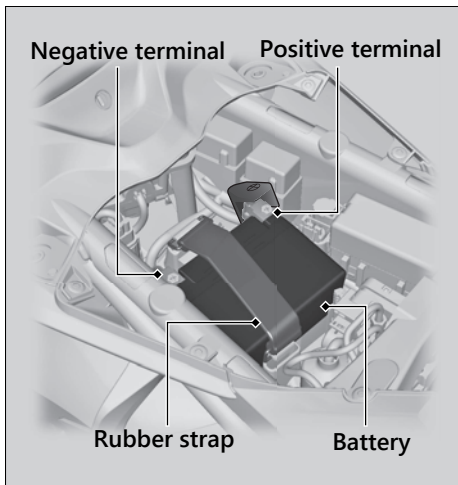

■ Removal

Make sure the electrical system is turned off.

1. Remove the front seat. ► P. 149
2. Unhook the rubber strap.
3. Disconnect the negative \ominus terminal from the battery.
4. Disconnect the positive \oplus terminal from the battery.
5. Remove the battery taking care not to drop the terminal nuts.

■ Installation

Install the parts in the reverse order of removal. Always connect the positive \oplus terminal first. Make sure that bolts and nuts are tight.

Make sure the clock information is correct after the battery is reconnected. ► P. 81
For proper handling of the battery, see "Maintenance Fundamentals." ► P. 128
"Battery Goes Dead." ► P. 200

Clip

Removal

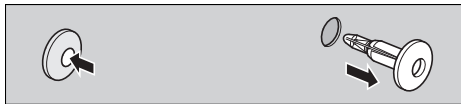

1. Press down on the center pin to release the lock.
2. Pull the clip out of the hole.

Installation



1. Push the bottom of the center pin.
2. Insert the clip into the hole.
3. Press down on the center pin to lock the clip.

Front Seat

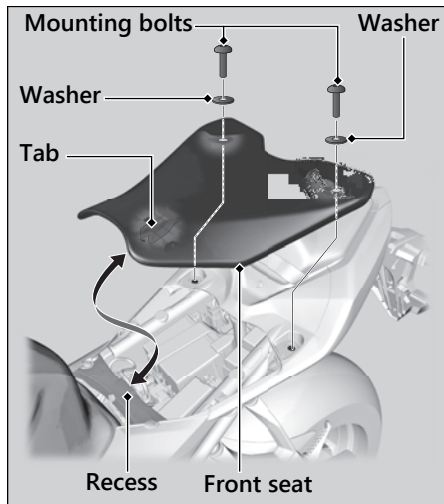

Removal

Remove the mounting bolts and washers, and then pull the front seat back and up.

Installation

1. Install the front seat while inserting the tab into the recess.
2. Install the washers and mounting bolts.
3. Tighten the mounting bolts securely. Make sure that the seat is locked securely in position by pulling it up lightly.

Rear Seat

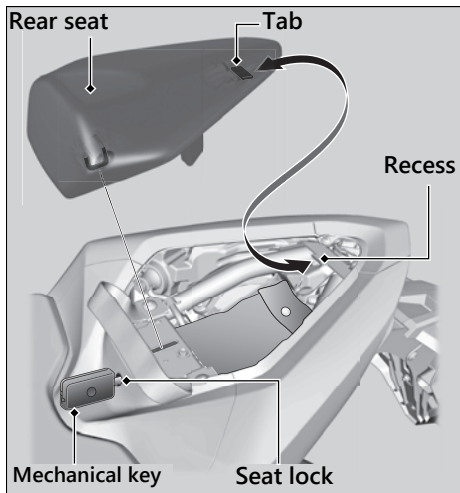

Removal

1. Insert the mechanical key into the seat lock.
2. Turn the mechanical key clockwise, then pull the rear seat forward and up.

Installation

1. Insert the tab into the recess.
2. Push down on the front of the rear seat. Make sure that the seat is locked securely in position by pulling it up lightly. The seat locks automatically when closed. Take care not to lock your key in the compartment under the rear seat.

Under Cowl

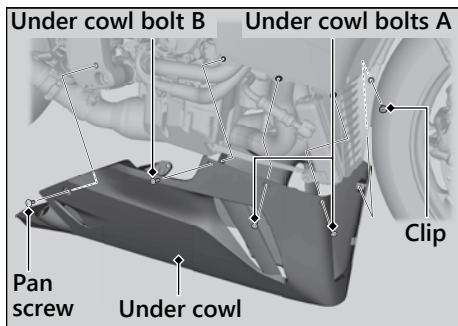
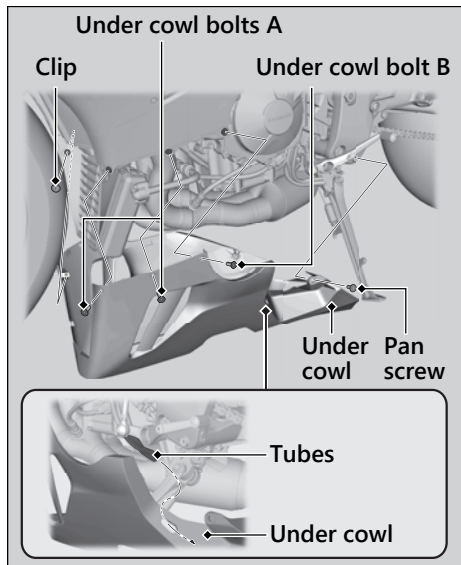

Removal

1. Remove the clips. ► P. 148
2. Remove the pan screws and under cowl bolts A and B.
3. Remove the under cowl carefully.

Installation

1. Install the under cowl using reverse of the removal procedure.
2. Route the tubes through the opening of the under cowl.
3. Install and tighten the under cowl bolts A and B securely.

Torque: 0.7 lbf·ft (1.0 N·m, 0.1 kgf·m)

4. Install and tighten the pan screws securely.

Torque: 7 lbf·ft (10 N·m, 1.0 kgf·m)

5. Install the clips.

Checking the Engine Oil

1. If the engine is cold, idle the engine for 3 to 5 minutes.
2. Turn off the electrical system to stop the engine, and wait for 2 to 3 minutes.
3. Place your vehicle in an upright position on a firm, level surface.
4. Remove the dipstick and wipe it clean.
5. Insert the dipstick until it seats, but don't screw it in.
6. Check that the oil level is between the upper level and lower level marks on the dipstick.
7. Securely install the dipstick.

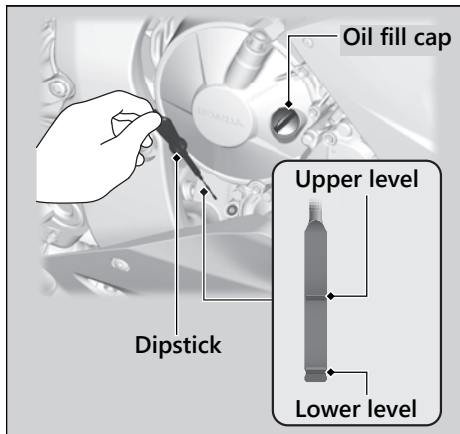

Adding Engine Oil

If the engine oil is below or near the lower level mark, add the recommended engine oil.

► P. 138, ► P. 234

1. Remove the oil fill cap. Add the recommended oil until it reaches the upper level mark.
 - Place your vehicle in an upright position on a firm, level surface when checking the oil level.
 - Do not overfill above the upper level mark.
 - Make sure no foreign objects enter the oil filler opening.
 - Wipe up any spills immediately.

2. Securely reinstall the oil fill cap.

NOTICE

Overfilling with oil or operating with insufficient oil can cause damage to your engine. Do not mix different brands and grades of oil. They may affect lubrication and clutch operation.

For the recommended oil and oil selection guidelines, see “Maintenance Fundamentals.”

► P. 138

Checking the Coolant

Check the coolant level in the reserve tank while the engine is cold.

1. Place your vehicle on a firm, level surface.
2. Hold your vehicle in an upright position.
3. Check that the coolant level is between the UPPER level and LOWER level marks on the reserve tank.

If the coolant level is dropping noticeably or the reserve tank is empty, you likely have a serious leak. Have your vehicle inspected by your dealer.

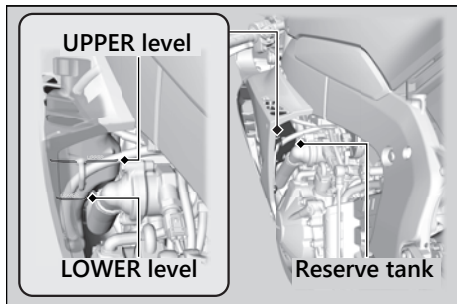

Adding Coolant

If the coolant level is below the LOWER level mark, add the recommended coolant (► P. 141) until the level reaches the UPPER level mark.

Add fluid only from the reserve tank cap and do not remove the radiator cap.

1. Remove the middle cowl bolts.
2. Pull the middle cowl outward carefully and hook the rib on the stopper of the upper inner panel.

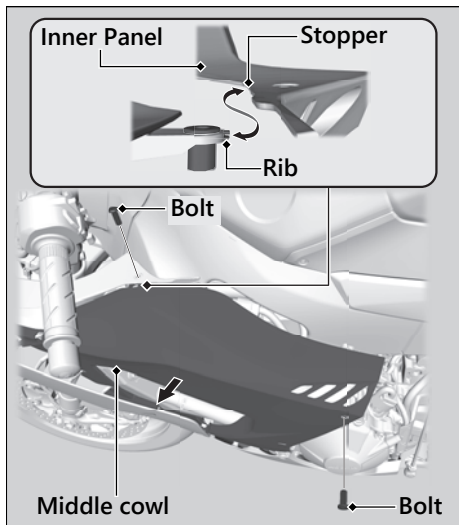

3. Remove the reserve tank cap and add fluid while monitoring the coolant level.
 - Do not overfill above the UPPER level mark.
 - Make sure no foreign objects enter the reserve tank opening.
4. Securely reinstall the reserve tank cap.
5. Install the parts in the reverse order of removal.
 - Tighten the middle cowl bolts.

Torque: 0.7 lbf·ft (1.0 N·m, 0.1 kgf·m)

Reserve tank cap

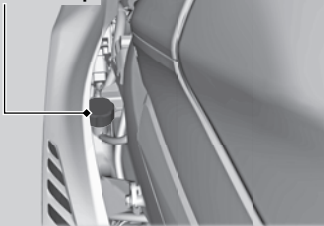

⚠ WARNING

Removing the radiator cap while the engine is hot can cause the coolant to spray out, potentially scalding you.

Always let the engine and radiator cool down before removing the radiator cap.

Checking Brake Fluid

1. Place your vehicle in an upright position on a firm, level surface.

2. **Except CBR1000SP Front**

Check that the brake fluid reservoir is horizontal and that the fluid level is between the LOWER level and UPPER level marks.

CBR1000SP Front

Check that the brake fluid reservoir is

horizontal and that the fluid level is between the MIN and MAX marks.

If the brake fluid level in either reservoir is below the LOWER level mark or MIN mark or the brake lever and pedal freeplay becomes excessive, inspect the brake pads for wear. If the brake pads are not worn, you most likely have a leak. Have your vehicle inspected by your dealer.

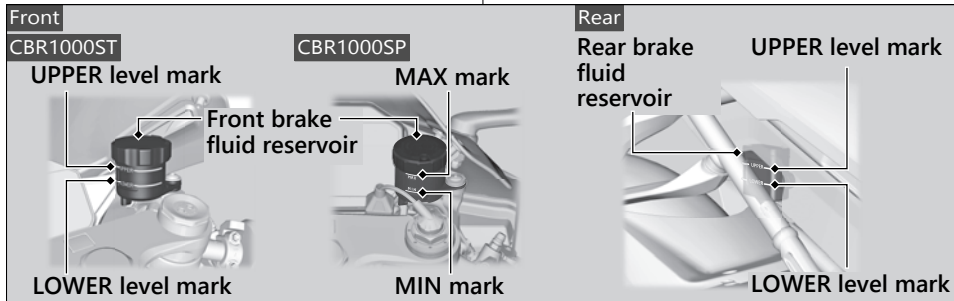

Inspecting the Brake Pads

Check the condition of the brake pad wear indicators.

The pads need to be replaced if a brake pad is worn to the bottom of the indicator.

1. **Front** Inspect the brake pads from in front of the brake caliper.
 - Always inspect both left and right brake calipers.
2. **Rear** Inspect the brake pads from the underside of the rear of the vehicle.
 - If necessary have the pads replaced by your dealer.
 - Always replace both left and right brake pads at the same time.

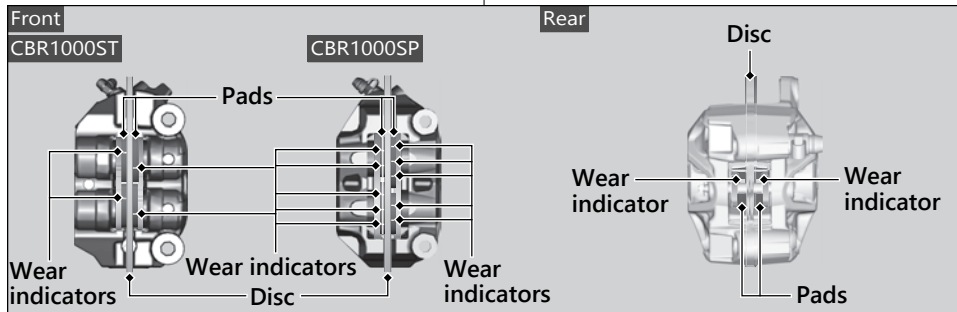

Adjusting the Brake Light Switch

Check the operation of the brake light switch. Hold the brake light switch and turn the adjusting nut in the direction A if the switch operates too late, or turn the nut in the direction B if the switch operates too soon.

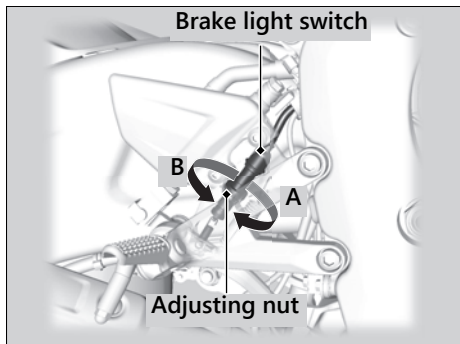

Checking the Side Stand

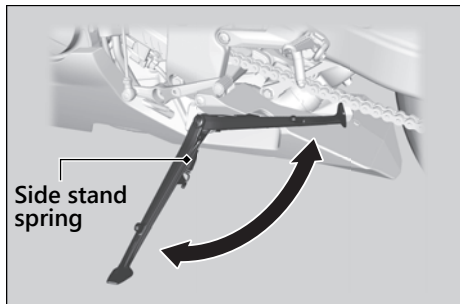

1. Check that the side stand operates smoothly. If the side stand is stiff or squeaky, clean the pivot area and lubricate the pivot bolt with clean grease.
2. Check the spring for damage or loss of tension.
3. Sit on the vehicle, shift the transmission to Neutral, and raise the side stand.
4. Start the engine, pull the clutch lever in, and shift the transmission into gear.
5. Lower the side stand all the way. The engine should stop as you lower the side stand. If the engine doesn't stop, have your vehicle inspected by your dealer.

Inspecting the Drive Chain Slack

Check the drive chain slack at several points along the chain. If the slack is not constant at all points, some links may be kinked and binding.

Have the chain inspected by your dealer.

1. Shift the transmission to Neutral. Stop the engine.
2. Place your vehicle on its side stand on a firm, level surface.
3. Check the slack in the lower half of the drive chain midway between the sprockets.

Drive chain slack:

1.0 - 1.4 in (25 - 35 mm)

- ▶ Do not ride your vehicle if the slack exceeds 2.0 in (50 mm).

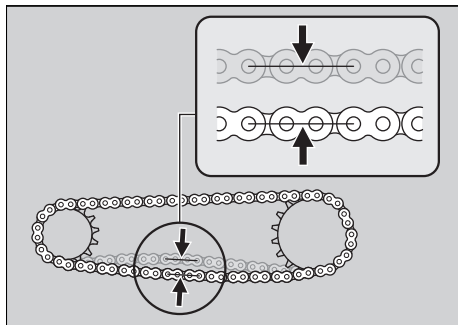

4. Roll the vehicle forward and check that the chain moves smoothly.
5. Inspect the sprockets. ➤ P. 140
6. Clean and lubricate the drive chain. ➤ P. 140

Checking the Clutch

Checking the Clutch Lever Freeplay

Check the clutch lever freeplay.

Freeplay at the clutch lever:

0.4 - 0.8 in (10 - 20 mm)

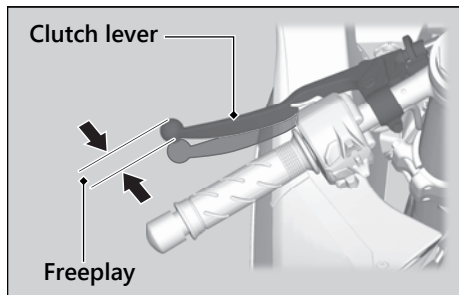

Check the clutch cable for kinks or signs of wear. If necessary have it replaced by your dealer.

Lubricate the clutch cable with a commercially available cable lubricant to prevent premature wear and corrosion.

NOTICE

Improper freeplay adjustment can cause premature clutch wear.

Adjusting the Clutch Lever Freeplay

Upper Adjustment

Attempt adjustment with the upper clutch cable adjuster first.

Turn the clutch cable adjuster until the freeplay is 0.4 - 0.8 in (10 - 20 mm).

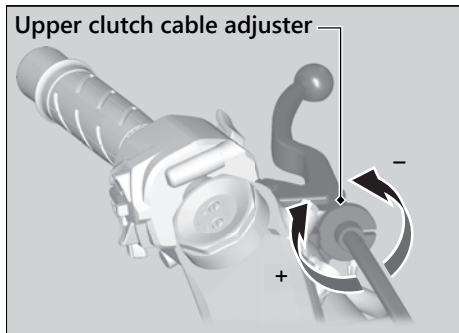

Lower Adjustment

If the upper clutch cable adjuster is threaded out near its limit, or the correct freeplay cannot be obtained, attempt adjustment with the lower clutch cable adjusting nut.

1. Turn the upper clutch cable adjuster all the way in (to provide maximum freeplay).
2. Loosen the lower lock nut.
3. Turn the adjusting nut until the clutch lever freeplay is 0.4 - 0.8 in (10 - 20 mm).
4. Tighten the lower lock nut and check the clutch lever freeplay.
5. Start the engine, pull the clutch lever in, and shift into gear. Make sure the engine does not stall and the vehicle does not creep. Gradually release the clutch lever and open the throttle. Your vehicle should move smoothly and accelerate gradually.

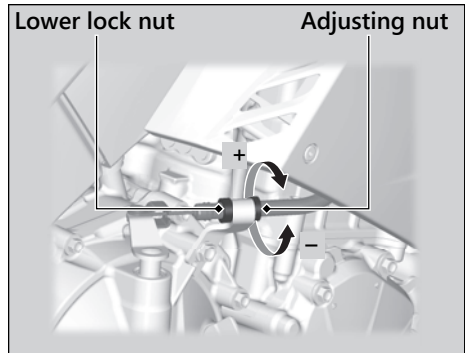

If proper adjustment cannot be obtained or the clutch does not work correctly, see your dealer.

Checking the Throttle

With the engine off, check that the throttle rotates smoothly from fully closed to fully open. If the throttle does not move smoothly, close automatically, have the vehicle inspected by your dealer.

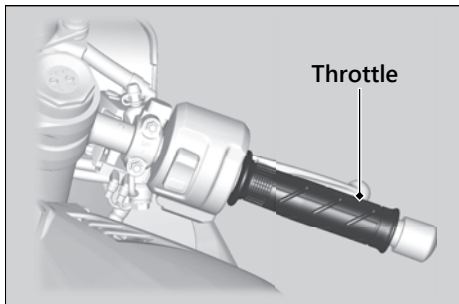

Adjusting the Brake Lever

You can adjust the distance between the tip of the brake lever and handle grip.

Adjustment method

CBR1000ST

Turn the adjuster until the numbers align with the index mark while pushing the lever forward in the desired position.

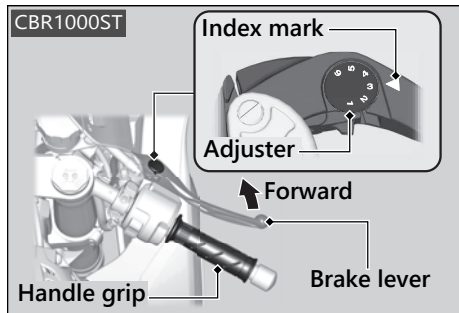

CBR1000SP

Turn the adjuster clockwise while pushing the lever forward to widen the distance. Turn the adjuster counterclockwise while pushing the lever forward to narrow the distance.

▶ Make sure the cut-out is seated on the lug.

CBR1000SP

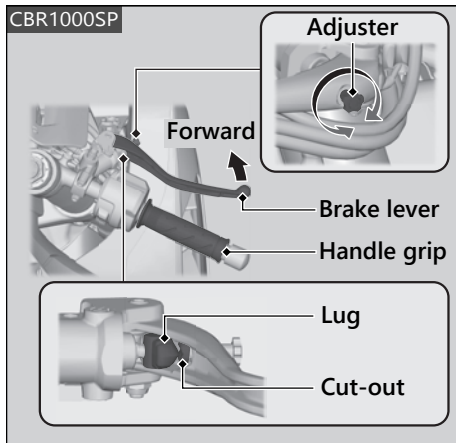

Other Adjustments ► Adjusting the Brake Lever

After adjustment, check that the lever operates correctly before riding.

NOTICE

Do not turn the adjuster beyond its natural limit.

Adjusting the Front Suspension

Spring Preload

CBR1000ST

You can adjust the spring preload by the adjuster to suit the load or the road surface. The spring preload adjuster has 15 turns. Turn clockwise to increase spring preload (hard), or turn counterclockwise to decrease spring preload (soft). The standard position is the 7 1/2 turns from the full soft position.

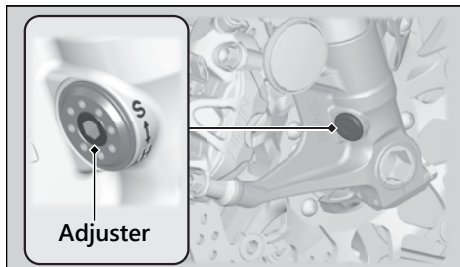

NOTICE

Do not turn the adjuster beyond its limits. Adjust both left and right forks to the same spring preload.

Rebound Damping

CBR1000ST

You can adjust the rebound damping by the TEN adjuster to suit the load or the road surface.

Turn the adjuster using a suitable tool. The TEN adjuster has 5 1/2 turns.

Turn clockwise to increase rebound damping (hard), or turn counterclockwise to decrease rebound damping (soft). The standard position is 4 turns from the full hard position.

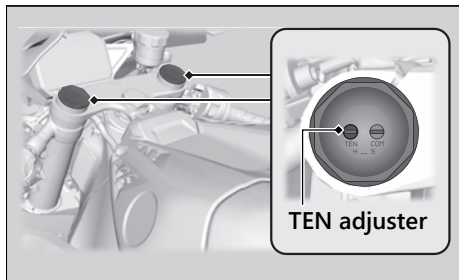

NOTICE

Do not turn the adjuster beyond its limits. Adjust both left and right forks to the same rebound damping.

Compression Damping

CBR1000ST

You can adjust the compression damping by the COM adjuster to suit the load or the road surface.

Turn the adjuster using a suitable tool.

The COM adjuster has 7 turns.

Turn clockwise to increase compression damping (hard), or turn counterclockwise to decrease compression damping (soft). The standard position is 5 turns from the full hard position.

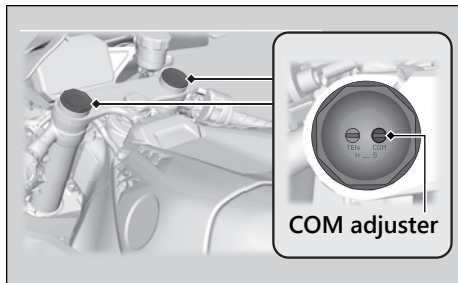

NOTICE

Do not turn the adjuster beyond its limits.
Adjust both left and right forks to the same compression damping.

Adjusting the Rear Suspension

Spring Preload

CBR1000ST

You can adjust the spring preload by the adjuster to suit the load or the road surface. Turn the adjuster using a suitable tool. The preload adjuster has 10 positions. Positions 1 to 3 are for a decrease spring preload (soft), or turn the position 5 to 10 increase spring preload (hard). The standard position is 4.

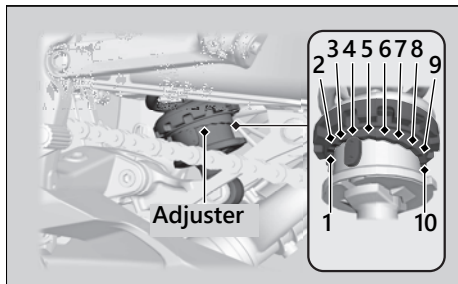

NOTICE

Do not turn the adjuster beyond its limits. Attempting to adjust directly from 1 to 10 or 10 to 1 may damage the shock absorber.

NOTICE

The rear shock absorber damper unit contains high pressure nitrogen gas. Do not attempt to disassemble, service, or improperly dispose of the damper. See your dealer.

Rebound Damping

CBR1000ST

You can adjust the rebound damping by the TEN adjuster to suit the load or the road surface.

Turn the adjuster using a suitable tool.

The TEN adjuster has 4 turns.

Turn clockwise to increase rebound damping (hard), or turn counterclockwise to decrease rebound damping (soft).

The standard position is 2 turns from the full hard position.

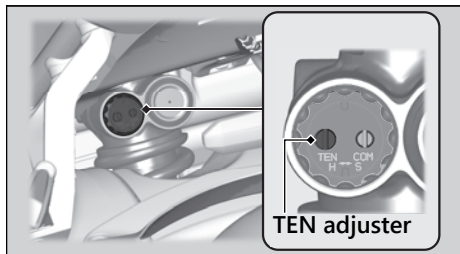

NOTICE

Do not turn the adjuster beyond its limits.

NOTICE

The rear shock absorber damper unit contains high pressure nitrogen gas. Do not attempt to disassemble, service, or improperly dispose of the damper. See your dealer.

Compression Damping

CBR1000ST

You can adjust the compression damping by the COM adjuster to suit the load or the road surface.

Turn the adjuster using a suitable tool.

The COM adjuster has 4 1/2 turns.

Turn clockwise to increase compression damping (hard), or turn counterclockwise to decrease compression damping (soft).

The standard position is 2 1/4 turns from the full hard position.

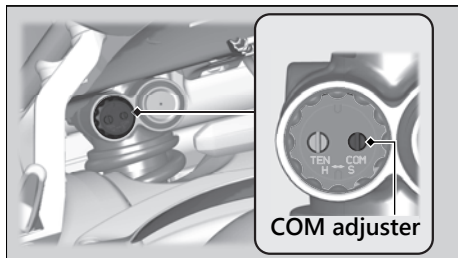

NOTICE

Do not turn the adjuster beyond its limits.

NOTICE

The rear shock absorber damper unit contains high pressure nitrogen gas. Do not attempt to disassemble, service, or improperly dispose of the damper. See your dealer.

Adjusting the ÖHLINS Smart EC System

CBR1000SP

This model is equipped with the ÖHLINS Smart EC system.

This system consists of front and rear suspension and Suspension Control Unit (SCU).

This system provides the pre-programmed damping characteristics optimized for different situation to the front and rear suspension.

SCU constantly determines riding conditions from vehicle information. As a result, this system provides the optimum rebound and compression damping characteristics.

The system continually adjusts compression and rebound damping levels according to the riding situation.

You can adjust the front and rear suspension preload manually.

ÖHLINS Smart EC is a trademark of ÖHLINS RACING AB, Sweden.

Front Spring Preload

You can adjust the spring preload by the adjuster to suit the load or the road surface.

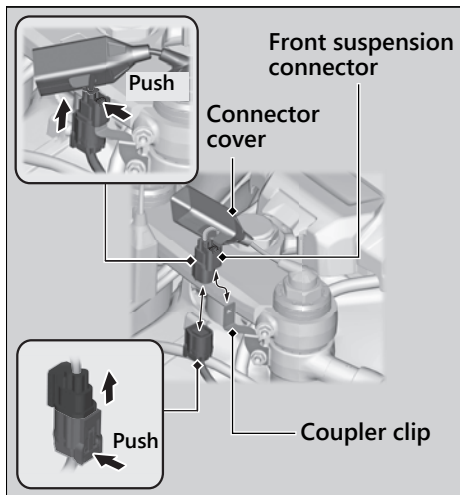

1. Make sure the electrical system is turned off.
2. Slide the connector cover, and then disconnect the front suspension connector from the coupler clip.
3. Disconnect the front suspension connector.
► Do not remove by pulling on the wire harness.

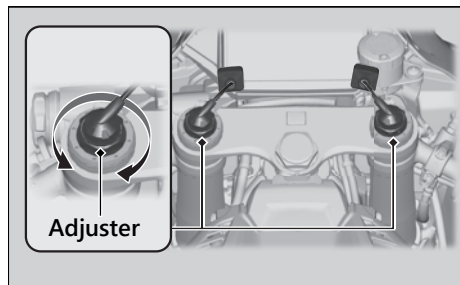

4. Turn clockwise to increase spring preload (hard), or turn counterclockwise to decrease spring preload (soft).
The standard position is the 2 turns from the full soft position.

NOTICE

Do not turn the adjuster beyond its limits. Adjust both left and right forks to the same spring preload.

5. After the adjustment, connect the front suspension connector.
 - Be careful not to allow water or dust to enter the connector.
 - Make sure to install the connector completely.

6. Connect the front suspension connector to the coupler clip and then install the connector cover.

■ Rear Spring Preload

You can adjust the spring preload by the adjuster knob to suit the load or the road surface.

Turn clockwise to increase spring preload (hard), or turn counterclockwise to decrease spring preload (soft).

The standard position is 8 turns from the full hard position.

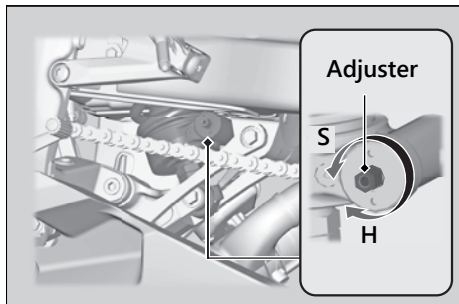

NOTICE

Do not turn the adjuster beyond its limits.

I Damping Adjustment

You can select A-mode which automatically adjusts damping according to the riding situation and MANUAL mode which allows damping to be set at a fixed level.

A-mode

A-mode will automatically adjust compression and rebound damping levels for the front and rear suspension according to the current vehicle conditions.

A-mode provides 3 situation (TRACK, SPORT and RAIN) with different riding feel and vehicle characteristics for various situations. A-mode has 3 modes (A1, A2, A3), and each mode can select the situation suitable for the riding condition.

Defaults of A-mode can be adjusted using the ÖHLINS Objective Based Tuning interface (OBTi).

“OBTi” provides the interface where the rider can adjust the settings in order to enhance the vehicle characteristics to rider's preferences.

Adjustable OBTi support items and riding situations.

Situation	OBTi support items				
	FRONT	REAR	BRAKE	ACC	CORNER
TRACK	A	A	A	A	A
SPORT	A	A	A	N/A	N/A
RAIN	A	A	A	N/A	N/A

A : Adjustable

N/A : Not adjustable

Other Adjustments ► Adjusting the ÖHLINS Smart EC System

FRONT/REAR:

By adjusting the front and rear firmness objective, it is possible to increase(+) or decrease(-) the front and rear suspension total damping level.

Direction

For TRACK

(+): More stable feeling. Good for high grip tire and high road surface temperature.

(-): Useful to increase weight transfer. Good setting for low grip condition.

Adjusting the parameters separately allows changing the front and rearing balance separately.

For SPORT/RAIN

(+): More stable feeling. Good for controlling the suspension movement moderately.

(-): More comfort feeling. Good setting for bumpy road and wet condition.

Adjusting the parameters separately allows changing the front and rearing balance separately.

BRAKE:

By adjusting the brake support objective it is possible to increase (+) or decrease (-) the pitching resistance during initial braking.

Direction

(+): Front fork compresses slowly.

(-): Front fork compresses quickly.

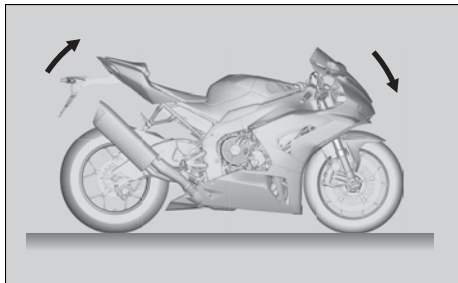

ACC (TRACK only):

By adjusting the acceleration objective it is possible to increase (+) or decrease (-) the pitching resistance during accelerating.

Direction

(+): More stable feeling especially during hard acceleration out of corner.

(-): Useful to increase weight transfer to increase rear tire load.

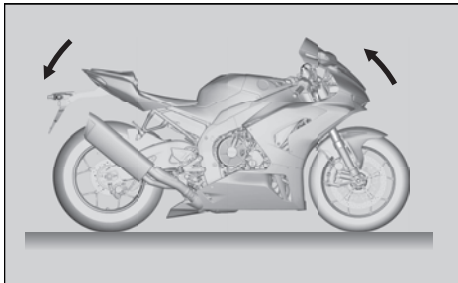

CORNER (TRACK only):

By adjusting the corner objective it is possible to increase (+) or decrease (-) the agile movements of the while turning.

Direction

(+): More agility especially in middle of corner.

(-): Good setting for rain or low grip condition.

To adjust the "FRONT", "REAR", "BRAKE", "ACC" and "CORNER". 📖 P. 60

📖 P. 65

To select the S mode. 📖 P. 105

MANUAL mode

The suspension setting can be fixed at a certain value on compression and rebound damping of the front and rear suspensions.

There is no automatic adjustment function for the front and rear suspension damping.

MANUAL mode provides 3 modes (M1, M2 and M3).

Preset of M1 is suitable for track riding.

Preset of M2 is suitable for winding roads.

Preset of M3 is suitable for street riding.

In MANUAL mode, the following damping levels can be adjusted as desired:

FR COM: Compression damping for front suspension

FR REB: Rebound damping for front suspension

RR COM: Compression damping for rear suspension

RR REB: Rebound damping for rear suspension

To adjust the “FR COM”, “FR REB”, “RR COM” and “RR REB”. ► P. 60 ► P. 66

To select the S mode. ► P. 105

Replacing the Honda SMART Key Battery

If the Honda SMART Key indicator flashes 5 times when the electrical system is turned on, or the operating range becomes unstable, replace the battery as soon as possible. We recommend to see your dealer for this service.

Battery type: CR2032

1. With the emblem upward, separate the Honda SMART Key by inserting a coin or a flat head screwdriver covered with a protective cloth into the slit.
 - ▶ Wrap a coin or a screwdriver with a protective cloth to prevent scratching the Honda SMART Key.
 - ▶ Do not touch the circuit or terminal. This may cause problems.
 - ▶ Be careful to avoid scratching the waterproof covering or allowing dust to enter.
 - ▶ Do not forcibly dismantle the Honda SMART Key body.

2. Replace the old battery with a new one with the positive (+) side facing up.
3. Assemble the parts in the reverse order of disassembly.

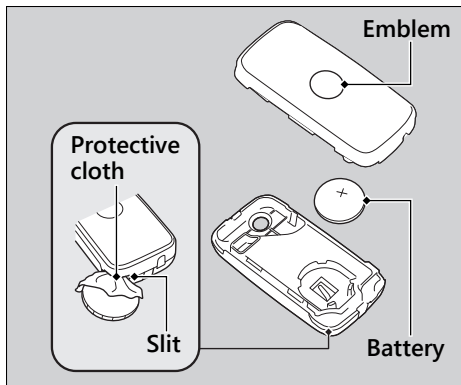

⚠ WARNING

Chemical Burn Hazard: do not swallow battery.

If swallowed, the battery can cause severe internal burns and even death.

- Keep battery away from children and battery compartment securely closed.
- If the battery compartment does not close securely, stop using the product and keep it away from children.
- Immediately seek medical attention if a child may have swallowed battery.

Troubleshooting

Engine Will Not Start	P. 186
Overheating (High coolant temperature indicator is on)	P. 187
Warning Indicators On or Flashing	P. 188
Low Oil Pressure Indicator	P. 188
PGM-FI (Programmed Fuel Injection)	
Malfunction Indicator Lamp (MIL).....	P. 188
ABS (Anti-lock Brake System) Indicator	P. 189
HESD (Honda Electronic Steering Damper) Indicator	P. 189
Torque Control Indicator.....	P. 190
Honda SMART Key Indicator.....	P. 191
When the Honda SMART Key System Does Not Operate Properly	P. 192

Activating the Electrical System in an Emergency	P. 194
Tire Puncture	P. 199
Electrical Trouble	P. 200
Battery Goes Dead.....	P. 200
Burned-out Light Bulb	P. 201
Blown Fuse.....	P. 202

Starter Motor Operates But Engine Does Not Start

Check the following items:

- Check the correct engine starting sequence. ➤ P. 111
- Check that there is gasoline in the fuel tank.
- Check if the PGM-FI malfunction indicator lamp (MIL) is on.
 - ▶ If the indicator lamp is on, contact your dealer as soon as possible.

Starter Motor Does Not Operate

Check the following items:

- Check the correct engine starting sequence. ➤ P. 111
- Check for a blown fuse. ➤ P. 202
- Check for a loose battery connection (➤ P. 146) or battery terminal corrosion (➤ P. 133).
- Check the condition of the battery.
 - P. 200

If the problem continues, have your vehicle inspected by your dealer.

Overheating (High coolant temperature indicator is on)

The engine is overheating when the following occurs:

- High coolant temperature indicator comes on.
- Acceleration becomes sluggish.
If this occurs, pull safely to the side of the road and perform the following procedure.

Extended fast idling may cause the high coolant temperature indicator to come on.

NOTICE

Continuing to ride with an overheated engine can cause serious damage to the engine.

1. Stop the engine using the ignition switch, and then push the ignition ON switch to turn on the electrical system.

2. Check that the radiator fan is operating, and then turn the electrical system off.

If the fan is not operating:

Suspect a fault. Do not start the engine. Transport your vehicle to your dealer.

If the fan is operating:

Allow the engine to cool with the electrical system turned off.

3. After the engine has cooled, inspect the radiator hose and check if there is a leak.

➔ P. 155

If there is a leak:

Do not start the engine. Transport your vehicle to your dealer.

4. Check the coolant level in the reserve tank. ➔ P. 155
▶ Add coolant as necessary.
5. If 1-4 check normal, you may continue riding, but closely monitor the high coolant temperature indicator.

Low Oil Pressure Indicator

If the low oil pressure indicator comes on, pull safely to the side of the road and stop the engine.

NOTICE

Continuing to ride with low oil pressure can cause serious damage to the engine.

1. Check the engine oil level, and add oil as necessary. 📄 P. 153, 📄 P. 154
2. Start the engine.
 - ▶ Only continue riding if the low oil pressure indicator goes off.

Rapid acceleration may momentarily cause the low oil pressure indicator to come on, especially if the oil is at or near the low level. If the low oil pressure indicator stays on when the oil level is at the proper level, stop the engine and contact your dealer.

If the engine oil level goes down rapidly, your vehicle may have a leak or another serious problem. Have your vehicle inspected by your dealer.

PGM-FI (Programmed Fuel Injection) Malfunction Indicator Lamp (MIL)

If the indicator comes on while riding, you may have a serious problem with the PGM-FI system. Reduce speed and have your vehicle inspected by your dealer as soon as possible.

ABS (Anti-lock Brake System) Indicator

If the indicator operates in one of the following ways, you may have a serious problem with the ABS. Reduce your speed and have your vehicle inspected by your dealer as soon as possible.

- Indicator comes on or starts flashing while riding.
- Indicator does not come on when the electrical system is turned on.
- Indicator does not go off at speeds above 6 mph (10 km/h).

If the ABS indicator stays on, your brakes will continue to work as a conventional system, but without the anti-locking function.

The ABS indicator may flash if you turn the rear wheel while the rear wheel is lifted off the ground. In this case, turn the electrical system off and on again. The ABS indicator will go off after your speed reaches 19 mph (30 km/h).

HESD (Honda Electronic Steering Damper) Indicator

If the indicator comes on while riding, you may have a serious problem with the HESD. Reduce speed and have your vehicle inspected by your dealer as soon as possible.

Torque Control Indicator

If the indicator operates in one of the following ways, you may have a serious problem with the Torque Control. Reduce your speed and have your vehicle inspected by your dealer as soon as possible.

- Indicator comes and stays on (solid) while riding.
- Indicator does not come on when the electrical system is turned on.
- Indicator does not go off at speeds above 3 mph (5 km/h).

Even when the Torque Control indicator is on, your vehicle will have normal riding ability without Torque Control function.

- When the indicator comes on while the Torque Control is in operation, you will have to completely close the throttle to regain normal riding ability.

The Torque Control indicator may come on if you rotate the rear wheel while your vehicle is lifted off the ground. In this case, turn the electrical system off and on again. The Torque Control indicator will go off after your speed reaches 3 mph (5 km/h).

Honda SMART Key Indicator

When the Honda SMART Key indicator flashes 5 times

Replacing the Honda SMART Key Battery 📖 P. 183

When the Honda SMART Key indicator is flashing while the electrical system is on

The Honda SMART Key indicator flashes when communication between your vehicle and Honda SMART Key stops after turning on the electrical system.

It is probably caused by the following:

- Strong radio waves or noise are affecting the system
- You lose the Honda SMART Key while riding

However, this does not affect the operation of your vehicle until the electrical system is off.

You may not be able to turn off the electrical system when losing the Honda SMART Key while riding, or if the battery is low, or because the system is affected by strong radio waves or noise. If this occurs, turn the ignition switch knob OFF/🔒 (Lock) counterclockwise and hold it until the electrical system shut off.

You can also turn off the electrical system by turning the ignition switch knob OFF/🔒 (Lock) counterclockwise 3 times within 3 seconds.

If the electrical system cannot be turned on because the Honda SMART Key battery becomes weak (or dead), it can be activated by means of emergency procedures. 📖 P. 194

When the Honda SMART Key System Does Not Operate Properly

When the Honda SMART Key system does not work properly, perform the following.

- Check that the Honda SMART Key system is activated.

Lightly push the ON/OFF button on the Honda SMART Key.

If the Honda SMART Key LED is red, activate the Honda SMART Key system.

➤ P. 101

If the Honda SMART Key LED does not respond, replace the battery.

- Check that there is no communication failure in the Honda SMART Key system. The Honda SMART Key system uses low-intensity radio waves. The Honda SMART Key system may not work properly in the following conditions:
 - ▶ When there are facilities nearby that generate strong radio waves or noise such as TV towers, power stations, radio stations, or airports.
 - ▶ When you carry the Honda SMART Key with a laptop or wireless communication device such as a radio or mobile phone.
 - ▶ When the Honda SMART Key comes into contact with or is covered by metal objects.

When the Honda SMART Key System Does Not Operate Properly

- Check that a registered Honda SMART Key is used.
Use a registered Honda SMART Key. The Honda SMART Key system cannot be activated without a registered Honda SMART Key.
- Make sure that you do not use a broken Honda SMART Key.
If you use a broken Honda SMART Key, the Honda SMART Key system cannot be activated. Bring the ID tag to your dealer.

- Check the battery condition and battery lead in your vehicle.
Check the battery and battery terminals. If the battery is weak, contact your dealer.

If the Honda SMART Key system cannot be activated due to other causes, contact your dealer.

Activating the Electrical System in an Emergency

The mechanical key and ID tag can be used to activate the electrical system when the electric system cannot be turned on because the Honda SMART Key battery becomes weak or dead.

Set up to ID number input mode

1. Remove the front seat using a 5 mm Hex wrench provided in the tool kit.
 - ▶ To access the tool kit, remove the rear seat. ➤ P. 150
2. Remove the fuse box cover. ➤ P. 202
3. Pull out the SMART ECU fuse with the fuse puller and wait about 2 minutes before insert the SMART ECU fuse again.
4. Push and hold the ignition ON switch for more than 4 seconds.
 - ▶ The steering lock indicator comes on and the system enters the ID number input mode.

5. Check the ID number on the ID tag.

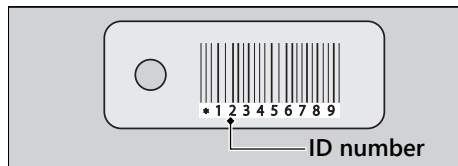
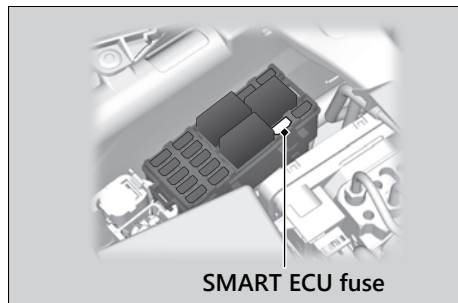

■ ID number input

You can input your ID number by pushing the ignition ON switch and Turn the ignition switch knob OFF/🔒 (Lock) counterclockwise. Input the ID number on the ID tag in order from the left in turn by pushing the ignition ON switch.

The ID number is input according to the number of times the ignition ON switch is pushed.

Push the ignition ON switch the desired number of times, then turn the ignition switch knob OFF/🔒 (Lock) counterclockwise to fix the current digit (the steering lock indicator goes off briefly and comes on again), and input the next digit, and then repeat until all the digits are input.

While inputting the ID number, if the button is not pressed for about 60 seconds, the inputted ID number is cancelled and the system returns to the state before removing the SMART ECU fuse (the steering lock indicator goes off).

Example:

- To input "0", turn the ignition switch knob OFF/**i** (Lock) counterclockwise without pushing the ignition ON switch, and then input next digit.

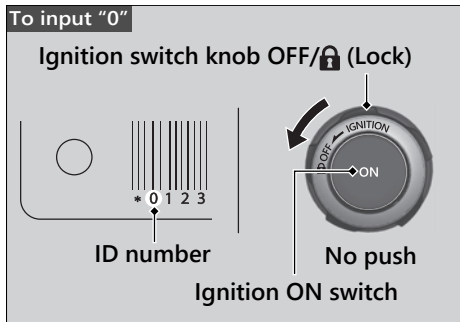

- To input "1", push the ignition ON switch once, and then turn the ignition switch knob OFF/**i** (Lock) counterclockwise to input the next digit.

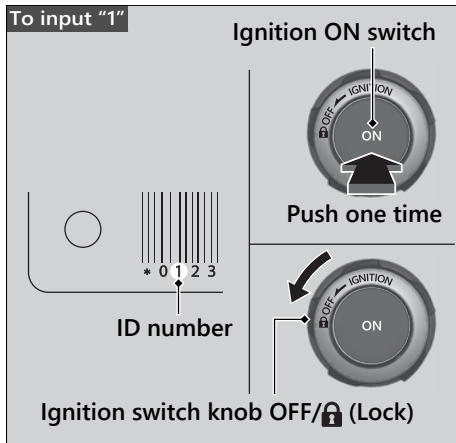

ID number input success

After the last digit of the ID number is inputted, ID number is authenticated, the steering lock indicator will flash every 2 seconds.

Push the ignition ON switch within 30 seconds after the ID number is authenticated.

If the steering is locked

The steering will be unlocked. To activate the electrical system, push the ignition ON switch once again within 30 seconds after the ID number is authenticated.

If the steering is unlocked

The electrical system will be activated. You can start the engine.

You can turn off the engine and electrical system and also lock the steering using the ignition switch. The ignition switch operation is disabled 30 seconds after the electrical system is turned off.

To activate the electrical system again, repeat the procedures for activating the electrical system in an emergency.

Activating the Electrical System in an Emergency

ID number input failure

If the ID number is not authenticated after inputting, the steering lock indicator goes off. The steering cannot be unlocked and the electrical system will not activate.

Repeat the procedures for activating the electrical system in an emergency.

ID number input cancel

If you input the wrong number, you can cancel ID number input by not operating the switch for about 60 seconds (the steering lock indicator goes off).

Repeat the procedures for activating the electrical system in an emergency.

Tire Puncture

Repairing a puncture or removing a wheel requires special tools and technical expertise. We recommend you have this type of service performed by your dealer.

After an emergency repair, always have the tire inspected/replaced by your dealer.

Emergency Repair Using a Tire Repair Kit

If your tire has a minor puncture, you can make an emergency repair using a tubeless tire repair kit.

Follow the instructions provided with the emergency tire repair kit.

Riding your vehicle with a temporary tire repair is very risky. Do not exceed 30 mph (50 km/h). Have the tire replaced by your dealer as soon as possible.

WARNING

Riding your vehicle with a temporary tire repair can be risky. If the temporary repair fails, you can crash and be seriously injured or killed.

If you must ride with a temporary tire repair, ride slowly and carefully and do not exceed 30 mph (50 km/h) until the tire is replaced.

Battery Goes Dead

CBR1000ST

Charge the battery using a motorcycle battery charger.

Remove the battery from the vehicle before charging.

Do not use an automobile-type battery charger, as these can overheat a motorcycle battery and cause permanent damage. If the battery does not recover after recharging, contact your dealer.

NOTICE

Jump starting using an automobile battery can damage your vehicle's electrical system and is not recommended.

Bump starting is also not recommended.

CBR1000SP

Battery charging is needed.

A battery charger recommended by your lithium-ion (li-ion) battery manufacturer is needed for battery charging.

Contact your dealer before charging the battery.

Remove the battery from the vehicle before charging.

NOTICE

Only use a charger recommended by your lithium-ion (li-ion) battery manufacturer. Using a battery charger that is not recommended can cause permanent damage to your battery.

If the battery does not recover after recharging, contact your dealer.

NOTICE

Do not jump-start, as this can damage your vehicle's electrical system and battery. Bump starting is not recommended.

Burned-out Light Bulb

All light bulbs on the vehicle are LEDs. If there is an LED which is not turned on, see your dealer for servicing.

Blown Fuse

Before handling fuses, see “Inspecting and Replacing Fuses.” ► P. 138

Fuse Box Fuses

1. Remove the front seat. ► P. 149
2. Remove the fuse box cover.
3. Pull the main fuse and other fuses out one by one with the fuse puller furnished in reverse side of the fuse box cover and check for a blown fuse. Always replace a blown fuse with a spare fuse of the same rating.
 - Spare fuses are provided on back side of the fuse box cover.
4. Reinstall the fuse box cover.
5. Reinstall the front seat.

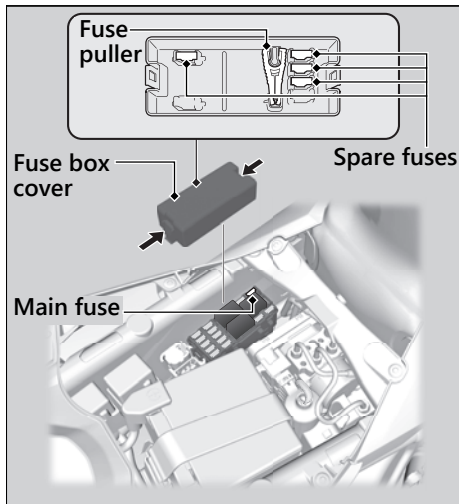

NOTICE

If a fuse fails repeatedly, you likely have an electrical problem. Have your vehicle inspected by your dealer.

Information

Service Diagnostic Recorders	P. 204	Reporting Safety Defects	P. 231
Keys.....	P. 205		
Instruments, Controls, & Other Features...	P. 208		
Caring for Your Vehicle.....	P. 211		
Storing Your Vehicle.....	P. 215		
Transporting Your Vehicle	P. 216		
You & the Environment	P. 216		
Vehicle Identification Number.....	P. 218		
Emission Control Systems	P. 219		
Catalytic Converter	P. 223		
Oxygenated Fuels.....	P. 224		
Authorized Manuals	P. 225		
Warranty Coverage and Service	P. 226		
Honda Contacts	P. 229		

Service Diagnostic Recorders

Your vehicle is equipped with service-related devices that record information about powertrain performance and riding conditions. The data can be used to help technicians diagnose, repair and maintain the vehicle. This data may not be accessed by anyone else except as legally required or with the permission of the vehicle owner.

However this data may be accessed by Honda, its authorised dealers and authorised repairers, employees, representatives and contractors only for the purpose of the technical diagnosis, research and development of the vehicle.

Keys

Honda SMART Key

The Honda SMART Key is equipped with a mechanical key.

Carrying the Honda SMART Key allows you to perform the following operations:

- Locking or unlocking the steering and activating or deactivating the electrical system
- Opening the fuel fill cap and rear seat

The ID number of the Honda SMART Key is on the ID tag. You can also unlock the steering (if it is locked) and activating the electrical system by inputting the ID number.

Always carry the ID tag, but separate from the Honda SMART Key, to avoid losing all of them at the same time.

Also store the key tag and a copy of your ID number in a safe place other than your vehicle.

The Honda SMART Key contains electronic circuits. If the circuits are damaged, the Honda SMART Key will not allow you to perform any operations.

- Do not drop the Honda SMART Key or set heavy objects on them.
- Protect the Honda SMART Key from direct sunlight, high temperature, and high humidity.
- Do not scratch or puncture.
- Do not store near any magnetized products such as a magnetized key chain.
- Always keep the Honda SMART Key away from electric appliances such as a TV, radio, PC or low-frequency massage device.
- Keep the Honda SMART Key away from liquids. If it gets wet, dry it immediately with a soft cloth.
- Keep the Honda SMART Key away from the vehicle while washing the vehicle.
- Do not burn.
- Do not wash in an ultrasonic cleaner.

Keys

- If fuel, wax, or grease adhere to the Honda SMART Key, wipe it off immediately to avoid cracking or warping.
- Do not disassemble the Honda SMART Key other than when changing a battery. Only the cover of the Honda SMART Key can be disassembled. Do not disassemble other parts.
- Do not lose your Honda SMART Key. If you lose it, you will need to register a new Honda SMART Key. See your dealer with your ID tag for registration.

The battery in the Honda SMART Key system normally lasts about 2 years.

Do not keep mobile phones or other radio transmitting devices in any compartment. The radio frequency from the devices will interrupt the Honda SMART Key system.

To get an additional Honda SMART Key, take the Honda SMART Key and the vehicle to your dealer.

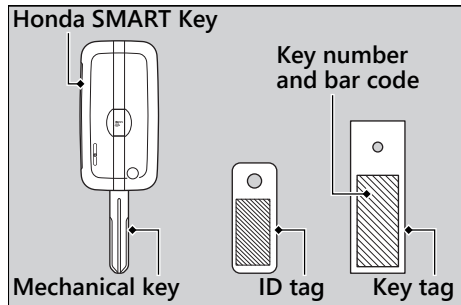

USA

Each radio frequency device installed in the vehicle conforms to the requirements and standards of the regulation listed below:

This device complies with Part 15 of the FCC Rules. Operation is subject to the following two conditions: (1) this device may not cause harmful interference, and (2) this device must accept any interference received, including interference that may cause undesired operation.

Changes or modifications not expressly approved by the party responsible for compliance could void the user's authority to operate the equipment.

Canada

This device complies with Industry Canada's licence-exempt RSSs. Operation is subject to the following two conditions: (1) This device may not cause interference; and (2) This device must accept any interference, including interference that may cause undesired operation of the device.

Le présent appareil est conforme aux CNR d'Industrie Canada applicables aux appareils radio exempts de licence. L'exploitation est autorisée aux deux conditions suivantes: 1) l'appareil ne doit pas produire de brouillage; 2) l'utilisateur de l'appareil doit accepter tout brouillage radioélectrique subi, même si le brouillage est susceptible d'en compromettre le fonctionnement.

Instruments, Controls, & Other Features

Ignition Switch

Leaving the electrical system on with the engine stopped will drain the battery.

Do not operate the ignition switch while riding.

Engine Stop Switch

Do not use the engine stop switch except in an emergency. Doing so when riding will cause the engine to suddenly turn off, making riding unsafe.

If you stop the engine using the engine stop switch, turn the ignition switch knob OFF/ (Lock) counterclockwise to turn off the electrical system. Failing to do so will drain the battery.

Odometer

The display locks at 999,999 when the read-out exceeds 999,999.

Tripmeter

The tripmeters return to 0.0 when each read-out exceeds 9,999.9.

Owner's manual

The owner's manual, registration, and insurance information can be stored in the tool bag under the rear seat. ➤ P. 120

Ignition Cut-off System

IMU (Inertial Measurement Unit) sensor automatically stops the engine and fuel pump if the vehicle falls over. To reset the IMU, you must turn the electrical system off and back to on before the engine can be restarted.

If a failure of the IMU is detected, the engine and fuel pump will not stop automatically when the vehicle falls over.

HESD

The Honda Electronic Steering Damper (HESD) automatically controls the steering damper characteristics in accordance with vehicle speed and acceleration.

HESD Indicator Comes On ➤ P. 189

Assist-slipper Clutch System

The assist-slipper clutch system helps to prevent the rear tire from locking up when the deceleration of your vehicle produces a strong engine braking effect. It also makes the clutch lever operation feel lighter.

Use only MA classification engine oil for your vehicle. Using engine oil other than MA classification oil could result in damage to the assist-slipper clutch system.

Throttle by Wire System

This model is equipped with a Throttle by Wire System.

Do not put magnetized items or items susceptible to magnetic interference near the right handlebar switches.

Automatic Brightness Control

The backlight brightness of the meter will be controlled automatically when "AUTO" is selected on the brightness setting.

Ambient brightness is detected by the photosensor.

Do not damage or cover the photosensor.

Otherwise, the automatic brightness control may not work properly.

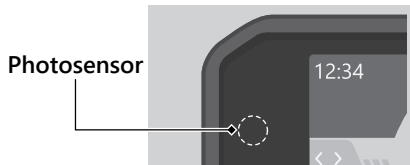

Caring for Your Vehicle

Frequent cleaning and polishing is important to ensure the life of your Honda. A clean vehicle makes it easier to spot potential problems. In particular, seawater and salts used to prevent ice on roads promote the formation of corrosion. Always wash your vehicle thoroughly after riding on coastal or treated roads.

Washing

Allow the engine, muffler, brakes, and other high-temperature parts to cool before washing.

1. Rinse your vehicle thoroughly using a low pressure garden hose to remove loose dirt.
2. If necessary, use a sponge or a soft towel with mild cleaner to remove road grime.
 - ▶ Clean the windshield, headlight lens, panels, and other plastic components with extra care to avoid scratching them. Avoid directing water into the air cleaner, muffler, and electrical parts.
3. Thoroughly rinse your vehicle with plenty of clean water and dry with a soft, clean cloth.
4. After the vehicle dries, lubricate any moving parts.
 - ▶ Make sure that no lubricant spills onto the brakes or tires. Brake discs, pads, drum or shoes contaminated with oil will suffer greatly reduced braking effectiveness and can lead to a crash.
5. Lubricate the drive chain immediately after washing and drying the vehicle.
6. Apply a coat of wax to prevent corrosion.
 - ▶ Avoid products that contain harsh detergents or chemical solvents. These can damage the metal, paint, and plastic on your vehicle. Keep the wax clear of the tires and brakes.
 - ▶ If your vehicle has any matte painted parts, do not apply a coat of wax to the matte painted surface.

Washing Precautions

Follow these guidelines when washing:

- Do not use high-pressure washers:
 - ▶ High-pressure water cleaners can damage moving parts and electrical parts, rendering them inoperable.
 - ▶ Water in the air intake can be drawn into the throttle body and/or enter the air cleaner.
 - Do not direct water at the muffler:
 - ▶ Water in the muffler can prevent starting and causes rust in the muffler.
 - Dry the brakes:
 - ▶ Water adversely affects braking effectiveness. After washing, apply the brakes intermittently at low speed to help dry them.
 - Do not direct water under the seat:
 - ▶ Water in the under seat compartment can damage your documents and other belongings.
-
- Do not direct water at the air cleaner:
 - ▶ Water in the air cleaner can prevent the engine from starting.
 - Do not direct water near the headlight:
 - ▶ The headlight's inside lens may fog temporarily after washing or while riding in the rain. This does not impact the headlight function. However, if you see a large amount of water or ice accumulated inside the lens(es), have your vehicle inspected by your dealer.
 - Do not use wax or polishing compounds on matte painted surface:
 - ▶ Use a soft cloth or sponge, plenty of water, and a mild detergent to clean matte painted surfaces. Dry with a soft clean cloth.

Aluminum Components

Aluminum will corrode from contact with dirt, mud, or road salt. Clean aluminum parts regularly and follow these guidelines to avoid scratches:

- Do not use stiff brushes, steel wool, or cleaners containing abrasives.
- Avoid riding over or scraping against curbs.

Panels

Follow these guidelines to prevent scratches and blemishes:

- Wash gently using a soft sponge and plenty of water.
- To remove stubborn stains, use diluted detergent and rinse thoroughly with plenty of water.
- Avoid getting gasoline, brake fluid, or detergents on the instruments, panels, or headlight.

Windscreen

Using plenty of water, clean the windscreen with a soft cloth or sponge. (Avoid using detergents or any kind of chemical cleaner on the windscreen.) Dry with a soft, clean cloth.

NOTICE

To avoid possible scratching or other damage, use only water and a soft cloth or sponge to clean the windscreen.

For a dirtier windscreen, use a diluted neutral detergent with a sponge and plenty of water. Make sure to wash off all the detergent. (Detergent residue may cause windscreen cracks.)

Replace the windscreen if scratches cannot be removed and they obstruct clear vision.

Take care to keep battery electrolyte, brake fluid, or other chemical solvents off the windscreen and screen garnish. They will damage the plastic.

Exhaust Pipe and Muffler

The exhaust pipe and muffler are titanium and stainless steel but may become stained by mud or dust.

The part in the following illustration is coated to prevent oxidation.

To avoid damaging the coating, do not use aggressive chemical cleaners or compounds.

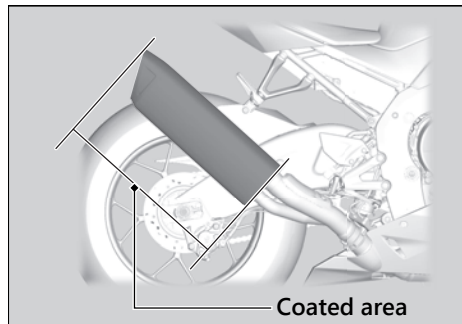

Coated area

To remove mud or dust, use a wet sponge and a mild detergent, then rinse well with clean water. Dry with chamois or a soft towel. Use a soft cloth sprayed with a multi-purpose spray lubricant and wipe clean.

Uncoated area

To remove mud or dust, use a wet sponge and a liquid kitchen abrasive, then rinse well with clean water. Dry with chamois or a soft towel. If necessary, remove heat stains by using a commercially available fine texture compound. Then rinse by the same manner as removing mud or dust.

NOTICE

Even though the exhaust is made of titanium and stainless steel, it can become stained. Remove all marks and blemishes as soon as they are noticed.

Storing Your Vehicle

If you store your vehicle outdoors, you should consider using a full-body cover.

If you won't be riding for an extended period, follow these guidelines:

- Wash your vehicle and wax all painted surfaces (except matte painted surfaces). Coat chrome pieces with rust-inhibiting oil.
- Lubricate the drive chain. ➤ P. 140
- Place your vehicle on a maintenance stand and position a block so that both tires are off the ground.
- After rain, remove the body cover and allow the vehicle to dry.

- Remove the battery (➤ P. 146) to prevent discharge. Fully charge the battery and then place it in a shaded, well-ventilated area.
 - ▶ If you leave the battery in place, disconnect the negative ⊖ terminal to prevent discharge.

After removing your vehicle from storage, inspect all maintenance items required by the Maintenance Schedule.

USA For more information about storage, refer to the *Honda Winter Storage Guide*, available from your dealer.

Canada For more information about storage, visit our website at www.honda.ca and look up "Storage Tips" under the "Honda Warranty" in the Warranty tab for your Model.

Transporting Your Vehicle

If your vehicle needs to be transported, it should be carried on a motorcycle trailer or a flatbed truck or trailer that has a loading ramp or lifting platform, and motorcycle tie-down straps. Never try to tow your vehicle with a wheel or wheels on the ground.

NOTICE

Towing your vehicle can cause serious damage to the transmission.

You & the Environment

Owning and riding a vehicle can be enjoyable, but you must do your part to protect the environment.

Choose Sensible Cleaners

Use a biodegradable detergent when you wash your vehicle. Avoid aerosol spray cleaners that contain chlorofluorocarbons (CFCs) which damage the atmosphere's protective ozone layer.

Recycle Wastes

Put oil and other toxic wastes in approved containers and take them to a recycling center. Call your local or state office of public works or environmental services to find a recycling center in your area, and to get instructions on how to dispose of non-recyclable wastes. Do not place used engine oil in the trash, or pour it down a drain or on the ground. Used oil, gasoline, coolant, and cleaning solvents contain poisons that can hurt refuse workers and contaminate drinking water, lakes, rivers, and oceans.

Vehicle Identification Number

The VIN and engine serial number uniquely identify your vehicle and are required in order to register your vehicle. They may also be required when ordering replacement parts. You should record these numbers and keep them in a safe place.

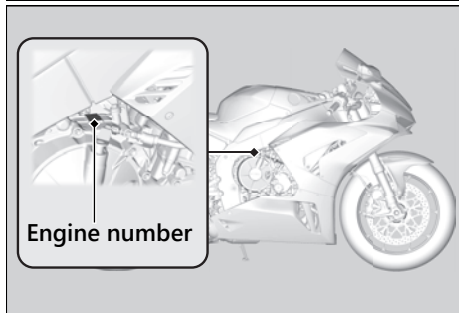
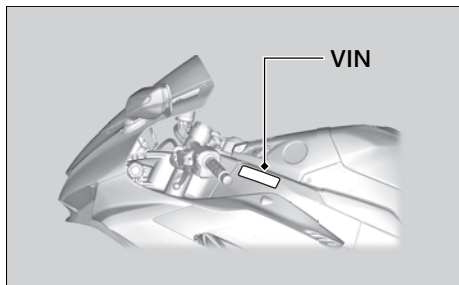
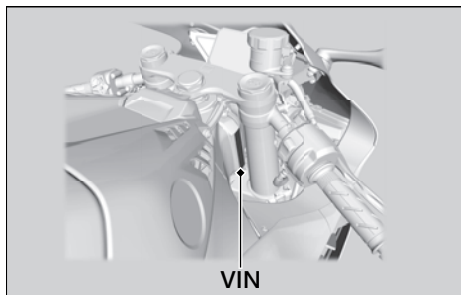

Emission Control Systems

Your vehicle engine emits combustion byproducts, including carbon monoxide (CO), oxides of nitrogen (NO_x), and hydrocarbons (HC). Gasoline evaporation also emits hydrocarbons. Controlling the production of NO_x, CO, and HC is important for the environment.

Exhaust Emission Requirements

The U.S. Environmental Protection Agency (EPA), the California Air Resources Board (CARB), and Environment and Climate Change Canada (ECCC) require that your vehicle comply with applicable exhaust, crankcase, and fuel permeation emission standards during its useful life, when operated and maintained according to the instructions provided.

CARB also requires that your vehicle comply with applicable evaporative emission requirements during its useful life, when

operated and maintained according to the instructions provided.

USA Compliance with the terms of the Distributor's Warranties for Honda Motorcycle Emission Control Systems is necessary in order to maintain a valid emissions system warranty. The Vehicle Emission Control Information label is located on the left side of the swingarm.

Vehicle emission control information label

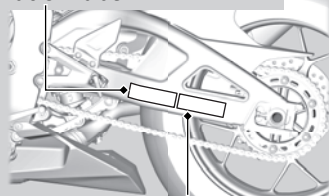

Canada Vehicle emission control information label

Noise Emission Requirements

The EPA requires that vehicles built after January 1, 1983 comply with applicable noise emission standards for one year or 3,730 miles (6,000 km) after the time of purchase when operated and maintained according to the instructions provided.

Exhaust Emission Control System

The exhaust emission control system includes the following components that should not need adjustment, although periodic inspection by your dealer is recommended.

PGM-FI System

The PGM-FI (programmed fuel injection) system uses sequential multiport fuel injection, and is comprised of air intake, engine control, fuel control, and exhaust control subsystems. The engine control module (ECM) uses sensors to determine how much air enters the engine, and then controls how much fuel to inject.

Ignition Timing Control System

The ignition timing control system adjusts the ignition timing to reduce the amount of HC, CO, and NO_x produced.

Secondary Air Injection System

The secondary air injection system adds filtered air into the exhaust gas to help improve emission control performance.

Catalytic Converters

The exhaust system contains one or more catalytic converters. Catalytic converters use a catalyst to convert most of the harmful exhaust gas compounds into harmless compounds.

Evaporative Emission Control System

50 STATE (meets California)

An evaporative emissions control system uses a canister filled with charcoal to adsorb fuel vapor from the fuel tank while the engine is off. The vapor is drawn into the engine and burned while riding.

Crankcase Emissions Control System

The engine is equipped with a closed crankcase system to prevent discharging crankcase emissions into the atmosphere.

Blow-by gas is returned to the combustion chamber through the crankcase breather hose air cleaner housing and throttle body.

Fuel Permeation Emission Control

The fuel tank, fuel hoses, and fuel vapor charge hoses use fuel permeation control technologies to prevent fuel vapor emissions. Tampering with these components to reduce or defeat the effectiveness of the fuel permeation technologies is prohibited.

Noise Emission Control System

TAMPERING WITH THE NOISE CONTROL SYSTEM IS PROHIBITED:

U. S. federal law prohibits, and Canadian provincial laws may prohibit, the following acts or the causing thereof: (1) The removal or rendering inoperative by any person, other than for purposes of maintenance, repair or replacement, of any device or element of design incorporated into any new vehicle for the purpose of noise control prior to its sale or delivery to the ultimate purchaser or while it is in use; or (2) the use of the vehicle after such device or element of design has been removed or rendered inoperative by any person.

AMONG THOSE ACTS PRESUMED TO CONSTITUTE TAMPERING ARE THE FOLLOWING ACTS:

- Removal of, or puncturing the muffler, baffles, header pipes or any other component which conducts exhaust gases.
- Removal of, or puncturing of any part of the intake system.
- Lack of proper maintenance.
- Removing or disabling any emissions compliance component, or replacing any compliance component with a noncompliant component.

Problems Affecting Vehicle Exhaust Emissions

Have your vehicle inspected and repaired by your dealer if you experience any of the following symptoms:

- Hard starting or stalling after starting
- Rough idling
- Misfiring or backfiring during acceleration
- Poor engine performance and poor fuel economy

Catalytic Converter

This vehicle is equipped with a three-way catalytic converter. The catalytic converter contains precious metals that serve as catalysts in high temperature chemical reactions that convert hydrocarbons (HC), carbon monoxide (CO), and oxides of nitrogen (NOx) in the exhaust gasses into safe compounds.

A defective catalytic converter contributes to air pollution and can impair your engine's performance. A replacement unit must be an original Honda part or equivalent.

Follow these guidelines to protect your vehicle's catalytic converter.

- Always use unleaded gasoline. Leaded gasoline will damage the catalytic converter.
- Keep the engine in good running condition. A poorly running engine can cause the catalytic converter to overheat causing damage to the converter or the vehicle.
- If your engine is misfiring, backfiring, stalling, or otherwise not running properly, stop riding and turn off the engine. Have your vehicle serviced as soon as possible.

Oxygenated Fuels

Some conventional fuels blended with alcohol or an ether compound are available in some locales to help reduce emissions to meet clean air standards. These gasolines are collectively referred to as oxygenated fuels. If you plan to use oxygenated fuel, check that it is unleaded and meets the minimum octane rating and blend requirement.

The following fuel blends have been approved for use in your vehicle:

- Ethanol (ethyl alcohol) up to 10% by volume.
 - ▶ Gasoline containing ethanol may be marketed under the name Gasohol.
- Do not use gasoline containing methanol (methyl alcohol).

If you accidentally fill your fuel tank with an oxygenated fuel containing higher percentages, you may experience performance problems. To resolve the problem, have your dealer drain the fuel tank and replace with the correct fuel. Fuel system or performance problems resulting from the use of an oxygenated fuel containing higher percentages are not covered by your warranty.

NOTICE

Improper use of oxygenated fuels can damage metal, rubber, and plastic parts of your fuel system.

Oxygenated fuel can also damage paint.

Damage caused by spilled fuel is not covered by warranty.

If you notice any undesirable operating symptoms or performance problems, try a different brand of gasoline.

Authorized Manuals

USA The Service Manual used by your authorized dealer is available from your Honda dealer or Helm, Inc.

Canada See your dealer to order authorized manuals.

Also available, but not necessary to service your model, is the Honda Common Service Manual, which explains basic service information for various systems on Honda motorcycles, scooters, and ATV.

USA The Winter Storage Guide in conjunction with the Owner's Manual and Service Manual

can help you prepare your Honda motorcycle, scooter, ATV, and SxS for winter storage. These Honda manuals are written for the professional technician. However, if you possess the proper tools, observe the safety standards, and are mechanically capable, you should find them easy to use.

Special Honda tools are necessary for some procedures.

USA

Order online: www.helminc.com

Order Toll Free: 1-888-CYCLE93

(1-888-292-5393)

(NOTE: For Credit Card Orders Only)

Monday - Friday 8:00 AM - 6:00 PM EST

Description
2021 CBR1000ST/SP Service Manual
Common Service Manual (61CSM00)
USA Winter Storage Guide (S9507)
2021 CBR1000ST/SP Owner's Manual

Warranty Coverage and Service

Coverage

Your new Honda is covered by the following warranties:

- Vehicle Limited Warranty
- Emission Control System Warranty
- **USA** Noise Control Warranty

The responsibilities, restrictions, and exclusions that apply to these warranties are explained in the Warranties Booklet given to you by your Honda dealer at the time of purchase. Always keep your Honda owner's card with your Warranties Booklet.

Canada Please refer to the Warranty Booklet posted on our website at www.honda.ca.

It is important to realize that your warranty applies only to defects in material or workmanship of your Honda. Your warranty coverage does not apply to the normal wear and deterioration associated with use of the vehicle.

Your warranty coverage is not voided if you perform your own maintenance. However, failures that occur due directly to improper maintenance are not covered by these warranties.

USA You can extend almost all of your warranty coverage through the Honda Protection Plan. For more information, see your Honda dealer.

Statement on Warranty Coverage for Aftermarket and Recycled Parts

New Jersey

The Magnuson-Moss Warranty Act, 15 U.S.C. s. 2301 et seq., makes it illegal for motor vehicle manufacturers to void a motor vehicle warranty or deny warranty coverage solely because an aftermarket or recycled part has been used to repair the vehicle or someone other than the authorized service provider performed service on the vehicle. This provision does not apply to a new motor vehicle purchased solely for commercial or industrial use.

Under federal law, a manufacturer may deny warranty coverage and charge for repairs to a vehicle if it is discovered that an aftermarket or recycled part installed on the vehicle is defective or was installed incorrectly and caused damage to another part of the vehicle otherwise covered under warranty. The Federal Trade Commission requires that a manufacturer demonstrate that an aftermarket or recycled part or service

performed by a person other than an authorized service provider caused damage to another part of the vehicle otherwise covered under warranty before denying warranty coverage. Additionally, federal law allows a manufacturer to void a motor vehicle warranty or deny warranty coverage if the manufacturer provides the article or service to consumers free of charge under the warranty or the manufacturer has secured a waiver from the Federal Trade Commission.

Warranty Coverage and Service

Service

Please remember that maintenance recommended in the Maintenance Schedule is not included in your warranty coverage.

If you believe you have a problem with your vehicle, call the service department of your Honda dealer. Make an appointment for an inspection and diagnosis. You will be asked to authorize that inspection, and your dealer will return the results of the inspection. If a problem exists and is covered under warranty, your dealer will perform the warranty repairs. If you have any questions about your warranty coverage or the nature of the repair, talk to the Service Manager of your Honda dealer.

If a misunderstanding occurs and you aren't satisfied with your dealer's handling of the situation, we suggest you discuss your problem with the appropriate member of the dealership's management team. If you are still not satisfied, contact the owner of the dealership or their designated representative.

Honda Contacts

American Honda Motor Co., Inc.

If you wish to contact Honda directly to comment on your experiences with your vehicle or with your dealer, please send your comments to the following address:

Powersports Customer Relations
American Honda Motor Co., Inc.,
P.O. Box 2200, Torrance,
CA 90509-2200
Mailstop: 100-4W-5F
Telephone: (866) 784-1870
Website:
<https://powersports.honda.com/contact-us>

Canada

Honda Canada Inc.
Customer Relations Department,
180 Honda Boulevard
Markham, Ontario
L6C 0H9

Telephone: (888) 946-6329

Fax: (877) 939-0909

E-mail: honda_cr@ch.honda.com

Please include the following information in your letter:

- Name, address, and telephone number
- Product model, year, and VIN
- Date of purchase
- Dealer name and address

We will likely ask your Honda dealer to respond, or possibly acknowledge your comments directly.

Your Honda Dealer

The service department of your Honda dealer offers trained personnel to perform regular maintenance and unexpected repairs. It has the latest available service information from Honda and also handles warranty inspections and repairs.

The parts department offers Honda Genuine Parts, Pro Honda products, Honda Genuine Accessories (USA only), and Honda accessories and products (Canada only) that provide the same quality that went into your vehicle.

USA The sales department offers the Honda Protection Plan to extend almost all of your warranty coverage.

Your Honda dealer can also supply information about, riding events, and information about safety training available in your local area.

Reporting Safety Defects

USA

If you believe that your vehicle has a defect which could cause a crash or could cause injury or death, you should immediately inform the National Highway Traffic Safety Administration (NHTSA) in addition to notifying American Honda Motor Co., Inc.

If NHTSA receives similar complaints, it may open an investigation, and if it finds that a safety defect exists in a group of vehicles, it may order a recall and remedy campaign. However, NHTSA cannot become involved in individual problems between you, your dealer, or American Honda Motor Co., Inc.

To contact NHTSA, you may call the Vehicle Safety Hotline toll-free at:

1-888-327-4236

(TTY: 1-800-424-9153); go to

<http://www.safercar.gov>;

or write to:

Administrator, NHTSA,

1200 New Jersey Avenue, SE.,

Washington, DC 20590.

You can also obtain other information about motor vehicle safety from:

<http://www.safercar.gov>.

Reporting Safety Defects

Canada

If you believe that your vehicle has a defect which could cause a crash or could cause injury or death, you should immediately inform Honda Canada Inc. and you may also inform Transport Canada.

If Transport Canada receives similar complaints, it may open an investigation, and if it finds that a safety defect exists in a group of vehicles, it may lead to a recall and remedy campaign. However, Transport Canada cannot become involved in individual problems between you, your dealer, or Honda Canada Inc.

To contact Transport Canada's Defect Investigations and Recalls Division, you may call:

1-800-333-0510

For more information on reporting safety defects or about motor vehicle safety, go to

<http://www.tc.gc.ca/roadsafety>.

Specifications

■ Main Components

Overall length	82.7 in (2,100 mm)
Overall width	29.3 in (745 mm)
Overall height	44.9 in (1,140 mm)
Wheelbase	57.3 in (1,455 mm)
Minimum ground clearance	4.5 in (115 mm)
Caster angle	24°
Trail	4.0 in (102 mm)
Curb weight	443 lb (201 kg)
Maximum weight capacity *1	366 lb (166 kg)
Passenger capacity	Rider and 1 passenger
Minimum turning radius	12.47 ft (3.80 m)
Displacement	61.0 cu-in (1,000 cm ³)
Bore x stroke	3.19 x 1.91 in (81.0 x 48.5 mm)
Compression ratio	13.2:1
Fuel	Unleaded gasoline Recommended: 91 PON or higher
Tank capacity	4.25 US gal (16.1 L)

Battery	CBR1000ST YTZ7S 12 V-6 Ah (10 HR)	
	CBR1000SP HY85S lithium-ion (li-ion) 12 V-2.0 Ah (20 HR)	
Gear ratio	1st	2.615
	2nd	2.058
	3rd	1.700
	4th	1.478
	5th	1.333
	6th	1.214
Reduction ratio (primary / final)	1.630 / 2.687	

*1 : Including rider, passenger, all luggages, and accessories

Specifications

■ Service Data

Tire size	Front	120/70ZR17M/C(58W)
	Rear	200/55ZR17M/C(78W)
Tire type		Radial, tubeless
Recommended Tire	Front	BRIDGESTONE RS11F
		PIRELLI DIABLO SUPERCORSA SP V3
	Rear	BRIDGESTONE RS11R N
		PIRELLI DIABLO SUPERCORSA SP V3 E
Tire air pressure	Front	36 psi (250 kPa, 2.50 kgf/cm ²)
	Rear	42 psi (290 kPa, 2.90 kgf/cm ²)
Minimum tread depth	Front	0.06 in (1.5 mm)
	Rear	0.08 in (2.0 mm)
Spark plug	(standard)	SILMAR10C9S (NGK)
Spark plug gap		0.031 - 0.035 in (0.80 - 0.90 mm)
Idle speed	(non-adjustable)	1,400 ± 100 rpm
Recommended engine oil		Honda 4-stroke motorcycle oil API Service Classification SG or higher, excluding oils marked as "Energy Conserving" or "Resource Conserving," SAE 10W-30, JASO T 903 standard MA

Engine oil capacity	After draining	3.0 US qt (2.8 L)
	After draining & engine oil filter change	3.2 US qt (3.0 L)
	After disassembly	4.2 US qt (4.0 L)
Recommended brake fluid	Honda DOT 4 Brake Fluid	
Cooling system capacity	2.42 US qt (2.29 L)	
Recommended coolant	Pro Honda HP Coolant	
Recommended drive chain lubricant	Pro Honda HP Chain Lube or equivalent	
Drive chain slack	1.0 - 1.4 in (25 - 35 mm)	
Standard drive chain	DID525HV3KAI or RK525ROZ8	
	No. of links	120
Standard sprocket size	Drive sprocket	16T
	Driven sprocket	43T

■ Bulbs

Headlight	LED
Brake light/Taillight	LED
Front turn signal / Position light	LED
Rear turn signal	LED
License plate light	LED

■ Fuses

Main fuse	30 A
Other fuse	30 A, 15 A, 10 A, 7.5A

■ Torque Specifications

Under cowl bolt	0.7 lbf-ft (1.0 N·m, 0.1 kgf·m)
Under cowl pan screw	7 lbf-ft (10 N·m, 1.0 kgf·m)
Middle cowl bolt	0.7 lbf-ft (1.0 N·m, 0.1 kgf·m)

Information Record

VIN	
Engine No.	
Color Label & Code	
Owner's Name	
Address	
City/State	
Phone	
Dealer's Name	
Address	
City/State	
Phone	
Service Manager	

California Proposition 65 Warning

 **WARNING:** Operating, servicing and maintaining a passenger vehicle or off-highway motor vehicle can expose you to chemicals including engine exhaust, carbon monoxide, phthalates, and lead, which are known to the State of California to cause cancer and birth defects or other reproductive harm. To minimize exposure, avoid breathing exhaust, do not idle the engine except as necessary, service your vehicle in a well-ventilated area and wear gloves or wash your hands frequently when servicing your vehicle. For more information go to www.P65Warnings.ca.gov/passenger-vehicle.

Free Manuals Download Website

<http://myh66.com>

<http://usermanuals.us>

<http://www.somanuals.com>

<http://www.4manuals.cc>

<http://www.manual-lib.com>

<http://www.404manual.com>

<http://www.luxmanual.com>

<http://aubethermostatmanual.com>

Golf course search by state

<http://golfingnear.com>

Email search by domain

<http://emailbydomain.com>

Auto manuals search

<http://auto.somanuals.com>

TV manuals search

<http://tv.somanuals.com>