

# HP Photosmart A440 series

## User Guide



**Hewlett-Packard Company notices**

The information contained in this document is subject to change without notice.

All rights reserved. Reproduction, adaptation, or translation of this material is prohibited without prior written permission of Hewlett-Packard, except as allowed under copyright laws. The only warranties for HP products and services are set forth in the express warranty statements accompanying such products and services. Nothing herein should be construed as constituting an additional warranty. HP shall not be liable for technical or editorial errors or omissions contained herein.

© 2007 Hewlett-Packard Development Company, L.P.

Windows, Windows 2000, and Windows XP are U.S. registered trademarks of Microsoft Corporation.

Windows Vista is either a registered trademark or trademark of Microsoft Corporation in the United States and/or other countries.

Intel and Pentium are trademarks or registered trademarks of Intel Corporation or its subsidiaries in the United States and other countries.

---

# Contents

<b>1 Welcome</b>	
One touch photo printing at your fingertips .....	3
Find more information .....	3
Printer parts .....	4
Optional accessories .....	7
Use the Print menu .....	8
<b>2 Paper basics</b>	
Choose and load paper .....	9
Choose the best paper for the job .....	9
Load your paper .....	9
<b>3 Print basics</b>	
Dock your camera .....	11
Print from a docked camera .....	12
View photos to print .....	12
Print photos .....	12
Set print quality .....	13
Enhance your photos .....	13
<b>4 Print from other devices</b>	
PictBridge-certified camera .....	15
Print from a PictBridge-certified camera .....	15
Computer .....	15
About HP Photosmart Essential, HP Photosmart Mac, and HP Photosmart Share .....	16
Transfer photos to a computer .....	16
<b>5 Maintain and transport the printer</b>	
Insert the print cartridge .....	17
Remove ink from your skin and clothing .....	18
Clean and maintain the printer .....	19
Clean the outside of the printer .....	19
Automatically clean the print cartridge .....	19
Manually clean the print cartridge contacts .....	20
Print a test page .....	21
Align the print cartridge .....	21
Update the HP Photosmart software .....	22
Store the printer and print cartridge .....	22
Store the printer .....	23
Store the print cartridge .....	23
Maintain the quality of photo paper .....	23
Transport the printer .....	24
<b>6 Troubleshooting</b>	
Printer hardware problems .....	27
Printing problems .....	30

Error messages .....	33
<b>7 Specifications</b>	
System requirements .....	35
Printer specifications .....	35
<b>8 HP support</b>	
Check the HP support Web site first .....	37
HP support by phone .....	37
Phone support period .....	37
Placing a call .....	38
After the phone support period .....	38
Warranty .....	39
Additional warranty options .....	40
Regulatory model identification number VCVRA-0703 .....	40
Environmental statements .....	40
<b>A HP Photosmart A440 series menus</b>	
Printer menus .....	41
<b>B Quick Reference</b> .....	43
<b>Index</b> .....	45

---

# 1 Welcome

Thank you for your HP Photosmart purchase! This HP Photosmart A440 series is an innovative pairing of camera and printer in one easy-to-use device. The printer uses HP Real Life technologies, such as red-eye removal, to make it easy for you to get better prints with or without a computer.

---

 **NOTE:** In this guide, references to the printer mean the part of the HP Photosmart A440 series product other than the camera.

---

## One touch photo printing at your fingertips

The HP Photosmart A440 series makes printing your photos convenient, easy, and fast. Just follow these basic steps for most of your printing needs:

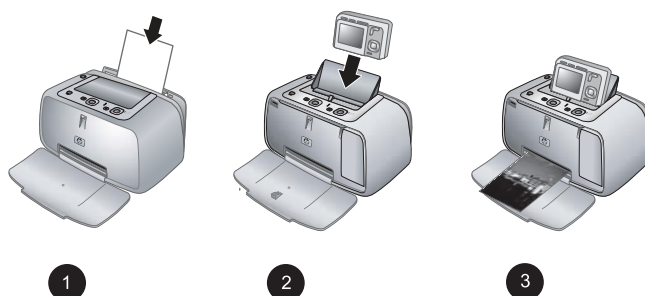

1. **Choose and load paper.** Use HP Advanced Photo paper for the best results. For more information, see [“Choose and load paper”](#) on page 9.
2. **Dock your camera and view photos.** For more information, see [“Dock your camera”](#) on page 11 and [“View photos to print”](#) on page 12.
3. **Print a photo with the press of a button.** Press **Print** to print any photo you are viewing. It's that easy!

For a more complete look at each step, see [“Print basics”](#) on page 11.

## Find more information

Your new HP Photosmart A440 series printer comes with the following documentation:

- **Quick Start Guide:** The setup instructions that explain how to set up the printer and camera, and install the HP Photosmart software. Read this document first.
- **Printer User Guide:** The printer *User Guide* is the book you are reading. This guide describes the basic features of the printer, explains how to use the printer without connecting it to a computer, and contains hardware troubleshooting information.
- **Electronic Help:** The electronic Help describes how to use the printer with a computer and contains software troubleshooting information.
- **Camera User Guide:** This documentation explains how to use the camera to take pictures and includes troubleshooting and maintenance information. The camera

documentation is provided in electronic format and can be found in one of the following locations, depending on where you purchased the camera and if you purchased it separately or not:

- Europe, the Middle East, Africa, or Latin America: If you purchased the camera and printer as a combined product, the camera User Guide is provided on the **HP Photosmart User Guide CD** included with your combined product. If you purchased the camera separately, the camera User Guide is provided on the **HP Photosmart software CD** included with your camera. See the printed camera Quick Start Guide that came with your camera for specific instructions on how to access the camera User Guide on the CD.
- North America: If you purchased the camera and printer as a combined product, the camera User Guide is provided on the **HP Photosmart software CD** included with your combined product. If you purchased the camera separately, the camera User Guide is provided on the **HP Photosmart software CD** that came with your camera. See the printed Quick Start Guide that came with your camera for specific instructions on how to access the camera User Guide on the CD.

After you have installed the HP Photosmart software on your computer, you can view the electronic Help on your computer:

- **Windows:** From the **Start** menu, select **Programs** or **All Programs**, point to **HP, HP Photosmart A440 series**, and then click **Help**.
- **Mac:** Choose **Help, Mac Help** in the Finder, and then choose **Library, HP Photosmart Printer Help**.

## Printer parts

This section gives an overview of the parts of your printer, and provides references to sections where the parts and functions are described in more detail.

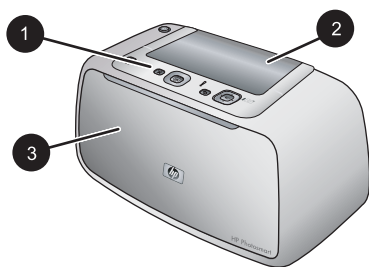

**Figure 1-1 Front view (closed)**

1	<b>Control panel:</b> Control the basic functions of the printer from here.
2	<b>Camera dock cover:</b> Open this to dock the camera on the printer.
3	<b>Output tray (closed):</b> Open this to print or to connect a PictBridge-certified digital camera to the camera port on the front of the printer.

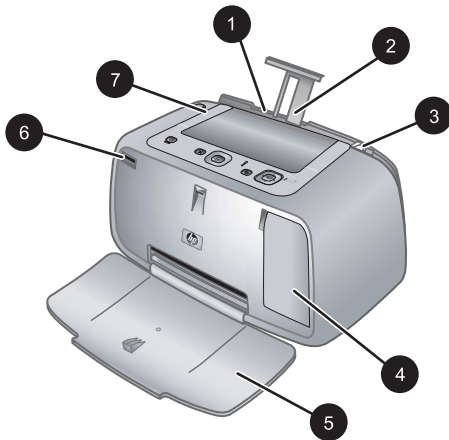

**Figure 1-2 Front view (open)**

1	<b>Input tray:</b> Load paper here. Open the output tray first. The input tray opens automatically when you open the output tray. To close the input tray you must close the output tray first.
2	<b>Input tray extension:</b> Pull out to support paper.
3	<b>Paper-width guide:</b> Move to the width of the current paper to position the paper properly.
4	<b>Print cartridge door:</b> Open to insert or remove the HP 110 Tri-color Inkjet print cartridge.
5	<b>Output tray (open):</b> The printer deposits prints here. The input tray opens automatically when you open the output tray.
6	<b>Camera port:</b> Connect a PictBridge-certified digital camera to this port.
7	<b>Handle:</b> Extend to carry the printer.

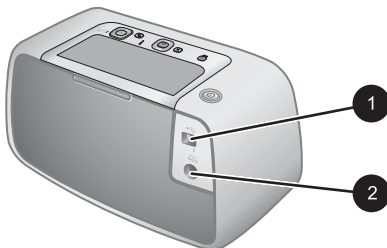

**Figure 1-3 Rear of printer**

1	<b>USB port:</b> Connect the printer to a computer using the supplied USB cable here.
2	<b>Power cord connection:</b> Connect the power cord here.

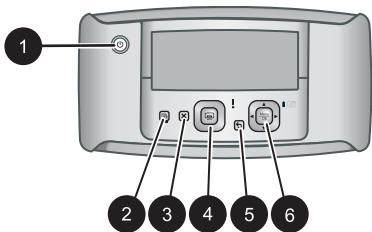

**Figure 1-4 Control panel**

1	<b>On:</b> Press to turn the printer on or off. If you have a camera docked on the printer, this button will turn the camera off/on also.
2	<b>Red Eye:</b> Press to turn Red Eye on or off. See <a href="#">“Enhance your photos”</a> on page 13.
3	<b>Cancel:</b> Press to stop a print action.
4	<b>Print:</b> Press to print the current photo. Each additional press prints the same photo again.
5	<b>Back:</b> Press <b>Back</b> to step back one screen at a time.
6	<b>4-way arrow button:</b> Press the 4-way arrow button to scroll through photos, or to navigate the menus. Press <b>Menu/OK</b> to open/close a menu option.

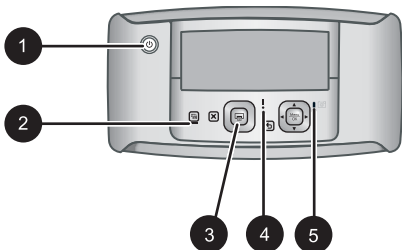

**Figure 1-5 Indicator lights**

1	<b>On light:</b> Solid green if the printer is on, flashing if the printer is turning on or off.
2	<b>Red Eye light:</b> Solid green if Red Eye is turned on.
3	<b>Print light:</b> Solid green if the printer is ready to print, pulsing green if the printer is busy printing.
4	<b>Status light:</b> Flashing red if there is an error or if some user action is required. An error message on the camera image display describes the problem.
5	<b>Camera batteries light:</b> Solid green if the camera rechargeable batteries are charged, flashing if the batteries are charging. If you dock a fully charged camera, the camera batteries light is off.



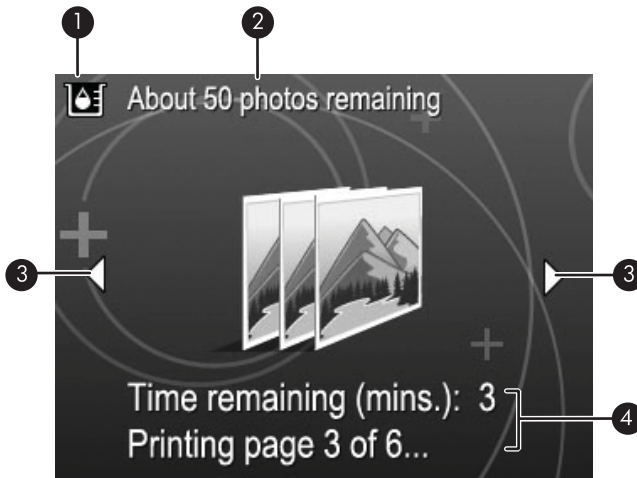

**Figure 1-6 Photo summary screen**

1	<b>Ink-level indicator:</b> Displays the ink level of the HP 110 Tri-color Inkjet print cartridge.
2	<b>Estimated prints remaining status:</b> Displays the approximate number of photos you can print with the current print cartridge.
3	<b>Navigation arrows:</b> These arrows indicate there are other photos you can browse through by pressing ◀ or ▶ on the printer control panel.
4	<b>Messaging area:</b> Displays printer messages.

## Optional accessories

There are optional accessories available for Photosmart printers that enhance their use for printing anywhere, anytime. The accessory or accessories available for your printer appear in this section. The appearance of the accessories may vary from what is shown.

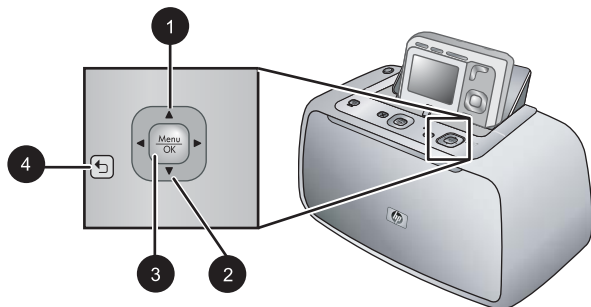

**Figure 1-7 HP Photosmart Carrying Case**

The lightweight, durable HP Photosmart Carrying Case holds and protects everything you need for hassle-free printing on the go.

## Use the Print menu

The Print menu contains many features for printing photos, changing print settings, and more. When the camera is not in the camera dock, different menus are displayed. For more information, see the camera *User Guide*.



---

 **TIP:** The menu contains many useful commands and options, but common functions, such as printing, are usually available with a single button press on the printer control panel.

---

### To use the Print menu

1. With the camera turned off, insert it into the dock on top of the printer. For more information see [“Dock your camera” on page 11](#).
2. Press **Menu/OK** (3) to open the **Print Options** menu, press ▲ (1) or ▼ (2) to select **Print Menu**, and then press **Menu/OK** again.
3. Press ▲ (1) or ▼ (2) to navigate through the options under the menu. Menu options that are not accessible are dimmed.
4. Press **Menu/OK** (3) to select an option.
5. To exit a menu, press the  button (4).

---

 **NOTE:** For a list of printer menu options, see [“Printer menus” on page 41](#).

---

---

## 2 Paper basics

This section provides some basic information about paper and other media you can use with your printer.

### Choose and load paper

Learn how to choose the right paper for your print job and how to load it into the input tray for printing.

- [Choose the best paper for the job](#)
- [Load your paper](#)

### Choose the best paper for the job

Use HP Advanced Photo Paper. It is especially designed to work with the inks in your printer to create beautiful photos. Other photo papers will produce inferior results.

For a list of available HP-designed inkjet paper, or to purchase supplies, go to:

- [www.hpshopping.com](http://www.hpshopping.com) (U.S.)
- [www.hpshopping.ca](http://www.hpshopping.ca) (Canada)
- [www.hp.com/eur/hpoptions](http://www.hp.com/eur/hpoptions) (Europe)
- [www.hp.com](http://www.hp.com) (All other countries/regions)

The printer is set by default to print the best quality photos on HP Advanced Photo Paper. If you print on a different type of paper, be sure to change the paper type. For information on changing the paper type in the printer menu, see “[To change the paper type](#)” on page 10.

### Load your paper

Paper loading tips:

- You can print on photo paper, index cards, L-size cards, A-6 cards, or panoramic paper.
- Before loading paper, slide out the paper-width guide to make room for the paper.
- Load only one type and size of paper at a time. Do not mix paper types or sizes in the input tray.
- Do not load more than **20** sheets of 10 x 15 cm (4 x 6 inches) photo paper.
- Do not load more than **10** sheets of 10 x 30 cm (4 x 12 inches) photo paper for panoramic printing. Loading more than ten sheets can cause paper feed problems.
- If you are using tabbed paper, load the paper so the tab feeds in last.

### To load paper

1. Open the output tray. The input tray opens automatically.

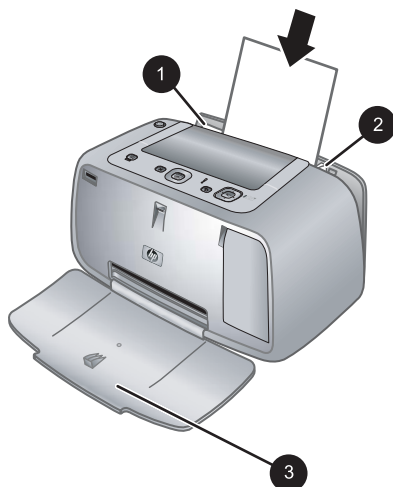

2. Load up to 20 sheets of photo paper with the print side or glossy side facing the front of the printer. If you are using tabbed paper, load the paper so tab feeds in last. When loading, slide the paper to the left side of the input tray and push the paper down firmly until it stops.
3. Adjust the paper-width guide to fit close to the edge of the paper without bending the paper.

### To change the paper type

---

 **TIP:** If you are printing on a paper type other than the recommended HP Advanced Photo Paper, be sure to change the paper type setting to improve the results. Best quality can be achieved with HP Advanced Photo Paper only.

---

1. Press **Menu/OK**, press ▼ to select **Print Menu**, and then press **Menu/OK** again.
2. Press ▼ to select **Tools**, and then press **Menu/OK**.
3. Press ▼ to select **Paper type**, and then press **Menu/OK**.
4. Press ▼ to select one of the following paper types:
  - **HP Advanced Photo Paper** (default)
  - **HP Premium Photo Paper**
  - **Other**
5. Press **Menu/OK**.

---

## 3 Print basics

The printer lets you produce amazing prints without even going near a computer. After setting up the printer using the setup instructions that came in the box, you are just a few steps away from printing your photos. This section contains the following topics:

- “[Dock your camera](#)” on page 11
- “[Print from a docked camera](#)” on page 12
- “[Set print quality](#)” on page 13
- “[Enhance your photos](#)” on page 13

---

 **NOTE:** In the following instructions, always use the buttons on the printer control panel, unless instructed otherwise. Also note that all camera buttons are disabled when the camera is in the camera dock.

---

### Dock your camera

To print photos you have taken with the camera, dock the camera on the printer. Dock the camera only when it is turned **OFF**.

---

 **CAUTION:** Do not attempt to dock an incompatible camera on the printer. Docking an incompatible camera could damage the connector. Go to [www.hp.com/support](http://www.hp.com/support) for a list of compatible HP cameras for the printer.

**CAUTION:** Do not undock the camera while printing. If you undock the camera while printing, all print jobs are cancelled.

 **NOTE:** You can also connect a PictBridge-certified camera to the camera port on the front of the printer using the USB cable that came with the camera. However, you cannot connect another camera if the HP Photosmart A440 series camera is already docked on the printer. See “[PictBridge-certified camera](#)” on page 15.

---

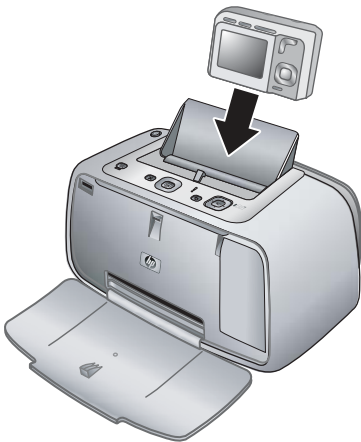

### To dock the camera on the printer

1. Open the camera dock cover, if necessary.
2. Hold the camera so the camera image display faces you and the bottom of the camera is down.
3. Make sure the camera is turned off.
4. Press the camera into the dock so that the connector tab in the camera dock plugs into the connector slot on the bottom of the camera.
5. In most cases, docking the camera turns on both the printer and the camera. If it does not, press **On** on the printer control panel.

---

 **NOTE:** While the camera is docked, the camera image display dims after eight minutes of inactivity, and turns off after ten minutes. The camera image display turns back on if you send a print job from a connected computer, or if you press any button on the printer.

---

## Print from a docked camera

Printing photos directly from the docked camera is the easiest and fastest way to turn your digital photos into outstanding prints. This section contains the following topics:

- [“View photos to print” on page 12](#)
- [“Print photos” on page 12](#)

### View photos to print

You can browse and print from the camera image display.

You select the photos you want to print by using the printer control panel. Make sure the camera has photos in its internal memory or on an optional memory card in the camera, and make sure the camera is properly docked.

#### To view photos

- ▲ Browse the photos on the camera by pressing ◀ or ▶ on the printer control panel.

### Print photos

**Important:** Your photos are instantly dry, and can be handled immediately after they are printed. However, HP recommends that you leave the printed surface of your photos exposed to the air for 3 minutes after printing to allow the colors to fully develop before you stack them with other photos or place them in albums.

#### One touch photo prints

1. Navigate to a photo you want to print.
2. Press **Print** once for each copy of the photo you want to print. This adds the photo to the print queue.
3. Press ◀ or ▶ to browse to the next photo you want to print. You do not have to wait for the first photo to finish printing.



---

**NOTE:** You can also print the current photo by pressing **Menu/OK**, selecting **Print this image now** in the **Print Options** menu, and then pressing **Menu/OK** again.

---

### To print all photos

1. Press **Menu/OK**, press ▼ to select **Print Menu**, and then press **Menu/OK** again.
2. Press ▼ to select **Print All**, and then press **Menu/OK**.
3. Follow the prompts on the camera image display.

### To print a photo index

1. Press **Menu/OK**, press ▼ to select **Print Menu**, and then press **Menu/OK** again.
2. Press ▼ to select **Print Index**, and then press **Menu/OK**.

A photo index shows thumbnail views and index numbers for all photos. Use an index card or plain paper to conserve photo paper.

## Set print quality

You can set the printer to print photos at a higher or lower level of quality. For the best quality photos, choose **Best**. This mode produces the highest quality photo, but is also a slightly slower print mode. If you want to print a photo quickly and are not concerned with obtaining the highest quality, choose the lower quality setting, **Fast**.

### To change the print quality

1. Press **Menu/OK**, press ▼ to select **Print Menu**, and then press **Menu/OK** again.
2. Select **Printer Settings**, and then press **Menu/OK**.
3. Select **Print quality**, and then press ◀ or ▶ to select the desired print quality.
4. Press **Menu/OK**.

## Enhance your photos

Red Eye automatically enhances your photos using HP Real Life Technologies that:

- Sharpen blurred photos.
- Improve the dark areas of a photo without affecting the light areas of a photo.
- Reduce red-eye that can occur in photos taken with a flash.
- Improve the overall brightness, color, and contrast of photos.

Red Eye is on by default when you turn on the printer for the first time. If you want to print a photo without using the Red Eye improvements, turn off Red Eye.

### To turn off Red Eye

- ▲ Press **Red Eye**.

Red Eye remains off until you press **Red Eye** again.





---

# 4 Print from other devices

Use the printer with other devices to share photos with friends and family. You can print from a:

- [“PictBridge-certified camera”](#) on page 15
- [“Computer”](#) on page 15

## PictBridge-certified camera

You can print photos by connecting a PictBridge-certified digital camera directly to the camera port of the printer with a USB cable. When you print from a digital camera, the printer uses the settings that you selected on the camera. For more information, see the documentation that came with the camera.

### Print from a PictBridge-certified camera

Using a PictBridge-certified camera with the printer is easy and fast.

---

 **NOTE:** Make sure that there is not a camera docked before connecting a camera to the camera port. You can only have one camera connected at a time.

---

#### To print using a PictBridge-certified camera

1. Load HP Advanced Photo Paper into the printer.
2. Turn on the PictBridge-certified digital camera.
3. Make sure the USB configuration setting of the camera is set to Digital Camera (non-HP cameras only), and then connect the camera to the camera port of the printer using the USB cable that came with the PictBridge-certified camera.  
See the camera documentation for more information about the USB configuration setting. The name of the setting and its options may differ on non-HP digital cameras.
4. If you already selected photos for printing on the camera, the **Print DPOF Photos?** or **Print marked pictures?** dialog box is displayed on the camera. Select **No** to bypass printing pre-selected photos or **Yes** to print them before proceeding.  
DPOF (Digital Print Order Format) provides information to the printer about photos preselected on the camera for printing, along with information on the number of copies to be printed and other image settings.
5. Use the options and controls on your camera to print your photos. See the camera documentation for more information.

## Computer

You need to transfer your photos to the computer before you can use them with HP Photosmart software that lets you print from a computer. First install the HP Photosmart software. For more information, see [“Transfer photos to a computer”](#) on page 16.

For information on installing the HP Photosmart software, see the setup instructions that came in the box with the printer. The HP Photosmart software includes the interface that is displayed whenever you print from a computer.

Be sure to download the latest software update every couple of months to ensure you have the latest features and improvements. For more information, see [“Update the HP Photosmart software”](#) on page 22.

---

 **NOTE:** The electronic Help provides more information on the many print settings available when you print from a computer. To learn how to open the electronic Help, see [“Find more information”](#) on page 3.

---

## About HP Photosmart Essential, HP Photosmart Mac, and HP Photosmart Share

HP Photosmart Essential and HP Photosmart Mac let you:

- Print panoramic photos
- Print passport photos
- Add a decorative border to a photo
- Use your photos for creative projects such as scrapbooking albums, greeting cards, and iron-on transfers
- Organize your photos in albums and search through them by keyword and dates (Windows only)
- Edit and enhance your photos by adding text or doing color correction
- Share your photos online with family and friends by using HP Photosmart Share.

For more information on the HP Photosmart software, explore the electronic Help.

Use HP Photosmart Share to share photos with friends and relatives using e-mail, online albums, or an online photo finishing service. The printer must be connected through a USB cable to a computer with Internet access and have all the HP software installed. If you try to use HP Photosmart Share and do not have all the required software installed or configured, a message prompts you through the required steps. For more information on HP Photosmart Share, see the camera *User Guide*.

## Transfer photos to a computer

You can transfer photos to a computer from a docked camera or other connected device, if you have set up a USB connection between the computer and the device. In addition you must have installed the HP Photosmart software. You need to transfer the photos to your computer to use them in image editing software, including the HP Photosmart software that came with the printer.

### To transfer photos to a computer

1. Connect the printer to the computer with a USB cable.
2. Turn off the camera if it is on.
3. Dock a camera on the printer or connect a PictBridge camera to the camera port.
4. HP Solution Center opens on the computer. Click **Transfer Photos**, and then follow the prompts on the computer. For more information, see the HP Photosmart Software Help.

---

# 5 Maintain and transport the printer

The printer requires very little maintenance. Follow the guidelines in this chapter to extend the life span of the printer and printing supplies, and to ensure that your prints are always of the highest quality. This section contains the following topics:

- “[Insert the print cartridge](#)” on page 17
- “[Remove ink from your skin and clothing](#)” on page 18
- “[Clean and maintain the printer](#)” on page 19
- “[Update the HP Photosmart software](#)” on page 22
- “[Store the printer and print cartridge](#)” on page 22
- “[Maintain the quality of photo paper](#)” on page 23
- “[Transport the printer](#)” on page 24

For information on maintaining the camera, see the camera *User Guide*.

## Insert the print cartridge

Use the HP 110 Tri-color Inkjet print cartridge to print black-and-white and color photos. HP Vivera Inks deliver true-to-life photo quality and exceptional fade resistance, resulting in vivid colors that last. HP Vivera Inks are specially formulated and scientifically tested for quality, purity, and fade resistance.

For optimal printing results, HP recommends using only HP print cartridges. Inserting an incorrect cartridge may invalidate the printer warranty.

---

△ **CAUTION:** Check that you are using the correct print cartridges. Also, note that HP does not recommend modifying or refilling HP cartridges. Damage that results from modifying or refilling HP cartridges is not covered by the HP warranty.

---

For best print quality, HP recommends that you install all retail print cartridges before the date stamped on the box.

### To prepare the printer and cartridge

1. Make sure the printer is on.
2. Open the print cartridge door of the printer.
3. Remove the bright pink tape from the cartridge.

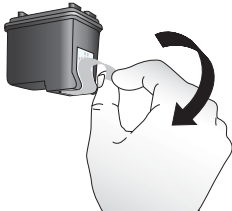

**Figure 5-1** Remove the pink tape



**Figure 5-2 Do not touch here**



### To insert the cartridge

1. If you are replacing a cartridge, push down and pull outward on the cartridge in the cradle to remove it.
2. Hold the replacement cartridge with the label on top. Slide the cartridge at a slight upward angle into the cradle so the copper-colored contacts go in first. Push the cartridge until it snaps into place.
3. Close the print cartridge door. The camera screen shows an icon with the approximate ink level for the installed print cartridge. No ink-level icon is displayed if the cartridge is not a genuine HP cartridge, or if the cartridge has been used in a different printer.
4. Load HP Advanced Photo Paper in the input tray, press **Menu/OK**, and then follow the onscreen instructions to align the cartridge.

 **NOTE:** Ink from the cartridges is used in the printing process in a number of different ways, including in the initialization process, which prepares the device and cartridges for printing, and in printhead servicing, which keeps print nozzles clear and ink flowing smoothly. In addition, some residual ink is left in the cartridge after it is used. For more information see [www.hp.com/go/inkusage](http://www.hp.com/go/inkusage).

## Remove ink from your skin and clothing

Follow these instructions to remove ink from your skin and clothing:

Surface	Remedy
Skin	Wash the area with an abrasive soap.
White fabric	Wash the fabric in <i>cold</i> water and use chlorine bleach.

(continued)

Surface	Remedy
Color fabric	Wash the fabric in <i>cold</i> water and use sudsy ammonia.

△ **CAUTION:** Always use cold water to remove ink from fabric. Warm or hot water can set the ink into the fabric.

## Clean and maintain the printer

Keep the printer and print cartridge clean and well maintained using the simple procedures in this section.

### Clean the outside of the printer

#### To clean the outside of the printer

1. Turn off the printer, and then disconnect the power cord from the back of the printer.
2. Wipe the outside of the printer with a soft cloth that has been lightly moistened with water.

△ **CAUTION:** Do not use any type of cleaning solution. Household cleaners and detergents may damage the printer finish.

**CAUTION:** Do not clean the interior of the printer. Keep all fluids away from the interior.

### Automatically clean the print cartridge

If you notice white lines or single-color streaks on your prints, you may need to clean the print cartridge. Do not clean the cartridge more often than necessary, since cleaning uses up ink.

#### To clean the print cartridge

1. Make sure a camera is in the camera dock.
2. Press **Menu/OK**, press ▼ to select **Print Menu**, and then press **Menu/OK** again.
3. Select **Tools**, and then press **Menu/OK**.
4. Select **Clean cartridge**, and then press **Menu/OK**.
5. When the printer finishes cleaning the cartridge and prints a test page, check the test page and select from the following options:
  - If the test page has white streaks or missing colors, the print cartridge needs to be cleaned again. Select **Yes** on the camera image display, and then press **Menu/OK** on the printer control panel.
  - If the print quality of the test page looks good, select **Cancel** on the camera image display, and then press **Menu/OK**.

You can clean the cartridge up to three times. Each successive cleaning is more thorough and uses more ink.

If you complete all three levels of cleaning using this procedure and you still notice white streaks or missing colors on the test page, you may need to clean the print cartridge

copper-colored contacts. For more information, see [“To clean the print cartridge contacts”](#) on page 20.

---

 **NOTE:** If the cartridge or printer has been recently dropped, you may also see white streaks or missing colors in your prints. This problem is temporary and clears up within 24 hours.

---

## Manually clean the print cartridge contacts

If you use the printer in a dusty environment, debris may accumulate on the copper-colored contacts and cause printing problems.

### To clean the print cartridge contacts

1. Gather the following items to clean the contacts:
  - Distilled water (tap water may contain contaminants that can damage the print cartridge)
  - Cotton swabs or other soft, lint-free material that will not stick to the print cartridge
2. Open the print cartridge door.
3. Remove the print cartridge and place it on a piece of paper with the ink nozzle plate facing up. Be careful not to touch the copper-colored contacts or the ink nozzle plate with your fingers.

---

△ **CAUTION:** Do not leave the print cartridge outside the printer for more than 30 minutes. Ink nozzles exposed to the air longer than this may dry out and cause printing problems.

---

4. Lightly moisten a cotton swab with distilled water and squeeze any excess water from the swab.
5. Gently wipe the copper-colored contacts with the cotton swab.

---

△ **CAUTION:** Do not touch the ink nozzle plate. Touching the ink nozzle plate will result in clogs, ink failure, and bad electrical connections.

---

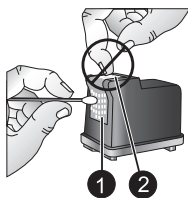

1	Clean copper colored contacts with swab
2	Ink nozzle plate

6. Repeat steps 4 and 5 until no ink residue or dust appears on a clean swab.
7. Insert the print cartridge in the printer, and then close the print cartridge door.

## Print a test page

You can print a test page that contains useful information about the installed print cartridge, serial number, and other aspects of the printer.

### To print a test page

1. Make sure the camera is in the camera dock.
2. Load paper in the input tray. Use plain paper or index cards to conserve photo paper.
3. Press **Menu/OK**, press ▼ to select **Print Menu**, and then press **Menu/OK** again.
4. Select **Tools**, and then press **Menu/OK**.
5. Select **Print Test Page**, and then press **Menu/OK**.

## Align the print cartridge

The first time you insert a HP 110 Tri-color Inkjet print cartridge, the printer aligns it automatically. However, if colors in printouts are misaligned, or if the alignment page does not print correctly when you insert a new print cartridge, use the following procedure to align the print cartridge.

### To align the print cartridge

1. Press **Menu/OK**, press ▼ to select **Print Menu**, and then press **Menu/OK** again.
2. Select **Tools**, and then press **Menu/OK**.
3. Select **Align cartridge**, and then press **Menu/OK**.
4. When the printer finishes aligning the cartridge, it prints an alignment page to confirm that the alignment was successful.



- The check marks verify that the print cartridge is installed correctly and functioning properly.
- If an “x” is displayed to the left of any of the bars, align the print cartridge again. If the “x” is still displayed, replace the print cartridge.

## Update the HP Photosmart software

Download the latest software update every few months to ensure you have the latest features and improvements. You can download HP Photosmart software updates by going to [www.hp.com/support](http://www.hp.com/support) or by using HP Software Update.

### To download the software (Windows)

 **NOTE:** Make sure you are connected to the Internet before you use HP Software Update.

1. From the Windows **Start** menu, select **Programs** or **All Programs**, point to **HP**, and then click **HP Software Update**. The HP Software Update window is displayed.
2. Click **Check Now**. HP Software Update searches the HP Web site for software updates. If the computer does not have the most recent version of the HP Photosmart software installed, a software update is displayed in the HP Software Update window.
  - ▲ If the computer has the most recent version of the HP Photosmart software installed, the following message is displayed in the HP Software Update window: “No updates are available for your system at this time.”
3. If a software update is available, select the checkbox next to the software update to select it.
4. Click **Install**.
5. Follow the onscreen instructions to complete the installation.

### To download the software (Mac)

 **NOTE:** Make sure you are connected to the Internet before you use the HP Photosmart Update application.

1. Start HP Photosmart Mac.
2. Click the **Applications** tab, and then click **HP Software Update**.
3. Follow the onscreen instructions to check for software updates.  
If you are behind a firewall, enter the proxy server information in the update screen.

## Store the printer and print cartridge

Protect the printer and print cartridge by storing them properly when you are not using them.



## Store the printer

The printer can be stored for long or short periods of inactivity

- Close the input and output trays when the printer is not in use.
- Store the printer indoors out of direct sunlight in a place without temperature extremes.
- If the printer and print cartridge have not been used for one month or more, clean the print cartridge before printing. For more information, see [“Automatically clean the print cartridge”](#) on page 19.

## Store the print cartridge

When you store or transport the printer, always leave the active print cartridge inside the printer. The printer stores the print cartridge in a protective cap during the power-down cycle.

---

△ **CAUTION:** Make sure the printer completes its power-down cycle before you unplug the power cord. This allows the printer to store the print cartridge properly.

---

Follow these tips to help maintain HP print cartridges and ensure consistent print quality:

- Keep all unused print cartridges in their original sealed packages until they are needed. Store print cartridges at room temperature (15–35° C or 59–95° F).
- Do not remove the plastic tape covering the ink nozzles until you are ready to install the print cartridge in the printer. If the plastic tape has been removed from the print cartridge, do not attempt to reattach it. Reattaching the tape damages the print cartridge.

## Maintain the quality of photo paper

For best results with photo paper, follow the guidelines in this section.

### To store photo paper

- Store the photo paper in its original packaging or in a resealable plastic bag.
- Store the packaged photo paper on a flat, cool, and dry surface.
- Return unused photo paper to the plastic bag. Paper left in the printer or exposed to the elements may curl.

### To handle photo paper

- Always hold photo paper by the edges to avoid fingerprints.
- If the photo paper has curled edges, place it in its plastic storage bag and gently bend it in the opposite direction of the curl until the paper lies flat.

## Transport the printer

It is easy to transport and set up the printer almost anywhere. Take it with you on vacations and to family gatherings and social events to instantly print and share photos with family and friends.

To make it even easier to print on the go, you can purchase:

**Carrying Case:** Carry the printer and printing supplies together in this convenient HP Photosmart carrying case.

### To transport the printer

1. Turn off the printer.
2. Remove the camera from the camera dock and close the camera dock door.
3. Remove all paper from the input and output trays, close the output tray, and then close the input tray.

---

 **NOTE:** Make sure the printer completes its power-down cycle before you unplug the power cord. This allows the printer to store the print cartridge properly.

---

4. Unplug the power cord.
5. If the printer is connected to a computer, disconnect the USB cable from the computer.
6. Always carry the printer upright.

---

 **NOTE:** Do not remove the print cartridge when transporting the printer.

---

 **TIP:** The printer has a convenient built-in handle you can use to make it easy to carry. Extend the handle by lifting it up from above the camera dock door. Do not shake or swing the printer while carrying it by the handle.

---



**Figure 5-3 Extend the handle**

Make sure to bring the following items with you:

- Paper
- Power cord
- Your compatible digital camera
- Extra print cartridges (if you plan to print a lot)

- Optional printer accessories you plan to use
- If you are going to connect the printer to a computer, bring the USB cable and HP Photosmart software CD

---

 **NOTE:** If you do not take the documentation with you, be sure to write down the correct print cartridge number or purchase enough HP print cartridges before you go.

---



---

# 6 Troubleshooting

The HP Photosmart A440 series printer is designed to be reliable and easy to use. This section answers frequently asked questions about using the printer and printing without a computer. It contains information about the following topics:

- “[Printer hardware problems](#)” on page 27
- “[Printing problems](#)” on page 30
- “[Error messages](#)” on page 33

For troubleshooting information about using the HP Photosmart software and printing from a computer, see the electronic Help. For information about viewing the electronic Help, see “[Find more information](#)” on page 3.

For information about troubleshooting issues involving the HP Photosmart camera, see the camera *User Guide*.

## Printer hardware problems

Before contacting HP support, read this section for troubleshooting tips or go to the online support services at [www.hp.com/support](http://www.hp.com/support).

---

 **NOTE:** If you want to connect the printer to a computer, HP recommends using a USB cable of less than 3 meters (10 feet) in length. The supplied USB cable meets this recommendation.

---

### The Status light is flashing red.

**Cause:** The printer requires attention. Try the following solutions.

**Solution:**

- Check the camera image display for instructions. If the printer is connected to a computer, check the computer monitor for instructions.
- Turn the printer off, unplug the power cord, and then wait 30 seconds. Plug the power cord back in and then turn on the printer.
- A print cartridge is not installed. For more information, see “[Insert the print cartridge](#)” on page 17.
- If the Status light continues to flash, go to [www.hp.com/support](http://www.hp.com/support) or contact HP support.

---

### The On light flashed briefly after I turned the printer off.

**Solution:** This is a normal part of the power-down process. It does not indicate a problem with the printer.

---

**I can't dock my camera on the printer.**

**Solution:** The camera may not be compatible with the printer. Do not attempt to dock an incompatible camera. Go to [www.hp.com/support](http://www.hp.com/support) for a list of compatible HP cameras for the printer.

For more information, see "[Dock your camera](#)" on page 11.

---

**The buttons on the control panel do not respond.**

**Cause:** A printer error has occurred. Try the following solutions.

**Solution:**

- Wait for about a minute to see if the printer resets.
  - Undock and redock the camera. This often corrects the problem.
  - Turn the printer off, unplug the power cord, and then wait 30 seconds. Plug the power cord back in and then turn on the printer.
  - If the printer does not reset, and the control panel buttons still do not respond, go to [www.hp.com/support](http://www.hp.com/support) or contact HP support.
- 

**The printer does not find and display the images on the camera memory card or internal memory.**

**Solution:**

- Turn the printer off and then back on.
  - The memory card may contain file types the printer cannot read directly from the memory card. This is only an issue when you are using a PictBridge-certified camera with the camera port on the front of the printer.
    - Save the photos to a computer, and then print them from the computer. For more information, see the documentation that came with the camera and the electronic Help.
    - The next time you take pictures, set the digital camera to save them in a file format the printer can read directly from the memory card. For a list of supported file formats, see "[Printer specifications](#)" on page 35. For instructions on setting the digital camera to save photos in specific file formats, see the documentation that came with the camera.
  - The photo file names have changed from the original file names assigned to them by the camera. Make sure the file names comply with the standard file naming convention and structure used by the camera.
- 

**Not all the images on my camera were transferred to my computer.**

**Cause:** The missing photos are stored in the camera's internal memory. Only photos on the camera's memory card are transferred.

**Solution:** Move the photos from the camera's internal memory to the camera's memory card. For more information, see the camera documentation.

You can also remove the memory card and then redock the camera. This forces the printer to read the internal memory of the camera.

---

### **The printer is plugged in, but it will not turn on.**

#### **Solution:**

- The printer may be plugged into a power strip that is turned off. Turn on the power strip, and then turn on the printer.
  - The printer may be plugged into an incompatible power source. If you are traveling abroad, make certain the power source in the country/region you are visiting complies with the power requirements and power cord of the printer.
  - Check that the power adapter is functioning properly. To check the power adapter:
    - Make sure the power adapter is connected to your printer and a compatible power source.
    - Press and hold down the **On** button on the printer. If the **On** button lights up, then the power cord is working properly. If it fails to light, go to [www.hp.com/support](http://www.hp.com/support) or contact HP support.
- 

### **The printer makes noises when I turn it on, or starts making noises on its own after it has been sitting unused for a while.**

**Solution:** The printer may make noises after long periods of inactivity (approximately 2 weeks), or when its power supply has been interrupted and then restored. This is normal operation—the printer is performing an automatic maintenance procedure to ensure that it produces the best quality output.

---

### **The camera buttons are not working.**

**Solution:** You are pushing buttons on the camera after it is placed in the camera dock. All camera buttons are disabled when the camera is in the camera dock. Use the buttons on the control panel instead.

---

### **The printer does not recognize the PictBridge camera connected to the camera port.**

#### **Cause:**

- You had a camera in the camera dock when you connected the PictBridge camera to the camera port. The printer only recognizes one camera at a time.
- The PictBridge camera connected to the camera port is not on.

**Solution:** Disconnect both cameras, and then connect the PictBridge camera to the camera port using the USB cable that came with the camera. If only the PictBridge camera is connected, make sure it is turned on.

---

### **The camera batteries will not charge.**

#### **Solution:**

- You may be using alkaline batteries, which are not rechargeable. Purchase rechargeable batteries to take advantage of the printer's charging feature. For more information, see the camera *User Guide*.
  - The camera is not securely in the camera dock on top of the printer. Make sure the camera is docked properly. For more information, see "[Dock your camera](#)" on page 11.
  - Make sure the power cord is connected to the printer and to an active AC power outlet.
  - The rechargeable batteries may be old and unable to hold a charge. Replace the batteries.
- 

## **Printing problems**

Before contacting HP support, read this section for troubleshooting tips or go to the online support services at [www.hp.com/support](http://www.hp.com/support).

### **Paper does not feed into the printer correctly.**

#### **Solution:**

- Make sure that the paper-width guide fits close to the edge of the paper without bending the paper.
  - There may be too much paper loaded in the input tray. Remove some paper and try printing again.
  - If sheets of photo paper stick together, try loading one sheet at a time.
  - If you are using the printer in an extremely high- or low- humidity environment, insert the paper as far as it will go into the input tray, and load one sheet of photo paper at a time.
  - If you are using photo paper that is curled, place the paper in a plastic bag and gently bend it in the opposite direction of the curl until the paper lies flat. If the problem persists, use paper that is not curled. For information about proper storage and handling of photo paper, see "[Maintain the quality of photo paper](#)" on page 23.
  - The paper may be too thin or too thick. Try using HP-designed photo paper. For more information, see "[Choose the best paper for the job](#)" on page 9.
  - If you are using 10 x 30 cm (4 x 12 inches) photo paper for panoramic printing, do not load more than ten sheets in the input tray. Loading more than 10 sheets of panorama paper can cause paper feed problems.
-



## The image printed at an angle or is off-center.

### Solution:

- The paper may not be loaded correctly. Reload the paper, making sure that the paper is correctly oriented in the input tray and that the paper-width guide fits close to the edge of the paper. For paper-loading instructions, see [“Choose and load paper”](#) on page 9.
  - The print cartridge may need to be aligned. For more information, see [“Align the print cartridge”](#) on page 21.
- 

## No page came out of the printer.

### Solution:

- The printer may need attention. Read the camera image display for instructions.
  - The power may be off or there may be a loose connection. Make sure that the power is on and the power cord is securely connected.
  - You may not have any paper in the input tray. Check that paper is loaded correctly in the input tray. For paper-loading instructions, see [“Choose and load paper”](#) on page 9.
  - The paper may have jammed while printing. See the following section for instructions on clearing a paper jam.
- 

## The paper jammed while printing.

**Solution:** Check the camera image display for instructions. To clear a paper jam, try the following solutions.

- If the paper came part way through the front of the printer, gently pull the paper towards you to remove it.
  - If the paper did not come part way through the front of the printer, try removing it from the back of the printer:
    - Remove the paper from the input tray.
    - Gently pull the jammed paper to remove it from the back of the printer.
  - If you cannot grasp the edge of the jammed paper to remove it, try the following:
    - Turn off the printer, unplug the power cord, and then wait 30 seconds.
    - Plug in the power cord and then turn on the printer. The printer checks for paper in the paper path and will automatically eject the jammed paper.
- 

 **TIP:** If you experience paper jams while printing, try loading one sheet of photo paper at a time. Insert the paper as far as it will go into the input tray.

---

### **A blank page came out of the printer.**

**Solution:**

- Check the ink-level icon on the camera image display. If the print cartridge is out of ink, replace it. For more information, see [“Insert the print cartridge” on page 17](#).
  - You may have begun printing and then cancelled the process. If you cancelled the process before the photo started printing, the printer may have already loaded paper in preparation for printing. The next time you print, the printer will eject the blank page before starting the new printing project.
- 

### **My photo printed on top of the tabbed end of the paper.**

**Solution:** When using tabbed paper, load it so that the tab feeds in last.

---

### **The printer ejects the paper when preparing to print.**

**Solution:** Direct sunlight could be interfering with the operation of the automatic paper sensor. Move the printer out of direct sunlight. The printer also ejects paper if it detects that the paper has already been printed on.

---

### **Print quality is poor.**

**Solution:**

- The print cartridge may be running out of ink. Check the ink-level icon on the camera image display, and replace the cartridge if necessary. For more information, see [“Insert the print cartridge” on page 17](#).
- You may have selected a low-resolution setting on the digital camera when you took the picture. For better results in the future, set the digital camera to a higher resolution.
- Make sure you are using the right type of photo paper for the project. For best results use HP Advanced Photo paper. It is especially designed to work with the inks in your printer. Other photo papers will produce inferior results. For more information, see [“Choose the best paper for the job” on page 9](#).
- Make sure the print quality setting is set to the Best quality. See [“Set print quality” on page 13](#).
- Make sure you have selected the correct paper type setting. See [“To change the paper type” on page 10](#).
- Turn the Red Eye feature on or off. See [“Enhance your photos” on page 13](#).
- You may be printing on the wrong side of the paper. Make sure the paper is loaded with the side to be printed facing toward the front of the printer.
- The print cartridge may need to be cleaned. For more information, see [“Automatically clean the print cartridge” on page 19](#).

- The print cartridge may need to be aligned. For more information, see [“Align the print cartridge”](#) on page 21.
  - Your photos are instantly dry, and can be handled immediately after they are printed. However, HP recommends that you leave the printed surface of your photos exposed to the air for 3 minutes after printing, to allow the colors to fully develop before you stack them with other photos or place them in albums.
- 

### **The images I marked for printing in the digital camera do not print.**

**Solution:** Some PictBridge-certified digital cameras let you mark photos for printing (DPOF) both in the camera's internal memory and on the memory card. If you mark photos in the internal memory, and then move photos from the camera's internal memory to the memory card, the marks may not transfer. Mark photos for printing after you transfer them from a digital camera's internal memory to the memory card. This is not true of the HP Photosmart A440 series cameras.

---

 **NOTE:** Make sure you select **Yes** when you first dock the camera and are prompted about printing marked photos.

---

### **Some menu commands are dimmed.**

**Solution:**

- You are trying to print a video clip. Video clip printing is not supported. Try printing another photo.
  - There are no photos on the camera. Take some pictures and then try printing.
- 

### **When I print photos I see unexpected results.**

**Cause:** Red Eye is on and the HP Real Life Technologies are adjusting for red-eye, brightening, focus, and contrast.

**Solution:** Turn off Red Eye. See [“To turn off Red Eye”](#) on page 13.

---

## **Error messages**

Before contacting HP support, read this section for troubleshooting tips or go to the online support services at [www.hp.com/support](http://www.hp.com/support).

The following error messages may appear on the camera image display when the camera is docked on top of the printer. Follow the instructions to resolve the problem.

**Error message: Open output door or clear paper jam, then press Menu/OK.**

**Solution:** To clear a paper jam, try the following:

- If the paper came part way through the front of the printer, gently pull the paper towards you to remove it.
  - If the paper did not come part way through the front of the printer, try removing it from the back of the printer:
    - Remove the paper from the input tray.
    - Gently pull the jammed paper to remove it from the back of the printer.
  - If you cannot grasp the edge of the jammed paper to remove it, try the following:
    - Turn off the printer.
    - Unplug the printer power cord. Wait about 30 seconds and then plug the power cord back in.
    - Turn on the printer. The printer checks for paper in the paper path and will automatically eject the jammed paper.
- 

**Error message: Print cartridge is not compatible. Use appropriate cartridge.**

**Solution:** Replace the print cartridge with the HP 110 Tri-color Inkjet print cartridge. For more information, see [“Insert the print cartridge”](#) on page 17.

---

# 7 Specifications

This section lists the minimum system requirements for installing the HP Photosmart software, and provides selected printer specifications.

- [System requirements](#)
- [Printer specifications](#)

For a complete list of specifications for the HP Photosmart A440 series camera, see the camera *User Guide* that is provided in the box or in online format on the HP Photosmart User Guide CD or the HP Photosmart software CD depending on where you purchased the camera and if you purchased it separately or not.

## System requirements

Component	Windows Minimum	Mac Minimum
Operating System	Windows XP Home, XP Professional, or x64 Edition	Mac OS X 10.3.x, 10.4.x
Processor	Intel® Pentium® II (or equivalent) or higher	G3 or greater
RAM	64 MB (256 MB recommended)	128 MB
Free Disk Space	500 MB	150 MB
Video Display	800 x 600, 16-bit or higher	800 x 600, 16-bit or higher
CD-ROM Drive	4x	4x
Browser	Microsoft Internet Explorer 5.5 or later	—

## Printer specifications

Category	Specifications
Connectivity	<b>USB 2.0 full-speed:</b> Windows XP Home, XP Professional, or x64 Edition; Mac OS X 10.3.x, 10.4.x <b>PictBridge:</b> Using the front camera port
Image File Formats	JPEG Baseline
Margins	Top 0.0 mm (0.0 inches) ; Bottom 0.0 mm (0.0 inches) ; Left/ right 0.0 mm (0.0 inches)
Media Sizes	Photo paper 10 x 15 cm (4 x 6 inches) Photo paper with tab 10 x 15 cm with 1.25 cm tab (4 x 6 inches with 0.5 inch tab) Index cards 10 x 15 cm (4 x 6 inches) A6 cards 105 x 148 mm (4.1 x 5.8 inches)

(continued)

Category	Specifications
	<p>L-size cards 90 x 127 mm (3.5 x 5 inches)</p> <p>L-size cards with tab 90 x 127 mm with 12.5 mm tab (3.5 x 5 inches with 0.5 inch tab)</p> <p>Supported only when printing from a computer: Hagaki, 101 x 203 mm (4 x 8 inches), Panorama photo paper 10 x 30 cm (4 x 12 inches).</p>
<b>Media Types</b>	<p>HP Advanced Photo Paper (recommended)</p> <p>HP Premium Photo Paper</p> <p>Cards (index, A6, L-size)</p>
<b>Environmental Specifications</b>	<p><b>Maximum during operation:</b> 5–40° C (41–104° F), 5–90% RH</p> <p><b>Recommended during operation:</b> 15–35 °C (59–95° F), 20–80% RH</p>
<b>Paper Tray</b>	One 10 x 15 cm (4 x 6 inches) photo paper tray
<b>Paper Tray Capacity</b>	<p>20 sheets of photo paper, maximum thickness 292 µm (11.5 mil) per sheet</p> <p>10 sheets of 10 x 30 cm (4 x 12 inches) photo paper for panoramic printing</p>
<b>Power Consumption</b>	<p>Printing: 14.4 W</p> <p>Idle: 8.1 W (with camera docked)</p> <p>Off: 6.2 W (with camera docked)</p> <p>Idle and charging camera batteries: 25 W</p> <p>Off and charging camera batteries: 22.9 W</p>
<b>Power Supply Model Number</b>	<p>HP Part # 0957–2121 (North America), 120 Vac (±10%) 60 Hz (±3 Hz)</p> <p>HP Part # 0957–2120 (Rest of world), 100-240 Vac (±10%) 50/60 Hz (±3 Hz)</p>
<b>Print Cartridge</b>	<b>HP 110 Tri-color Inkjet print cartridge</b>
<b>USB 2.0 Full-speed Support</b>	<p>Windows XP Home, XP Professional, or x64 Edition</p> <p>Mac OS X 10.3.x, 10.4.x</p> <p>HP recommends that the USB cable be less than 3 meters (10 feet) in length</p>

---

# 8 HP support

- “[Check the HP support Web site first](#)” on page 37
- “[HP support by phone](#)” on page 37
- “[Warranty](#)” on page 39
- “[Additional warranty options](#)” on page 40
- “[Regulatory model identification number VCVRA-0703](#)” on page 40
- “[Environmental statements](#)” on page 40

## Check the HP support Web site first

Check the documentation that came with the printer. If you do not find the information you need, check out the HP support Web site.

### To check for online support

1. Visit the HP online support Web site at [www.hp.com/support](http://www.hp.com/support). HP online support is available to all HP customers. It is the fastest source for up-to-date device information and expert assistance and includes the following features:
  - Fast access to qualified online support specialists
  - Software and driver updates for the HP Photosmart
  - Valuable HP Photosmart and troubleshooting information for common problems
  - Proactive device updates, support alerts, and HP newsgrams that are available when you register the HP Photosmart
2. For Europe only: Contact your local point of purchase. If the HP Photosmart has a hardware failure, you will be asked to bring it back to your local point of purchase. (Service is provided at no charge during the device limited warranty period. After the warranty period, you will be quoted a service charge.)
3. If you do not find the information you need online, call HP support. Support options and availability vary by device, country/region, language, and phone support period.

## HP support by phone

For a list of support phone numbers, see the phone number list on the inside of the back cover.

### Phone support period

One year of phone support is available in North America, Asia Pacific, and Latin America (including Mexico). To determine the duration of phone support in Europe, the Middle East, and Africa, go to [www.hp.com/support](http://www.hp.com/support). Standard phone company charges apply.

## Placing a call

Call HP support while you are in front of the computer and the HP Photosmart. Be prepared to provide the following information:

- Device model number (located on the label on the front of the device)
- Device serial number (located on the back or bottom of the device)
- Messages that appear when the situation occurs
- Answers to these questions:
  - Has this situation happened before?
  - Can you re-create it?
  - Did you add any new hardware or software to your computer at about the time that this situation began?
  - Did anything else occur prior to this situation (such as a thunderstorm, device was moved, etc.)?

## After the phone support period

After the phone support period, help is available from HP at an additional cost. Help may also be available at the HP online support Web site: [www.hp.com/support](http://www.hp.com/support). Contact your HP dealer or call the support phone number for your country/region to learn more about support options.



# Warranty

HP product	Duration of limited warranty
Software Media	90 days
Printer	1 year
Print or Ink cartridges	Until the HP ink is depleted or the "end of warranty" date printed on the cartridge has been reached, whichever occurs first. This warranty does not cover HP ink products that have been refilled, remanufactured, refurbished, misused, or tampered with.
Accessories	1 year unless otherwise stated

## A. Extent of limited warranty

- Hewlett-Packard (HP) warrants to the end-user customer that the HP products specified above will be free from defects in materials and workmanship for the duration specified above, which duration begins on the date of purchase by the customer.
- For software products, HP's limited warranty applies only to a failure to execute programming instructions. HP does not warrant that the operation of any product will be interrupted or error free.
- HP's limited warranty covers only those defects that arise as a result of normal use of the product, and does not cover any other problems, including those that arise as a result of:
  - Improper maintenance or modification;
  - Software, media, parts, or supplies not provided or supported by HP;
  - Operation outside the product's specifications;
  - Unauthorized modification or misuse.
- For HP printer products, the use of a non-HP cartridge or a refilled cartridge does not affect either the warranty to the customer or any HP support contract with the customer. However, if printer failure or damage is attributable to the use of a non-HP or refilled cartridge or an expired ink cartridge, HP will charge its standard time and materials charges to service the printer for the particular failure or damage.
- If HP receives, during the applicable warranty period, notice of a defect in any product which is covered by HP's warranty, HP shall either repair or replace the product, at HP's option.
- If HP is unable to repair or replace, as applicable, a defective product which is covered by HP's warranty, HP shall, within a reasonable time after being notified of the defect, refund the purchase price for the product.
- HP shall have no obligation to repair, replace, or refund until the customer returns the defective product to HP.
- Any replacement product may be either new or like-new, provided that it has functionality at least equal to that of the product being replaced.
- HP products may contain remanufactured parts, components, or materials equivalent to new in performance.
- HP's Limited Warranty Statement is valid in any country where the covered HP product is distributed by HP. Contracts for additional warranty services, such as on-site service, may be available from any authorized HP service facility in countries where the product is distributed by HP or by an authorized importer.

## B. Limitations of warranty

TO THE EXTENT ALLOWED BY LOCAL LAW, NEITHER HP NOR ITS THIRD PARTY SUPPLIERS MAKES ANY OTHER WARRANTY OR CONDITION OF ANY KIND, WHETHER EXPRESS OR IMPLIED WARRANTIES OR CONDITIONS OF MERCHANTABILITY, SATISFACTORY QUALITY, AND FITNESS FOR A PARTICULAR PURPOSE.

## C. Limitations of liability

- To the extent allowed by local law, the remedies provided in this Warranty Statement are the customer's sole and exclusive remedies.
- TO THE EXTENT ALLOWED BY LOCAL LAW, EXCEPT FOR THE OBLIGATIONS SPECIFICALLY SET FORTH IN THIS WARRANTY STATEMENT, IN NO EVENT SHALL HP OR ITS THIRD PARTY SUPPLIERS BE LIABLE FOR DIRECT, INDIRECT, SPECIAL, INCIDENTAL, OR CONSEQUENTIAL DAMAGES, WHETHER BASED ON CONTRACT, TORT, OR ANY OTHER LEGAL THEORY AND WHETHER ADVISED OF THE POSSIBILITY OF SUCH DAMAGES.

## D. Local law

- This Warranty Statement gives the customer specific legal rights. The customer may also have other rights which vary from state to state in the United States, from province to province in Canada, and from country to country elsewhere in the world.
- To the extent that this Warranty Statement is inconsistent with local law, this Warranty Statement shall be deemed modified to be consistent with such local law. Under such local law, certain disclaimers and limitations of this Warranty Statement may not apply to the customer. For example, some states in the United States, as well as some governments outside the United States (including provinces in Canada), may:
  - Preclude the disclaimers and limitations in this Warranty Statement from limiting the statutory rights of a consumer (e.g., the United Kingdom);
  - Otherwise restrict the ability of a manufacturer to enforce such disclaimers or limitations; or
  - Grant the customer additional warranty rights, specify the duration of implied warranties which the manufacturer cannot disclaim, or allow limitations on the duration of implied warranties.
- THE TERMS IN THIS WARRANTY STATEMENT, EXCEPT TO THE EXTENT LAWFULLY PERMITTED, DO NOT EXCLUDE, RESTRICT, OR MODIFY, AND ARE IN ADDITION TO, THE MANDATORY STATUTORY RIGHTS APPLICABLE TO THE SALE OF THE HP PRODUCTS TO SUCH CUSTOMERS.

### HP Limited Warranty

Dear Customer,

You will find below the name and address of the HP entity responsible for the performance of the HP Limited Warranty in your country.

**You may have additional statutory rights against the seller based on your purchase agreement. Those rights are not in any way affected by this HP Limited Warranty.**

**Ireland:** Hewlett-Packard Ireland Ltd. 30 Herbert Street IRL-Dublin 2

**United Kingdom:** Hewlett-Packard Ltd, Cain Road, Bracknell, GB-Berks RG12 1HN

## **Additional warranty options**

Extended service plans are available for the printer at additional costs. Go to [www.hp.com/support](http://www.hp.com/support), select your country/region and language, then explore the services and warranty area for information about the extended service plans.

## **Regulatory model identification number VCVRA-0703**

For regulatory identification purposes, the product is assigned a Regulatory Model Number. The Regulatory Model Number for the product is VCVRA-0703. This regulatory number should not be confused with the marketing name (HP Photosmart A440 series) or product number (Q8506A).

## **Environmental statements**

For Environmental Stewardship information, see the electronic Help.

---

# A HP Photosmart A440 series menus

## Printer menus

For information on how to navigate through the menus and make selections, see [“Use the Print menu”](#) on page 8.



### Print menu

- **Printer Settings**
  - **Paper Size:** Automatic
  - **Print Size:** Automatic
  - **Print quality:** Select to change the print quality. Choose between **Best** (default) which produces the highest quality prints, or **Normal**, which uses less ink than Best and prints faster. **Automatic** displays if Best or Normal is not available from the connected camera.
  - **Borderless printing:** Select to turn borderless printing **On** (default) or **Off**. When borderless printing is turned off, all pages print with a narrow white border.
- **Print All:** Select and press **Menu/OK** to print all the photos in the camera, one photo per page.
- **Print Index:** Select and press **Menu/OK** to print an index of all photos.
- **Print favorites:** Select and press **Menu/OK** to print photos tagged as favorites.
- **Tools**
  - **Print test page:** Select to print a test page containing information about the printer that can help in troubleshooting problems. For more information, see [“Print a test page”](#) on page 21.
  - **Clean cartridge:** Select to clean the HP 110 Tri-color Inkjet print cartridge. For more information, see [“Automatically clean the print cartridge”](#) on page 19.
  - **Align cartridge:** Select to align the HP 110 Tri-color Inkjet print cartridge. For more information, see [“Align the print cartridge”](#) on page 21.
- **Cancel Printing:** Select this to cancel all queued print jobs. A confirmation screen is displayed first.









# B Quick Reference

**Table B-1 Image display icons**

	<b>Navigation arrows:</b> These arrows indicate there are other photos you can browse through by pressing ◀ or ▶ on the printer control panel.
	<b>Ink-level indicator:</b> Displays the ink level of the HP 110 Tri-color Inkjet print cartridge.
 1	<b>Printing icon:</b> Displays the number of copies of the current photo being printed.
1 of 30	<b>Index number:</b> Displays the index number of current photo and the total number of photos on the camera.

**Table B-2 Printer control panel buttons and icons.**

	<b>On:</b> Press to turn the printer on or off.
	<b>Red Eye:</b> Press to turn Red Eye on or off. See <a href="#">“Enhance your photos”</a> on page 13.
	<b>Print:</b> Press to print the current photo. Each additional press prints the same photo again.
	<b>Menu/OK:</b> Press to open and close a menu or select a menu option.
	<b>Back:</b> Press <b>Back</b> to step back one screen at a time.
	<b>Cancel:</b> Press to stop a print action.



---

# Index

## A

accessories 7, 24  
after the support period 38  
aligning print cartridges 21  
alignment page 21

## B

buttons 6

## C

calling HP support 38  
cameras  
    images do not print 33  
    port 4  
carrying case  
    model 7  
    transporting HP Photosmart  
        A440 series 24  
cartridges. *See* print cartridges  
cleaning  
    print cartridges 19  
    printer 19  
computer  
    printing from 3  
    system requirements 35  
control panel 6

## D

digital cameras. *See* cameras  
Digital Print Order Format. *See*  
    DPOF  
docking the camera 11  
documentation  
    electronic Help 3  
    guides 3  
    setup instructions 3  
documentation, printer 3  
DPOF 15

## E

electronic Help 3  
error messages 33

## F

file formats, supported 35  
Frequently asked questions 27

## G

Getting help 27

## H

Help 27  
help, electronic 3  
HP Photosmart A440 series  
    accessories 24  
    menu 41  
    transporting 24  
    using handle 24  
HP Photosmart software  
    HP Photosmart Essential 16  
    HP Photosmart Mac 16  
    HP Photosmart Share 16  
    updating 22  
HP Software Update 22  
HP support 37

## I

ink cartridges. *See* print  
    cartridges  
ink level, checking 21  
ink, removing ink from skin and  
    clothing 18

## J

jams, paper  
    jams 31

## L

lights 6  
loading paper 9

## M

menu, HP Photosmart A440  
    series 41

## P

Paper  
    basics 9

    choosing right paper 9  
    loading 9  
paper  
    buying and choosing 9  
    loading 9  
    maintaining 9, 23  
    specifications 35  
    trays 4  
    troubleshooting 30  
passport photos 12  
phone support 37  
phone support period  
    period for support 37  
photo summary screen 7  
photos  
    improving quality 13  
    removing red eye 13  
    transferring to a  
        computer 16  
    viewing for print 12  
placing a call 38  
print cartridges  
    aligning 21  
    cleaning 19  
    cleaning contacts 20  
    storing 23  
    testing 21  
Print quality  
    setting 13  
printer  
    accessories 7  
    cleaning 19  
    documentation 3  
    error messages 33  
    parts 4  
    specifications 35  
    storing 23  
Printer menu  
    using 8  
printing  
    all photos 12  
    basics 11  
    borderless prints 12  
    from a computer 15  
    from computer 3  
    from other devices 15

- from PictBridge-certified camera 15
- new photos 12
- passport photos 12
- test page 21

## **Q**

- quality
  - photo paper 23
  - photos 13
  - printing test page 21
  - troubleshooting 32
- Questions and Answers 27

## **R**

- Red Eye 13
- removing ink from skin and clothing 18

## **S**

- specifications 35
- storing
  - photo paper 23
  - print cartridges 23
  - printer 23
- support process 37
- system requirements 35

## **T**

- test page 21
- transporting HP Photosmart A440 series 24
- transporting printer 7
- trays, paper 4
- Troubleshooting 27
- troubleshooting
  - error messages 33
  - flashing lights 27
  - HP support 37
  - paper problems 30
  - quality problems 32

## **U**

- USB
  - port 4
  - specifications 35





www.hp.com/support

Africa (English speaking)	+27 11 2345872	
Afrique (francophone)	+33 1 4993 9230	
	021 67 22 80	الجزائر
Argentina (Buenos Aires)	54-11-4708-1600	
Argentina	0-800-555-5000	
Australia	www.hp.com/support/australia	
Österreich	www.hp.com/support	
	17212049	البحرين
België	www.hp.com/support	
Belgique	www.hp.com/support	
Brasil (Sao Paulo)	55-11-4004-7751	
Brasil	0-800-709-7751	
Canada	1-(800)-474-6836 (1-800 hp invent)	
Central America & The Caribbean	www.hp.com/support	
Chile	800-360-999	
中国	www.hp.com/support/china	
Colombia (Bogotá)	571-606-9191	
Colombia	01-8000-51-4746-8368	
Costa Rica	0-800-011-1046	
Česká republika	810 222 222	
Danmark	www.hp.com/support	
Ecuador (Andinatel)	1-999-119 ☎ 800-711-2884	
Ecuador (Pacifitel)	1-800-225-528 ☎ 800-711-2884	
	(02) 6910602	مصر
El Salvador	800-6160	
España	www.hp.com/support	
France	www.hp.com/support	
Deutschland	www.hp.com/support	
Ελλάδα (από το εξωτερικό)	+ 30 210 6073603	
Ελλάδα (εντός Ελλάδας)	801 11 75400	
Ελλάδα (από Κύπρο)	800 9 2654	
Guatemala	1-800-711-2884	
香港特別行政區	www.hp.com/support/hongkong	
Magyarország	06 40 200 629	
India	www.hp.com/support/india	
Indonesia	www.hp.com/support	
	+971 4 224 9189	العراق
	+971 4 224 9189	الكويت
	+971 4 224 9189	لبنان
	+971 4 224 9189	قطر
	+971 4 224 9189	اليمن
Ireland	www.hp.com/support	
	1-700-503-048	ישראל
Italia	www.hp.com/support	
Jamaica	1-800-711-2884	

日本	www.hp.com/support/japan	
	0800 222 47	الأردن
한국	www.hp.com/support/korea	
Luxembourg	www.hp.com/support	
Malaysia	www.hp.com/support	
Mauritius	(262) 262 210 404	
México (Ciudad de México)	55-5258-9922	
México	01-800-472-68368	
	081 005 010	المغرب
Nederland	www.hp.com/support	
New Zealand	www.hp.com/support	
Nigeria	(01) 271 2320	
Norge	www.hp.com/support	
	24791773	عمان
Panamá	1-800-711-2884	
Paraguay	009 800 54 1 0006	
Perú	0-800-10111	
Philippines	www.hp.com/support	
Polska	0801 800 235	
Portugal	www.hp.com/support	
Puerto Rico	1-877-232-0589	
República Dominicana	1-800-711-2884	
Reunion	0820 890 323	
România	0801 033 390	
Россия (Москва)	+7 495 7773284	
Россия (Санкт-Петербург)	+7 812 3324240	
	800 897 1415	السعودية
Singapore	www.hp.com/support/singapore	
Slovensko	0850 111 256	
South Africa (RSA)	0860 104 771	
Suomi	www.hp.com/support	
Sverige	www.hp.com/support	
Switzerland	www.hp.com/support	
臺灣	www.hp.com/support/taiwan	
ໄທ	www.hp.com/support	
	071 891 391	تونس
Trinidad & Tobago	1-800-711-2884	
Türkiye	+90 (212)291 38 65	
Україна	(044) 230-51-06	
	600 54 47 47	الإمارات العربية المتحدة
United Kingdom	www.hp.com/support	
United States	1-(800)-474-6836 (1-800 hp invent)	
Uruguay	0004-054-177	
Venezuela (Caracas)	58-212-278-8666	
Venezuela	0-800-474-68368	
Việt Nam	www.hp.com/support	

**Print Cartridge Selection Number**



**Tri-color**

**110**

© 2007 Hewlett-Packard Development Company, L.P.

Printed in [country] - English

[www.hp.com](http://www.hp.com)



EN



Q8506-90951

## Free Manuals Download Website

<http://myh66.com>

<http://usermanuals.us>

<http://www.somanuals.com>

<http://www.4manuals.cc>

<http://www.manual-lib.com>

<http://www.404manual.com>

<http://www.luxmanual.com>

<http://aubethermostatmanual.com>

Golf course search by state

<http://golfingnear.com>

Email search by domain

<http://emailbydomain.com>

Auto manuals search

<http://auto.somanuals.com>

TV manuals search

<http://tv.somanuals.com>