

OWNER'S MANUAL 2021

701 Supermoto

Art. no. 3402465en



Husqvarna[®]
MOTORCYCLES

DEAR HUSQVARNA MOTORCYCLES CUSTOMER

Congratulations on your decision to purchase a Husqvarna motorcycle. You are now the owner of a state-of-the-art sports vehicle which, with appropriate care, will bring you pleasure for a long time to come.

We wish you good and safe riding at all times!

Enter the serial numbers of your vehicle below.

Vehicle identification number (📖 p. 24)	Dealer's stamp
Engine number (📖 p. 26)	
Key number (📖 p. 26)	

The Owner's Manual contained the latest information for this model series at the time of publication. However, minor differences due to further developments in design cannot be ruled out completely.

All specifications contained herein are non-binding. Husqvarna Motorcycles GmbH specifically reserves the right to modify or delete technical specifications, prices, colors, forms, materials, services, designs, equipment, etc., without prior notice and without specifying reasons, to adapt these to local conditions, as well as to stop production of a particular model without prior notice. Husqvarna Motorcycles accepts no liability for delivery options, deviations from illustrations and descriptions, as well as misprints and other errors. The models portrayed partly contain special equipment that does not belong to the regular scope of supply.



3402465en

02/2021

DEAR HUSQVARNA MOTORCYCLES CUSTOMER

© 2021 Husqvarna Motorcycles GmbH, Mattighofen Austria

All rights reserved

Reproduction, even in part, as well as copying of all kinds, is permitted only with the express written permission of the copyright owner.



ISO 9001(12 100 6061)

Husqvarna Motorcycles applies quality assurance processes that lead to the highest possible product quality as defined in the ISO 9001 international quality management standard.

Issued by: TÜV-Management Service

REG.NO. 12 100 6061

Husqvarna Motorcycles GmbH
Stallhofnerstraße 3
5230 Mattighofen, Austria

This document is valid for the following models:

701 SUPERMOTO EU (F2603U3)

TABLE OF CONTENTS

1	MEANS OF REPRESENTATION.....	9	4	VIEW OF VEHICLE	20	
	1.1	Symbols used	9	4.1	View of vehicle, front left (example)	20
	1.2	Formats used	10	4.2	View of vehicle, rear right (example).....	22
2	SAFETY ADVICE	11	5	SERIAL NUMBERS.....	24	
	2.1	Use definition – intended use	11	5.1	Vehicle identification number.....	24
	2.2	Misuse.....	11	5.2	Type label.....	25
	2.3	Safety advice	11	5.3	Key number.....	26
	2.4	Degrees of risk and symbols	12	5.4	Engine number.....	26
	2.5	Tampering warning	13	5.5	Fork part number	27
	2.6	Safe operation.....	14	5.6	Shock absorber article number	27
	2.7	Protective clothing.....	15	6	CONTROLS	28
	2.8	Work rules.....	15	6.1	Clutch lever	28
	2.9	Environment.....	16	6.2	Hand brake lever.....	28
	2.10	Owner's Manual.....	16	6.3	Throttle grip.....	29
3	IMPORTANT NOTES	18	6.4	Horn button.....	29	
	3.1	Manufacturer warranty, implied warranty	18	6.5	Light switch.....	30
	3.2	Fuel, auxiliary substances.....	18	6.6	Turn signal switch	30
	3.3	Spare parts, accessories	18	6.7	Emergency OFF switch.....	31
	3.4	Service	19	6.8	Start button.....	32
	3.5	Figures	19	6.9	Combination switch	32
	3.6	Customer service.....	19	6.10	Ignition and steering lock.....	34

TABLE OF CONTENTS

6.11	Overview of indicator lights	35	7.15	Service interval display	54
6.12	Seat release	37	7.16	Tachometer	55
6.13	Grab handles	37	7.17	Odometer	56
6.14	Passenger foot pegs	38	7.18	Gear display	57
6.15	Shift lever	38	7.19	Service display	57
6.16	Foot brake lever	39	7.20	Distance fuel reserve	58
6.17	Side stand	40	8	PREPARING FOR USE	59
6.18	Opening fuel tank filler cap	41	8.1	Advice on preparing for first use	59
6.19	Closing the fuel tank filler cap	43	8.2	Running in the engine	61
7	DASH	44	8.3	Loading the vehicle	62
7.1	Overview	44	9	RIDING INSTRUCTIONS	65
7.2	Activation and test	44	9.1	Checks and maintenance measures when preparing for use	65
7.3	Setting the combination instrument ...	45	9.2	Starting the vehicle	66
7.4	Setting kilometers or miles	46	9.3	Starting off	68
7.5	Setting the clock	47	9.4	Shifting, riding	68
7.6	Setting the service interval	48	9.5	Easy Shift	74
7.7	Distance 1	49	9.6	Motorcycle traction control	75
7.8	Distance 2	50	9.7	Braking	76
7.9	Average speed 1	51	9.8	Stopping, parking	78
7.10	Average speed 2	51	9.9	Transport	80
7.11	Riding time 1	52	9.10	Refueling	81
7.12	Riding time 2	53			
7.13	Service hour counter	53			
7.14	Clock	54			















10	SERVICE SCHEDULE.....	84	12	SERVICE WORK ON THE CHASSIS	100
10.1	Additional information.....	84	12.1	Raising the motorcycle with a lift stand	100
10.2	Required work.....	84	12.2	Removing the motorcycle from the lift stand	100
10.3	Recommended work.....	87	12.3	Raising the motorcycle with the rear lifting gear	101
11	TUNING THE CHASSIS.....	88	12.4	Removing the rear of the motorcycle from the wheel stand	102
11.1	Fork/shock absorber.....	88	12.5	Lifting the motorcycle with the front lifting gear.....	103
11.2	Adjusting the compression damping of the fork.....	88	12.6	Taking the motorcycle off the front lifting gear	104
11.3	Adjusting the rebound damping of the fork.....	90	12.7	Cleaning the dust boots of the fork legs	105
11.4	Compression damping of the shock absorber.....	91	12.8	Removing the fork protector.....	107
11.5	Adjusting the low-speed compression damping of the shock absorber.....	92	12.9	Installing the fork protector.....	107
11.6	Adjusting the high-speed compression damping of the shock absorber.....	93	12.10	Bleeding the fork legs	108
11.7	Adjusting the rebound damping of the shock absorber.....	95	12.11	Removing the seat	109
11.8	Handlebar position.....	96	12.12	Mounting the seat	109
11.9	Adjusting the handlebar position 	97	12.13	Removing the tool set.....	110
			12.14	Storing tool set.....	111
			12.15	Take off the side cover	112
			12.16	Mounting the side cover	113
			12.17	Removing front fender	113

TABLE OF CONTENTS

12.18	Installing front fender	114	13.7	Checking the free travel of foot brake lever	144
12.19	Removing the air filter 	115	13.8	Adjusting the basic position of the foot brake lever 	145
12.20	Installing the air filter 	116	13.9	Checking the rear brake fluid level ...	147
12.21	Checking the chain for dirt.....	117	13.10	Adding rear brake fluid 	148
12.22	Cleaning the chain	118	13.11	Checking the rear brake linings	150
12.23	Checking the chain tension	120	14	WHEELS, TIRES	152
12.24	Adjusting the chain tension.....	122	14.1	Removing the front wheel 	152
12.25	Checking the chain, rear sprocket, engine sprocket, and chain guide.....	124	14.2	Installing the front wheel 	154
12.26	Adjusting the chain guide 	129	14.3	Removing the rear wheel 	157
12.27	Adjusting the basic position of the clutch lever.....	130	14.4	Installing the rear wheel 	159
12.28	Checking/correcting the fluid level of the hydraulic clutch	131	14.5	Checking the rear hub damping rubber pieces 	163
13	BRAKE SYSTEM	134	14.6	Checking the tire condition.....	165
13.1	Anti-lock braking system (ABS)	134	14.7	Tubeless tire system	168
13.2	Adjusting the basic position of the hand brake lever	137	14.8	Checking tire pressure	169
13.3	Checking the brake discs	138	14.9	Checking spoke tension	170
13.4	Checking the front brake fluid level.....	139	14.10	Using tire repair spray.....	172
13.5	Adding front brake fluid 	140	15	ELECTRICAL SYSTEM.....	173
13.6	Checking the front brake linings	143	15.1	Removing the 12-V battery 	173
			15.2	Installing the 12-V battery 	175
			15.3	Charging the 12-V battery 	177







15.4	Changing the main fuse.....	179	17	TUNING THE ENGINE.....	208
15.5	Changing the ABS fuses.....	182	17.1	Changing the riding mode	208
15.6	Changing the fuses of individual electrical power consumers.....	184	17.2	Adjusting traction control.....	209
15.7	Removing the headlight mask with the headlight	187	17.3	Checking the basic position of the shift lever.....	210
15.8	Installing the headlight mask with the headlight	188	17.4	Adjusting the basic position of the shift lever 	211
15.9	Changing the headlight bulb.....	189	18	SERVICE WORK ON THE ENGINE	212
15.10	Changing the parking light bulb.....	191	18.1	Changing the fuel screen 	212
15.11	Checking the headlight setting	192	18.2	Checking the engine oil level	214
15.12	Adjusting the headlight range	193	18.3	Changing the engine oil and oil filter, cleaning the oil screens 	215
15.13	ACC1 and ACC2.....	194	18.4	Adding engine oil	223
15.14	Diagnostics connector.....	194	19	CLEANING, CARE.....	226
16	COOLING SYSTEM.....	195	19.1	Cleaning the motorcycle.....	226
16.1	Cooling system	195	19.2	Checks and maintenance steps for winter operation.....	229
16.2	Checking the antifreeze and coolant level.....	196	20	STORAGE.....	231
16.3	Checking the coolant level.....	198	20.1	Storage	231
16.4	Draining the coolant 	200	20.2	Preparing for use after storage.....	234
16.5	Filling/bleeding the cooling system 	201	21	TROUBLESHOOTING	235
16.6	Changing the coolant 	204			

TABLE OF CONTENTS

22	TECHNICAL DATA	239	28.3	Green and blue symbols.....	269
22.1	Engine	239	INDEX		270
22.2	Engine tightening torques.....	241			
22.3	Capacities	246			
22.3.1	Engine oil.....	246			
22.3.2	Coolant.....	247			
22.3.3	Fuel.....	247			
22.4	Chassis	247			
22.5	Electrical system.....	249			
22.6	Tires	250			
22.7	Fork.....	250			
22.8	Shock absorber	251			
22.9	Chassis tightening torques	253			
23	SUBSTANCES.....	260			
24	AUXILIARY SUBSTANCES.....	263			
25	STANDARDS	265			
26	INDEX OF SPECIAL TERMS	266			
27	LIST OF ABBREVIATIONS	267			
28	LIST OF SYMBOLS	268			
28.1	Red symbols	268			
28.2	Yellow and orange symbols.....	268			

1.1 Symbols used

The meaning of specific symbols is described below.



Indicates an expected reaction (e.g. of a work step or a function).



Indicates an unexpected reaction (e.g. of a work step or a function).



All work marked with this symbol requires specialist knowledge and technical understanding. In the interests of your own safety, have these jobs performed by an authorized Husqvarna Motorcycles workshop. There, your motorcycle will be optimally cared for by specially trained experts using the specialist tools required.



Indicates a page reference (more information is provided on the specified page).



Indicates information with more details or tips.



Indicates the result of a testing step.

1 MEANS OF REPRESENTATION

V

Indicates a voltage measurement.

A

Indicates a current measurement.



Indicates the end of an activity, including potential rework.

1.2 Formats used

The typographical formats used in this document are explained below.

Proprietary name

Indicates a proprietary name.

Name®

Indicates a protected name.

Brand™

Indicates a brand available on the open market.

Underlined terms

Refer to technical details of the vehicle or indicate technical terms, which are explained in the glossary.

2.1 Use definition – intended use

This vehicle has been designed and built to withstand the normal stresses and strains of road use. This vehicle is not suitable for use on race tracks or offroad.



Info

This vehicle is only authorized for operation on public roads in its homologated version.

2.2 Misuse

The vehicle must only be used as intended.

Dangers can arise for people, property and the environment through use not as intended.

Any use of the vehicle beyond the intended and defined use constitutes misuse.

Misuse also includes the use of operating and auxiliary fluids which do not meet the required specification for the respective use.

2.3 Safety advice

A number of safety instructions need to be followed to operate the product described safely. Therefore read this instruction and all further instructions included carefully. The safety instructions are highlighted in the text and are referred to at the relevant passages.

2 SAFETY ADVICE



Info

Various information and warning labels are attached in prominent locations on the product described. Do not remove any information or warning labels. If they are missing, you or others may not recognize dangers and may therefore be injured.

2.4 Degrees of risk and symbols



Danger

Identifies a danger that will immediately and invariably lead to fatal or serious permanent injury if the appropriate measures are not taken.



Warning

Identifies a danger that is likely to lead to fatal or serious injury if the appropriate measures are not taken.



Caution

Identifies a danger that may lead to minor injuries if the appropriate measures are not taken.

Note

Identifies a danger that will lead to considerable machine and material damage if the appropriate measures are not taken.



Note

Indicates a danger that will lead to environmental damage if the appropriate measures are not taken.

2.5 Tampering warning

Tampering with the noise control system is prohibited. Federal law prohibits the following acts or the causing thereof:

- 1 The removal or rendering inoperative by any person other than for purposes of servicing, repair, or replacement, of any device or element of design incorporated into any new vehicle for the purpose of noise control prior to its sale or delivery to the ultimate purchaser or while it is in use, or
- 2 the use of the vehicle after such device or element of design has been removed or rendered inoperative by any person.

Among those acts presumed to constitute tampering are the acts listed below:

- 1 Removal or puncturing of the main silencers, baffles, header pipes or any other components which conduct exhaust gases.
- 2 Removal or puncturing of parts of the intake system.
- 3 Lack of proper maintenance.
- 4 Replacing moving parts of the vehicle, or parts of the exhaust system or intake system, with parts other than those specified by the manufacturer.

2.6 Safe operation



Danger

Danger of accidents A rider who is not fit to ride poses a danger to him or herself and others.

- Do not operate the vehicle if you are not fit to ride due to alcohol, drugs or medication.
- Do not operate the vehicle if you are physically or mentally impaired.



Danger

Danger of poisoning Exhaust gases are toxic and inhaling them may result in unconsciousness and death.

- Always make sure there is sufficient ventilation when running the engine.
- Use effective exhaust extraction when starting or running the engine in an enclosed space.



Warning

Danger of burns Some vehicle components become very hot when the vehicle is operated.

- Do not touch any parts such as the exhaust system, radiator, engine, shock absorber, or brake system before the vehicle parts have cooled down.
- Let the vehicle parts cool down before you perform any work on the vehicle.

Only operate the vehicle when it is in perfect technical condition, in accordance with its intended use, and in a safe and environmentally compatible manner.

An appropriate driver's license is needed to ride the vehicle on public roads.

Have malfunctions that impair safety promptly eliminated by an authorized Husqvarna Motorcycles workshop.

Adhere to the information and warning labels on the vehicle.

2.7 Protective clothing



Warning

Risk of injury Missing or poor protective clothing presents an increased safety risk.

- Wear appropriate protective clothing such as helmet, boots, gloves as well as trousers and a jacket with protectors on all rides.
- Always wear protective clothing that is in good condition and meets the legal regulations.

In the interest of your own safety, Husqvarna Motorcycles recommends that you only operate the vehicle while wearing protective clothing.

2.8 Work rules

Unless specified otherwise, the ignition must be turned off during all work (models with ignition lock, models with remote key) or the engine must be at a standstill (models without ignition lock or remote key).

Special tools are necessary for certain tasks. The tools are not a component of the vehicle, but can be ordered using the number in parentheses. Example: bearing puller (15112017000)

During assembly, use new parts to replace parts which cannot be reused (e.g. self-locking screws and nuts, expansion screws, seals, sealing rings, O-rings, pins, and lock washers).

In the case of certain screws, a screw adhesive (e.g. **Loctite**[®]) is required. Observe the manufacturer's instructions.

If thread locker (e.g., **Precote**[®]) has already been applied to a new part, do not apply any additional thread locker.

After disassembly, clean the parts that are to be reused and check them for damage and wear. Change damaged or worn parts.

After completing a repair or service work, check the operating safety of the vehicle.

2.9 Environment

If you use your motorcycle responsibly, you can ensure that problems and conflicts do not occur. To protect the future of the motorcycle sport, make sure that you use your motorcycle legally, display environmental consciousness, and respect the rights of others.

When disposing of used oil, other operating and auxiliary fluids, and used components, comply with the laws and regulations of the respective country.

Because motorcycles are not subject to the EU regulations governing the disposal of used vehicles, there are no legal regulations that pertain to the disposal of an end-of-life motorcycle. Your authorized Husqvarna Motorcycles dealer will be glad to advise you.

2.10 Owner's Manual

It is important that you read this Owner's Manual carefully and completely before making your first trip. The Owner's Manual contains useful information and many tips on how to operate, handle, and service your motorcycle. This is the only way to find out how best to customize the vehicle for your own use and how you can protect yourself from injury.

Info

Store the Owner's Manual on your terminal device, for example, so that you can read it whenever you need to.

If you would like to know more about the vehicle or have questions on the material you read, please contact an authorized Husqvarna Motorcycles dealer.

The Owner's Manual is an important component of the vehicle. If the vehicle is sold, the Owner's Manual must be downloaded again by the new owner.

The Owner's Manual can be downloaded several times using the QR code or the link on the delivery certificate.

The Owner's Manual is also available for download from your authorized Husqvarna Motorcycles dealer and on the Husqvarna Motorcycles website. A printed copy can also be ordered from your authorized Husqvarna Motorcycles dealer.

International Husqvarna Motorcycles website: www.husqvarna-motorcycles.com

3 IMPORTANT NOTES

3.1 Manufacturer warranty, implied warranty

The work prescribed in the service schedule must only be carried out in an authorized Husqvarna Motorcycles workshop and confirmed in the **Husqvarna Motorcycles Dealer.net**, as otherwise all warranty claims will be void. Damage or secondary damage caused by tampering with and/or conversions on the vehicle are not covered by the manufacturer warranty.

3.2 Fuel, auxiliary substances



Note

Environmental hazard Improper handling of fuel is a danger to the environment.

- Do not allow fuel to enter the groundwater, the soil, or the sewage system.

Use fuels and auxiliary substances in accordance with the Owner's Manual and specification.

3.3 Spare parts, accessories

For your own safety, only use spare parts and accessory products that are approved and/or recommended by Husqvarna Motorcycles and have them installed by an authorized Husqvarna Motorcycles workshop. Husqvarna Motorcycles accepts no liability for other products and any resulting damage or loss. Certain spare parts and accessory products are specified in parentheses in the descriptions. Your authorized Husqvarna Motorcycles dealer will be glad to advise you.

The current **Husqvarna Motorcycles Technische Zubehör** for your vehicle can be found on the Husqvarna Motorcycles website.

International Husqvarna Motorcycles website: www.husqvarna-motorcycles.com

3.4 Service

A prerequisite for perfect operation and prevention of premature wear is that the service, care, and tuning work on the engine and chassis is properly carried out as described in the Owner's Manual. An incorrect suspension setting can lead to damage and breakage of chassis components.

Use of the vehicle under difficult conditions, such as dusty environments, heavy rain, high heat or with a heavy load, can lead to considerably more rapid wear of components such as the air filter, drive train, brake system, or suspension components. For this reason, it may be necessary to inspect or replace parts before the next scheduled service.

It is imperative that you adhere to the stipulated run-in times and service intervals. If you observe these exactly, you will ensure a much longer service life for your motorcycle.

The relevant mileage or time interval is whichever occurs first.

3.5 Figures

The figures contained in the manual may depict special equipment.

In the interest of clarity, some components may be shown disassembled or may not be shown at all. It is not always necessary to disassemble the component to perform the activity in question. Please follow the instructions in the text.

3.6 Customer service

Your authorized Husqvarna Motorcycles dealer will be happy to answer any questions you may have regarding your vehicle and Husqvarna Motorcycles.

A list of authorized Husqvarna Motorcycles dealers can be found on the Husqvarna Motorcycles website. International Husqvarna Motorcycles website: www.husqvarna-motorcycles.com

4 VIEW OF VEHICLE

4.1 View of vehicle, front left (example)



- ① Clutch lever (📖 p. 28)
- ② Fuel tank filler cap
- ③ Grab handles (📖 p. 37)
- ④ Passenger foot pegs (📖 p. 38)
- ⑤ Side stand (📖 p. 40)
- ⑥ Seat release (📖 p. 37)
- ⑦ Shift lever (📖 p. 38)

4 VIEW OF VEHICLE

4.2 View of vehicle, rear right (example)

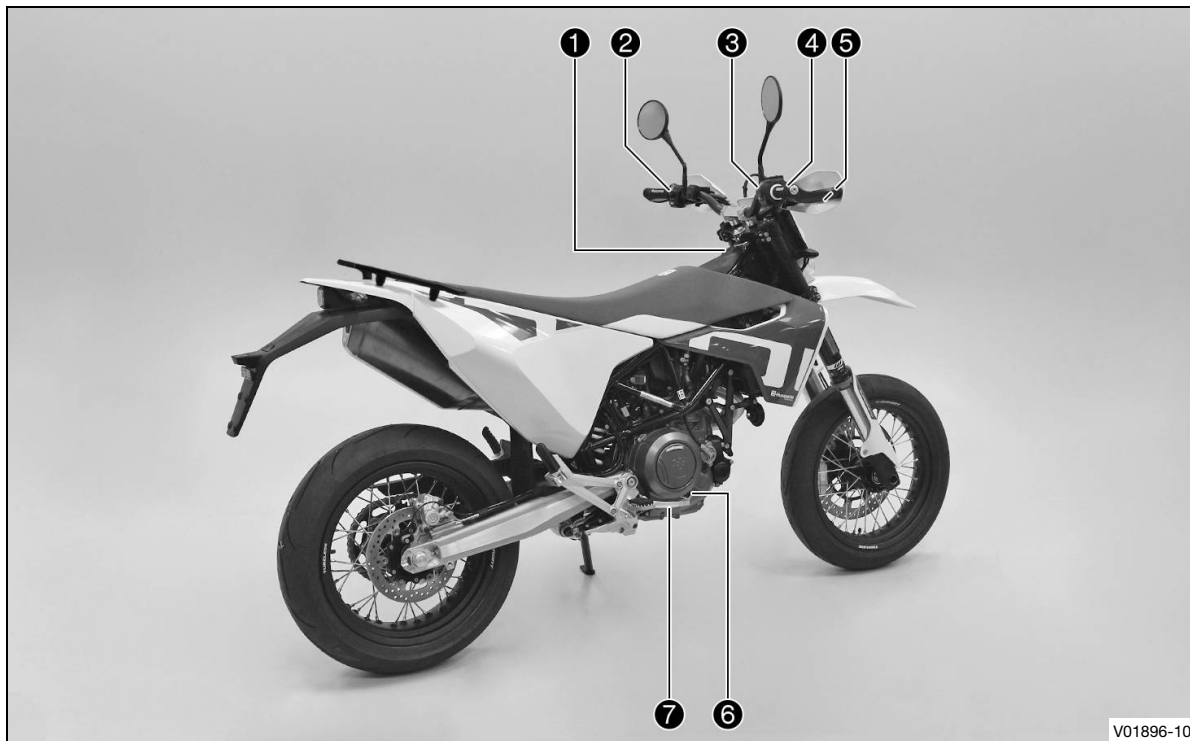

- ① Ignition and steering lock (📖 p. 34)
- ② Horn button (📖 p. 29)
- ② Turn signal switch (📖 p. 30)
- ② Light switch (📖 p. 30)
- ③ Start button (📖 p. 32)
- ③ Emergency OFF switch (📖 p. 31)
- ④ Throttle grip (📖 p. 29)
- ⑤ Hand brake lever (📖 p. 28)
- ⑥ Level viewer, engine oil
- ⑦ Foot brake lever (📖 p. 39)

5 SERIAL NUMBERS

5.1 Vehicle identification number

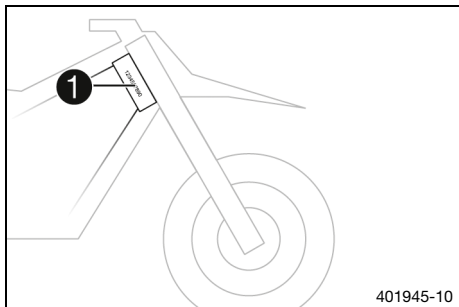

The vehicle identification number **1** is stamped on the right side of the steering head.

5.2 Type label

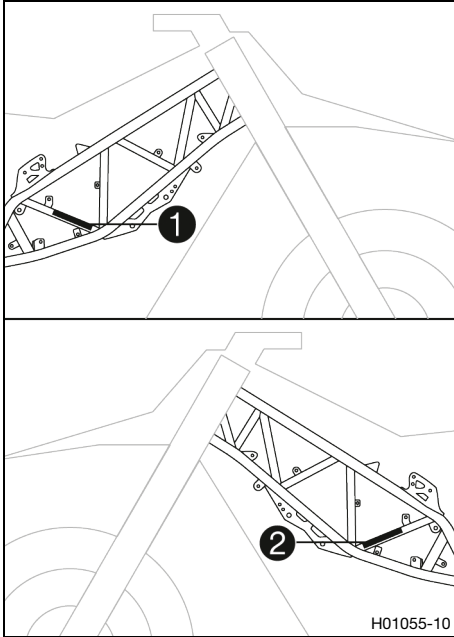

The Europe type label **1** is located on the right side of the frame.

The Australia type label **2** is located on the left side of the frame.

5 SERIAL NUMBERS

5.3 Key number

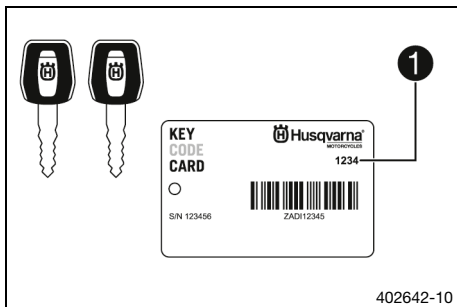

The key number **1** can be found on the **KEYCODECARD**.

i Info

You need the key number to order a spare key. Keep the **KEYCODECARD** in a safe place.

5.4 Engine number

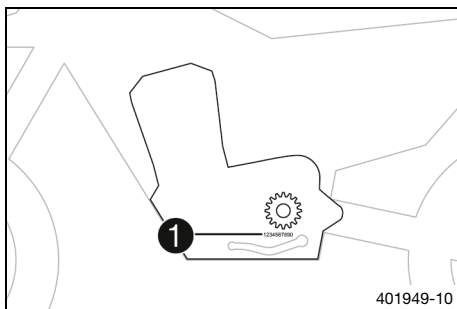

The engine number **1** is stamped on the left side of the engine under the engine sprocket.

5.5 Fork part number

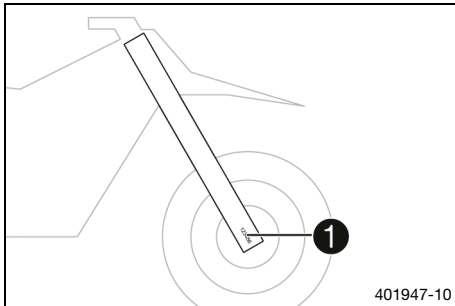

The fork part number **1** is stamped on the inner side of the fork stub.

5.6 Shock absorber article number

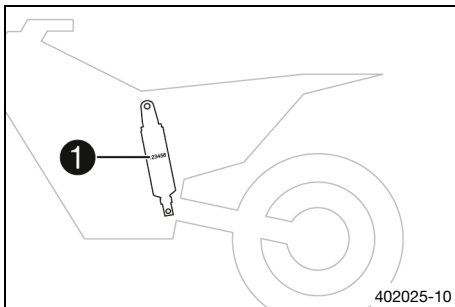

The shock absorber article number **1** is on the left side of the shock absorber.

6 CONTROLS

6.1 Clutch lever

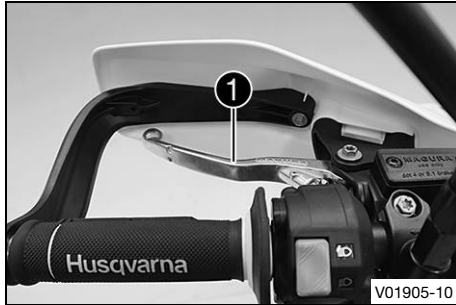

Clutch lever **1** is fitted on the handlebar on the left. The clutch is activated hydraulically and adjusts itself automatically.

6.2 Hand brake lever



The hand brake lever **1** is fitted on the right side of the handlebar. The hand brake lever operates the front brake.

6.3 Throttle grip





The throttle grip ❶ is fitted on the right side of the handlebar.

6.4 Horn button



Horn button ❶ is fitted on the left side of the handlebar.

Possible states

- The horn button  is in the basic position
- The horn button  is pressed – The horn is operated in this position.



6 CONTROLS

6.5 Light switch



The light switch **1** is fitted on the left side of the handlebar.

Possible states



	Low beam on – Light switch is turned downwards. In this position, the low beam and tail light are switched on.
	High beam on – Light switch is turned upwards. In this position, the high beam and the tail light are switched on.

6.6 Turn signal switch



The turn signal switch **1** is fitted on the left side of the handlebar.

Possible states

	Turn signal off
	Left turn signal on – Turn signal switch pressed to the left. The turn signal switch returns to the center position after activation.
	Right turn signal on – Turn signal switch pressed to the right. The turn signal switch returns to the center position after activation.

To switch off the turn signal, press the turn signal switch towards the switch housing.

6.7 Emergency OFF switch



The emergency OFF switch ① is fitted on the right side of the handlebar.

Possible states

	<p>Emergency OFF switch off – In this position, the ignition circuit is interrupted, a running engine stops, and the engine cannot be started.</p>
	<p>Emergency OFF switch on – This position is necessary for operation as the ignition circuit is closed.</p>

6 CONTROLS

6.8 Start button



Start button **1** is fitted on the right side of the handlebar.

Possible states

- The start button **1** is in the basic position
- The start button **1** is pressed – In this position, the starter motor is actuated.

6.9 Combination switch

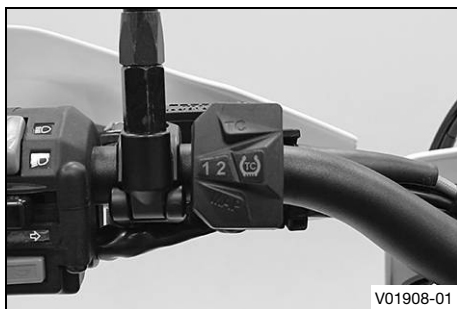

The combination switch is fitted on the left side of the handlebar.

Possible states

1	STREET – Riding mode STREET and traction control are activated when LED 1 lights up.
1TC	STREET without TC – When LEDs 1 and TC light up, riding mode STREET is active and traction control is deactivated.
2	SPORT – If LED 2 is lit up, riding mode SPORT , a subsequently active traction control and ABS mode Supermoto are activated.

2TC	SPORT without TC – If LEDs 2 and TC are lit up, riding mode SPORT and ABS mode Supersmoto are active. The traction control is deactivated.
------------	---

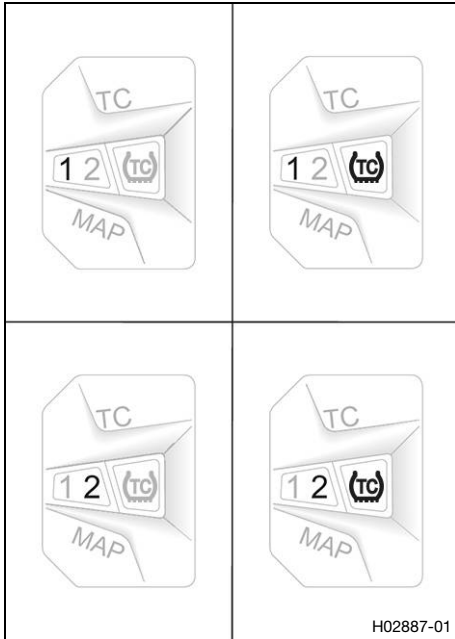

The combination switch displays the current riding mode and traction control setting.

Press button **MAP** on the combination switch to change the riding mode, the traction control and the ABS mode.

The traction control is activated or deactivated using button **TC** on the combination switch.

i Info

Each time the ignition is switched on, all three switch LEDs light up for a function check.

If all three LEDs light up during operation, an error has been detected by the engine control unit. Contact an authorized Husqvarna Motorcycles workshop immediately.

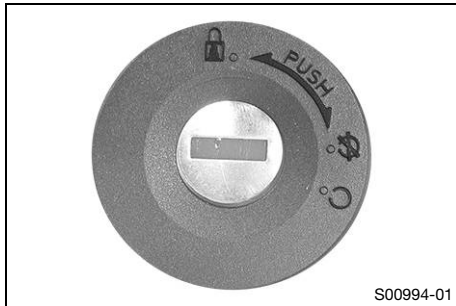

6 CONTROLS

6.10 Ignition and steering lock



The ignition and steering lock is located in front of the seat.



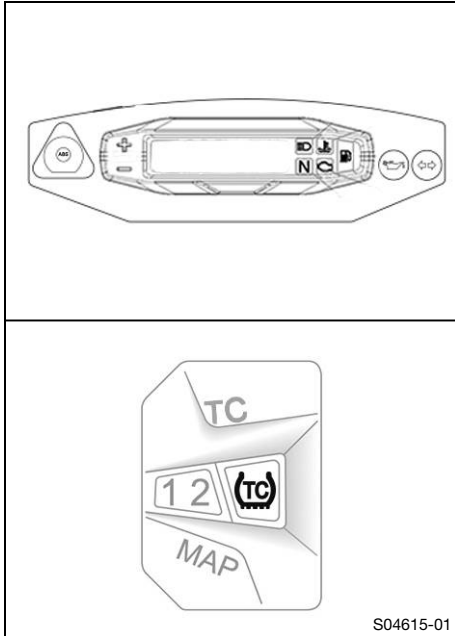

Possible states

	Ignition off OFF – In this position, the ignition circuit is interrupted, a running engine stops, and a non-running engine will not start. The ignition key can be removed.
	Ignition on ON – In this position, the ignition circuit is closed and the engine can be started.
	Steering locked – In this position, the ignition circuit is interrupted and the steering locked. The ignition key can be removed.





6.11 Overview of indicator lights



Possible states

	<p>ABS warning lamp lights up/flashes yellow – If the ABS warning lamp lights up, the ABS is not active. The ABS warning lamp also lights up if a malfunction is detected. Contact an authorized Husqvarna Motorcycles workshop. If the ABS warning lamp flashes slowly, ABS mode Supermoto is active.</p>
	<p>The high beam indicator lamp lights up blue – The high beam is switched on.</p>
	<p>Fuel level warning lamp lights up orange – The fuel level has reached the reserve mark.</p>
	<p>Malfunction indicator lamp lights up orange – The OBD has detected a malfunction in the vehicle electronics. Come safely to a halt, and contact an authorized Husqvarna Motorcycles workshop.</p>
	<p>The coolant temperature warning lamp lights up red – The coolant temperature has reached a critical value. Stop immediately (taking care not to endanger yourself or other road users in the process), switch off the engine, allow it to cool down and check the coolant level.</p>

6 CONTROLS

	The idle indicator lamp lights up green – The transmission is in neutral.
	Turn signal indicator lamp flashes green – The turn signal is switched on.
	The oil pressure warning lamp lights up red – The oil pressure is too low. Stop immediately, taking care not to endanger yourself or other road users in the process, and switch off the engine.
	TC indicator lamp lights up/flashes yellow – If the TC indicator light lights up, the <u>cornering MTC</u> (📖 p. 75) is not active. If the TC indicator light and both ride mode lamps light up at same time, a malfunction has been detected. Contact an authorized Husqvarna Motorcycles workshop. The TC indicator light flashes if the <u>cornering MTC</u> actively engages.

6.12 Seat release



The loop **1** unlocks the seat.

6.13 Grab handles

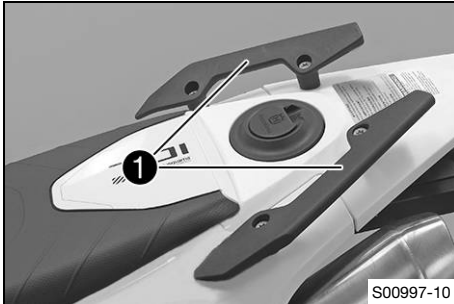

The grab handles **1** are used for moving the motorcycle around.

If you carry a passenger, the passenger can hold onto the grab handles during the trip.

6 CONTROLS

6.14 Passenger foot pegs

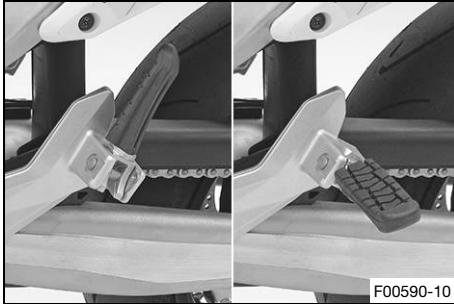

The passenger foot pegs can be folded up and down.

Possible states

- Passenger foot pegs folded up – For operation without a passenger.
- Passenger foot pegs folded down – For operation with a passenger.

6.15 Shift lever

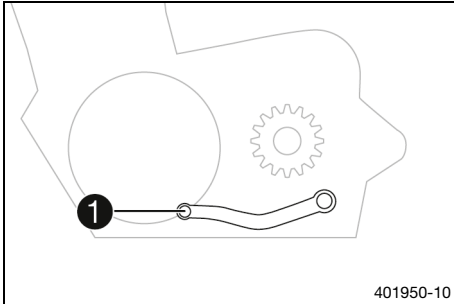

The shift lever **1** is mounted on the left side of the engine.

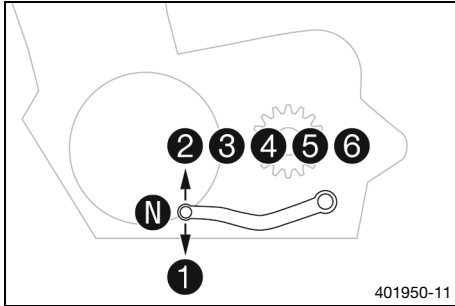

The gear positions can be seen in the photograph.
The neutral or idle position is between the first and second gears.

6.16 Foot brake lever

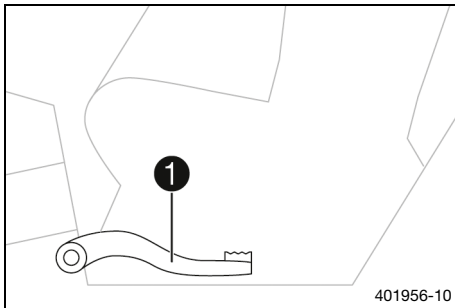

Foot brake lever **1** is located in front of the right footrest.
The rear brake is engaged with the foot brake lever.

6.17 Side stand

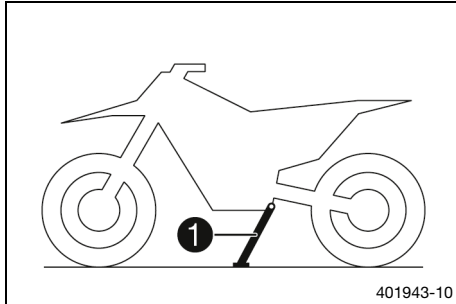

Side stand **1** is located on the left of the vehicle.
The side stand is used for parking the motorcycle.



Info

The side stand must be folded up during motorcycle use.
The side stand is coupled with the safety starting system
– see the riding instructions.

Possible states

- Side stand folded out – The vehicle can be supported on the side stand. The safety starting system is active.
- Side stand folded in – This position is mandatory when riding the motorcycle. The safety starting system is inactive.

6.18 Opening fuel tank filler cap



Danger

Fire hazard Fuel is highly flammable.

The fuel in the fuel tank expands when warm and can escape if overfilled.

- Do not fuel the vehicle in the vicinity of open flames or lit cigarettes.
- Switch off the engine for refueling.
- Make sure that no fuel is spilled; particularly not on hot parts of the vehicle.
- If any fuel is spilled, wipe it off immediately.
- Observe the specifications for refueling.



Warning

Danger of poisoning Fuel is poisonous and a health hazard.

- Avoid skin, eye and clothing contact with fuel.
- Immediately consult a doctor if you swallow fuel.
- Do not inhale fuel vapors.
- In case of skin contact, rinse the affected area with plenty of water.
- Rinse the eyes thoroughly with water, and consult a doctor in case of fuel contact with the eyes.
- Change your clothing in case of fuel spills on them.
- Keep fuels correctly in a suitable canister, and out of the reach of children.

6 CONTROLS



Note

Environmental hazard Improper handling of fuel is a danger to the environment.

- Do not allow fuel to enter the groundwater, the soil, or the sewage system.



- Lift cover **1** of fuel tank filler cap and insert the ignition key.
- Turn the ignition key 90° counterclockwise and take off the fuel tank filler cap.



Info

The fuel tank filler cap has a fuel tank breather.

6.19 Closing the fuel tank filler cap



- Put the fuel tank filler cap back on and turn the ignition key 90° clockwise.
- Remove the ignition key and fold down the cover.



7.1 Overview

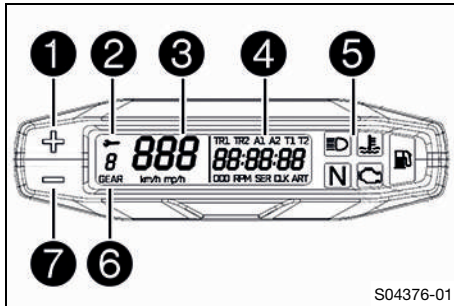

- ① + button
- ② Service display (📖 p. 57)
- ③ Speedometer
- ④ Display
- ⑤ Overview of indicator lights (📖 p. 35)
- ⑥ Gear display (📖 p. 57)
- ⑦ - button

7.2 Activation and test

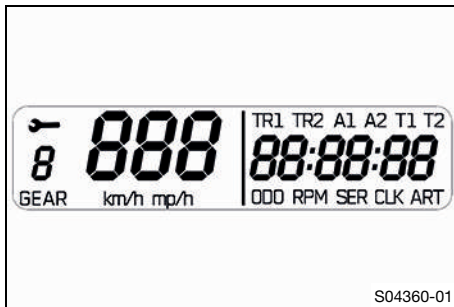

Activating combination instrument

The combination instrument is activated when the ignition is switched on.

Display test

To enable you to check that the display is functioning properly, all display segments light up briefly.

7.3 Setting the combination instrument

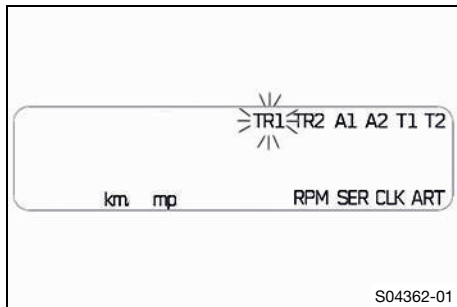
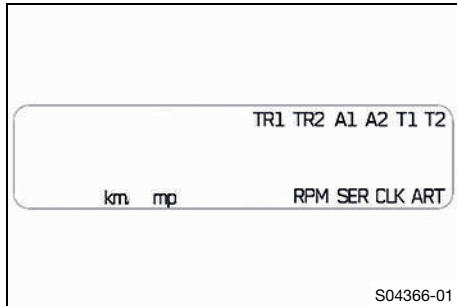

Condition

The motorcycle is stationary.

- Press and hold both buttons for 3 – 5 seconds.
- ✓ The Setup menu is displayed.



Info

In the setup menu, all the indicators can be activated and deactivated.

- Press the + button to select the desired indicator.
- Press the - button to activate or deactivate the selected indicator.



Info

An activated indicator flashes quickly.
A deactivated indicator flashes slowly.

- Press the + button repeatedly until the setup menu is closed.



Info

When the setup menu is closed, you can press the + or - button to switch between the activated indicators.

7.4 Setting kilometers or miles



Info

If the unit is changed, the value is retained and converted accordingly. Make the setting according to the country.

Condition

The motorcycle is stationary.

- Press and hold both buttons for 3 – 5 seconds.
 - ✓ The Setup menu is displayed.
- Press the + button repeatedly until **km** or **mp** flashes on the indicator.
- Press the - button to change from **km** to **mp** or from **mp** to **km**.
- Press the + button.
 - ✓ The settings made are adopted and the setup menu is closed.

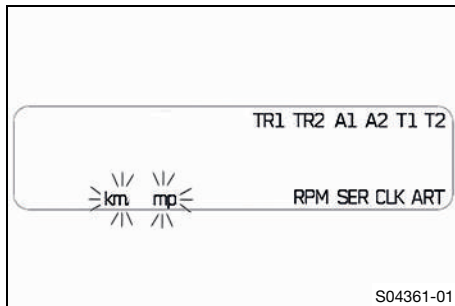

7.5 Setting the clock

Condition

The motorcycle is stationary.

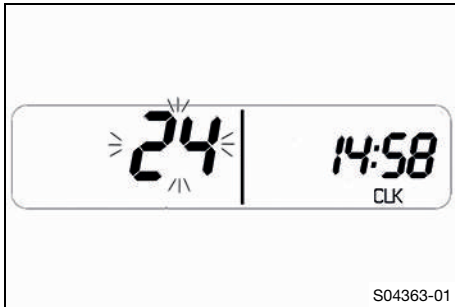

- Press the + or - button repeatedly until the indicator **CLK** appears in the combination instrument.
- Press and hold the - button for 3–5 seconds.
 - ✓ The combination instrument switches to the clock setting mode.
- Press the - button to select the 24 h display or 12 h display for the clock.
- Confirm the selection using the + button.
 - ✓ The setting is adopted and the combination instrument automatically changes to the next menu item.

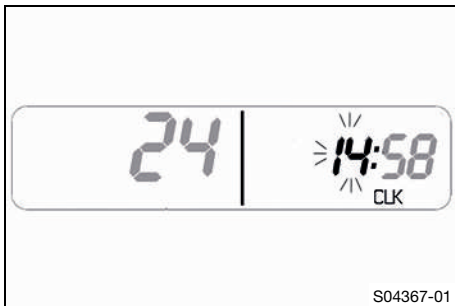

- Press the - button to set the hour.
- Confirm the selection using the + button.
 - ✓ The setting is adopted and the combination instrument automatically changes to the next menu item.
- Press the - button to set the minute.
- Confirm the selection using the + button.
 - ✓ The setting is adopted and the setting mode is closed.



7.6 Setting the service interval



Condition

The motorcycle is stationary.

- Press the + or - button repeatedly until **SER** is shown on the combination instrument.
- Press and hold the - button until the service interval display starts flashing.
- Press the - button repeatedly until the desired service interval is displayed.



Info

The indicator can be set within the range of 500 to 10,000.

- Press and hold the - button for 3–5 seconds until the indicator is no longer flashing.

7.7 Distance 1

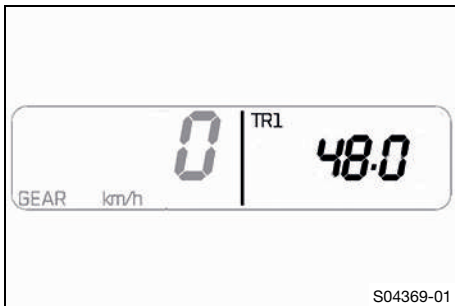



- Press the + or - button repeatedly until **TR1** is shown on the combination instrument.

TR1 shows distance 1 since the last reset, e.g., between two refueling stops.



Info

If the value of 9999.9 is exceeded, **TR1** is automatically reset to 0.0.

Briefly press the button  .	Next display mode
Briefly press the button  .	Next display mode
Press the button  for 2–3 seconds.	TR1 is reset to 0.0.

7.8 Distance 2

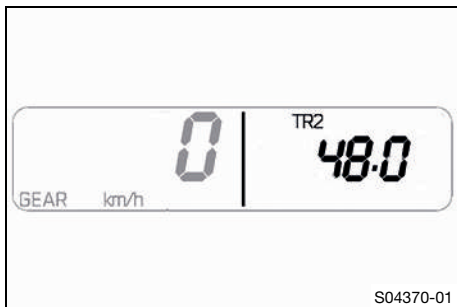

- Press the + or - button repeatedly until **TR2** is shown on the combination instrument.

TR2 shows distance 2 since the last reset, e.g., between two refueling stops.

i Info

If the value of 9999.9 is exceeded, **TR2** is automatically reset to 0.0.

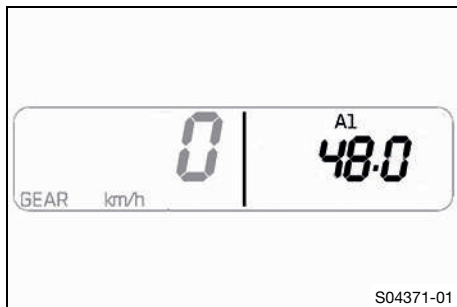

Briefly press the button + .	Next display mode
Briefly press the button - .	Next display mode
Press the button = for 2–3 seconds.	TR2 is reset to 0.0.

7.9 Average speed 1



- Press the + or - button repeatedly until **A1** is shown on the combination instrument.

A1 shows average speed 1 since the last reset.

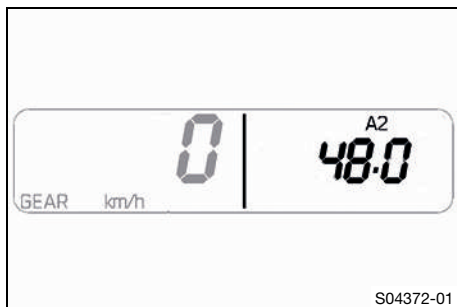

Briefly press the button  .	Next display mode
Briefly press the button  .	Next display mode
Press the button  for 2–3 seconds.	A1 is reset to 0.0.

7.10 Average speed 2



- Press the + or - button repeatedly until **A2** is shown on the combination instrument.

A2 shows average speed 2 since the last reset.

Briefly press the button  .	Next display mode
Briefly press the button  .	Next display mode

Press the button  for 2–3 seconds.

A2 is reset to 0.0.

7.11 Riding time 1



- Press the + or - button repeatedly until **T1** is shown on the combination instrument.

T1 shows riding time 1 since the last reset.

Briefly press the button .

Next display mode

Briefly press the button .

Next display mode

Press the button  for 2–3 seconds.

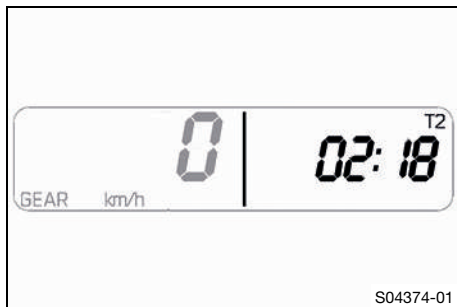

T1 is reset to 0.0.

7.12 Riding time 2



- Press the + or - button repeatedly until **T2** is shown on the combination instrument.

T2 shows riding time 2 since the last reset.

Briefly press the button  .	Next display mode
Briefly press the button  .	Next display mode
Press the button  for 2–3 seconds.	T2 is reset to 0.0.

7.13 Service hour counter

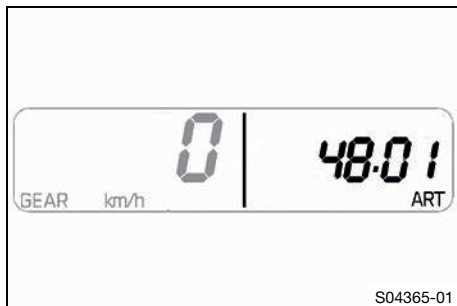

- Press the + or - button repeatedly until **ART** is shown on the combination instrument.

ART shows the motorcycle's operating hours

7.14 Clock

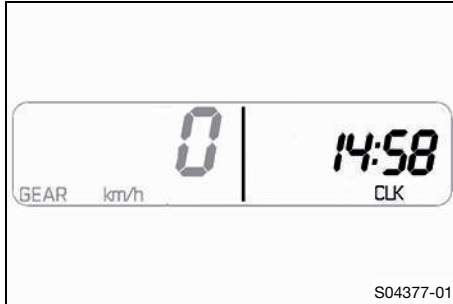

- Press the + or - button repeatedly until **CLK** is shown on the combination instrument.

CLK shows the time.

7.15 Service interval display

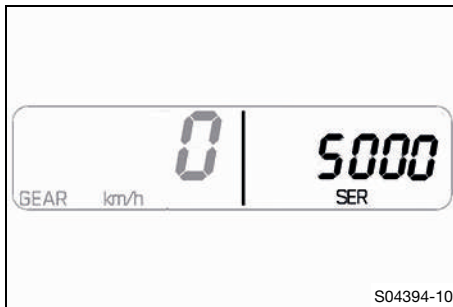

- Press the + or - button repeatedly until **SER** is shown on the combination instrument.
- SER** shows the remaining kilometers until the next service is due.

7.16 Tachometer

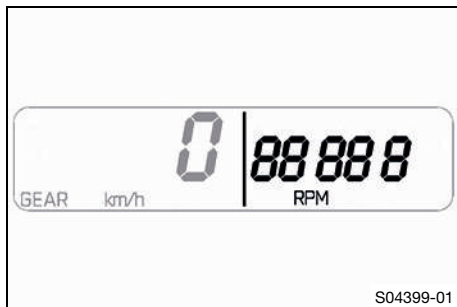

- Press the + or - button repeatedly until **RPM** is shown on the combination instrument.

Guideline

Speed per symbol approx.	
8	1,000 rpm
88	3,000 rpm
888	4,000 rpm
8888	5,000 rpm
88888	7,000 rpm
888888	9,000 rpm

RPM shows the current engine speed.



Info

Before the first service, the tachometer always flashes with a slow frequency (5 Hz) when the engine speed reaches 6500 rpm.

The tachometer flashes with a slow frequency (5 Hz) in the following cases: The coolant temperature is lower than 35 °C and the engine speed has reached 6500 rpm, or the recommended shift speed of 8000 rpm has been reached.

The tachometer flashes with a fast frequency (10 Hz) when the maximum engine speed is reached.

7.17 Odometer

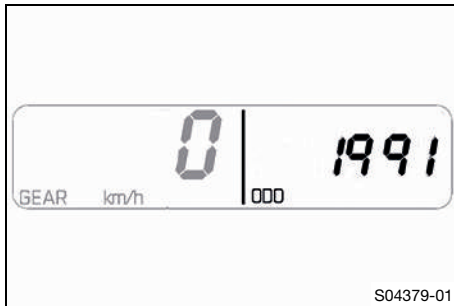

- Press the + or - button repeatedly until **ODO** is shown on the combination instrument.

ODO shows the motorcycle's overall mileage.

7.18 Gear display

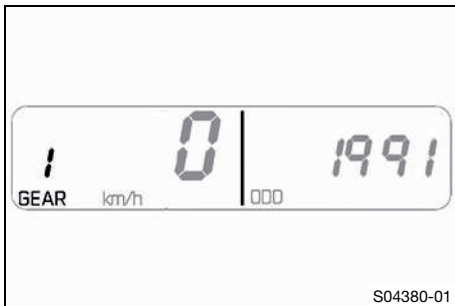

The gear display shows the engaged gear.



Info

The gear display is at the left of the display.

7.19 Service display

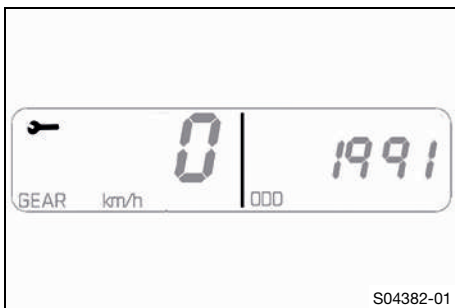

The service display is at the top left of the display.



Info

If the service display appears, a service is due. Contact an authorized Husqvarna Motorcycles workshop.

7.20 Distance fuel reserve

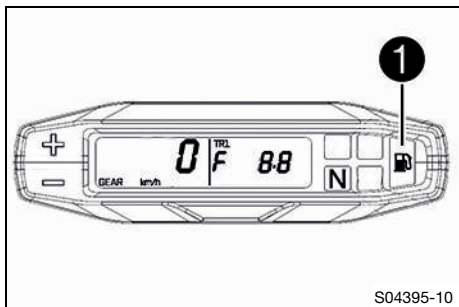

When the fuel level has reached the reserve mark, **TR1 F** appears on the display, and the fuel level warning lamp **1** lights up. This indicator can be closed by pressing the + or - button.

i Info

This indicator shows the distance traveled since the beginning of the fuel reserve. When the indicator is closed, the fuel level warning lamp continues to be lit up.

8.1 Advice on preparing for first use



Danger

Danger of accidents A rider who is not fit to ride poses a danger to him or herself and others.

- Do not operate the vehicle if you are not fit to ride due to alcohol, drugs or medication.
- Do not operate the vehicle if you are physically or mentally impaired.



Warning

Risk of injury Missing or poor protective clothing presents an increased safety risk.

- Wear appropriate protective clothing such as helmet, boots, gloves as well as trousers and a jacket with protectors on all rides.
- Always wear protective clothing that is in good condition and meets the legal regulations.



Warning

Danger of crashing Different tire tread patterns on the front and rear wheel impair the handling characteristic.

Different tire tread patterns can make the vehicle significantly more difficult to control.

- Make sure that only tires with a similar tire tread pattern are fitted to the front and rear wheel.



Warning

Danger of accidents Non-approved or non-recommended tires and wheels impact the handling characteristic.

- Only use tires/wheels approved by Husqvarna Motorcycles with the corresponding speed index.

8 PREPARING FOR USE



Warning

Danger of accidents New tires have reduced road grip.

The contact surface on new tires is not yet roughened.

- Run in new tires with moderate riding at alternating angles.
Running-in phase 200 km (124 mi)



Warning

Danger of accidents The brake system fails in the event of overheating.

If the foot brake lever is not released, the brake linings drag continuously.

- Take your foot off the foot brake lever if you do not want to brake.



Info

When using your vehicle, remember that others may feel disturbed by excessive noise.

- Make sure that the pre-sale inspection work has been carried out by an authorized Husqvarna Motorcycles workshop.
 - ✓ You will receive a delivery certificate when the vehicle is handed over.
- Before riding for the first time, read the entire Owner's Manual carefully.
- Get to know the controls.
- Adjust the basic position of the clutch lever. (📖 p. 130)
- Adjust the basic position of the hand brake lever. (📖 p. 137)
- Adjust the basic position of the foot brake lever. (👉📖 p. 145)

- Get used to handling the motorcycle in a suitable area before making a longer trip. Try also to ride as slowly as possible and in a standing position to get a better feel for the motorcycle.
- Hold the handlebar firmly with both hands and keep your feet on the footrests when riding.
- Do not make any trips that exceed your ability and experience.
- Run the engine in. (📖 p. 61)



8.2 Running in the engine

- During the run-in phase, do not exceed the specified vehicle speed in the respective gear.

Guideline

During the first	1,000 km (620 mi)
Maximum speed per gear	
first-gear	50 km/h (31.1 mph)
second-gear	70 km/h (43.5 mph)
third-gear	90 km/h (55.9 mph)
fourth-gear	110 km/h (68.4 mph)
fifth-gear	125 km/h (77.7 mph)
sixth-gear	140 km/h (87 mph)

- Avoid fully opening the throttle.



8.3 Loading the vehicle



Warning

Danger of accidents Total weight and axle loads influence the handling characteristic.

The total weight consists of: motorcycle ready for operation and with a full tank, driver and passenger with protective clothing and helmet, and luggage.

- Do not exceed the maximum permissible overall weight or the axle loads.



Warning

Danger of accidents Improper mounting of cases or the tank rucksack impairs the handling characteristic.

- Mount and secure cases and tank rucksack according to the manufacturer's instructions.



Warning

Danger of accidents Carrying luggage alters handling characteristics at high speed.

- Adapt your speed to your payload.
- Ride more slowly if your motorcycle is loaded with cases or other luggage.

Maximum speed with baggage 130 km/h (80.8 mph)



Warning

Danger of accidents The luggage system will be damaged if it is overloaded.

- Read the manufacturer information on maximum payload when mounting cases.



Warning

Danger of accidents Luggage which has slipped impairs visibility.

If the tail light is covered, you are less visible to traffic behind you, especially when it is dark.

- Check that your luggage is fixed properly at regular intervals.



Warning

Danger of accidents A high payload alters the handling characteristic and increases the stopping distance.

- Adapt your speed to your payload.



Warning

Danger of accidents Pieces of luggage which have slipped impair the handling characteristic.

- Check that your luggage is fixed properly at regular intervals.



Warning

Fire hazard The hot exhaust system may burn luggage.

- Fasten your luggage in such a way that it cannot be burned or singed by the hot exhaust system.

-
- If you carry luggage, make sure you secure it firmly as close as possible to the center of the vehicle and ensure even weight distribution between the front and rear wheels.
 - Do not exceed the maximum permissible weight and the maximum permissible axle loads.

8 PREPARING FOR USE

Guideline

Maximum permissible overall weight	350 kg (772 lb.)
Maximum permissible front axle load	150 kg (331 lb.)
Maximum permissible rear axle load	200 kg (441 lb.)



9.1 Checks and maintenance measures when preparing for use

i Info

Before every trip, check the condition of the vehicle and ensure that it is roadworthy. The vehicle must be in perfect technical condition when it is being operated.

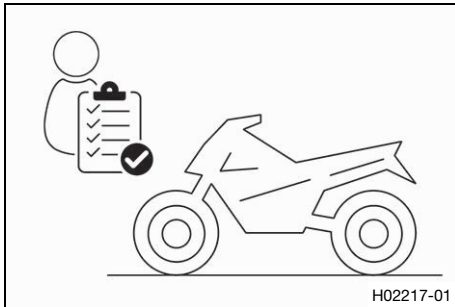

- Check the engine oil level. (📖 p. 214)
- Check the front brake fluid level. (📖 p. 139)
- Check the rear brake fluid level. (📖 p. 147)
- Check the front brake linings. (📖 p. 143)
- Check the rear brake linings. (📖 p. 150)
- Check that the brake system is functioning properly.
- Check the coolant level. (📖 p. 198)
- Check the chain for dirt. (📖 p. 117)
- Check the chain tension. (📖 p. 120)
- Check the tire condition. (📖 p. 165)
- Check tire pressure. (📖 p. 169)
- Check the settings of all controls and ensure that they can be operated smoothly.
- Check that the electrical system is functioning properly.
- Check that luggage is properly secured.
- Sit on the motorcycle and check the rear mirror setting.
- Check the fuel level.



9.2 Starting the vehicle



Danger

Danger of poisoning Exhaust gases are toxic and inhaling them may result in unconsciousness and death.

- Always make sure there is sufficient ventilation when running the engine.
- Use effective exhaust extraction when starting or running the engine in an enclosed space.



Caution

Danger of accidents Electronic components and safety devices will be damaged if the 12-V battery is discharged or missing.

If the 12-V battery is discharged or defective, malfunctions in the vehicle electronics can occur, especially when starting.



- Never operate the vehicle with a discharged 12-V battery or without a 12-V battery.

Note

Engine damage High revving speed with a cold engine negatively impacts the lifespan of the engine.

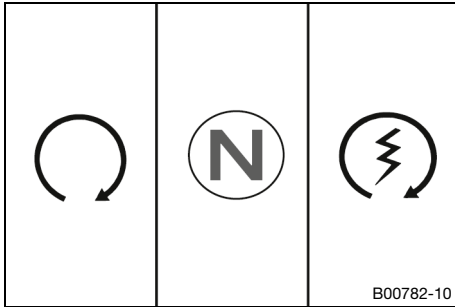
- Always run the engine warm at a low speed.



- Turn the emergency OFF switch to the position .
- Switch on the ignition by turning the ignition key to the **ON**  position.
 - ✓ After you switch on the ignition, you can hear the fuel pump working for about two seconds. The function check of the combination instrument is run at the same time.
 - ✓ The ABS warning lamp lights up and goes back out after starting off.
- Shift the transmission to neutral position.
 - ✓ Green idle indicator lamp **N** lights up.
- Press start button .



Info

Do not press the start button until the combination instrument function check has finished. Do not open the throttle to start. Press the starter for a maximum of 5 seconds. Wait for a least 5 seconds before trying again. This motorcycle is equipped with a safety starting system. You can only start the engine if the transmission is in neutral or if the clutch lever is pulled when a gear is engaged. If the side stand is folded out and you shift into gear and release the clutch lever, the engine stops.

9 RIDING INSTRUCTIONS

- Take the weight off the side stand and swing it back up with your foot as far as it will go.

9.3 Starting off

- Pull the clutch lever, engage 1st gear, release the clutch lever slowly and simultaneously open the throttle carefully.

9.4 Shifting, riding



Warning

Danger of accidents Abrupt load alterations can cause the vehicle to get out of control.

- Avoid abrupt load alterations and sudden braking actions.
- Adapt your speed to the road conditions.



Warning

Danger of accidents If you change down at high engine speed, the rear wheel blocks and the engine races.

- Do not change into a low gear at high engine speed.



Warning

Danger of accidents An incorrect ignition key position causes malfunctions.

- Do not change the ignition key position while driving.

**Warning**

Danger of accidents Adjustments to the vehicle distract attention from traffic activity.

- Make all adjustments when the vehicle is at a standstill.

**Warning**

Risk of injury The passenger may fall from the motorcycle if they conduct themselves incorrectly.

- Ensure that the passenger sits correctly on the passenger seat, places his or her feet on the passenger foot pegs and holds on to the rider or the grab handles.
- Note the regulations governing the minimum age of passengers in your country.

**Warning**

Danger of accidents A risky riding style constitutes a major risk.

- Comply with traffic regulations and ride defensively and with foresight to detect sources of danger as early as possible.

**Warning**

Danger of accidents Cold tires have reduced road grip.

- Ride the first miles carefully on every journey at moderate speed until the tires reach operating temperature.

9 RIDING INSTRUCTIONS



Warning

Danger of accidents New tires have reduced road grip.

The contact surface on new tires is not yet roughened.

- Run in new tires with moderate riding at alternating angles.
Running-in phase 200 km (124 mi)



Warning

Danger of accidents Total weight and axle loads influence the handling characteristic.

The total weight consists of: motorcycle ready for operation and with a full tank, driver and passenger with protective clothing and helmet, and luggage.

- Do not exceed the maximum permissible overall weight or the axle loads.



Warning

Danger of accidents Pieces of luggage which have slipped impair the handling characteristic.

- Check that your luggage is fixed properly at regular intervals.



Warning

Danger of accidents A fall can damage the vehicle more seriously than it may first appear.

- Check the vehicle after a fall as you do when preparing for use.

Note

Engine damage Unfiltered intake air has a negative effect on the service life of the engine.

Dust and dirt will enter the engine without an air filter.

- Only operate the vehicle if it is equipped with an air filter.

Note

Engine failure Overheating damages the engine.

- If the coolant temperature warning is displayed, stop immediately and take care not to endanger yourself or other traffic participants in the process.
- Allow the engine and cooling system to cool down.
- Check and, if necessary, correct the coolant level on the cooling system while it is in a cooled state.

**Info**

If unusual noises occur during operation, stop immediately, switch off the engine, park the vehicle properly, and contact an authorized Husqvarna Motorcycles workshop.

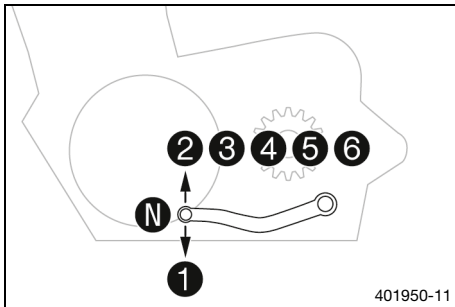

- Shift into a higher gear when conditions allow (incline, road situation, etc.).
- Release the throttle while simultaneously pulling the clutch lever, shift into the next gear, release the clutch lever, and open the throttle.



**Info**

You can see the positions of the 6 forward gears in the figure. The neutral or idle position is between the first and second gears. First gear is used for starting off or for steep inclines.

- After reaching maximum speed by fully opening the throttle grip, turn the throttle back so it is $\frac{3}{4}$ open. This will barely

9 RIDING INSTRUCTIONS

reduce the speed, but fuel consumption will be considerably lower.

- Accelerate only up to a speed suitable for the road surface and weather conditions. Particularly in bends, do not shift, and accelerate very carefully.
- Brake if necessary and close the throttle at the same time in order to shift down.
- Pull clutch lever and shift into a lower gear, release the clutch lever slowly, and open the throttle or shift again.
- If the engine stalls (e.g. at an intersection), just pull the clutch lever and press the start button. The transmission must not be shifted into neutral.
- Switch off the engine if you are likely to be running at idle speed or stationary for a long time.
- Avoid frequent and lengthy slipping of the clutch. This causes the engine oil, engine and cooling system to heat up.
- Ride at a low engine speed instead of at a high engine speed with a slipping clutch.
- If the oil pressure warning lamp  lights up, stop immediately, taking care not to endanger yourself or other road users in the process, and switch off the engine. Contact an authorized Husqvarna Motorcycles workshop.
- If the malfunction indicator lamp  lights up during a trip, please contact an authorized Husqvarna Motorcycles workshop as soon as possible.

- Easy Shift allows you to shift up in the speed range shown without pulling the clutch lever.

Guideline

Minimum speed before gear change	
First gear to second gear	30 km/h (18.6 mph)
Second gear to third gear	40 km/h (24.9 mph)
Third gear to fourth gear	45 km/h (28 mph)
Fourth gear to fifth gear	50 km/h (31.1 mph)
Fifth gear to sixth gear	55 km/h (34.2 mph)

- Easy Shift allows you to shift down in the speed range shown without pulling the clutch lever.

Guideline

Maximum speed before gear change	
Sixth gear to fifth gear	165 km/h (102.5 mph)
Fifth gear to fourth gear	145 km/h (90.1 mph)
Fourth gear to third gear	120 km/h (74.6 mph)
Third gear to second gear	90 km/h (55.9 mph)
Second gear to first gear	60 km/h (37.3 mph)



9 RIDING INSTRUCTIONS

9.5 Easy Shift

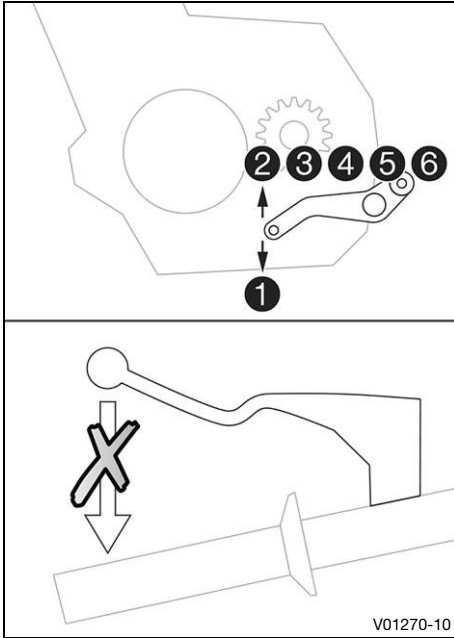

If Easy Shift is activated, you can shift up and down without actuating the clutch.

Because there is no need to close the throttle grip, uninterrupted gear shifts are possible.

Easy Shift uses the shifter shaft position to check whether or not a shift should be initiated, and sends a corresponding signal to the engine control unit.

9.6 Motorcycle traction control

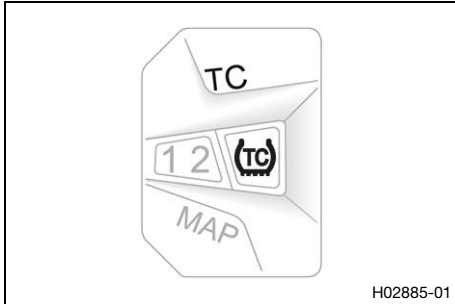



The motorcycle traction control (cornering MTC) lowers the engine torque in case of loss of traction in the rear wheel. Depending on the riding mode, different amounts of slip are allowed when the traction control is activated.

i Info

When motorcycle traction control is switched off, the rear wheel may spin during strong acceleration and on surfaces with low grip, resulting in a risk of crashing. After the ignition is switched on, motorcycle traction control is enabled again.

The motorcycle traction control **MTC** is switched on and off on the left combination switch using the **TC** button.

i Info

When the motorcycle traction control is active, the TC indicator lamp  flashes. When motorcycle traction control is switched off, the TC indicator lamp  lights up.

9.7 Braking



Warning

Danger of accidents Moisture and dirt impair the brake system.

- Brake carefully several times to dry out and remove dirt from the brake linings and the brake discs.



Warning

Danger of accidents A spongy pressure point on the front or rear brake reduces braking efficiency.

- Check the brake system and do not continue riding until the problem is eliminated. (Your authorized Husqvarna Motorcycles workshop will be glad to help.)



Warning

Danger of accidents The brake system fails in the event of overheating.

If the foot brake lever is not released, the brake linings drag continuously.

- Take your foot off the foot brake lever if you do not want to brake.



Warning

Danger of accidents Higher total weight increases the stopping distance.

- Take the longer stopping distance into account when carrying a passenger or luggage with you.



Warning

Danger of accidents Salt on the roads impairs the brake system.

- Brake carefully several times to remove salt from the brake linings and the brake discs.



Warning

Danger of accidents ABS may increase the stopping distance in certain situations.

- Adjust application of the brakes to the respective riding situation and riding surface conditions.



Warning

Danger of accidents Excessively forceful application of the brakes blocks the wheels.

The ABS effectiveness is only ensured if it is switched on.

- Leave the ABS switched on in order to benefit from the protective effect.



Warning

Danger of accidents The rear wheel can lock due to the engine braking effect.

- Pull in the clutch, if you perform emergency or full braking, or if you brake on a slippery ground.

-
- To brake release the throttle and apply the front and rear brakes at the same time.



Info

When the ABS is enabled, you can achieve maximum braking power even on low grip surfaces such as sandy, wet, or slippery terrain without the danger of the wheels locking.



Warning

Danger of accidents Banked or laterally sloping ground reduces the maximum possible delay.

- If possible finish braking before going into a bend.

9 RIDING INSTRUCTIONS

- Always finish braking before you go into a bend. Change down to a lower gear appropriate to your road speed.
- Use the braking effect of the engine on long downhill stretches. Change down one or two gears, but do not over-rev the engine. You will have to apply the brakes far less frequently as a result and the brake system will not overheat.

9.8 Stopping, parking



Warning

Risk of injury People who act without authorization endanger themselves and others.

- Do not leave the vehicle unattended if the engine is running.
- Protect the vehicle against access by unauthorized persons.
- Lock the steering and remove the ignition key if you leave the vehicle unattended.



Warning

Danger of burns Some vehicle components become very hot when the vehicle is operated.

- Do not touch any parts such as the exhaust system, radiator, engine, shock absorber, or brake system before the vehicle parts have cooled down.
- Let the vehicle parts cool down before you perform any work on the vehicle.

Note

Material damage The vehicle may be damaged by incorrect procedure when parking.

Significant damage may be caused if the vehicle rolls away or falls over.
The components for parking the vehicle are designed only for the weight of the vehicle.

- Park the vehicle on a firm and level surface.
- Ensure that nobody sits on the vehicle when the vehicle is parked on a stand.

Note

Fire hazard Hot vehicle components pose a fire hazard and explosion risk.

- Do not park the vehicle near to materials which are highly flammable or explosive.
- Allow the vehicle to cool down before covering it.

- Apply the brakes on the motorcycle.
- Shift the transmission to neutral position.
- Switch off the ignition by turning the ignition key to the **OFF** ☒ position.



Info

If the engine is switched off with the emergency OFF switch and the ignition remains switched on at the ignition lock, power continues to flow to most power consumers. This discharges the 12-V battery. You should therefore always switch off the engine with the ignition lock – the emergency OFF switch is intended for emergencies only.

- Park the motorcycle on a firm surface.
- Swing side stand forward with your foot as far as it will go and lean the vehicle on it.
- Lock the steering by turning the handlebar fully to the left, pressing down the ignition key to the position ☒ and turning it to the position ☒. To make the steering lock engage more easily, move the handlebar a little to the left and right. Remove the ignition key.



9 RIDING INSTRUCTIONS

9.9 Transport

Note

Danger of damage The parked vehicle can roll away or fall over.

- Park the vehicle on a firm and level surface.

Note

Fire hazard Hot vehicle components pose a fire hazard and explosion risk.

- Do not park the vehicle near to materials which are highly flammable or explosive.
- Allow the vehicle to cool down before covering it.

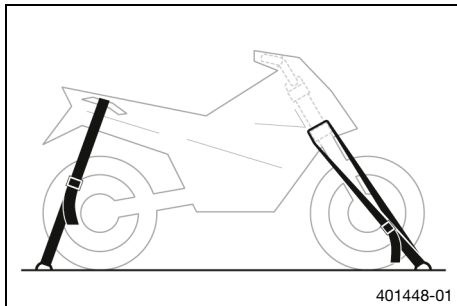

- Switch off the engine and remove the ignition key.
- Use tension belts or other suitable devices to secure the motorcycle against accidents or falling over.

9.10 Refueling



Danger

Fire hazard Fuel is highly flammable.

The fuel in the fuel tank expands when warm and can escape if overfilled.

- Do not fuel the vehicle in the vicinity of open flames or lit cigarettes.
- Switch off the engine for refueling.
- Make sure that no fuel is spilled; particularly not on hot parts of the vehicle.
- If any fuel is spilled, wipe it off immediately.
- Observe the specifications for refueling.



Warning

Danger of poisoning Fuel is poisonous and a health hazard.

- Avoid skin, eye and clothing contact with fuel.
- Immediately consult a doctor if you swallow fuel.
- Do not inhale fuel vapors.
- In case of skin contact, rinse the affected area with plenty of water.
- Rinse the eyes thoroughly with water, and consult a doctor in case of fuel contact with the eyes.
- Change your clothing in case of fuel spills on them.

Note

Material damage Inadequate fuel quality causes the fuel filter to quickly become clogged.

9 RIDING INSTRUCTIONS

In some countries and regions, the available fuel quality and cleanliness may not be sufficient. This will result in problems with the fuel system.

- Refuel only with clean fuel that meets the specified standards. (Your authorized Husqvarna Motorcycles workshop will be glad to help.)



Note

Environmental hazard Improper handling of fuel is a danger to the environment.

- Do not allow fuel to enter the groundwater, the soil, or the sewage system.
-

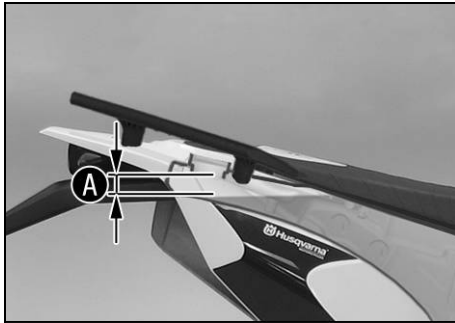

- Switch off the engine.
- Open fuel tank filler cap. (📖 p. 41)
- Fill the fuel tank with fuel up to level **A**.

Guideline

Level A	20 mm (0.79 in)
----------------	-----------------

Fuel tank capacity, approx.	12.7 l (3.36 US gal)	Super unleaded (ROZ 95) (📖 p. 262)
-----------------------------	-------------------------	--

- Close the fuel tank filler cap. (📖 p. 43)



V01462-10

10 SERVICE SCHEDULE

10.1 Additional information

Any further work that results from the compulsory work or from the recommended work must be ordered separately and invoiced separately.

Different service intervals may apply in your country, depending on the local operating conditions.

Individual service intervals and scopes may change in the course of technical developments. The most up-to-date service schedule can always be found on Husqvarna Motorcycles Dealer.net. Your authorized Husqvarna Motorcycles dealer will be glad to advise you.

10.2 Required work

	every 24 months				
	every 12 months				
	every 20,000 km (12,400 mi)				
	every 10,000 km (6,200 mi)				
	after 1,000 km (620 mi)				
Read out the fault memory using the Husqvarna Motorcycles diagnostics tool. 🛠️	○	●	●	●	●
Program the shift shaft sensor. 🛠️	○	●	●	●	●
Check that the electrical system is functioning properly. 🛠️	○	●	●	●	●
Change the engine oil and the oil filter, clean the oil screens. 🛠️ (📖 p. 215)	○	●	●	●	●
Check the front brake linings. (📖 p. 143)	○	●	●	●	●
Check the rear brake linings. (📖 p. 150)	○	●	●	●	●
Check the brake discs. (📖 p. 138)	○	●	●	●	●
Check the brake lines for damage and leakage. 🛠️	○	●	●	●	●

	every 24 months			
	every 12 months			
	every 20,000 km (12,400 mi)			
	every 10,000 km (6,200 mi)			
	after 1,000 km (620 mi)			
Change the front brake fluid. 🛠️				•
Change the rear brake fluid. 🛠️				•
Change the hydraulic clutch fluid. 🛠️				•
Check the rear brake fluid level. (📖 p. 147)	○	•	•	•
Check the front brake fluid level. (📖 p. 139)	○	•	•	•
Check/correct the fluid level of the hydraulic clutch. (📖 p. 131)		•	•	•
Check the free travel of the foot brake lever. (📖 p. 144)	○	•	•	•
Check the shock absorber and fork for leaks. Perform a fork service and shock absorber service as needed and depending on how the vehicle is used. 🛠️	○	•	•	•
Clean the dust boots of the fork legs. (📖 p. 105)		•	•	
Check the steering head bearing for play. 🛠️	○	•	•	•
Check the tire condition. (📖 p. 165)	○	•	•	•
Check tire pressure. (📖 p. 169)	○	•	•	•
Check the spoke tension. (📖 p. 170)	○	•	•	•
Check the rim run-out. 🛠️	○	•	•	•
Check the chain, rear sprocket, engine sprocket, and chain guide. (📖 p. 124)		•	•	•
Check the chain tension. (📖 p. 120)	○	•	•	•

10 SERVICE SCHEDULE

		every 24 months				
		every 12 months				
		every 20,000 km (12,400 mi)				
		every 10,000 km (6,200 mi)				
		after 1,000 km (620 mi)				
Change the fuel screen. 🛠️ (📖 p. 212)	○	●	●	●	●	●
Change the spark plugs. 🛠️				●		
Check the valve clearance. 🛠️			●	●		
Check the antifreeze and coolant level. (📖 p. 196)	○	●	●	●	●	●
Check the cables for damage and routing without sharp bends. 🛠️			●	●	●	●
Change the air filter. Clean the air filter box. 🛠️			●	●		
Check the fuel pressure. 🛠️			●	●	●	●
Check the headlight setting. (📖 p. 192)	○	●	●			
Check that the radiator fan is functioning properly. 🛠️	○	●	●	●	●	●
Final check: Check the vehicle is roadworthy and take a test ride. 🛠️	○	●	●	●	●	●
Read out the fault memory after the test ride using the Husqvarna Motorcycles diagnostics tool. 🛠️	○	●	●	●	●	●
Set the service interval. (📖 p. 48)	○	●	●	●	●	●
Make a service entry in Husqvarna Motorcycles Dealer.net . 🛠️	○	●	●	●	●	●

- One-time interval
- Periodic interval

10.3 Recommended work

	every 48 months				
	every 12 months				
	every 30,000 km (18,600 mi)				
	every 10,000 km (6,200 mi)				
	after 1,000 km (620 mi)				
Check the frame. 🐾				•	
Check the link fork. 🐾				•	
Check the fork bearing for play. 🐾		•	•		
Check the wheel bearing for play. 🐾	○	•	•	•	•
Empty the drainage hoses. 🐾	○	•	•	•	•
Grease all moving parts (e.g., side stand, hand lever, chain, ...) and check for smooth operation. 🐾	○	•	•	•	•
Check all hoses (e.g. fuel, coolant, bleeder, drainage, etc.) and sleeves for cracking, leaks, and incorrect routing. 🐾		•	•	•	•
Check the tightness of the safety-relevant screws and nuts which are easily accessible. 🐾	○	•	•	•	•
Change the coolant. 🐾 (📖 p. 204)					•

- One-time interval
- Periodic interval

11 TUNING THE CHASSIS

11.1 Fork/shock absorber

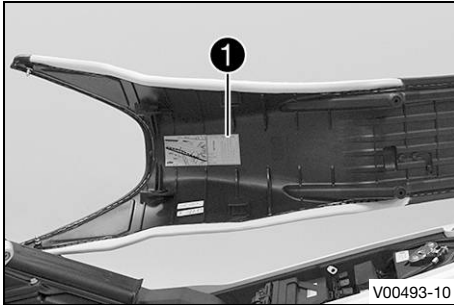

The fork and the shock absorber offer many options for adapting the chassis to the riding style and the payload.



Info

The recommendations for the suspension setting are shown in table 1. The table is located on the underside of the front rider's seat.

These adjustments should be understood as a guideline and should always be the basis for one's own personal suspension setting. Do not change the adjustments at random, as otherwise the riding characteristics could deteriorate, particularly at high speeds.

11.2 Adjusting the compression damping of the fork



Info

The hydraulic compression damping determines the fork suspension behavior.

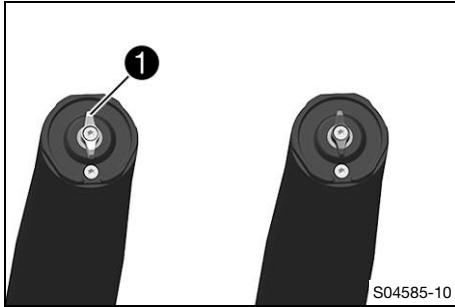

- Turn white adjusting screw **1** clockwise as far as it will go.



Info

Adjusting screw **1** is located at the upper end of the left fork leg.

The compression damping is located in left fork leg **COMP** (white adjusting screw). The rebound damping is located in right fork leg **REB** (red adjusting screw).

- Turn counterclockwise by the number of clicks corresponding to the fork type.

Guideline

Compression damping	
Comfort	20 clicks
Standard	15 clicks
Sport	10 clicks
Full payload	10 clicks



Info

Turn clockwise to increase damping; turn counterclockwise to reduce damping.

11.3 Adjusting the rebound damping of the fork



Info

The hydraulic rebound damping determines the fork suspension behavior.

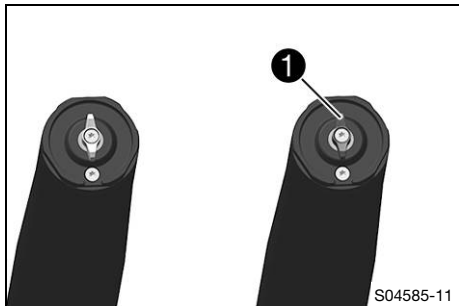

- Turn red adjusting screw **1** clockwise as far as it will go.



Info

Adjusting screw **1** is located at the upper end of the right fork leg.

The rebound damping is located in right fork leg **REB** (red adjusting screw). The compression damping is located in left fork leg **COMP** (white adjusting screw).

- Turn counterclockwise by the number of clicks corresponding to the fork type.

Guideline

Rebound damping	
Comfort	20 clicks
Standard	15 clicks
Sport	10 clicks
Full payload	10 clicks

**Info**

Turn clockwise to increase damping; turn counter-clockwise to reduce damping.



11.4 Compression damping of the shock absorber

The compression damping of the shock absorber is divided into two ranges: high-speed and low-speed. High-speed and low-speed refer to the compression speed of the rear wheel suspension and not to the vehicle speed.

The high-speed compression adjuster, for example, has an effect when riding over an asphalt edge: the rear wheel suspension compresses quickly.

The low-speed compression adjuster has an effect, for example, when riding over long ground swells: the rear wheel suspension compresses slowly.

These two ranges can be adjusted separately, although the transition between high-speed and low-speed is gradual. Thus, modifications in the high-speed range affect the compression damping in the low-speed range and vice versa.

11.5 Adjusting the low-speed compression damping of the shock absorber



Caution

Risk of injury Parts of the shock absorber will move around if the shock absorber is detached incorrectly.

The shock absorber is filled with highly compressed nitrogen.

- Please follow the description provided. (Your authorized Husqvarna Motorcycles workshop will be glad to help.)



Info

The low-speed compression adjuster takes effect during slow to normal compression of the shock absorber.

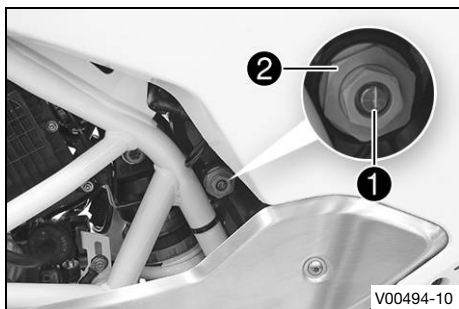

- Turn adjusting screw **1** clockwise with a screwdriver as far as the last perceptible click.



Info

Do not loosen fitting **2**!

- Turn counterclockwise by the number of clicks corresponding to the shock absorber type.

Guideline

Low-speed compression damping	
Comfort	20 clicks
Standard	15 clicks
Sport	10 clicks
Full payload	10 clicks



Info

Turn clockwise to increase damping; turn counter-clockwise to reduce damping.



11.6 Adjusting the high-speed compression damping of the shock absorber



Caution

Risk of injury Parts of the shock absorber will move around if the shock absorber is detached incorrectly.

The shock absorber is filled with highly compressed nitrogen.

- Please follow the description provided. (Your authorized Husqvarna Motorcycles workshop will be glad to help.)

11 TUNING THE CHASSIS

i Info

The high-speed compression adjuster takes effect during fast compression of the shock absorber.

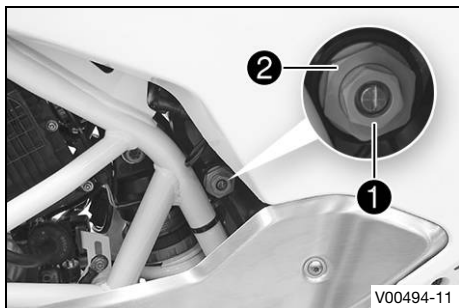

- Turn adjusting screw **1** all the way clockwise with a socket wrench.

i Info

Do not loosen fitting **2**!

- Turn counterclockwise by the number of turns corresponding to the shock absorber type.

Guideline

High-speed compression damping	
Comfort	2 turns
Standard	1.5 turns
Sport	1 turn
Full payload	1 turn

i Info

Turn clockwise to increase damping; turn counterclockwise to reduce damping.

11.7 Adjusting the rebound damping of the shock absorber



Caution

Risk of injury Parts of the shock absorber will move around if the shock absorber is detached incorrectly.

The shock absorber is filled with highly compressed nitrogen.

- Please follow the description provided. (Your authorized Husqvarna Motorcycles workshop will be glad to help.)

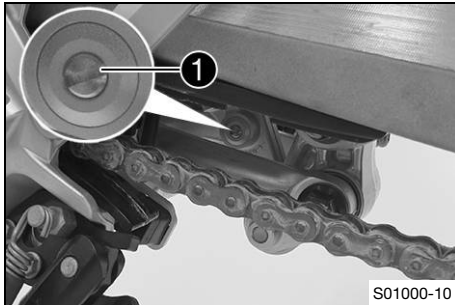

- Turn adjusting screw ❶ clockwise up to the last perceptible click.
- Turn counterclockwise by the number of clicks corresponding to the shock absorber type.

Guideline

Rebound damping	
Comfort	20 clicks
Standard	15 clicks
Sport	10 clicks
Full payload	10 clicks

11 TUNING THE CHASSIS



Info

Turn clockwise to increase damping; turn counter-clockwise to reduce damping.

11.8 Handlebar position

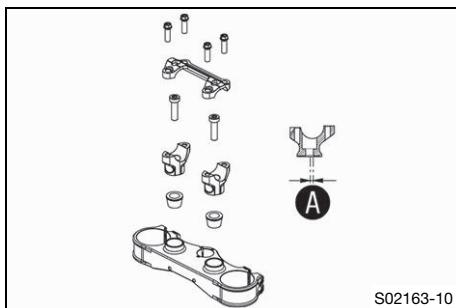

The holes on the handlebar support are placed at a distance of **A** from the center.

Hole distance A	3.5 mm (0.138 in)
------------------------	-------------------

The handlebar can be mounted in 2 different positions. This allows the handlebar to be mounted in the most comfortable position for the rider.

11.9 Adjusting the handlebar position ↴



Warning

Danger of accidents A repaired handlebar poses a safety risk.

If the handlebar is bent or straightened, the material becomes fatigued. The handlebar may break as a result.

- Change the handlebar if the handlebar is damaged or bent.

11 TUNING THE CHASSIS

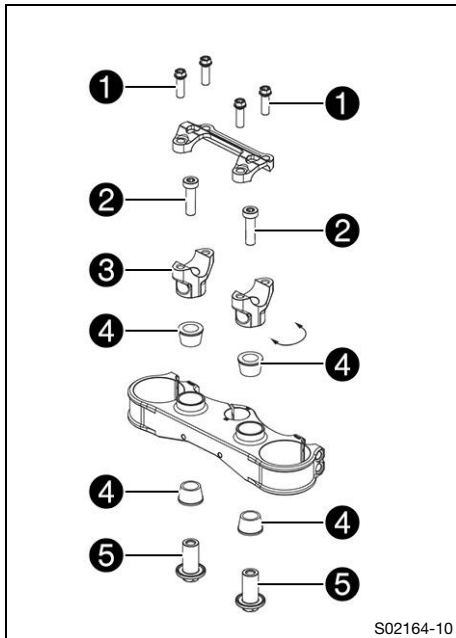

- Remove screws ①. Take off the handlebar clamp. Remove the handlebar and lay it to one side.



Info

Cover the components to protect them against damage.
Do not kink the cables and lines.

- Remove screws ②. Remove handlebar support ③.
- Position rubber bushings ④ and push through nuts ⑤ from below.
- Place the handlebar support in the required position.



Info

The handlebar supports are longer and higher on one side.
Position the left and right handlebar supports evenly.

- Mount and tighten screws ②.

Guideline

Screw, handlebar support	M10	45 Nm (33.2 lbf ft) Loctite®243™
--------------------------	-----	--

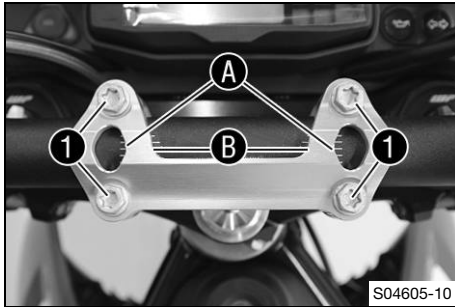

- Position the handlebar.



Info

Make sure the cables and wiring are positioned correctly.

- Position the handlebar clamp.
- Mount screws ① but do not tighten yet.
 - ✓ Handlebar clamp marking **A** is aligned with center line **A** of the handlebar scale.
- First bolt the handlebar clamp with screws ① onto the longer, higher side of the handlebar supports so that both parts touch.
- Tighten screws ① evenly.

Guideline

Screw, handlebar clamp	M8	20 Nm (14.8 lbf ft)
------------------------	----	---------------------

12 SERVICE WORK ON THE CHASSIS

12.1 Raising the motorcycle with a lift stand

Note

Danger of damage The parked vehicle can roll away or fall over.

- Park the vehicle on a firm and level surface.

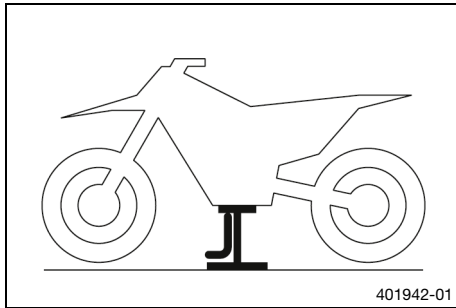

- Raise the motorcycle in the area of the footrest bracket.
 - ✓ Neither wheel is in contact with the ground.
- Secure the motorcycle against falling over.

12.2 Removing the motorcycle from the lift stand

Note

Danger of damage The parked vehicle can roll away or fall over.

- Park the vehicle on a firm and level surface.

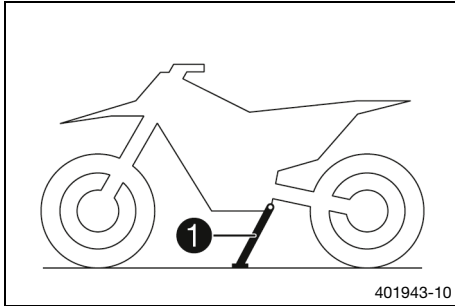

- Remove the motorcycle from the lift stand and rest it on side stand ①.
- Remove the lift stand.

12.3 Raising the motorcycle with the rear lifting gear

Note

Danger of damage The parked vehicle can roll away or fall over.

- Park the vehicle on a firm and level surface.

12 SERVICE WORK ON THE CHASSIS

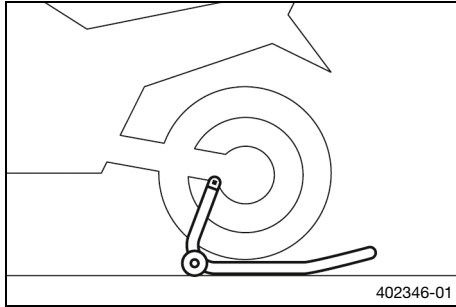

- Insert the adapter in the rear lifting gear.

Adapter (69329955030)

Rear wheel work stand (6932995500033)

- Stand the motorcycle upright, align the lifting gear to the link fork and the adapters, and raise the motorcycle.

12.4 Removing the rear of the motorcycle from the wheel stand

Note

Danger of damage The parked vehicle can roll away or fall over.

- Park the vehicle on a firm and level surface.

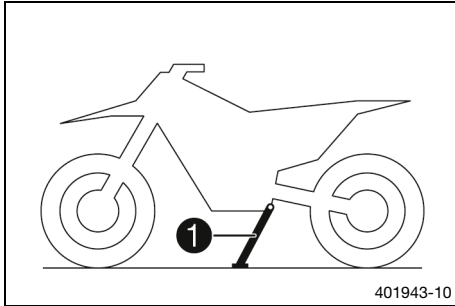

- Secure the motorcycle against falling over.
- Remove the rear wheel stand and lean the vehicle on side stand ①.



12.5 Lifting the motorcycle with the front lifting gear

Note

Danger of damage The parked vehicle can roll away or fall over.

- Park the vehicle on a firm and level surface.

Preparatory work

- Raise the motorcycle with the rear lifting gear. (📖 p. 101)

12 SERVICE WORK ON THE CHASSIS

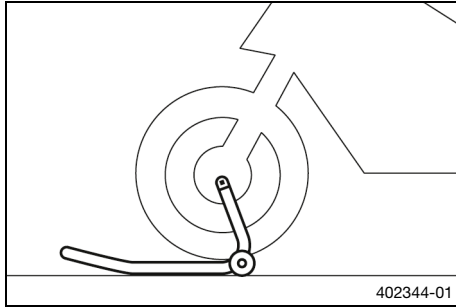

Main work

- Move the handlebar to the straight-ahead position, align suitable lifting gear at the front.

Front wheel work stand, small (6112996500033)



Info

Always raise the motorcycle at the rear first.

- Lift the motorcycle at the front.

12.6 Taking the motorcycle off the front lifting gear

Note

Danger of damage The parked vehicle can roll away or fall over.

- Park the vehicle on a firm and level surface.

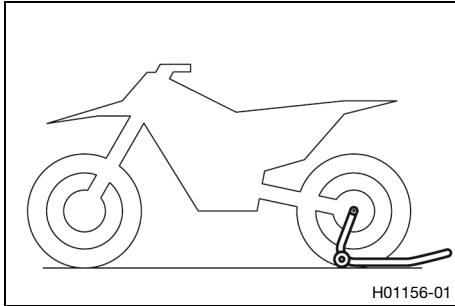

- Secure the motorcycle against falling over.
- Remove the front lifting gear.



12.7 Cleaning the dust boots of the fork legs

Preparatory work

- Remove the fork protector. (📖 p. 107)

Main work

- Push dust boots ① of both fork legs downward.

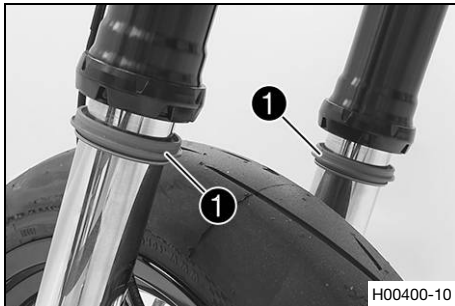

Info

The dust boots remove dust and coarse dirt particles from the inside fork tubes. Over time, dirt can accumulate behind the dust boots. If this dirt is not removed, the oil seals behind can start to leak.



Warning

Danger of accidents Oil or grease on the brake discs reduces the braking effect.

- Always keep the brake discs free of oil and grease.
- Clean the brake discs with brake cleaner when necessary.

- Clean and oil the dust boots and inner fork tubes of both fork legs.

Universal oil spray (📖 p. 264)

- Press the dust boots back into their installation position.
- Remove excess oil.

Finishing work

- Install the fork protector. (📖 p. 107)

12.8 Removing the fork protector

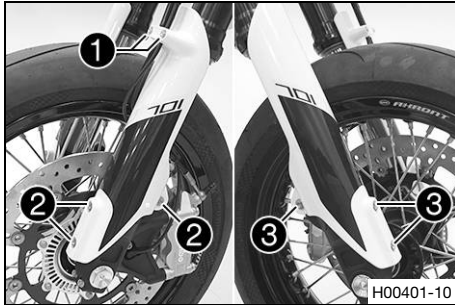

- Remove screws ① and take off the clamp.
- Remove screws ② on the left fork leg. Take off the fork protector.
- Remove screws ③ on the right fork leg. Take off the fork protector.

12.9 Installing the fork protector

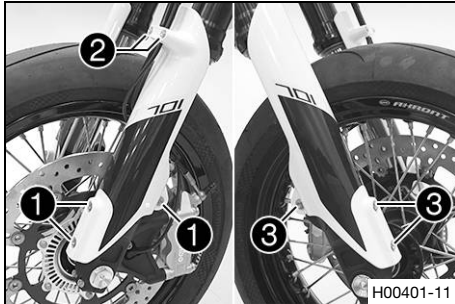

- Position the fork protector on the left fork leg. Mount and tighten screws ①.

Guideline

Remaining screws, chassis	M6	10 Nm (7.4 lbf ft)
---------------------------	----	--------------------

- Position the brake line, wiring harness, and clamp. Mount and tighten screws ②.
- Position the fork protector on the right fork leg. Mount and tighten screws ③.

12 SERVICE WORK ON THE CHASSIS

Guideline

Remaining screws, chassis	M6	10 Nm (7.4 lbf ft)
------------------------------	----	--------------------

12.10 Bleeding the fork legs

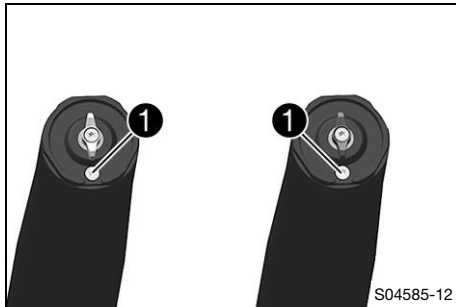

Preparatory work

- Raise the motorcycle with a lift stand. (📖 p. 100)

Main work

- Release bleeder screws ①.
- ✓ Any excess pressure escapes from the interior of the fork.
- Tighten the bleeder screws.



Info

Carry out this operation on both fork legs.

Finishing work

- Remove the motorcycle from the lift stand. (📖 p. 100)

12.11 Removing the seat



- Pull on the loop ① while raising the rear of the seat.
- Pull off the seat sideways at the front ends from the side cover.
- Pull seat back and lift it off.



12.12 Mounting the seat

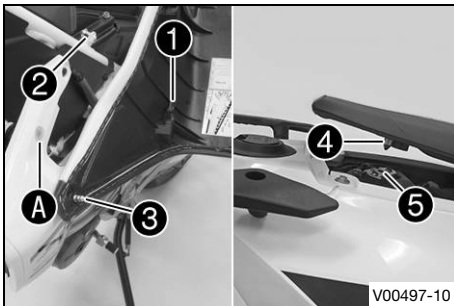

- Stretch the seat at the front ends slightly and position holding tabs ① on holders ②.
- ✓ The holding tabs engage in the holder.
- Press holding tab ③ into the bushings A.
- Insert locking pin ④ into the lock housing ⑤ and push down the rear of the seat until the locking pin engages with an audible click.
- Check, finally, that the seat is correctly mounted.



12 SERVICE WORK ON THE CHASSIS

12.13 Removing the tool set

Preparatory work

- Remove the seat. (📖 p. 109)

Main work

- Take the hexagon socket wrench for loosening and mounting screws ❶ and ❷ from attachment A on the underside of the seat.
- Remove screws ❶.
- Remove screws ❷.
- Take off the left side cover.
- Open the tool set compartment and take out tool set ❸.

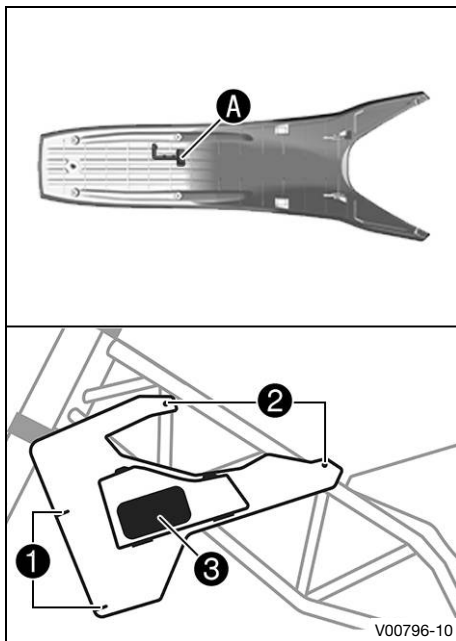

12.14 Storing tool set

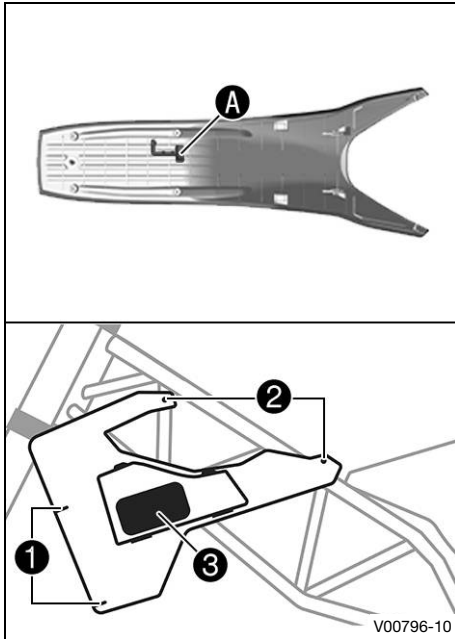

Preparatory work

- Remove the seat. (📖 p. 109)

Main work

- Remove screws ❶.
- Remove screws ❷.



Info

A tool for removing and mounting these screws is located in holder **A** on the underside of the seat.

- Take off the left side cover.
- Open the tool set compartment and store tool set ❸.
- Close the tool set compartment.
- Position the left side cover.
- Mount and tighten screws ❷.

Guideline

Screw, trim	M5x12	3.5 Nm (2.58 lbf ft)
-------------	-------	----------------------

- Mount and tighten screws ❶.

Guideline

Screw, front spoiler	M5x17	3.5 Nm (2.58 lbf ft)
----------------------	-------	----------------------

- Make sure the tool is reinserted in holder **A**.

12 SERVICE WORK ON THE CHASSIS

Finishing work

- Mount the seat. (📖 p. 109)

12.15 Take off the side cover

Preparatory work

- Remove the seat. (📖 p. 109)

Main work

- Remove screws ① and ②.
- Take off the side cover.
- Repeat these steps on the opposite side.

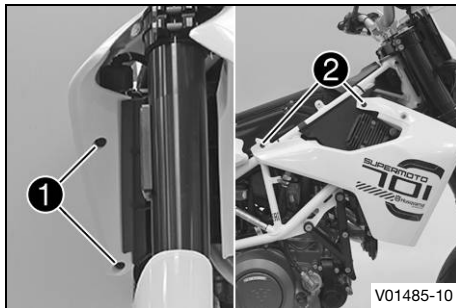

12.16 Mounting the side cover

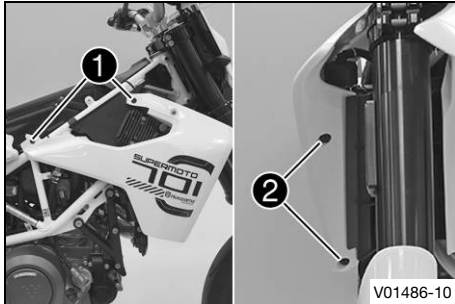

Main work

- Position the side cover, and mount and tighten screws ❶.

Guideline

Screw, trim	M5x12	3.5 Nm (2.58 lbf ft)
-------------	-------	----------------------

- Mount and tighten screws ❷.

Guideline

Screw, front spoiler	M5x17	3.5 Nm (2.58 lbf ft)
----------------------	-------	----------------------

- Repeat these steps on the opposite side.

Finishing work

- Mount the seat. (📖 p. 109)



12.17 Removing front fender

Preparatory work

- Remove the headlight mask with the headlight. (📖 p. 187)

12 SERVICE WORK ON THE CHASSIS

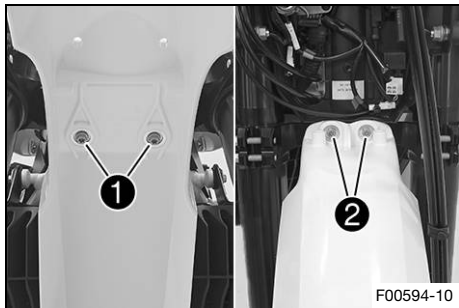

Main work

- Remove screws ①.
- Remove screws ② and take off the fender.

12.18 Installing front fender

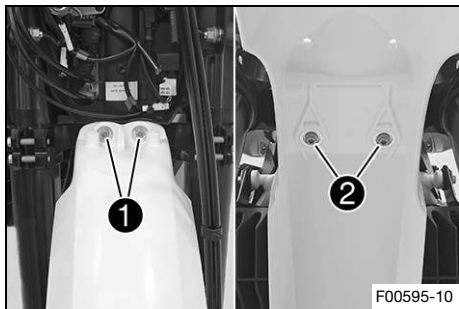

Main work

- Position front fender. Mount and tighten screws ①.

Guideline

Remaining screws, chassis	M6	10 Nm (7.4 lbf ft)
---------------------------	----	--------------------

- Mount and tighten screws ②.

Guideline

Remaining screws, chassis	M6	10 Nm (7.4 lbf ft)
---------------------------	----	--------------------

Finishing work

- Install the headlight mask with the headlight. (📖 p. 188)

- Check the headlight setting. (📖 p. 192)



12.19 Removing the air filter 🛠️

Preparatory work

- Remove the seat. (📖 p. 109)

Main work

- Remove screws ❶.
- Remove the upper part of the air filter box ❷.

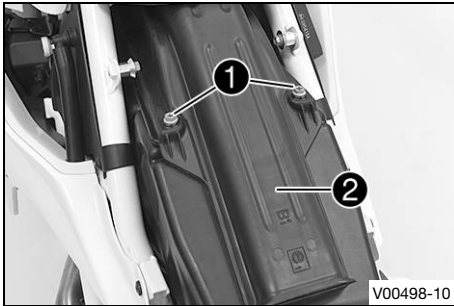

12 SERVICE WORK ON THE CHASSIS

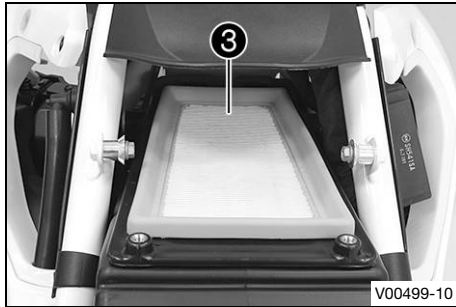

Note

Engine damage Unfiltered intake air has a negative effect on the service life of the engine.

Dust and dirt will enter the engine without an air filter.

- Only operate the vehicle if it is equipped with an air filter.

- Remove air filter ③.

12.20 Installing the air filter ↗

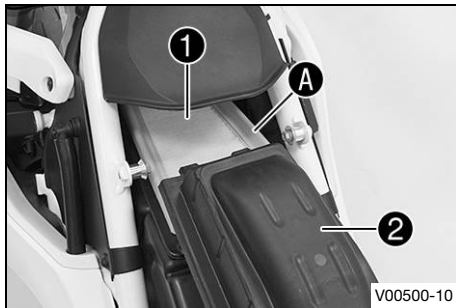

Main work

- Clean the air filter box.
- Mount air filter ①.



Info

The air filter must lie flush against the air filter box along the entire sealing surface A.

If the air filter is not mounted correctly, dust and dirt may enter the engine and result in damage.

- Hook air filter box top ② into the front of the air filter box and swing down.

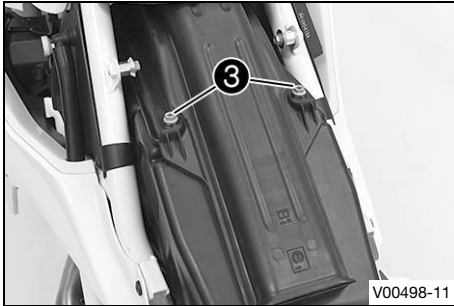

- Mount and tighten screws **3**.

Guideline

Screw, upper part of the air filter box	M6	2 Nm (1.5 lbf ft)
---	----	-------------------

Finishing work

- Mount the seat. (📖 p. 109)



12.21 Checking the chain for dirt

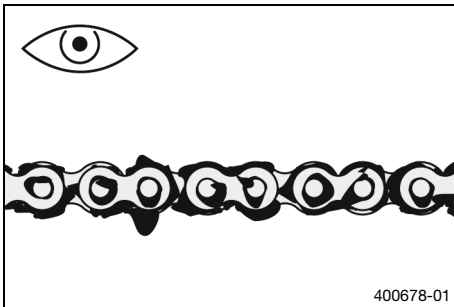

- Check the chain for heavy soiling.
 - » If the chain is very dirty:
 - Clean the chain. (📖 p. 118)



12 SERVICE WORK ON THE CHASSIS

12.22 Cleaning the chain



Warning

Danger of accidents Lubricants on the tires reduces the road grip.

- Remove lubricants from the tires using a suitable cleaning agent.



Warning

Danger of accidents Oil or grease on the brake discs reduces the braking effect.

- Always keep the brake discs free of oil and grease.
- Clean the brake discs with brake cleaner when necessary.



Note

Environmental hazard Hazardous substances cause environmental damage.

- Dispose of oils, grease, filters, fuel, cleaning agents, brake fluid, etc., correctly and in compliance with the applicable regulations.



Info

The service life of the chain depends largely on its maintenance.

Preparatory work

- Raise the motorcycle with the rear lifting gear. (📖 p. 101)

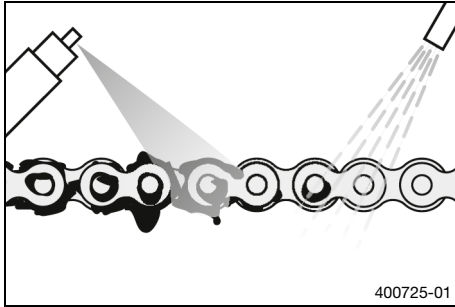

Main work

- Rinse off loose dirt with a soft jet of water.
- Remove old grease residue with chain cleaner.

Chain cleaner (📖 p. 263)

- After drying, apply chain spray.

Street chain spray (📖 p. 264)

Finishing work

- Remove the rear of the motorcycle from the wheel stand.
(📖 p. 102)



12.23 Checking the chain tension



Warning

Danger of accidents Incorrect chain tension damages components and results in accidents.

If the chain is tensioned too much, the chain, engine sprocket, rear sprocket, transmission and rear wheel bearings wear more quickly. Some components may break if overloaded.

If the chain is too loose, the chain may fall off the engine sprocket or the rear sprocket. As a result, the rear wheel locks or the engine will be damaged.

- Check the chain tension regularly.
- Set the chain tension in accordance with the specification.

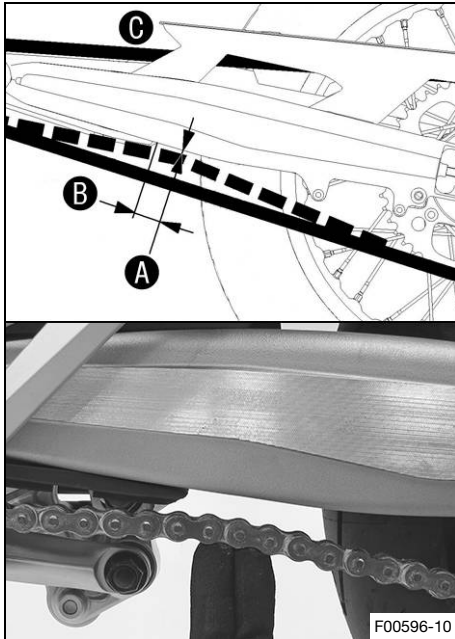

- Raise the motorcycle with the rear lifting gear. (📖 p. 101)



Info

The check is also possible when the motorcycle is resting on the side stand.

- Shift the transmission to neutral position.
- Push the chain upward at a distance **B** from the chain sliding guard and determine chain tension **A**.



Info

The top part of chain **C** must be taut.
Chain wear is not always even. Repeat this measurement at different chain positions.

Chain tension A	5 mm (0.2 in)
Distance B to chain sliding guard	30 mm (1.18 in)

- » If the chain tension does not meet the specification:
 - Adjust the chain tension. (📖 p. 122)
- Remove the rear of the motorcycle from the wheel stand. (📖 p. 102)



12.24 Adjusting the chain tension



Warning

Danger of accidents Incorrect chain tension damages components and results in accidents.

If the chain is tensioned too much, the chain, engine sprocket, rear sprocket, transmission and rear wheel bearings wear more quickly. Some components may break if overloaded.

If the chain is too loose, the chain may fall off the engine sprocket or the rear sprocket. As a result, the rear wheel locks or the engine will be damaged.

- Check the chain tension regularly.
- Set the chain tension in accordance with the specification.

Preparatory work

- Check the chain tension. (📖 p. 120)

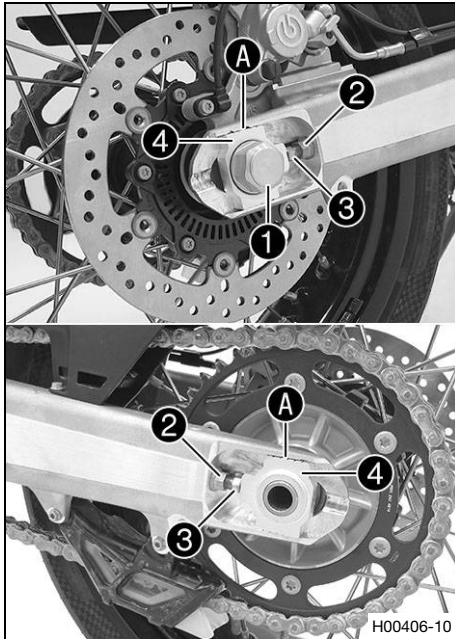

Main work

- Loosen nut **1**.
- Remove nuts **2** on the left and right.
- Adjust the chain tension by turning adjusting screws **3** left and right.

Guideline

Chain tension	5 mm (0.2 in)
Turn the adjusting screws 3 on the left and right so that the markings on the left and right chain adjusters 4 are in the same position relative to the reference marks A . The rear wheel is then correctly aligned.	



Info

The top chain section must be taut.
Chain wear is not always even. Repeat this measurement at different chain positions.

- Tighten nuts **2**.
- Make sure that chain adjusters **4** are fitted correctly on adjusting screws **3**.
- Tighten nut **1**.

Guideline

Nut, rear wheel spindle	M25x1.5	90 Nm (66.4 lbf ft)
-------------------------	---------	---------------------

12 SERVICE WORK ON THE CHASSIS

12.25 Checking the chain, rear sprocket, engine sprocket, and chain guide

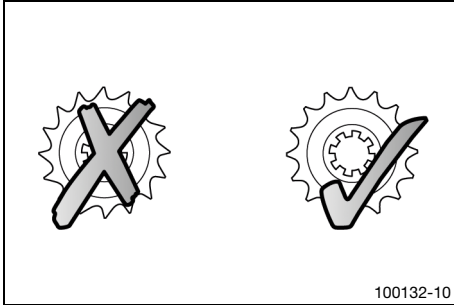

Preparatory work

- Raise the motorcycle with the rear lifting gear. (📖 p. 101)

Main work

- Shift the transmission into neutral.
- Check the rear sprocket and engine sprocket for wear.
 - » If the rear sprocket or engine sprocket is worn:
 - Change the drivetrain kit. 🛠️



Info

The engine sprocket, rear sprocket and chain should always be replaced together.

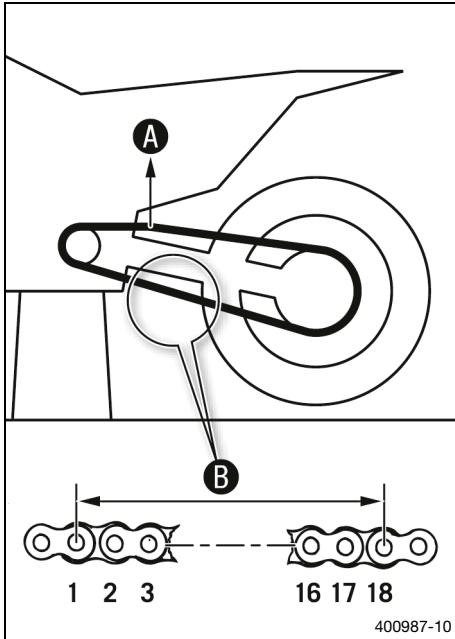

- Pull on the top section of the chain with the specified weight **A**.

Guideline

Weight of chain wear measurement	15 kg (33 lb.)
----------------------------------	----------------

- Measure distance **B** of 18 chain rollers in the lower chain section.

i Info

Chain wear is not always even, so you should repeat this measurement at different chain positions.

Maximum distance B from 18 chain rollers at the longest chain section	272 mm (10.71 in)
--	-------------------

- » If distance **B** is greater than the specified measurement:
 - Change the drivetrain kit. 🛠️

i Info

When a new chain is mounted, the rear sprocket and engine sprocket should also be changed.

New chains wear out faster on an old, worn rear sprocket or engine sprocket.

12 SERVICE WORK ON THE CHASSIS

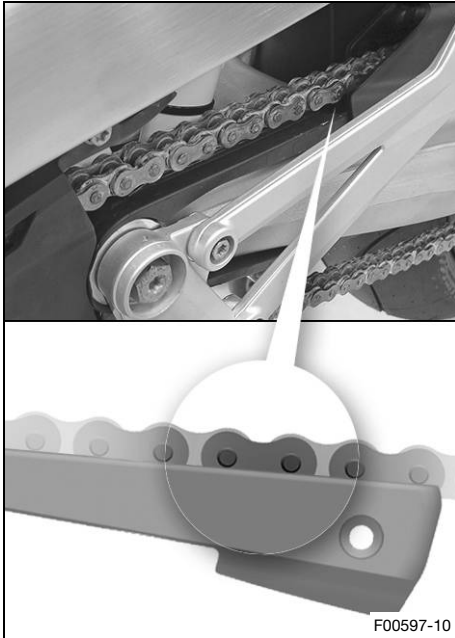

- Check the chain sliding guard for wear.
 - » If the lower edge of the chain pins is in line with, or below, the chain sliding guard:
 - Replace the chain sliding guard. 🛠️
- Check that the chain sliding guard is firmly seated.
 - » If the chain sliding guard is loose:
 - Tighten the screws on the chain sliding guard.

Guideline

Screw, chain sliding guard	M6	8 Nm (5.9 lbf ft) Loctite®243™
----------------------------	----	--

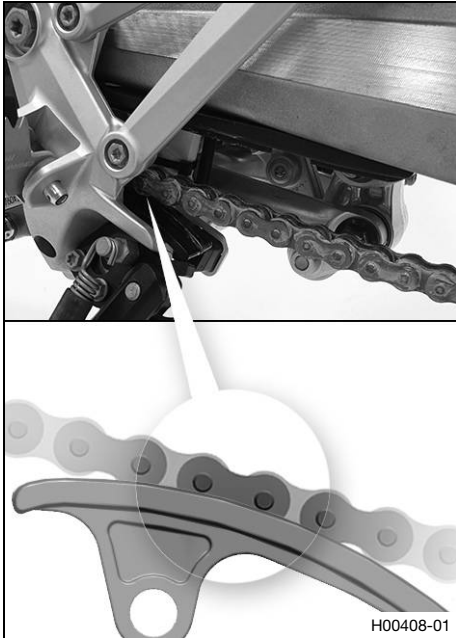

- Check the chain sliding piece for wear.
 - » If the lower edge of the chain pins is in line with or below the chain sliding piece:
 - Change the chain sliding piece. 🛠️
- Check that the chain sliding piece is firmly seated.
 - » If the chain sliding piece is loose:
 - Tighten the screw on the chain sliding piece.

Guideline

Screw, chain sliding piece	M8	15 Nm (11.1 lbf ft)
----------------------------	----	------------------------

12 SERVICE WORK ON THE CHASSIS

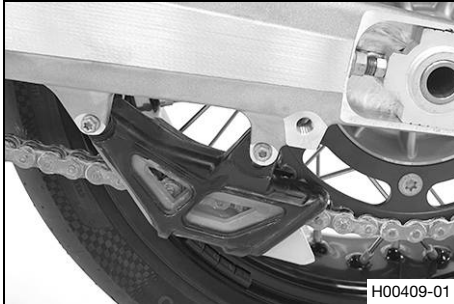
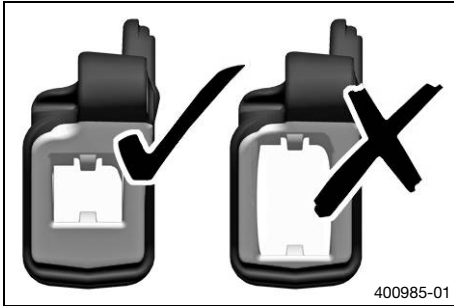

- Check the chain guide for wear.



Info

Wear can be seen on the front of the chain guide.

- » If the light part of the chain guide is worn:
 - Change the chain guide. 🛠️

- Check that the chain guide is firmly seated.
 - » If the chain guide is loose:
 - Tighten the screws on the chain guide.

Guideline

Screw, chain guide	M6	8 Nm (5.9 lbf ft)
--------------------	----	-------------------

Finishing work

- Remove the rear of the motorcycle from the wheel stand.
(📖 p. 102)

12.26 Adjusting the chain guide ↩

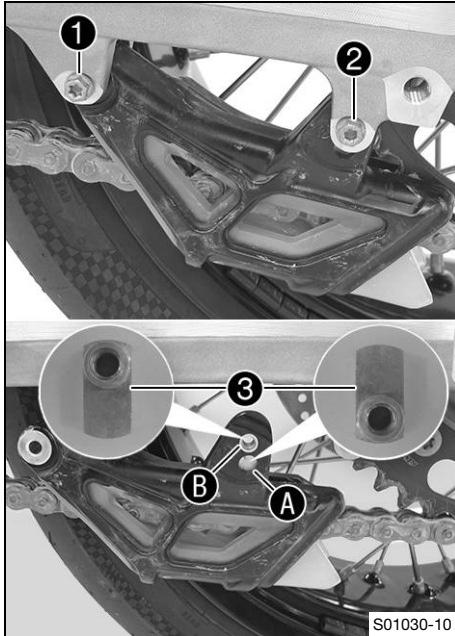

- Remove screws ① and ②. Take off the chain guide.

Condition

Number of teeth: ≤ 44 teeth

- Insert nut ③ in hole A. Position the chain guide.
- Mount and tighten screws ① and ②.

Guideline

Screw, chain guide	M6	8 Nm (5.9 lbf ft)
--------------------	----	-------------------

Condition

Number of teeth: ≥ 45 teeth

- Insert nut ③ in hole B. Position the chain guide.
- Mount and tighten screws ① and ②.

Guideline

Screw, chain guide	M6	8 Nm (5.9 lbf ft)
--------------------	----	-------------------

12 SERVICE WORK ON THE CHASSIS

12.27 Adjusting the basic position of the clutch lever

i Info

When the adjusting screw is turned clockwise, the clutch lever moves closer to the handlebar.

When the adjusting screw is turned counterclockwise, the clutch lever moves away from the handlebar.

The range of adjustment is limited.

Only turn the adjusting screw by hand, and do not use force.

Do not make any adjustments while riding.

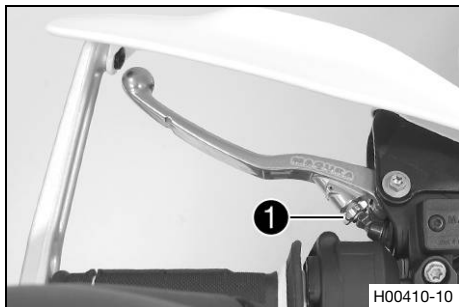

- Adjust the basic position of the clutch lever to your hand size by turning adjusting screw **1**.
- When adjusting the clutch lever, make sure to leave a minimum clearance to other parts of the vehicle.

Guideline

Minimum clearance	5 mm (0.2 in)
-------------------	---------------

12.28 Checking/correcting the fluid level of the hydraulic clutch



Warning

Skin irritation Brake fluid causes skin irritation.

- Keep brake fluid out of the reach of children.
- Wear suitable protective clothing and safety glasses.
- Do not allow brake fluid to come into contact with the skin, the eyes or clothing.
- Consult a doctor immediately if brake fluid has been swallowed.
- Rinse the affected area with plenty of water in the event of contact with the skin.
- Rinse eyes thoroughly with water immediately and consult a doctor if brake fluid comes into contact with the eyes.
- If brake fluid spills on to your clothing, change the clothing.



Note

Environmental hazard Hazardous substances cause environmental damage.

- Dispose of oils, grease, filters, fuel, cleaning agents, brake fluid, etc., correctly and in compliance with the applicable regulations.

12 SERVICE WORK ON THE CHASSIS

i Info

The fluid level rises with increasing wear of the clutch facing discs.

Never use DOT 5 brake fluid. It is silicone-based and purple in color. Oil seals and clutch lines are not designed for DOT 5 brake fluid.

Avoid contact between brake fluid and painted parts. Brake fluid attacks paint.

Only use clean brake fluid from a sealed container.

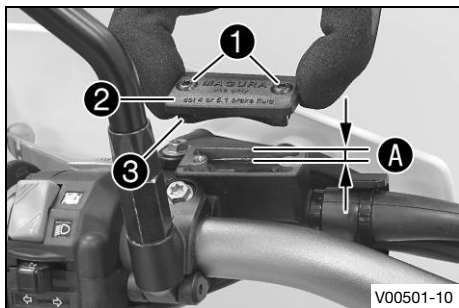

- Move the clutch fluid reservoir mounted on the handlebar to a horizontal position.
- Remove screws ①.
- Take off cover ② with membrane ③.
- Check the fluid level.

Fluid level A below container rim	4 mm (0.16 in)
--	----------------

- » If the fluid level does not meet specifications:
 - Correct the fluid level of the hydraulic clutch.

Brake fluid DOT 4 / DOT 5.1 (📖 p. 260)

- Position the cover with the membrane. Mount and tighten the screws.

**Info**

Clean up overflowed or spilled brake fluid immediately with water.



13 BRAKE SYSTEM

13.1 Anti-lock braking system (ABS)

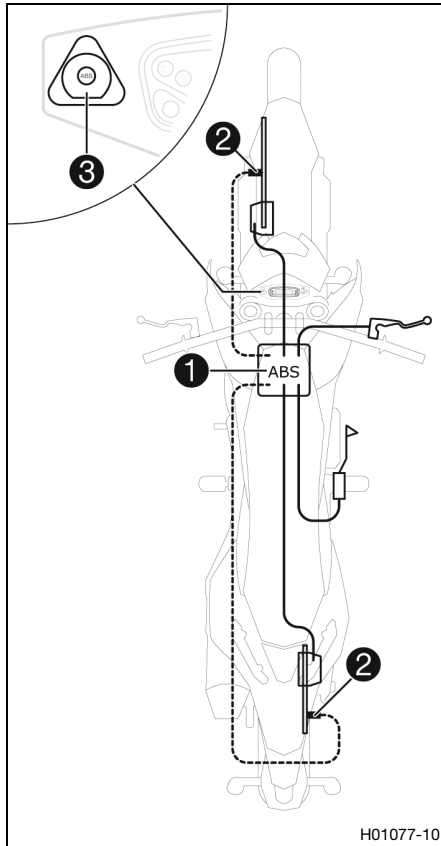

The ABS module **1**, consisting of a hydraulic unit, an ABS control unit, and a return pump, is located under the seat. One wheel speed sensor **2** is located in each case on the front and the rear wheel.



Warning

Danger of accidents Changes to the vehicle impair the function of the ABS.

- Only allow the rear wheel to spin with the front brake applied if the ABS is switched off (burn out).
- Do not make any changes to the suspension travel.
- Only use spare parts on the brake system which have been approved and recommended by Husqvarna Motorcycles.
- Only use tires/wheels approved by Husqvarna Motorcycles with the corresponding speed index.
- Maintain the specified tire pressure.
- Service work and repairs must be performed professionally. (Your authorized Husqvarna Motorcycles workshop will be glad to help.)

ABS is a safety system that prevents locking of the wheels when driving straight ahead without the influence of lateral forces.



Warning

Danger of accidents Driving aids can reduce the probability of a fall only within physical limits.

It is not always possible to compensate for extreme riding situations, for example with luggage loaded with a high center of gravity, varying road surfaces, steep descents or full braking without disengaging the gear.

- Adapt your riding style to the road conditions and your driving ability.



Warning

Danger of accidents An incorrectly selected ABS mode makes control of the vehicle considerably more difficult.

The ABS modes are each only suitable for certain conditions.

- Always select an ABS mode that is compatible with the surface of the ground.

ABS has two operating modes: the **Road** and **Supermoto**ABS modes.

In ABS mode **Road**, the ABS controls both wheels.

In ABS mode **Supermoto**, the ABS only controls the front wheel. There is no ABS control on the rear wheel. The ABS warning lamp  flashes slowly to remind you that the **Supermoto** ABS mode is enabled.



Info

In the **Supermoto** ABS mode, the rear wheel may lock and there is a risk of falling.
ABS mode **Supermoto** is only available in riding mode **SPORT**.

The ABS operates with two independent brake circuits (front and rear brakes). When the ABS control unit detects a locking tendency in a wheel, ABS begins regulating the brake pressure. The control function causes a slight pulsing of the hand and foot brake levers.

The ABS warning lamp  must light up after the ignition is switched on and go out after starting off. If it does not go out after starting off or if it lights up while riding, this indicates a fault in the ABS. In this case, the ABS is no longer enabled and the wheels may lock during braking. The brake system itself stays functional; only ABS control is not available.

The ABS warning lamp may also light up if the rotating speeds of the front and rear wheels differ greatly under extreme riding conditions, for example when making "wheelies" or if the rear wheel spins. This causes the ABS to switch off.

To reactivate the ABS, the vehicle must be stopped and the ignition switched off. The ABS is reactivated when the vehicle is switched on again. The ABS warning lamp goes out when you start off.

i Info

The motorcycle has an additional 5-D sensor. The 5-D sensor makes the ABS control dependent on the angle of inclination and pitch. This can prevent locking and slipping of the wheels during braking when the vehicle is inclined (riding in curves) within the physical limitations.

13.2 Adjusting the basic position of the hand brake lever



- Adjust the basic position of the hand brake lever to your hand size by turning adjusting wheel **1**.

i Info

Push the hand brake lever forward and turn the adjusting wheel.
Do not make any adjustments while riding.

13.3 Checking the brake discs



Warning

Danger of accidents Worn-out brake discs reduce the braking effect.

- Make sure that worn-out brake discs are replaced immediately. (Your authorized Husqvarna Motorcycles workshop will be glad to help.)

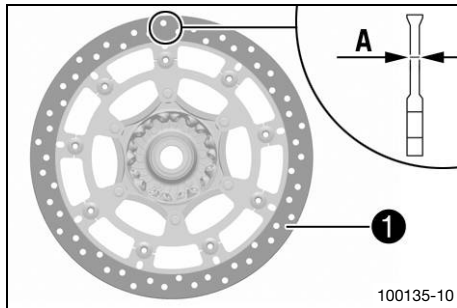

- Check the front and rear brake disc thickness at multiple points for the dimension **A**.



Info

Wear will reduce the thickness of the brake disc at contact surface **1** of the brake linings.

Brake discs - wear limit	
front	4.0 mm (0.157 in)
rear	4.5 mm (0.177 in)

- » If the brake disc thickness is less than the specified value.
 - Change the front brake disc. 🛠️
 - Change the rear brake disc. 🛠️
- Check the front and rear brake discs for damage, cracking, and deformation.

- » If the brake disc exhibits damage, cracking, or deformation:
 - Change the front brake disc. 🛠️
 - Change the rear brake disc. 🛠️



13.4 Checking the front brake fluid level



Warning

Danger of accidents An insufficient brake fluid level will cause the brake system to fail.

If the brake fluid level drops below the specified marking or the specified value, the brake system is leaking or the brake linings are worn down.

- Check the brake system and do not continue riding until the problem is eliminated. (Your authorized Husqvarna Motorcycles workshop will be glad to help.)



Warning

Danger of accidents Old brake fluid reduces the braking effect.

- Make sure that brake fluid for the front and rear brake is changed in accordance with the service schedule. (Your authorized Husqvarna Motorcycles workshop will be glad to help.)

13 BRAKE SYSTEM

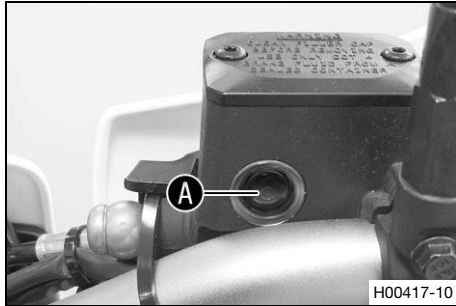

- Move the brake reservoir mounted on the handlebar to a horizontal position.
- Check the brake fluid level in the viewer.
 - » If the brake fluid level has dropped below the marking **A**:
 - Add front brake fluid. 🗨️ (📖 p. 140)

13.5 Adding front brake fluid 🗨️



Warning

Danger of accidents An insufficient brake fluid level will cause the brake system to fail.

If the brake fluid level drops below the specified marking or the specified value, the brake system is leaking or the brake linings are worn down.

- Check the brake system and do not continue riding until the problem is eliminated. (Your authorized Husqvarna Motorcycles workshop will be glad to help.)

**Warning**

Skin irritation Brake fluid causes skin irritation.

- Keep brake fluid out of the reach of children.
- Wear suitable protective clothing and safety glasses.
- Do not allow brake fluid to come into contact with the skin, the eyes or clothing.
- Consult a doctor immediately if brake fluid has been swallowed.
- Rinse the affected area with plenty of water in the event of contact with the skin.
- Rinse eyes thoroughly with water immediately and consult a doctor if brake fluid comes into contact with the eyes.
- If brake fluid spills on to your clothing, change the clothing.

**Warning**

Danger of accidents Old brake fluid reduces the braking effect.

- Make sure that brake fluid for the front and rear brake is changed in accordance with the service schedule. (Your authorized Husqvarna Motorcycles workshop will be glad to help.)

**Note**

Environmental hazard Hazardous substances cause environmental damage.

- Dispose of oils, grease, filters, fuel, cleaning agents, brake fluid, etc., correctly and in compliance with the applicable regulations.

i Info

Never use DOT 5 brake fluid. It is silicone-based and purple in color. Oil seals and brake lines are not designed for DOT 5 brake fluid.

Avoid contact between brake fluid and painted parts. Brake fluid attacks paint.

Only use clean brake fluid from a sealed container.

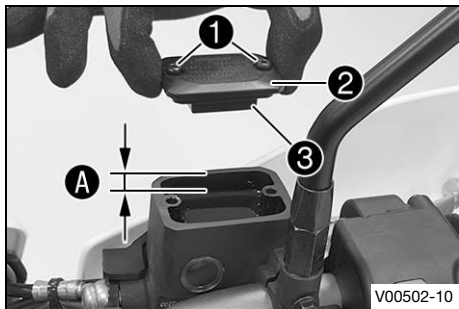

Preparatory work

- Check the front brake linings. (📖 p. 143)

Main work

- Move the brake reservoir mounted on the handlebar to a horizontal position.
- Remove screws ①.
- Take off cover ② with membrane ③.
- Add brake fluid to level A.

Guideline

Level A (brake fluid level below reservoir rim)	5 mm (0.2 in)
---	---------------

Brake fluid DOT 4 / DOT 5.1 (📖 p. 260)
--

- Position the cover with the membrane. Mount and tighten the screws.

**Info**

Clean up overflowed or spilled brake fluid immediately with water.



13.6 Checking the front brake linings

**Warning**

Danger of accidents Worn-out brake linings reduce the braking effect.

- Ensure that worn-out brake linings are replaced immediately. (Your authorized Husqvarna Motorcycles workshop will be glad to help.)

**Warning**

Danger of accidents Damaged brake discs reduce the braking effect.

If the brake linings are not changed in time, the brake lining carriers grind against the brake disc. As a consequence, the braking effect is greatly reduced and the brake discs are destroyed.

- Check the brake linings regularly.

13 BRAKE SYSTEM

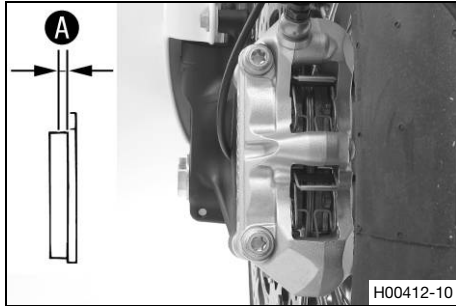

- Check the brake linings for minimum thickness **A**.

Minimum thickness A	$\geq 1 \text{ mm } (\geq 0.04 \text{ in})$
----------------------------	---

- » If the minimum thickness is less than specified:
 - Change the front brake linings. 🛠️
- Check the brake linings for damage and cracking.
 - » If there is wear or tearing:
 - Change the front brake linings. 🛠️

13.7 Checking the free travel of foot brake lever



Warning

Danger of accidents The brake system fails in the event of overheating.

If there is no free travel on the foot brake lever, pressure builds up in the brake system on the rear brake.

- Set the free travel on the foot brake lever in accordance with the specification.

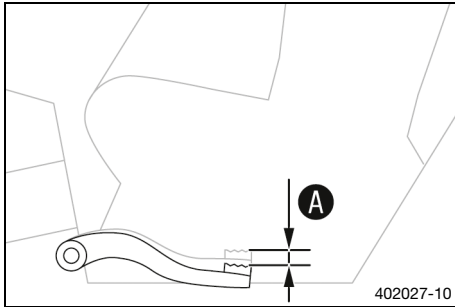

- Move the foot brake lever back and forth between the end stop and the contact to the foot brake cylinder piston and check free travel **A**.

Guideline

Free travel at foot brake lever	3 ... 5 mm (0.12 ... 0.2 in)
---------------------------------	------------------------------



Info

You will know that contact has been made with the foot brake cylinder piston when there is increased resistance when you activate the foot brake lever.

- » If the free travel does not meet specifications:
 - Adjust the basic position of the foot brake lever. 🛠️ (📖 p. 145)



13.8 Adjusting the basic position of the foot brake lever 🛠️



Warning

Danger of accidents The brake system fails in the event of overheating.

If there is no free travel on the foot brake lever, pressure builds up in the brake system on the rear brake.

- Set the free travel on the foot brake lever in accordance with the specification.

13 BRAKE SYSTEM

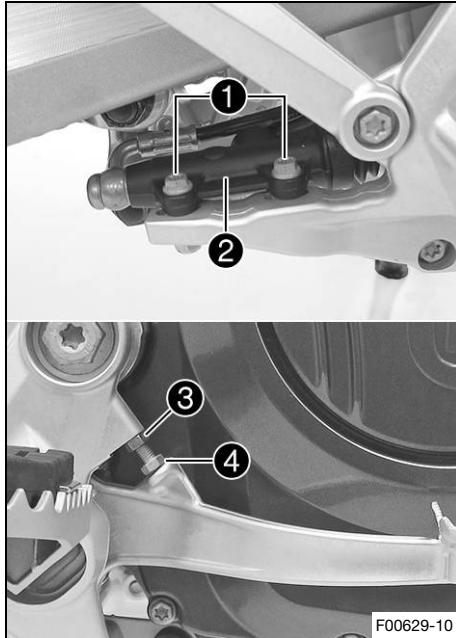

- Loosen fittings ① on foot brake cylinder ②.
- To adjust the basic position of the foot brake lever to individual requirements, loosen nut ③ and turn screw ④ accordingly.

i Info

The range of adjustment is limited. The screw must be screwed into the footrest bracket by at least four turns.

- Position foot brake cylinder ② so that the foot brake lever has the necessary free travel.
- Tighten fittings ①.

Guideline

Screw connection, foot brake cylinder	M6	10 Nm (7.4 lbf ft)
--	----	--------------------

- Check the free travel of the foot brake lever. (📖 p. 144)
- Tighten nut ③.

13.9 Checking the rear brake fluid level



Warning

Danger of accidents An insufficient brake fluid level will cause the brake system to fail.

If the brake fluid level drops below the **MIN** marking, the brake system is leaking or the brake linings are worn down.

- Check the brake system and do not continue riding until the problem is eliminated. (Your authorized Husqvarna Motorcycles workshop will be glad to help.)



Warning

Danger of accidents Old brake fluid reduces the braking effect.

- Make sure that brake fluid for the front and rear brake is changed in accordance with the service schedule. (Your authorized Husqvarna Motorcycles workshop will be glad to help.)

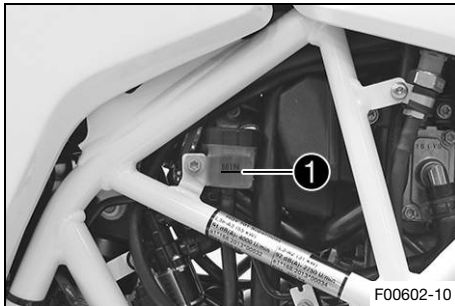

- Stand the vehicle upright.
- Check the brake fluid level in the brake fluid reservoir.
 - » If the fluid level reaches the **MIN** marking **1**:
 - Add rear brake fluid. 📖 (p. 148)

13.10 Adding rear brake fluid



Warning

Danger of accidents An insufficient brake fluid level will cause the brake system to fail.

If the brake fluid level drops below the **MIN** marking, the brake system is leaking or the brake linings are worn down.

- Check the brake system and do not continue riding until the problem is eliminated. (Your authorized Husqvarna Motorcycles workshop will be glad to help.)



Warning

Skin irritation Brake fluid causes skin irritation.

- Keep brake fluid out of the reach of children.
- Wear suitable protective clothing and safety glasses.
- Do not allow brake fluid to come into contact with the skin, the eyes or clothing.
- Consult a doctor immediately if brake fluid has been swallowed.
- Rinse the affected area with plenty of water in the event of contact with the skin.
- Rinse eyes thoroughly with water immediately and consult a doctor if brake fluid comes into contact with the eyes.
- If brake fluid spills on to your clothing, change the clothing.



Warning

Danger of accidents Old brake fluid reduces the braking effect.

- Make sure that brake fluid for the front and rear brake is changed in accordance with the service schedule. (Your authorized Husqvarna Motorcycles workshop will be glad to help.)



Note

Environmental hazard Hazardous substances cause environmental damage.

- Dispose of oils, grease, filters, fuel, cleaning agents, brake fluid, etc., correctly and in compliance with the applicable regulations.



Info

Never use DOT 5 brake fluid. It is silicone-based and purple in color. Oil seals and brake lines are not designed for DOT 5 brake fluid.

Avoid contact between brake fluid and painted parts. Brake fluid attacks paint.

Only use clean brake fluid from a sealed container.

Preparatory work

- Check the rear brake linings. (📖 p. 150)

13 BRAKE SYSTEM

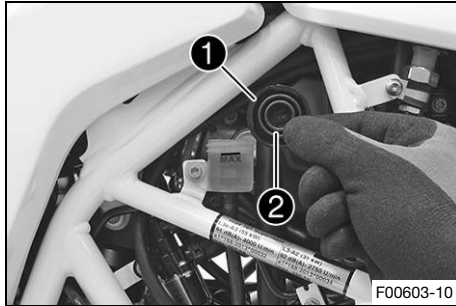

Main work

- Position the vehicle vertically.
- Remove screw cap ❶ with the washer and membrane ❷.
- Add brake fluid up to the **MAX** marking.

Brake fluid DOT 4 / DOT 5.1 (📖 p. 260)

- Mount the screw cover with washer and the membrane.



Info

Immediately clean up any brake fluid that has overflowed or spilled with water.

13.11 Checking the rear brake linings



Warning

Danger of accidents Worn-out brake linings reduce the braking effect.

- Ensure that worn-out brake linings are replaced immediately. (Your authorized Husqvarna Motorcycles workshop will be glad to help.)



Warning

Danger of accidents Damaged brake discs reduce the braking effect.

If the brake linings are not changed in time, the brake lining carriers grind against the brake disc. As a consequence, the braking effect is greatly reduced and the brake discs are destroyed.

- Check the brake linings regularly.

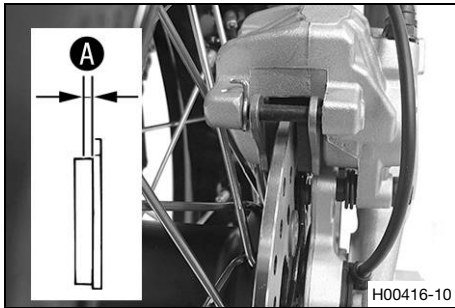

- Check the brake linings for minimum thickness **A**.

Minimum thickness A	$\geq 1 \text{ mm } (\geq 0.04 \text{ in})$
----------------------------	---

- » If the minimum thickness is less than specified:
 - Change the rear brake linings. 🛠️
- Check the brake linings for damage and cracking.
 - » If there is wear or tearing:
 - Change the rear brake linings. 🛠️

14.1 Removing the front wheel ↻

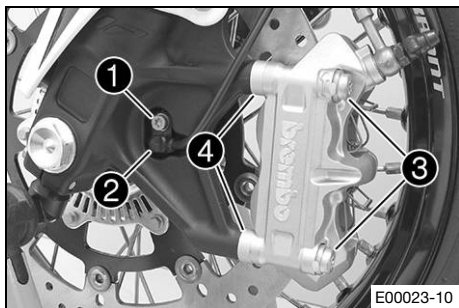

Preparatory work

- Raise the motorcycle with the rear lifting gear. (📖 p. 101)
- Lift the motorcycle with the front lifting gear. (📖 p. 103)

Main work

- Remove screw **1** and pull wheel speed sensor **2** out of the hole.
- Remove screws **3** and spacers **4**.
- Press back the brake linings by slightly tilting the brake caliper laterally on the brake disc.
- Pull the brake caliper carefully back from the brake disc and hang to the side.



Info

Do not operate the hand brake lever if the brake caliper has been removed.

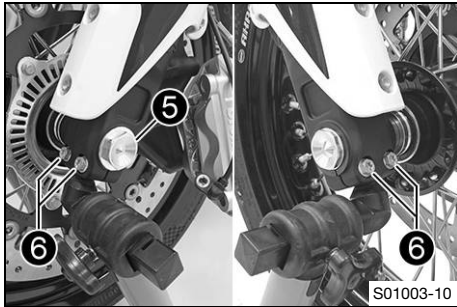

- Loosen screw 5 by several rotations.
- Loosen screws 6.
- Press on screw 5 to push the wheel spindle out of the axle clamp.
- Remove screw 5.



Warning

Danger of accidents Damaged brake discs reduce the braking effect.

- Always lay the wheel down in such a way that the brake disc is not damaged.

- Hold front wheel and remove wheel spindle. Take the front wheel out of the fork.
- Remove spacers 7.

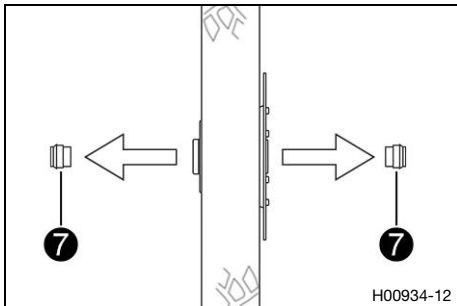

14.2 Installing the front wheel 🛞



Warning

Danger of accidents Oil or grease on the brake discs reduces the braking effect.

- Always keep the brake discs free of oil and grease.
- Clean the brake discs with brake cleaner when necessary.

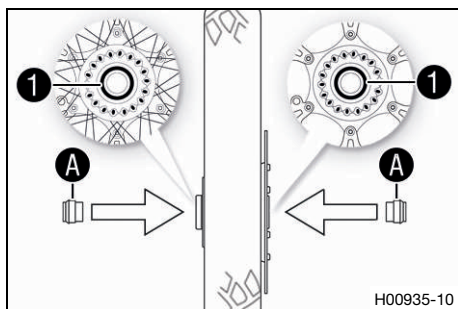

Main work

- Check the wheel bearing for damage and wear.
 - » If the wheel bearing is damaged or worn:
 - Change front wheel bearing. 🛞
- Clean and grease shaft seal rings ① and contact surfaces A of the spacers.

Long-life grease (📖 p. 263)

- Insert the spacers.

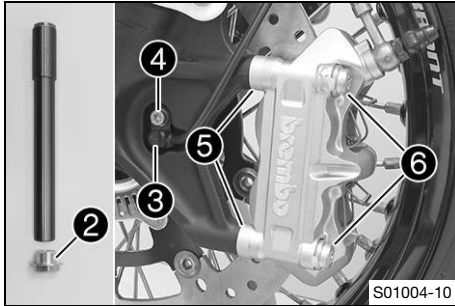

- Clean and grease the wheel spindle.

Long-life grease (📖 p. 263)

- Jack up the front wheel into the fork, position it, and insert the wheel spindle.
- Mount and tighten screw ②.

Guideline

Screw, front wheel spindle	M24x1.5	45 Nm (33.2 lbf ft)
----------------------------	---------	---------------------

- Position wheel speed sensor ③ in the hole.
- Mount and tighten screw ④.

Guideline

Screw, wheel speed sensor	M6	6 Nm (4.4 lbf ft)
---------------------------	----	-------------------

- Position the brake caliper on the brake disc.
 - ✓ The brake linings are correctly positioned.
- Position spacers ⑤. Mount screws ⑥, but do not tighten yet.

Guideline

Screw, front brake caliper	M10x1.25	45 Nm (33.2 lbf ft) Loctite®243™
----------------------------	----------	--

14 WHEELS, TIRES

- Operate the hand brake lever repeatedly until the brake linings are in contact with the brake disc and there is a pressure point. Secure the hand brake lever in the activated position.

✓ The brake caliper straightens.

- Tighten screws ⑥.

Guideline

Screw, front brake caliper	M10x1.25	45 Nm (33.2 lbf ft) Loctite®243™
----------------------------	----------	--

- Remove the locking piece of the hand brake lever.
 - Take the motorcycle off the front lifting gear. (📖 p. 104)
 - Operate the front brake and compress the fork a few times firmly.
- ✓ The fork legs straighten.
- Tighten screws ⑦.

Guideline

Screw, fork stub	M8	15 Nm (11.1 lbf ft)
------------------	----	---------------------



Finishing work

- Remove the rear of the motorcycle from the wheel stand. (📖 p. 102)

14.3 Removing the rear wheel ↻

Preparatory work

- Raise the motorcycle with the rear lifting gear. (📖 p. 101)

Main work

- Take the brake line out of the guide.

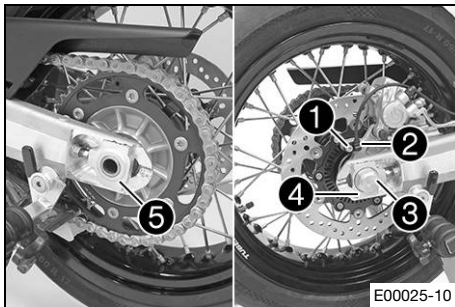
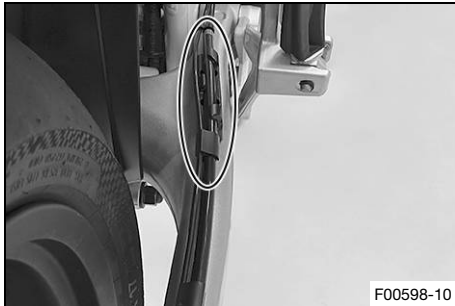

- Manually press the brake caliper toward the brake disc to push back the brake piston.
- Remove screw ① and pull wheel speed sensor ② out of the hole.
- Remove nut ③. Take off chain adjuster ④.
- Pull out wheel spindle ⑤ to the point where the chain adjuster is no longer in contact with the adjusting screw.

14 WHEELS, TIRES



- Push the rear wheel forward as far as possible and take the chain off the rear sprocket.



Info

Cover the components to protect them against damage.

-
- Hold the rear wheel and remove the wheel spindle.



Warning

Danger of accidents Damaged brake discs reduce the braking effect.

- Always lay the wheel down in such a way that the brake disc is not damaged.

-
- Take the rear wheel out of the link fork.



Info

Do not operate the foot brake when the rear wheel is removed.

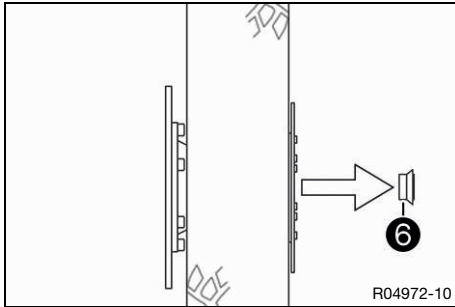

- Remove spacer ⑥.

14.4 Installing the rear wheel 🛠️



Warning

Danger of accidents Oil or grease on the brake discs reduces the braking effect.

- Always keep the brake discs free of oil and grease.
- Clean the brake discs with brake cleaner when necessary.



Warning

Danger of accidents There is no braking effect to start with at the rear brake after installing the rear wheel.

- Actuate the foot brake several times before going on a ride until you can feel a firm pressure point.

Main work

- Check the rear hub damping rubber pieces. 🛠️ (📖 p. 163)

14 WHEELS, TIRES

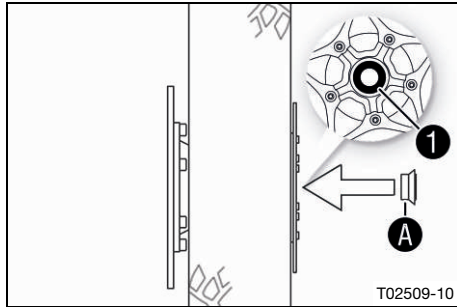

- Check the wheel bearing for damage and wear.
 - » If the wheel bearing is damaged or worn:
 - Change the rear wheel bearing. 🛠️
 - Clean and grease shaft seal ring **1** and contact surface **A** of the spacer.
- Long-life grease (📖 p. 263)
- Insert a spacer.

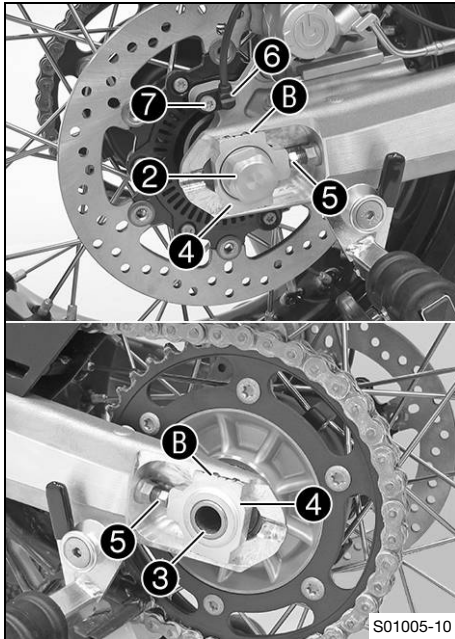

- Clean and grease the thread of the wheel spindle and nut ②.

Long-life grease (📖 p. 263)

- Clean and grease the wheel spindle.

Long-life grease (📖 p. 263)

- Mount the damping rubber and rear sprocket carrier in the rear wheel.
- Position the rear wheel.
 - ✓ The brake linings are correctly positioned.
- Push the rear wheel forward as far as possible and lay the chain on the rear sprocket.
- Mount wheel spindle ③ and chain adjuster ④. Mount nut ②, but do not tighten yet.
- Make sure that chain adjusters ④ are fitted correctly on adjusting screws ⑤.

Guideline

In order for the rear wheel to be correctly aligned, the markings on the left and right chain adjusters must be in the same position relative to reference markings ⑧.



Info

Mount left and right chain adjusters ④ in the same position.

14 WHEELS, TIRES

- Tighten nut ②.

Guideline

Nut, rear wheel spindle	M25x1.5	90 Nm (66.4 lbf ft)
-------------------------	---------	---------------------

- Position wheel speed sensor ⑥ in the hole.

- Mount and tighten screw ⑦.

Guideline

Screw, wheel speed sensor	M6	6 Nm (4.4 lbf ft)
---------------------------	----	-------------------

- Position the brake line in the guide.
- Operate the foot brake lever repeatedly until the brake linings are in contact with the brake disc and there is a pressure point.



Finishing work

- Remove the rear of the motorcycle from the wheel stand. (📖 p. 102)
- Check the chain tension. (📖 p. 120)

14.5 Checking the rear hub damping rubber pieces 🛠️

i Info

The engine power is transmitted from the rear sprocket to the rear wheel via the 6 damping rubber pieces. They eventually wear out during operation. If the damping rubber pieces are not changed in time, the rear sprocket carrier and the rear hub will be damaged.

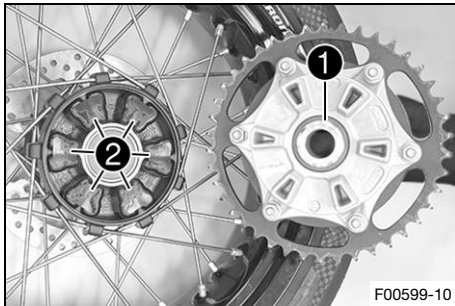

Preparatory work

- Raise the motorcycle with the rear lifting gear. (📖 p. 101)
- Remove the rear wheel. 🛠️ (📖 p. 157)

Main work

- Check bearing ❶.
 - » If the bearing is damaged or worn:
 - Change the bearing of the rear sprocket carrier. 🛠️
- Check the damping rubber pieces ❷ of the rear hub for damage and wear.
 - » If the damping rubber pieces of the rear hub are damaged or worn:
 - Change all the damping rubber pieces of the rear hub.

14 WHEELS, TIRES



- Lay the rear wheel on a workbench with the rear sprocket facing upwards and insert the wheel spindle in the hub.
- To check play **A**, hold the rear wheel tight and try to turn the rear sprocket with your hand.

i Info

Measure the play on the outside of the rear sprocket.

Play of damping rubber pieces on rear wheel	$\leq 5 \text{ mm } (\leq 0.2 \text{ in})$
---	--

- » If clearance **A** is larger than the specified value:
 - Change all the damping rubber pieces of the rear hub.

Finishing work

- Install the rear wheel. 🛠️ (📖 p. 159)
- Remove the rear of the motorcycle from the wheel stand. (📖 p. 102)
- Check the chain tension. (📖 p. 120)

14.6 Checking the tire condition



Warning

Danger of accidents If a tire bursts while riding, the vehicle becomes uncontrollable.

- Ensure that damaged or worn tires are replaced immediately. (Your authorized Husqvarna Motorcycles workshop will be glad to help.)



Warning

Danger of crashing Different tire tread patterns on the front and rear wheel impair the handling characteristic.

Different tire tread patterns can make the vehicle significantly more difficult to control.

- Make sure that only tires with a similar tire tread pattern are fitted to the front and rear wheel.



Warning

Danger of accidents Non-approved or non-recommended tires and wheels impact the handling characteristic.

- Only use tires/wheels approved by Husqvarna Motorcycles with the corresponding speed index.

14 WHEELS, TIRES



Warning

Danger of accidents New tires have reduced road grip.

The contact surface on new tires is not yet roughened.

- Run in new tires with moderate riding at alternating angles.
Running-in phase 200 km (124 mi)



Info

The type, condition, and pressure of the tires all have a major impact on the handling characteristic of the motorcycle.

Worn tires have a negative effect on handling characteristics, especially on wet surfaces.

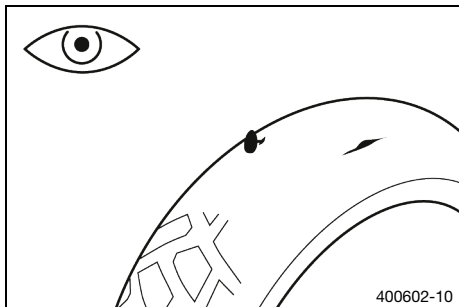

- Check the front and rear tires for cuts, run-in objects, and other damage.
 - » If the tires have cuts, run-in objects, or other damage:
 - Change the tires. 🛠️
- Check the tread depth.



Info

Adhere to the legally required minimum tread depth.

Minimum tread depth	$\geq 2 \text{ mm } (\geq 0.08 \text{ in})$
---------------------	---

- » If the tread depth is less than the minimum tread depth:
 - Change the tires. 🛠️

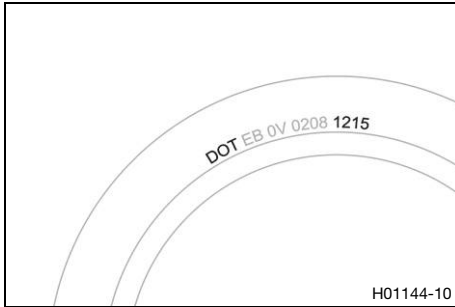

- Check the tire age.



Info

The tire date of manufacture is usually contained in the tire label and is indicated by the last four digits of the **DOT** number. The first two digits indicate the week of manufacture and the last two digits the year of manufacture.

Husqvarna Motorcycles recommends that the tires be changed after 5 years at the latest, regardless of the actual state of wear.

- » If the tires are more than 5 years old:
 - Change the tires. 🛠️



14 WHEELS, TIRES

14.7 Tubeless tire system

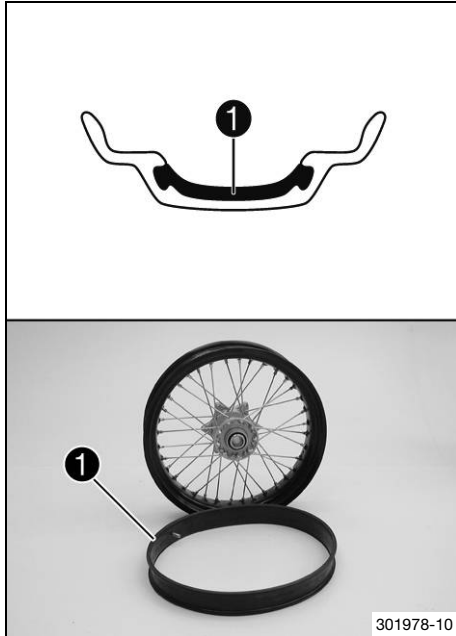

This vehicle uses a tubeless tire system in which a rim seal band **1** is used instead of the conventional tube.

The advantages of the tubeless system lie in the absence of danger from a faulty tube. This greatly reduces the risk of a sudden loss in pressure.

The moments of inertia of these wheels are smaller than in conventional spoked wheels with a tube. This results in better handling and riding comfort.

The rigid rim design results in a wire spoke wheel that is almost entirely maintenance-free.

Husqvarna Motorcycles recommends that the rim seal band is changed after 5 years at the latest, regardless of the actual state of wear.

14.8 Checking tire pressure



Info

Low tire pressure leads to abnormal wear and overheating of the tire.
Correct tire pressure ensures optimal riding comfort and maximum tire service life.

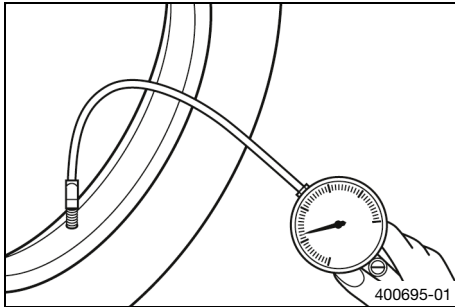

- Remove the protection cap.
- Check the tire pressure when the tires are cold.

Tire pressure when solo	
front	2.0 bar (29 psi)
rear	2.0 bar (29 psi)

Tire pressure with passenger / full payload	
front	2.0 bar (29 psi)
rear	2.2 bar (32 psi)

- » If the tire pressure does not meet specifications:
 - Correct the tire pressure.
- Mount the protection cap.



14.9 Checking spoke tension



Warning

Danger of accidents Incorrectly tensioned spokes impair the handling characteristic and result in secondary damage.

The spokes break due to being overloaded if they are too tightly tensioned. If the tension in the spokes is too low, then lateral and radial run-out will form in the wheel. Other spokes will become looser as a result.

- Check spoke tension regularly, and in particular on a new vehicle. (Your authorized Husqvarna Motorcycles workshop will be glad to help.)



Info

A loose spoke can unbalance the wheel and other spokes may loosen within a short period. If the spokes are too tight, they can break due to local overload. Check the spoke tension regularly, especially on a new motorcycle.

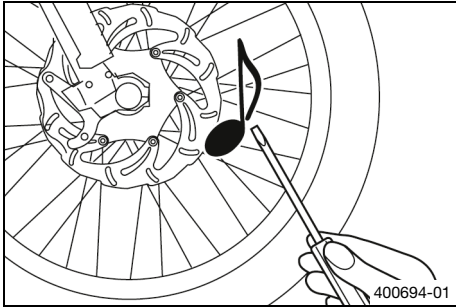

- Strike each spoke briefly using a screwdriver blade.



Info

The frequency of the sound depends on the spoke length and spoke diameter. If you hear different tone frequencies from different spokes of equal length and diameter, this is an indication of different spoke tensions.

You should hear a high note.

- » If the spoke tension differs:
 - Correct the spoke tension. 🛠️



14 WHEELS, TIRES

14.10 Using tire repair spray

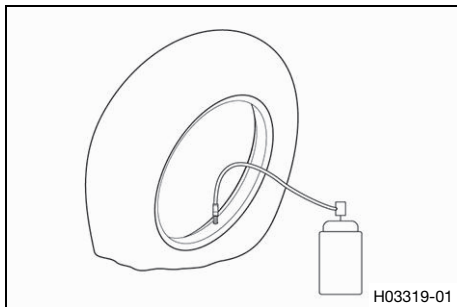

Warning

Danger of accidents Incorrect use of tire repair spray will result in the repaired tire losing pressure.

Tire repair spray cannot be used for all types of damage.

- Observe the instructions and specifications of the manufacturer of the tire repair spray.
- After repairing a tire with tire repair spray, ride slowly and carefully.
- Ride no further than to the nearest workshop and have the tire changed.

Tire repair spray should only be used in an emergency. We recommend transporting the broken down vehicle to the nearest workshop instead of using tire repair spray.

15.1 Removing the 12-V battery ↴



Warning

Risk of injury Battery acid and battery gases cause serious chemical burns.

- Keep 12 V batteries out of the reach of children.
- Wear suitable protective clothing and safety glasses.
- Avoid contact with battery acid and battery gases.
- Keep sparks or open flames away from the 12 V battery.
- Only charge 12 V batteries in well-ventilated rooms.
- Rinse the affected area immediately with plenty of water in the event of contact with the skin.
- Rinse eyes with water for at least 15 minutes and consult a doctor immediately if battery acid and battery gases get into the eyes.

Preparatory work

- Remove the seat. (📖 p. 109)

15 ELECTRICAL SYSTEM

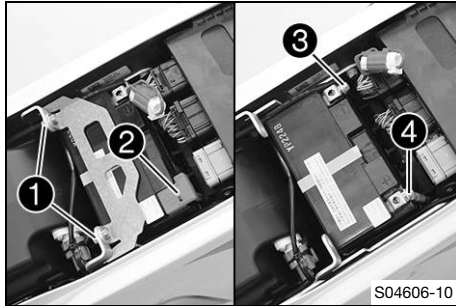

Main work

- Remove screws ①.
- Push the retaining bracket toward the rear and remove it.
- Take off positive terminal cover ②.
- Disconnect negative cable ③ from the 12-V battery.
- Disconnect positive cable ④ from the 12-V battery.
- Lift out the 12-V battery.



Info

Never operate the motorcycle with a discharged 12-V battery or without a 12-V battery. In both cases, electrical components and safety devices can be damaged. The vehicle will therefore no longer be roadworthy.

15.2 Installing the 12-V battery ↘

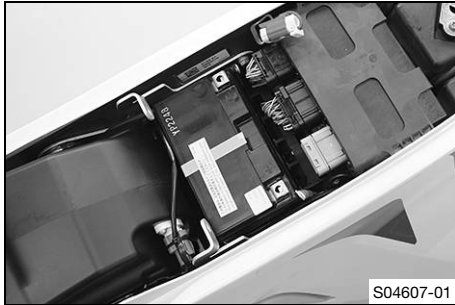

Main work

- Insert the 12-V battery into the battery compartment with the terminals facing to the rear.

12-V battery (YTZ10S) (📖 p. 249)

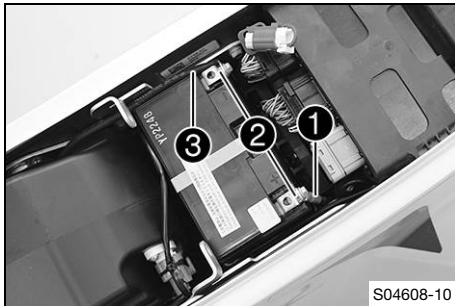

- Position positive cable ① with washer ②.
- Position negative cable ③ with washer ②.
- Mount and tighten the screw.

Guideline

Screw, battery terminal	M6	4.5 Nm (3.32 lbf ft)
-------------------------	----	----------------------

15 ELECTRICAL SYSTEM

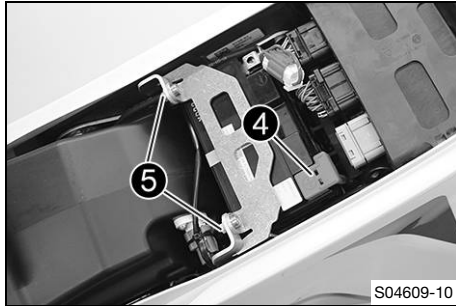

- Position positive terminal cover 4.
- Position retaining bracket and mount and tighten screws 5.

Guideline

Remaining screws, chassis	M6	10 Nm (7.4 lbf ft)
------------------------------	----	--------------------

Finishing work

- Mount the seat. (📖 p. 109)
- Set the clock. (🕒 p. 47)

15.3 Charging the 12-V battery ↴



Warning

Risk of injury Battery acid and battery gases cause serious chemical burns.

- Keep 12 V batteries out of the reach of children.
- Wear suitable protective clothing and safety glasses.
- Avoid contact with battery acid and battery gases.
- Keep sparks or open flames away from the 12 V battery.
- Only charge 12 V batteries in well-ventilated rooms.
- Rinse the affected area immediately with plenty of water in the event of contact with the skin.
- Rinse eyes with water for at least 15 minutes and consult a doctor immediately if battery acid and battery gases get into the eyes.



Note

Environmental hazard 12 V batteries contain environmentally hazardous materials.

- Do not dispose of 12 V batteries as household waste.
- Dispose of 12 V batteries at a collection point for used batteries.



Note

Environmental hazard Hazardous substances cause environmental damage.

- Dispose of oils, grease, filters, fuel, cleaning agents, brake fluid, etc., correctly and in compliance with the applicable regulations.

i Info

Even when there is no load on the 12-V battery, it discharges steadily each day.

The charging level and the method of charging are very important for the service life of the 12-V battery. Rapid recharging with a high charging current shortens the service life of the battery.

If the charging current, charging voltage, or charging time is exceeded, electrolyte escapes through the safety valves. This reduces the capacity of the 12-V battery.

If the 12-V battery is depleted by repeated starting, the 12-V battery must be charged immediately.

If the 12-V battery is left in a discharged state for an extended period, it will become deeply discharged and sulfating occurs, destroying the battery.

The 12-V battery is maintenance-free. The acid level does not have to be checked.

Preparatory work

- Remove the seat. (📖 p. 109)
- Remove the 12-V battery. 🛠️ (📖 p. 173)

Main work

- Connect a battery charger to the 12-V battery. Switch on the battery charger.

Guideline

The battery charger must be suitable for the 12-V battery.

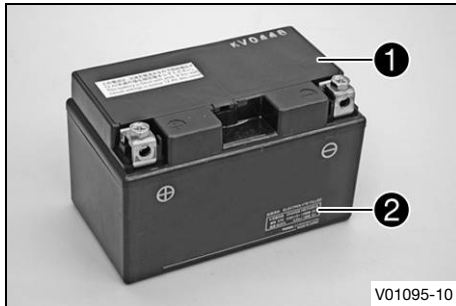

i Info

Never remove cover **1**.



Charge the 12-V battery to a maximum of 10 % of the capacity specified on battery housing **2**.

- Switch off the battery charger after charging and disconnect from the 12-V battery.

Guideline

The charging current, charging voltage, and charging time must not be exceeded.	
Recharge the 12-V battery regularly when the motorcycle is not being used	3 months

Finishing work

- Install the 12-V battery.  (p. 175)
- Mount the seat.  (p. 109)
- Set the clock.  (p. 47)



15.4 Changing the main fuse



Warning

Fire hazard Incorrect fuses overload the electrical system.

- Only use fuses with the required ampere value.
- Do not bypass or repair fuses.

i Info

The main fuse protects all electrical power consumers of the vehicle. It is in the housing of the starter relay next to the 12-V battery.

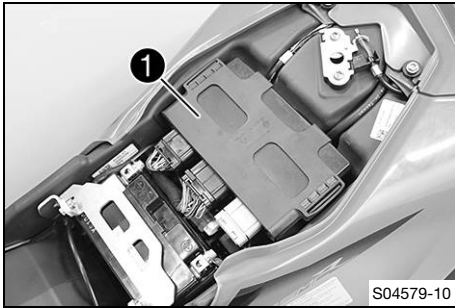

Preparatory work

- Remove the seat. (📖 p. 109)

Main work

- Pull engine electronics control unit **1** off the holder and hang it to the side.
- Take off protection caps **2**.

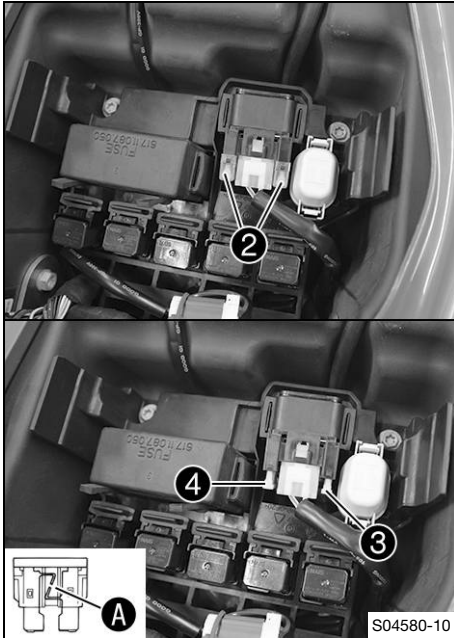

- Remove a defective main fuse ③ with needle nose pliers.



Info

A faulty fuse has a burned-out fuse wire **A**.
A spare fuse ④ is located in the starter relay.

- Insert a new main fuse.

Fuse (58011109130) (📖 p. 249)



Info

Insert a new spare fuse into the starter relay to have it available when needed.

- Check that the electrical system is functioning properly.
- Mount the protection caps.
- Position the engine electronics control unit.

Finishing work

- Mount the seat. (📖 p. 109)
- Set the clock. (📖 p. 47)



15.5 Changing the ABS fuses



Warning

Fire hazard Incorrect fuses overload the electrical system.

- Only use fuses with the required ampere value.
- Do not bypass or repair fuses.



Info

Two fuses for the ABS are located under the seat. These fuses protect the return pump and the hydraulic unit of the ABS. The third fuse, which protects the ABS control unit, is located in the fuse box.

Preparatory work

- Remove the seat. (📖 p. 109)
- Pull off engine electronics control unit from the holder and hang it to the side.

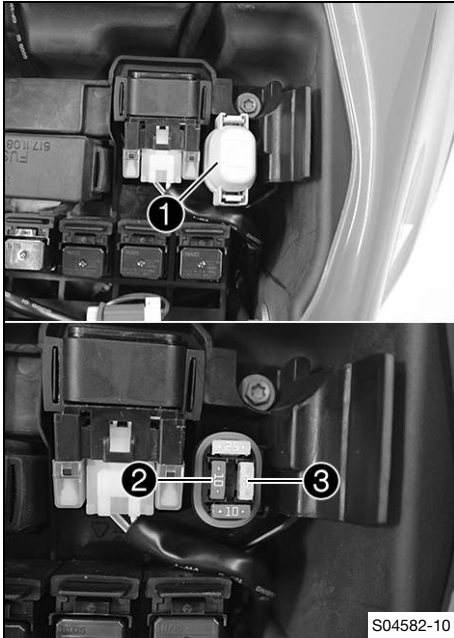

To change the fuse of the ABS hydraulic unit:

- Take off protection cap ①.
- Remove the fuse ② of the ABS hydraulic unit.
- Insert a new fuse.

Fuse (75011088010) (📖 p. 249)

- Mount the protection cap.

To change the fuse of the ABS return pump:

- Take off protection cap ①.
- Remove the fuse ③ of the ABS return pump.
- Insert a new fuse.

Fuse (75011088025) (📖 p. 249)

- Mount the protection cap.

Finishing work

- Position the engine electronics control unit.
- Mount the seat. (📖 p. 109)



15.6 Changing the fuses of individual electrical power consumers



Info

The fuse box containing the fuses of individual electrical power consumers is located under the seat.

Preparatory work

- Remove the seat. (📖 p. 109)
- Pull off engine electronics control unit from the holder and hang it to the side.

Main work

- Open fuse box cover **1**.



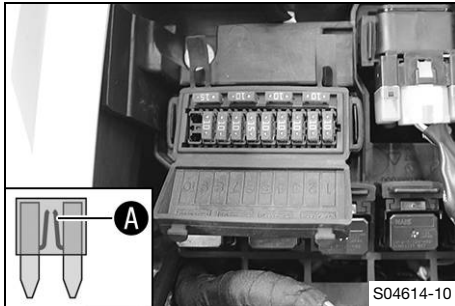

- Remove the faulty fuse.

Guideline

Fuse 1 - 10 A - ignition, combination instrument, clock, engine electronics control unit
Fuse 2 - 10 A - ignition, combination instrument, engine electronics control unit
Fuse 3 - 10 A - fuel pump
Fuse 4 - 10 A - radiator fan
Fuse 5 - 10 A - horn, brake light, turn signal
Fuse 6 - 15 A - high beam, low beam, position light, tail light, license plate lamp
Fuse 7 - 10 A - for auxiliary equipment ACC 1 (permanent positive)
Fuse 8 - 10 A - for auxiliary equipment ACC 2 (ignition plus), USB charging socket
Fuse 9 - 10 A - ABS
Fuse 10 - not assigned
Fuse SPARE - 10 A/15 A - spare fuses



Info

A faulty fuse has a burned-out fuse wire **A**.



Warning

Fire hazard Incorrect fuses overload the electrical system.

- Only use fuses with the required ampere value.
- Do not bypass or repair fuses.

- Insert the spare fuse with the correct rating.

Fuse (75011088010) (📖 p. 249)

Fuse (75011088015) (📖 p. 249)



Tip

Put a spare fuse in the fuse box so that it is available if needed.

- Check the function of the electrical power consumer.
- Close the fuse box cover.
- Position the engine electronics control unit.

Finishing work

- Mount the seat. (📖 p. 109)

15.7 Removing the headlight mask with the headlight

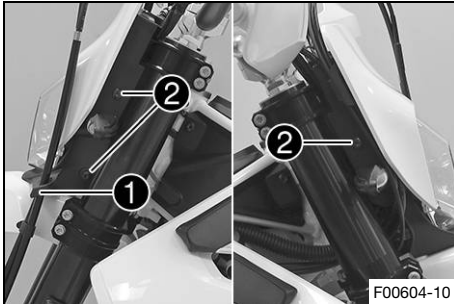

- Cover the fender with a cloth to protect it from damage.
- Detach the brake line and wiring harness from holder **1**.
- Remove screws **2** on both sides.
- Swivel the headlight mask forward.

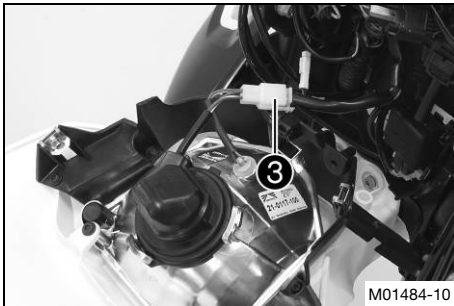

- Disconnect plug-in connector **3** of the headlight.
- Take off the headlight mask.



15.8 Installing the headlight mask with the headlight

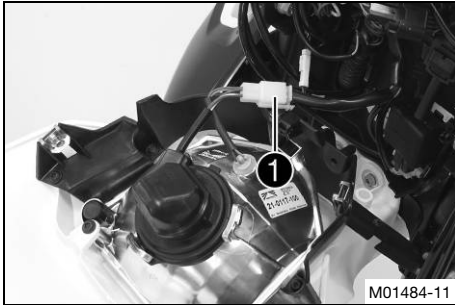

Main work

- Connect plug-in connector **1** of the headlight.
- Check that the lighting is functioning properly.

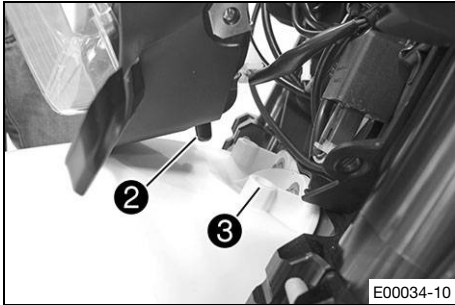

- Remove the cloth from the fender and position the headlight mask.
- ✓ Both holding lugs **2** engage in drilled holes **3** of the fender.

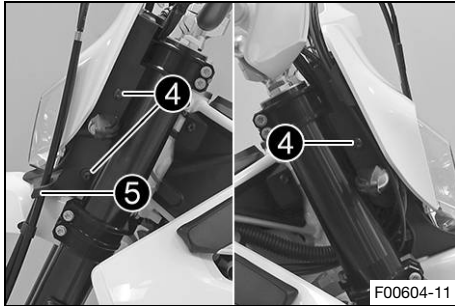

- Mount and tighten screws ④.

Guideline

Screw, headlight mask	M5	5 Nm (3.7 lbf ft)
-----------------------	----	-------------------

- Mount the brake line and wiring harness in holder ⑤.

Finishing work

- Check the headlight setting. (📖 p. 192)



15.9 Changing the headlight bulb

Note

Damage to reflector Grease on the reflector reduces the light intensity.

Grease on the bulb will evaporate due to the heat and be deposited on the reflector.

- Clean and degrease the bulbs before mounting.
- Do not touch the bulbs with your bare hands.

Preparatory work

- Remove the headlight mask with the headlight. (📖 p. 187)

15 ELECTRICAL SYSTEM

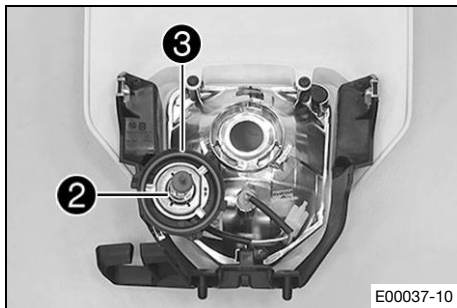
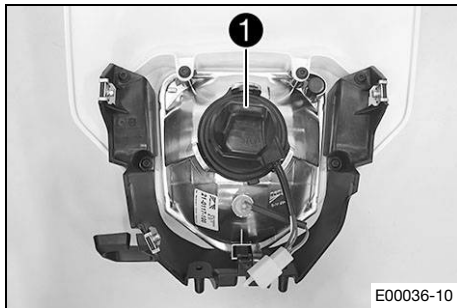

Main work

- Turn protection cap ① together with the underlying bulb socket counterclockwise all the way and remove it.

- Pull out headlight bulb ②.
- Insert the new headlight bulb.

Headlight (H4/socket P43t) (📖 p. 249)

- Insert the protection cap with the bulb socket into the reflector and turn it clockwise all the way.



Info

Ensure that O-ring ③ is seated properly.

Finishing work

- Install the headlight mask with the headlight. (📖 p. 188)
- Check the headlight setting. (📖 p. 192)

15.10 Changing the parking light bulb

Note

Damage to reflector Grease on the reflector reduces the light intensity.

Grease on the bulb will evaporate due to the heat and be deposited on the reflector.

- Clean and degrease the bulbs before mounting.
- Do not touch the bulbs with your bare hands.

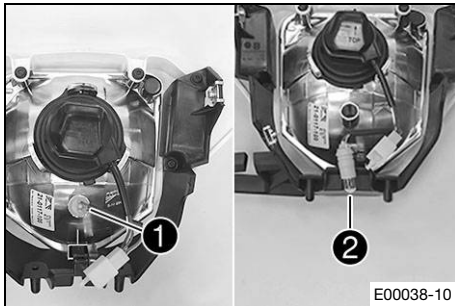

Preparatory work

- Remove the headlight mask with the headlight. (📖 p. 187)

Main work

- Pull bulb socket ① out of the reflector.
- Pull parking light bulb ② out of the bulb socket.
- Insert a new parking light bulb in the bulb socket.

Position light (W5W / socket W2.1x9.5d) (📖 p. 250)

- Insert the bulb socket in the reflector.

Finishing work

- Install the headlight mask with the headlight. (📖 p. 188)
- Check the headlight setting. (📖 p. 192)



15.11 Checking the headlight setting

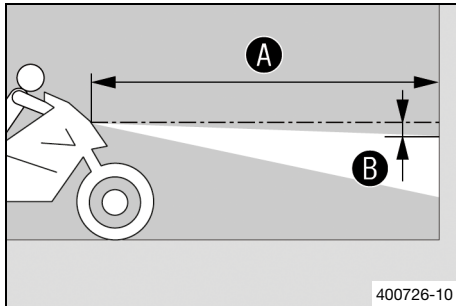

- Position the vehicle upright on a horizontal surface in front of a light wall and make a marking at the height of the center of the low beam headlight.
- Make another mark at a distance **B** under the first marking.

Guideline

Distance B	5 cm (2 in)
-------------------	-------------

- Position the vehicle vertically at a distance **A** away from the wall.

Guideline

Distance A	5 m (16 ft)
-------------------	-------------

- The rider now mounts the motorcycle with luggage and passenger if applicable.
- Switch on the low beam.
- Check the headlight setting.

The light-dark boundary must be exactly on the lower marking when the motorcycle is ready to be operated with the rider mounted along with any luggage and a passenger if applicable.

- » If the boundary between light and dark does not meet specifications:
 - Adjust the headlight range. (📖 p. 193)

15.12 Adjusting the headlight range



Preparatory work

- Check the headlight setting. (📖 p. 192)

Main work

- Loosen screw ❶.
- Adjust the headlight range by pivoting the headlight.

Guideline

The boundary between light and dark must be exactly on the lower mark for a motorcycle with rider (instructions on how to apply the mark: Checking the headlight setting).



Info

If you have a payload, you may have to correct the headlight range.

- Tighten screw ❶.



15 ELECTRICAL SYSTEM

15.13 ACC1 and ACC2

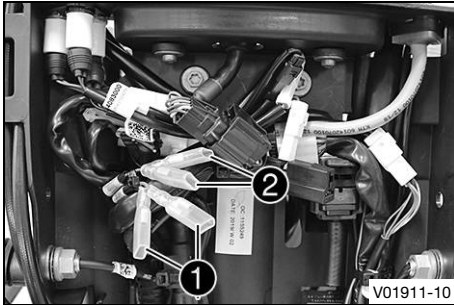

Installation location

- The power supplies ACC1 ① and ACC2 ② are located behind the headlight mask.

i Info

The power supplies are protected by a fuse; however, this fuse also protects other electrical power consumers. The maximum continuous load is therefore significantly lower than the value of the fuse. Do not use a stronger fuse.

15.14 Diagnostics connector

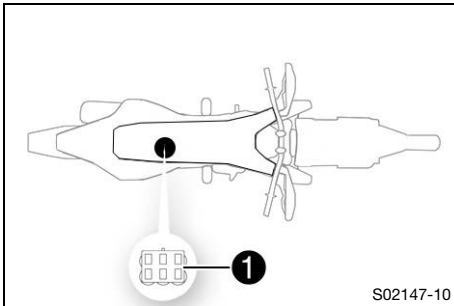

Diagnostics connector ① is located under the engine electronics control unit.

16.1 Cooling system

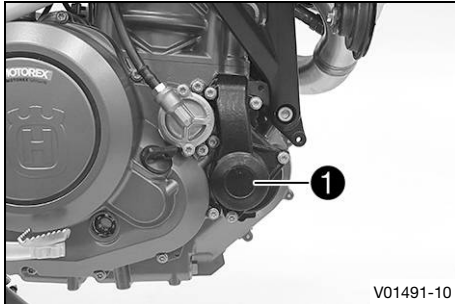

Water pump ❶ in the engine ensures forced circulation of the coolant.

The pressure resulting from the warming of the cooling system is regulated by a valve in radiator cap ❷. Heat expansion causes excess coolant to flow into compensating tank ❸. When the temperature falls, this surplus coolant is sucked back into the cooling system. This ensures that operating the vehicle at the specified coolant temperature will not result in a risk of malfunctions.

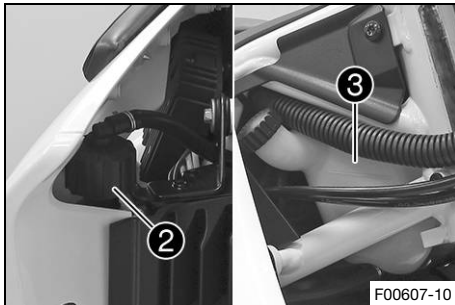

125 °C (257 °F)

The coolant is cooled by the air stream and a radiator fan, which is activated at high temperature.

The lower the speed, the less the cooling effect. Dirty cooling fins also reduce the cooling effect.

16.2 Checking the antifreeze and coolant level



Warning

Danger of scalding During motorcycle operation, the coolant gets very hot and is under pressure.

- Do not open the radiator, the radiator hoses or other cooling system components if the engine or the cooling system are at operating temperature.
- Allow the cooling system and the engine to cool down before you open the radiator, the radiator hoses or other components of the cooling system.
- In the event of scalding, rinse the area affected immediately with lukewarm water.



Warning

Danger of poisoning Coolant is toxic and a health hazard.

- Keep coolant out of the reach of children.
- Do not allow coolant to come into contact with the skin, the eyes and clothing.
- Consult a doctor immediately if coolant is swallowed.
- Rinse the affected area immediately with plenty of water in the event of contact with the skin.
- Rinse eyes thoroughly with water and consult a doctor immediately if coolant gets into the eyes.
- Change clothing if coolant spills onto your clothing.

Condition

The engine is cold.

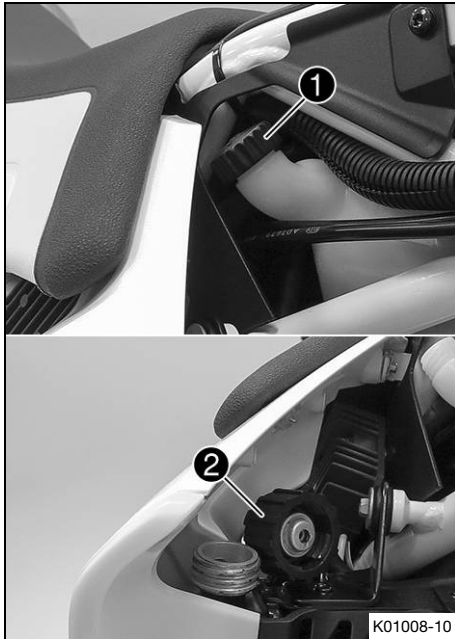

- Stand the motorcycle on its side stand on a horizontal surface.
- Remove cover ① of the compensating tank.
- Remove radiator cap ②.
- Check the antifreeze in the coolant.

-25 ... -45 °C (-13 ... -49 °F)

- » If the antifreeze in the coolant does not match the specified value:
 - Correct the antifreeze in the coolant.
- Check the coolant level in the compensating tank.

The coolant level must be between the two markings.

- » If the coolant level does not match the specified value:
 - Correct the coolant level.

Coolant (📖 p. 260)

- Mount cover ① of the compensating tank.
- Check the coolant level in the radiator.

The radiator must be filled completely.

- » If the coolant level does not match the specified value:
 - Check the coolant level and the reason for the loss.
- Mount radiator cap ②.



16.3 Checking the coolant level



Warning

Danger of scalding During motorcycle operation, the coolant gets very hot and is under pressure.

- Do not open the radiator, the radiator hoses or other cooling system components if the engine or the cooling system are at operating temperature.
- Allow the cooling system and the engine to cool down before you open the radiator, the radiator hoses or other components of the cooling system.
- In the event of scalding, rinse the area affected immediately with lukewarm water.



Warning

Danger of poisoning Coolant is toxic and a health hazard.

- Keep coolant out of the reach of children.
- Do not allow coolant to come into contact with the skin, the eyes and clothing.
- Consult a doctor immediately if coolant is swallowed.
- Rinse the affected area immediately with plenty of water in the event of contact with the skin.
- Rinse eyes thoroughly with water and consult a doctor immediately if coolant gets into the eyes.
- Change clothing if coolant spills onto your clothing.

Condition

The engine is cold.

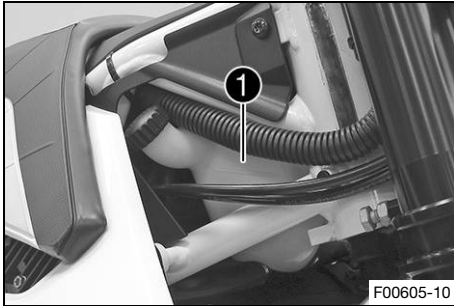

- Stand the motorcycle on its side stand on a horizontal surface.
- Check the coolant level in compensating tank ①.

The coolant level must be between the two markings.

- » If the coolant level does not match the specified value:
 - Correct the coolant level.

Coolant (📖 p. 260)

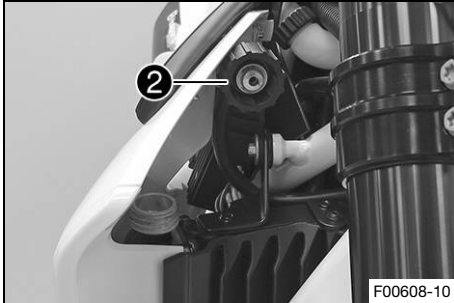

- Remove radiator cap ② and check the coolant level in the radiator.

The radiator must be filled completely.

- » If the coolant level does not match the specified value:
 - Check the coolant level and the reason for the loss.

Coolant (📖 p. 260)

- Mount the radiator cap.



16.4 Draining the coolant ↴



Warning

Danger of scalding During motorcycle operation, the coolant gets very hot and is under pressure.

- Do not open the radiator, the radiator hoses or other cooling system components if the engine or the cooling system are at operating temperature.
- Allow the cooling system and the engine to cool down before you open the radiator, the radiator hoses or other components of the cooling system.
- In the event of scalding, rinse the area affected immediately with lukewarm water.



Warning

Danger of poisoning Coolant is toxic and a health hazard.

- Keep coolant out of the reach of children.
- Do not allow coolant to come into contact with the skin, the eyes and clothing.
- Consult a doctor immediately if coolant is swallowed.
- Rinse the affected area immediately with plenty of water in the event of contact with the skin.
- Rinse eyes thoroughly with water and consult a doctor immediately if coolant gets into the eyes.
- Change clothing if coolant spills onto your clothing.

Condition

The engine is cold.

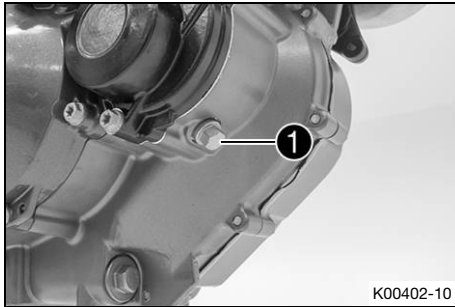

- Position the motorcycle upright.
- Position an appropriate container under the engine.
- Remove screw ❶ with the seal ring.
- Remove the radiator cap.
- Completely drain the coolant.
- Mount and tighten screw ❶ with a new seal ring.

Guideline

Screw plug, water pump drain hole	M10x1	15 Nm (11.1 lbf ft)
-----------------------------------	-------	---------------------

16.5 Filling/bleeding the cooling system ↩



Warning

Danger of poisoning Coolant is toxic and a health hazard.

- Keep coolant out of the reach of children.
- Do not allow coolant to come into contact with the skin, the eyes and clothing.
- Consult a doctor immediately if coolant is swallowed.
- Rinse the affected area immediately with plenty of water in the event of contact with the skin.
- Rinse eyes thoroughly with water and consult a doctor immediately if coolant gets into the eyes.
- Change clothing if coolant spills onto your clothing.

16 COOLING SYSTEM

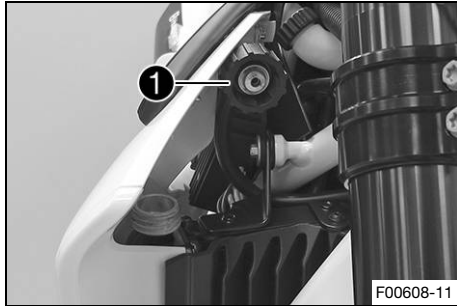

- Stand the motorcycle on its side stand on a horizontal surface.
- Remove radiator cap ❶.



- Refill with coolant.

Coolant	1.20 l (1.27 qt.)	Coolant (📖 p. 260)
---------	----------------------	--------------------

- Completely fill the radiator with coolant.
- Mount radiator cap ❶.

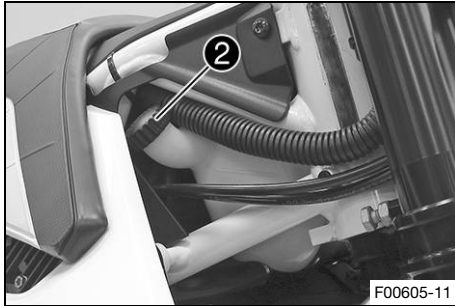

- Remove cover ② of the compensating tank.
- Add coolant up to a level between the two marks.
- Mount the cover of the compensating tank.



Danger

Danger of poisoning Exhaust gases are toxic and inhaling them may result in unconsciousness and death.

- Always make sure there is sufficient ventilation when running the engine.
 - Use effective exhaust extraction when starting or running the engine in an enclosed space.
-
- Start the engine and let it warm up.
 - Stop the engine and allow it to cool down.
 - Check the coolant level. (📖 p. 198)



16.6 Changing the coolant ↴



Warning

Danger of scalding During motorcycle operation, the coolant gets very hot and is under pressure.

- Do not open the radiator, the radiator hoses or other cooling system components if the engine or the cooling system are at operating temperature.
- Allow the cooling system and the engine to cool down before you open the radiator, the radiator hoses or other components of the cooling system.
- In the event of scalding, rinse the area affected immediately with lukewarm water.



Warning

Danger of poisoning Coolant is toxic and a health hazard.

- Keep coolant out of the reach of children.
- Do not allow coolant to come into contact with the skin, the eyes and clothing.
- Consult a doctor immediately if coolant is swallowed.
- Rinse the affected area immediately with plenty of water in the event of contact with the skin.
- Rinse eyes thoroughly with water and consult a doctor immediately if coolant gets into the eyes.
- Change clothing if coolant spills onto your clothing.

Condition

The engine is cold.

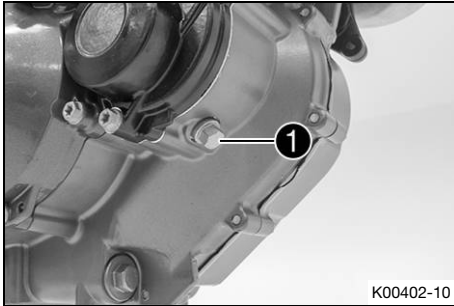

Main work

- Position the motorcycle upright.
- Position an appropriate container under the engine.
- Remove screw ① with the seal ring.

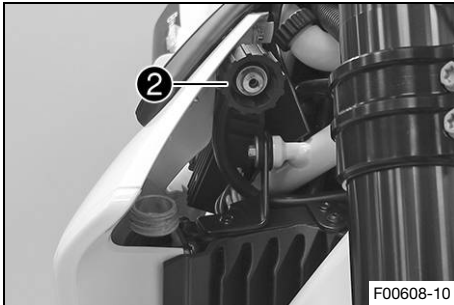

- Remove radiator cap ②.
- Completely drain the coolant.

16 COOLING SYSTEM

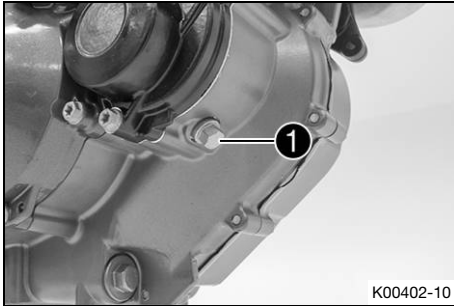

- Mount and tighten screw ① with a new seal ring.

Guideline

Screw plug, water pump drain hole	M10x1	15 Nm (11.1 lbf ft)
-----------------------------------	-------	---------------------

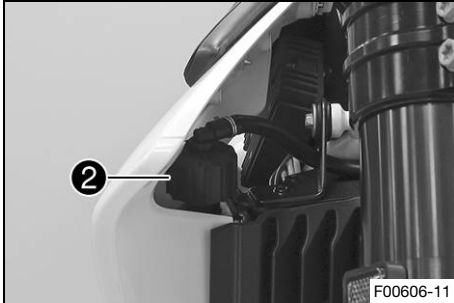

- Stand the motorcycle on a level surface using the side stand.
- Refill with coolant.

Coolant	1.20 l (1.27 qt.)	Coolant (📖 p. 260)
---------	----------------------	--------------------

- Completely fill the radiator with coolant.
- Mount radiator cap ②.

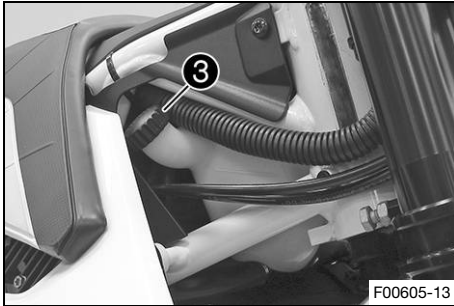

- Remove cover ③ of the compensating tank.
- Add coolant up to a level between the two marks.
- Mount cover ③ of the compensating tank.



Danger

Danger of poisoning Exhaust gases are toxic and inhaling them may result in unconsciousness and death.

- Always make sure there is sufficient ventilation when running the engine.
- Use effective exhaust extraction when starting or running the engine in an enclosed space.

- Start the engine and allow it to warm up.
- Stop the engine and allow it to cool down.

Finishing work

- Check the coolant level. (📖 p. 198)



17.1 Changing the riding mode

i Info

The desired riding mode can be activated via the **MAP** button on the combination switch. The setting most recently selected is activated again when restarting. The riding mode can also be changed during the ride.

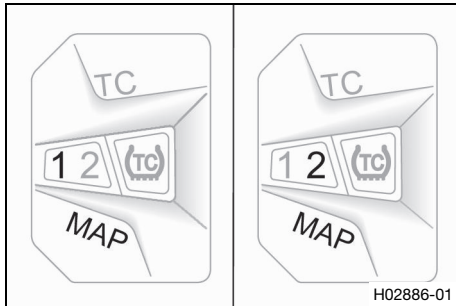

Condition

Throttle grip closed.

- Press **MAP** button until the LED displays the desired riding mode. Riding mode **1** is **STREET** and riding mode **2** is **SPORT**.
 - ✓ STREET – balanced response
 - ✓ SPORT – direct response

i Info

The riding mode only influences the throttle response. The homologated performance is available in both riding modes. In riding mode **2**, the traction control allows more slip and rise of the front wheel. In riding mode **2**, the ABS switches to ABS mode **Supermoto**.

17.2 Adjusting traction control

i Info

Traction control is activated when the ignition is switched on.

The traction control lowers the tightening torque in case of loss of traction in the rear wheel.

When traction control is switched off, the rear wheel may spin during high acceleration and on surfaces with low grip, resulting in a risk of crashing.

Traction control can also be adjusted during the ride.

Traction control cannot be deactivated until a minimum speed has previously been reached and the self test is complete.

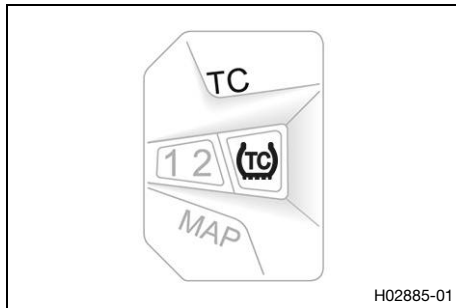

Deactivating traction control:

Condition

Throttle grip closed.

Speed before deactivation: ≥ 4 km/h (≥ 2.5 mph)

- Press and hold button **TC** for 5 seconds.
 - ✓ The **TC** LED lights up when the traction control is deactivated.

Activating the traction control:

Condition

Throttle grip closed.

- Press and hold button **TC** for 5 seconds.

- ✓ The **TC** LED does not light up when the traction control is activated.



Info

If the TC indicator lamp and both drive mode lamps light up at same time, an error has been detected in the traction control. Contact an authorized Husqvarna Motorcycles workshop.

17.3 Checking the basic position of the shift lever



Info

When driving, the shift lever must not touch the rider's boot when in the basic position. When the shift lever keeps touching the boot, the transmission will be subject to an excessive load.

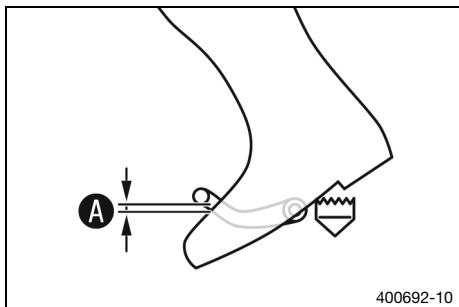

- Sit on the vehicle in the riding position and determine distance **A** between the upper edge of your boot and the shift lever.

Distance between shift lever and upper edge of boot	10 ... 20 mm (0.39 ... 0.79 in)
---	---------------------------------

- » If the distance does not meet specifications:
 - Adjust the basic position of the shift lever. 🛠️
- (📖 p. 211)

17.4 Adjusting the basic position of the shift lever ↩

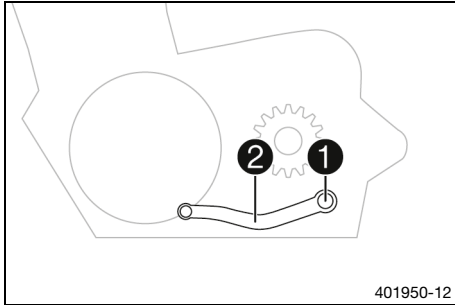

- Remove screw ① with the washers and take off shift lever ②.

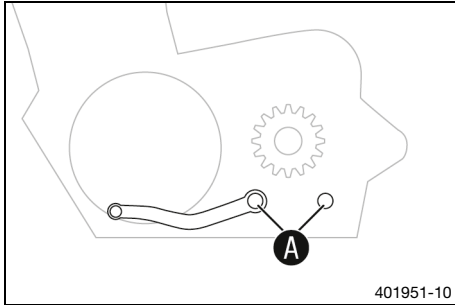

- Clean gear teeth A of the shift lever and shift shaft.
- Mount shift lever ② on the shift shaft in the required position and engage the gearing.



Info

The range of adjustment is limited.
The shift lever must not come into contact with any other vehicle components during the shift procedure.

- Mount and tighten screw ① with the washers.

Guideline

Screw, shift lever	M6	14 Nm (10.3 lbf ft) Loctite®243™
--------------------	----	--



18.1 Changing the fuel screen ↴



Danger

Fire hazard Fuel is highly flammable.

The fuel in the fuel tank expands when warm and can escape if overfilled.

- Do not fuel the vehicle in the vicinity of open flames or lit cigarettes.
- Switch off the engine for refueling.
- Make sure that no fuel is spilled; particularly not on hot parts of the vehicle.
- If any fuel is spilled, wipe it off immediately.
- Observe the specifications for refueling.



Warning

Danger of poisoning Fuel is poisonous and a health hazard.

- Avoid skin, eye and clothing contact with fuel.
- Immediately consult a doctor if you swallow fuel.
- Do not inhale fuel vapors.
- In case of skin contact, rinse the affected area with plenty of water.
- Rinse the eyes thoroughly with water, and consult a doctor in case of fuel contact with the eyes.
- Change your clothing in case of fuel spills on them.



Note

Environmental hazard Improper handling of fuel is a danger to the environment.

- Do not allow fuel to enter the groundwater, the soil, or the sewage system.

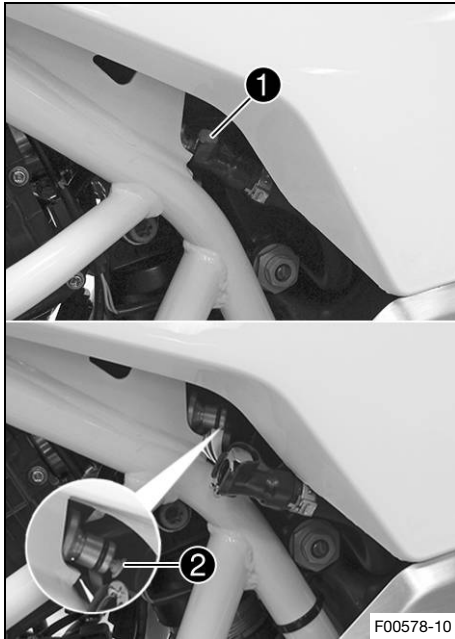

- Clean quick release coupling **1** thoroughly with compressed air.



Info

Under no circumstances should dirt enter into the fuel line. Dirt in the fuel line clogs the injection valve!

- Disconnect quick release coupling **1**.
- Pull fuel screen **2** out of the connecting piece.
- Insert the new fuel screen all the way into the connecting piece.
- Spray silicone spray onto a lint-free cleaning cloth and lightly lubricate the O-ring of the quick-release coupling.

Silicone spray (📖 p. 264)

- Join the quick release coupling.

18 SERVICE WORK ON THE ENGINE



Danger

Danger of poisoning Exhaust gases are toxic and inhaling them may result in unconsciousness and death.

- Always make sure there is sufficient ventilation when running the engine.
- Use effective exhaust extraction when starting or running the engine in an enclosed space.

- Start the engine and check the response.

18.2 Checking the engine oil level

Condition

The engine is at operating temperature.

Preparatory work

- Stand the motorcycle upright on a horizontal surface.

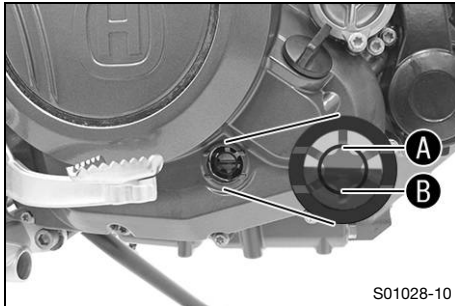

Main work

- Check the engine oil level.



Info

After switching off the engine, wait one minute before checking the level.

The engine oil must be between marking **A** and marking **B** of the oil level viewer.

- » If the engine oil level is below the **B** mark:
 - Add engine oil. (📖 p. 223)
- » If the engine oil level is above the **A** mark:
 - Correct the engine oil level.



18.3 Changing the engine oil and oil filter, cleaning the oil screens 🛠️



Warning

Danger of scalding Engine and gear oil get very hot when the motorcycle is ridden.

- Wear suitable protective clothing and safety gloves.
- In the event of scalding, rinse the area affected immediately with lukewarm water.

18 SERVICE WORK ON THE ENGINE



Note

Environmental hazard Hazardous substances cause environmental damage.

- Dispose of oils, grease, filters, fuel, cleaning agents, brake fluid, etc., correctly and in compliance with the applicable regulations.
-



Info

Drain the engine oil while the engine is at operating temperature.

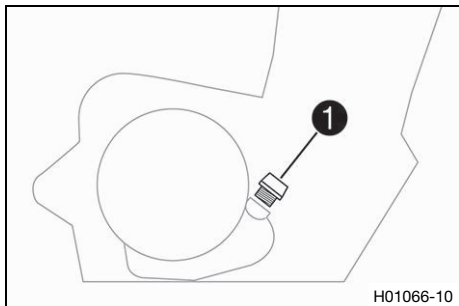

Main work

- Position an appropriate container under the engine.
- Remove filler plug **1** with the O-ring.

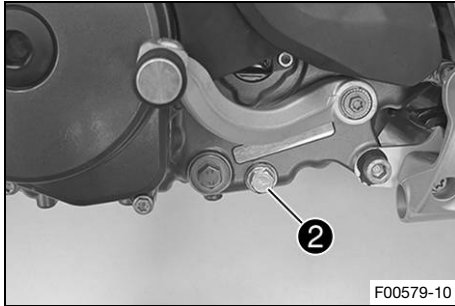

- Remove oil drain plug ② with the magnet and seal ring.
- Allow the engine oil to drain completely.

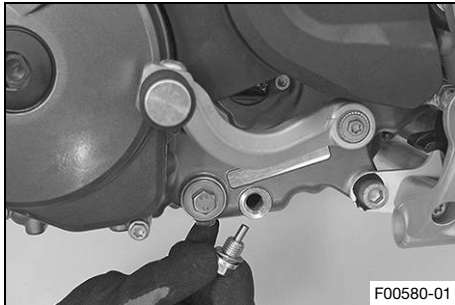

- Thoroughly clean the oil drain plug with magnet.
- Mount and tighten the oil drain plug with the magnet and new seal ring.

Guideline

Oil drain plug with magnet	M12x1.5	20 Nm (14.8 lbf ft)
----------------------------	---------	---------------------

18 SERVICE WORK ON THE ENGINE

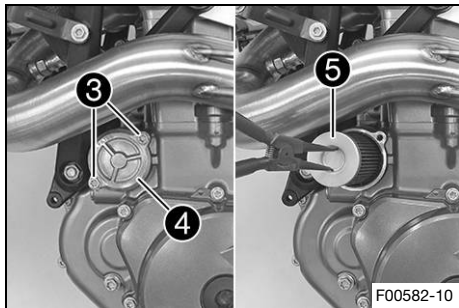

- Remove screws ③. Remove oil filter cover ④ with the O-ring.
- Pull oil filter ⑤ out of the oil filter housing.

Lock ring plier (51012011000)

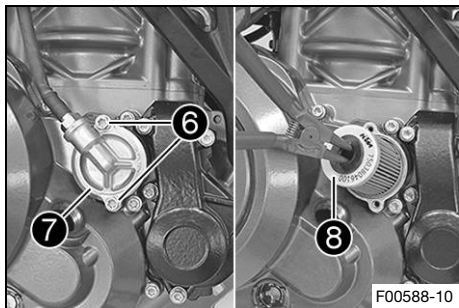

- Remove screws ⑥. Remove oil filter cover ⑦ with the O-ring.
- Pull oil filter ⑧ out of the oil filter housing.

Lock ring plier (51012011000)

- Allow the engine oil to drain completely.
- Thoroughly clean the parts and the sealing surfaces.

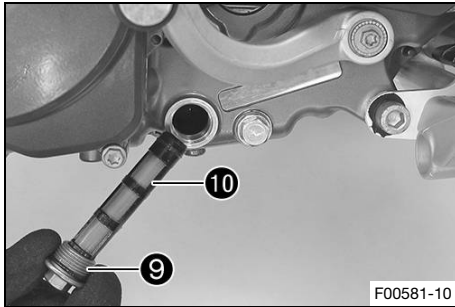

- Remove screw plug 9 with oil screen 10 and the O-rings.

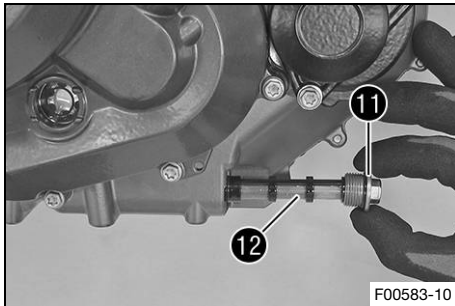

- Remove screw plug 11 with oil screen 12 and the O-rings.
- Allow the engine oil to drain completely.
- Thoroughly clean the parts and the sealing surfaces.

18 SERVICE WORK ON THE ENGINE

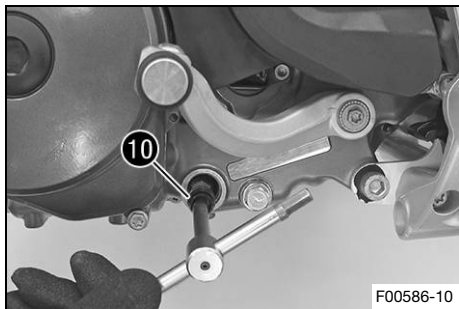

- Position oil screen 10 with the O-rings on a pin wrench.
- Position the pin wrench through the drill hole of the screw plug in the opposite section of the engine case.
- Push the oil screen all the way into the engine case.

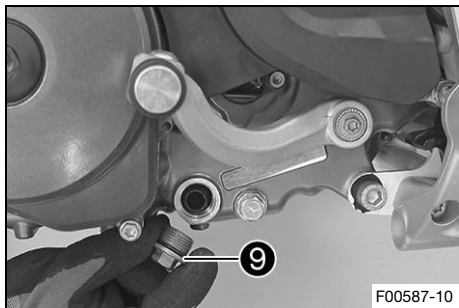

- Mount and tighten screw plug 9 with the O-ring.

Guideline

Plug, oil screen	M20x1.5	15 Nm (11.1 lbf ft)
------------------	---------	---------------------

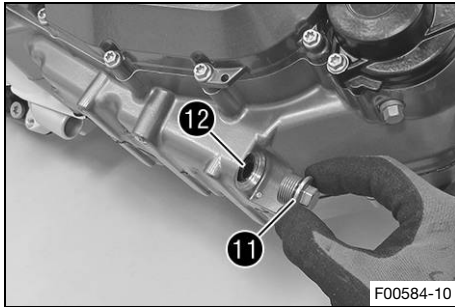

- Position oil screen **12** with the O-rings.
- Mount and tighten screw plug **11** with the O-ring.

Guideline

Plug, oil screen	M20x1.5	15 Nm (11.1 lbf ft)
------------------	---------	---------------------

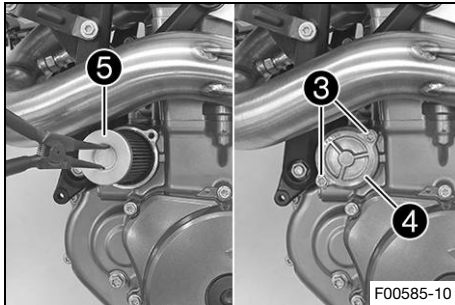

- Insert new oil filter **5**.
- Lubricate the O-ring of the oil filter cover. Position oil filter cover **4**.
- Mount and tighten screws **3**.

Guideline

Screw, oil filter cover	M5	6 Nm (4.4 lbf ft)
-------------------------	----	-------------------

18 SERVICE WORK ON THE ENGINE

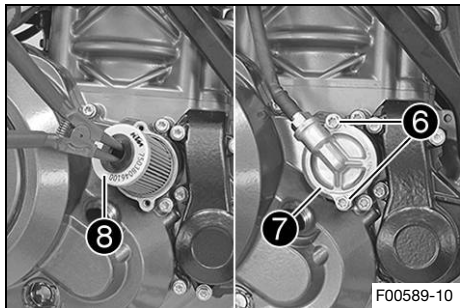

- Insert new oil filter **8**.
- Lubricate the O-ring of the oil filter cover. Position oil filter cover **7**.
- Mount and tighten screws **6**.

Guideline

Screw, oil filter cover	M5	6 Nm (4.4 lbf ft)
-------------------------	----	-------------------

- Fill up with engine oil at the clutch cover.

Engine oil	1.70 l (1.8 qt.)	Engine oil (SAE 10W/50) (📖 p. 261)
------------	------------------	--



Info

Too little engine oil or poor-quality engine oil will result in premature wear of the engine.

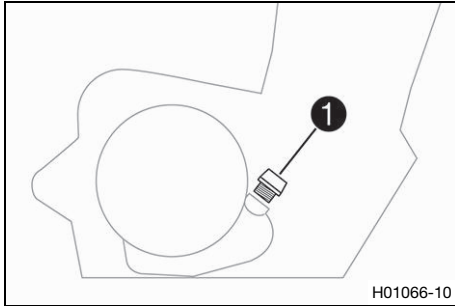

- Mount and tighten filler plug ① with the O-ring.



Danger

Danger of poisoning Exhaust gases are toxic and inhaling them may result in unconsciousness and death.

- Always make sure there is sufficient ventilation when running the engine.
 - Use effective exhaust extraction when starting or running the engine in an enclosed space.
-
- Start the engine and check for leaks.
- Finishing work**
- Check the engine oil level. (📖 p. 214)



18.4 Adding engine oil



Info

Too little engine oil or poor-quality engine oil will result in premature wear of the engine.

18 SERVICE WORK ON THE ENGINE

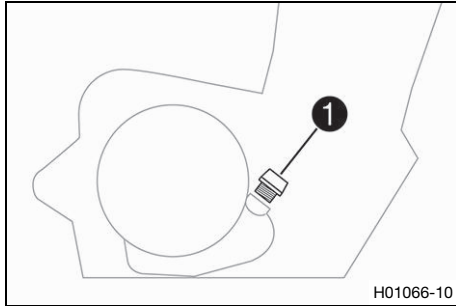

Main work

- Remove filler plug ❶ with the O-ring, and fill up with engine oil.
- Fill engine oil to the middle of the level viewer.

Engine oil (SAE 10W/50) (📖 p. 261)



Info

For optimal performance of the engine oil, do not mix different types of engine oil. Husqvarna Motorcycles recommends changing the engine oil.

- Mount and tighten filler plug ❶ together with the O-ring.



Danger

Danger of poisoning Exhaust gases are toxic and inhaling them may result in unconsciousness and death.

- Always make sure there is sufficient ventilation when running the engine.
 - Use effective exhaust extraction when starting or running the engine in an enclosed space.
- Start the engine and check for leaks.

Finishing work

- Check the engine oil level. (📖 p. 214)



19.1 Cleaning the motorcycle

Note

Material damage Components become damaged or destroyed if a pressure cleaner is used incorrectly. The high pressure forces water into the electrical components, connectors, throttle cables, and bearings, etc. Pressure which is too high causes malfunctions and destroys components.

- Do not direct the water jet directly on to electrical components, connectors, throttle cables or bearings.
- Maintain a minimum distance between the nozzle of the pressure cleaner and the component.

Minimum clearance 60 cm (23.6 in)



Note

Environmental hazard Hazardous substances cause environmental damage.

- Dispose of oils, grease, filters, fuel, cleaning agents, brake fluid, etc., correctly and in compliance with the applicable regulations.
-



Info

To maintain the value and appearance of the motorcycle over a long period, clean it regularly. Avoid direct sunshine when cleaning the motorcycle.

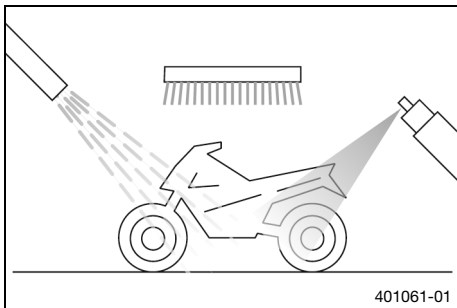

- Close off exhaust system to keep water from entering.
- Remove loose dirt first with a soft jet of water.
- Spray the heavily soiled parts with a normal commercial motorcycle cleaner and clean using a brush.

Motorcycle cleaner (📖 p. 263)



Info

Use warm water containing normal motorcycle cleaner and a soft sponge.

Never apply motorcycle cleaner to a dry vehicle; always rinse the vehicle with water first.

If the vehicle was operated in road salt, clean it with cold water. Warm water would enhance the corrosive effects of salt.

- After rinsing the motorcycle with a gentle spray of water, allow it to dry thoroughly.
- Remove the closure of the exhaust system.



Warning

Danger of accidents Moisture and dirt impair the brake system.

- Brake carefully several times to dry out and remove dirt from the brake linings and the brake discs.

- After cleaning, ride the vehicle a short distance until the engine warms up.



Info

The heat produced causes water at inaccessible locations in the engine and on the brake system to evaporate.

- Push back the protection caps of the handlebar controls to allow any water that has penetrated to evaporate.
- After the motorcycle has cooled down, lubricate all moving parts and pivot points.
- Clean the chain. (📖 p. 118)
- Treat bare metal (except for brake discs and the exhaust system) with a corrosion inhibitor.

Preserving materials for paints, metal and rubber
(📖 p. 263)

- Treat all painted parts with a mild paint care product.

Perfect finish and high gloss polish for paints (📖 p. 263)

**Info**

Do not polish parts that were matte when delivered as this would strongly impair the material quality.

- Treat all plastic parts and powder-coated parts with a mild cleaning and care product.

Special cleaner for glossy and matte paint finishes, metal and plastic surfaces (📖 p. 264)

- Lubricate the ignition/steering lock.

Universal oil spray (📖 p. 264)



19.2 Checks and maintenance steps for winter operation

**Info**

If you use the motorcycle in winter, salt can be expected on the roads. You should therefore take precautions against aggressive road salt.

After riding on salted roads, thoroughly clean the vehicle with cold water and dry it well. Warm water enhances the corrosive effects of salt.

19 CLEANING, CARE

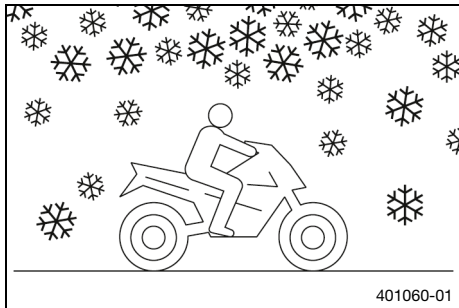

- Clean the motorcycle. (📖 p. 226)
- Clean the brake system.

i Info

After **EVERY** trip on salted roads, thoroughly clean the brake calipers and brake linings, after they have cooled down and without removing them, with cold water and dry them carefully.

After riding on salted roads, thoroughly clean the motorcycle with cold water and dry it well.

-
- Treat the engine, the swingarm, and all other bare or zinc-plated parts (except the brake discs) with a wax-based corrosion inhibitor.

i Info

Corrosion inhibitor must not come in contact with the brake discs as this would greatly reduce the braking force.

-
- Clean the chain. (📖 p. 118)
- 

20.1 Storage



Warning

Danger of poisoning Fuel is poisonous and a health hazard.

- Avoid skin, eye and clothing contact with fuel.
- Immediately consult a doctor if you swallow fuel.
- Do not inhale fuel vapors.
- In case of skin contact, rinse the affected area with plenty of water.
- Rinse the eyes thoroughly with water, and consult a doctor in case of fuel contact with the eyes.
- Change your clothing in case of fuel spills on them.
- Keep fuels correctly in a suitable canister, and out of the reach of children.



Info

If you plan to garage the motorcycle for a longer period, perform the following steps or have them performed.

Before storing the motorcycle, check all parts for function and wear. If service, repairs, or replacements are necessary, you should do this during the storage period (less workshop overload). In this way, you can avoid long workshop waiting times at the start of the new season.

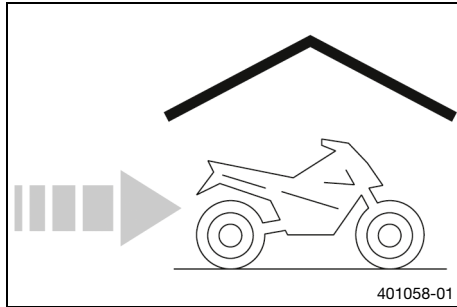

- When refueling for the last time before taking the motorcycle out of service, add fuel additive.



Info

The fuel additive stabilizes the fuel for longer storage and makes starting easier next time.

- Refuel. (📖 p. 81)
- Clean the motorcycle. (📖 p. 226)
- Change the engine oil and the oil filter, clean the oil screens. 🛠️ (📖 p. 215)
- Check the antifreeze and coolant level. (📖 p. 196)
- Check tire pressure. (📖 p. 169)
- Remove the 12-V battery. 🛠️ (📖 p. 173)
- Charge the 12-V battery. 🛠️ (📖 p. 177)

Guideline

Storage temperature of the 12-V battery without direct sunlight	0 ... 35 °C (32 ... 95 °F)
---	----------------------------

- Store the vehicle in a dry location that is not subject to large fluctuations in temperature.

**Info**

Husqvarna Motorcycles recommends jacking up the motorcycle.

- Raise the motorcycle with the rear lifting gear. (📖 p. 101)
 - Lift the motorcycle with the front lifting gear. (📖 p. 103)
 - Cover the motorcycle with a tarp or cover that is permeable to air.
-

**Info**

Do not use non-porous materials since they prevent humidity from escaping, thus causing corrosion. Avoid running the engine for a short time only. Since the engine cannot warm up properly, the water vapor produced during combustion condenses and causes valves and the exhaust system to rust.



20.2 Preparing for use after storage

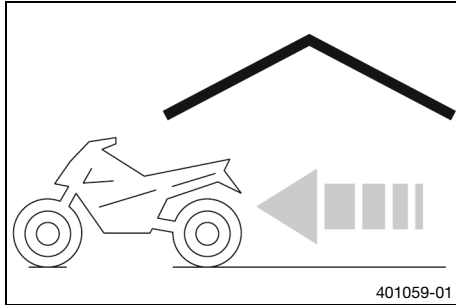

- Take the motorcycle off the front lifting gear. (📖 p. 104)
- Remove the rear of the motorcycle from the wheel stand. (📖 p. 102)
- Charge the 12-V battery. 🔌 (📖 p. 177)
- Install the 12-V battery. 🔌 (📖 p. 175)
- Set the clock. (📖 p. 47)
- Perform checks and maintenance measures when preparing for use. (📖 p. 65)
- Take a test ride.

Faults	Possible cause	Action
The engine does not turn when the start button is pressed	Operating error	– Carry out start procedure. (📖 p. 66)
	12 V battery discharged	– Charge the 12-V battery. 🛠️ (📖 p. 177) – Check the open-circuit current. 🛠️
	Fuse 1 , 2 or 3 blown	– Change the fuses of individual electrical power consumers. (📖 p. 184)
	Main fuse blown	– Change the main fuse. (📖 p. 179)
	No ground connection present	– Check the ground connection.
Engine turns only if the clutch lever is drawn	The vehicle is in gear	– Shift the transmission to neutral position.
	The vehicle is in gear and the side stand is folded out	– Shift the transmission to neutral position.
The engine turns but does not start	Operating error	– Carry out start procedure. (📖 p. 66)
	Fuse 3 blown	– Change the fuses of individual electrical power consumers. (📖 p. 184)
	Quick release coupling not joined	– Join quick release coupling.
	Malfunction in the electronic fuel injection	– Read out the fault memory using the Husqvarna Motorcycles diagnostics tool. 🛠️
	Throttle opened while starting	– When starting, DO NOT open the throttle. – Carry out start procedure. (📖 p. 66)

21 TROUBLESHOOTING

Faults	Possible cause	Action
Engine has too little power	Air filter is very dirty	<ul style="list-style-type: none"> – Remove the air filter. 🛠️ (📖 p. 115) – Install the air filter. 🛠️ (📖 p. 116)
	Fuel screen is very dirty	<ul style="list-style-type: none"> – Change the fuel screen. 🛠️ (📖 p. 212)
	Fuel filter is very dirty	<ul style="list-style-type: none"> – Check the fuel pressure. 🛠️
	Malfunction in the electronic fuel injection	<ul style="list-style-type: none"> – Read out the fault memory using the Husqvarna Motorcycles diagnostics tool. 🛠️
Engine overheats	Too little coolant in cooling system	<ul style="list-style-type: none"> – Check the cooling system for leakage. – Check the coolant level. (📖 p. 198)
	Radiator fins very dirty	<ul style="list-style-type: none"> – Clean radiator fins.
	Foam formation in cooling system	<ul style="list-style-type: none"> – Drain the coolant. 🛠️ (📖 p. 200) – Fill/bleed the cooling system. 🛠️ (📖 p. 201)
	Buckled or damaged radiator hose	<ul style="list-style-type: none"> – Change the radiator hose. 🛠️
	Thermostat is faulty	<ul style="list-style-type: none"> – Check the thermostat. 🛠️
	Fuse 4 blown	<ul style="list-style-type: none"> – Change the fuses of individual electrical power consumers. (📖 p. 184)
	Defect in radiator fan system	<ul style="list-style-type: none"> – Check the radiator fan system. 🛠️
	Air in cooling system	<ul style="list-style-type: none"> – Fill/bleed the cooling system. 🛠️ (📖 p. 201)

Faults	Possible cause	Action
Malfunction indicator lamp lights up or flashes	Malfunction in the electronic fuel injection	– Read out the fault memory using the Husqvarna Motorcycles diagnostics tool. 🛠️
N The idling speed indicator lamp does not light up when the transmission is in neutral	Gear position sensor not programmed	– Read out the fault memory using the Husqvarna Motorcycles diagnostics tool. 🛠️
Engine dies during the journey	Lack of fuel	– Refuel. (📖 p. 81)
	Fuse 1, 2 or 3 blown	– Change the fuses of individual electrical power consumers. (📖 p. 184)
ABS warning lamp lights up	ABS fuse blown	– Change the ABS fuses. (📖 p. 182)
	Large difference in wheel speeds of the front and rear wheels	– Stop the vehicle, switch off the ignition, and start it again.
	Malfunction in ABS	– Read out the ABS fault memory using the Husqvarna Motorcycles diagnostics tool. 🛠️
High oil consumption	Engine vent hose bent	– Route the vent hose without bends or change it if necessary.
	Engine oil level too high	– Check the engine oil level. (📖 p. 214)
	Engine oil too thin (low viscosity)	– Change the engine oil and the oil filter, clean the oil screens. 🛠️ (📖 p. 215)

21 TROUBLESHOOTING

Faults	Possible cause	Action
Headlight and parking light are not functioning	Fuse 6 blown	– Change the fuses of individual electrical power consumers. (📖 p. 184)
Turn signal, brake light and horn not functioning	Fuse 5 blown	– Change the fuses of individual electrical power consumers. (📖 p. 184)
Time is not (correctly) displayed	Fuse 1 blown	– Change the fuses of individual electrical power consumers. (📖 p. 184) – Set the clock. (📖 p. 47)
12 V battery discharged	Ignition not switched off when vehicle was parked	– Charge the 12-V battery. 🛡️ (📖 p. 177)
	The 12-V battery is not being charged by the alternator	– Check the charging voltage. 🛡️ – Check the open-circuit current. 🛡️
Combination instrument shows nothing in the display	Fuse 1 or 2 blown	– Change the fuses of individual electrical power consumers. (📖 p. 184) – Set the clock. (📖 p. 47)

22.1 Engine

Design	1-cylinder 4-stroke engine, water-cooled
Displacement	692.7 cm ³ (42.271 cu in)
Stroke	80 mm (3.15 in)
Bore	105 mm (4.13 in)
Compression ratio	12.7:1
Idle speed	
Coolant temperature: $\geq 70\text{ }^{\circ}\text{C}$ ($\geq 158\text{ }^{\circ}\text{F}$)	1,600 ... 1,700 rpm
Control	OHC, intake with cam levers, exhaust controlled by rocker arm, chain drive
Valve diameter, intake	42 mm (1.65 in)
Valve diameter, exhaust	34 mm (1.34 in)
Valve play, cold	
Intake at: $20\text{ }^{\circ}\text{C}$ ($68\text{ }^{\circ}\text{F}$)	0.10 ... 0.15 mm (0.0039 ... 0.0059 in)
Exhaust at: $20\text{ }^{\circ}\text{C}$ ($68\text{ }^{\circ}\text{F}$)	0.22 ... 0.27 mm (0.0087 ... 0.0106 in)
Crankshaft bearing	2 roller bearings
Conrod bearing	Slide bearing
Piston pin bearing	Piston pin with DLC coating
Pistons	Forged light alloy
Piston rings	1 compression ring, 1 lower compression ring, 1 oil ring with spring expander

22 TECHNICAL DATA

Engine lubrication	Semi-dry sump lubrication system with two trochoid pumps
Primary transmission	36:79
Clutch	APTC™ antihopping clutch in oil bath/hydraulically operated
Transmission	6-gear transmission, claw shifted
Transmission ratio	
First gear	14:35
Second gear	16:28
Third gear	20:27
Fourth gear	21:23
Fifth gear	23:22
Sixth gear	23:20
Mixture preparation	Electronic fuel injection
Ignition	Contactless controlled fully electronic ignition with digital ignition adjustment
Alternator	12 V, 300 W
Spark plug	
Inside spark plug	NGK LKAR9BI-10
Outside spark plug	NGK LMAR7DI-10
Spark plug electrode gap	1.0 mm (0.039 in)

Cooling	Water cooling, permanent circulation of coolant by water pump
Starting aid	Starter motor, automatic decompression

22.2 Engine tightening torques

Screw, membrane fixation	M3	2 Nm (1.5 lbf ft) Loctite®243™
Hose clamp, intake flange	M4	2.5 Nm (1.84 lbf ft)
Oil nozzle for clutch lubrication	M4	2 Nm (1.5 lbf ft)
Oil nozzle for conrod bearing lubrication	M4	0.8 Nm (0.59 lbf ft)
Locking screw for bearing	M5	6 Nm (4.4 lbf ft) Loctite®243™
Oil nozzle in cylinder head	M5	2 Nm (1.5 lbf ft) Loctite®243™
Remaining screws, engine	M5	6 Nm (4.4 lbf ft)
Screw, axial lock of camshaft	M5	6 Nm (4.4 lbf ft) Loctite®243™
Screw, clutch spring	M5	6 Nm (4.4 lbf ft)
Screw, cover plate for oil return line	M5	6 Nm (4.4 lbf ft)

22 TECHNICAL DATA

Screw, gear sensor	M5	5 Nm (3.7 lbf ft)	Loctite®243™
Screw, oil filter cover	M5	6 Nm (4.4 lbf ft)	
Screw, oil pump cover	M5	6 Nm (4.4 lbf ft)	Loctite®243™
Screw, shift shaft sensor	M5	5 Nm (3.7 lbf ft)	Loctite®243™
Remaining screws, engine	M6	10 Nm (7.4 lbf ft)	
Screw in alternator cover	M6	10 Nm (7.4 lbf ft)	
Screw, alternator cover	M6x30	10 Nm (7.4 lbf ft)	
Screw, alternator cover (timing chain shaft through-hole)	M6	10 Nm (7.4 lbf ft)	Loctite®243™
Screw, camshaft bearing support	M6x80	10 Nm (7.4 lbf ft)	
Screw, camshaft bearing support	M6x90	10 Nm (7.4 lbf ft)	
Screw, clutch cover	M6x25	10 Nm (7.4 lbf ft)	
Screw, clutch cover	M6x30	10 Nm (7.4 lbf ft)	
Screw, clutch cover	M6x35	10 Nm (7.4 lbf ft)	
Screw, clutch slave cylinder	M6x20	10 Nm (7.4 lbf ft)	
Screw, clutch slave cylinder	M6x20	10 Nm (7.4 lbf ft)	
Screw, clutch slave cylinder	M6x40	10 Nm (7.4 lbf ft)	
Screw, crankshaft speed sensor	M6	10 Nm (7.4 lbf ft)	Loctite®243™

Screw, cylinder	M6	10 Nm (7.4 lbf ft)	Loctite®243™
Screw, cylinder head	M6	10 Nm (7.4 lbf ft)	Loctite®243™
Screw, engine case	M6x25	10 Nm (7.4 lbf ft)	
Screw, engine case	M6x30	10 Nm (7.4 lbf ft)	
Screw, engine case	M6x70	10 Nm (7.4 lbf ft)	
Screw, engine case	M6x80	10 Nm (7.4 lbf ft)	
Screw, guide rail	M6x30	10 Nm (7.4 lbf ft)	Loctite®2701™
Screw, guide rail	M6x20	10 Nm (7.4 lbf ft)	Loctite®243™
Screw, ignition coil	M6	10 Nm (7.4 lbf ft)	
Screw, locking lever	M6	10 Nm (7.4 lbf ft)	Loctite®243™
Screw, resonator	M6	10 Nm (7.4 lbf ft)	
Screw, secondary air system cover	M6x12	10 Nm (7.4 lbf ft)	Loctite®243™
Screw, shift drum locating	M6	15 Nm (11.1 lbf ft)	Loctite®243™
Screw, shift lever	M6	14 Nm (10.3 lbf ft)	Loctite®243™
Screw, starter motor	M6	10 Nm (7.4 lbf ft)	

22 TECHNICAL DATA

Screw, stator	M6	10 Nm (7.4 lbf ft)	Loctite®243™
Screw, tensioning rail	M6x30	10 Nm (7.4 lbf ft)	Loctite®2701™
Screw, thermostat case	M6	10 Nm (7.4 lbf ft)	
Screw, timing chain shaft	M6	10 Nm (7.4 lbf ft)	Loctite®243™
Screw, valve cover	M6	10 Nm (7.4 lbf ft)	
Screw, water pump cover	M6	10 Nm (7.4 lbf ft)	
Screw, water pump wheel	M6	10 Nm (7.4 lbf ft)	Loctite®243™
Intake channel vacuum connection	M6x0.75	2.5 Nm (1.84 lbf ft)	Loctite®2701™
Oil nozzle for piston cooling	M6x0.75	4 Nm (3 lbf ft)	
Nut, exhaust flange	M8	20 Nm (14.8 lbf ft)	Copper paste
Screw plug, locking screw	M8	15 Nm (11.1 lbf ft)	
Screw, rocker arm shaft	M8x40	15 Nm (11.1 lbf ft)	
Screw, rocker arm shaft	M8x55	15 Nm (11.1 lbf ft)	
Setscrew, camshaft bearing bridge	M8	6 Nm (4.4 lbf ft)	Loctite®243™
Stud, exhaust flange	M8	15 Nm (11.1 lbf ft)	Loctite®243™

Screw, cylinder head	M10	<p>Tightening sequence: Tighten diagonally, beginning with the rear screw on the timing chain shaft.</p> <p>1st stage 15 Nm (11.1 lbf ft)</p> <p>2nd stage 30 Nm (22.1 lbf ft)</p> <p>3rd stage 45 Nm (33.2 lbf ft)</p> <p>4th stage 60 Nm (44.3 lbf ft)</p> <p style="text-align: right;">Thread greased</p>
Oil pressure sensor	M10x1	10 Nm (7.4 lbf ft)
Screw plug, oil channel	M10x1	15 Nm (11.1 lbf ft) Loctite®243™
Screw plug, water pump drain hole	M10x1	15 Nm (11.1 lbf ft)
Screw, unlocking of timing chain tensioner	M10x1	10 Nm (7.4 lbf ft)
Spark plug outside	M10x1	11 Nm (8.1 lbf ft)
Spark plug inside	M12x1.25	18 Nm (13.3 lbf ft)
Coolant temperature sensor on the cylinder head	M12x1.5	12 Nm (8.9 lbf ft)
Oil drain plug with magnet	M12x1.5	20 Nm (14.8 lbf ft)

22 TECHNICAL DATA

Screw plug, oil pressure control valve	M12x1.5	20 Nm (14.8 lbf ft)
Screw plug, oil channel	M14x1.5	15 Nm (11.1 lbf ft) Loctite®243™
Engine case stud	M16x1.5	25 Nm (18.4 lbf ft) Loctite®243™
Rotor nut	M18x1.5	100 Nm (73.8 lbf ft)
Nut, engine sprocket	M20x1.5	100 Nm (73.8 lbf ft) Loctite®243™
Nut, inner clutch hub	M20x1.5	120 Nm (88.5 lbf ft) Loctite®243™
Nut, primary gear wheel	M20LHx1.5	90 Nm (66.4 lbf ft) Loctite®243™
Plug, oil screen	M20x1.5	15 Nm (11.1 lbf ft)
Plug, timing chain tensioner	M24x1.5	25 Nm (18.4 lbf ft)
Screw plug, alternator cover	M24x1.5	8 Nm (5.9 lbf ft)

22.3 Capacities

22.3.1 Engine oil

Engine oil	1.70 l (1.8 qt.)	Engine oil (SAE 10W/50) (📖 p. 261)
------------	------------------	------------------------------------

22.3.2 Coolant

Coolant	1.20 l (1.27 qt.)	Coolant (📖 p. 260)
---------	-------------------	--------------------

22.3.3 Fuel

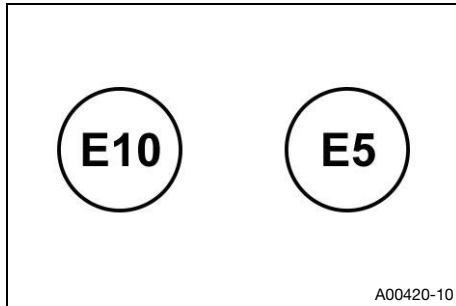

Please observe the labels on EU fuel pumps.

Fuel tank capacity, approx.	12.7 l (3.36 US gal)	Super unleaded (ROZ 95) (📖 p. 262)
Fuel reserve, approx.	1.8 l (1.9 qt.)	

22.4 Chassis

Frame	Lattice frame made of chrome molybdenum steel tubing, powder-coated
-------	---

22 TECHNICAL DATA

Fork	WP Suspension APEX 5348
Shock absorber	WP Suspension XPLORE 5746
Suspension travel	
front	215 mm (8.46 in)
rear	240 mm (9.45 in)
Brake system	
front	Disc brake with radially mounted four-piston brake caliper, floating brake disc
rear	Disc brake with single-piston brake caliper, floating
Brake discs - diameter	
front	320 mm (12.6 in)
rear	240 mm (9.45 in)
Brake discs - wear limit	
front	4.0 mm (0.157 in)
rear	4.5 mm (0.177 in)
Tire pressure when solo	
front	2.0 bar (29 psi)
rear	2.0 bar (29 psi)
Tire pressure with passenger / full payload	
front	2.0 bar (29 psi)
rear	2.2 bar (32 psi)

Secondary drive ratio	16:42
Chain	5/8 x 1/4" X-ring
Steering head angle	63°
Wheelbase	1,485 ± 15 mm (58.46 ± 0.59 in)
Seat height unloaded	882 mm (34.72 in)
Ground clearance unloaded	237 mm (9.33 in)
Weight without fuel, approx.	149.4 kg (329.4 lb.)
Maximum permissible front axle load	150 kg (331 lb.)
Maximum permissible rear axle load	200 kg (441 lb.)
Maximum permissible overall weight	350 kg (772 lb.)

22.5 Electrical system

12-V battery	YTZ10S	Battery voltage: 12 V Nominal capacity: 8.6 Ah Maintenance-free
Fuse	58011109130	30 A
Fuse	75011088025	25 A
Fuse	75011088015	15 A
Fuse	75011088010	10 A
Headlight	H4/socket P43t	12 V 60/55 W

22 TECHNICAL DATA

Position light	W5W / socket W2.1x9.5d	12 V 5 W
Combination instrument lighting and indicator lamps	LED	
Turn signal	LED	
Brake/tail light	LED	
License plate lamp	LED	

22.6 Tires

Front tire	Rear tire
120/70 R 17 M/C 58H TL Continental ContiAttack SM EVO	160/60 R 17 M/C 69H TL Continental ContiAttack SM EVO
The tires specified represent one of the possible series production tires. Additional information is available in the Service section under: www.husqvarna-motorcycles.com	

22.7 Fork

Fork article number	14.18.8S.12
Fork	WP Suspension APEX 5348
Compression damping	
Comfort	20 clicks

Standard	15 clicks	
Sport	10 clicks	
Full payload	10 clicks	
Rebound damping		
Comfort	20 clicks	
Standard	15 clicks	
Sport	10 clicks	
Full payload	10 clicks	
Spring length with preload spacer(s)	463 mm (18.23 in)	
Spring rate		
Medium (standard)	5.3 N/mm (30.3 lb/in)	
Fork length	879 mm (34.61 in)	
Fork oil per fork leg	590 ml (19.95 fl. oz.)	Fork oil (SAE 4) (48601166S1)  p. 262

22.8 Shock absorber

Shock absorber article number	15.18.7S.12	
Shock absorber	WP Suspension XPLOR 5746	
Low-speed compression damping		
Comfort	20 clicks	

22 TECHNICAL DATA

Standard	15 clicks
Sport	10 clicks
Full payload	10 clicks
High-speed compression damping	
Comfort	2 turns
Standard	1.5 turns
Sport	1 turn
Full payload	1 turn
Rebound damping	
Comfort	20 clicks
Standard	15 clicks
Sport	10 clicks
Full payload	10 clicks
Spring rate	
Standard	75 N/mm (428 lb/in)
Fitted length	391 mm (15.39 in)
Shock absorber fluid  p. 262)	SAE 2.5

22.9 Chassis tightening torques

Rear fairing screw, tail light	EJOT PT® K50x12	2.5 Nm (1.84 lbf ft)
Remaining screws, chassis	EJOT PT® K45x12	1 Nm (0.7 lbf ft)
Remaining screws, chassis	EJOT PT® K50x12	1 Nm (0.7 lbf ft)
Remaining screws, chassis	EJOT PT® K50x14	1 Nm (0.7 lbf ft)
Remaining screws, chassis	EJOT PT® K50x16	2 Nm (1.5 lbf ft)
Remaining screws, chassis	EJOT PT® K50x18	2 Nm (1.5 lbf ft)
Screw, chain guard	EJOT PT® K50x18	1.5 Nm (1.11 lbf ft)
Screw, combination instrument	EJOT PT® 45x12-Z	1 Nm (0.7 lbf ft)
Screw, combination switch, left	EJOT PT® K50x18	2 Nm (1.5 lbf ft)
Screw, radiator shield	EJOT PT® K50x14	2 Nm (1.5 lbf ft)
Screw, side stand sensor	EJOT PT® K50x12	1 Nm (0.7 lbf ft)
Fitting, side stand sensor	M4	2 Nm (1.5 lbf ft)
Remaining nuts, chassis	M4	3 Nm (2.2 lbf ft)
Remaining screws, chassis	M4	3 Nm (2.2 lbf ft)
Spoke nipple, front wheel	M4.5	4 Nm (3 lbf ft)
Spoke nipple, rear wheel	M4.5	4 Nm (3 lbf ft)
Remaining nuts, chassis	M5	5 Nm (3.7 lbf ft)
Remaining screws, chassis	M5	5 Nm (3.7 lbf ft)
Screw brake line holder on frame	M5	4 Nm (3 lbf ft)

22 TECHNICAL DATA

Screw, brake line holder on link fork	M5	8 Nm (5.9 lbf ft)
Screw, cable on starter motor	M5	3 Nm (2.2 lbf ft)
Screw, combination switch, left	M5	3.5 Nm (2.58 lbf ft)
Screw, electrical holder	M5	3 Nm (2.2 lbf ft)
Screw, exhaust heat shield	M5	8 Nm (5.9 lbf ft) Loctite®243™
Screw, foot brake lever stub	M5	6 Nm (4.4 lbf ft) Loctite®243™
Screw, front spoiler	M5x17	3.5 Nm (2.58 lbf ft)
Screw, fuel level sensor	M5	3 Nm (2.2 lbf ft)
Screw, fuel pump	M5	4 Nm (3 lbf ft)
Screw, fuel tank closure flange	M5	2.5 Nm (1.84 lbf ft)
Screw, license plate holder, bottom	M5	8 Nm (5.9 lbf ft)
Screw, radiator fan cover	M5	3.2 Nm (2.36 lbf ft)
Screw, rear fender	M5	3 Nm (2.2 lbf ft)
Screw, throttle grip	M5	3.5 Nm (2.58 lbf ft)
Screw, trim	M5x12	3.5 Nm (2.58 lbf ft)
Nut, valve	M6	4.5 Nm (3.32 lbf ft)
Remaining nuts, chassis	M6	10 Nm (7.4 lbf ft)
Remaining screws on fuel tank	M6	5 Nm (3.7 lbf ft)

Remaining screws, chassis	M6	10 Nm (7.4 lbf ft)	
SAS valve screw on frame	M6	4 Nm (3 lbf ft)	
Screw connection, foot brake cylinder	M6	10 Nm (7.4 lbf ft)	
Screw, ABS control unit	M6	5 Nm (3.7 lbf ft)	
Screw, ABS module retaining bracket on frame	M6	10 Nm (7.4 lbf ft)	
Screw, air filter box, on frame	M6	6 Nm (4.4 lbf ft)	
Screw, angle sensor	M6	8 Nm (5.9 lbf ft)	
Screw, ball joint of push rod on foot brake cylinder	M6	10 Nm (7.4 lbf ft)	Loctite®243™
Screw, battery compartment	M6	2 Nm (1.5 lbf ft)	
Screw, battery terminal	M6	4.5 Nm (3.32 lbf ft)	
Screw, brake assembly	M6	5 Nm (3.7 lbf ft)	
Screw, brake fluid reservoir for rear brake	M6	5 Nm (3.7 lbf ft)	
Screw, brake hose bracket	M6	6 Nm (4.4 lbf ft)	Loctite®243™
Screw, chain guard	M6	2 Nm (1.5 lbf ft)	Loctite®243™
Screw, chain guide	M6	8 Nm (5.9 lbf ft)	
Screw, chain sliding guard	M6	8 Nm (5.9 lbf ft)	Loctite®243™

22 TECHNICAL DATA

Screw, clutch assembly	M6	5 Nm (3.7 lbf ft)
Screw, front brake disc	M6	14 Nm (10.3 lbf ft) Loctite®243™
Screw, ignition lock	M6	10 Nm (7.4 lbf ft) Loctite®243™
Screw, license plate holder, bottom	M6	8 Nm (5.9 lbf ft)
Screw, license plate holder, top	M6	8 Nm (5.9 lbf ft)
Screw, magnetic holder on side stand	M6	6 Nm (4.4 lbf ft) Loctite®243™
Screw, radiator bleeding	M6	8 Nm (5.9 lbf ft)
Screw, radiator bracket, bottom	M6	8 Nm (5.9 lbf ft)
Screw, radiator bracket, top	M6	10 Nm (7.4 lbf ft)
Screw, rear brake disc	M6	14 Nm (10.3 lbf ft) Loctite®243™
Screw, rear fender	M6	7 Nm (5.2 lbf ft)
Screw, seat lock	M6	5 Nm (3.7 lbf ft)
Screw, seat support, front	M6	5 Nm (3.7 lbf ft)
Screw, upper part of the air filter box	M6	2 Nm (1.5 lbf ft)
Screw, voltage regulator	M6	8 Nm (5.9 lbf ft)
Screw, wheel speed sensor	M6	6 Nm (4.4 lbf ft)

Handle bar end screw	M8	15 Nm (11.1 lbf ft)
Nut, manifold on cylinder head	M8	20 Nm (14.8 lbf ft) Copper paste
Nut, rear sprocket screw	M8	35 Nm (25.8 lbf ft) Loctite®2701™
Remaining nuts, chassis	M8	25 Nm (18.4 lbf ft)
Remaining screws, chassis	M8	25 Nm (18.4 lbf ft)
Screw, bottom triple clamp	M8	12 Nm (8.9 lbf ft)
Screw, chain sliding piece	M8	15 Nm (11.1 lbf ft)
Screw, connection lever on frame	M8	30 Nm (22.1 lbf ft) Loctite®243™
Screw, foot brake lever	M8	25 Nm (18.4 lbf ft) Loctite®243™
Screw, fork stub	M8	15 Nm (11.1 lbf ft)
Screw, front footrest bracket	M8	25 Nm (18.4 lbf ft)
Screw, fuel tank bracket	M8	15 Nm (11.1 lbf ft)
Screw, fuel tank, bottom	M8	25 Nm (18.4 lbf ft) Loctite®243™
Screw, fuel tank, top	M8	25 Nm (18.4 lbf ft) Loctite®243™
Screw, grab handle	M8	10 Nm (7.4 lbf ft)
Screw, handlebar clamp	M8	20 Nm (14.8 lbf ft)

22 TECHNICAL DATA

Screw, heel protector	M8x12	5 Nm (3.7 lbf ft) Loctite®243™
Screw, main silencer clamp	M8	12 Nm (8.9 lbf ft) Copper paste
Screw, main silencer holder	M8	25 Nm (18.4 lbf ft)
Screw, main silencer holder on fuel tank	M8	25 Nm (18.4 lbf ft)
Screw, rear footrest bracket	M8x16	25 Nm (18.4 lbf ft)
Screw, side stand bracket	M8	25 Nm (18.4 lbf ft) Loctite®243™
Screw, spring holder plate on side stand bracket	M8	25 Nm (18.4 lbf ft) Loctite®243™
Screw, steering stem	M8	20 Nm (14.8 lbf ft) Loctite®243™
Screw, top triple clamp	M8	17 Nm (12.5 lbf ft)
Engine carrying screw	M10	45 Nm (33.2 lbf ft) Loctite®243™
Remaining nuts, chassis	M10	45 Nm (33.2 lbf ft)
Remaining screws, chassis	M10	45 Nm (33.2 lbf ft)
Screw, bottom shock absorber	M10	45 Nm (33.2 lbf ft) Loctite®243™
Screw, brake caliper bleeder, front	M10	25 Nm (18.4 lbf ft)
Screw, engine bearer on frame	M10	45 Nm (33.2 lbf ft)

Screw, handlebar support	M10	45 Nm (33.2 lbf ft)	Loctite®243™
Screw, side stand	M10	35 Nm (25.8 lbf ft)	Loctite®243™
Screw, top shock absorber	M10	45 Nm (33.2 lbf ft)	Loctite®243™
Banjo bolt, brake line	M10x1	25 Nm (18.4 lbf ft)	
Screw, front brake caliper	M10x1.25	45 Nm (33.2 lbf ft)	Loctite®243™
Lambda sensor	M12x1.25	25 Nm (18.4 lbf ft)	Copper paste
Screw, swingarm pivot	M12x1.5	80 Nm (59 lbf ft)	
Nut, angle lever to link fork	M14x1.5	100 Nm (73.8 lbf ft)	
Nut, linkage lever to rocker arm	M14x1.5	100 Nm (73.8 lbf ft)	
Screw, radiator temperature sensor	M18	20 Nm (14.8 lbf ft)	
Screw, bottom steering head	M20x1.5	60 Nm (44.3 lbf ft)	Loctite®243™
Screw, top steering head	M20x1.5	12 Nm (8.9 lbf ft)	
Screw, front wheel spindle	M24x1.5	45 Nm (33.2 lbf ft)	
Nut, rear wheel spindle	M25x1.5	90 Nm (66.4 lbf ft)	

Brake fluid DOT 4 / DOT 5.1

Standard/classification

- DOT

Guideline

- Use only brake fluid that complies with the specified standard (see specifications on the container) and that exhibits the corresponding properties.

Recommended supplier

Castrol

- **REACT PERFORMANCE DOT 4**

MOTOREX®

- **Brake Fluid DOT 5.1**

Coolant

Guideline

- Only use high-grade, silicate-free coolant with corrosion inhibitor additive for aluminum motors. Low grade and unsuitable antifreeze causes corrosion, deposits and frothing.
- Do not use pure water as only coolant is able to meet the requirements needed in terms of corrosion protection and lubrication properties.
- Only use coolant that complies with the requirements stated (see specifications on the container) and that has the relevant properties.

Antifreeze protection to at least	-25 °C (-13 °F)
-----------------------------------	-----------------

The mixture ratio must be adjusted to the necessary antifreeze protection. Use distilled water if the coolant needs to be diluted.

The use of premixed coolant is recommended.

Observe the coolant manufacturer specifications for antifreeze protection, dilution and miscibility (compatibility) with other coolants.

Recommended supplier

MOTOREX®

- **COOLANT M3.0**

Engine oil (SAE 10W/50)

Standard/classification

- JASO T903 MA2 (📖 p. 265)
- SAE (📖 p. 265) (SAE 10W/50)

Guideline

- Use only engine oils that comply with the specified standards (see specifications on the container) and that possess the corresponding properties.

Fully synthetic engine oil

Recommended supplier

MOTOREX®

- **Power Synt 4T**

Fork oil (SAE 4) (48601166S1)

Standard/classification

- SAE (📖 p. 265) (SAE 4)

Guideline

- Use only oils that comply with the specified standards (see specifications on the container) and that exhibit the corresponding properties.

Shock absorber fluid (SAE 2.5) (50180751S1)

Standard/classification

- SAE (📖 p. 265) (SAE 2.5)

Guideline

- Use only oils that comply with the specified standards (see specifications on the container) and that exhibit the corresponding properties.

Super unleaded (ROZ 95)

Standard/classification

- DIN EN 228 (ROZ 95)

Guideline

- Only use super unleaded fuel that matches or is equivalent to the specified standard.
- Fuel with an ethanol content of up to 10% (E10 fuel) is safe to use.



Info

Do **not** use fuel containing methanol (e.g., M15, M85, M100) or more than 10% ethanol (e.g., E15, E25, E85, E100).

Chain cleaner

Recommended supplier

MOTOREX®

- Chain Clean

Long-life grease

Recommended supplier

MOTOREX®

- Bike Grease 2000

Motorcycle cleaner

Recommended supplier

MOTOREX®

- Moto Clean

Perfect finish and high gloss polish for paints

Recommended supplier

MOTOREX®

- Moto Shine

Preserving materials for paints, metal and rubber

Recommended supplier

MOTOREX®

- Moto Protect

Silicone spray

Recommended supplier

MOTOREX®

- Silicone Spray

Special cleaner for glossy and matte paint finishes, metal and plastic surfaces

Recommended supplier

MOTOREX®

- Quick Cleaner

Street chain spray

Guideline

Recommended supplier

MOTOREX®

- Chainlube Road Strong

Universal oil spray

Recommended supplier

MOTOREX®

- Joker 440 Synthetic

JASO T903 MA2

Different technical development directions required a separate specification for motorcycles – the **JASO T903 MA2** standard.

Earlier, engine oils from the automobile industry were used for motorcycles because there was no separate motorcycle specification.

Whereas long service intervals are demanded for automobile engines, the focus for motorcycle engines is on high performance at high engine speeds.

In most motorcycle engines, the transmission and clutch are lubricated with the same oil.

The **JASO T903 MA2** standard meets these special requirements.

SAE

The SAE viscosity classes were defined by the Society of Automotive Engineers and are used for classifying oils according to their viscosity. The viscosity describes only one property of oil and says nothing about quality.



26 INDEX OF SPECIAL TERMS

ABS	Anti-lock braking system	Safety system that prevents locking of the wheels when driving straight ahead without the influence of lateral forces
-	Easy Shift	Engine electronics function for shifting up and down without clutch actuation
MTC	Motorcycle Traction Control	Auxiliary function of the motor control that reduces engine torque with spinning rear wheel
OBD	On-board diagnosis	Vehicle system, which monitors the specified parameters of the vehicle electronics

Art. no.	Article number
ca.	circa
cf.	compare
e.g.	for example
etc.	et cetera
i.a.	inter alia
no.	number
poss.	possibly



28.1 Red symbols

Red symbols indicate an error condition that requires immediate intervention.

	The coolant temperature warning lamp lights up red – The coolant temperature has reached a critical value. Stop immediately (taking care not to endanger yourself or other road users in the process), switch off the engine, allow it to cool down and check the coolant level.
	The oil pressure warning lamp lights up red – The oil pressure is too low. Stop immediately, taking care not to endanger yourself or other road users in the process, and switch off the engine.

28.2 Yellow and orange symbols



Yellow and orange symbols indicate an error condition that requires prompt intervention. Active driving aids are also represented by yellow or orange symbols.

	ABS warning lamp lights up/flashes yellow – If the ABS warning lamp lights up, the ABS is not active. The ABS warning lamp also lights up if a malfunction is detected. Contact an authorized Husqvarna Motorcycles workshop. If the ABS warning lamp flashes slowly, ABS mode Supermoto is active.
	Fuel level warning lamp lights up orange – The fuel level has reached the reserve mark.
	Malfunction indicator lamp lights up orange – The OBD has detected a malfunction in the vehicle electronics. Come safely to a halt, and contact an authorized Husqvarna Motorcycles workshop.

	<p>TC indicator lamp lights up/flashes yellow – If the TC indicator light lights up, the cornering MTC (p. 75) is not active. If the TC indicator light and both ride mode lamps light up at same time, a malfunction has been detected. Contact an authorized Husqvarna Motorcycles workshop. The TC indicator light flashes if the cornering MTC actively engages.</p>
--	--

28.3 Green and blue symbols

Green and blue symbols reflect information.

	<p>The high beam indicator lamp lights up blue – The high beam is switched on.</p>
	<p>The idle indicator lamp lights up green – The transmission is in neutral.</p>
	<p>Turn signal indicator lamp flashes green – The turn signal is switched on.</p>

1

12-V battery

charging	177
installing	175
removing	173

A

ABS	134
------------	-----

ABS fuses

changing	182
----------	-----

ACC1

front	194
-------	-----

ACC2

front	194
-------	-----

Accessories	18
--------------------	----

Air filter

installing	116
removing	115

Anti-lock braking system	134
---------------------------------	-----

Auxiliary substances	18
-----------------------------	----

B

Brake discs

checking	138
----------	-----

Brake fluid

front brake, adding	140
of rear brake, adding	148

Brake fluid level

front brake, checking	139
rear brake, checking	147

Brake linings

front brake, checking	143
rear brake, checking	150

Brakes	76
---------------	----

Braking	76
----------------	----

C

Capacity

coolant	202, 206, 247
engine oil	222, 246
fuel	83, 247

Chain

checking	124
cleaning	118

dirt, checking for	117	Cooling system	195
Chain guide		filling/bleeding	201
checking	124	Cornering MTC	75
setting	129	Customer service	19
Chain tension		D	
adjusting	122	Diagnostics connector	194
checking	120	Driving	68
Changing the headlight bulb	189	E	
Clutch		Easy Shift	74
fluid level, checking/correcting	131	Emergency OFF switch	31
Clutch lever	28	Engine	
basic position, adjusting	130	running in	61
Combination instrument		Engine number	26
adjusting	45	Engine oil	
clock, setting	47	adding	223
kilometers or miles, setting	46	changing	215
overview	44	Engine oil level	
service interval, setting	48	checking	214
Coolant		Engine sprocket	
antifreeze and coolant level, checking	196	checking	124
changing	204	Environment	16
draining	200		
level, checking	198		

F	
Figures	19
Foot brake lever	39
basic position, adjusting	145
free travel, checking	144
Fork	88
compression damping, adjusting	88
dust boots, cleaning	105
fork legs, bleeding	108
rebound, adjusting	90
Fork part number	27
Fork protector	
installing	107
removing	107
Front fender	
installing	114
removing	113
Front wheel	
installing	154
removing	152
Fuel screen	
changing	212
Fuel tank filler cap	
closing	43
opening	41
Fuel, oils, etc.	18
Fuse	
individual electrical power consumers, changing	184
G	
Grab handles	37
H	
Hand brake lever	28
basic position, adjusting	137
Handlebar position	96
adjusting	97
Headlight	
light range, adjusting	193
setting, checking	192
Headlight mask with headlight	
installing	188
removing	187
Horn button	29

I	
Ignition lock	34
Implied warranty	18
Intended use	11
K	
Key number	26
L	
Light switch	30
Loading the vehicle	62
Luggage	62
M	
Main fuse	
changing	179
Manufacturer warranty	18
Misuse	11
Motorcycle	
cleaning	226
lift stand, raising with	100
lift stand, removing from	100
lifting with front lifting gear	103
raising with the rear lifting gear	101
removing the rear from the wheel stand	102

taking off front lifting gear	104
Motorcycle traction control	75
O	
Oil filter	
changing	215
Oil screens	
cleaning	215
Overview of indicator lights	35
Owner's Manual	16
P	
Parking	78
Parking light bulb	
changing	191
Passenger foot pegs	38
Preparing for use	
advice on preparing for first use	59
after storage	234
checks and maintenance measures when	
preparing for use	65
Protective clothing	15

R

Rear hub damping rubber pieces	
checking	163
Rear sprocket	
checking	124
Rear wheel	
installing	159
removing	157
Refueling	
fuel	81
Riding	
starting off	68
Riding mode	
changing	208

S

Safe operation	14
Seat	
mounting	109
removing	109
unlocking	37
Service	19
Service schedule	84-87

Shift lever	38
basic position, adjusting	211
basic position, checking	210
Shifting	68
Shock absorber	88
compression damping, general	91
high-speed compression damping, adjusting	93
low-speed compression damping, adjusting	92
rebound damping, adjusting	95
Shock absorber article number	27
Side cover	
mounting	113
removing	112
Side stand	40
Spare parts	18
Spoke tension	
checking	170
Start button	32
Starting	66
Steering lock	34
Stopping	78
Storage	231

T	
Technical data	
capacities	246
chassis	247
chassis tightening torques	253
electrical system	249
engine	239
engine tightening torques	241
fork	250
shock absorber	251
tires	250
Throttle grip	29
Tire condition	
checking	165
Tire pressure	
checking	169
Tire repair spray	
using	172
Tool set	
removing	110
storing	111
Traction control	
adjusting	209

Transport	80
Troubleshooting	235-238
Tubeless tire system	168
Turn signal switch	30
Type label	25

U	
Use definition	11

V	
Vehicle identification number	24
View of vehicle	
front left	20
rear right	22

W	
Winter operation	
checks and maintenance steps	229
Work rules	15



3402465en

02/2021



Husqvarna Motorcycles GmbH
Stallhofnerstraße 3 | 5230 Mattighofen | Austria
www.husqvarna-motorcycles.com



Photo: Mitterbauer/KISKA,
Husqvarna Motorcycles GmbH

Free Manuals Download Website

<http://myh66.com>

<http://usermanuals.us>

<http://www.somanuals.com>

<http://www.4manuals.cc>

<http://www.manual-lib.com>

<http://www.404manual.com>

<http://www.luxmanual.com>

<http://aubethermostatmanual.com>

Golf course search by state

<http://golfingnear.com>

Email search by domain

<http://emailbydomain.com>

Auto manuals search

<http://auto.somanuals.com>

TV manuals search

<http://tv.somanuals.com>