

GB Operator's manual

FR Manuel d'utilisation

ES Manual de instrucciones

Please read these instructions carefully and make sure you understand them before using the machine.

EDGER ATTACHMENT EA 850

ACCESSOIRE TRANCHE-BORDURE EA 850

SUPLEMENTO CORTABORDES EA 850

Lire attentivement et bien assimiler le manuel d'utilisation avant d'utiliser la machine.

Lea detenidamente el manual de instrucciones y asegúrese de entender su contenido antes de utilizar la máquina.

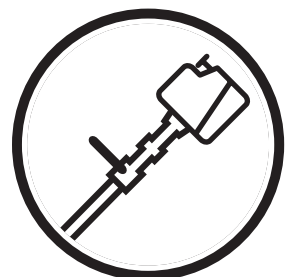

GB FR ES

CONTENTS

Contents

CONTENTS

Contents	2
Note the following before starting:	2
WHAT IS WHAT?	
What is what on the edger attachment?	3
SAFETY INSTRUCTIONS	
Machine's safety equipment	4
General safety precautions	4
General working instructions	5
Basic working techniques	6
ASSEMBLY	
Fitting the bevel gear	7
Fitting the cutter	7
STARTING AND STOPPING	
Starting and stopping	8
MAINTENANCE	
Bevel gear	9
Lubricating the flexible drive shaft	9
Adjusting the edger's cutting depth	9
Maintenance schedule	9
TECHNICAL DATA	
Technical data	9

Note the following before starting:

Please read the operator's manual carefully and make sure you understand the instructions before using the machine.

These instructions supplement the instructions that were included with the machine. For other procedures, please refer to the operating instructions for the machine.

Husqvarna AB has a policy of continuous product development and therefore reserves the right to modify the design and appearance of products without prior notice.

Long-term exposure to noise can result in permanent hearing impairment. So always use approved hearing protection.



WARNING! Under no circumstances may the design of the machine be modified without the permission of the manufacturer. Always use genuine accessories. Non-authorized modifications and/or accessories can result in serious personal injury or the death of the operator or others.



WARNING! This accessory may only be used together with the intended clearing saw/trimmer, see under heading "Approved accessories" in chapter Technical data in the machine's Operator's Manual.

The machine is only designed for edging lawns.

WHAT IS WHAT?

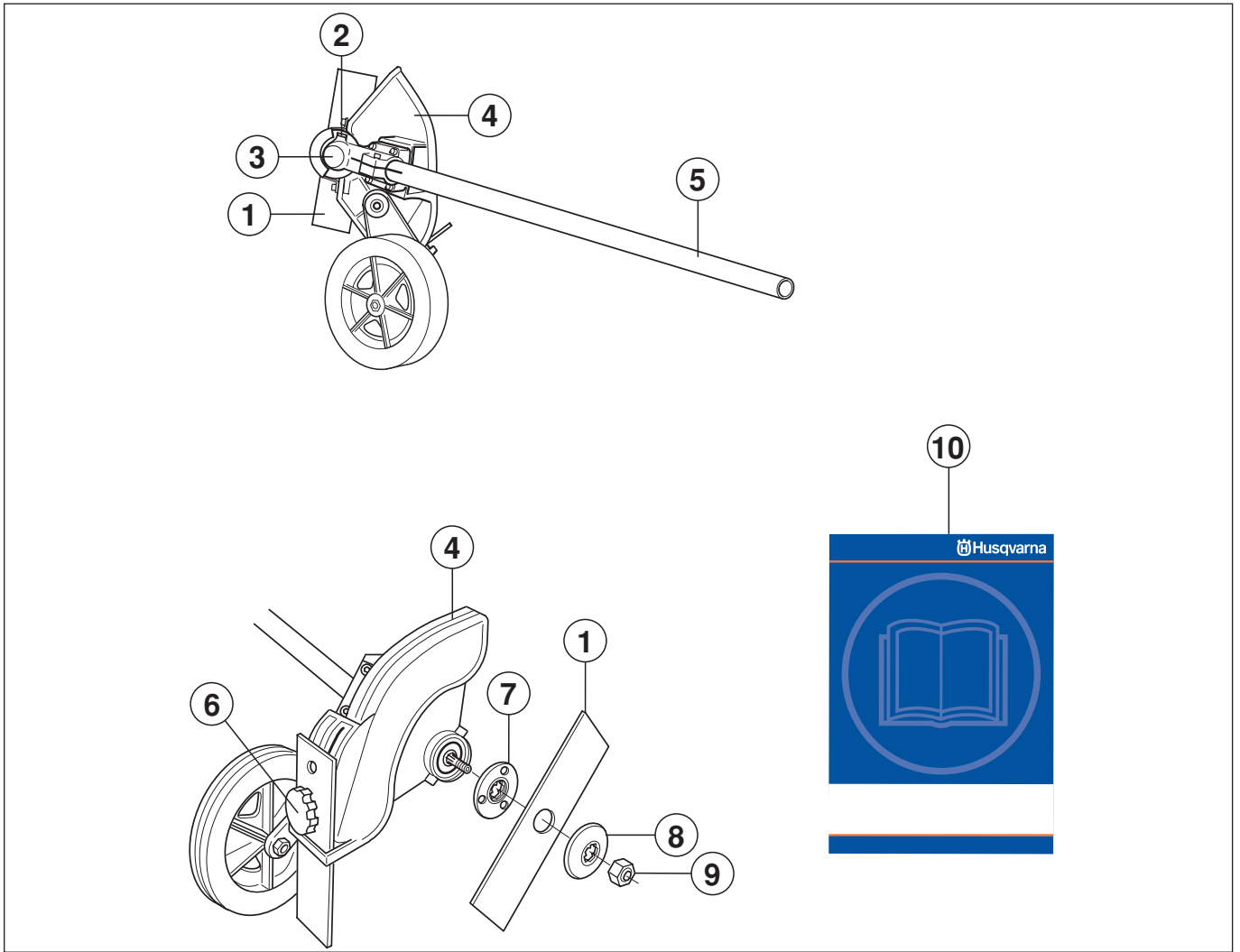

What is what on the edger attachment?

- | | |
|---------------------------------|----------------------|
| 1 Cutter | 6 Locking knob |
| 2 Grease filler cap, bevel gear | 7 Drive disc |
| 3 Bevel gear | 8 Support flange |
| 4 Blade guard | 9 Locking nut |
| 5 Shaft | 10 Operator's manual |

SAFETY INSTRUCTIONS

Machine's safety equipment

This section describes the machine's safety equipment, its purpose, and how checks and maintenance should be carried out to ensure that it operates correctly. See the "What is what?" section to locate where this equipment is positioned on your machine.

The life span of the machine can be reduced and the risk of accidents can increase if machine maintenance is not carried out correctly and if service and/or repairs are not carried out professionally. If you need further information please contact your nearest service workshop.



WARNING! Never use a machine with faulty safety equipment. The machine's safety equipment must be checked and maintained as described in this section. If your machine fails any of these checks contact your service agent to get it repaired.



WARNING! Always stop the engine before you work on any part of the cutting equipment. This continues to move even after the throttle is released. Check that the cutting equipment has stopped completely and remove the HT lead from the spark plug before you start any work on it.

Cutting attachment guard

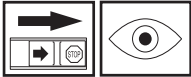

This guard is intended to prevent loose objects from being thrown towards the operator. The guard also protects the operator from accidental contact with the cutting attachment.

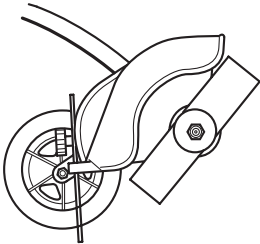

- Check that the guard is undamaged and not cracked. Replace the guard if it has been exposed to impact or is cracked.
- Only use cutting attachments with the guards we recommend! See the chapter on Technical data.

Cutting equipment



The cutter is designed and manufactured to withstand the loads that edging of a lawn involves.

Check the cutting attachment for damage or cracks. A damaged cutting attachment should always be replaced.

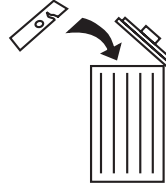

Locking nut

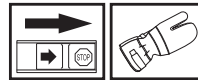

The locking nut secures the cutting attachment on the output shaft.

Protect your hand from injury when assembling, use the blade guard as protection when tightening with a socket spanner.

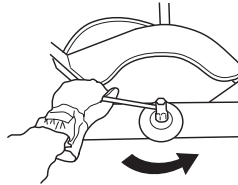

When fitting, tighten the nut in the opposite direction to the direction of rotation of the cutting attachment. To remove it, undo the nut in the same direction as the cutting attachment rotates. (CAUTION! The nut has a left-hand thread.)



CAUTION! The nylon lining inside the locking nut must not be so worn that you can turn it by hand. The lining should offer a resistance of at least 1.5 Nm. The nut should be replaced after it has been put on approx. 10 times.

General safety precautions



WARNING! The machine can cause serious personal injury. Read the safety instructions carefully. Learn how to use the machine.



WARNING! A faulty cutting attachment may increase the risk of accidents.

CAUTION! Please read the operator's manual carefully and make sure you understand the instructions before using the machine.

SAFETY INSTRUCTIONS

Personal protection

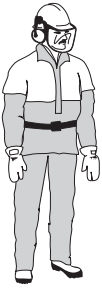

- Always wear boots and other equipment described under the heading Personal protective equipment.
- Always wear working clothes and heavy-duty long trousers.
- Never wear loose clothing or jewellery.
- Make sure your hair does not hang below shoulder level.

Safety instructions regarding the surroundings

- Never allow children to use the machine.
- Ensure that no-one comes closer than 15 m while you are working.
- Never allow anyone else to use the machine without first ensuring that they have understood the contents of the operator's manual.

Safety instructions before starting work



- Inspect the working area. Remove all loose objects, such as stones, broken glass, nails, steel wire, string, etc. that could be thrown out or become wrapped around the cutter or cutter guard.
- Keep unauthorised persons at a distance. Children, animals, onlookers and helpers should be kept outside the safety zone of 15 m. Stop the machine immediately if anyone approaches.
- Check the entire machine before starting. Replace damaged parts. Check that there are no fuel leaks and that all guards and covers are complete and fastened securely. Check all nuts and screws.
- Check that the cutter is not cracked or damaged in any other way.

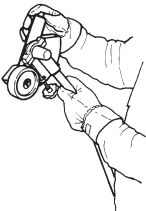

- Make sure the cutter guard is fitted and not damaged.

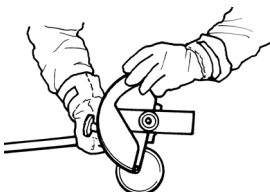

- Check that the cutter and cutter guard are correctly secured.
- When adjusting the carburettor make sure the cutter is held against the ground and that no-one is in the immediate vicinity.
- Make sure the cutter always stops when the engine is idling.
- Make sure that the handle and safety features are in good working order. Never use a machine that lacks a part or has been modified outside its specifications.
- Only use the machine for the purpose it was intended for.

General working instructions

IMPORTANT INFORMATION

This section describes the basic safety rules for working with edgers.

If you encounter a situation where you are uncertain how to proceed you should ask an expert. Contact your dealer or your service workshop.

Avoid all usage which you consider to be beyond your capability.

Basic safety rules



- 1 Look around you:
 - To ensure that people, animals or other things cannot affect your control of the machine.
 - To ensure that people, animals, etc., do not come into contact with the cutting attachment or loose objects that are thrown out by the cutting attachment.
 - CAUTION! Do not use the machine unless you are able to call for help in the event of an accident.
- 2 Do not use the machine in bad weather, such as dense fog, heavy rain, strong wind, intense cold, etc.
- 3 Make sure you can move and stand safely. Check the area around you for possible obstacles (roots, rocks, branches, ditches, etc.) in case you have to move suddenly. Take great care when working on sloping ground.



- 4 The engine must be switched off before moving.
- 5 Never put the machine down with the engine running unless you have it in clear sight.

SAFETY INSTRUCTIONS

Basic working techniques

Safety instructions while working



- Always ensure you have a safe and stable working position.
- Always use both hands to hold the machine. Hold the machine at the side of your body.



- Use your right hand to control the throttle setting.

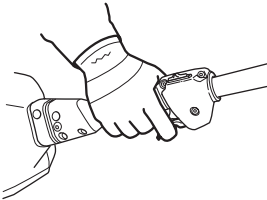

- Make sure that your hands and feet do not come near the cutting attachment when the engine is running.
- When the engine is switched off, keep your hands and feet away from the cutting attachment until it has stopped completely.



- Always carry out edging at full throttle.
- Always keep the cutter close to the ground.
- Always slow the engine to idle speed after each working operation. Long periods at full throttle without any load on the engine (i.e. without the resistance that the cutting attachment exerts on the engine when you are using the machine) can lead to serious engine damage.
- Be especially careful when pulling the edger towards you during work.
- If any foreign object is hit or if vibrations occur stop the machine immediately. Disconnect the HT lead from the spark plug. Check that the machine is not damaged. Repair any damage.



WARNING! Sometimes grass or stones can get trapped in the cutter guard and cutter. Always stop the engine before cleaning.



WARNING! Watch out for thrown objects. Always wear approved eye protection. Never lean over the cutting attachment guard. Stones, rubbish, etc. can be thrown up into the eyes causing blindness or serious injury.

Safety instructions after completing work



- Make sure the cutting attachment has stopped before cleaning, carrying out repairs or an inspection. Disconnect the HT lead from the spark plug.
- Always wear heavy-duty gloves when repairing the cutting attachment. This is extremely sharp and can easily cause cuts.

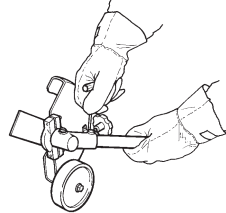

- Store the machine out of reach of children.
- Use only original spare parts for repairs.

ASSEMBLY

Fitting the bevel gear

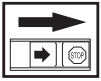

Fit the bevel gear on the shaft. Turn the cutter so that the shaft engages in the bevel gear.

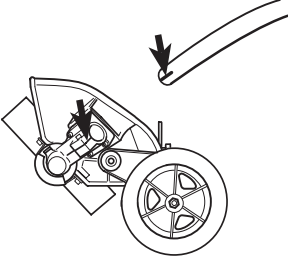

Position the bevel gear so that the slot aligns with the line on the shaft.

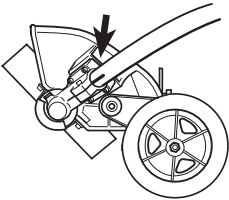

Firmly tighten the screw.

Fitting the cutter

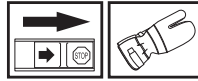

Fit the cutter as follows:

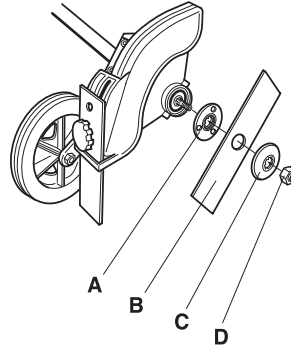

- 1 Fit the drive disc (A) on the output shaft. Make sure that the edge that engages in the hole in the cutter is facing outwards.

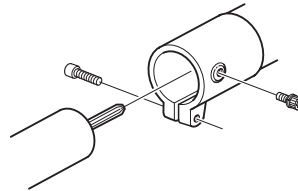

- 2 Prevent the cutter from rotating by inserting the locking pin in the hole behind the cutter guard, so that it engages it in the corresponding hole in the drive disc.
- 3 Place the cutter (B) on the drive disc.
- 4 Fit the support flange (C). The support flange must be fitted so that its outer edge presses against the cutter.
- 5 Fit the locking nut (D). CAUTION! The locking nut has a left-hand thread. Tighten the locking nut to a torque of 35-50 Nm.
- 6 Remove the locking pin.

CAUTION! Do not forget to remove the locking pin before using the machine.



WARNING! Under no circumstances may the edger cutter be used without the cutter guard fitted.

STARTING AND STOPPING

Starting and stopping

Check before starting

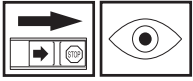

- For safety reasons follow these recommendations!
- Check that the support flange is not cracked due to fatigue or due to being tightened too much. Discard the support flange if it is cracked.

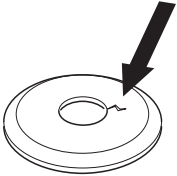

- Ensure the locking nut has not lost its captive force. The nut lock should have a locking force of at least 1.5 Nm. The tightening torque of the locking nut should be 35-50 Nm.



- Check that the cutter and cutter guard are not damaged or cracked. Replace the cutter or cutter guard if they have been exposed to impact or if they are cracked.

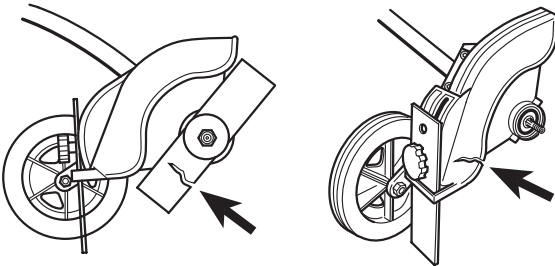

- Check that the cutting attachment always stops when the engine is idling.
- Only use the machine for the purpose it was intended for.
- Make sure that the handle and safety features are in good working order. Never use a machine that lacks a part or has been modified outside its specifications.

MAINTENANCE

Bevel gear



The bevel gear is filled with the right quantity of grease at the factory. However, before using the machine you should check that the bevel gear is filled three-quarters full with grease. Use HUSQVARNA special grease.

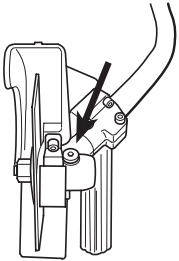

The grease in the bevel gear does not normally need to be changed except if repairs are carried out.

Lubricating the flexible drive shaft



Inside the hollow drive shaft of the edger is a flexible drive shaft. This flexible drive shaft should be regularly lubricated every 25 hours in operation. Loosen the two screws on the bevel gear and remove it. The flexible drive shaft is easily removed from the hollow shaft by taking a firm grip on the shaft end. Lubricate the entire length of the flexible drive shaft and reinsert it in the hollow drive shaft. Turn the shaft while inserting it so that it correctly engages in the clutch. Refit the bevel gear on the hollow drive shaft and tighten the two screws.

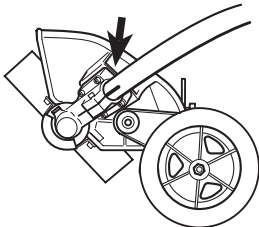

Adjusting the edger's cutting depth



The cutting depth must be adjusted before starting work.

- Loosen the locking knob (A) and rotate the guard by moving the locking knob forwards or backwards. If the locking knob is moved forwards (away from the machine) the cutting depth is increased. If the locking handle is moved backwards (towards the machine) the cutting depth is reduced.

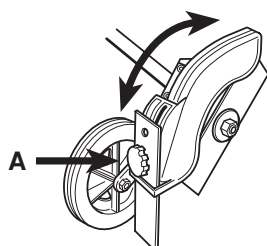

- Set the desired cutting depth.
- Lock the locking knob.

Maintenance schedule

Below you will find some general maintenance instructions. If you need further information please contact your service workshop.

Daily maintenance

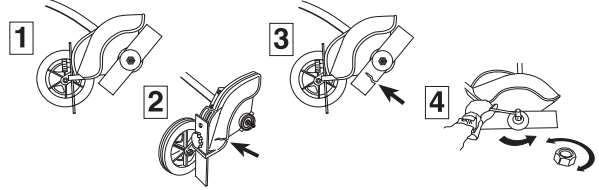

- Check that the cutter does not rotate when the engine is idling.
- Check that the guard is undamaged and not cracked. Replace the guard if it has been exposed to impact or is cracked.
- Check that the cutter is undamaged and not cracked. Replace the cutter if necessary.
- Check that the locking nut is tight.

Weekly maintenance

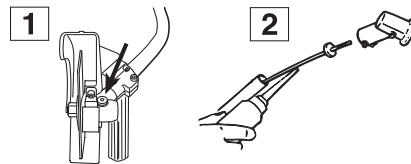

- Check that the bevel gear is filled three-quarters full with lubricant. Fill if necessary using special grease.
- The flexible drive shaft must be lubricated every 25 working hours or more frequently.

Technical data

Technical data

Weight, Lbs/kg	1,6
Blade length, mm	195
Centre hole, blade, inch/mm	1 / 25,4
Speed, blade, rpm	7140

1150309-20



2006-10-03

Free Manuals Download Website

<http://myh66.com>

<http://usermanuals.us>

<http://www.somanuals.com>

<http://www.4manuals.cc>

<http://www.manual-lib.com>

<http://www.404manual.com>

<http://www.luxmanual.com>

<http://aubethermostatmanual.com>

Golf course search by state

<http://golfingnear.com>

Email search by domain

<http://emailbydomain.com>

Auto manuals search

<http://auto.somanuals.com>

TV manuals search

<http://tv.somanuals.com>