

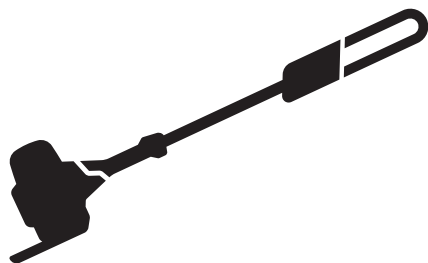

Husqvarna[®]



535FBX, TA1100

Contents

Introduction 535FBX.....	2	EC Declaration of Conformity 535FBX.....	32
Safety 535FBX.....	5	Introduction TA1100.....	33
Assembly 535FBX.....	11	Safety TA1100.....	34
Operation 535FBX.....	15	Assembly TA1100.....	36
Maintenance 535FBX.....	19	Operation TA1100.....	37
Troubleshooting.....	28	Technical data TA1100.....	38
Transportation and storage.....	29	Accessories	38
Technical data 535FBX.....	29	EC Declaration of Conformity TA1100.....	39
Accessories	31		

Introduction 535FBX

Intended use

The product is used for cutting branches and twigs.

Note: National regulations can set limit to the operation of the product.

Only use the product with accessories that are approved by the manufacturer. Refer to *Accessories on page 38*.

Product overview 535FBX

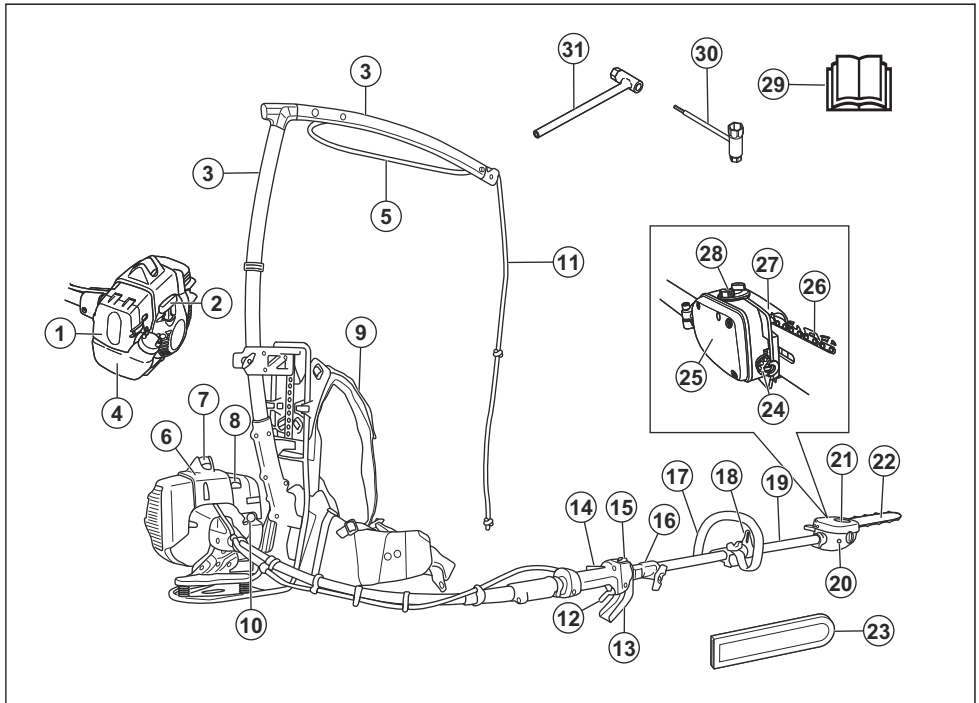

1. Air filter cover
2. Starter rope handle
3. Load reducer
4. Fuel tank
5. Stem guard
6. Engine cover
7. Spark plug cap and spark plug
8. Choke control
9. Harness
10. Air purge bulb
11. Cord
12. Throttle trigger
13. Throttle hand guard
14. Throttle trigger lockout
15. Stop switch
16. Shaft coupling
17. Loop handle
18. Suspension ring
19. Shaft
20. Adjustment screw for the chain lubrication
21. Bar nut
22. Guide bar
23. Transport guard

24. Chain tension screw
25. Chain oil tank
26. Saw chain
27. Protective guard for saw chain
28. Chain oil tank
29. Operator's manual
30. Combination wrench
31. Spark plug wrench

Symbols on the product



WARNING! This product is dangerous. Injury or death can occur to the operator or bystanders if the product is not used carefully and correctly. To prevent injury to the operator or bystanders, read and obey all safety instructions in the operator's manual.



Please read the operator's manual carefully and make sure that you understand the instructions before use.



Use a protective helmet in locations where objects can fall on you. Use approved hearing protection. Use approved eye protection.



Use approved protective gloves.



Use heavy-duty slip-resistant boots.



Fuel.



Chain oil.



Adjustment of the oil flow.



Direction of rotation, saw chain.

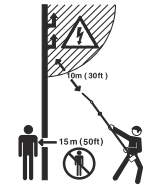

This product is not electrically insulated. If the product touches or comes close to high-voltage power lines it could lead to death or serious injury. Electricity can jump from one point to another by arcing. The higher the voltage, the greater the distance electricity can jump. Electricity can also travel through branches and other objects, especially if they are wet. Always keep a distance of at least 10 m between the machine and high-voltage power lines and/or any objects that are touching them. If you have to work within this safe distance you should always contact the relevant power company to make sure the power is switched off before you start work.

The operator of the product must ensure, while working, that no persons or animals come closer than 15 meters.



Primer bulb.



Choke.



Noise emission to the environment refer to the European Community's Directive. The emission of the product is specified in the Technical data chapter and on the label.



The product agrees with the applicable EC directives.

yyyywwxxxx

The rating plate shows the serial number. **yyyy** is the production year, **ww** is the production week and **xxxx** is the sequential number.

Note: Other symbols/decals on the product refer to certification requirements for other commercial areas.

Euro V Emissions



WARNING: Tampering with the engine voids the EU type-approval of this product.

Product liability

As referred to in the product liability laws, we are not liable for damages that our product causes if:

- the product is incorrectly repaired.
- the product is repaired with parts that are not from the manufacturer or not approved by the manufacturer.
- the product has an accessory that is not from the manufacturer or not approved by the manufacturer.
- the product is not repaired at an approved service center or by an approved authority.

Safety 535FBX

Safety definitions

Warnings, cautions and notes are used to point out specially important parts of the manual.



WARNING: Used if there is a risk of injury or death for the operator or bystanders if the instructions in the manual are not obeyed.



CAUTION: Used if there is a risk of damage to the product, other materials or the adjacent area if the instructions in the manual are not obeyed.

Note: Used to give more information that is necessary in a given situation.

General safety instructions



WARNING: Read the warning instructions that follow before you use the product.

- This product produces an electromagnetic field during operation. This field may under some circumstances interfere with active or passive medical implants. To reduce the risk of serious or fatal injury we recommend persons with medical implants to consult their physician and the medical implant manufacturer before operating this product.
- This product is a dangerous tool if you are not careful or if you use the product incorrectly. This product can cause serious injury or death to the operator or others.
- It is very important that you read and understand the contents of this operator's manual. If you feel uncertainty about a work situation or the operating procedures after you read the operator's manual, speak to a service agent before you continue.
- Under no circumstances may the design of the product be modified without the permission of the manufacturer. Do not use a product that appears to have been modified by others and only use accessories recommended for this product. Non-authorized modifications and/or accessories can result in serious personal injury or the death of the operator or others.
- Do a check of the product before use. Refer to *Safety devices on the product on page 7* and *To check before starting on page 15*. Do not use a defective product. Do the safety checks, maintenance and service instructions described in this manual.

Safety instructions for assembly



WARNING: Read, understand and obey these instructions carefully before you use the product.

- The complete clutch cover and shaft must be fitted before the machine is started, otherwise the clutch can come loose and cause personal injury.
- The only accessories you can operate with this product are the cutting attachments we recommend. Refer to *Accessories on page 38*.
- Use approved protective gloves.
- Make sure that you assemble the protective cover and shaft correctly before you start the engine.
- To operate the product safely and prevent injury to the operator or other persons, the product must always be attached correctly to the harness.

Safety instructions for operation



WARNING: Read the warning instructions that follow before you do maintenance on the product.

- Use personal protective equipment, refer to *Personal protective equipment on page 6*.
- This product is not electrically insulated. If the product touches or comes close to high-voltage power lines it could lead to death or serious bodily injury. Electricity can jump from one point to another by arcing. The higher the voltage, the greater the distance electricity can jump. Electricity can also travel through branches and other objects, especially if they are wet. Always keep a distance of at least 10 m between the product and high-voltage power lines and/or any objects that are touching them. If have to work within this safe distance you should always contact the relevant power company to make sure the power is switched off before you start work.
- Overexposure to vibration can lead to circulatory damage or nerve damage in persons who have poor circulation. Speak to your physician if you experience symptoms of overexposure to vibration. Such symptoms include numbness, loss of feeling, tingling, pricking, pain, loss of strength, changes in skin colour or condition. These symptoms usually show in the fingers, hands or wrists. The risk increases at low temperatures.
- The inside of the muffler contain chemicals that may be carcinogenic. Avoid contact with these elements in the event of a damaged muffler. Long term inhalation of the engine's exhaust fumes, chain oil mist and sawdust can represent a health risk.
- Never use the machine indoors or in spaces lacking proper ventilation. Exhaust fumes contain carbon

monoxide, an odourless, poisonous and highly dangerous gas.

- Do not operate a product without a muffler or with a defective muffler. A defective muffler can increase the noise level and the risk of fire. Keep fire extinguishing tools near. If you must have a spark arrestor mesh in your area, do not use the product without or with a broken spark arrestor mesh.
- If the saw chain does not stop when idling, adjust the idle speed. Refer to *To adjust the throttle wire on page 20*. Do not use the product until it is correctly adjusted or repaired.
- This product has a long reach. Make sure that no people or animals come closer than 15 m when the product is running. Always look behind you before you turn around with the product. Stop the product immediately if a person or animal enters the 15 m safety zone. If more than one operator does work in the same area, keep a safety distance of a minimum of 15 m.
- Observe the applicable safety regulations for work in the vicinity of overhead power lines. Also falling branches can result in short-circuiting.
- Never stand directly underneath a branch that is being cut. This could lead to serious or even fatal personal injury.
- Watch out for stumps of branches that can be thrown out when you cut. Do not cut too close to the ground where stones and other objects can be thrown out.
- Do not operate the product in bad weather, such as dense fog, heavy rain, strong wind and intense cold. To operate in bad weather can make you tired and add risks, such as icy ground and unpredictable felling direction.
- Do not use the product if you are tired, ill, or under the influence of alcohol, drugs or medicine, as this has a negative effect on your vision, alertness, coordination and judgment.
- Make sure that you can move safely and have a safe stance. Examine the area around you for obstacles such as roots, rocks, branch and ditches. Be careful during work on slopes.
- Do not remove the cut material, or let other persons remove cut material, while the engine is on or the cutting equipment rotates, as this can result in serious injury.
- Do not overreach. Keep a stable position of the feet and a good balance at all times.

- Always hold the product with both hands. Hold the product on the right side of your body.

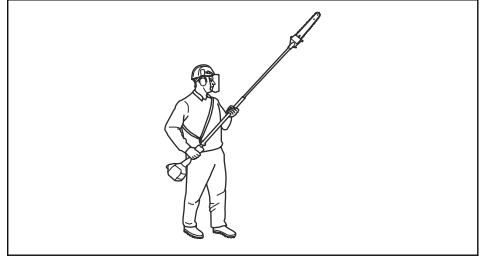

- Keep your hands and feet away from the saw chain until it has stopped completely when the product is deactivated.
- Never work from a ladder, stool or any other raised position that is not fully secured.
- Do not put the product down with the engine on unless you have it in clear view.
- Listen for warning signals and loud voices when you use hearing protection. Always remove your hearing protection when the engine stops.
- Stop the engine before you move to a new work area. Always attach the transport guard before you move the equipment.
- Never allow children to use or be in the vicinity of the product. Remove the spark plug cap when the product is not under close supervision.

Personal protective equipment



WARNING: Read the warning instructions that follow before you use the product.

- Always use approved personal protective equipment when you use the product. Personal protective equipment cannot fully prevent injury but it decreases the degree of injury if an accident does occur. Let your dealer help you select the right equipment.
- Use a protective helmet where there is a risk of falling objects.

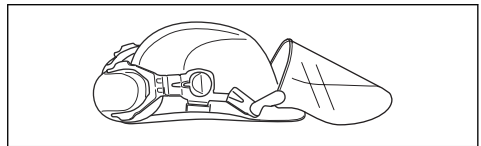

- Use approved hearing protection that provides adequate noise reduction. Long-term exposure to noise can result in permanent hearing impairment.

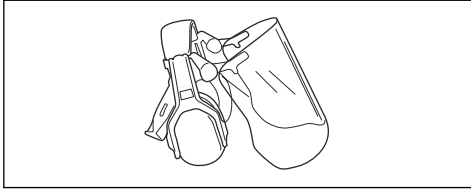

- Use approved eye protection. If you use a visor, you must also use approved protective goggles. Approved protective goggles must comply with the ANSI Z87.1 standard in the USAs or EN 166 in EU countries.

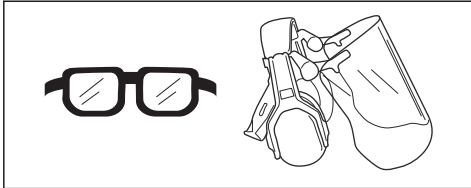

- Use gloves when necessary, for example when you attach, examine or clean the cutting equipment.

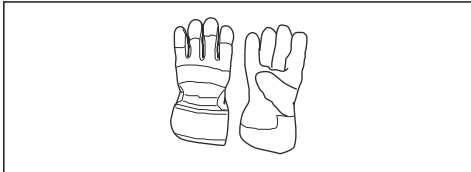

- Use sturdy non-slip boots.



- Use clothing made of a strong fabric. Always use heavy, long pants and long sleeves. Do not use loose clothing that can catch on twigs and branches. Do not wear jewelry, short pants, sandals or go with bare feet. Put your hair up safely above shoulder level.
- Keep first aid equipment close at hand.

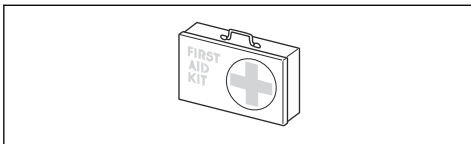

Safety devices on the product



WARNING: Read the warning instructions that follow before you use the product.

- Do not use a product with defective safety devices.
- Do a check of the safety devices regularly. Refer to *Maintenance schedule* on page 19.
- If the safety devices are defective, speak to your Husqvarna servicing dealer.

To do a check of the throttle trigger lockout

The throttle lockout is designed to prevent accidental operation of the throttle control.

1. Press the throttle trigger lockout (A) and make sure that the throttle control is released (B). When you release the handle the throttle control and the throttle trigger lockout both move back to their initial positions. This movement is controlled by two independent return springs. This arrangement means that the throttle control is automatically locked at the idle setting.

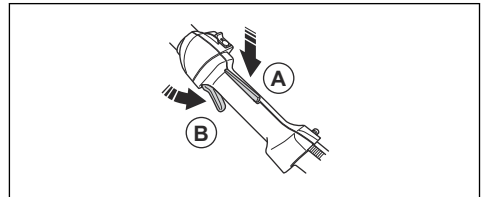

2. Make sure that the throttle control is locked at the idle setting when the throttle trigger lockout is released.

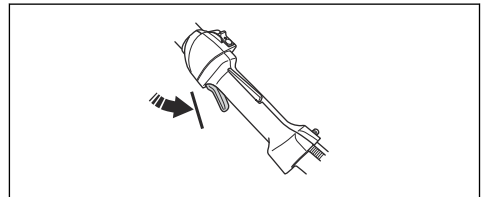

3. Press the throttle trigger lockout and make sure that it returns to its initial position when you release it.

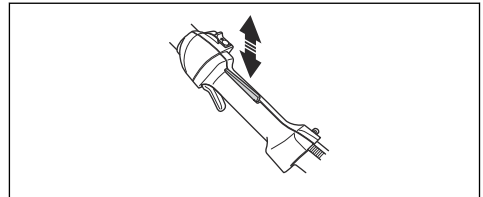

4. Do a check of the throttle control and throttle trigger lockout move freely and that the return springs work properly.

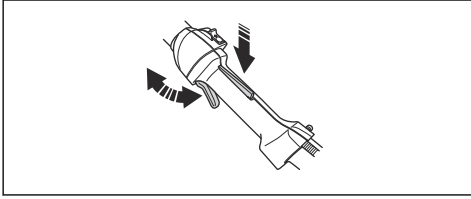

5. Start the product (refer to instructions under *To start the product on page 18*) and apply full throttle.
6. Release the throttle and make sure that the saw chain stops and remains at a standstill. If the saw chain rotates with the throttle in the idle position the carburettor idle setting must be checked. Refer to instructions under the chapter *To adjust the idle speed on page 20*.

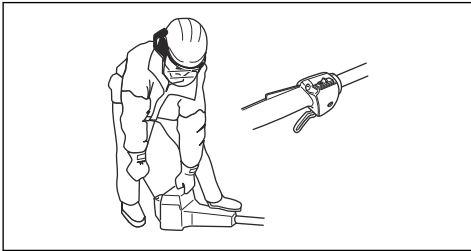

To do a check of the stop switch

1. Start the engine.
2. Move the stop switch to the stop position and make sure that the engine stops.

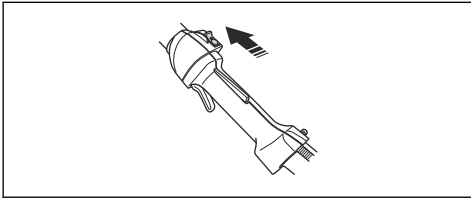

To do a check of the vibration damping system

The vibration damping system of the product decreases the vibration between the engine unit and the shaft unit of the product. This keeps the vibration in the handles to a minimum which makes the operation easier.

1. Stop the engine.

2. Do a visual check for deformation and damage, for example cracks.

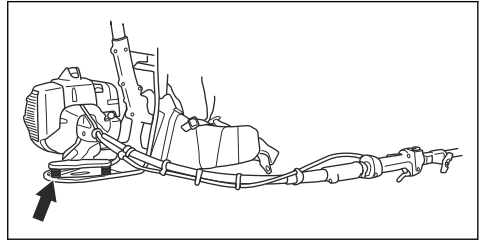

3. Make sure that the elements of the vibration damping systems is attached correctly.

To do a check of the muffler



WARNING: Bear in mind that the exhaust fumes from the engine are hot and may contain sparks which can start a fire. Never start the product indoors or near combustible material!



WARNING: Never use the machine indoors or in spaces lacking proper ventilation. Exhaust fumes contain carbon monoxide, an odourless, poisonous and highly dangerous gas.



WARNING: Never use a product with a faulty muffler.



The muffler keeps noise levels to a minimum and sends exhaust fumes away from the operator. For mufflers it is very important that you follow the instructions on how to check, maintain and service your product.

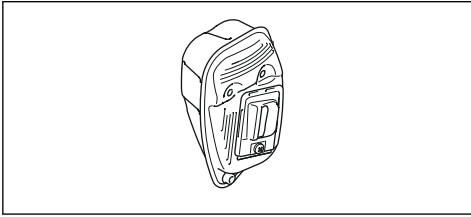

- Do a visual check for damage and deformation.
- Make sure that the muffler is correctly attached to the product.

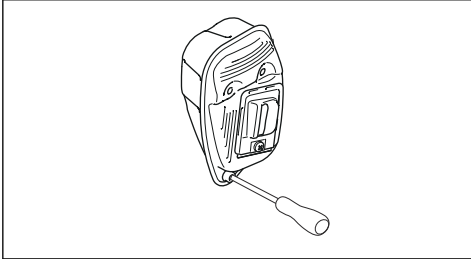

- If the muffler on your product has a spark arrester screen, do a visual check. Replace the spark arrester screen if it is damaged.
 - a) Clean the spark arrester screen if it is blocked. A blocked mesh will make the engine overheated which can cause serious damage.
 - b) Make sure that the spark arrester mesh is attached correct.

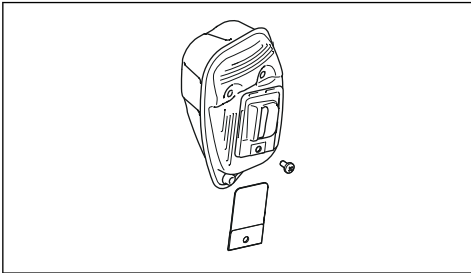

Fuel safety



WARNING: Read the warning instructions that follow before you use the product.

- Do not mix the fuel indoor or near a heat source.
- Do not start the product if there is fuel or engine oil on the product. Remove the unwanted fuel/oil and let the product dry. Remove unwanted fuel from the product.
- If you spill fuel on your clothing, change clothing immediately.

- Do not get fuel on your body, it can cause injury. If you get fuel on your body, use a soap and water to remove the fuel.
- Do not start the engine if you spill oil or fuel on the product or on your body.
- Do not start the product if the engine has a leak. Examine the engine for leaks regularly.
- Be careful with fuel. Fuel is flammable and the fumes are explosive and can cause injuries or death.
- Do not breathe in the fuel fumes, it can cause injury. Make sure that there is a sufficient airflow.
- Do not smoke near the fuel or the engine.
- Do not put warm objects near the fuel or the engine.
- Do not add the fuel when the engine is on.
- Make sure that the engine is cool before you refuel.
- Before you refuel, open the fuel tank cap slowly and release the pressure carefully.
- Do not add fuel to the engine in an indoor area. Not sufficient airflow can cause injury or death because of asphyxiation or carbon monoxide.
- Tighten the fuel tank cap carefully or a fire can occur.
- Move the product at a minimum of 3 m (10 ft) from the position where you filled the tank before a start.
- Do not put too much fuel in the fuel tank.
- Make sure that a leak cannot occur when you move the product or fuel container.
- Do not put the product or a fuel container where there is an open flame, spark or pilot light. Make sure that the storage area does not contain an open flame.
- Only use approved containers when you move the fuel or put the fuel into storage.
- Empty the fuel tank before long-term storage. Obey the local law on where to dispose fuel.
- Clean the product before long-term storage.
- Remove the spark plug cap before you put the product into storage to make sure that the engine does not start accidentally.

Safety instructions for maintenance



WARNING: Read the warning instructions that follow before you do maintenance on the product.

- Do only the maintenance and servicing given in this operator's manual. Let professional servicing personnel do all other servicing and repairs.
- Regularly do the safety checks, maintenance and service instructions given in this manual. Regular maintenance increases the life of the product and decreases the risk of accidents. Refer to *Maintenance 535RBX on page 19* for instructions.
- If the safety checks in this operator's manual is not approved after you do maintenance, speak to your servicing dealer. We guarantee that there are

professional repairs and servicing available for your product.

Safety instructions for the cutting equipment



WARNING: Read the warning instructions that follow before you use the product.

- Only use the guide bar/saw chain combinations and filing equipment that we recommend. Refer to *Filing equipment and filing angles on page 31* for instructions.
- Use protective gloves when you use or do maintenance on the saw chain. A saw chain that does not move can also cause injuries.
- Keep the cutting teeth correctly sharpened. Obey the instructions and use the recommended file gauge. A saw chain that is damaged or incorrectly sharpened increases the risk of accidents.

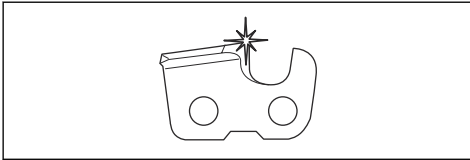

- Keep the correct depth gauge setting. Obey the instructions and use the recommended depth gauge setting.

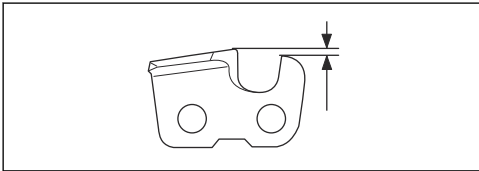

- Make sure that the saw chain has the correct tension. If the saw chain is not tight against the guide bar, the saw chain can derail. An incorrect saw chain tension increases wear on the guide bar, saw chain and chain drive sprocket. Refer to *To tension the chain on page 27*.

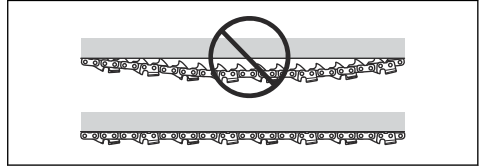

- Do maintenance on the cutting equipment regularly and keep it correctly lubricated. If the saw chain is not correctly lubricated, the risk of wear on the guide bar, saw chain and chain drive sprocket increases.

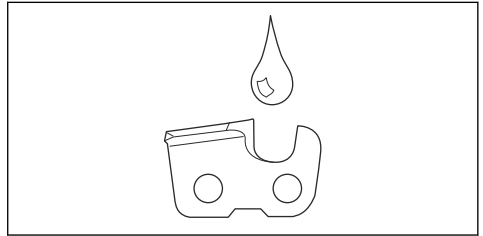

Assembly 535FBX

To assemble the engine to the frame

1. Assemble the engine and the frame with the bolt. Make sure that the heel is put on the correct side of the stop. Refer to the illustration.

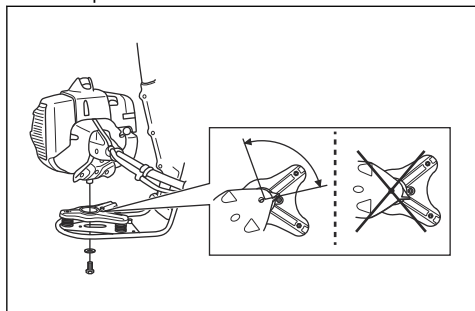

2. Tighten the nut with the combination wrench to approximately 15 Nm.

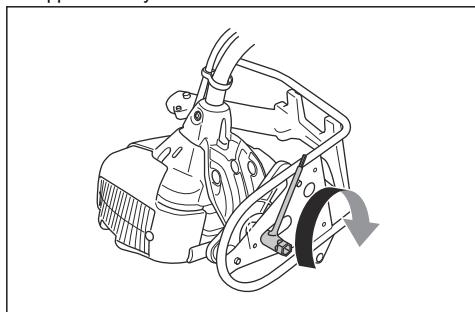

To assemble the load reducer

1. Attach the bottom part of the load reducer to the frame.
2. Adjust the bottom part of the load reducer to a correct work height. Tighten the knob.

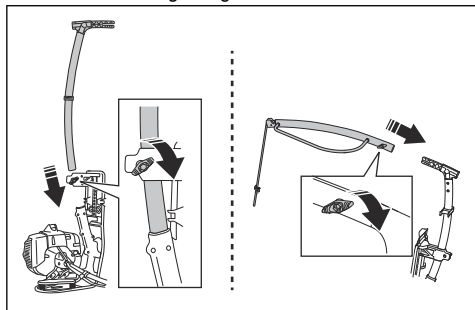

3. Install the top part of the load reducer. Tighten the knob.

To assemble the two-piece shaft

1. Turn the knob to loosen the coupling.
2. Align the tab of the cutting attachment (A) with the arrow of the coupling (B).

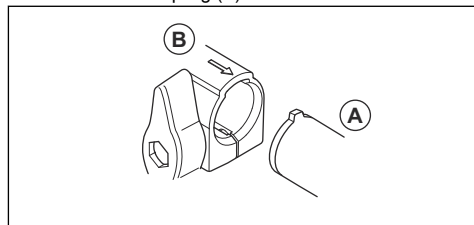

3. Carefully push the shaft into the coupling until you hear a click.

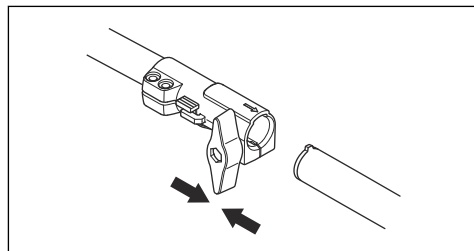

4. Tighten the knob fully.

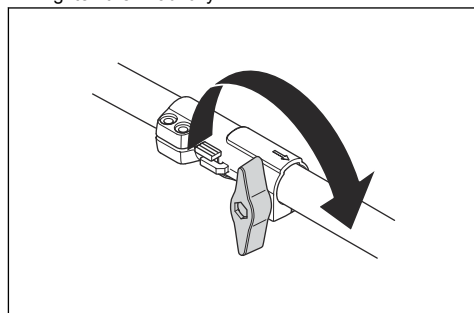

To disassemble the two-piece shaft

1. Turn the knob 3 turns or more to loosen the coupling.

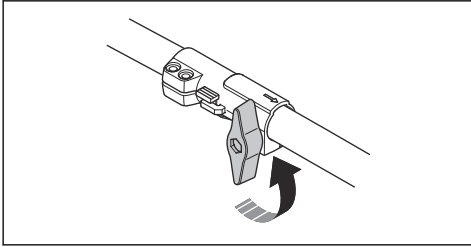

2. Push and hold the button (C).
3. Hold tight in the end of the shaft that the engine is attached to.
4. Pull the attachment straight out of the coupling.

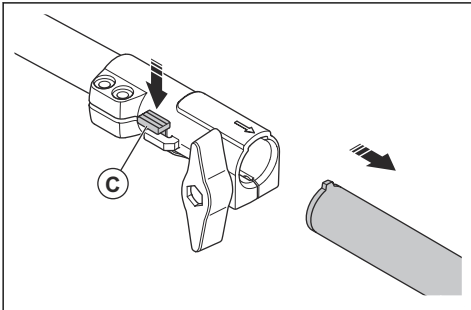

To assemble the loop handle

1. Put the loop handle onto the shaft, between the arrows.

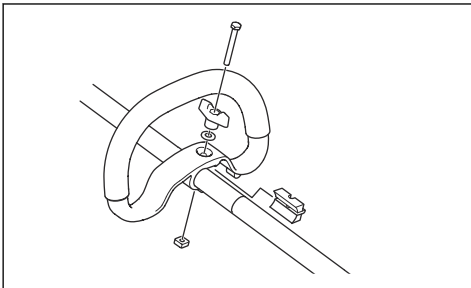

2. Put the spacer into the slot of the loop handle.
3. Install the nut, the knob and the screw. Do not tighten fully.
4. Adjust the product to an applicable operation position.
5. Tighten the knob.

To assemble the bar and chain

1. Unscrew the bar nut and remove the protective cover.
2. Fit the bar over the bar bolt. Place the bar in its rearmost position. Place the chain over the drive sprocket and in the groove on the bar. Begin on the top side of the bar.
3. Make sure that the edges of the cutting links are facing forward on the top edge of the guide bar.

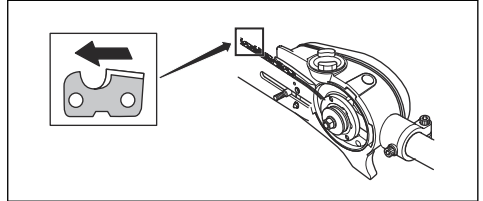

4. Fit the cover and locate the chain adjuster pin (A) in the hole in the bar. Check that the drive links of the chain fit correctly on the drive sprocket (B) and that the chain is in the groove in the bar (C). Tighten the bar nut finger-tight.

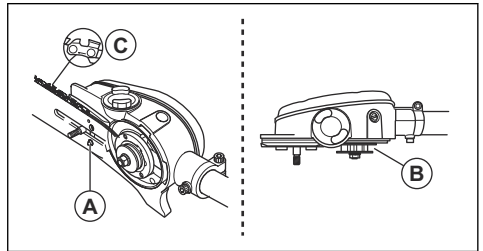

5. Tension the chain by turning the chain tensioning screw clockwise using the combination spanner. The chain should be tensioned until it does not sag from the underside of the bar.

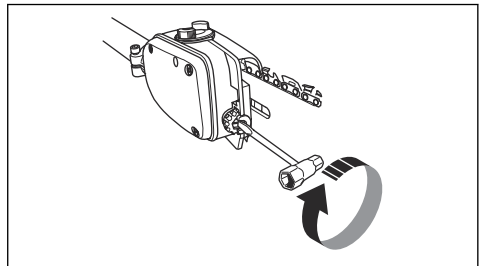

- The chain is correctly tensioned when it does not sag from the underside of the bar, but can still be turned easily by hand. Hold up the bar tip and tighten the bar nuts with the combination spanner.

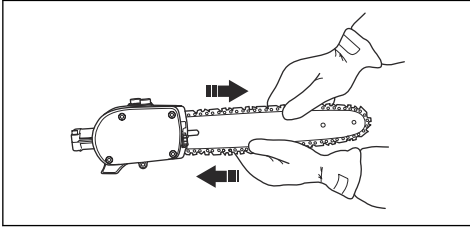

- When fitting a new chain, the chain tension has to be checked frequently until the chain is run-in. Check the chain tension regularly. A correctly tensioned chain ensures good cutting performance and long life.

To adjust the backplate height

- Loosen the 2 fasteners that hold the backplate.

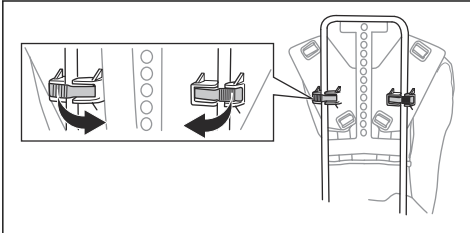

- Loosen the backplate from the frame on 1 side.

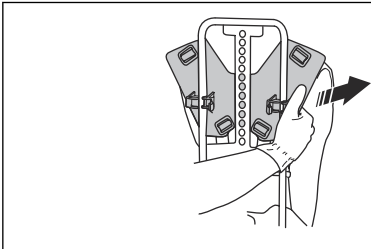

- Adjust the backplate to the correct height. Make sure that the pin aligns with 1 of the holes on the frame.

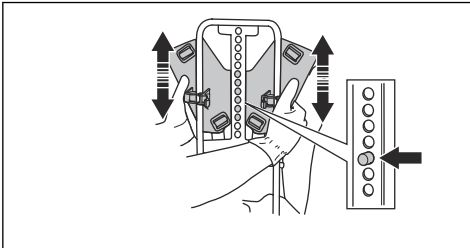

To adjust the harness

- Put on the harness of the product.
- Tighten the hip strap tightly. Make sure that the hip strap aligns with the hip.

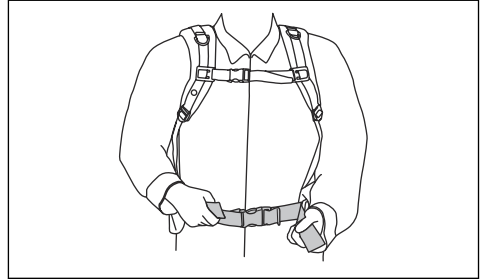

- Tighten the chest strap.

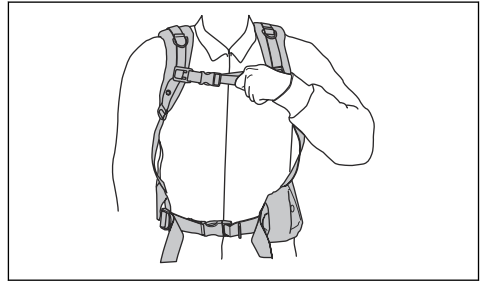

- Adjust the chest strap vertically. Make sure that the chest strap is tight against your body.

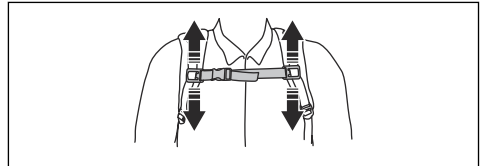

- Adjust the shoulder strap until the weight is equal on your shoulders.

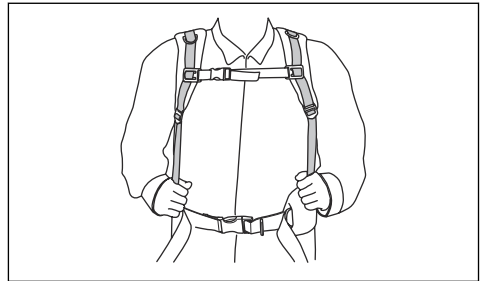

To set the work height

1. Pull out the cord to the necessary work length and make a knot.

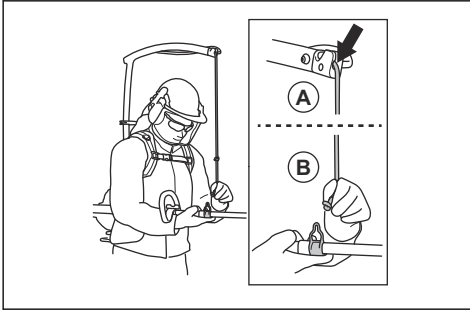

2. Install the knot to the suspension ring on the shaft.
3. To make the cord shorter, pull the cord up by the top part of the load reducer. The load reducer automatically winds the cord when the tension decreases.

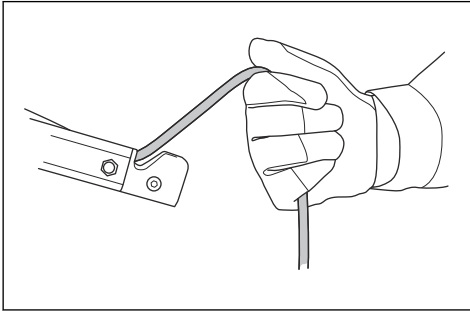

To set the product in transport position

1. Loosen the knob and remove the top part of the load reducer.

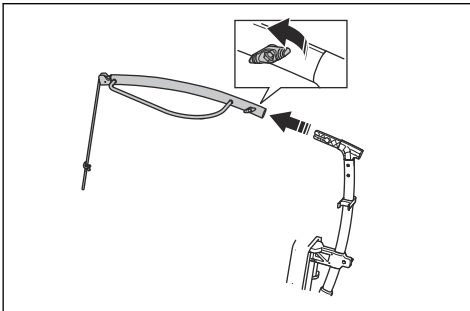

2. Attach the top part (B) of the load reducer to the bottom part (A) of the load reducer.

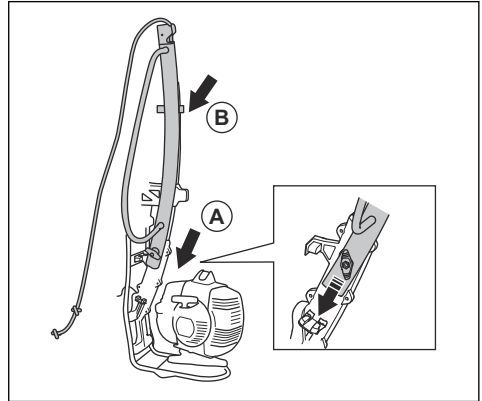

3. Turn the knob 3 turns or more to loosen the coupling on the shaft.

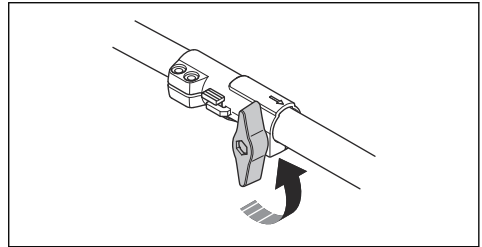

4. Push and hold the button (C).

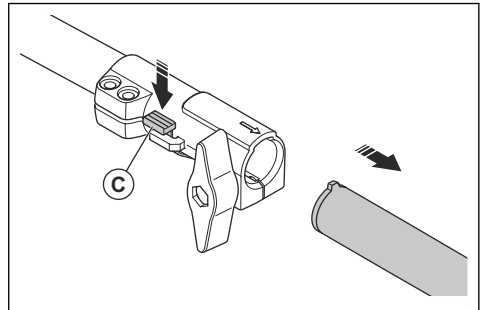

5. Hold tight in the end of the shaft that the engine is attached to.
6. Pull the attachment straight out of the coupling.

7. Install the shaft to the knob on the frame.

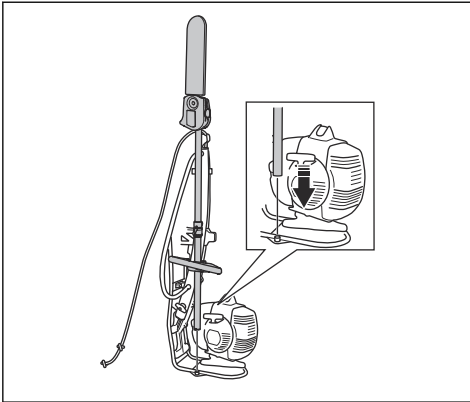

9. Hang the throttle hand guard on the frame.

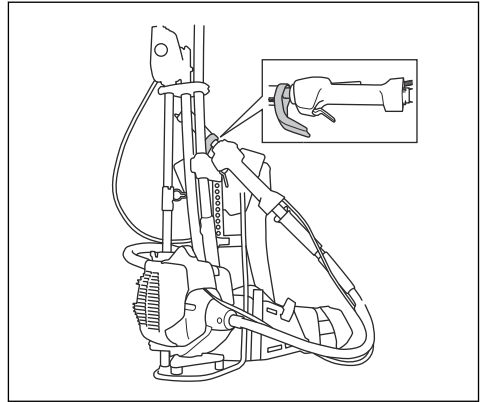

8. Wind the cord around the load reducer and the shaft. Attach the cord to the shaft.

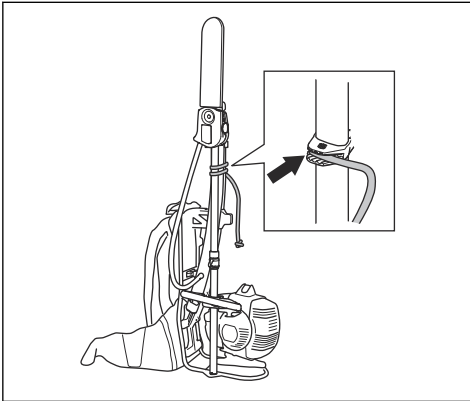

Operation 535FBX

Introduction



WARNING: Before you operate the product, you must read and understand the safety chapter.

To check before starting

1. Inspect the working area. Remove any objects that could be thrown out.
2. Check the saw chain. Never use blunt, cracked or damaged equipment.
3. Check that the product is in perfect working order.
4. Check that all nuts and screws are tight.
5. Make sure the chain is adequately lubricated, refer to *To check the chain lubrication on page 28.*

6. Check that the saw chain always stops when the engine is idling.
7. Only use the product for the purpose it was intended for.
8. Make sure the handle and safety features are in order. Never use a machine that has any parts missing or has been modified in relation to the specification.

Fuel

This product has a two-stroke engine.



CAUTION: Incorrect type of fuel can result in engine damage. Use a mixture of gasoline and two-stroke oil.

Premixed fuel

- Use Husqvarna premixed alkylate fuel of a good quality, for best performance and extension of the engine life. This fuel contains less harmful chemicals compared to regular fuel, which decreases harmful exhaust fumes. The quantity of remains after combustion is lower with this fuel, which keeps the components of the engine more clean.

To mix fuel

Gasoline



CAUTION: Do not use gasoline with an octane number less than 90 RON (87 AKI). This can cause damage to the product.



CAUTION: Do not use gasoline with more than 10% ethanol concentration (E10). This can cause damage to the product.

- Always use new unleaded gasoline with a minimum octane number of 90 RON (87 AKI) and with less than 10% ethanol concentration (E10).
- Use gasoline with a higher octane number if you frequently use the product at continuously high engine speed.

Two-stroke oil

- For best results and performance use Husqvarna two-stroke oil.
- If Husqvarna two-stroke oil is not available, use a two-stroke oil of good quality for air-cooled engines. Speak to your servicing dealer to select the correct oil.



CAUTION: Do not use two-stroke oil for water-cooled outboard engines, also referred to as outboard oil. Do not use oil for four-stroke engines.

To mix gasoline and two-stroke oil

Gasoline, liter	Two-stroke oil, liter
	2% (50:1)
5	0.10
10	0.20
15	0.30
20	0.40



CAUTION: Small errors can influence the ratio of the mixture drastically when you mix small quantities of fuel. Measure the quantity

of oil carefully and make sure that you get the correct mixture.

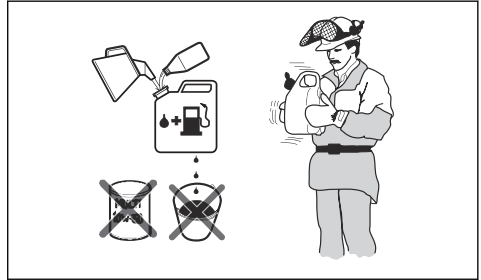

1. Fill half the quantity of gasoline in a clean container for fuel.
2. Add the full quantity of oil.
3. Shake the fuel mixture.
4. Add the remaining quantity of gasoline to the container.
5. Carefully shake the fuel mixture.



CAUTION: Do not mix fuel for more than 1 month at a time.

To fill the fuel tank

1. Clean the area around the fuel tank cap.
2. Shake the container and make sure that the fuel is fully mixed. Use a fuel container with an anti-spill valve.
3. Fill the fuel tank.
4. Tighten the fuel tank cap carefully.
5. Move the product 3 m (10 ft) or more away from the refueling area and fuel source before starting.

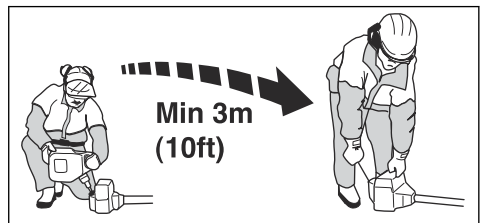

CAUTION: Contamination in the tanks causes malfunction. Clean the fuel tank and chain oil tank regularly and replace the fuel filter one time a year or more.

To use the correct chain oil



WARNING: Do not use waste oil, which can cause injury to you and the environment. Waste oil also causes damage to the oil pump, the guide bar and the saw chain.



WARNING: The saw chain can break if the lubrication of the cutting equipment is not sufficient. Risk of serious injury or death to the operator.



WARNING: This product has a function that lets the fuel run out before the chain oil. Use the correct chain oil for this safety function to operate correctly. Speak to your servicing dealer when you select your chain oil.

Note: This product has an automatic chain lubrication system. You can also adjust the oil flow. Refer to *To check the chain lubrication on page 28*.

- Use Husqvarna chain oil for maximum saw chain life and to minimise environmental damage. If Husqvarna chain oil is not available, we recommend you to use a standard chain oil.
- Use a chain oil with good adherence to the saw chain.
- Use a chain oil with correct viscosity range that agrees with the air temperature.



CAUTION: If the oil is too thin, it runs out before the fuel. In temperatures below 0°C/32°F some chain oils become too thick, which can cause damage to the oil pump components.

- Use the recommended cutting equipment. Refer to *Recommended cutting equipment on page 31*.

To use the product

- Hold the product as close to your body as possible to get the best balance. Use the harness to support the weight of the machine and make it easier to handle.
- Make sure that the tip does not touch the ground.
- Do not rush the work, but work steadily until all the branches have been cut back cleanly.
- Always slow the engine to idle speed after each working operation. Long periods at full throttle without any load on the engine can lead to serious engine damage.
- Always work at full throttle.

- Whenever possible position yourself so that you can make the cut at right angles to the branch.

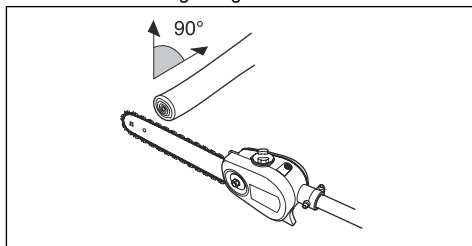

- Do not work with the shaft held straight out in front of you as this increases the apparent weight of the cutting attachment.

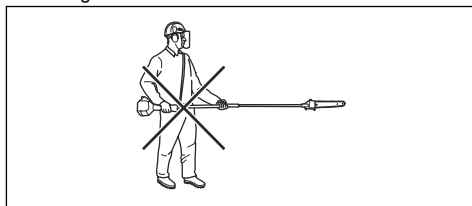

- Cut large branches in sections so that you have better control over where they fall.

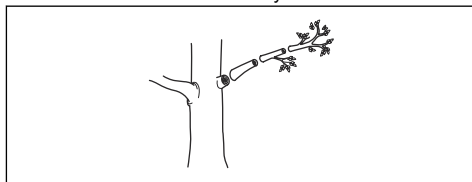

- Never cut through the swelling at the root of the branch as this will slow down healing and increase the risk of fungal attack.

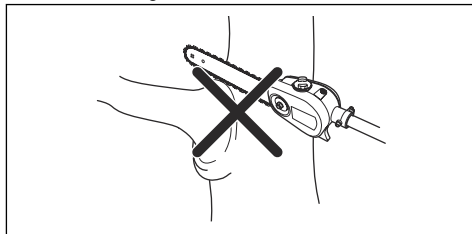

- Use the stop at the base of the cutting head to provide support during cutting. This will help prevent the cutting attachment from bouncing on the branch.

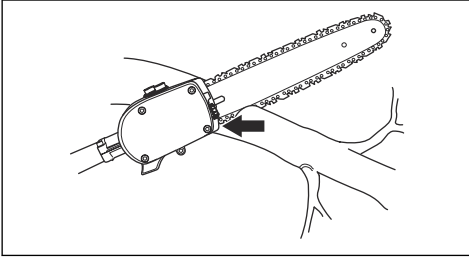

- Make an initial cut on the underside of the branch before cutting through the branch. This will prevent tearing of the bark, which could lead to slow healing and cause permanent damage to the tree. The cut should not be deeper than $\frac{1}{2}$ of the branch thickness to prevent jamming. Keep the chain running while you withdraw the cutting attachment from the branch to prevent it jamming.

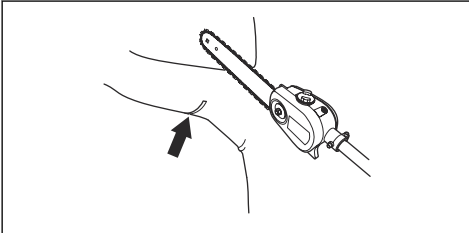

To prepare the product for start

1. Push the air purge bulb again and again until the fuel starts to fill the air purge bulb.

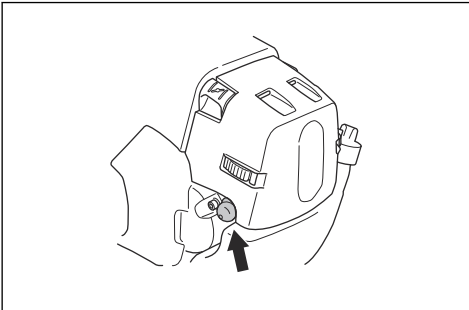

Note: It is not necessary to fully fill the air purge bulb.

2. Move the choke control up into choke position.

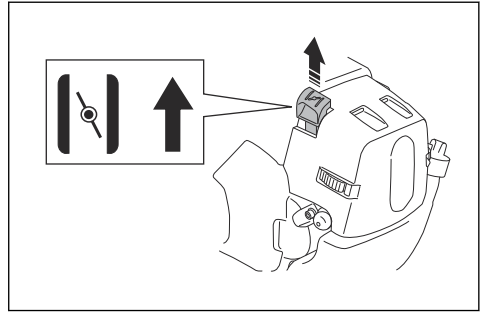

WARNING: Be careful, risk of cut injuries. The saw chain starts to rotate immediately when you start the engine with the choke.

To start the product



WARNING: Read the warning instructions in the safety chapter before you start the product (refer to *Safety 535FBX on page 5*).

1. Use protective gloves.
2. Hold the body of the product on the ground with your left hand.



CAUTION: Do not use your feet!

3. Hold the starter rope handle.
4. Slowly pull out the starter rope with your right hand until you feel some resistance (the starter pawl grip).



WARNING: Do not twist the starter rope around your hand.

5. Pull the cord quickly and with power.



CAUTION: Do not pull the starter rope all the way out and do not let go off the starter rope handle when the starter rope is fully extended. This can cause damage to the product.

6. Pull the starter rope again and again until the engine starts.
7. Reset the choke when the engine fires.
8. Operate the throttle gradually when the engine starts.
9. Make sure the engine runs smoothly.

To stop the product

1. Move the stop switch into the stop position to stop the engine.

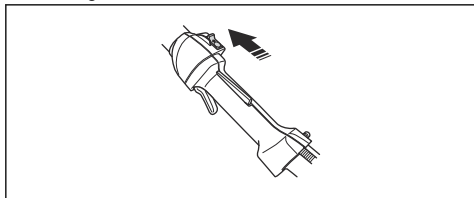

CAUTION: The stop switch automatically goes back to its initial position. In order to prevent accidental starting, the spark plug cap must be removed from the spark plug when assembling, checking and/or maintenance is done.

- Clear an open space at one end of the work area, and start the work from there.
- Move in a regular pattern across the work area.
- Move the product fully to the left and right, to clear a width of 4–5 m on each turn.
- Clear a length of 75 m before you turn and go back. Move the fuel can along with you as you continue.
- Move in a direction where you do not go across ditches and obstacles more than necessary.
- Move in a direction where the wind makes the cut vegetation fall in the cleared area.
- Move along slopes, not up and down.

Forestry clearing

General work instructions



WARNING: Be careful when you cut a tree that is in tension. The tree can move quickly before or after you cut it. Keep a correct position and operating procedure to prevent serious injury.

Maintenance 535RBX

Introduction

Below you will find some general maintenance instructions. If you need further information please contact your service workshop.

Note: The user must only carry out the maintenance and service work described in this operator's manual. More extensive work must be carried out by an authorized service workshop.

Maintenance schedule

The following is a list of the maintenance steps that must be performed on the product. Most of the items are described later in this chapter.

Maintenance	Daily	Weekly	Monthly
Clean the external surface.	X		
Make sure that the throttle trigger lock and the throttle works correctly.	X		
Do a check of the stop switch to make sure that it works correctly.	X		
Make sure that the saw chain does not rotate at idle speed.	X		
Clean the air filter. Replace if necessary.	X		
Check the saw chain with regard to visible cracks in the rivets and links, whether the saw chain is stiff or whether the rivets and links are abnormally worn.	X		
Clean the area under the protective cover.	X		
Make sure that the screws and nuts are tight.	X		

Maintenance	Daily	Weekly	Monthly
Examine the engine, the fuel tank and the fuel lines for leaks.	X		
Clean the cooling system.		X	
Examine the starter and the starter rope for damages.		X	
Examine the vibration damping elements for damages and cracks.		X	
Clean the outside of the spark plug. Remove it and do a check of the electrode gap. Adjust the gap to the correct distance (refer to <i>To examine the spark plug on page 22</i>) or replace the spark plug. Make sure that the spark plug is fitted with a suppressor.		X	
Clean the outside of the carburettor and the space around it.		X	
File off any burrs from the edges of the bar.		X	
Clean or replace the spark arrestor mesh on the muffler.		X	
Clean the fuel tank.			X
Do a check of the fuel filter for contamination and the fuel hose for cracks or other defects. Replace if necessary.			X
Do a check of all cables and connections.			X
Do a check of the clutch, clutch springs and the clutch drum for wear. Replace if necessary by an authorized service workshop.			X
Replace the spark plug. Make sure that the spark plug is fitted with a suppressor.			X

To adjust the idle speed

1. Make sure that the air filter is clean and the air filter cover is attached before you adjust the idle speed.
2. Start the product. Refer to *Air filter on page 22*
3. Adjust the idle speed with the idle adjustment screw T which is identified with "T" mark. Turn the idle adjustment screw clockwise until the saw chain starts to turn.

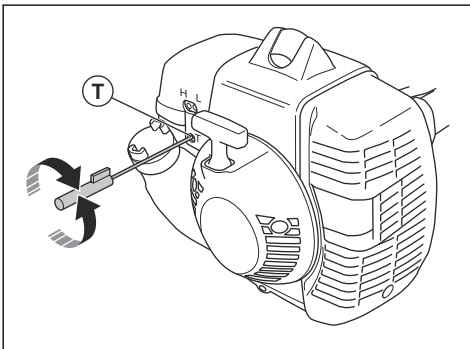

4. Turn the idle adjustment screw counterclockwise until the saw chain stops.

The idle speed is correct when the engine operates smoothly in all positions. The idle speed must be below the speed when the saw chain starts to turn.



WARNING: If the saw chain does not stop when you adjust the idle speed, turn to your nearest servicing dealer. Do not use the product until it is correctly adjusted or repaired.

Note: Refer to *Technical data 535FBX on page 29* for the recommended idle speed.

To adjust the throttle wire

Note: The throttle wire must be adjusted after 100 hours of operation or if the engine does not operate correctly.

1. Make sure that the idle speed is correctly adjusted, refer to *To adjust the idle speed on page 20*.
2. Stop the engine.
3. Remove the cylinder cover.
4. Push and hold the throttle trigger fully.

5. Push the throttle cam with your finger.

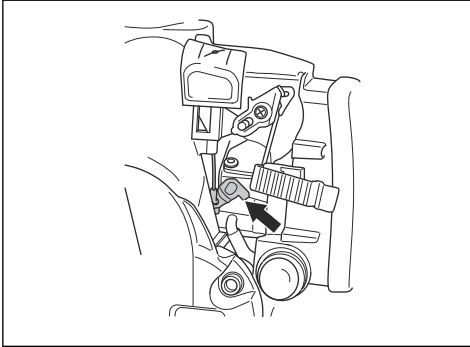

6. If the throttle cam moves, adjust the throttle wire.
a) Turn the adjustment screw clockwise.

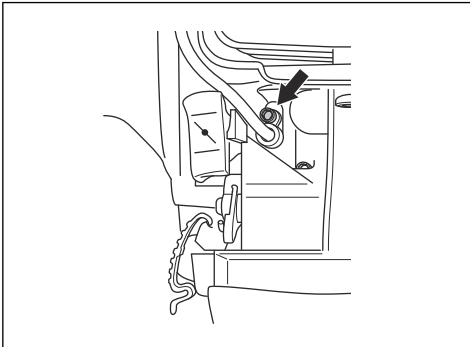

- b) Push the throttle cam with your finger. If the throttle cam does not move, the throttle wire is correctly adjusted.
7. Install the cylinder cover and do a check of the idle speed.

To do a check of the muffler



WARNING: Do not use a product that has a defective muffler or a muffler that is in bad condition.



WARNING: Do not use the product if the spark arrester screen on the muffler is missing or defective.

1. Examine the muffler for damages and defects.

2. Make sure that the muffler is correctly attached to the product.

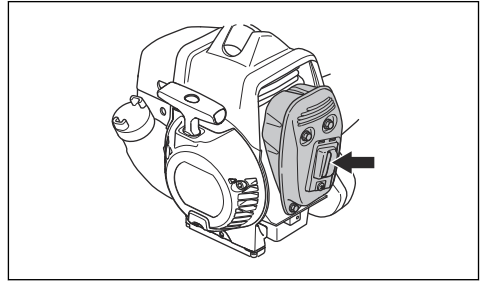

3. If your product has a special spark arrester screen, clean the spark arrester screen weekly.
4. Replace a damaged spark arrester screen.

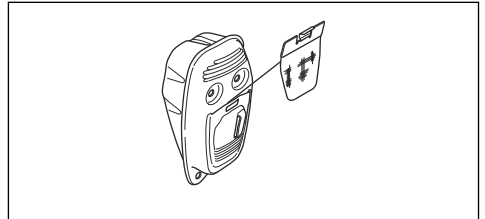

CAUTION: If the spark arrester screen is blocked, the product becomes too hot and this causes damage to the cylinder and piston.

Cooling system

The product has a cooling system to keep the operation temperature as low as possible.

Clean the components of the cooling system with a brush weekly or more frequently in rougher conditions. A dirty or blocked cooling system makes the product too hot which causes damage to the piston and cylinder.

The cooling system has the following components:

1. Air intake on the starter.
2. Cooling fins on the cylinder.
3. Cylinder cover.

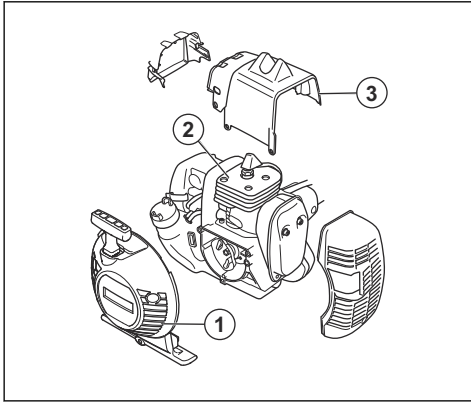

To examine the spark plug



CAUTION: Always use the recommended spark plug type. Incorrect spark plug type can cause damage to the product.

- Examine the spark plug if the engine is low on power, is not easy to start or does not operate correctly at idle speed.
- To decrease the risk of unwanted material on the spark plug electrodes, obey these instructions:
 - a) Make sure that the idle speed is correctly adjusted.
 - b) Make sure that the fuel mixture is correct.
 - c) Make sure that the air filter is clean.
- If the spark plug is dirty, clean it and make sure that the electrode gap is correct, refer to *Technical data 535FBX on page 29*.

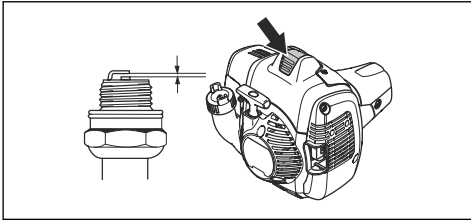

- Replace the spark plug if it is necessary.

To lubricate the drive shaft

1. Pull up the knob and remove the drive shaft sleeve from the clutch cover.

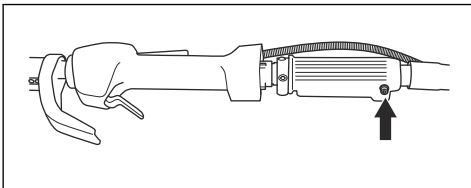

- a) Shake or pull the drive shaft out of the drive shaft sleeve.

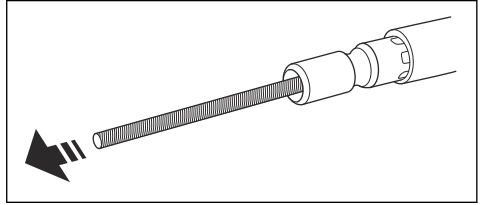

2. Lubricate the drive shaft.

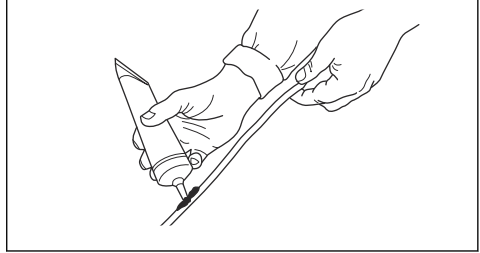

3. Push and turn the drive shaft at the same time to put it back in the drive shaft sleeve. Keep approximately 10 mm / 0.40 in. of the drive shaft outside the edge of the drive shaft sleeve.

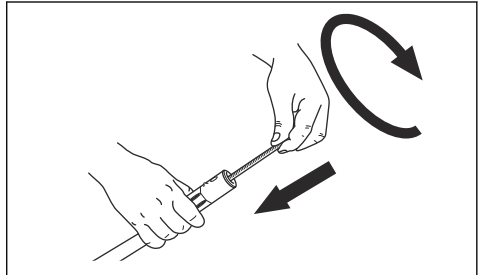

4. Align the hole in the drive shaft sleeve with the knob on the clutch cover.

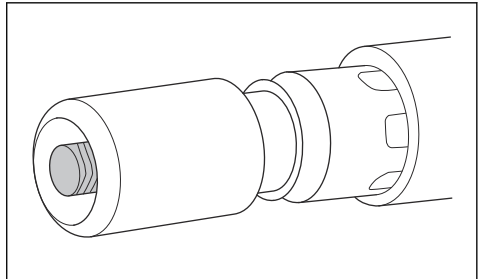

5. Push and turn the drive shaft at the same time to connect it.

Air filter

Remove dust and dirt from the air filter to keep it clean in order to prevent:

- Carburettor malfunctions.
- Starting problems.
- Loss of engine power.
- Unnecessary wear to engine parts.
- Too much fuel consumption.

Clean the air filter at an interval of 25 hours, or more regularly if conditions are unusually dusty.

To clean the air filter



CAUTION: An air filter that is damaged, very dirty or soaked with fuel must always be replaced.

If you use an air filter for a long time, it cannot be fully cleaned. Replace the air filter with a new one at regular intervals.

1. Move the choke lever up, to close the choke valve.
2. Remove the air filter cover and remove the air filter.

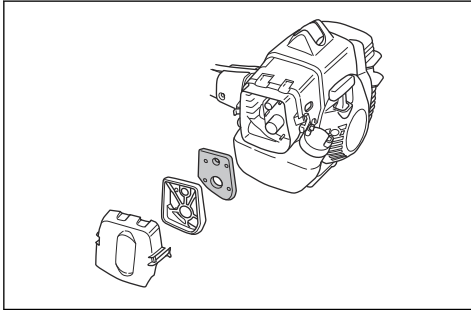

3. Clean the air filter with warm soap water.
4. Replace the air filter if it is too dirty to fully clean it. Always replace a damaged air filter.
5. Also clean the inner surface of the filter cover. Use air or a brush.
6. Do a check of the rubber sealing surface. Replace the filter on the rubber seal if it is damaged.
7. Make sure that the filter is dry before you assemble it.

Two piece-shaft

Apply grease to the end of the drive shaft after each 30 hours of operation. There is a risk that the drive shaft ends (splined coupling) on models with two-piece shafts will seize if they are not lubricated regularly.

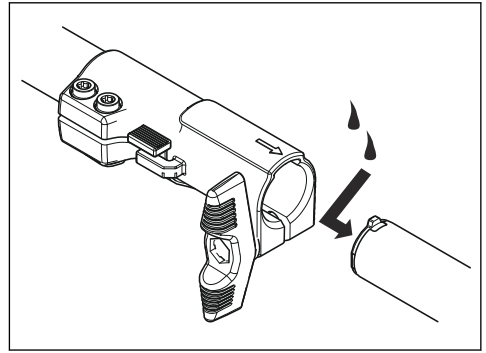

To do a check of the spur sprocket

The clutch drum has a spur sprocket that is welded on the clutch drum.

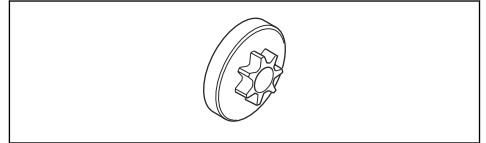

- Regularly do a visual check of the degree of wear on the spur sprocket. Replace the clutch drum with the spur sprocket if there is too much wear.

To examine the cutting equipment

1. Make sure that there are no cracks in rivets and links and that no rivets are loose. Replace if it is necessary.

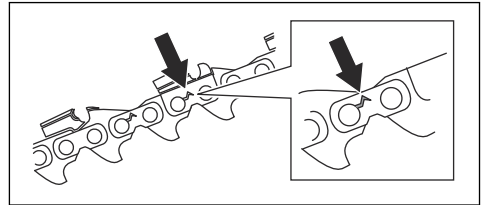

2. Make sure that the saw chain is easy to bend. Replace the saw chain if it is rigid.
3. Compare the saw chain with a new saw chain to examine if the rivets and links are worn.
4. Replace the saw chain when the longest part of the cutting tooth is less than 4 mm/0.16 in. Also replace the saw chain if there are cracks on the cutters.

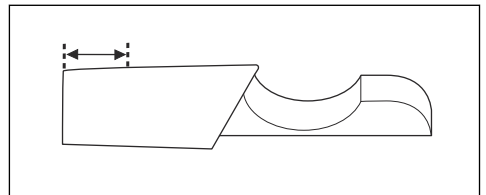

To do a check of the guide bar

1. Make sure that the oil channel is not blocked. Clean if it is necessary.

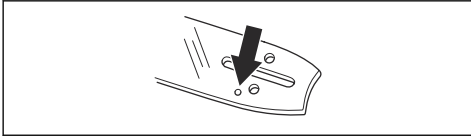

2. Examine if there are burrs on the edges of the guide bar. Remove the burrs using a file.

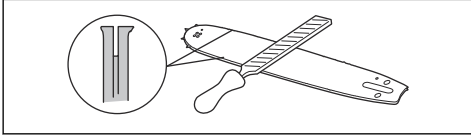

3. Clean the groove in the guide bar.

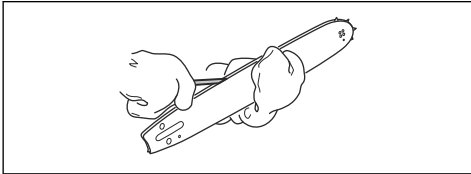

4. Examine the groove in the guide bar for wear. Replace the guide bar if it is necessary.

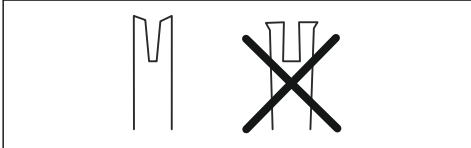

5. Examine if the guide bar tip is rough or very worn.

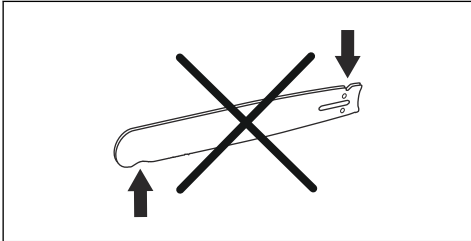

6. Make sure that the bar tip sprocket turns freely and that the lubricating hole in the bar tip sprocket is not blocked. Clean and lubricate if it is necessary.



7. Turn the guide bar daily to extend its life cycle.

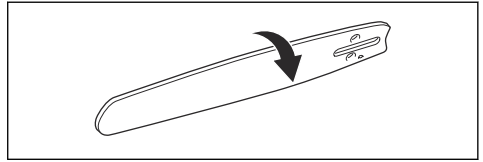

To sharpen the saw chain

Information about the guide bar and saw chain



WARNING: Use protective gloves when you use or do maintenance on the saw chain. A saw chain that does not move can also cause injuries.

Replace a worn or damaged guide bar or saw chain with the guide bar and saw chain combination recommended by Husqvarna. This is necessary to keep the safety functions of the product. Refer to *Accessories on page 38*, for a list of replacement bar and chain combinations that we recommend.

- Guide bar length, in/cm. Information about the guide bar length can usually be found on the rear end of the guide bar.

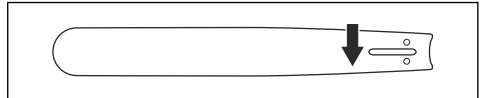

- Number of teeth on bar tip sprocket (T).

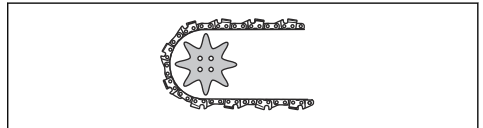

- Chain pitch, in. The distance between the drive links of the saw chain must align with the distance of the teeth on the bar tip sprocket and drive sprocket.

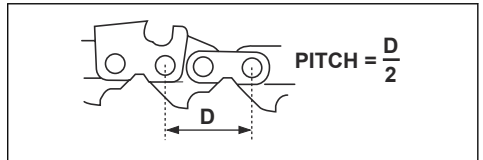

- Number of drive links. The number of drive links is decided by the type of guide bar.

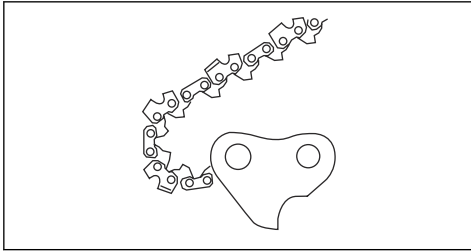

- Bar groove width, in/mm. The groove width in guide bar must be the same as the chain drive links width.

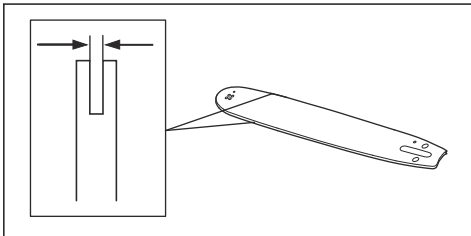

- Chain oil hole and hole for chain tensioner. The guide bar must align with product.

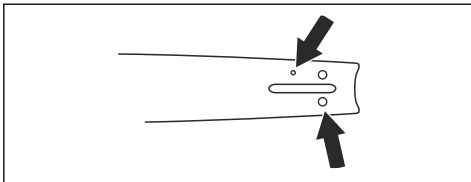

- Drive link width, mm/in.

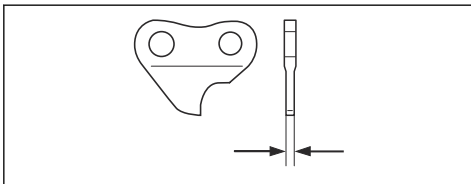

General information about how to sharpen the cutters

Do not use a blunt saw chain. If the saw chain is blunt, you must apply more pressure to push the guide bar through the wood. If the saw chain is very blunt, there will be no wood chips but sawdust.

A sharp saw chain eats through the wood and the wood chips becomes long and thick.

The cutting tooth (A) and the depth gauge (B) together makes the cutting part of the saw chain, the cutter. The

difference in height between the two gives the cutting depth (depth gauge setting).

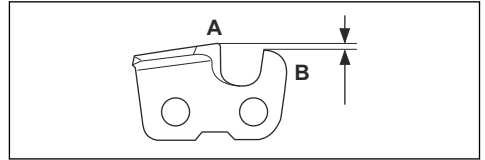

When you sharpen the cutter, think about the following:

- Filing angle.

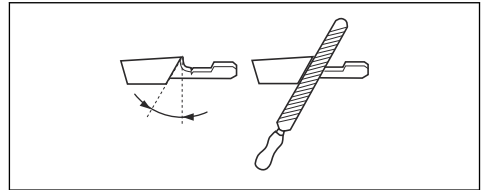

- Cutting angle.

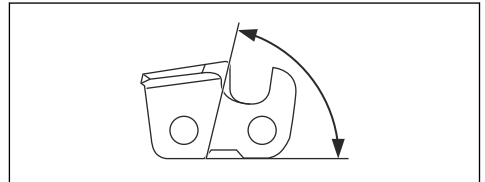

- File position.

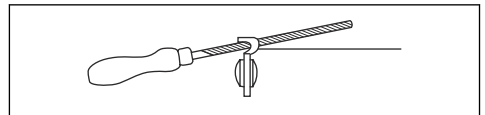

- Round file diameter.

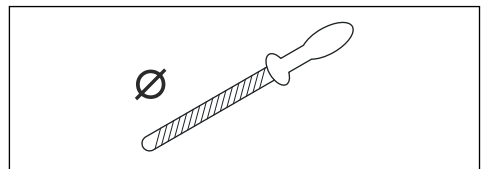

It is not easy to sharpen a saw chain correctly without the correct equipment. Use Husqvarna file gauge. This will help you to keep maximum cutting performance.

Note: Refer to *To sharpen the cutters on page 26* for information about sharpening of the saw chain.

To sharpen the cutters

1. Use a round file and a file gauge to sharpen the cutting teeth.

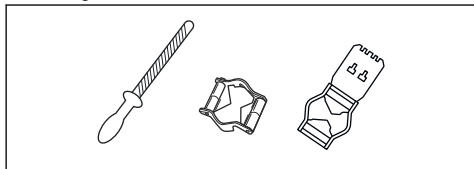

Note: Refer to *Filing equipment and filing angles on page 31* for information about which file and gauge that Husqvarna recommends for your saw chain.

2. Apply the file gauge correctly on to the cutter. Refer to the instruction supplied with the file gauge.
3. Move the file from the inner side of the cutting teeth and out. Decrease the pressure on the pull stroke.

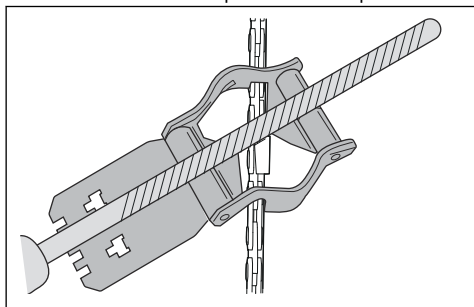

4. Remove material from one side of all the cutting teeth.
5. Turn the product around and remove material on the other side.
6. Make sure that all cutting teeth are the same length.

General information about how to sharpen the cutters

Do not use a blunt saw chain. If the saw chain is blunt, you must apply more pressure to push the guide bar through the wood. If the saw chain is very blunt, there will be no wood chips but sawdust.

A sharp saw chain eats through the wood and the wood chips becomes long and thick.

The cutting tooth (A) and the depth gauge (B) together makes the cutting part of the saw chain, the cutter. The difference in height between the two gives the cutting depth (depth gauge setting).

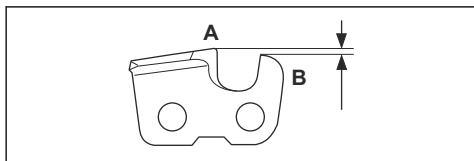

When you sharpen the cutter, think about the following:

- Filing angle.

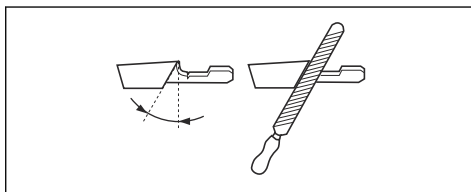

- Cutting angle.

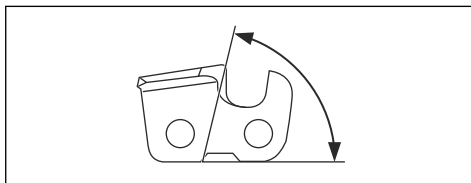

- File position.

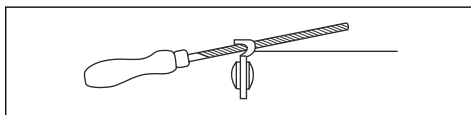

- Round file diameter.

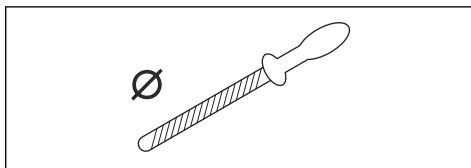

It is not easy to sharpen a saw chain correctly without the correct equipment. Use Husqvarna file gauge. This will help you to keep maximum cutting performance and the kickback risk at a minimum.



WARNING: The force of the kickback increases a lot if you do not follow the sharpening instructions.

Note: Refer to *To sharpen the saw chain on page 24* for information about sharpening of the saw chain.

To adjust the depth gauge setting

Before you adjust the depth gauge setting or sharpen the cutters, refer to *General information about how to sharpen the cutters on page 25*, for instructions. We

recommend you to adjust the depth gauge setting after each third operation that you sharpen the cutting teeth.

We recommend that you use our depth gauge tool to receive the correct depth gauge setting and bevel for the depth gauge.

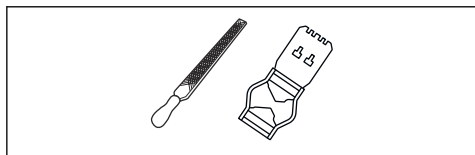

1. Use a flat file and a depth gauge tool to adjust the depth gauge setting. Only use Husqvarna depth gauge tool to get the correct depth gauge setting and bevel for the depth gauge.
2. Put the depth gauge tool on the saw chain.

Note: See the package of the depth gauge tool for more information about how to use the tool.

3. Use the flat file to remove the part of the depth gauge that extends through the depth gauge tool.

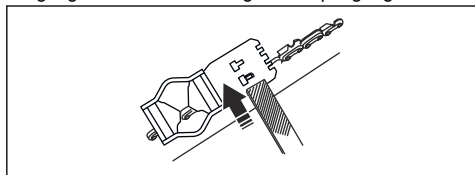

To tension the chain



WARNING: A saw chain with an incorrect tension can derail from the guide bar and cause serious injury or death.

A saw chain becomes longer when you use it. Adjust the saw chain regularly.

1. Loosen the bar nut that hold the clutch cover/chain brake. Use a wrench.

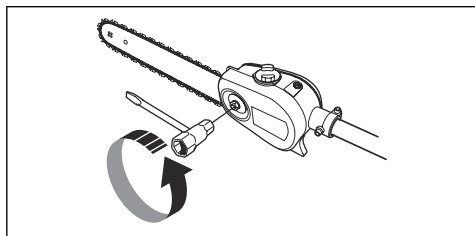

2. Tighten the bar nuts by hand as tightly as you can.

3. Lift the front of the guide bar and turn the chain tensioning screw. Use a wrench.

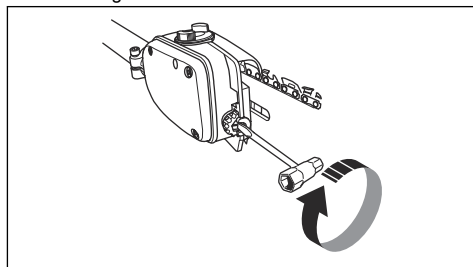

4. Tighten the saw chain until it is tight against the guide bar but still can move easily.
5. Tighten the bar nuts using the wrench and lift the front of the guide bar at the same time.

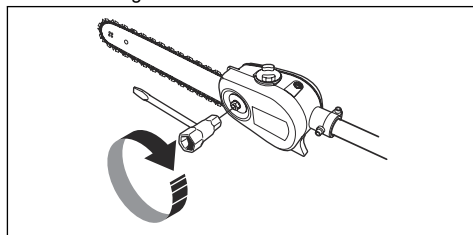

6. Make sure you can pull the saw chain around freely by hand and that it does not hang from the guide bar.

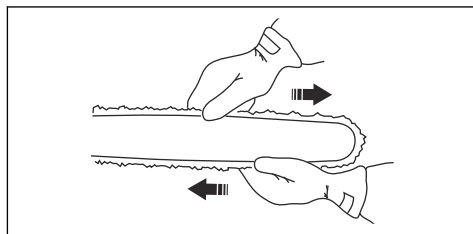

To fill with chain oil

1. Open the oil cap on top of the bar head.

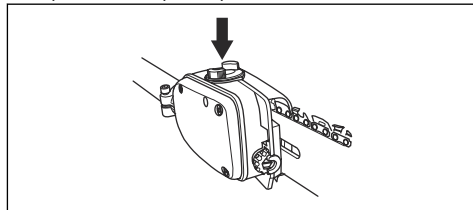

2. Fill with Husqvarna saw chain oil.
3. Attach the cap again.

To check the chain lubrication

1. Check the chain lubrication each time you refuel. Aim the tip of the bar at a light coloured surface about 20 cm (8 inches) away. After 1 minute running at 75 % throttle you should see a distinct line of oil on the light surface.

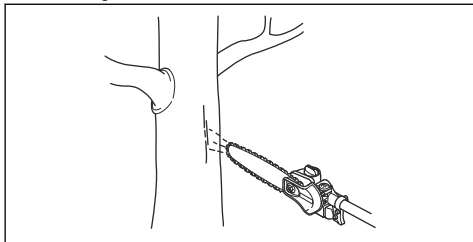

2. If the saw chain lubrication does not operate correctly, do a check of the guide bar. Refer to *To do a check of the guide bar on page 24* for instructions. Speak to your servicing dealer if the maintenance steps does not help.

To adjust chain lubrication



WARNING: Stop the engine before you make adjustments to the oil pump.

Turn the adjustment screw for the oil pump. Use a screwdriver or combination wrench.

- Turn the adjuster screw clockwise to increase the oil flow.

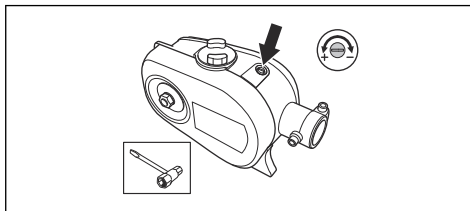

- Turn the adjuster screw counterclockwise to decrease the oil flow.

Troubleshooting

The engine does not start

Check	Possible cause	Procedure
Stop switch.	The stop switch is in the stop position.	Let an approved service agent replace the stop switch.
Fuel tank.	Incorrect fuel type.	Drain the fuel tank and fill with correct fuel.
Spark plug and cylinder.	The spark plug is dirty or wet.	Make sure that the spark plug is dry and clean.
	The spark plug electrode gap is incorrect.	Clean the spark plug. Make sure that the electrode gap is correct, refer to <i>Technical data 535FBX on page 29</i> . Make sure that the spark plug has a suppressor.
	The spark plug is loose.	Tighten the spark plug.
	Engine is flooded because of repeated starts with full choke after ignition.	Remove and clean the spark plug. Put the product on its side with the spark plug hole away from you. Pull the starter rope handle 6-8 times. Assemble the spark plug and start the product. Refer to <i>To start the product on page 18</i> .

The engine starts but stops again

Check	Possible cause	Procedure
Fuel tank	Incorrect fuel type.	Empty the fuel tank and fill it with correct fuel.
Air filter	The air filter is clogged.	Clean the air filter.

Transportation and storage

Transportation and storage

- For storage and transportation of the product and fuel, make sure that there are no leaks or fumes. Sparks or open flames, for example from electrical devices or boilers, can start a fire.
- Always use approved containers for storage and transportation of fuel.
- Empty the fuel and chain oil tanks before transportation or before long-term storage. Discard the fuel and chain oil at an applicable disposal location.
- Use the transportation guard on the product to prevent injuries or damage to the product. A saw chain that does not move can also cause serious injuries.
- Remove the spark plug cap from the spark plug.

- Attach the product safely during transportation.

To prepare your product for long-term storage

- Disassemble and clean the saw chain and the groove in the guide bar.



CAUTION: If the saw chain and guide bar are not cleaned, they can become rigid or blocked.

- Attach the transportation guard.
- Clean the product. Refer to *Maintenance 535RBX on page 19* for instructions.
- Do a complete servicing of the product.

Technical data 535FBX

Technical data

Engine	
Cylinder displacement, cm ³	34.6
Cylinder bore, mm	38.0
Stroke, mm	30.5
Recommended max. speed, rpm	11700
Idle speed, rpm	2900
Max. engine output, according to ISO 8893, kW/rpm	1.6/8400
Catalytic converter muffler	Yes
Speed-regulated ignition system	Yes
Ignition system	
Spark plug	Champion RCJ 6Y
Electrode gap, mm	0.5
Fuel and lubrication system	

Fuel tank capacity, litre/cm ³	0.6/600
Oil tank capacity, litre/cm ³	0.26/260
Weight	
Without fuel, cutting attachment, kg	12.4
Noise emissions ¹	
Sound power level, measured dB (A)	110
Sound power level, guaranteed dB (A)	111
Sound levels ²	
Equivalent sound pressure level at the operator's ear, measured according to ISO 22868, dB(A):	
Equipped with approved accessory (original)	94
Vibration levels ³	
Equivalent vibration levels ($a_{hv,eq}$) at handles, measured according to ISO 22867, m/s ² :	
Equipped with approved accessory (original), front/rear	1.8/1.2

¹ Reported data for the noise output level has a typical dispersion (standard deviation) of 2 dB (A).

² Reported data for equivalent sound pressure level for the product has a typical statistical dispersion (standard deviation) of 1 dB (A).

³ Reported data for equivalent vibration level has a typical statistical dispersion (standard deviation) of 1 m/s².

Accessories

Recommended cutting equipment







Recommended guide bar and saw chain combination.

Guide bar				Saw chain	
Length, in.	Pitch, in.	Gauge, mm	Max. nose radius	Type	Length, drive links, no.
13	0.325	1.3	10T	Husqvarna H30	56
				Husqvarna SP33G	

Filing equipment and filing angles

If you do not know which saw chain you have on your product, turn to your servicing dealer.

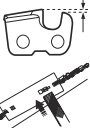
Husqvarna file gauge gives you the correct filing angles. We recommend you to always use a Husqvarna file gauge to restore the sharpness of the saw chain. The part numbers are given in the table below.

						
H30	3/16 in. / 4.8 mm	80°	30°	0.025 in. / 0.65 mm	505 69 81-00	505 69 81-08
SP33G	3/16 in. / 4.8 mm	80°	30°	0.025 in. / 0.65 mm	-	586 93 84-01

EC Declaration of Conformity 535FBX

EC Declaration of Conformity

Husqvarna AB, SE-561 82 Huskvarna, Sweden, tel: +46-36-146500, declares that the pole saws **Husqvarna 535FBX** with serial numbers dating from 2016 onwards (the year is clearly stated on the rating plate, followed by the serial number), comply with the requirements of the COUNCIL'S DIRECTIVE:

- of May 17, 2006 "relating to machinery" **2006/42/EC**
- of February 26, 2014 "relating to electromagnetic compability" **2014/30/EU**
- of June 8, 2011 "on the restriction of the use of certain hazardous substances in electrical and electronic equipment" **2011/65/EU**
- of May 8, 2000 "relating to the noise emissions in the environment" **2000/14/EG**.

The following standards have been applied:

EN ISO 12100:2010, CISPR12:2007, EN ISO 14982:2009, EN ISO 11680-1:2011, EN ISO 11680-2:2011, EN 50581:2012.

RISE SMP Svensk Maskinprovning AB, Box 7035, SE-750 07 Uppsala, Sweden, has carried out EC type examination in accordance with the machinery directive's (2006/42/EC) article 12, point 3b. The certificate for EC type examination in accordance with annex V, has the number: **0404/09/2163**

In addition ,0404, RISE SMP Svenska Maskinprovning AB, Box 7035, SE-750 07 Uppsala, Sweden, has certified conformity with annex V of the Council's Directive of May 8, 2000 "relating to the noise emissions in the enviroment" 2000/14/EC. The certitudes have the number 01/165/003 - 535FBX.

For information relating to noise emissions, refer to *Technical data 535FBX on page 29.*

The supplied polesaw conforms to the example that underwent EC type examination.

Huskvarna, 2016-03-30



Per Gustafsson, Development Manager (Authorized representative for Husqvarna AB and responsible for technical documentation)

Introduction TA1100

Symbols on the product



WARNING! This product is dangerous. Injury or death can occur to the operator or bystanders if the product is not used carefully and correctly. To prevent injury to the operator or bystanders, read and obey all safety instructions in the operator's manual.



Read the operator's manual carefully and make sure that you understand the instructions before use.



Use a protective helmet in locations where objects can fall on you. Use approved hearing protection. Use approved eye protection.



max rpm Maximum speed of the output shaft.



The product agrees with the applicable EC directives.



The product can cause objects to eject, which can cause injury.



Keep a minimum of 15 m distance to persons and animals during operation of the product.



Use approved protective gloves.



Use heavy-duty slip-resistant boots.



Only use flexible cutting wire. Do not use metal cutting attachments.



Noise emissions to the environment according to European Directive 2000/14/EC and New South Wales legislation "Protection of the Environment Operations (Noise Control) Regulation 2017". Noise emission data can be found on the machine label and in the Technical data chapter.

Note: Other symbols/decals on the product refer to certification requirements for other commercial areas.

Product overview TA1100

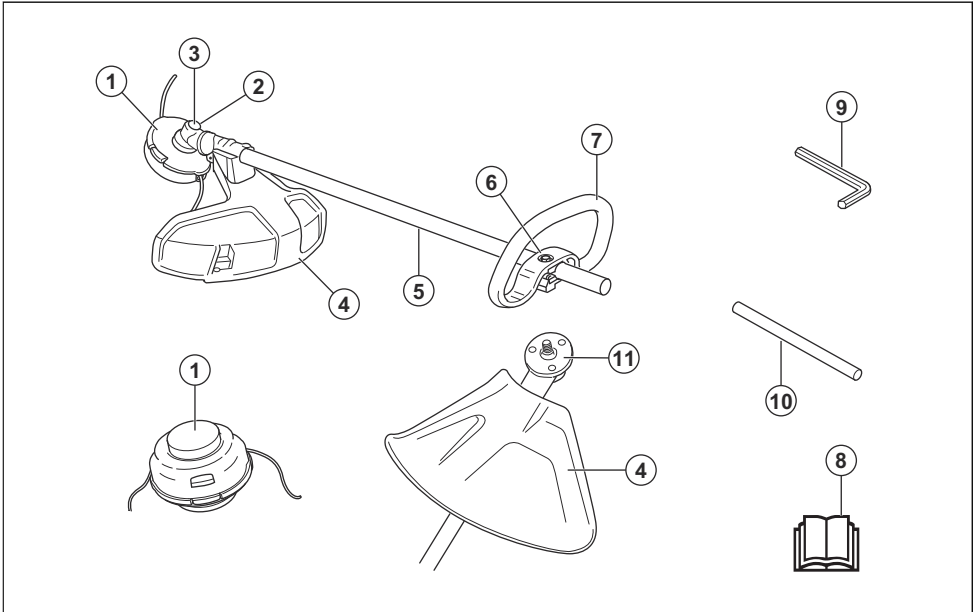

- | | |
|----------------------------------|----------------------|
| 1. Trimmer head | 7. Loop handle |
| 2. Grease filler cap, bevel gear | 8. Operator's manual |
| 3. Bevel gear | 9. Hex key |
| 4. Cutting attachment guard | 10. Locking pin |
| 5. Shaft | 11. Drive disc |
| 6. Handle adjustment | |

Safety TA1100

Safety instructions for operation



WARNING: Read the warning instructions that follow before you use the product.

- You must understand the difference between grass clearing and grass trimming before use.
- If you encounter a situation where you are uncertain how to proceed you should ask an expert. Contact your dealer or your service workshop. Avoid all usage which you consider to be beyond your capability.
- Never use a product that is faulty. Carry out the safety checks, maintenance and service instructions described in this manual. Some maintenance and service measures must be carried out by trained and qualified specialists. Refer to *Maintenance schedule on page 19*.
- All covers, guards and handles must be fitted before you start the product. Ensure that the spark plug cap and ignition lead are undamaged to avoid the risk of electric shock.
- Never use the product if you are fatigued, while under the influence of alcohol or drugs, medication or anything that could affect your vision, alertness, coordination or judgement.
- Do not use the product in bad weather such as dense fog, heavy rain, strong wind, intense cold, etcetera. Working in bad weather is tiring and often brings added risks, such as icy ground, unpredictable felling direction, etcetera.
- The only accessories you can operate with this engine unit are the cutting attachments that we recommend. Refer to *Approved accessories on page 38*.
- Never allow children to use or be in the vicinity of the product. As the product is equipped with a spring-loaded start/stop switch and can be started by low

speed and force on the starter handle, even small children under some circumstances can produce the force necessary to start the product. This can mean a risk of serious personal injury. Therefore remove the spark plug cap when the product is not under close supervision.

- Running an engine in a confined or badly ventilated area can result in death due to asphyxiation or carbon monoxide poisoning.
- The complete clutch cover and shaft must be fitted before the product is started, otherwise the clutch can come loose and cause personal injury.
- Ensure that no people or animals come closer than 15 m while you work. When several operators are working in the same area the safety distance should be at least 15 m. Otherwise there is a risk of serious personal injury. Stop the product immediately if anyone approaches. Never swing the product around without first checking behind you to make sure that no one is within the safety zone.
- Ensure that people, animals or other things can not affect your control of the product or that they do not come in contact with the cutting attachment or loose objects that are thrown out by the cutting attachment. However, do not touch the product unless you are able to call for help in the event of an accident.
- Always inspect the working area. Remove all loose objects such as stones, broken glass, nails, steel wire, string, etcetera, that could be thrown out or become wrapped around the cutting attachment.
- Make sure that you can move and stand safely. Check the area around you for possible obstacles (roots, rocks, branches, ditches, etcetera) in case you have to move suddenly. Take great care when you work on sloping ground.

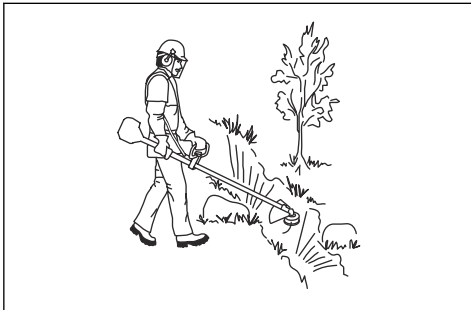

- Keep a good balance and a firm foothold at all times. Do not overreach.
- Always hold the product with both hands. Hold the product on the right side of your body.
- Keep the cutting attachment below waist level.
- Switch off the engine before you move to another area. Fit the transportation guard before you carry or transport the equipment any distance.
- Never put the product down with the engine running unless you have it in clear sight.

- Stop the engine and cutting equipment before you remove material that has wound around the blade shaft. Neither the operator of the product nor anyone else may attempt to remove the cut material while the engine is running or the cutting equipment is rotating, as this can result in serious injury. The bevel gear can get hot during use and may remain so for a while afterwards. You could get burnt if you touch it.
- Watch out for thrown objects. Always wear approved eye protection. Never lean over the cutting attachment guard. Stones, rubbish, etcetera, can be thrown up into the eyes which can cause blindness or serious injury.
- Sometimes branches or grass get caught between the guard and cutting attachment. Always stop the engine before you clean the product.
- Always slow the engine to idle speed after each working operation. Long periods at full throttle without any load on the engine can lead to serious engine damage.
- Listen out for warning signals or shouts when you wear hearing protection. Always remove your hearing protection as soon as the engine stops.
- Overexposure to vibration can lead to circulatory damage or nerve damage in people who have impaired circulation. Contact your doctor if you experience symptoms of overexposure to vibration. These symptoms include numbness, loss of feeling, tingling, pricking, pain, loss of strength, changes in skin color or condition. These symptoms normally appear in the fingers, hands or wrists.
- Do not use a product with a damaged spark plug cap.
- Do not use a product with a defective muffler.
- Keep all parts of your body away from the rotating cutting attachment and hot surfaces.
- Never use a product with a faulty muffler
- Never start or use the product indoors, near combustible material or in spaces that lack proper ventilation. The exhaust fumes from the engine contain carbon monoxide, an odorless, poisonous and highly dangerous gas. Also, the exhaust fumes are hot and may contain sparks that can start a fire.

Cutting attachment



WARNING: The cutting attachment must not rotate when you do work on it. Make sure that the engine has stopped. Remove the spark plug cap before you do work on the cutting attachment.



WARNING: Make sure that the cutting attachment is not damaged. A damaged cutting attachment can cause accidents. Replace a damaged cutting attachment.



WARNING: Use the correct cutting attachment. Only use the cutting attachment with the guards we recommend, refer to *Approved accessories on page 38*.

Cutting attachment guard

The cutting attachment guard prevents a loose object to eject in the direction of the operator. The guard also prevents the operator from accidentally touching the cutting attachment.

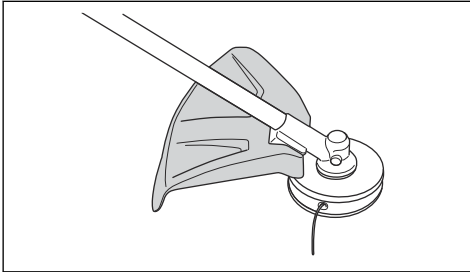

Examine the cutting attachment guard for damage and cracks. Replace if it is damaged or has cracks. Only use the approved guard for the cutting attachment.



WARNING: Do not use a cutting attachment without an approved guard. If an incorrect or defective guard is installed, this can cause damage to persons.

Trimmer head



WARNING: Always make sure the trimmer line is wound tightly and evenly around the drum to prevent harmful vibration.



- Only use recommended trimmer heads and trimmer lines.
- Only use recommended cutting attachments.
- Smaller machines requires small trimmer heads and vice versa.
- The length of the trimmer line is important. A longer trimmer line requires greater engine power than a shorter trimmer line of the same diameter.
- Make sure that the cutter on the trimmer guard is intact. This cuts the trimmer line to the correct length.
- Soak the trimmer line in water for a couple of days before use to increase the life length.

Assembly TA1100

To assemble the loop handle

1. Put the loop handle onto the shaft, between the arrows.

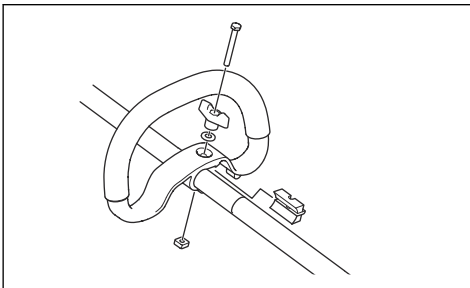

2. Put the spacer into the slot of the loop handle.
3. Install the nut, the knob and the screw. Do not tighten fully.
4. Adjust the product to an applicable operation position.
5. Tighten the knob.

To assemble the cutting attachment guard and trimmer head

1. Attach the correct cutting attachment guard (A) for the trimmer head (See, *Approved accessories on page 38*).
2. Put the cutting attachment guard onto the fitting on the shaft.
3. Secure with the bolt(L).

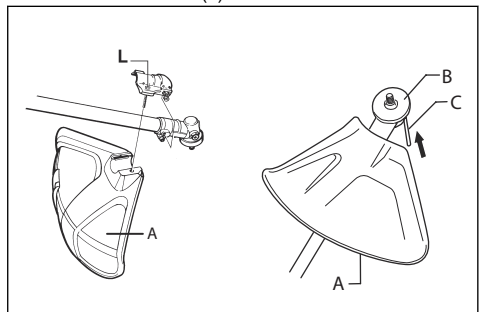

4. Install the drive disc (B) on the output shaft.

- Turn the output shaft until one of the holes in the drive disc aligns with the related hole in the gear housing.



WARNING: Make sure that the higher section of the drive disc installs correctly in the center hole of the cutting attachment. If the cutting attachment is installed incorrectly, it can result in serious injury.

- Put the locking pin (C) in the hole to lock the shaft.

- Turn the trimmer head /plastic blades (H) in the opposite direction from which the trimmer head/ plastic blades rotates.

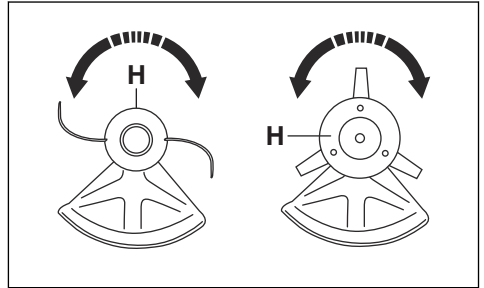

Operation TA1100

Grass trimming with a trimmer head

To trim the grass

- Hold the trimmer head immediately above the ground at an angle. Do not push the trimmer line into the grass.

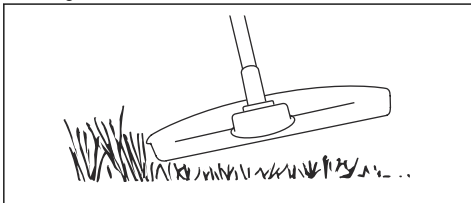

- Decrease the length of the trimmer line by 10-12 cm / 4-4.75 in.
- Decrease the engine speed to decrease the risk of damage to plants.
- Use 80 % throttle when you cut grass near objects.



To cut the grass

- Make sure that the trimmer line is parallel to the ground when you cut the grass.

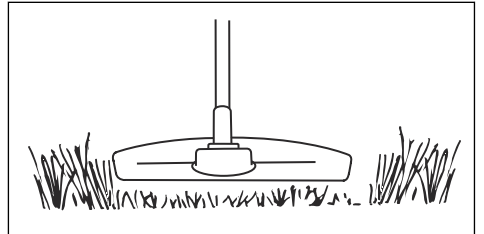

- Do not push the trimmer head to the ground. This can cause damage to the product.
- Move the product from side to side when you cut grass. Use full speed.

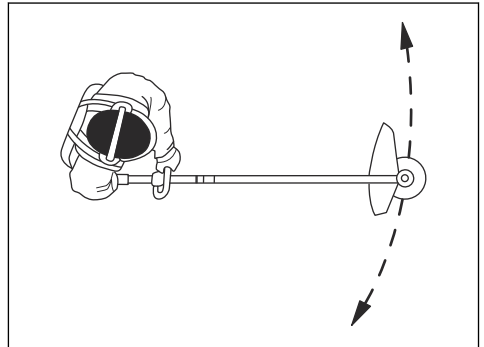

To sweep the grass

The airflow from the rotating trimmer line can be used to remove cut grass from an area.

- Hold the trimmer head and the trimmer line parallel to the ground and above the ground.
- Apply full throttle.

3. Move the trimmer head from side to side and sweep the grass.

prevent unbalance and vibrations in the handles. Also do a check of the other parts of the trimmer head and clean it if necessary.



WARNING: Clean the trimmer head cover each time you assemble new trimmer line to

Technical data TA1100

Technical data

Weight	
Weight with cutting attachment and guard, kg	1.4
Noise emissions ⁴	
Sound power level, measured dB (A)	111
Sound power level, guaranteed L _{WA} dB (A)	113
Sound levels ⁵	
Equivalent sound pressure level at the operator's ear, measured according to EN ISO 11806 and ISO 7917, dB(A), min./max.:	
Equipped with approved accessory (original)	98
Vibration levels	
Equivalent vibration levels (a _{hv,eq}) at handles, measured according to EN ISO 11806 and ISO 22867, m/s ² :	
Equipped with with approved accessory (original), left/right	3.1/2.5

Accessories

Approved accessories

Approved accessories	Type	Cutting attachment guard, Art. no.
Trimmer head	T35	588 54 37-01

⁴ Noise emissions in the environment measured as sound power (L_{WA}) in conformity with EC directive 2000/14/EC. Reported sound power level for the machine has been measured with the original cutting attachment that gives the highest level. The difference between guaranteed and measured sound power is that the guaranteed sound power also includes dispersion in the measurement result and the variations between different machines of the same model according to Directive 2000/14/EC.

⁵ Reported data for equivalent sound pressure level has a typical statistical dispersion (standard deviation) of 1 dB (A).

EC Declaration of Conformity TA1100

EC Declaration of Conformity

Husqvarna AB, SE-561 82 Huskvarna, Sweden, tel: +46-36-146500, declares that the pole saws **Husqvarna TA1100** with serial numbers dating from 2016 onwards (the year is clearly stated on the rating plate, followed by the serial number), comply with the requirements of the COUNCIL'S DIRECTIVE:

- of May 17, 2006 "relating to machinery" **2006/42/EC**
- of February 26, 2014 "relating to electromagnetic compability" **2014/30/EU**
- of June 8, 2011 "on the restriction of the use of certain hazardous substances in electrical and electronic equipment" **2011/65/EU**
- of May 8, 2000 "relating to the noise emissions in the environment" **2000/14/EC**.

The following standards have been applied:

EN ISO 12100:2010, EN ISO 11806-1:2011, EN ISO 11806-2:2011, EN 50581:2012

RISE SMP Svensk Maskinprovning AB, Box 7035, SE-750 07 Uppsala, Sweden, has carried out EC type examination in accordance with the machinery directive's (2006/42/EC) article 12, point 3b. The certificate for EC type examination in accordance with annex V, has the number: **SEC/17/2474**.

Huskvarna, 2016-03-30



Per Gustafsson, Development Manager (Authorized representative for Husqvarna AB and responsible for technical documentation)



www.husqvarna.com

Original instructions

1158824-26



2019-11-27

Free Manuals Download Website

<http://myh66.com>

<http://usermanuals.us>

<http://www.somanuals.com>

<http://www.4manuals.cc>

<http://www.manual-lib.com>

<http://www.404manual.com>

<http://www.luxmanual.com>

<http://aubethermostatmanual.com>

Golf course search by state

<http://golfingnear.com>

Email search by domain

<http://emailbydomain.com>

Auto manuals search

<http://auto.somanuals.com>

TV manuals search

<http://tv.somanuals.com>