



Radio / CD / MP3

**Barcelona MP35**

7 645 250 310

**Madrid MP35**

7 645 260 310

---

### Operating Instructions



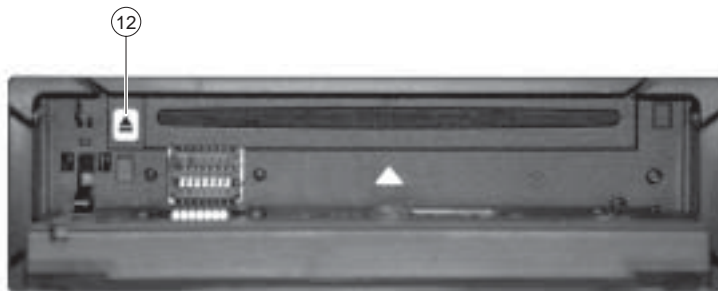

<http://www.blaupunkt.com>

 **BLAUPUNKT**



# CONTROLS

---

- ① Button to switch the device on/off and operate the volume mute function.
- ②  button, to open the flip-release control panel
- ③ Volume control
- ④ **BND•TS** button  
Short press: Select the FM memory banks and the MW and LW wavebands.  
Long press: Start the Travelstore function.
- ⑤ **AUDIO** button to adjust the bass, treble, balance and fader. Select an equalizer preset. Activate, deactivate and adjust X-BASS.
- ⑥ Arrow buttons
- ⑦ **MENU** button  
Short press: Open the settings menu.  
Long press: Start the scan function.
- ⑧ **TRAF•RDS** button  
Short press: Switch traffic-information standby on/off.  
Long press: Switch the RDS function on/off.
- ⑨ Keys **1 - 6**
- ⑩  **DIS** button  
Short press: Briefly display the clock time.  
Long press: Configure the display.
- ⑪ **SRC** button  
Switch sources between radio, CD/MP3, CD changer (if connected) and AUX.
- ⑫  button to eject a CD from the device (only visible when the control panel is open).

<b>Notes and accessories</b> .....	<b>37</b>	<b>Traffic information</b> .....	<b>48</b>
Road safety .....	37	Switching traffic information	
Installation .....	37	priority on/off .....	48
Accessories .....	37	Setting the volume for traffic	
<b>Detachable control panel</b>		announcements .....	48
<b>(flip-release panel)</b> .....	<b>38</b>	<b>CD mode</b> .....	<b>49</b>
Theft protection .....	38	Switching to CD mode .....	49
Detaching the control panel .....	38	Selecting tracks .....	49
Attaching the control panel .....	38	Fast track selection .....	49
Off timer .....	39	Fast searching (audible) .....	49
<b>Switching on/off</b> .....	<b>40</b>	Random track play (MIX) .....	50
<b>Adjusting the volume</b> .....	<b>41</b>	Scanning tracks (SCAN) .....	50
Setting the power-on volume .....	41	Repeating tracks (REPEAT) .....	50
Quick volume reduction (mute) .....	41	Pausing playback (PAUSE) .....	50
Switching the confirmation beep		Configuring the display .....	50
on/off .....	41	Displaying CD text .....	51
Telephone audio .....	42	Traffic announcements in	
<b>Radio mode</b> .....	<b>43</b>	CD mode .....	51
Adjusting the tuner settings .....	43	Ejecting a CD .....	51
Switching to radio mode .....	43	<b>MP3 mode</b> .....	<b>52</b>
RDS functions .....	43	Preparing an MP3-CD .....	52
Selecting the waveband /		Switching to MP3 mode .....	53
memory bank .....	44	Configuring the display .....	53
Tuning into a station .....	44	Selecting a directory .....	54
Setting the sensitivity of station		Selecting tracks/files .....	54
seek tuning .....	44	Fast searching .....	54
Storing stations .....	45	Random track play (MIX) .....	54
Storing stations automatically		Scanning tracks (SCAN) .....	55
(Travelstore) .....	45	Repeating individual tracks or	
Listening to stored stations .....	45	whole directories (REPEAT) .....	55
Scanning receivable stations		Pausing playback (PAUSE) .....	55
(SCAN) .....	45		
Setting the scanning time .....	46		
Programme type (PTY) .....	46		
Optimising radio reception .....	47		
Configuring the display .....	47		

# CONTENTS

---

<b>CD-changer mode</b> .....	56	<b>Adjusting the brightness (dimmer)</b> .....	62
Switching to CD-changer mode ....	56	<b>Entering the power-on message</b> .....	63
Selecting CDs .....	56	<b>Configuring the level display</b> .	63
Selecting tracks .....	56	<b>External audio sources</b> .....	64
Fast searching (audible) .....	56	Switching the AUX input on/off .....	64
Configuring the display .....	56	<b>Specifications</b> .....	64
Repeating individual tracks or whole CDs (REPEAT) .....	56		
Random track play (MIX) .....	57		
Scanning all the tracks on all the CDs (SCAN) .....	57		
Pausing playback (PAUSE) .....	57		
<b>Remote control</b> .....	58		
<b>CLOCK time</b> .....	58		
Displaying the clock time .....	58		
Setting the clock time .....	58		
Selecting 12/24-hour clock mode .	58		
Displaying the time continuously when the device is off and the ignition is on .....	59		
Briefly displaying the time when the device is switched off .....	59		
<b>Sound</b> .....	59		
Adjusting the bass .....	59		
Adjusting the treble .....	60		
Setting the left/right volume distribution (balance) .....	60		
Adjusting the front/rear volume distribution (fader) .....	60		
Equalizer presets .....	61		
<b>X-BASS</b> .....	61		

## Notes and accessories

Thank you for choosing a Blaupunkt product. We hope you enjoy using this new piece of equipment.

### **Please read these operating instructions before using the equipment for the first time.**

The Blaupunkt editors are constantly working on making the operating instructions clearer and easier to understand. However, if you still have any questions on how to operate the device, please contact your dealer or the telephone hotline for your country. You will find the telephone number printed at the back of this booklet.

We provide a manufacturer guarantee on our products bought within the European Union. You can view the guarantee conditions at [www.blaupunkt.de](http://www.blaupunkt.de) or ask for them directly at:

Blaupunkt GmbH  
Hotline  
Robert Bosch Str. 200  
D-31139 Hildesheim  
Germany

## Road safety

 Road safety has absolute priority. Only operate your car sound system if the road and traffic conditions allow you to do so. Familiarise yourself with the device before setting off on your journey.

You must always be able to hear police, fire service and ambulance sirens in good time from inside your vehicle. For this reason, listen to your car sound system at a moderate volume level during your journey.

## Installation

If you want to install your car sound system yourself, please read the installation and connection instructions that follow these operating instructions.

## Accessories

Only use accessories approved by Blaupunkt.

### Remote control

The RC 08, RC 10, RC 10 H or RC 12H (available as optional accessories) remote control allows you to access the most important functions of your car sound system safely and conveniently from your steering wheel.

You cannot switch the device on/off using the remote control.

### Amplifiers

You can use all Blaupunkt and Velocity amplifiers.

### CD changers

You can connect the following Blaupunkt CD changers: CDC A 08, IDC A 09 and CDC A 03.

# DETACHABLE CONTROL PANEL

## Detachable control panel (flip-release panel)

### Theft protection

The device is equipped with a detachable control panel (flip-release panel) as a way of protecting your equipment against theft. The device is worthless to a thief without this control panel.

Protect your device against theft by taking the control panel with you whenever you leave your vehicle. Do not leave the control panel inside your vehicle - not even in a hiding place.

The control panel has been designed to be easy to use.

### Notes:

- Never drop the control panel.
- Never expose the control panel to direct sunlight or other heat sources.
- Avoid direct skin contact with the control panel's electrical contacts. If necessary, clean the contacts with a lint-free cloth and some alcohol.

### Detaching the control panel

- ⇒ Press the  button (2).

The control panel opens out towards you.

- ⇒ Hold the control panel by its right side and then pull the control panel straight out of the bracket.

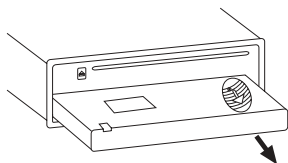

### Notes:

- The device will switch off after a particular time period configured by you. For further details, read the section entitled "OFF TIMER" in this chapter.
- All the current settings are saved.
- Any CD already inserted in the device remains there.

### Attaching the control panel

- ⇒ Hold the control panel at approximately right angles to the device.
- ⇒ Slide the control panel into the device's guides that are positioned on the left and right at the lower edge of the housing. Push the control panel carefully into the bracket until it clicks into place.
- ⇒ Flip up the control panel and carefully press it into the device until it clicks into place.

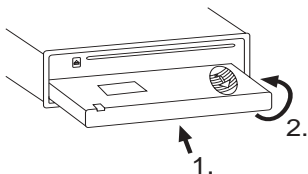

**Note:**

- When attaching the control panel, make sure you do not press the display.

If the device was still switched on when you removed the control panel, it will automatically switch on with the last settings activated (i.e. radio, CD/MP3, CD changer or AUX) when the panel is replaced.

## Off timer

**Note:**

- The device is equipped with a time-out function. If, for instance, you press the **MENU** button (7) and select a menu item, the device will switch back approx. 8 seconds after the last button was pressed. Any changes to the settings that you have made will be saved.

After you detach the control panel, the device will switch off after a preset time period. You can set this time to between 0 and 30 seconds.

- ⇒ Press the **MENU** button (7).
- ⇒ Press the **V** or **^** button (6) repeatedly until "OFF TIMER" appears in the display.
- ⇒ Adjust the time using the **<>** buttons (6).

When you have finished making your changes,

- ⇒ press the **MENU** button (7) twice.

**Note:**

- If you set the off-timer to 0 seconds, the device will switch off immediately as soon as you open the control panel.



# SWITCHING ON/OFF

---

## Switching on/off

There are various ways of switching the device on/off:

### Switching the device on/off using the vehicle ignition

If the device is correctly connected to the vehicle's ignition and you did not switch it off by pressing button ①, the device will switch on/off simultaneously with the ignition.

### Switching the device on/off using the detachable control panel

⇨ Detach the control panel.

The device switches off.

#### Note:

- The device will switch off after a preset time period. For further details, read the section entitled "Off timer".

⇨ Attach the control panel again.

The device switches on. The last setting (radio, CD/MP3, CD changer or AUX) will be reactivated.

### Switching on/off using button ①

⇨ To switch on the device, press button ①.

⇨ To switch off the device, press and hold down button ① for longer than two seconds.

The device switches off.

#### Note:

- To protect the vehicle battery, the device will switch off automatically after one hour if the ignition is off.

### Switching on by inserting a CD

If the device is switched off and there is no CD present in the drive,

⇨ press the  button ②.

The control panel opens.

⇨ Gently insert the CD with its printed side uppermost into the drive until you feel some resistance.

The drive draws in the CD automatically.

You must not hinder or assist the drive as it draws in the CD.

⇨ Gently close the control panel whilst exerting a little pressure until you feel it click into place.

The device switches on and starts playing the CD.

#### Note:

- If the vehicle ignition was switched off before you inserted the CD, you will first have to switch on the device by pressing button ① in order to start playing the CD.

## ADJUSTING THE VOLUME

### Adjusting the volume

You can adjust the volume in steps from 0 (off) to 66 (maximum).

To increase the volume,

- ⇨ turn the volume control (3) clockwise.

To decrease the volume,

- ⇨ turn the volume control (3) anti-clockwise.

### Setting the power-on volume

You can set the power-on volume.

- ⇨ Press the **MENU** button (7).
- ⇨ Press the **V** or **^** button (6) repeatedly until "ON VOLUME" appears in the display.
- ⇨ Adjust the power-on volume using the **<>** buttons (6).

To help you adjust the setting more easily, the device will increase or decrease the volume as you make your changes.

If you change the setting to "LAST VOL", the volume level that was set the last time you switched off the device will be activated again.

#### Note:

- To protect your hearing, the power-on volume is limited to a value of "38". If the volume level was higher than this when the device was last switched off and the "LAST VOL" setting is activated, the system will reset the volume to "38" when you switch the device on again.

When you have finished adjusting the setting,

- ⇨ press the **MENU** button (7) twice.

### Quick volume reduction (mute)

You can quickly decrease the volume (mute) to a level preset by you.

- ⇨ **Briefly** press button (1).

"MUTE" appears in the display.

### Cancelling mute

To return to your previously set volume level,

- ⇨ **briefly** press button (1) again.

### Setting the mute level

You can adjust the mute level.

- ⇨ Press the **MENU** button (7).
- ⇨ Press the **V** or **^** button (6) repeatedly until "MUTE LVL" appears in the display.
- ⇨ Adjust the mute level using the **<>** buttons (6).

When you have finished adjusting the setting,

- ⇨ press the **MENU** button (7) twice.

### Switching the confirmation beep on/off

The system will play a confirmation beep for some functions if you keep a button pressed down for longer than two seconds, for instance, when you assign a radio station to a station button. You can switch the beep on/off.

## ADJUSTING THE VOLUME

---

- ⇒ Press the **MENU** button (7).
- ⇒ Press the **V** or **Λ** button (6) repeatedly until “BEEP ON” or “BEEP OFF” appears in the display.
- ⇒ Adjust the beep setting using the **<>** buttons (6). “OFF” means the beep is switched off and “ON” means the beep is switched on.

When you have finished adjusting the setting,

- ⇒ press the **MENU** button (7).

### Telephone audio

If your car sound system is connected to a mobile telephone, the sound system's volume will be muted as soon as you “pick up” the telephone. The telephone call is then outputted over the car sound system's loudspeakers. This requires that the mobile telephone be connected to the car sound system as described in the installation instructions.

You will need a cable for this with the following Blaupunkt number: 7 607 001 503.

If the sound system receives a traffic announcement during a telephone call, the system will only play the traffic announcement after you have finished the call.

You can set the volume at which you want telephone calls to be initially heard.

- ⇒ Press the **MENU** button (7).
- ⇒ Press the **V** or **Λ** button (6) repeatedly until “TEL VOL” appears in the display.

- ⇒ Set your preferred volume level using the **<>** buttons (6).

When you have finished making your changes,

- ⇒ press the **MENU** button (7) twice.

### **Note:**

- You can use the volume control (3) to adjust the volume of a telephone call whilst the call is being outputted by the sound system.

## Radio mode

This device is equipped with an RDS radio receiver. Many of the receivable FM stations broadcast a signal that not only carries the programme but also additional information such as the station name and programme type (PTY). The station name appears in the display as soon as the tuner receives it.

## Adjusting the tuner settings

To ensure that the tuner works properly, the device must be configured for the region in which you are using it. You can choose between Europe (EUROPE), United States (USA), South America (S-AMERICA) and Thailand (THAI). By default, the tuner is set to the region in which the device was sold. If you encounter problems with radio reception, please check this setting.

The radio functions described in these operating instructions refer to the EUROPE tuner setting.

- ⇨ Press and hold down the **1** and **5** buttons (9) simultaneously and switch on the device again by pressing button (1).

“TUNER” is displayed.

- ⇨ Select your tuner region using the **V** or **^** button (6).

To save the setting,

- ⇨ switch the device off and on again or wait approx. 8 seconds. The car sound system starts with the last setting activated (radio, CD/MP3, CD changer or AUX).

## Switching to radio mode

If you are in CD/MP3, CD-changer or AUX mode,

- ⇨ press the **BND•TS** button (4)

or

- ⇨ press the **SRC** button (11) repeatedly until the memory bank (e.g. “FM1”) appears in the display.

## RDS functions

The convenient RDS functions AF (Alternative Frequency) and REGIONAL extend your radio’s range of functions.

- **AF:** If the RDS function is activated, the radio automatically tunes into the best receivable frequency for the station that is currently set.
- **REGIONAL:** At certain times, some radio stations divide their programme into regional programmes providing different content. You can use the REG function to prevent the car radio from switching to alternative frequencies that are broadcasting different programme content.

### Note:

- REGIONAL must be activated/deactivated separately in the menu.

## Switching the RDS function on/off

If you want to use the RDS functions (AF and REGIONAL),

- ⇨ press and hold down the **TRAF•RDS** button (8) for longer than two seconds.

The RDS function is active when the RDS symbol is shown in the display.

# RADIO MODE

---

## Switching REGIONAL on/off

- ⇒ Press the **MENU** button (7).
- ⇒ Press the **V** or **^** button (6) repeatedly until “REG” appears in the display. “OFF” or “ON” is displayed alongside “REG”.
- ⇒ To switch REGIONAL on/off, press the **>** or **<** button (6).
- ⇒ Press the **MENU** button (7).

## Selecting the waveband / memory bank

You can use this device to receive programmes broadcast over the FM frequency range as well as the MW and LW (AM) wavebands. There are three memory banks available for the FM waveband (FM1, FM2 and FMT) and one for each of the MW and LW wavebands. Six stations can be stored in each memory bank.

To switch between the FM memory banks (FM1, FM2 and FMT) and the MW and LW wavebands,

- ⇒ briefly press the **BND•TS** button (4).

## Tuning into a station

There are various ways of tuning into a station.

### Automatic station seek tuning

- ⇒ Press the **V** or **^** button (6).
- The radio tunes into the next receivable station.

### Tuning into stations manually

You can also tune into stations manually.

#### Note:

- You can only tune into stations manually if the RDS function is deactivated.
- ⇒ Press the **<** or **>** button (6).

### Browsing through broadcasting networks (only FM)

If radio stations provide several programmes, you have the option of browsing through their “broadcasting networks”.

#### Note:

- The RDS function must be activated before you can use this feature.
- ⇒ Press the **<** or **>** button (6) to switch to the next station on the broadcasting network.

#### Note:

- When using this feature, you will only be able to switch to stations that you have received once before already. To receive the stations, use the scan function or the Travel-store function.

### Setting the sensitivity of station seek tuning

You can choose whether the radio should only tune into stations providing good reception or whether it can also tune into those with a weak reception.

- ⇒ Press the **MENU** button (7).

⇨ Press the **V** or **^** button (6) repeatedly until “SENS” and the currently set value appear in the display.

“SENS HI6” means that the tuner is set to the highest sensitivity setting. “SENS LO1” means it is set to the lowest sensitivity setting.

⇨ Set the desired sensitivity using the **<>** buttons (6).

When you have finished adjusting the setting,

⇨ press the **MENU** button (7).

### Note:

- You can set different sensitivity levels for FM and MW or LW.

## Storing stations

### Storing stations manually

- ⇨ Select the memory bank that you want (FM1, FM2, FMT) or one of the wavebands (MW or LW).
- ⇨ Tune into the station that you want.
- ⇨ Press and hold down one of the station buttons **1 - 6** (9) for longer than two seconds to assign the station to that button.

### Storing stations automatically (Travelstore)

You can automatically store the six stations providing the best reception in the region (only FM). The stations are stored in the FMT memory bank.

### Note:

- Any stations previously stored in this memory bank are deleted in the process.

⇨ Press and hold down the **BND•TS** button (4) for longer than two seconds.

The storing procedure begins. “FM TSTORE” appears in the display. After the process has completed, the radio will play the station that is stored in memory location 1 of the FMT memory bank.

## Listening to stored stations

- ⇨ Select the memory bank or waveband.
- ⇨ Press the station button **1 - 6** (9) that corresponds to the station that you want to listen to.

## Scanning receivable stations (SCAN)

You can use the scan function to listen to all the receivable stations briefly. You can set the scanning time in the menu to between 5 and 30 seconds (in steps of 5 seconds).

### Starting SCAN

- ⇨ Press and hold down the **MENU** button (7) for longer than two seconds.

Scanning begins. “SCAN” appears briefly in the display followed by a flashing display of the current station name or frequency.

### Cancelling SCAN and continuing listening to a station

- ⇨ Press the **MENU** button (7).

Scanning stops and the radio continues playing the station that it tuned into last.

# RADIO MODE

## Setting the scanning time

- ⇨ Press the **MENU** button (7).
- ⇨ Press the **▼** or **▲** button (6) repeatedly until "SCAN TIME" appears in the display.
- ⇨ Set the desired scanning time using the **<>** buttons (6).

When you have finished adjusting the setting,

- ⇨ press the **MENU** button (7) twice.

### **Note:**

- The scanning time that you set is also used when scanning in CD/MP3 mode and in CD-changer mode.

## Programme type (PTY)

Besides transmitting the station name, some FM stations also provide information on the type of programme they are broadcasting. Your car radio can receive and display this information.

For example, the programme types can be:

CULTURE	TRAVEL	JAZZ
SPORT	NEWS	POP
ROCK	CLASSICS	

You can use the PTY function to select stations of a particular programme type.

### **PTY-EON**

If you specify the programme type and start seek tuning, the radio will switch from the current station to a station of the selected programme type.

### **Notes:**

- If the tuner does not find a station that matches the selected programme type, you will hear a beep and "NO PTY" appears briefly in the display. The radio will then re-tune to the station that it received last.
- If the tuned radio station or another station on the broadcasting network broadcasts your selected programme type at a later point in time, the radio will automatically switch from the currently tuned station or from CD/MP3 mode or CD-changer mode to the station whose programme type matches the one you selected.

## **Switching PTY on/off**

- ⇨ Press the **MENU** button (7).
- ⇨ Press the **▼** or **▲** button (6) repeatedly until "PTY ON" or "PTY OFF" appears in the display.
- ⇨ Press the **>** or **<** button (6) to switch PTY ON or OFF.
- ⇨ Press the **MENU** button (7).

## **Selecting the PTY language**

You can select the language in which the programme types are displayed. The following are available: "DEUTSCH", "ENGLISH" and "FRANÇAIS".

- ⇨ Press the **MENU** button (7).
- ⇨ Press the **▼** or **▲** button (6) repeatedly until "PTY LANG" appears in the display.

- ⇒ Set your preferred language using the <> buttons (6).

When you have finished adjusting the setting,

- ⇒ press the **MENU** button (7) twice.

## Selecting a programme type and starting seek tuning

- ⇒ Press the < or > button (6).

The current programme type appears in the display.

- ⇒ If you want to select another programme type, you can do so by pressing the < or > button (6) whilst this display is visible.

The selected programme type appears briefly in the display.

- ⇒ Press the **V** or **^** button (6) to start seek tuning.

The radio will then tune into the next station it finds that matches your selected programme type.

## Optimising radio reception

### HICUT

The HICUT function improves reception during poor radio reception (only FM). If interference occurs, the interference level is cut automatically.

### Switching HICUT on/off

- ⇒ Press the **MENU** button (7).
- ⇒ Press the **V** or **^** button (6) repeatedly until “HICUT” appears in the display.
- ⇒ Press the < or > button (6) to adjust the HICUT setting.

“HICUT 0” means that the interference level will not be cut automatically. “HICUT 1” means that it will be cut automatically.

- ⇒ Press the **MENU** button (7).

## Configuring the display

In radio mode, you have the option of displaying the waveband together with the memory bank and the time or the station name / frequency of the current station.

- ⇒ To switch between the displays, press and hold down the **DIS** button (10) for longer than two seconds.



# TRAFFIC INFORMATION

## Traffic information

Your device is equipped with an RDS-EON receiver. EON stands for **Enhanced Other Network**.

Whenever a traffic announcement (TA) is broadcast, the system switches automatically from a station that does not provide traffic reports to the appropriate traffic information station within the broadcasting network that does.

Once the traffic report has been played, the system will switch back to the programme you were listening to before.

### Switching traffic information priority on/off

⇨ Briefly press the **TRAF•RDS** button (8).

Traffic announcement priority is active when the traffic-jam symbol lights up in the display.

#### **Notes:**

You will hear a warning beep:

- if you leave the reception area of a traffic information station that you are currently listening to.
- if you are receiving a traffic information station and the volume is set to minimum (0) or if, whilst listening to a CD/MP3, a CD in the changer or an AUX source, you leave the reception area of the tuned traffic information station and the subsequent automatic search cannot find a new traffic information station.

- if you retune the radio from a traffic information station to a station that does not broadcast traffic information.

If you hear the warning beep, you can either switch off traffic information priority or tune into a station that broadcasts traffic information.

### Setting the volume for traffic announcements

- ⇨ Press the **MENU** button (7).
- ⇨ Press the **▼** or **▲** button (6) repeatedly until "TA VOLUME" appears in the display.
- ⇨ Adjust the volume using the **<>** buttons (6).

When you have finished adjusting the setting,

- ⇨ press the **MENU** button (7) twice.

#### **Notes:**

- You can use the volume control (3) to adjust the volume during a traffic announcement for the duration of that announcement.
- You can set the volume distribution for the traffic announcements. For further details, please read the "Sound" chapter.

## CD mode

You can use this device to play standard audio CDs, CD-Rs and CD-RWs with a diameter of 12 or 8 cm.

 Risk of severe damage to the CD drive!

Contoured CDs (shape CDs) are not suitable for playback in this unit. We do not accept responsibility for any damage to the CD drive that may occur as a result of the use of unsuitable CDs.

To ensure the system functions properly, only use CDs labelled with the compact disc logo. Problems might be experienced when playing copy-protected CDs. Blaupunkt cannot guarantee the proper functioning of copy-protected CDs!

Besides being able to play audio CDs on this device, you can also play CDs containing MP3 music files. For further details, please read the "MP3 mode" chapter.

### Switching to CD mode

If there is no CD inserted in the drive,

⇒ press the  button (2).

The control panel opens.

⇒ Gently push the CD with the printed side uppermost into the CD compartment until you feel some resistance.

The drive draws in the CD automatically.

You must not assist or hinder the drive as it draws in the CD.

⇒ Gently close the control panel whilst exerting a little pressure until you feel it click into place.

The CD starts playing.

### **Note:**

- If the vehicle ignition was switched off before you inserted the CD, you will first have to switch on the device by pressing button (1) in order to start playing the CD.

If there is already a CD inserted in the drive,

⇒ press the **SRC** button (1) repeatedly until "CD" appears in the display.

Playback begins from the point at which it was last interrupted.

### Selecting tracks

⇒ Press one of the arrow buttons (6) to select the next or previous track.

If you press the **V** or **<** button (6) once, the current track will be played again from the beginning.

### Fast track selection

For fast track selection (backwards or forwards),

⇒ press and hold down one of the **▲ V** buttons (6) until fast-reverse / fast-forward track selection begins.

### Fast searching (audible)

For fast searching (backwards or forwards),

⇒ press and hold down one of the **<>** buttons (6) until fast searching backwards / forwards begins.

## CD MODE

---

### Random track play (MIX)

⇨ Press the **5 MIX** button (9).

“MIX CD” appears briefly in the display and the MIX symbol lights up. The next randomly selected track will then be played.

### **Cancelling MIX**

⇨ Press the **5 MIX** button (9) again.

“MIX OFF” appears briefly in the display and the MIX symbol disappears.

### Scanning tracks (SCAN)

You can scan (briefly play) all the tracks on the CD.

⇨ Press and hold down the **MENU** button (7) for longer than two seconds.

The next track will then be scanned.

### **Note:**

- You can set the scanning time. For further details, please read the section entitled “Setting the scanning time” in the “Radio mode” chapter.

### **Cancelling SCAN and continuing listening to a track**

⇨ To cancel scanning, press the **MENU** button (7).

The currently scanned track will then continue to be played normally.

### Repeating tracks (REPEAT)

If you want to repeat a track,

⇨ press the **4 RPT** button (9).

“RPT TRCK” appears briefly in the display and the RPT symbol lights up. The track is repeated continuously until you deactivate RPT.

### **Cancelling REPEAT**

If you want to cancel the repeat function,

⇨ press the **4 RPT** button (9) again.

“RPT OFF” appears briefly in the display and the RPT symbol disappears. Normal playback is then resumed.

### Pausing playback (PAUSE)

⇨ Press button **3** (9).

“PAUSE” appears in the display.

### **Cancelling pause**

⇨ Press button **3** (9) whilst pause is activated.

Playback is resumed.

### Configuring the display

You can choose between two display types for CD mode:

- Track number and clock time
  - Track number and playing time
- ⇨ To switch between the displays, press and hold down the **DIS** button (10) for longer than two seconds.

## Displaying CD text

Some CDs include CD text. The CD text might contain the names of the artist, album and track.

You can allow the CD text to be displayed as scrolling text every time you switch to another track. The default display will appear again after the whole CD text has been shown once. For further details, please read the section entitled "Configuring the display".

## Switching CD text on/off

- ⇒ Press the **MENU** button (7).
- ⇒ Press the **V** or **^** button (6) repeatedly until "CD TEXT" appears in the display.
- ⇒ Switch the CD text function on ("TEXT ON") or off ("TEXT OFF") using the **>** or **<** button (6).

When you have finished adjusting the setting,

- ⇒ press the **MENU** button (7) twice.

## Traffic announcements in CD mode

If you wish to receive traffic announcements whilst CD mode is activated,

- ⇒ press the **TRAF•RDS** button (8).

Traffic announcement priority is active when the traffic jam symbol is shown in the display. For further details, please read the "Traffic information reception" chapter.

## Ejecting a CD

- ⇒ Press the **▶** button (2).

The control panel opens.

- ⇒ Press the **▲** button (12) next to the CD compartment.

The CD is ejected.

- ⇒ Remove the CD.
- ⇒ Gently close the control panel whilst exerting a little pressure until you feel it click into place.

## **Notes:**

- If a CD is ejected, the drive will automatically draw it back in again after approx. 10 seconds.
- You can also eject CDs whilst the device is switched off or whilst another audio source is activated.

# MP3 MODE

## MP3 mode

You can also use this car sound system to play CD-Rs and CD-RWs that contain MP3 music files.

### Preparing an MP3-CD

The various combinations of CD burners, CD burning software and CD blanks may lead to problems arising with the device's ability to play certain CDs. If problems occur with your own burned CDs, you should try another brand of CD blank or choose another colour of CD blank.

The format of the CD must be ISO 9660 Level 1 / Level 2 or Joliet. Other formats cannot be played reliably.

You can create a maximum of 252 directories on a CD. You can use this device to access each of the directories.

Regardless of the number of directories on the CD, the device can handle up to 999 MP3 files on a single CD with a maximum of 255 files in a directory.

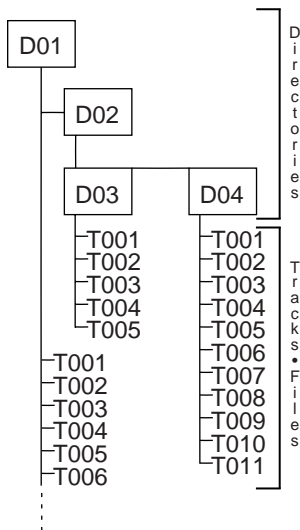

Each directory can be given a name using a PC. The device is capable of displaying the directory name. You should name the directories and tracks/files using the method provided by your CD burner software. The software's instruction manual will provide details on how to do this.

#### **Note:**

- When naming directories and tracks/files you should not use accents and special characters.

If you like your files to be in the correct order, you should use burner software that places files in alphanumerical order. If your software does not provide this feature you also have the option of sorting the files manually. To do so, you should place a number (e.g. "001",

“002”, etc.) at the beginning of each file name - you must include the leading zeros.

MP3 tracks can contain additional information such as the artist, album and track names (ID3 tags). This device can display ID3 tags (version 1).

When creating (encoding) MP3 files from audio files, you should use bit rates up to a maximum of 256 kbits/sec.

This device can only play MP3 files that have the “.MP3” file extension.

#### Note:

To ensure uninterrupted playback,

- do not attempt to change the file extension to “.MP3” of any files other than MP3 files and then attempt to play them! The device will ignore these invalid files during playback.
- Do not use “mixed” CDs containing both non-MP3 data and MP3 tracks (the device only reads MP3 files during MP3 playback).
- Do not use mix-mode CDs containing both CD audio tracks and MP3 tracks. If you try playing a mix-mode CD, the device will only play the CD audio tracks.

### Switching to MP3 mode

MP3 mode is activated in the same way as normal CD mode. For further details, please read the section entitled “Switching to CD mode” in the “CD mode” chapter.

### Configuring the display

An MP3-CD must already be inserted in the device before you can change the following settings.

#### Configuring the default display

You can display various types of information on the current track:

- Track number and playing time (“TRCK-TIME”)
- Track number and clock time (“TRCK-CLK”)
- Directory number and track number (“DIR-TRCK”)
- Directory number and clock time (“DIR-CLK”)
- Directory number and playing time (“DIR-TIME”)

#### Note:

- After you switch tracks, the device first displays the MP3 scrolling text once and then it displays the information continuously.

To switch between the different display options,

- ⇨ press and hold down the **DIS** button  for longer than two seconds.

A different display type is selected every time you perform a long press on the **DIS** button .

- ⇨ Perform this long button press repeatedly until the information you want is displayed.

# MP3 MODE

## Configuring the MP3 scrolling text

One of the following scrolling texts is displayed once every time the track is changed. Afterwards, the configured default display is shown.

The available scrolling texts are:

- Directory name ("DIR NAME")
- Track name ("SONG NAME")
- Album name ("ALBM NAME")
- Artist name ("ARTIST")
- File name ("FILE NAME")

### Note:

- The artist, track and album names are part of the MP3-ID tag (version 1) and can only be displayed if they have been saved with the MP3 files (for further details, please read the instructions that came with your PC's MP3 software or burner software).

To switch between the different display options,

- ⇒ press the **MENU** button (7).
- ⇒ Press the **V** or **^** button (6) repeatedly until "MP3 DISP" appears in the display.
- ⇒ Use the **>** or **<** button (6) to select the MP3 scrolling text that you want.

When you have finished adjusting the setting,

- ⇒ press the **MENU** button (7) twice.

## Selecting a directory

To move up or down to another directory,

- ⇒ press the **V** or **^** button (6) once or several times.

## Selecting tracks/files

To move up or down to another track/file in the current directory,

- ⇒ press the **<** or **>** button (6) once or several times.

If you press the **<** button (6) once, the current track will be played again from the beginning.

## Fast searching

For fast searching (backwards or forwards),

- ⇒ press and hold down the **<** or **>** button (6) until fast searching backwards / forwards begins.

## Random track play (MIX)

To play the tracks in the current directory in random order,

- ⇒ briefly press the **5 MIX** button (9).

"MIX DIR" appears in the display and the MIX symbol lights up.

To play all the tracks on the inserted MP3-CD in random order,

- ⇒ press and hold down the **5 MIX** button (9) for longer than two seconds.

"MIX CD" appears in the display and the MIX symbol is displayed.

### Cancelling MIX

To cancel MIX,

⇨ briefly press the **5 MIX** button (9).

“MIX OFF” appears in the display and the MIX symbol disappears.

### Scanning tracks (SCAN)

You can scan (briefly play) all the tracks on the CD.

⇨ Press and hold down the **MENU** button (7) for longer than two seconds. The next track will then be scanned.

“TRK SCAN” appears in the display alongside the flashing track numbers. The tracks on the CD are briefly played in ascending order.

#### Note:

- You can set the scanning time. For details on setting the scanning time, please read the section entitled “Setting the scanning time” in the “Radio mode” chapter.

### Cancelling SCAN and continuing listening to a track

⇨ Briefly press the **MENU** button (7).

The currently scanned track will then continue to be played normally.

### Repeating individual tracks or whole directories (REPEAT)

To play the current track repeatedly,

⇨ briefly press the **4 RPT** button (9).

“RPT TRCK” appears briefly in the display and RPT is displayed.

To play the whole directory repeatedly,

⇨ press and hold down the **4 RPT** button (9) for longer than two seconds.

“RPT DIR” appears in the display.

### Cancelling REPEAT

To stop the current track or current directory from being repeated,

⇨ briefly press the **4 RPT** button (9).

“RPT OFF” appears briefly and RPT disappears from the display.

### Pausing playback (PAUSE)

⇨ Press button **3** (9).

“PAUSE” appears in the display.

### Cancelling pause

⇨ Press button **3** (9) whilst pause is activated.

Playback is resumed.



# CD-CHANGER MODE

## CD-changer mode

### Note:

- Information on handling CDs, inserting CDs and operating the CD changer can be found in the operating instructions supplied with your CD changer.

### Switching to CD-changer mode

- ⇒ Press the **SRC** button (11) repeatedly until "CHANGER" appears in the display.

The device starts playing the first CD that the CD changer detects.

### Selecting CDs

To move up or down to another CD,

- ⇒ press the **V** or **Λ** button (6) once or several times.

### Note:

- The device will ignore empty CD slots in the changer and slots containing invalid CDs.

### Selecting tracks

To move up or down to another track on the current CD,

- ⇒ press the **<** or **>** button (6) once or several times.

### Fast searching (audible)

For fast searching (backwards or forwards),

- ⇒ press and hold down one of the **<>** buttons (6) until fast searching backwards / forwards begins.

## Configuring the display

There are five display options available for CD-changer mode:

- Track number and playing time ("TRCK-TIME")
- Track number and clock time ("TRCK-CLK")
- CD number and track number ("CD-TRCK")
- CD number and clock time ("CD-CLK")
- CD number and playing time ("CD-TIME")

- ⇒ To switch between the displays, press and hold down the **DIS** button (10) for longer than two seconds.

A different display type is selected every time you perform a long press on the **DIS** button (10).

- ⇒ Perform this long button press repeatedly until the information you want is displayed.

### Repeating individual tracks or whole CDs (REPEAT)

To repeat the current track,

- ⇒ briefly press the **4 RPT** button (9).

"RPT TRCK" appears briefly in the display and RPT is displayed.

To repeat the current CD,

- ⇒ press and hold down the **4 RPT** button (9) for longer than two seconds.

"RPT DISC" appears briefly in the display and RPT is displayed.

### Cancelling REPEAT

To stop the current track or current CD from being repeated,

⇨ briefly press the **4 RPT** button (9).

“RPT OFF” appears and RPT disappears from the display.

### Random track play (MIX)

To play the tracks on the current CD in random order,

⇨ briefly press the **5 MIX** button (9).

“MIX CD” appears briefly in the display and MIX is displayed.

To play the tracks on all the inserted CDs in random order,

⇨ press and hold down the **5 MIX** button (9) for longer than two seconds.

“MIX ALL” appears briefly in the display and MIX is displayed.

### Cancelling MIX

⇨ Briefly press the **5 MIX** button (9).

“MIX OFF” appears and MIX disappears from the display.

### Scanning all the tracks on all the CDs (SCAN)

To scan (briefly play) all the tracks on all the inserted CDs in ascending order,

⇨ press and hold down the **MENU** button (7) for longer than two seconds.

“TRK SCAN” appears in the display and the number of the current track flashes.

### Cancelling SCAN

To stop scanning,

⇨ briefly press the **MENU** button (7).

The currently scanned track will then continue to be played normally.

#### Note:

- You can set the scanning time. For further details, please read the section entitled “Setting the scanning time” in the “Radio mode” chapter.

### Pausing playback (PAUSE)

⇨ Press button **3** (▶) (9).

“PAUSE” appears in the display.

### Cancelling pause

⇨ Press button **3** (▶) (9) whilst pause is activated.

Playback is resumed.

## Remote control

Your car radio is equipped with an integrated infrared remote-control receiver. The receiver is built into the detachable control panel.

You can safely and conveniently control the majority of the device's functions using a steering-wheel remote control or handheld remote control (available as optional accessories).

You cannot switch the device on/off using the remote control.

### Note:

- The infrared receiver that is included with the remote control only needs to be installed (as described in the installation instructions) if there is no direct line-of-sight connection between the remote control and the car radio.

## CLOCK time

### Displaying the clock time

To display the clock time briefly,

- ⇨ briefly press the **DIS** button (10).

### Setting the clock time

To set the clock time,

- ⇨ press the **MENU** button (7).
- ⇨ Press the **∨** or **∧** button (6) repeatedly until "CLOCK SET" appears in the display.
- ⇨ Press the **<** button (6).

The clock time appears in the display. The hours flash and can be adjusted.

- ⇨ Adjust the hours using the **∧ ∨** buttons (6).

Once the hours are set,

- ⇨ press the **>** button (6).

The minutes flash.

- ⇨ Adjust the minutes using the **∧ ∨** buttons (6).
- ⇨ Press the **MENU** button (7) twice.

### Selecting 12/24-hour clock mode

- ⇨ Press the **MENU** button (7).
- "MENU" appears in the display.
- ⇨ Press the **∨** or **∧** button (6) repeatedly until "24 H MODE" or "12 H MODE" appears in the display.
  - ⇨ Press the **<** or **>** button (6) to switch between the modes.

When you have finished adjusting the setting,

- ⇒ press the **MENU** button (7).

### Displaying the time continuously when the device is off and the ignition is on

To display the time when the device is off and the vehicle ignition is on,

- ⇒ press the **MENU** button (7).
- “MENU” appears in the display.
- ⇒ Press the **V** or **^** button (6) repeatedly until “CLOCK OFF” or “CLOCK ON” appears in the display.
- ⇒ Press the **<** or **>** button (6) to switch between the ON/OFF settings.

When you have finished adjusting the setting,

- ⇒ press the **MENU** button (7).

### Briefly displaying the time when the device is switched off

To display the time briefly when the device is off,

- ⇒ press the **DIS** button (10).

The clock time is shown in the display for approx. 8 seconds.

## Sound

You can adjust the sound settings (bass and treble) separately for each source (radio, CD/MP3 and CD changer / AUX).

You can boost or cut the bass and treble in steps of  $\pm 7$ .

You can choose from 4 possible centre frequencies in order to further optimise the sound.

The change to the boost or cut of the bass and treble relates to the particular centre frequency that you selected.

The volume distribution settings (balance and fader) apply to all the audio sources (except for traffic announcements).

You can **only** adjust the balance and fader settings for traffic announcements **whilst** a traffic announcement is actually being played.

### Adjusting the bass

#### Adjusting the bass boost/cut

- ⇒ Press the **AUDIO** button (5).
- “BASS” appears in the display.
- ⇒ Press the **V** or **^** button (6) to adjust the bass.

#### Setting the bass centre frequency

You can choose between 4 centre frequencies for boosting/cutting the bass: 60 Hz, 80 Hz, 100 Hz and 120 Hz.

- ⇒ Whilst the bass setting is being displayed, press the **<** or **>** button (6) to choose between the 4 possible centre frequencies.

# SOUND

---

When you have finished adjusting the setting,

- ⇒ press the **AUDIO** button (5).

## Adjusting the treble

### **Adjusting the treble boost/cut**

- ⇒ Press the **AUDIO** button (5).

“BASS” appears in the display.

- ⇒ Press the **>** button (6) repeatedly until “TREBLE” appears in the display.
- ⇒ Press the **∇** or **▲** button (6) to adjust the treble.

### **Setting the treble centre frequency**

You can choose between 4 centre frequencies for boosting/cutting the treble: 8 kHz, 10 kHz, 12 kHz and 15 kHz.

- ⇒ Whilst the treble setting is being displayed, press the **<** or **>** button (6) to choose between the 4 possible centre frequencies.

When you have finished adjusting the setting,

- ⇒ press the **AUDIO** button (5).

## Setting the left/right volume distribution (balance)

To adjust the left/right volume distribution (balance),

- ⇒ press the **AUDIO** button (5).  
“BASS” appears in the display.
- ⇒ Press the **>** button (6) repeatedly until “BAL” appears in the display.
- ⇒ Press the **∇** or **▲** button (6) to adjust the balance (right/left).

When you have finished adjusting the setting,

- ⇒ press the **AUDIO** button (5).

## Adjusting the front/rear volume distribution (fader)

To adjust the front/rear volume distribution (fader),

- ⇒ press the **AUDIO** button (5).  
“BASS” appears in the display.
- ⇒ Press the **>** button (6) repeatedly until “FADER” appears in the display.
- ⇒ Press the **∇** or **▲** button (6) to adjust the fader (front/rear).

When you have finished adjusting the setting,

- ⇒ press the **AUDIO** button (5).

### Equalizer presets

This device is equipped with an equalizer that has been preset with settings for the "ROCK", "POP" and "CLASSIC" music styles.

To select an equalizer preset,

- ⇨ press the **AUDIO** button (5).
- "BASS" appears in the display.
- ⇨ Press the **>** button (6) repeatedly until "POP", "ROCK", "CLASSIC" or "EQ OFF" appears in the display.
- ⇨ Press the **∨** or **∧** button (6) to select one of the presets or select "EQ OFF" to switch off the equalizer. If you select one of the presets, it will be shown continuously in the display.

When you have finished adjusting the setting,

- ⇨ press the **AUDIO** button (5).

### X-BASS

You can use the X-Bass feature to boost the bass at low volume levels.

The selected X-Bass setting affects all the audio sources (radio, CD/MP3, CD changer or AUX).

You can set the X-Bass in steps ranging from OFF to three. Three means that the X-Bass boost is set to maximum and OFF means that X-Bass is switched off. Additionally, you can choose between a centre frequency of 50 Hz or 100 Hz.

#### Adjusting the X-BASS boost

- ⇨ Press the **AUDIO** button (5).
- "BASS" appears in the display.
- ⇨ Press the **>** button (6) repeatedly until "X-BASS" appears in the display together with the current setting.
- ⇨ Press the **∨** or **∧** button (6) repeatedly until the setting that you want appears in the display.

When you have finished adjusting the setting,

- ⇨ press the **AUDIO** button (5).

#### Setting the X-BASS centre frequency

You can choose between 2 centre frequencies for the X-BASS: 50 Hz or 100 Hz.

- ⇨ Whilst the X-BASS setting is being displayed, press the **<** or **>** button (6) to choose between the 2 possible centre frequencies.

When you have finished adjusting the setting,

- ⇨ press the **AUDIO** button (5).

## BRIGHTNESS (DIMMER)

---

### Adjusting the brightness (dimmer)

The display brightness will change when the headlights are turned on/off if your car radio is connected as described in the installation instructions and your vehicle is equipped with the appropriate connection. You can adjust the display brightness for night and day separately in steps ranging from 1 - 9.

In addition, you can select the "AUTO DIM" setting for the night-time dimmer (DIM NIGHT). If the "AUTO DIM" setting is activated, the car radio's illumination will be adjusted to suit the cockpit's illumination setting when the vehicle lights are switched on.

### Setting "DIM DAY" or "DIM NIGHT"

⇨ Press the **MENU** button (7).

"MENU" appears in the display.

⇨ Press the **▼** or **▲** button (6) repeatedly until "DIM DAY" or "DIM NIGHT" appears in the display.

⇨ Press the **<** or **>** button (6) to switch between the brightness levels.

When you have finished adjusting the setting,

⇨ press the **MENU** button (7) twice.

### Setting "AUTO DIM"

⇨ Press the **▼** or **▲** button (6) repeatedly until "DIM NIGHT" appears in the display.

⇨ Press the **<** button (6) repeatedly until "AUTO DIM" appears in the display.

When you have finished adjusting the setting,

⇨ press the **MENU** button (7) twice.

## Entering the power-on message

After you switch on your device, the system displays a short message in the display. The factory default setting is the "BLAUPUNKT" text. Instead of this, you can enter your own text up to 9 characters long.

- ⇒ Press the **MENU** button (7).
- ⇒ Press the **▼** or **▲** button (6) repeatedly until "ON MSG" appears in the display.
- ⇒ Press the **>** button (6).

The default text for the power-on message appears in the display. The input cursor flashes at the beginning of the line.

### Note:

- You can delete the entire line by pressing and holding down the **<** or **>** button (6) for longer than two seconds.

To enter a different text,

- ⇒ select a letter using the **▼** or **▲** button (6).
- ⇒ Move the selection cursor using the **<** or **>** button (6).

Once you have entered the message,

- ⇒ press the **MENU** button (7) twice.

The settings are saved.

## Configuring the level display

The level display temporarily provides you with a symbolic representation of the volume and audio settings whilst you are adjusting them.

When you are not changing any settings, the level display depicts the peak music/speech output. You can switch the level display on/off.

- ⇒ Press the **MENU** button (7).

"MENU" appears in the display.

- ⇒ Press the **▼** or **▲** button (6) repeatedly until "PEAK LVL" appears in the display.

- ⇒ Press the **<** or **>** button (6) to switch between "PEAK ON" and "PEAK OFF".

When you have finished adjusting the setting,

- ⇒ press the **MENU** button (7) twice.



## External audio sources

**Instead** of connecting a CD changer, you can connect another audio source equipped with a line output. Audio sources can, for example, be portable CD players, MiniDisc players or MP3 players.

If you want to connect an external audio source, you will need an adapter cable. You can obtain this cable (Blaupunkt no.: 7 607 897 093) from your authorised Blaupunkt dealer.

### Note:

- If no CD changer is connected, the AUX input must be activated in the menu.

### Switching the AUX input on/off

⇒ Press the **MENU** button (7).

“MENU” appears in the display.

⇒ Press the **V** or **^** button (6) repeatedly until “AUX OFF” or “AUX ON” appears in the display.

⇒ Press the **<** or **>** button (6) to switch AUX on/off.

When you have finished adjusting the setting,

⇒ press the **MENU** button (7).

### Note:

- If the AUX input is activated, you can select it by pressing the **SRC** button (11). “AUX INPUT” then appears in the display.

## Specifications

### Amplifier

Output power: 4 x 25 watts sine in accordance with DIN 45 324 at 14.4 V  
4 x 45 watts max. power

### Tuner

Wavebands in Europe:

FM : 87.5 - 108 MHz  
MW : 531 - 1 602 kHz  
LW : 153 - 279 kHz

FM frequency response:

35 - 16,000 Hz

### CD

Frequency response:

20 - 20,000 Hz

### Pre-amp out

4 channels: 2 V

### Input sensitivity

AUX input: 2 V / 6 kΩ

Subject to changes!

Bitte den ausgefüllten Gerätepass sicher aufbewahren!

Please keep the filled-in radio pass in a safe place!

Prière de conserver soigneusement la carte d'autoradio remplie !

Tenete per favore il libretto di apparecchio, debitamente riempito,  
in un posto sicuro!

Bewaar de ingevulde apparaatpas op een veilige plaats!

Vänligen förvara ifyllt apparatpass på säker plats!

¡Favor guardar el documento del aparato debidamente llenado en  
un lugar seguro!

Por favor, guardar o cartão preenchido do aparelho num lugar  
seguro!

Det udfyldte apparatpas opbevares et sikkert sted!

DEUTSCH

ENGLISH

FRANÇAIS

ITALIANO

NEDERLANDS

SVENSKA

ESPAÑOL

PORTUGUÊS

DANSK

Country:	Phone:	Fax:	WWW:
Germany	(D) 0180-5000225	05121-49 4002	http://www.blaupunkt.com
Austria	(A) 01-610 39 0	01-610 39 391	
Belgium	(B) 02-525 5444	02-525 5263	
Denmark	(DK) 44 898 360	44-898 644	
Finland	(FIN) 09-435 991	09-435 99236	
France	(F) 01-4010 7007	01-4010 7320	
Great Britain	(GB) 01-89583 8880	01-89583 8394	
Greece	(GR) 210 94 27 337	210 94 12 711	
Ireland	(IRL) 01-4149400	01-4598830	
Italy	(I) 02-369 62331	02-369 62464	
Luxembourg	(L) 40 4078	40 2085	
Netherlands	(NL) 023-565 6348	023-565 6331	
Norway	(N) 66-817 000	66-817 157	
Portugal	(P) 01-2185 00144	01-2185 11111	
Spain	(E) 902 52 77 70	91 410 4078	
Sweden	(S) 08-7501500	08-7501810	
Switzerland	(CH) 01-8471644	01-8471650	
Czech. Rep.	(CZ) 02-6130 0441	02-6130 0514	
Hungary	(H) 01-333 9575	01-324 8756	
Poland	(PL) 0800-118922	022-8771260	
Turkey	(TR) 0212-335 06 69	0212-346 00 40	
USA	(USA) 800-2662528	708-6817188	
Brasil			
(Mercosur)	(BR) +55-19 3745 2769	+55-19 3745 2773	
Malaysia			
(Asia Pacific)	(MAL) +604-6382 474	+604-6413 640	

**● BLAUPUNKT**

## Gerätepass

Name: .....

Typ: **7 645** .....

Serien-Nr: **BP** .....

Blaupunkt GmbH, Robert-Bosch-Straße 200, D-31139 Hildesheim



8622404319

## **(DE) Hinweis zum PTY-EON-Empfang**

Wenn Ihr Blaupunkt-Gerät von einem gehörten Radioprogramm zu einem anderen Radioprogramm oder von einer gewählten Quelle (CD oder CD-Wechsler) zu einem Radioprogramm umschaltet, so überprüfen Sie bitte, ob Sie PTY (Programm-Typ) eingeschaltet haben.

Möchten Sie diese PTY-EON-Umschaltung nicht haben, so schalten Sie diese im Menü mit „PTY off“ aus. Drücken Sie zuvor eine der Tasten AUDIO, SRC oder BND.

Bitte lesen Sie dazu auch in der Bedienungsanleitung unter „Radiobetrieb“ den Absatz „Programm-Typ (PTY)“.

## **(GB) Note regarding PTY-EON reception**

If your Blaupunkt system switches from your chosen radio programme to another radio programme or from your chosen audio source (CD or CD changer) to a radio programme, please check whether you have activated the PTY (programme type) function.

If you do not want this PTY-EON switching to occur, you should deactivate it in the menu by selecting “PTY off”. Press one of the AUDIO, SRC or BND buttons beforehand.

Please also read about this in the operating instructions in the section entitled “Programme type (PTY)” under “Radio mode”.

## **(FR) Remarque concernant la réception PTY EON**

Quand votre appareil Blaupunkt commute d'une émission de radio que vous êtes en train d'écouter à un autre programme radio ou d'une source (CD ou changeur CD) que vous avez choisie, assurez-vous d'avoir activé PTY (type de programme).

Si vous ne souhaitez pas cette commutation PTY EON, désactivez-la en sélectionnant « PTY off » dans le menu. Appuyez au préalable sur l'une des touches AUDIO, SRC ou BND.

Pour plus d'informations, reportez-vous également au paragraphe « Type de programme (PTY) » du chapitre « Mode radio » du mode d'emploi.

## **(IT) Nota sulla ricezione del PTY-EON**

Quando il vostro apparecchio Blaupunkt si sintonizza da un radioprogramma in ascolto ad un altro, oppure si disinserisce dalla fonte audio selezionata (CD o multilettores CD) e passa alla ricezione di un programma radio, controllate per favore se avete inserito la funzione PTY (tipo di programma).

Se volete evitare queste commutazioni PTY-EON, selezionate nel menu la funzione "PTY off". Prima di fare ciò premete uno dei tasti AUDIO, SRC o BND.

Leggete per favore a tale proposito quanto riportato nelle istruzioni d'uso nella sezione "Esercizio Radio" al punto "Tipo di programma (PTY)".

## **(NL) Aanwijzing bij de PTY-EON-ontvangst**

Wanneer uw Blaupunkt-apparaat van één beluisterde radiozender overschakelt op een andere, of van een gekozen geluidsbron (cd of cd-wisselaar) op een radiozender, kunt u controleren of u PTY (programmatype) hebt ingeschakeld.

Wanneer u geen prijs stelt op deze PTY-EON-omschakeling, schakelt u deze in het menu uit met "PTY off". Druk van tevoren op een van de toetsen AUDIO, SRC of BND.

Lees hiervoor ook in de gebruiksaanwijzing onder "Radioweergave" de alinea "Programmatype (PTY)".

## **(SW) Information om mottagning med PTY-EON**

Byter din Blaupunkt bilstereo självmant från inställt radioprogram eller spelad cd/cd-växlare till annat radioprogram? Då är möjligen funktionen Programtyp (PTY-EON) tillkopplad.

Om Du vill undvika detta, frånkopplar Du funktionen Programtyp (PTY-EON) i menyn. Tryck först på någon av knapparna AUDIO, SRC eller BND och välj sedan "PTY off".

För mer information, se avsnittet "Programtyp (PTY)" i bruksanvisningens kapitel "Radio".

## **(ES) Observaciones sobre la recepción PTY-EON**

Si su equipo Blaupunkt cambia de la emisora de radio que está escuchando a otra, o de la fuente de sonido seleccionada (CD o cambiadiscos) a una emisora de radio, verifique si tiene activada la función PTY (tipo de programa).

Si no desea que el equipo cambie automáticamente a emisoras PTY-EON, desactive dicha función seleccionando la opción "PTY off" en el menú. Pulse previamente una de las teclas AUDIO, SRC o BND.

Para más detalles, consulte el punto "Tipo de programa (PTY)" en el capítulo "Modo de radio" de las instrucciones de manejo.

## **(PT) Informação sobre a recepção no modo PTY-EON**

Se o seu aparelho mudar de um programa para outro programa ou de uma fonte que está a ouvir actualmente (CD ou CDC) para um programa radiofónico, verifique se a função PTY (tipo de programa) está activada.

Se não desejar usar a função PTY-EON, desactive-a no menu escolhendo a opção "PTY OFF". Prima anteriormente uma das teclas AUDIO, SRC ou BND.

Para tal, leia também o parágrafo "Tipo de programas (PTY)" no capítulo "Rádio" nas instruções de serviço.

## **(DK) Oplysning om PTY-EON-modtagelse**

Hvis din Blaupunkt radio slår fra det aktuelle radioprogram over i et andet eller fra en valgt kilde (CD eller Multi CD) over i et radioprogram, bør du tjekke om du har tændt for PTY (programtype).

Hvis PTY-EON-omsiftningen ikke ønskes, deaktiveres funktionen med "PTY off" i menuen. Forinden trykkes på en af tasterne AUDIO, SRC eller BND.

Læs også afsnittet om "Programtype (PTY)" under "Radiodrift" i betjeningsvejledningen.

## **(SF) PTY-EON-vastaanottoon liittyvä ohje**

Jos Blaupunkt-laite vaihtaa kuuntelemastasi radio-ohjelmasta toiseen radio-ohjelmaan tai valitsemastasi äänilähteestä (CD tai CD-vaihtaja) johonkin radio-ohjelmaan, tarkista onko PTY (ohjelmatyypin tunnustus) päällä.

Jos et halua laitteen vaihtavan radio-ohjelmaa automaattisesti PTY-EON-toiminnon avulla, voit kytkeä sen pois toiminnasta valikossa ("PTY off"). Paina ensin jotain painikkeista AUDIO, SRC tai BND.

Lue myös käyttöohjeen kohdasta "Radiokäyttö" kappale "Ohjelmatyypit (PTY)".

## **(PL) Wskazówki dotyczące odbioru PTY-EON**

Gdy urządzenie przełącza się z jednej stacji radiowej na inną lub z wybranego źródła audio (CD / zmieniacz CD) na odbiór programu radiowego, to należy sprawdzić, czy włączony program jest programem typu PTY.

Jeżeli nie chcą Państwo korzystać z funkcji PTY EON, to proszę w odpowiednim menu wybrać opcję „PTY off”. Przed wybraniem tej opcji trzeba wcisnąć jeden z przycisków AUDIO, SRC lub BND.

Dalsze informacje na ten temat znajdują Państwo w instrukcji obsługi w rozdziale „Tryb obsługi radia”, w punkcie „Typ programu (PTY)”.

## **(CZ) Upozornění k příjmu s funkcí PTY-EON**

Pokud se váš přístroj přepne ze stanice, kterou právě posloucháte, na jinou rozhlasovou stanici, nebo ze zvoleného zdroje (CD nebo měnič CD) na jiné rozhlasové vysílání, zkontrolujte, jestli není zapnutá funkce PTY (typ programu).

Pokud si nepřejete, aby došlo k přepínání přístroje funkcí PTY-EON, vypněte ji v nabídce bodem „PTY off“. Stiskněte nejprve jedno z tlačítek AUDIO, SRC nebo BND.

Bližší informace k tomuto bodu naleznete v návodu k obsluze v kapitole „Režim rádia“ v odstavci „Typ programu (PTY)“.

## **(HU) Utasítás a PTY-EON vételhez**

Ha az Ön Blaupunkt készüléke egy hallgatott rádióműsorról egy másik rádióműsorra vagy egy kiválasztott forrásról (CD vagy CD-váltó) egy rádióműsorra kapcsol át, úgy kérjük ellenőrizze, hogy bekapcsolta-e a PTY-t (műsortípus).

Ha Önnek nem megfelelő ez a PTY-EON átkapcsolás, kérjük, kapcsolja azt ki a menüben a „PTY off“-fal. Előtte azonban nyomja le az AUDIO, SRC vagy BND gombok egyikét.

Kérjük, ezzel kapcsolatban olvassa el a kezelési útmutató „Rádió üzemmód” fejezetében a „Műsortípus (PTY)” c. bekezdést.

## **(KR) Napomena uz PTY-EON-prijem**

Ako Vaš Blaupunkt uređaj prebacuje sa jednog radio-programa na neki drugi ili sa jednog izabranog izvora (CD ili CD-izmenjivač) na neki radio-program, onda molimo da proverite, da li ste uključili PTY (tip programa).

Ako ne želite ovo PTY-EON-prebacivanje, onda ga isključite u meniju sa „PTY off“. Prethodno pritisnite jednu od tipki AUDIO, SRC ili BND.

Molimo Vas, o tome pročitajte i u uputama za upotrebu pod „Rad radija” poglavlje „Tip programa (PTY)“.

## **(SE) Napomena uz PTY-EON-prijem**

Ako Vaš Blaupunkt uređaj prebacuje sa jednog radio-programa na neki drugi ili sa jednog izabranog izvora (CD ili CD-izmenjivač) na neki radio-program, onda molimo da proverite, da li ste uključili PTY (tip programa).

Ako ne želite ovo PTY-EON-prebacivanje, onda ga isključite u meniju sa „PTY off“. Prethodno pritisnite jedan od tastera AUDIO, SRC ili BND.

Molimo Vas, o tome pročitajte i u uputstvu za upotrebu pod „Rad radija” pasus „Tip programa (PTY)“.

## **(SK) Pokyny pre príjem PTY-EON**

Ak Váš prístroj Blaupunkt prepína z počúvaného rádioprogramu na iný rádioprogram alebo z niektorého zvoleného zdroja (CD alebo meniča CD) na iný rádioprogram, tak prosím skontrolujte, či ste zapnuli PTY (Program Type).

Ak nechcete toto prepínanie PTY-EON, vypnite ho v menu pomocou "PTY off". Stlačte pred tým niektoré z tlačidiel AUDIO, SRC alebo BND.

Prečítajte si prosím k tomu tiež v návode na obsluhu, pod "Rádiová prevádzka" odsek "Program Type (PTY)".

## **(SL) Navodilo za PTY-EON sprejem**

Ko se Vaša Blaupunkt naprava preklopi iz slušnega radijskega programa na drugi radijski program, oziroma iz izbrane zveze (CD ali CD-menjalca) na radijski program, Vas prosimo, da preverite, če ste vklopili PTY (programni-tip).

Če nočete preklon PTY-EON, potem priklopite le-tega v meniju na „PTY off“. Pritisnite pred tem na tipko AUDIO, SRC oziroma na BND.

Prosimo, da si preberete v navodilih za uporabo pod "radijo delovanje" odstavek "program-tip (PTY)".

## **(TR) PTY-EON yayını alınması ile ilgili bilgi**

Eğer Blaupunkt cihazınız dinlediğiniz bir radyo programından başka bir radyo programına veya seçmiş olduğunuz bir kaynaktan (CD veya CD değiştirici) bir radyo programına geçerse, PTY (program tipi) fonksiyonunu açmış olup olmadığını lütfen kontrol ediniz.

Eğer bu PTY-EON geçişini istemiyorsanız, bu fonksiyonu menü üzerinden "PTY off" ile kapatınız. Bu işlem den önce AUDIO, SRC veya BND tuşlarından birine basınız.

Lütfen bu konu ile ilgili olarak, kullanma kılavuzunda "Radyo modu" bölümündeki "Program tipi (PTY)" kısmını okuyunuz.

## **(GR) Υπόδειξη για τη λήψη PTY-EON**

Όταν η συσκευή σας Blaupunkt αλλάζει από ένα ραδιοφωνικό πρόγραμμα που ακούτε σε ένα άλλο ραδιοφωνικό πρόγραμμα ή από μια επιλεγμένη πηγή (CD ή τροφοδότης CD) σε ένα ραδιοφωνικό πρόγραμμα, τότε ελέγξτε παρακαλώ, εάν έχετε ενεργοποιήσει το PTY (τύπος προγράμματος).

Όταν δεν επιθυμείτε να έχετε αυτή την αλλαγή λειτουργίας PTY-EON, τότε απενεργοποιήστε την στο μενού με "PTY OFF". Πατήστε προηγουμένως ένα από τα πλήκτρα AUDIO, SRC ή BND.

Διαβάστε παρακαλώ γι' αυτό επίσης στις οδηγίες χειρισμού κάτω από "Λειτουργία ραδιοφώνου" την ενότητα "Τύπος προγράμματος (PTY)".



## **(RU) Указание по приемуPTY-EON**

При переключении тюнера аппарата Blaupunkt на другую радиостанцию или переключении с радиоприема на другой источник звука (проигрыватель CD или CD-чейнджер) проверьте, пожалуйста, включена ли функцияPTY (тип программы). Если Вы хотите отключить автоматический выбор программPTY-EON, то выключите эту функцию опцией меню "PTY off". Для этого нажмите одну из следующих клавиш – AUDIO, SRC или BND.

Ознакомьтесь, пожалуйста, с соответствующими инструкциями о включении автоматического режима выбора программ (PTY) в разделе "Прием радиопередач" пользовательской документации к Вашему аппарату Blaupunkt.

## Free Manuals Download Website

<http://myh66.com>

<http://usermanuals.us>

<http://www.somanuals.com>

<http://www.4manuals.cc>

<http://www.manual-lib.com>

<http://www.404manual.com>

<http://www.luxmanual.com>

<http://aubethermostatmanual.com>

Golf course search by state

<http://golfingnear.com>

Email search by domain

<http://emailbydomain.com>

Auto manuals search

<http://auto.somanuals.com>

TV manuals search

<http://tv.somanuals.com>