

Wireless Interface Module D8125INV

Operation and Installation Guide



1.0	Introduction.....	7
1.1	FCC Compliance Notice, Part 15.....	7
1.2	Other Literature Referenced	7
1.3	Documentation Conventions.....	7
1.3.1	Type Styles Used in this Manual	7
1.3.2	Tips, Important Notes, Cautions and Warnings.....	8
2.0	D8125INV Overview.....	9
2.1	Features	9
2.2	Specifications	9
2.2.1	Power.....	9
2.2.2	System Supervision.....	10
2.2.2.1	Watchdog.....	10
2.2.2.2	Self-Testing	10
2.3	D8125INV Inovonics Interface Module Point Expansion Description.....	10
2.4	D8125INV Back View.....	10
3.0	Installation	11
3.1	Mounting the D8125INV	11
3.2	Wiring the D8125INV to the Control Panel and FA400 Receiver	12
3.2.1	Setting the Jumper for a second receiver.....	13
3.3	D8125INV Quick Startup Recommendations.....	13
3.4	Labeling the Inovonics Transmitters	13
3.5	D8125INV Keypad Operation.....	14
3.5.1	Initial Power-Up	14
3.5.2	RF System OK.....	15
3.5.3	Call for Service	15
3.5.4	Factory Default Passcode.....	15
3.5.4.1	Entering Invalid Passcodes.....	15
3.6	D8125INV Menu Selections	16
3.6.1	Beginning steps to add/edit/delete an RF Transmitter	16
3.6.1.1	Point Mode	17
3.6.1.2	Menu 1: Add, Edit or Delete RF Transmitter	18
3.6.1.3	Adding a new RF Transmitter.....	18
3.6.1.3	Adding an existing RF Transmitter	20
3.6.1.4	Deleting an RF Transmitter	21
3.6.1.5	Programming the FA570/FA575 Repeater	21
3.6.1.6	Programming the FA113 Keyfob.....	22
3.6.1.7	Programming the D9412GV2, D7412GV2, D7212GV2, D9412G, D7412G, D7212G, D9412, D7412, D7212, and D9112 Control Panels for RF Transmitters	22
3.6.2	Menu 2: Change Installer Passcode	23
3.6.3	Menu 3: Set System ID	24
3.6.4	Menu 4: Clear EEPROM.....	25
3.6.5	Menu 5: Set RF System Supervision Interval.....	25
3.6.6	RF Diagnostics Function.....	26
4.0	Troubleshooting	29
4.1	FA400 Receiver Supervision	31
4.2	Missing Transmitters	31

D8125INV

Contents

4.3	Low Transmitter Battery Conditions.....	31
4.4	D8125INV Power Cycle Operation.....	32
4.5	Inovonics Frequently Asked Questions	32
4.5.1	What's the range of Inovonics Wireless transmitters?	32
4.5.2	What is the range of the Inovonics Wireless repeater?	32
4.5.3	What does the red decode LED/ light mean?.....	32
4.5.4	Does it matter what way I plug in the programming cable?.....	32
4.5.5	How can I get more range?.....	32
4.5.6	Why can't I program more than 1 transmitter per point?	32
4.5.7	Are your transmitters weatherproof?.....	32
4.5.8	What is temperature range for good operation?.....	33
4.5.9	Can I externalize an antenna?.....	33
4.5.10	Does each transmitter need a repeater?.....	33
5.0	D8125INV Program Sheet	35

Figures

Table 1: Update Kit Part Numbers	7
Table 2: Other Literature Referenced	7
Table 3: D8125INV Specifications.....	9
Table 4: FA400 Specifications	9
Figure 1: D8125INV Back View	10
Figure 2: Choosing a Knockout for Wiring Routing (D8103 enclosure shown)	11
Figure 3: Mounting the D8125INV base	11
Figure 4: D8125INV to D9412GV2/D9412G/D9412/D9112 Control Panel Wiring Diagram	12
Figure 5: D8125INV to D7412GV2/D7212GV2/7412G/D7212G/D7412/D7212 Control Panel Wiring	13
Figure 6: Tab to expose keypad.....	14
Figure 7: D8125INV Keypad.....	14
Table 5: Key Descriptions.....	14
Figure 8: Initializing screen	14
Figure 9: System Defaulted Display	14
Figure 10: RF System Normal	15
Figure 11: Call for Service	15
Figure 12: Invalid code display	15
Figure 13: Invalid code, Keypad locked display	15
Figure 14: D8125INV Menu Selections.....	16
Table 6: Recommended Mode Values.....	17
Figure 15: RF Transmitter status	18
Figure 16: Connecting cable to D8125INV	20
Figure 17: Connecting cable to transmitter.....	20
Figure 18: Point Number Status	27
Figure 19: RF Point not programmed	27
Figure 20: Call for Service, Enter Code + ENT	31
Figure 21: Call for Service, Receiver Missing	31
Figure 22: Call for Service, Enter Code + ENT	31
Figure 23: Call for Service, Receiver Missing	31

Tables

Table 1: Update Kit Part Numbers 7
Table 2: Other Literature Referenced 7
Table 3: D8125INV Specifications..... 9
Table 4: FA400 Specifications..... 9
Table 5: Key Descriptions..... 14
Table 6: Recommended Mode Values 17

Notes:

1.0 Introduction

This guide covers the installation of the D8125INV Wireless Interface Module for Inovonics Transmitters. The D8125INV is an interface module that allows the connection of an Inovonics FA400 Receiver and compatible transmitters. The D8125INV may be used with the following control panels: D9412G, D7412G, D9412GV2, D7412GV2, D9412, D9112, D7412, and D7212.

Control Panel Firmware Revision Requirements: The control panels listed in Table 1 must have firmware version 6.30 or higher. If you need to upgrade the control panel firmware of a currently installed system, order the following Update Kits from Bosch Security Systems Order Processing:

Control Panel	Update Kit Part Number
D9412G, D9412	D9499-0650 or higher
D9112	D9199-0650 or higher
D7412G, D7412	D7499-0650 or higher
D7212	D7299-0650 or higher
D9412GV2	All Revs
D7412GV2	All Revs
D7212GV2	All Revs

Table 1: Update Kit Part Numbers

1.1 FCC Compliance Notice, Part 15

This equipment has been tested and found to comply with the limits for a Class B digital device, pursuant to Part 15 of the FCC Rules. These limits are designed to provide reasonable protection against harmful interference in a commercial installation. This equipment generates, uses, and can radiate radio frequency energy, and, if not installed in accordance with the instructions, may cause harmful interference to radio communications. However, there is no guarantee that interference will not occur in a particular installation. If this equipment does cause harmful interference to radio or television reception, which can be determined by turning the equipment on and off, the user is encouraged to try to correct the interference by one or more of the following measures:

1. Reorient or relocate the receiving antenna.
2. Increase the separation between the equipment and the receiver.
3. Connect the equipment into an outlet on a circuit different from that to which the receiver is connected.
4. Consult the dealer or an experienced radio/TV technician for help.

1.2 Other Literature Referenced

Throughout this manual, references will be made to other documentation. See the following table for the documents referenced in this manual, which lists the complete part number for ordering purposes.

Name of document	Part Number
D9412G/D7412G/D9412GV2/D7412GV2 Program Entry Guide	47775
D9412G/D7412G/D9412GV2/D7412GV2 Operation and Installation Manual	43488

Table 2: Other Literature Referenced

1.3 Documentation Conventions

These conventions are intended to call out important features, items, notes, cautions, and warnings that the reader should be aware of in reading this document.

1.3.1 Type Styles Used in this Manual

To help identify important items in the text, the following type styles are used:

Bold text	Usually indicates selections that you may use while programming your control panel. It may also indicate an important fact that should be noted.
<i>Bold Italicized</i>	used to denote notes, cautions and/or warnings
<i>Italicized text</i>	Is used to reference the user to another part of this manual or another manual entirely. It is also used to symbolize names for records that the user will create.
Courier Text	Text that appears like this indicates what may appear on the D5200 Programmer display, keypad, or internal printer.
[CAPITALIZED TEXT]	Text like this is used to indicate to the user that a specific key should be pressed. Example: ...press the [ESC] key...

Introduction

1.3.2 Tips, Important Notes, Cautions and Warnings

Throughout this document, helpful tips, important notes, cautions and warnings will be presented for the reader to keep in mind. These appear different from the rest of the text as follows:



Important Notes - should be heeded for successful operation and programming. Also tips and shortcuts may be included here.



Caution - These caution the operator that physical damage to the program and/or equipment may occur.



Warning - These warn of the possibility of physical damage to the operator, program and/or equipment.

2.0 D8125INV Overview

2.1 Features

- Compatible with Bosch Security Systems D9412GV2, D7412GV2, D7212GV2, D9412G, D7412G, D7212G, D9412, D7412, D7212, and D9112 Control Panels. (FA113 can not be used on the D7212GV2 and D7212G panels)
- Menu driven User Interface
- On the D9412GV2, D9412G, D9412, and D9112, the D8125INV supports up to 2 Inovonics FA400 Receivers (with a maximum of 238 transmitters [119 per bus])
- On the D7412GV2, D7412G, and D7412, the D8125INV supports up to 2 Inovonics FA400 Receivers (with a maximum of 67 transmitters)
- On the D7212GV2 and D7212G, the D8125INV supports up to 2 Inovonics FA400 Receivers (with up to 32 transmitters in the same location).
- An unlimited number of FA113 Wireless Keyfobs can be added
- Used for diagnostic functions to troubleshoot system RF Transmitters
- Programmable system-wide supervision time interval and individual transmitter check-in time
- Programmable transmitter configuration (Normally Open/Normally Closed, Internal/External Contact, EOL Resistor)

2.2 Specifications

User Interface:	LCD Display	2 lines by 16 characters, Backlit
	Keypad	0 – 9 numbers ESC, ENT, PREV, NEXT and DIAG keys
Operating Voltage:	10.2 - 14 VDC supplied by Aux Power from Control Panel or an External Auxiliary Power Supply.	
Current:	30 mA typical, 45 mA maximum plus ≈ 40 mA for each FA400 receiver	
Operating Temperature:	+32°F to +149°F (0°C to +65°C), 93% Relative Humidity	
Wiring:	18 AWG or 22 AWG Solid or Stranded. Maximum distance from control panel cannot exceed 5 ft. (1.5 m).	
Dimensions (HxWxD):	3.94 in. x 6.5 in. x 1.2 in. (10 cm x 16.6 cm x 3 cm)	
Weight:	8.6 oz. (243 g)	

Table 3: D8125INV Specifications

Operating Voltage:	10.2 VDC to 14 VDC
Current:	40 mA Max.
Wiring:	18 AWG or 22 AWG Solid or Stranded. Maximum distance from D8125INV to FA400 cannot exceed 200 ft. (61 m) or 1000 ft. (305 m) with power supply.

Table 4: FA400 Specifications

2.2.1 Power



If the D8125INV is powered down and then back up, it may take up to a maximum of 5 minutes (up to 15 minutes for 5 minute Transmitter Check-In Time) for all the transmitters to report back to the D8125INV with their current status. On systems employing fewer transmitters, this time is reduced proportionately.

In addition, when the D8125INV is powered up, all programmed RF points will report Normal until their state is updated.

The D8125INV power should be connected to the control panel using the Aux Power terminals. If the D8125INV were to lose power, the following conditions may result:

- All RF points will report to the control panel as missing (trouble/alarm)

D8125INV

Overview

- All RF points will initialize in a normal state when power is reapplied
- Alarms initiated prior to power loss would be reset. If the alarm conditions persist when power is restored, new alarms would be generated.

Note: Programmed settings such as RF point configuration and System ID will remain intact upon the event of a power loss.

2.2.2 System Supervision

2.2.2.1 Watchdog

The D8125INV implements a watchdog software. Failure of the program will result in a software reset within two seconds. This may cause a trouble condition on the control panel for the duration of the reset.

2.2.2.2 Self-Testing

The D8125INV EEPROM memory is automatically tested on a periodic basis. The EEPROM checksum is verified every ten minutes. If the EEPROM checksum fails, a point bus trouble condition will be seen at the control panel.

2.3 D8125INV Inovonics Interface Module Point Expansion Description

Using two D8125INVs, you can program up to 238 (119 per bus) Inovonics Wireless Transmitters to the system on the D9412GV2, D7412GV2, D9412G, D7412G, D9412, D7412, D7212, and D9112 allow up to 67 Inovonics Wireless Transmitters, and D7212GV2 and D7212G allow up to 32 Inovonics wireless transmitters.

The D8125INV is an integrated interface module and keypad. The keypad is used to access the programming, and diagnostic functions of the wireless portion of the system. The integrated keypad on the D8125INV is physically different looking from the typical keypads (D1255, D1256, D1257, and so on) so that it will not be mistaken for a system keypad. When mounting the D8125INV, it must be within 5 feet (of the control panel). It has been designed such that it should be mounted right next to the D8103, D8108A or D8109 enclosure.

The D9412GV2, D7412GV2, D7212GV2, D9412G, D7412G, D7212G, D9412, D7412, D7212, and D9112 Control Panels can have both hardwired (D8128D OctoPOPITS, D8125 Popex / D9127 POPITS, D8125MUX) and wireless points connected at the same time.

To add wireless points, an Inovonics FA400 Receiver must be connected to the D8125INV which is then connected to the control panel's Zonex 1 (and/or Zonex 2) terminals and Aux Power. For best transmitter reception results, the FA400 should be centrally located among the transmitters. If transmitters are at too great of a distance for the FA400 Receiver to pick up the transmission, an Inovonics RF Repeater may be installed.

2.4 D8125INV Back View

See Figure 1 for areas of importance on the D8125INV,

1. Programming Jack (Access using front panel)
2. EPROM Socket – contains EPROM with encoded software
3. Sounder to indicate valid and invalid entry via the keypad
4. 4-Wire Zonex Power Panel Connection Terminal Strip
5. FA-400 Receiver Terminal Strip
6. LCD Contrast Adjustment

The D8125INV provides connection to a control panel using a Zonex 4-wire interface and to a FA-400 Receiver via a 3-wire interface.

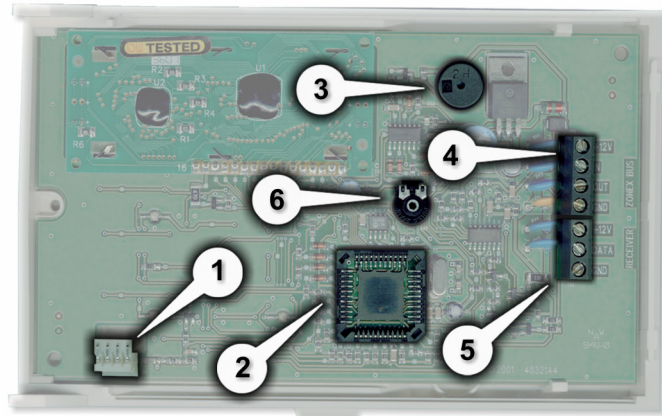

Figure 1: D8125INV Back View

3.0 Installation



The D8125INV is packaged with a Point Label Sheet. Save these, as you will use them when identifying the point numbers on the Inovonics transmitters.

3.1 Mounting the D8125INV

1. Select the knockout from the control panel enclosure that will be used to route the wiring.
2. Select the location from which the Inovonics FA400 Receiver wiring will be routed.

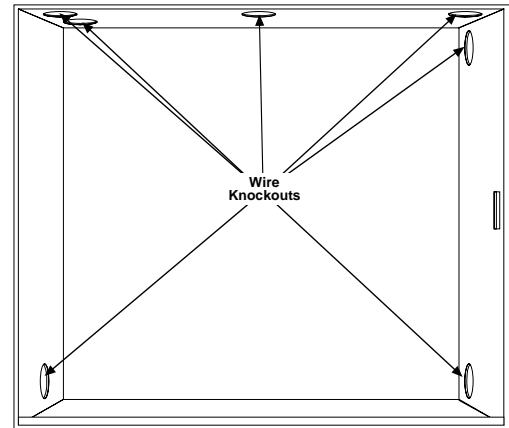

Figure 2: Choosing a Knockout for Wiring Routing (D8103 enclosure shown)

3. Remove the base of the D8125INV and use the screws provided with the unit to mount it adjacent to the control panel.
4. Connect the wiring (see Section 3.2 *Wiring the D8125INV to the Control Panel and FA400 Receiver*) to the D8125INV and mount the cover unit to the base.

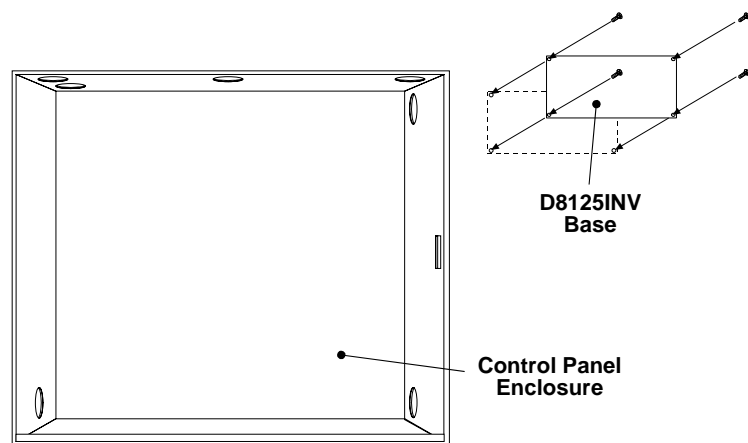

Figure 3: Mounting the D8125INV base

D8125INV

Installation

3.2 Wiring the D8125INV to the Control Panel and FA400 Receiver

The Inovonics FA400 Receiver may be located up to 200 ft. (61 m) from the D8125INV. If the installation requires the receiver to be mounted farther than this, an external power supply is required. The maximum distance in any case is 1000 ft. (305 m). For optimal mounting instructions, please refer to the instructions supplied by Inovonics.

If an external power supply is used to power the FA400 Receiver, you must:

- connect the negative terminal wire of the external power supply to the GND terminal of the D8125INV and the GND terminal of the FA400.
- if Ground Fault Detect is enabled on the D9412GV2, D9412G, D7412GV2, or D7412G, use a Ground Isolated Power Supply.

Certain installation configurations may require a second FA400 Receiver (see Section 3.2.1 *Setting the Jumper for a second receiver*, p.13.)



Disconnect all power to the Control Panel and to the D8125INV before beginning any work with the internal components.

Refer to Figure 4 and Figure 5 for the proper wiring connections.

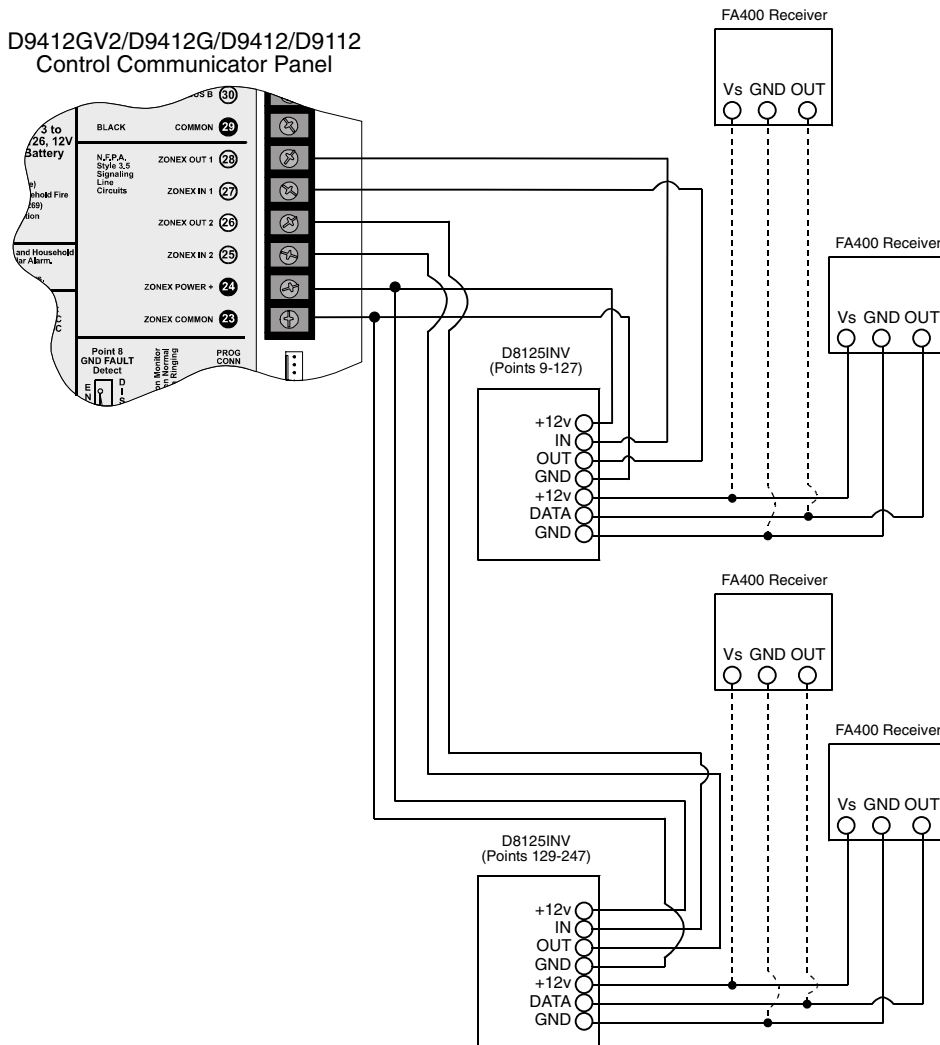

Figure 4: D8125INV to D9412GV2/D9412G/D9412/D9112 Control Panel Wiring Diagram

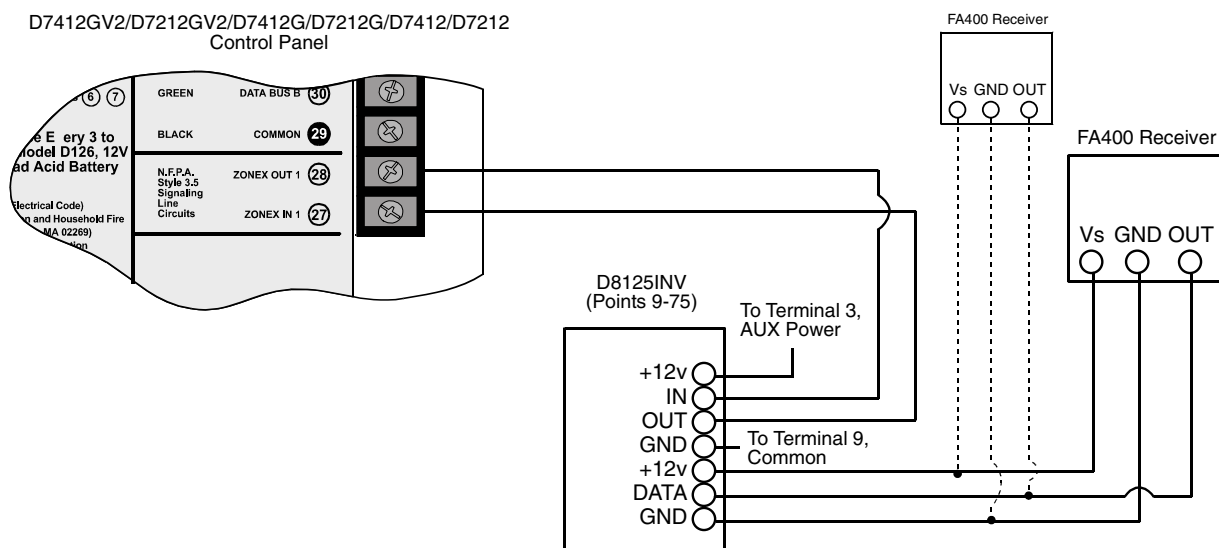

Figure 5: D8125INV to D7412GV2/D7212GV2/7412G/D7212G/D7412/D7212 Control Panel Wiring

3.2.1 Setting the Jumper for a second receiver

If the application requires a second FA400 receiver (for example having one receiver on the north side of a large warehouse and another receiver on the south side of the warehouse), which is typically used for better coverage, follow the steps below to set up the second FA400 receiver with one D8125INV.

To correctly set the jumper on the FA400 receiver, follow the steps below:

1. Remove the cover of the FA400 receiver.
2. Locate the jumper switch located above the reset button.
3. The FA400 Receiver is shipped with the jumper set for 1 receiver.
4. To set the FA400 Receiver to act as a second receiver, position the jumper to cover the middle and right pin.

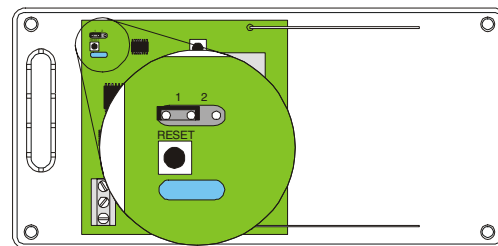
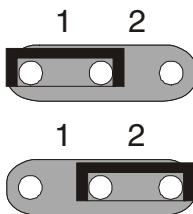

Note: If two receivers are being used and the one receiver goes missing, a 'Receiver Missing' message will NOT be reported since the other receiver is still being seen by the D8125INV, however, the points using it will go missing after the programmed supervision time.

3.3 D8125INV Quick Startup Recommendations

The following information details the recommended programming steps that should be taken when installing a D8125INV in a new installation.

1. Go to Menu 2 and change the Installer Passcode, if necessary (see Section 3.6.2 *Menu 2: Change Installer Passcode*, p.23).
2. Proceed to Menu 1 to begin adding RF Transmitters to the system (see Section 3.6.1.2 *Menu 1: Add, Edit or Delete RF Transmitter*, p.18).
3. Use the [DIAG] key for testing the system during and after installation.

3.4 Labeling the Inovonics Transmitters

Prior to programming the Inovonics transmitters or D8125INV, it is recommended that you take the time now to apply the point number labels from the Point Label Sheet to the individual transmitters.

D8125INV

Installation

3.5 D8125INV Keypad Operation

To access the keypad on the D8125INV, simply open the door by gently pulling on the tab on the bottom center of the keypad (Figure 6).

The keypad of the D8125INV is comprised of the following (see Figure 7: D8125INV Keypad):

1. LCD Display
2. Keys (see Table 5)
3. Transmitter Programming Jack



Figure 6: Tab to expose keypad

Key	Description
ESC	Escape – Backs out of a programming option or menu level.
ENT	Enter – Accepts a program entry.
PREV	Manually scrolls to a previous menu or point selection. This key will also stop the auto-scrolling of the menus.
NEXT	Manually scrolls to the next menu or point selection. This key will also stop the auto-scrolling of the menus.
DIAG	Shortcut to RF Diagnostics menu (see Section 3.6.6 RF Diagnostics Function, p.26)

Table 5: Key Descriptions

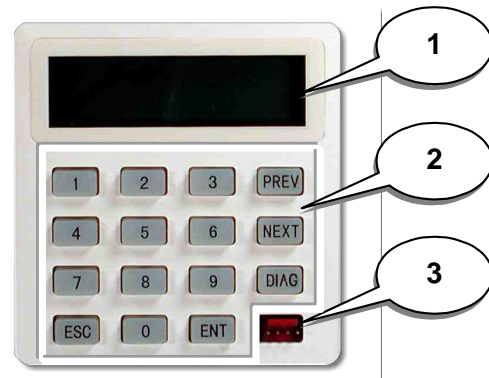

Figure 7: D8125INV Keypad



Single beep indicates entry is acknowledged, two beeps indicate valid entry and three beep tones indicate an input error has been made.

3.5.1 Initial Power-Up

When the D8125INV is powered up for the first time from the factory, it will display Figure 8 for approximately 3 seconds before displaying idle text (Figure 9, Figure 10 or Figure 11).

The “System”, in this case, is the D8125INV.

Note: *The Version 01.01 and System ID of 123 is only used here for an example. The actual Version and System ID number may be different.*

After that, Figure 9 will appear if no transmitters are programmed into the D8125INV, Figure 10 will appear if one or more transmitters are already programmed in the D8125INV and are not missing, or Figure 11 will be displayed if the D8125INV has a system fault.



Figure 8: Initializing screen



Figure 9: System Defaulted Display

3.5.2 RF System OK

If the system is OK, Figure 10 will appear.



Figure 10: RF System Normal

3.5.3 Call for Service

If one of the following conditions occurs, Figure 11 will appear.

- EEPROM Failed
- Receiver Missing
- Programmed RF Points Missing

see Section 4.0 *Troubleshooting*, p.29 for more information.



Figure 11: Call for Service

3.5.4 Factory Default Passcode

The D8125INV contains a single passcode. To access the functions in the D8125INV, this passcode must be entered first. The default passcode loaded at the factory is 123456 + [ENT]. This passcode may be changed at any time from within programming mode. To enter the default passcode, press 123456 + [ENT].

3.5.4.1 Entering Invalid Passcodes

If an invalid passcode is entered, the D8125INV keypad will display Figure 12. If an invalid passcode is entered 4 times in row, the keypad will display Figure 13.

The D8125INV will disallow any further entries for 5 minutes, unless power is cycled to the unit.



Figure 12: Invalid code display



Figure 13: Invalid code, Keypad locked display

Installation

3.6 D8125INV Menu Selections

After the passcode is entered and the [ENT] key is pressed, the first of the following menus are displayed with each menu displayed for three seconds before the next one is displayed.



Figure 14: D8125INV Menu Selections

To select a function, press the corresponding number or function key displayed. This menu scrolls for 5 minutes. After 5 minutes the display returns to showing idle text if no keypad activity is detected.



It is highly recommended that a walk test be performed after all programming is completed.

3.6.1 Beginning steps to add/edit/delete an RF Transmitter

Follow the steps below to begin the process of adding a new or existing RF transmitter:

1. From the Idle Text screen, enter the passcode and press [ENT] to access the main menu.



2. Press 1 to add or edit an RF Transmitter (RF Xmtr).



3. Enter the point number and press [ENT]



4. At the Transmitter point status screen, do the following depending on the desired action:

To edit mode (see Section 3.6.1.1 *Point Mode*) and/or check-in time for new transmitters, press 1 and see Section 3.6.1.3 *Adding a new RF Transmitter*, p. 18 or to reprogram existing transmitters, see Section 3.6.1.3 *Adding an existing RF Transmitter*, p.20.

To delete a transmitter from the D8125INV, press 2 and see Section 3.6.1.4 *Deleting an RF Transmitter* p.21.

3.6.1.1 Point Mode

The Point Mode setting determines whether:

- the transmitter is a burg point or fire point,
- Normally Open or Normally Closed contacts are used,
- the Internal and/or external contacts are used, and
- end of line resistors are used on the external contacts.

This applies to RF Transmitters that have external contacts and/or internal magnetic contacts (see Table 7).

Inovonics Transmitter	Mode	External Contact			Internal Contact	Fire Point
		Normally Open	Normally Closed	End of Line Resistor (use 2.2 K ¼ Watt)		
FA210 Reduced Size Universal	1		✓	✓		
	2		✓			
	3	✓		✓		
FA210W	4	✓				
	6	✓			✓	
FA250 High Power Universal	7	✓		✓	✓	
	8		✓	✓		✓
FA210BN	9		✓			✓
	10	✓		✓		✓
FA210WBN	11	✓				✓
	5				✓	
FA210W & FA210WBN Reduced Size "Wide-Gap" Universal	12				✓	✓

Inovonics Transmitter	Mode
FA113 Keyfob (see Section 3.6.1.6 Programming the FA113 Keyfob, p. 22)	4
FA202 Photoelectric Smoke Detector	9
FA203S/D Necklace Pendant	4
FA204 Pendant	4
FA205S/FA205D Belt Clip/Loop	4
FA206 ALL	2
FA207 Glassbreak	4
FA209 Billtrap	4
FA216L/H Low Temperature/High Temperature	4
FA223S/D Single/Double Button Water Resistant Pendant	4
FA570 High Power Indoor Repeater FA575 High Power Outdoor Repeater	4

Table 6: Recommended Mode Values

Installation

3.6.1.2 Menu 1: Add, Edit or Delete RF Transmitter

This menu is used to add/edit/delete RF transmitters to the D8125INV and to configure them.

The display for adding, editing or deleting an RF Transmitter is the same.

Figure 15 shows an example of the display.

1. The point address of the RF Transmitter.
2. The mode the RF Transmitter is in (see Section 3.6.1.1 *Point Mode*, p.17 for more information).
3. The current check-in selection for that specific RF Transmitter (see Section 3.6.1.3 *Adding a new RF Transmitter*, p.18).
4. This line is used to display the key options for this transmitter (see Section 3.6.1.3 *Adding a new RF Transmitter*, p.18).
 <command scroll> = “Push 1 to edit” displays for 3 seconds, “2 to delete” displays for 3 seconds, “3 to program” displays for 3 seconds or “ESC to exit” displays for 3 seconds



Figure 15: RF Transmitter status

Function	Used When...	For more information...
Adding new	<ul style="list-style-type: none"> • adding new transmitter(s) • programming transmitter(s) and adding to D8125INV • to change mode and/or check-in time of transmitter(s) 	Section 3.6.1.3 <i>Adding a new RF Transmitter</i> , p.18
Adding existing	<ul style="list-style-type: none"> • adding the point to D8125INV without reprogramming the transmitter(s) • replacing the D8125INV without reprogramming the transmitter(s) 	Section 3.6.1.3 <i>Adding an existing RF Transmitter</i> , p.20
Deleting	<ul style="list-style-type: none"> • deleting transmitter(s) from the D8125INV 	Section 3.6.1.4 <i>Deleting an RF Transmitter</i> , p.21

Table 7: RF Transmitter options

3.6.1.3 Adding a new RF Transmitter

To add an RF transmitter, follow the steps below:

1. Complete the steps in Section 3.6.1 *Beginning steps to add/edit/delete an RF Transmitter*, p.16.
2. After the point number has been entered, the keypad will display:

Note: *By default, all new points being added will be assigned Mode 4 and have a check-in time of 1 minute.*

3. Push [1] to edit the transmitter if the displayed values need to be modified. If not, proceed to step 8.



4. The display will change to the following:

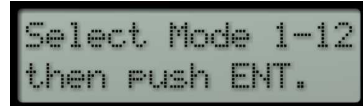

5. To set the point mode of the RF Transmitter, see Section 3.6.1.1 *Point Mode*, p.17 for information on selectable Point Modes.

6. After the Mode is selected, the keypad will display the available check-in time selection of either 1 minute (by pressing [1] + [ENT]) or 5 minutes (by pressing [2] + [ENT]).



Push 1 + ENT for
1 min. check-in.

Enter the desired check-in time and press [ENT].

The check-in time is a supervisory signal that is sent from each transmitter at this interval. Each transmitter shipped from Inovonics comes defaulted with a 1 minute check-in time. To extend battery life of the transmitter, this entry may be set to the 5 minute interval. For fire, set the entry to one minute.



Push 2 + ENT for
5 min. check-in.

7. After the check-in time is entered, the D8125INV will display the following.



Pt015: M04, 1min
Push 1 to edit,



Pt015: M04, 1min
2 to delete,



Pt015: M04, 1min
3 to continue,



Pt015: M04, 1min
or ESC to exit,

8. Push [3] to continue adding the transmitter



Pt015: M04, 1min
3 to continue,

9. The keypad displays two options:

- Push [1] for a new transmitter
- Push [2] for an existing transmitter



Push 1 for new
xntr.



Push 2 for
existing xntr.

10. Press [1] on the keypad



Push 1 for new
xntr.

11. When the keypad displays,



Connect Xntr and
press reset btn

Installation

- a. Connect the 4-pin end of the programming cable (P/N 50576) to the programming jack on the D8125INV.

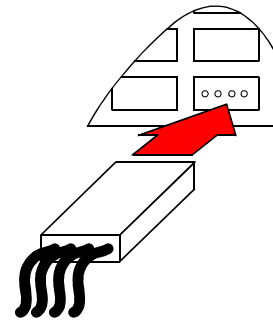

Figure 16: Connecting cable to D8125INV

- b. Remove the cover of the RF Transmitter.
- c. Connect one end of the programming cable to the three-pin connector on the transmitter.

Orientation of the connector to the transmitter pins is not important.

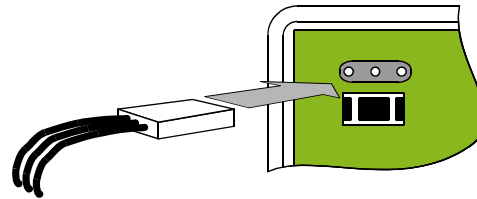
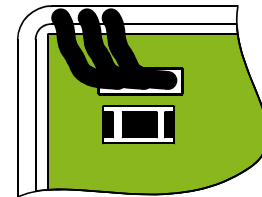

Figure 17: Connecting cable to transmitter

All transmitters will have the same 3-pin programming header (connector)

12. Press the reset button on the transmitter.



13. Once the information is programmed correctly into the transmitter, the keypad display will show briefly.

If transmitter is not connected to the D8125INV within 5 minutes or the transmitter was unable to accept the information, a 3-beep error tone will occur and the keypad will display:



Note: *The point number of the transmitter will automatically increment.*

14. Disconnect the programming cable from the transmitter and the D8125INV.
15. Record the point information on the D8125INV Program Record Sheet (see Section 5.0 *D8125INV Program Sheet*, p.35) and on the transmitter point label before proceeding to the next transmitter.

3.6.1.3 Adding an existing RF Transmitter

It may be necessary to take an already installed transmitter and add it again to the D8125INV (especially if the D8125INV is damaged and needs to be replaced). In this case, the RF transmitters can be added to the D8125INV without having to manually connect each transmitter to the D8125INV. The Mode and Check-in time are programmed into the transmitters, not the D8125INV. This option can only be used when replacing a D8125INV.



If changing the mode or check in time or replacing another manufacturer's interface, program as a new transmitter.

Refer to the D8125INV Program Record Sheet (see Section 5.0 *D8125INV Program Sheet*, p.35) for mode and check-in time when replacing the D8125INV.



Do not program any other transmitters for Points 74 and 75 or Points 194 and 195. These are for the FA113 Keyfobs only.

To add an existing RF Transmitter, follow the steps below:

1. Complete the steps in Section 3.6.1 *Beginning steps to add/edit/delete an RF Transmitter*, p.16.
2. After the point number has been entered, the keypad will display:

```
Pt015: M04, 1min
Push 1 to edit,
```

3. Push [3] to continue adding the transmitter

```
Pt015: M04, 1min
3 to Program,
```

4. The keypad displays two options:
 - Push [1] for a new transmitter
 - Push [2] for an existing transmitter

```
Push 1 for new
xmtr.
```

5. Press [2] on the keypad.

```
Push 2 for
existing xmtr.
```

6. The keypad displays the following:

```
Pt015 added.
```

Note: *The point number of the transmitter is automatically incremented.*

7. Record the point information on the D8125INV Program Record Sheet (see Section 5.0 *D8125INV Program Sheet*, p.35) before proceeding to the next transmitter.

3.6.1.4 Deleting an RF Transmitter

To delete a programmed RF Transmitter, follow the steps below:

1. Complete the steps in Section 3.6.1 *Beginning steps to add/edit/delete an RF Transmitter*, p.16.
2. After the point number has been entered, the keypad display will display:

```
Pt015: M04, 1min
Push 1 to edit,
```

3. Push [2] to delete the transmitter.

```
Pt015: M04, 1min
2 to delete,
```

4. The selected point is deleted and the keypad beeps twice and displays the following for 3 seconds.

```
Pt015 deleted.
```

Note: *The point number of the transmitter is automatically incremented.*

3.6.1.5 Programming the FA570/FA575 Repeater

If it is necessary to install a FA570/FA575 Repeater into this system, it must be programmed as an RF point. However, the Repeater will only send Low Battery Reports and Tamper Reports. The same procedure for adding an RF Transmitter (see Section 3.6.1.3 *Adding a new RF Transmitter*, p.18) is used to add the FA570/FA575 Repeater. The recommended check-in time interval should be set for 5 minutes. For further information please refer to the Inovonics FA570 or FA575 Installation Instructions.

Installation

3.6.1.6 Programming the FA113 Keyfob

An unlimited number of FA113 Keyfobs can be added to a system in the same location. However, the system is not capable of differentiating the keyfobs. The D8125INV does not supervise Low Battery or Missing conditions for any of the Keyfobs. The FA113 Keyfob is treated as a Maintained Keyswitch on D9412GV2, D7412GV2, D9412G, D7412G, D9412, D7412, D7212, and D9112 Control Panels. When using both arming/disarming and alert functions of the keyfob, Points 74 and 75 (for Zonex Bus 1 on D9412GV2, D7412GV2, D9412G, D7412G, D9412, D7412, D7212, and D9112 Control Panels) and Points 194 and 195 (for Zonex Bus 2 on D9412GV2, D9412G, D9412, and D9112 Control Panels) are used.



Do not program any other transmitters for Points 74 and 75 or Points 194 and 195. These are for the FA113 Keyfobs only.

The FA113 Keyfob has four buttons: ON, OFF, and two Alert (*) buttons. The ON button is used to arm the area the point is assigned to and initiate the Master Arm Delay state. The OFF button is used to disarm the area to which the point is assigned.

The Point Index for Point 74 and 194 must be programmed as a Point Type 4 with a Point Response of 2.

When both Alert buttons are pressed, the D8125INV sends a Short to the control panel for Point 75 or 195. Program the control panel accordingly so that the Point Response provides the appropriate response. To clear the condition from Point 75 or 195, press the ON or OFF button.

To program an FA113 keyfob, connect the programming cable to the transmitter and program the lower numbered point (74 or 194) as a new transmitter and select mode 4. Disconnect the programming cable and program the higher numbered point (75 or 195) into the D8125INV as an existing transmitter and select mode 4. This will enable both points on the keyfob.

3.6.1.7 Programming the D9412GV2, D7412GV2, D7212GV2, D9412G, D7412G, D7212G, D9412, D7412, D7212, and D9112 Control Panels for RF Transmitters

Regardless of the mode that is programmed into each transmitter (Normally Open, Normally Closed), the D8125INV will send back to the control panel the responses shown in Table 8.

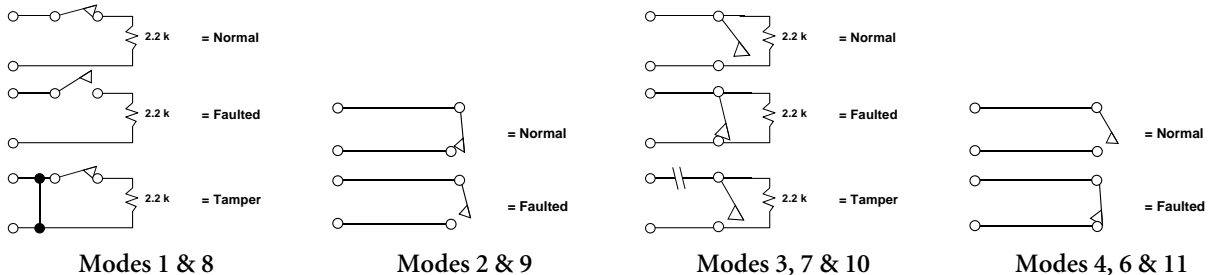

If the RF Transmitter sends...	D8125INV sends to the control panel...
a Faulted condition	Shorted condition
a Tamper condition	Open condition
a Normal condition	Normal condition
a Low Battery condition (see note)	Low Battery condition

Table 8: D8125INV Point Transition Reporting to D9412, D9112, D7412, and D7212 Control Panels

Note: Only D9412G, D7412G, D7212G, D9412, D7412, D7212, and D9112 Control Panels, Version 6.50 and higher, are able to send RF BATTERY LOW events. See the D9412G/D7412G Program Entry Guide (P/N: 47775) for information on programming RF BATTERY LOW events in the Routing section. The D9412GV2, D7412GV2, and D7212GV2 can use any revision. In addition, RPS Version 3.6 and 9000MAIN Handler Version 1.13 or higher must be used to enable this event.

Based on the information in Table 8, please follow the recommended programming guidelines for Point Type and Point Response shown in Table 9.

If both a Tamper and Fault condition occur, the Tamper condition takes priority over the Fault condition and an open condition is sent to the control panel.

Therefore, Bosch Security Systems recommends the following:



- Controlled points be programmed as ‘Instant alarm on Open’ when armed and ‘Trouble’ when disarmed.
- 24 Hour points be programmed as ‘Instant alarm on Open’
- Fire points be programmed as ‘Trouble on Open’

An Open condition on the control panel signifies a Tamper while a Short condition is considered a Fault.

Inovonics Transmitter	Fire (Fire Point = Yes)		Burg			
	Point Type	Point Response	24 Hour		Controlled	
			Point Type	Point Response	Point Type	Point Response
FA113 -- Pt 74 and 194 only	n/a		4	2	n/a	
FA113 – Pt 75 and 195 only	0	1,9	0	1,9	1,2,3	0,1,6,7,E
FA202			n/a			
FA203S/D*	n/a		0	1,9	1,2,3	0,1,6,7,E
FA204*						
FA205S/FA205D*						
FA206I/S			n/a		2,3	
FA206DS						
FA207						
FA209*						
FA210W	0	1,9	0	1,9	1,2,3	
FA210						
FA216L/H						
FA223S/D	n/a					
FA250	0	1,9				
FA570/FA575	n/a		3		n/a	

* = Devices can be programmed as 24 Hour or Controlled Point depending on the application

Table 9: Recommended Point Types/Point Responses

3.6.2 Menu 2: Change Installer Passcode

Note: If the installer’s passcode is lost, you must send the D8125INV to Bosch repair for defaulting.

Shipped from the factory, the D8125INV passcode is 123456. To change this passcode, follow the steps shown below:

1. From the Main Menu, press [2]. The keypad will display:.....

Enter the current passcode.



Note: Each digit of the passcode will appear as a *.

If the passcode entered does not match the existing passcode, a 3-beep error tone will occur and the keypad will display:



Then you will return to the Main Menu.

After a valid passcode is entered, the keypad will display:.....

Enter a new 6-digit passcode.



Installation

The keypad should now display:.....

Again, enter the new 6-digit passcode.

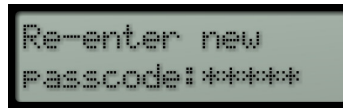

If the passcodes match, the keypad will display:



If a mistake was made and the passcodes do not match, a 3-beep error tone will occur and the keypad will display:



Then you will return to the Main Menu.

To exit out of this menu, simply press the [ESC] key.

3.6.3 Menu 3: Set System ID

The System ID is a 3-digit number (0-255) that is programmed into each transmitter and D8125INV. In installations that require two D8125INV Interface Modules, the System ID stored in the D8125INV's *must be different*. This ensures that the transmitters will report back to the correct D8125INV.

From the factory, the D8125INV will come preprogrammed with a random System ID that ranges from 0-255. To modify the System ID, follow the steps shown below.

1. From the Main Menu, press the [ENT] key. The keypad will display:

Note: 123 is used here as an example. The actual System ID may vary.

followed by:



2. Press [ENT]. The keypad displays:.....

Enter the new 3-digit System ID. If the System ID does not fall within the range of 0-255, a 3-beep error tone will occur before returning to step 1.



3. If a valid System ID is entered, the keypad will display:

If this is the correct, press the [ENT] key, otherwise press the [ESC] key.



If the System ID needs to be modified, you must do this prior to programming any transmitters associated to their respective D8125INV. If the System ID is changed after the transmitters have been programmed, all transmitters (Point numbers, Mode settings, and Check-in time) WILL BE REPORTED AS MISSING BY THE D9412, D9412G, D9412GV2, D9112, D7412, D7412G, D7412GV2, D7212, D7212G, AND D7212GV2 CONTROL PANELS ONLY AFTER THE SUPERVISION INTERVAL EXPIRES and will have to be reprogrammed as new.

3.6.4 Menu 4: Clear EEPROM

This menu selection is available if it is believed that the data in the D8125INV is corrupted and you wish to clear the information and reprogram it. To clear the EEPROM, follow the steps shown below.

- 1. To access this menu selection, press 4 from the main menu. The keypad will display:

followed by:.....

and then:

- 2. Push the [ENT] key. Since clearing the EEPROM will delete the entire point database and default the D8125INV to the default settings, another confirmation is required to proceed.
- 3. If you wish to exit from this menu, press the [ESC] key. Otherwise, push the [ENT] key one more time to confirm that you wish to have the EEPROM erased.

Note: The System ID is maintained even after EEPROM is cleared, however, everything else is brought back to factory default values.

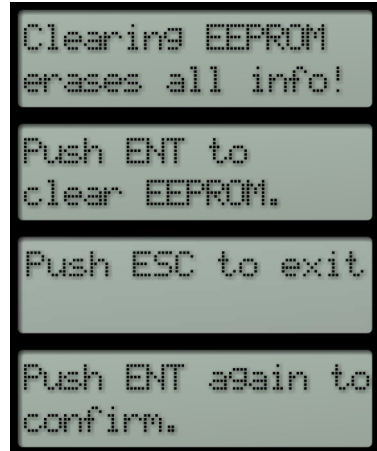

3.6.5 Menu 5: Set RF System Supervision Interval

The RF System Supervision Interval determines how long the D8125INV will wait to hear at least one check-in transmission (or any transmission) from a transmitter before sending a Missing condition to the Control Panel. The interval value that is chosen applies to all transmitters system wide. To set the RF System Supervision Interval, follow the steps shown below.

- 1. To access this menu selection, press 5 from the main menu. The keypad will then display the following menus:

<value> = None, 4 hr., 12 hr., or 24 hr.

Note: All transmitters follow the programmed supervision interval except the FA113 Keyfob and fire points.

Note: The supervision interval begins when the D8125INV powers up. If removing a battery in a transmitter to test this feature, the supervision interval starts before the transmitter is programmed, taking until the end of the next supervision window to go into trouble.

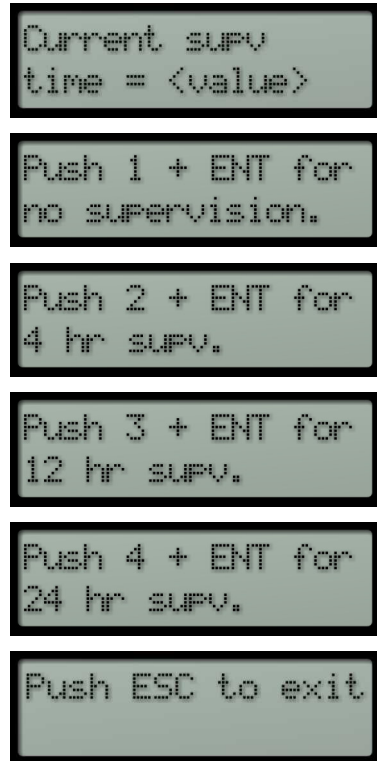

Installation

2. If [1] + [ENT] is pressed, the keypad will display (for two seconds before returning to the main menu):



```
New surv time =
none
```

If [2] + [ENT] is pressed, the keypad will display (for two seconds before returning to the main menu):.....



```
New surv time =
4 hr
```

If [3] + [ENT] is pressed, the keypad will display (for two seconds before returning to the main menu):.....



```
New surv time =
12 hr
```

If [4] + [ENT] is pressed, the keypad will display (for two seconds before returning to the main menu):.....



```
New surv time =
24 hr
```



The Supervision Interval for Fire Points (Modes 8 – 12) will remain fixed at 4 hours regardless of programmed value.

If a receiver does not receive a check-in transmission or any other type of transmission (ex. “Alarm, Tamper”) within the time programmed, the D8125INV will send a Missing condition for that point to the control panel.

3.6.6 RF Diagnostics Function

The RF Diagnostics function allows you to troubleshoot individual RF transmitters programmed in the system. This menu is split into two sub-menus: Individual point status and Off-Normal point status.

To access the RF Diagnostics menu, follow the steps shown below.

1. To access this function, one of two methods can be used.
 - a. Press [DIAG] on the keypad from idle text.



```
Call For Service
Enter Code + ENT
```

Enter a valid passcode and press [ENT]:



```
Enter Passcode
to view RF Diag.
```

- b. From the main menu (after a valid passcode has been entered), press [DIAG] on the keypad.



```
Push DIAG for RF
Diagnostics.
```

2. The keypad will then display the following menus (if there are no system faults on the D8125INV):

See step 4 below

See step 5 below

3. If [1] is pressed, this menu allows you to jump to any RF point programmed into the D8125INV. If [1] is pressed from this menu, the keypad will display:

4. After a valid RF Point Number is entered, Figure 18 will be displayed.

Figure 18: Point Number Status

Item	Variable	Description	
1	xxx	?	D8125INV has not received at least 30 transmissions to determine signal strength
		Bad	Transmitter must be relocated
		OK	Good signal strength
2	<value>	Normal	
		Faulted	
		Tamper	
		Missing	
		Low Bat	
		Tamper, Low Bat	
Faulted, Low Bat			

Table 10: Variable Descriptions

If an invalid RF Point Number is entered, the following is displayed:

If the D8125INV is connected to Zonex 1, enter point numbers 9-127 (or 9-75 if D7412G, D7412, D7412GV2, D7212, D7212G, or D7212GV2).

Figure 19: RF Point not programmed



Points 74 and 75 and Points 194 and 195 are reserved for the FA113 Keyfob.

If the D8125INV is connected to Zonex 2, enter point numbers 129-247. After entering the point number and pressing the [ENT] key, the keypad will display Figure 18.

D8125INV

Installation

To view the next RF point number programmed in the D8125INV, press [NEXT], otherwise press [PREV] to see the previously programmed RF point.

5. If [2] is pressed from this menu, the keypad will display all off-normal points at a 2-3 second scroll rate. By pressing [NEXT] or [PREV] while this is scrolling stops the auto scroll. The [NEXT] and [PREV] keys are used to view point status individually. (See Figure 18)
6. The keypad will then revert back to the initial Diagnostics menu:



Push 1 for
Single Pt Status

See step 4



Push 2 for Off
Normal Pt Status



See step 5



Push ESC to exit

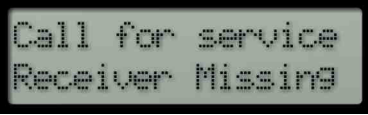

Troubleshooting

4.0 Troubleshooting

Symptom	Diagnosis	Remedy
	D8125INV has lost communications with the FA400 receiver. This will cause all programmed RF points on that D8125INV to go missing immediately (missing alarms or missing troubles at control panel.) It will also cause a Point Bus Fail 1 (or 2) at the control panel.	<p>Check for LED activity at receiver(s).</p> <p>Double-check wiring between D8125INV and FA400.</p> <ul style="list-style-type: none"> +12 V/Vs to GND = approx. 13 VDC DATA/OUT to GND = fluctuating voltage (data flowing) <p>Make sure that jumper on FA400 is set to '1' if one FA400 is used on a D8125INV; If two FA400's are used on a D8125INV, set the jumper on one FA400 receiver to '1', and the jumper on the FA400 receiver to '2'.</p>
	<p>The D8125INV hasn't 'heard' from an RF point for the length of the programmed supervision interval. The most common reasons are damage to the transmitter, physical environmental changes, or a dead battery.</p> <p>To find out which RF points are missing, press [DIAG] for RF diagnostics, then [2] for Off-normal point's status. Display will start at lowest numbered off-normal point and automatically scroll up. [NEXT] or [PREV] keys will switch to manual scrolling.</p>	<p>Locate missing transmitter.</p> <p>Check for physical damage. Check battery voltage, which should equal 3.0 VDC min. Bring transmitter closer to receiver and cause a transmission, to determine if a range problem exists due to a change in the environment. For range problems, a 2nd FA400 per D8125INV, or an FA570/575 repeater may be used.</p>
	Internal diagnostics checksum failure	Clear EEPROM, and reprogram the D8125INV and all of its transmitters. If EEPROM failure re-occurs, return the D8125INV for repair/replacement.
<p>Undesired point response at D8125INV (e.g. RF point is normal when it should be faulted, etc.)</p> <p>Note: <i>When testing RF points, first check for proper point response at D8125INV RF diagnostics. When point responses are correct at the D8125INV, then move on to testing point responses at the control panel.</i></p>	<p>Programmed mode of transmitter is incorrect.</p> <p>Wiring of external circuit is incorrect.</p>	<p>Check the mode charts in <i>Table 9: Recommended Point Types/Point Responses</i>, p.23. Make sure mode selection is correct for that transmitter model. For Universal transmitters, make sure the mode selection is correct for the external circuit type (NO/NC/EOL?/not used), and whether or not the internal contact (magnet) is used.</p> <p>Correct wiring of external circuit</p>

D8125INV

Troubleshooting

Symptom	Diagnosis	Remedy
Point response is correct at the D8125INV, but incorrect at the control panel (for example, RF point is in trouble when it should be faulted, etc.).	Point programming at control panel is incorrect.	Make sure point programming at control panel is correct, especially the Point Response Type. Remember that regardless of transmitter type or configuration of an external circuit, the D8125INV will always report a fault to the control panel as a short, and a tamper as an open. In most cases, a point response type that gives trouble on open is desired.
RF points change state unexpectedly, with no actual state change at transmitter	Two or more transmitters are programmed as the same RF point number. There is another, nearby D8125INV system with transmitters, programmed with the same System ID.	Transmitters send RF point status (fault/tamper/normal) at status change and at 1 min. or 5 min. check-in intervals. If two duplicate points are in different states, the RF point state at the D8125INV may keep changing as the check-in transmissions from each transmitter are received. If duplicate RF points are in the same state, RF point state at the D8125INV will stay the same. The system ID is shipped at a random value of 000-255. D8125INV systems that are within RF range of each other must have different System ID's, to avoid interaction of the systems. That's why it's a good idea to check for duplicate System ID's if two D8125INVs are used. Remember that if the System ID is changed, all transmitters in that D8125INV system will have to be reprogrammed as new.
 in RF Diagnostics	Received signal level for that point is low.	A second FA400/receiver can be added to a D8125INV and mounted in a different location to increase range. An Inovonics FA570/575 high-power repeater may be used to increase range to a greater degree.
 in RF Diagnostics	D8125INV has not received enough recent transmissions from that RF point to give an 'OK' or 'BAD' signal indication; Several transmissions are required. The signal indication will start out as '?' after power up, after programming an RF point, or after an RF point has gone missing.	Cause several transmissions to update signal level. About 4 alarms or tampers and 4 restorals spaced 5 seconds apart will cause enough transmissions to get an accurate signal indication. Without activations, it will take about a half-hour to get signal strength readings if transmitter Check-In time is set to 1 minute. It will take about 2 hours if Check-In time is set to 5 minutes.

Troubleshooting

Symptom	Diagnosis	Remedy
RF Keyfob transmitter points go missing	RF keyfobs may only be programmed as points 74 & 75, or as points 194 & 195. Since keyfobs can be carried off-site, these points are not supervised, regardless of the programmed RF supervision interval.	Reprogram RF keyfob transmitters as Points 74 & 75 (zonex 1), or Points 194 & 195 (zonex 2).
RF points go missing when programmed supervision interval = none.	These RF Points are programmed as Fire Points (transmitter modes 8-12). Transmitters programmed as Fire points will be supervised at 4 hour intervals, regardless of programmed supervision interval time.	If those RF points are not for Fire devices, connect and reprogram the transmitter as new, changing the transmitter Mode to non-fire (Modes 1-7).

Table 11: Troubleshooting Solutions

4.1 FA400 Receiver Supervision

The D8125INV supervises the Inovonics FA400 receiver by periodically polling it. If the FA400 does not respond to the polls over a five minute period, the D8125INV will initiate a Point Bus Trouble event back to the control panel. The control panel will then initiate a Point Bus Fail 1 (or 2) event.

If this occurs, the D8125INV will display Figure 20.



Figure 20: Call for Service, Enter Code + ENT

Enter a valid passcode and then Figure 21 will be displayed.



Figure 21: Call for Service, Receiver Missing

4.2 Missing Transmitters

A transmitter may go missing in the system due to the following most common reasons:

- dead battery
- physical environmental changes
- damage to the transmitter

The D8125INV will display Figure 22.

Enter a valid passcode and then Figure 23 will be displayed.

Note: The number 019 (which is used as an example) refers to the actual quantity of points missing, not the specific point number.



Figure 22: Call for Service, Enter Code + ENT



Figure 23: Call for Service, Receiver Missing

4.3 Low Transmitter Battery Conditions

When the transmitter reports low battery conditions and replacement is necessary be sure to press reset button on transmitter after replacing battery. Also, be sure to test the transmitter for proper operation after replacing battery.

D8125INV

Troubleshooting

4.4 D8125INV Power Cycle Operation

If the D8125INV is powered down and then back up, it may take up to a maximum of 5 minutes for all the transmitters to report back to the D8125INV with their current status. On systems employing fewer transmitters, this time is reduced proportionately.

In addition, when the D8125INV is powered up, all transmitters report Normal until their state is updated.

4.5 Inovonics Frequently Asked Questions

This FAQ is reprinted with permission from Inovonics.

4.5.1 What's the range of Inovonics Wireless transmitters?

Range for any wireless device depends very heavily on the environment. In general, radio signals will be absorbed into materials that contain moisture, such as concrete, water, and earth. Radio signals will bounce off of metal surfaces and penetrate fairly easily through drywall or glass. In any case, the radio signals will lose some power as they pass through or come in contact with objects. For comparison purposes the only equitable measurement is "true-line-of-sight". This is a condition where there are absolutely no obstacles between the transmitter's antenna and the receiver's antenna.

At this writing, there are 2 types of output power used on Inovonics Wireless transmitters.

1. High Power. The line of sight range is 10,000 ft. Available only in the FA250 and FA570/575.
2. Standard Power. The line of sight range is 2,500 ft. Available in all transmitters except the FA250.



The FA250 will program the same as the FA210W.

It is rare that an installation has a true-line-of-sight condition so for a more definitive answer on range we suggest you test the environment with an FA715 Survey Kit.

In a typical building environment our 900 MHz signal propagates easily around the metal studs and concrete floors. Customers regularly tell us that they are impressed with the performance. If additional coverage is needed we offer an FA570/575 Intelligent Repeater. These repeaters support an unlimited number of Inovonics Wireless transmitters.

4.5.2 What is the range of the Inovonics Wireless repeater?

The repeater uses our High Power specification in its output. The re-transmit range is 10,000 ft. line of site.

The receive coverage area is dependent on the power output of the transmitters it repeats.

4.5.3 What does the red decode LED/ light mean?

This LED is located on the circuit board of Inovonics Wireless receivers. It is an indicator of the RF noise in the area. Every time the light blinks the receiver is attempting to decode a signal. This light shows that the unit is turned on and working. It is listening to all of the radio energy in the environment to determine if any signals are coming in on the Frequency Agile protocol. If a valid FA signal is received, the adjacent Valid LED will illuminate.

4.5.4 Does it matter what way I plug in the programming cable?

NO - As long as the 3 pins are inserted into the programming cable, polarity isn't important.

4.5.5 How can I get more range?

You can use Inovonics FA570/FA575 Repeaters to extend the range of any Inovonics Wireless system.

4.5.6 Why can't I program more than 1 transmitter per point?

Programming more than a single transmitter to a given point number defeats the ability of the Inovonics Wireless system to supervise itself. This is a practice called "stacking points" and is discouraged in practice. Never stack points in a life-safety or security application.

4.5.7 Are your transmitters weatherproof?

Our FA223S pendant transmitter is water-tight to a depth of 1 foot. In addition, we offer the ACC640 NEMA Enclosure for outdoor environments. Many installers simply seal our transmitters in PVC pipe when used in outdoor

environments. Your choice of enclosures will depend on your specific needs. Be sure you keep in mind maintenance needs including battery replacement in a few years!

4.5.8 What is temperature range for good operation?

+40°F to +135°F (+4.4°C to +57.2°C)

4.5.9 Can I externalize an antenna?

No. Our FA575 repeater is our external antenna.

4.5.10 Does each transmitter need a repeater?

No. Each repeater can re-transmit multiple transmitters from multiple systems and do not require programming for individual points.

Notes:

D8125INV

D8125INV Program Sheet

Notes:

Notes:

Free Manuals Download Website

<http://myh66.com>

<http://usermanuals.us>

<http://www.somanuals.com>

<http://www.4manuals.cc>

<http://www.manual-lib.com>

<http://www.404manual.com>

<http://www.luxmanual.com>

<http://aubethermostatmanual.com>

Golf course search by state

<http://golfingnear.com>

Email search by domain

<http://emailbydomain.com>

Auto manuals search

<http://auto.somanuals.com>

TV manuals search

<http://tv.somanuals.com>