

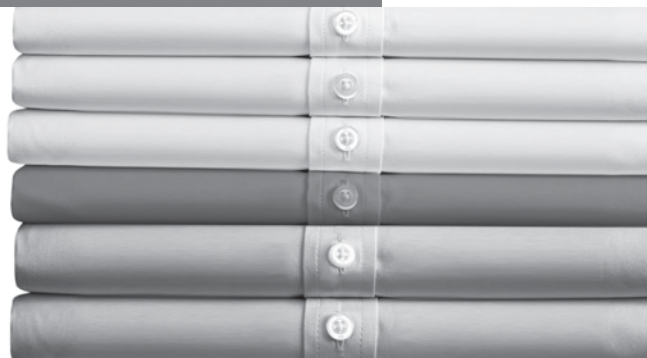

Register your new Bosch now:  
[www.bosch-home.com/welcome](http://www.bosch-home.com/welcome)



Sensixx'x **DA70** Easy**Comfort**



**BOSCH**

en Operating instructions

**Thank you for buying the “Sensixx’x DA70 EasyComfort” steam iron from Bosch.**

Carefully read through the operating instructions for the appliance and safeguard them for future reference.

**You can download this manual from the local home pages of Bosch.**

## General safety instructions

- The iron must not be left unattended while it is connected to the supply mains.
- Remove the plug from the socket before filling the appliance with water or before pouring out the remaining water after use.
- The appliance must be used and placed on a stable surface.
- When placed on its stand, make sure that the surface on which the stand is placed is stable.
- The iron should not be used if it has been dropped, if there are visible signs of damage or if it is leaking water. It must be checked by an authorized Technical Service Centre before it can be used again.
- With the aim of avoiding dangerous situations, any work or repair that the appliance may need, e.g. replacing a faulty mains cable, must only be carried out by qualified personnel from an Authorised Technical Service Centre.
- This appliance can be used by children aged from 8 years and above and persons with reduced physical, sensory or mental capabilities or lack of experience and knowledge if they have been given supervision or instruction concerning use of the appliance in a safe way and understand the hazards involved. Children shall not play with the appliance. Cleaning and user maintenance shall not be made by children without supervision.
- Keep the iron and its cord out of reach of children less than 8 years of age when it is energized or cooling down.
- This appliance is designed only for household use up to 2000m above sea level.
-  **CAUTION. Hot surface.**  
Surface is liable to get hot during use.

## Important notices

- This appliance has been designed exclusively for domestic use and must not be used for industrial purposes.
- This appliance must be used only for the purposes for which it was designed, i.e. as an iron. Any other use will be considered improper and consequently dangerous. The manufacturer will not be held responsible for any damage arising from misuse or improper use.
- This appliance reaches high temperatures and produces steam during use, this could cause scalds or burns in case of improper use.
  - Do not touch the soleplate! Hold the iron by its handle.
  - Do not leave the supply cord hanging over the table or ironing board, to prevent the appliance from falling.
  - Do not iron clothing while it is being worn!
  - Never spray or aim the steam at persons or animals!
- Do not allow the power cable to come into contact with sharp edges or with the soleplate when it is hot.
- Never rest the iron in a horizontal position when the soleplate is hot. Rest it on its heel.
- Do not touch the appliance with wet hands when in operation.
- This appliance is to be connected and used in accordance with the information stated on its characteristics plate.
- This appliance must be connected to an earthed socket. If it is absolutely necessary to use an extension cable, make sure that it is suitable for 16A and has a socket with an earth connection.

- In special environmental conditions slight instability may occur.
- The appliance must never be placed directly under the tap to fill the water tank.
- Unplug the appliance from the mains supply after each use, or if a fault is suspected.
- The electrical plug must not be removed from the socket by pulling the cable.
- Never immerse the iron in water or any other fluid.
- Do not leave the appliance exposed to weather conditions (rain, sun, frost, etc.).

## Advice on disposal

Our goods come in optimised packaging. This basically consists in using non-contaminating materials which should be handed over to the local waste disposal service as secondary raw materials. Your local town council can give you information about how to dispose of obsolete appliances.



**This appliance is labelled in accordance with European Directive 2012/19/EU concerning used electrical and electronic appliances (waste electrical and electronic**

**equipment – WEEE).**

**The guideline determines the framework for the return and recycling of used appliances as applicable throughout the EU.**

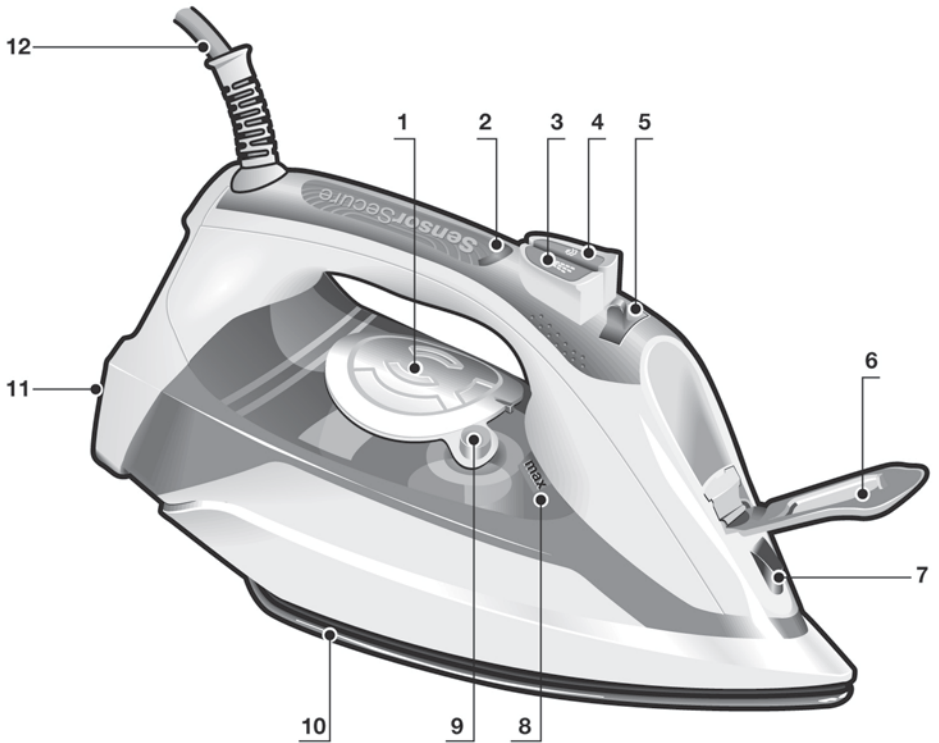
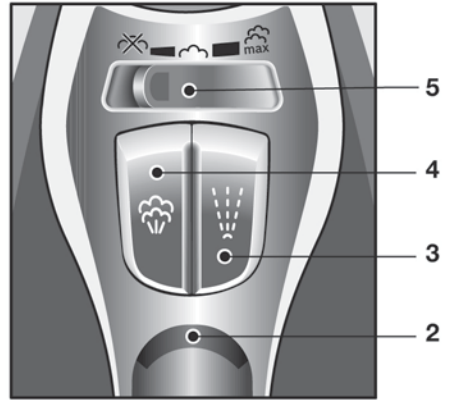

## Description

1. "TempOK" indicator lamps
2. "SensorSecure" indicator lamp
3. Spray button
4. Shot of steam button
5. Steam regulator
6. Water inlet lid
7. Spray nozzle
8. Level mark for maximum filling
9. "clean" button
10. Soleplate
11. Heel
12. Power cable

## Using your appliance



### 1. Filling the water tank

This appliance has been designed to use normal tap water.

**Important:** Do not use additives! The addition of other liquids, such as perfume, vinegar, starch, condensation water from tumble dryers or from air conditioning systems or chemicals will damage the appliance. Any damage caused by the use of the aforementioned products will make the guarantee void!

- 1 Unplug the iron from the mains.
- 2 Set the steam regulator (5) to the position .
- 3 Open the water inlet lid (6).
- 4 Fill the water tank. **Never fill beyond the level mark for maximum filling (8)!**
- 5 Close the water inlet lid.

**Tip:** To prolong the optimum steam function, you may mix tap water with distilled water 1:1. If the tap water in your district is very hard, mix tap water with distilled water 1:2.

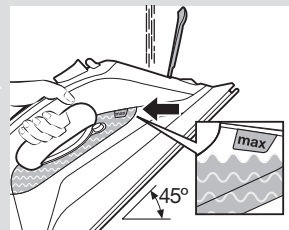
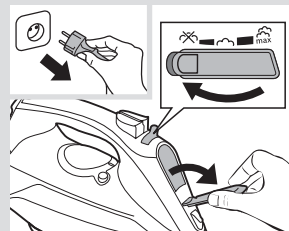

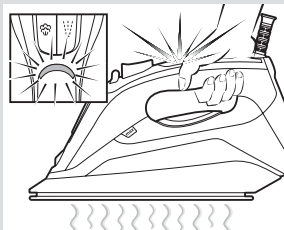
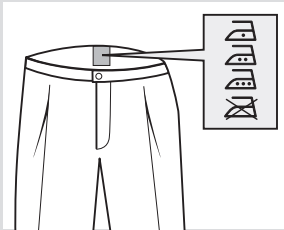
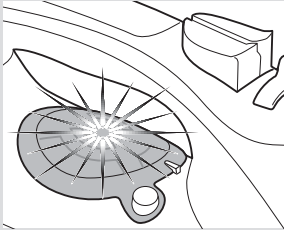
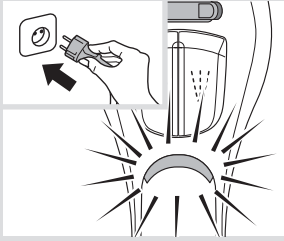

## 2. Heating

Remove any labels or protective covering from the soleplate (10).

- 1 Plug in the iron.
- 2 “SensorSecure” function will be activated and the indicator lamp (2) will flash.
- 3 The “TempOK” indicator lamp (1) will flash, indicating that the iron is heating up. When the iron is ready to use, the indicator lamp will remain lit continuously.



## “i-Temp” technology

This technology sets an appropriate temperature, which is suitable for all fabrics that can be ironed (symbols ).

The “i-Temp” technology does not apply to fabrics that cannot be ironed (symbol ).

Please check the garment care label for details or try ironing on a part of the fabric not visible normally.



## 3. “SensorSecure” function

After the initial heating, “SensorSecure” function switches off the iron when it is left unattended, thus increasing security and saving energy.

- 1 While the handle is gripped, the iron heats up. The “SensorSecure” indicator lamp (2) will remain lit continuously.
- 2 When the handle is released, the “SensorSecure” function is activated. The “SensorSecure” indicator lamp (2) will flash.



## 4. Steam settings

The steam regulator (5) is used to adjust the amount of steam produced when ironing.

| Steam setting     | Steam regulator |
|-------------------|-----------------|
| High steam flow   |                 |
| Medium steam flow |                 |
| Dry ironing       |                 |

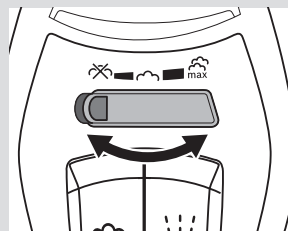

**Tip:** Try to iron the fabrics while they are still damp after washing. Steam will be generated from the fabrics rather than the iron.



## 5. Shot of steam function

Shot of steam can be used to remove stubborn wrinkles or to press in a sharp crease or pleat.

- 1 Press the shot of steam button (4) repeatedly with intervals of at least 5 seconds.

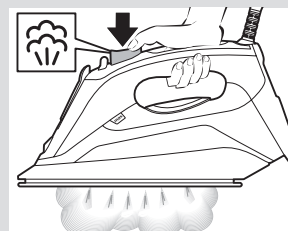

## 6. Vertical steam

Vertical steam can be used to remove creases from hanging clothes, curtains etc.

- 1 Hang article of clothing on a clothes hanger.
- 2 Operate the iron in a vertical position at a distance of 10 cm / 4 in, and press the shot of steam button (4) repeatedly with pauses of at least 5 seconds.

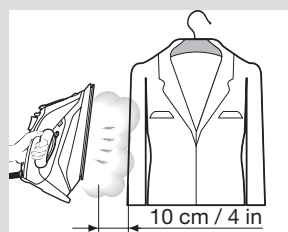

**Important:** If the “SensorSecure” indicator lamp (2) flashes while ironing in a vertical position, it means that the handle is not properly gripped and the iron will cool down.

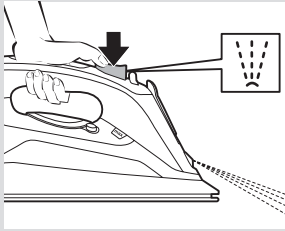

## 7. Spray

Spray can be used to remove stubborn wrinkles.

- 1 When ironing, press the spray button (3) and water will spray out of the spray nozzle (7) onto the garment.

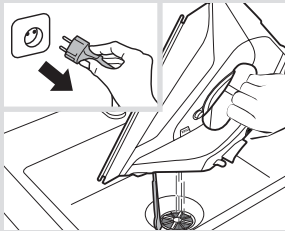

**Tip:** Do not use the spray function with silk.

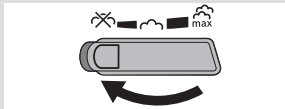

## 8. After ironing

- 1 Unplug the iron from the mains socket.
- 2 Empty the water tank.



- 3 Switch the steam regulator (5) from  to  and back again several times (self-cleaning). Set the steam regulator to the position .

- 4 Set the iron aside in a vertical position on its heel (11) to cool down.

- 5 Coil the power cable (12) loosely around the heel of the iron. Store the iron in an upright position.

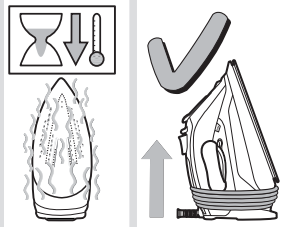

**Tip:** For immediate storage of the iron, you may use the "StoreProtect" accessory (see "Accessories" section).





## Cleaning & Maintenance

### Attention! Risk of burns!

**Always unplug the appliance from the mains supply before carrying out any cleaning or maintenance operation on it.**

- 1 If the iron is only slightly soiled, pull out the plug and allow the soleplate (10) to cool down. Wipe the housing and the soleplate with a damp cotton cloth only.
- 2 To keep the soleplate smooth, you should avoid hard contact with metal objects. Never use a scouring pad or chemicals to clean the soleplate.

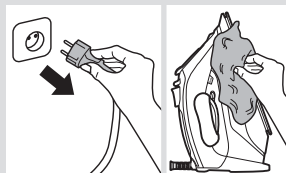

## Descaling systems

### A “self-clean”

Each time you use the steam regulator (5), the “self-clean” system cleans the mechanism of scale deposits.

### B “anti-calc”

The “anti-calc” cartridge has been designed to reduce the build-up of scale produced during steam ironing.

### C “Calc'nClean” function

The “Calc'nClean” function helps to remove scale particles out of the steam chamber.

If the water in your area is very hard, you may use this function approximately every two weeks.

- 1 Set the steam regulator (5) to the position . Unplug the iron from the mains socket.

**Tip:** For deep descaling, it is recommended to use the descaling liquid (see “Accessories” section). This procedure should be carried out every 3 months.

Pour a measure (25 ml) of the descaling fluid into the water tank.

- 2 Fill the water tank up to the level mark for maximum filling.

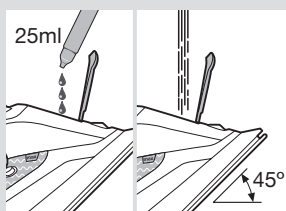
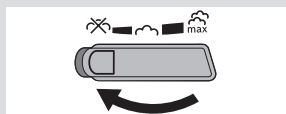
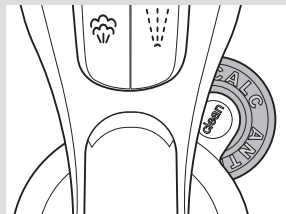

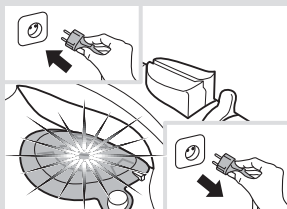

- 3 Plug in the iron.
- 4 When the lamp "TempOK" (1) remains lit continuously, **unplug the iron (very important!)**.

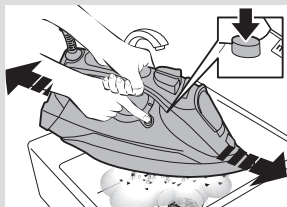

- 5 Hold the iron over a sink.
- 6 Press the "clean" button (9) and shake the iron back and forth keeping it in a horizontal position until approximately one third of the water capacity of the tank is evaporated. **Boiling water and steam will come out**, carrying scale or deposits that might be there.

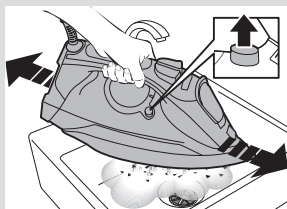

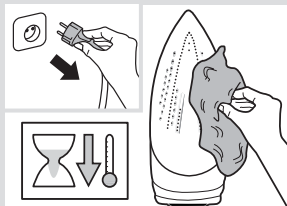

- 7 Release the "clean" button, and gently shake the iron for some seconds.
- 8 Repeat steps 6 and 7.
- 9 Check carefully that the water tank is empty (**very important!**).
- 10 Plug the iron in and heat it up again until the remaining water has evaporated.



- 11 Unplug the iron and let the soleplate cool down. Wipe the soleplate with a damp cotton cloth only.

## Accessories

The accessories may be purchased from the customer service or specialist shops.

|  <b>Descaling liquid</b> |  <b>"StoreProtect"</b> |
|---|---|
| For deep descaling of the steam iron.<br><b>Contents: 4 bottles x 25 ml.</b>                                | Enables an immediate and safe storage of the iron, even with a hot soleplate.                             |
| <b>Name of the accessory: TDZ1101</b>   | <b>Name of the accessory: TDZ1750</b>   |
| <b>Accessory code: 00311715</b>   | <b>Accessory code: 00575960</b>   |



## Trouble shooting

| Problem   | Probable cause  | Solution   |
|---|---|--|
| The iron does not heat up.  | The "SensorSecure" function has been activated. The iron is set to stand-by.  | Grip the handle of the iron to re-start it.  |
| Water drips out of the soleplate when using the "shot of steam" function. | You have pressed the shot of steam button (4) repeatedly without waiting for 5 seconds between each press.                | Wait 5 seconds between each press of the shot of steam button.                     |
| Steam does not come out.  | Steam regulator (5) is set to  position. | Set the steam regulator to a higher position.                                      |
| Excessive dripping or steaming.   | No proper closing of "clean" button (9).  | Point the iron away from the ironing area. Actuate a few times the "clean" button. |
| Smoke comes out when connecting the iron for the first time.              | This may be caused by the lubrication of some of the internal parts.  | This is normal and will stop after a few minutes.                                  |
| Deposits come out through the holes in the soleplate (10).                | Traces of lime scale are coming out of the steam chamber.   | Carry out a cleaning cycle (see "Calc'nClean function" section).                   |

If none of the above solves the problem, get in touch with an Authorised Technical Service.

## Guarantee conditions

The terms of the guarantee for this appliance are in accordance with that stated by our representative for the country in which it is sold.

The details of these conditions can be obtained from the retailer from whom the appliance was purchased. The purchase receipt must be presented when making any claims against the terms of this guarantee.



**Customer Service**

**Great Britain**

Bosch Customer Service

Grand Union House

Old Wolverton Road Milton Keynes

MK12 5PT

UK +44 (0)344 892 8979

IRL +353 (0)1450 2655

**[www.bosch-home.co.uk](http://www.bosch-home.co.uk)**

## Free Manuals Download Website

<http://myh66.com>

<http://usermanuals.us>

<http://www.somanuals.com>

<http://www.4manuals.cc>

<http://www.manual-lib.com>

<http://www.404manual.com>

<http://www.luxmanual.com>

<http://aubethermostatmanual.com>

Golf course search by state

<http://golfingnear.com>

Email search by domain

<http://emailbydomain.com>

Auto manuals search

<http://auto.somanuals.com>

TV manuals search

<http://tv.somanuals.com>