

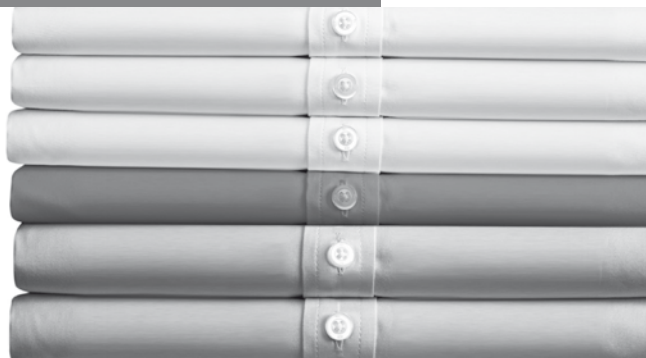

Register your new Bosch now:
<http://www.bosch-home.co.uk>



Sensixx B20L



BOSCH

en Operating instructions

| Index | Page |
|------------------------------------|-------------|
| 1. Description | 6 |
| 2. Getting started | 7 |
| 3. Setting the temperature | 8 |
| 4. Ironing with steam | 8 |
| 5. “PulseSteam” function | 9 |
| 6. “Ultimate steam” function | 9 |
| 7. “Intelligent steam” function | 9 |
| 8. Ironing without steam | 9 |
| 9. Vertical steam | 9 |
| 10. Energy saving “eco” setting | 10 |
| 11. Auto shut-off | 10 |
| 12. Additional accessories | 10 |
| 13. Calc’n’Clean | 11 |
| 14. Automatic clean warning | 11 |
| 15. Rinsing the iron steam chamber | 12 |
| 16. Cleaning & Maintenance | 13 |
| 17. Storing the appliance | 13 |
| 18. Tips to help you save energy | 13 |
| 19. Guarantee conditions | 13 |
| 20. Trouble shooting | 14 |

Thank you for buying the Sensixx B20L professional steam station, the new professional steam-ironing system from Bosch.

These instructions contain valuable information about the unique features of this iron and some hints to make ironing easier for you.

Please visit www.bosch-home.co.uk for more product information or to register your product, just follow the link to the Online guarantee registration.

Introduction

This powerful system produces continuous steam for an ideal ironing performance. It has a large water tank that can be refilled at any time without switching off the system.

We hope that you enjoy ironing with this steam station.

You can download this manual from the local homepages of Bosch.

General safety instructions

- The iron must not be left unattended while it is connected to the supply mains.
- Remove the plug from the socket before filling the appliance with water or before pouring out the remaining water after use.
- The appliance must be used and placed on a stable surface.
- When placed on its stand, make sure that the surface on which the stand is placed is stable.
- The iron should not be used if it has been dropped, if there are visible signs of damage or if it is leaking water. It must be checked by an authorized Technical Service Centre before it can be used again.
- With the aim of avoiding dangerous situations, any work or repair that the appliance may need, e.g. replacing a faulty mains cable, must only be carried out by qualified personnel from an Authorised Technical Service Centre.
- This appliance can be used by children aged from 8 years and above and persons with reduced physical, sensory or mental capabilities or lack of experience and knowledge if they have been given supervision or instruction concerning use of the appliance in a safe way and understand the hazards involved. Children shall not play with the appliance. Cleaning and user maintenance shall not be made by children without supervision.

- ❑ Keep the iron and its cord out of reach of children less than 8 years of age when it is energized or cooling down.
- ❑  **CAUTION. Hot surface.**
Surface is liable to get hot during use.
- ❑ This appliance is designed only for household use up to 2000m above sea level.

- Please read these instructions for use carefully before using the appliance and save them for future reference.
- This appliance complies with international safety standards.
- This appliance has been designed exclusively for domestic use and must not be used for industrial purposes.
- This appliance is to be connected and used in accordance with the information stated on its characteristics plate.
- This appliance must be connected to an earthed socket. If it is absolutely necessary to use an extension cable, make sure that it is suitable for 16A and has a socket with an earth connection.
- If the safety fuse fitted in the appliance blows, the appliance will be rendered inoperative. To restore normal operation the appliance will have to be taken to an authorised Technical Service Centre.
- The appliance must never be placed directly under the tap to fill the water tank.
- Unplug the appliance from the mains supply after each use, or if a fault is suspected.
- The electrical plug must not be removed from the socket by pulling the cable.
- Never immerse the iron in water or any other fluid.
- Do not leave the appliance exposed to weather conditions (rain, sun, frost, etc.)

Important :

- This appliance reaches high temperatures and produces steam during use, this could cause scalds or burns in case of improper use.
- The steam hose, base station, metal plate at the bottom of the removable iron pad (2) and in particular the iron can get hot when used. This is normal.
- Never aim the steam at people or animals.
- Do not allow the power cable to come into contact with the soleplate when it is hot.

Advice on disposal

Our goods come in optimised packaging. This basically consists in using non-contaminating materials which should be handed over to the local waste disposal service as secondary raw materials. Your local town council can give you information about how to dispose of obsolete appliances.



This appliance is labelled in accordance with European Directive 2012/19/EU concerning used electrical and electronic appliances (waste electrical and electronic equipment - WEEE).

The guideline determines the framework for the return and recycling of used appliances as applicable throughout the EU.

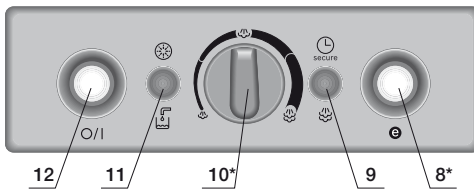
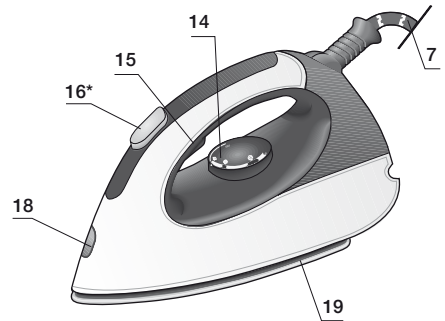
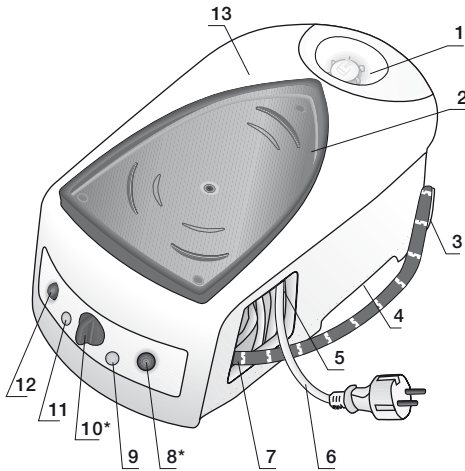

1 Description

- | | |
|---|--|
| <ul style="list-style-type: none"> 1. Water tank 2. Removable iron pad 3. Steam hose storage fixing 4. Carrying handles 5. Mains cable storage compartment 6. Mains cable 7. Steam hose 8. "Energy Saving" button * 9. "Steam ready" / "Auto shut-off" pilot light 10. Variable steam control * | <ul style="list-style-type: none"> 11. "Refill water tank" / "Clean warning" pilot light 12. Illuminated main power button / switch (O/I) 13. Housing with internal steam generator 14. Temperature control knob 15. Steam release button "Pulse steam" 16. Steam release button 17. "on / off" pilot light* 18. Iron pilot light 19. Soleplate |
|---|--|

* Model dependent

2 Getting started



1. Remove any label or protective covering from the soleplate.
2. Place the appliance horizontally on a solid, stable surface. You may remove the iron pad (2) from the appliance and place the iron on it on another solid, stable, horizontal surface.
3. Fill the water tank (1), making sure not to pass the level mark.



4. Unwind the mains cable (6) fully and plug it into an earthed socket.
5. Set the main power button / switch (12) to the on position "I" (button or pilot light 17* illuminated in red).
6. The "Steam ready" indicator lamp (9) will light up after several minutes, indicating that the appliance is ready to use.
When using the steam generator for the first time, or when using it straight after Calc'n'Clean, the steam generator will take slightly longer to heat up.
7. This appliance has a built-in water level sensor. The "refill water tank" indicator (11) will light when the water tank is empty.

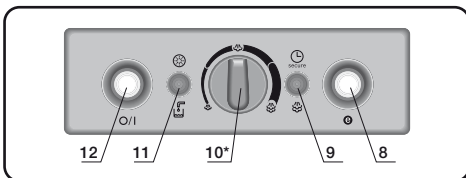

or (Model dependent) :

If the "steam ready" lamp (9) lights and steam is not released when pressing the trigger (15 or 16*), refill the water-tank.

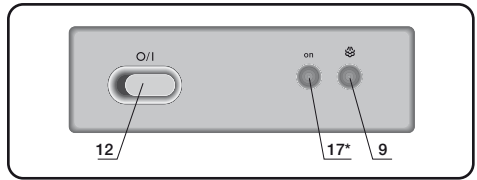

Important:

- Normal tap water can be used.
To prolong the optimum steam function, mix tap water with distilled water 1:1. If the tap water in your district is very hard, mix tap water with distilled water 1:2.
You can inquire about the water hardness with your local water supplier.
- The water tank can be filled at any time while using the appliance.
- To avoid damage and/or contamination of the water tank and the boiler, do not put perfume, vinegar, starch, descaling agents, additives or any other type of chemical product into the water tank.

Any damage caused by the use of the aforementioned products, will make the guarantee void.

- The iron is not designed to rest on its heel. Please always position it horizontally on the iron pad (2).
 - The iron pad can be placed into the specially designed recess on the appliance or somewhere suitable alongside the ironing area.
- Never rest the iron on the appliance without the iron pad!**
- During its first use the iron may produce certain vapours and odours, along with white particles on the soleplate, this is normal and it will stop after a few minutes.
 - While the steam release button is pressed, the water tank may produce a pumping sound, this is normal, indicating that water is being pumped to the steam tank.



1. Check the ironing instruction label on the garment to determine the correct ironing temperature.
2. Turn the temperature selector (14) to the required setting:

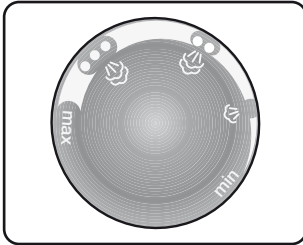

- Synthetics
- Silk – Wool
- Cotton – Linen

3. The indicator lamp (18) will remain lit while the iron is heating and go out as soon as the iron has reached the selected temperature.

Tips:

- Sort your garments out based on their cleaning symbol labels, always starting with clothes that have to be ironed at the lowest temperatures.
- If you are not sure what the garment is made of then begin ironing at a low temperature and decide on the correct temperature by ironing a small section not usually seen when worn.
- At the beginning of each use, it is possible that drops of water will be dispensed alongside steam.

Therefore, it is advisable to try the iron on the ironing board or a piece of cloth to start with.



1. Turn the temperature selector (14) to the required setting.
2. Set the amount of steam to suit your needs, using the variable steam control (10*).

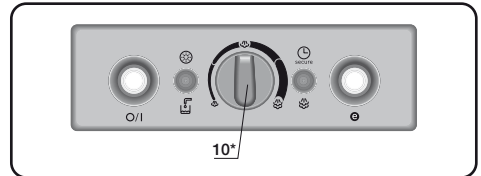

For normal use, please choose one of the following recommended settings:

| Temperature | Steam setting |
|-------------|---------------|
| • | |
| •• | |
| ••• | |

3. Press the steam release button (15 or 16*) to release steam.

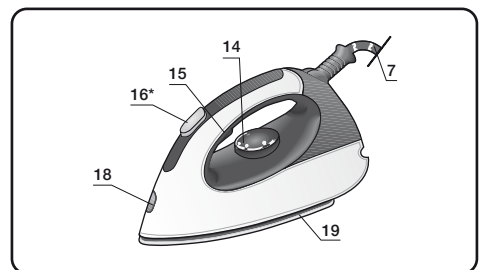

Attention:

When ironing on a lower temperature setting “•”.

- If the appliance has variable steam control (10*), set the variable steam control to its lowest position .
- If the appliance does not have variable steam control, press the steam release button only for a few seconds at a time when ironing at lower temperatures.

In both cases, if you find that water is dripping out of the soleplate, set the temperature selector (14) to a higher position (**take care that the garment can be ironed on this heat temperature setting**).

• At the beginning of each use, it is possible that drops of water will be dispensed alongside steam. Therefore, it is advisable to try the iron on the ironing board or a piece of cloth to start with.

Tip: for better ironing results, iron the last strokes without steam to dry the garment.

5 “PulseSteam” function



(Model dependent)

This appliance has a special function for tackling difficult creases.

When the steam release button is activated, the steam generator will give three powerful shots of steam so that the steam reaches even deeper into the fabrics.

1. Set the temperature selector (14) on “...”
2. Press the steam release button (15) on the bottom of the handle two times shortly (double-click).

or (Model dependent)

Shortly press the steam release button (16*) on the top of the handle.

Remark : It is possible to stop the shots of steam by pressing the steam button shortly again.

6 “Ultimate steam” function

(Model dependent)

The “Ultimate steam” function helps to decrease more stubborn materials found in garments like Jeans or linen tablecloth. When activating the steam button (16*) the steam generator produces an extra amount of steam. The function should be used during intervals of a few seconds, to be the most effective.

1. Set the temperature selector (14) on “...”

2. Press the steam button (16*).

Important:

- The steam hose (7) may get hot if you are ironing for long periods.
- **Note:** Some water drops may appear when you use the “Pulse steam” or the “Ultimate steam” function for the first time. The water drops will disappear after you have used the function for some time.

7 “Intelligent steam” function

(Model dependent)

This system has intelligent steam control, which, after releasing the steam release button (15), provides a small amount of additional steam.

The additional steam can always be stopped by briefly pressing the steam release button once again.

8 Ironing without steam



1. Select an appropriate temperature for the type of material being ironed.
2. Begin ironing but without pressing the steam release button (15 or 16*) .

9 Vertical steam



Never direct the steam jet at garments that are being worn.

Never aim the steam at people or animals.

1. Set the temperature control to the “...” or “max” position.
2. You can steam iron curtains and hanging garments (jackets, suits, coats...) by placing the iron in a vertical position and pressing the steam release button.

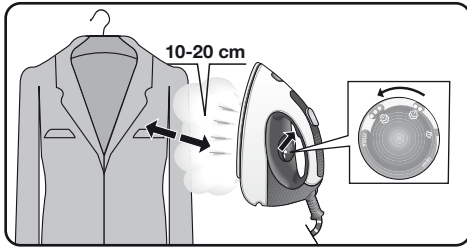

10 Energy saving "eco" setting

(Model dependent)

If the "Energy saving" button (8*) is switched on, the energy consumption of the appliance will be reduced, by means of an automatic reduction of electricity and water consumption. A good ironing result will still be obtained for most of the garments.

Use the normal energy setting for thick and highly wrinkled fabrics.

Note: If you work with the "Energy saving" function, the variable steam regulation and temperature regulation can still be used as recommended.

11 Auto shut-off

(Model dependent)

If during ironing, the steam release button (15-16*) on the iron handle is not pressed for a certain length of time (8 minutes), the steam station will automatically switch off.

The "auto shut-off" pilot lamp (9) will flash when auto shut-off has been activated.

To switch the steam station back on, press the steam release button again.

12 Additional accessories

(Model dependent)

Fabric protection soleplate cover

The fabric-protection soleplate cover is used for steam ironing delicate garments at maximum temperature without damaging them. Use of the soleplate cover also does away with the need for a cloth to prevent shine on dark materials.

It is advisable to first iron a small section on the inside of the garment to see if it is suitable.

To attach the soleplate cover to the iron, place the tip of the iron into the end of the soleplate cover and pull the elastic strap over the lower rear of the iron until it fits tightly. To release the soleplate cover, pull the elastic strap and remove the iron.

The fabric-protection soleplate cover may be purchased from the customer service or specialist shops:

| Accessory code (After-sales) | Name of accessory (Specialist outlets) |
|------------------------------|--|
| 00571510 | TDZ2045 |

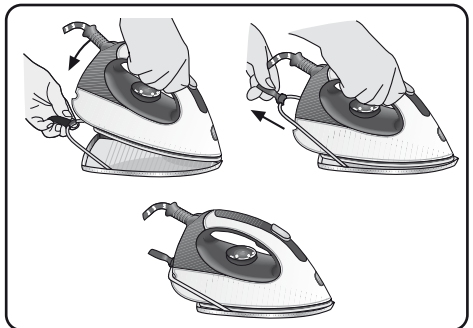

13 Calc'n'Clean

Cleaning the Boiler

To extend the life of your steam generator and to avoid any build up of scale, it is essential that you rinse out the boiler after several hours of use (approximately after 50 hours). If the water is hard, increase the frequency.

Do not use descaling agents for rinsing out the boiler, as they could damage it.

1. Check that the appliance is cold and unplugged for more than 2 hours, and that the water tank (1) is empty.
2. Place your appliance on the edge of your kitchen sink, so that any residual water in the water tank is directed into the sink.
3. Remove the plastic cover located on the bottom of the appliance by turning it to the  position.
4. Unscrew the boiler drainage plug using a coin.
5. Holding your steam generator in an upside down position, and using a jug, fill the boiler (in the base unit) with 1/4 litre of water.
6. Shake the base unit for a few moments and then empty it completely over a sink or bucket. To obtain the best result, we recommend that this operation is done twice.

Important: before closing, make sure no water remains in the boiler.

7. Replace and tighten up the boiler drainage plug with a coin.
8. Insert and close the plastic cover by turning it to the  position.

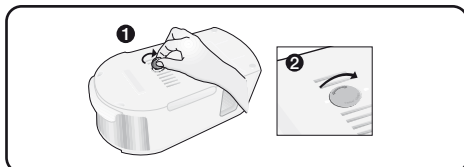
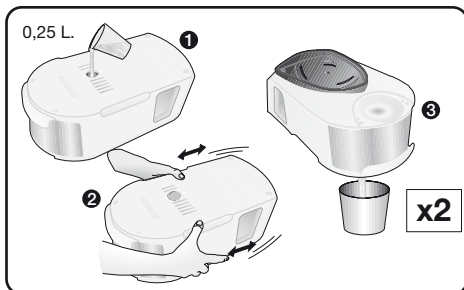
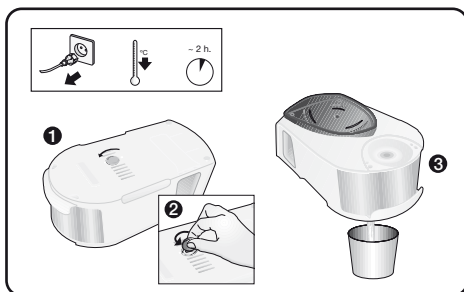

14 Automatic clean warning



(Model dependent)

Pilot light (11) will flash indicating that boiler must be rinsed. To do this, follow the procedure described in the section above.

To reset the “Calc'n'Clean” counter, switch the steam station off twice, keeping it off for at least 30 seconds each time.

(on → 30s off → on → 30s off → on)

⚠ Caution! Risk of burns!

This procedure helps to remove scale particles out of the steam chamber.

This cleaning procedure may be performed occasionally (approximately once a year), when after a long period of use with very hard water, scale particles start to come out of the soleplate.

1. Ensure that the iron is cooled down.
2. Set the temperature selector (14) of the iron to the “min” position.
3. Fill the tank with tap water.
4. Plug in the mains cable and set the main power button / switch (12) to the on position “I”.
5. Wait until the “steam ready” indicator lamp (9) lights up.
6. If the steam station has steam regulator (10*), set it to the maximum position ☼.
7. Hold the iron over the sink or a container to collect the water.
8. Press the steam release button (15) and gently shake the iron. Boiling water and steam will come out, carrying scale and deposits that might be there. This could take approximately 5 minutes.
9. Set the temperature selector (14) of the iron to the “max” position, without pressing the steam release button (15). The water in the steam chamber will start evaporating. Wait until all the water inside the steam chamber has evaporated and steam is no longer coming out from the soleplate.
10. To clean the soleplate (19), immediately rub off any residue by running the hot iron over dry cotton cloth.

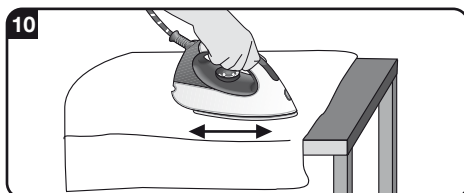
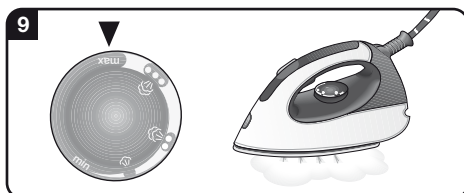
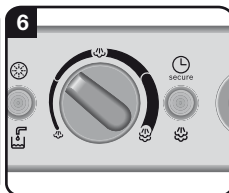
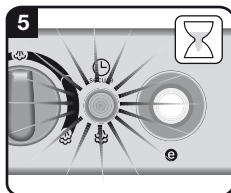
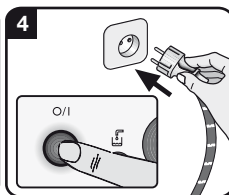
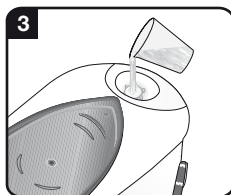
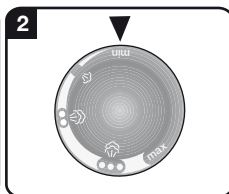
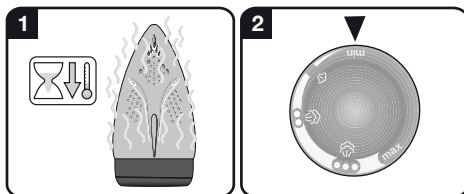



⚠ Always unplug the appliance from the mains supply before carrying out any cleaning or maintenance operation on it.

1. After ironing, pull out the plug and allow the appliance to cool down before cleaning.
2. Wipe the housing, handle and iron body with a damp cotton cloth.
3. If the soleplate is soiled with dirt or scale, clean it with a damp cotton cloth.
4. If the cloth is synthetic, it may melt due to the high temperature on the soleplate (19). Switch off the steam and rub off any residue immediately with a thickly folded, dry cotton cloth.
5. Never use abrasive products or solvents. To keep the soleplate (19) smooth, you should avoid hard contact with metal objects. Never use a scouring pad, or chemicals to clean the soleplate.

17 Storing the appliance



1. Always allow the appliance to cool down before storing it.
2. Set the main power to the "0" position and disconnect the mains cable.
3. Place the iron on the iron pad (2), standing on the soleplate (19).
4. Store the mains cable in the storage compartment (5) and the steam hose in the storage fixing (3). Do not wrap the cords too tight.
5. Use the carrying handles (4) on the sides when moving the appliance.

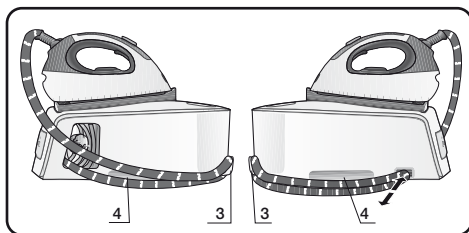

18 Tips to help you save energy



Steam production consumes the most energy. To help minimise the energy used, follow the advice below:

- Start by ironing the fabrics that require the lowest ironing temperature.
- Check the recommended ironing temperature on the label on the garment.
- Regulate the steam according to the selected ironing temperature, following the instructions in this manual.
- Try to Iron the fabrics while they are still damp and reduce the steam setting. Steam will be generated from the fabrics rather than the iron. If you tumble dry your fabrics before ironing them, set the tumble drier on the 'iron dry' programme.
- If the fabrics are damp enough, turn off the steam regulator (10*) completely.

19 Guarantee conditions

The terms of the guarantee for this appliance are in accordance with that stated by our representative for the country in which it is sold. The details of these conditions can be obtained from the retailer from whom the appliance was purchased. The purchase receipt must be presented when making any claims against the terms of this guarantee.

20 Trouble shooting

| Problem | Possible causes | Solution |
|--|--|--|
| The steam generator does not come on. | <ul style="list-style-type: none"> • There is a connection problem. • The main power button / switch (12) is not switched on. | <ul style="list-style-type: none"> • Check the mains cable, the plug and the socket. • Set the main power button / switch to the on position "I". |
| The iron does not heat up. | <ul style="list-style-type: none"> • The main power button / switch (12) is not switched on. • The temperature selector (14) is set to the "min" position. | <ul style="list-style-type: none"> • Set the main power button / switch to the on position "I". • Set the temperature selector to the desired position. |
| The iron begins to smoke when switched on. | <ul style="list-style-type: none"> • During first use: Certain components on the appliance have been lightly greased at the factory and may produce a little smoke when initially heated. • During later use: the soleplate may be soiled. | <ul style="list-style-type: none"> • This is completely normal and will stop after a short while. • Clean the soleplate according to the cleaning instructions in this manual. |
| Water flows through the holes on the soleplate (19). | <ul style="list-style-type: none"> • The steam function is being used before it has reached temperature. • The water is condensing inside the pipes because steam is being used for the first time or has not been used for a long time. • The steam generator contains too much scale. | <ul style="list-style-type: none"> • Reduce the steam flow when ironing at low temperatures by adjusting the variable steam control (10*). • Point the iron away from the ironing area and press the steam release button (15 or 16*) until steam is produced. • Clean the boiler as described in section "Calc'n'Clean". |
| Dirt comes out through the soleplate (19). | <ul style="list-style-type: none"> • There is a build-up of scale or minerals in the boiler. • Chemical products or additives have been used. | <ul style="list-style-type: none"> • Use tap water mixed 50% with distilled or demineralised water. If the tap water in your district is very hard, mix tap water with distilled water 1:2. • Clean the sole plate with a damp cloth. • Never add products to the boiler water. |
| The iron does not produce any steam. | <ul style="list-style-type: none"> • The boiler is not switched on or the water tank (1) is empty. • The steam regulator (10*) is set to the minimum position. | <ul style="list-style-type: none"> • Set the main power button / switch (12) to the on position "I", and/or fill the water tank. • Increase the steam flow by turning the steam control. |

| Problem | Possible causes | Solution |
|--|--|--|
| The ironed garment turns dark and/or sticks to the soleplate. | <ul style="list-style-type: none"> The selected temperature is too high and has damaged the garment. | <ul style="list-style-type: none"> Select a suitable temperature for the material being ironed and clean the soleplate (19) with a damp cloth. |
| The soleplate (19) turns brown. | <ul style="list-style-type: none"> This is a regular consequence of usage. | <ul style="list-style-type: none"> Clean the soleplate regularly with a damp cloth. |
| The appliance makes a pumping sound. | <ul style="list-style-type: none"> Water is being pumped into the steam tank (1). The sound will not stop. | <ul style="list-style-type: none"> This is normal. If the sound will not stop, do not use the steam generator and contact an authorised technical service centre. |
| Loss of pressure during ironing. | <ul style="list-style-type: none"> Steam release button (15) activated for a long period of time. | <ul style="list-style-type: none"> Use the steam release button with intervals. This improves the ironing result as the textiles will be steamed and dried properly giving a smoother result. |
| Waterspots appear on the garment during ironing. | <ul style="list-style-type: none"> May be caused by steam condensed on the ironing board. | <ul style="list-style-type: none"> Wipe the textile cover of the ironing board, and iron the spots without steam to dry them. |
| Water spots appear on the garment during use of the "Ultimate steam" function. | <ul style="list-style-type: none"> Water spots are caused by steam condensation in the hose when cooling down after use. | <ul style="list-style-type: none"> Water drops stop coming out of the soleplate after using the "Ultimate steam"* function for some time. |
| The hose (7) gets hot during use. | <ul style="list-style-type: none"> This is normal. It is caused by the steam passing through the hose during steam ironing. | <ul style="list-style-type: none"> Ensure that the steam generator is positioned to the side of the hand you are using to iron, to reduce contact with the hose as much as possible. |
| Water leakage from the boiler. | <ul style="list-style-type: none"> Drainage plug located at the bottom of the appliance is loose. | <ul style="list-style-type: none"> Tighten up boiler drainage plug with a coin. |
| The iron does not stop steaming after placing it on the pad (2). | <ul style="list-style-type: none"> "Pulse steam" function may have been activated by the double click. The steaming will not stop. | <ul style="list-style-type: none"> Just press the trigger (16*) once again and the iron will stop steaming at once. Contact an authorized technical service centre. |

If the above does not solve the problem, get in touch with an authorized technical service.



Customer Service

Great Britain

Bosch Customer Service

Grand Union House

Old Wolverton Road Milton Keynes

MK12 5PT

UK +44 (0)344 892 8979

IRL +353 (0)1450 2655

www.bosch-home.co.uk

Free Manuals Download Website

<http://myh66.com>

<http://usermanuals.us>

<http://www.somanuals.com>

<http://www.4manuals.cc>

<http://www.manual-lib.com>

<http://www.404manual.com>

<http://www.luxmanual.com>

<http://aubethermostatmanual.com>

Golf course search by state

<http://golfingnear.com>

Email search by domain

<http://emailbydomain.com>

Auto manuals search

<http://auto.somanuals.com>

TV manuals search

<http://tv.somanuals.com>