

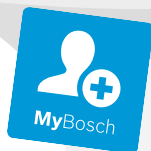

**BOSCH**



# Dishwasher

**SGS2HTI79E**

**[NL]** User manual

## Table of contents

Safety.....	4	Before using for the first time .....	21
General instructions .....	4	First time use.....	21
Destination of the device.....	4	Softening System .....	21
Restriction of users .....	4	Overview of the water hardness settings.....	21
Secure installation.....	4	Set water softening.....	22
Safe use.....	6	Softening salt .....	22
Damaged device .....	7	Switching off water softening.....	23
Dangers for children.....	8	Softening system regenerative run .....	24
Avoiding material damage .....	10	Rinse System .....	24
Safe installation.....	10	Rinse aid .....	24
Safe use.....	10	Setting the rinse aid amount .....	25
Environmental protection and saving.....	11	Switch off rinse system... 25	
Disposing of the packaging .....	11	Detergent .....	25
Saving energy .....	11	Suitable detergents .....	25
Aqua sensor .....	11	Unsuitable dishwashing detergent .....	27
Set up and connect.....	12	Notes on detergents.....	27
Scope of delivery .....	12	Filling detergent .....	27
Setting up and connecting the device.....	12	Crockery.....	28
Waste water connection .....	12	Damage to glass and crockery good .....	29
Drinking water connection .....	13	Loading crockery .....	29
Electrical connection .....	13	Unloading crockery .....	30
Getting to know your device.....	14	The Ministry in essence.....	30
Device .....	14	Switching on the appliance .....	30
Controls.....	15	Set program .....	31
Programs .....	17	Set additional function .....	31
Notes for test institutes .....	18	Making time setting.....	31
Additional Features .....	18	Start program .....	31
Equipment.....	18	Activating key lock .....	31
Upper basket .....	19	Deactivate key lock .....	32
Lower basket .....	19	Interrupt program .....	32
Cutlery basket .....	20	Cancel program .....	32
Folding plate supports .....	20	Switching off the device .....	32
Cutlery basket heights .....	21		

Basic Settings .....	33
Overview of the basic settings	
gen .....	33
Change basic settings.....	34
Cleaning and maintenance.....	34
Cleaning the rinse aid dispenser .....	34
Detergent .....	34
Device maintenance tips.....	34
Machine cleaning . . . . .  .....	34
Sieving System.....	36
Cleaning Spray Arms.....	37
Troubleshooting .....	38
Error code / error indication / signal	
nal .....	38
Washing result .....	40
Indications on the display.....	47
Malfunctions.....	48
Mechanical damage .....	49
Sounds .....	49
Cleaning the drain pump.....	51
Transport, storage and	
disposal.....	51
Disassembling the device .....	51
Making the device frost-proof....	52
Transporting the device .....	52
Disposal of your old device ....	52
Service.....	53
Product number (E-Nr.), production	
number (FD) and serial number (Z-	
Nr.) .....	53
AQUA-STOP guarantee .....	53
Technical data.....	54
Information on Free Software and Open	
Source Software .....	54



## Safety

---

Observe the following safety instructions.

### General instructions

- s Read this manual carefully.
- s Keep the operating instructions and product information for later use or for subsequent owners.
- s Do not connect the device in case of transport damage.

### Destination of the device

Only use the device:

- s to wash dishes.
- s for domestic use and in enclosed spaces within the domestic environment.
- s to an altitude of 4000 m above sea level.

### Restriction of the users

This appliance can be used by children aged from 8 years and above and persons with reduced physical, sensory or mental capabilities or lack of experience and/or knowledge if they are supervised or have been instructed in the safe use of the appliance. and have understood the resulting dangers. Children must not play with the appliance.

Cleaning and user maintenance shall not be made by children unless they are supervised.

Make sure that children under 8 years old cannot reach the device or the connecting cable.

### Safe installation



**WARNING – Risk of injury!**

Improper installations can cause injury.

- ▶ When setting up and connecting the device, follow the instructions in the operating and installation instructions.

**⚠ WARNING – Risk of electric shock!**

s Improper installations are dangerous.

- ▶ Only connect and use the device in accordance with the information on the type plate.
- ▶ Always use the supplied power cord of the new appliance.
  
- ▶ Only connect the device to a mains supply with alternating current via a properly installed earthed socket outlet.
  
- ▶ The protective earth system of the electrical house installation must be installed in accordance with the electrical engineering regulations.
- ▶ Never power the device via an external switching device, e.g. a time switch or remote control.
  
- ▶ When the device is installed, the mains plug of the mains connection cable must be freely accessible, or if free access is not possible, an all-pole disconnecting device must be installed in the permanently installed electrical system in accordance with the installation instructions.
- ▶ When setting up the device, make sure that the mains cable is not pinched or damaged.

s Cutting the supply hose or submerging the AquaStop valve in water is dangerous.

- ▶ Never immerse the plastic housing in water. An electric valve is located in the plastic housing on the supply hose.
  
- ▶ Never cut the supply hose. There are electrical connection lines in the supply hose.

**⚠ WARNING – Risk of fire!**

Using an extended power cord and unauthorized adapters is dangerous.

- ▶ Do not use extension cords or multiple sockets.
  
- ▶ If the power cord is too short, contact the after-sales service.

- ▶ Only use adapters approved by the manufacturer.

 WARNING – Risk of burns!

Improper installation can lead to burns.

- ▶ For free-standing appliances, ensure that the appliances are against a wall with the back.

Safe use

 WARNING – Risk of serious health hazard!

Failure to observe the safety instructions and instructions for use on the packaging of dishwasher detergents and rinse aids can lead to serious health damage.

- ▶ Observe the safety instructions and instructions for use on the packaging of detergents and rinse aids.

 WARNING – Risk of explosion!

s Solvents in the washing area of the device can lead to explosions.

- ▶ Never put solvents in the washing area of the appliance.

s Highly corrosive alkaline or strongly acidic cleaning agents in combination with aluminum objects in the washing area of the appliance can lead to explosions.

- ▶ Never use highly corrosive alkaline or strongly acidic cleaning agents, in particular those for professional or industrial use, in combination with aluminum objects (e.g. grease filters from extractor hoods or aluminum pans) in the dishwasher, e.g. for machine maintenance. maintain.

 WARNING – Risk of injury!

s An open appliance door can lead to injuries.

- ▶ Only open the appliance door for loading and unloading dishes in order to prevent accidents such as tripping.

- ▶ Do not sit or stand on the open appliance door.

s Knives and objects with sharp points can cause injuries.

- ▶ Place knives and objects with sharp points pointing downwards in the cutlery basket, knife holder or cutlery drawer.

 WARNING – Risk of burns!

If the appliance door is opened during the program run, hot water may splash out of the appliance.

- ▶ Only open the appliance door carefully during the program run.

 WARNING – Danger of tipping over!

Overloaded crockery baskets can lead to the appliance tipping over.

- ▶ Never overload the crockery baskets on free-standing appliances.

 WARNING – Risk of electric shock!

s Penetrating moisture can cause an electric shock.

- ▶ Only use the device in closed rooms.
- ▶ Never expose the device to excessive heat and humidity.
- ▶ Do not use a steam cleaner or high-pressure cleaner to clean the appliance.

s Damaged power cord insulation is dangerous.

- ▶ Never bring the connecting cable into contact with hot appliance parts or heat sources.
- ▶ Never bring the power cable into contact with sharp points or edges.
- ▶ Never kink, pinch or alter the power cord.

Damaged device

 WARNING – Risk of electric shock!

s A damaged appliance or power cord is dangerous.

- ▶ Never use a damaged device.

- ▶ Never use a device with a cracked or broken surface.
- ▶ Never pull on the power cord to disconnect the device from the power supply. Always pull the plug on the power cord.
- ▶ If the appliance or the mains cable is damaged, immediately unplug the mains cable from the socket or switch off the fuse in the fuse box and close the tap.

" Contact customer service." → *Page 53*

s Improper repairs are dangerous.

- ▶ Only qualified personnel may carry out repairs on the device.
- ▶ Only original spare parts may be used to repair the device.
  
- ▶ If the power cord of this appliance is damaged, it must be replaced with a special cord available from the manufacturer or its service agent.

Dangers for children

 **WARNING – Risk of suffocation!**

s Children can pull packing material over their head and become entangled and suffocate.

- ▶ Keep packaging material away from children.
- ▶ Do not let children play with packaging material.





s Children can inhale or swallow small parts and choke.

- ▶ Keep small parts away from children.
- ▶ Do not allow children to play with small parts.

s Children can lock themselves in the appliance and suffocate.

- ▶ If present, use the child lock.
- ▶ Never allow children to play with or operate the appliance.



-  **WARNING – Risk of health hazard!**  
Children can lock themselves in the appliance and endanger their lives.
- ▶ In the case of discarded appliances, remove the plug of the mains cable from the socket, then cut the mains cable and damage the lock of the appliance door so that the appliance door no longer closes.
-  **WARNING – Risk of crushing!**  
Children can become trapped between the appliance door and the cupboard doors below with appliances installed high.
- ▶ Watch out for children when opening and closing the appliance door.
-  **WARNING – Risk of chemical burns!**  
Dishwasher and rinse aids can cause burns to the mouth, throat and eyes.
- ▶ Keep children away from detergents and rinse aids.
  - ▶ Keep children away from the opened appliance. The water in the washroom is not drinking water. Residues of detergent and rinse aid may still be left in this.
-  **WARNING – Risk of injury!**  
Children can get their little fingers caught in the slots of the tablet tray and injure themselves.
- ▶ Keep children away from the opened appliance.

## ~~Material damage~~

### avoid

## Safe installation

### PAY ATTENTION!

- s An improper installation of the device can cause damage.
  - ▶ If the dishwasher is under or above other household appliances are installed, the information on installation in conjunction with the dishwasher in the installation instructions for the respective household appliance must be observed.
  - ▶ If no information is available or if the installation manual does not contain any instructions on this subject, check with the manufacturer of these household appliances whether the dishwasher can be built-in above or below other household appliances.
  - ▶ If there is no information from the fabricator is available, the dishwasher must not be installed above or below these household appliances.
  - ▶ To ensure safe operation of all household appliances, you must also follow the installation instructions for the dishwasher.
  - ▶ Do not place the dishwasher under a install hob.
  - ▶ Do not install the dishwasher in near heat sources such as radiators, water heaters, stoves or other appliances that give off heat.

- s Modified or damaged water hoses can lead to material damage and damage to the device.
  - ▶ Never kink water hoses, pinch, modify or cut.
  - ▶ Only supplied water hose or use original spare hoses.
  - ▶ Never used water hoses reuse.
- s Too low or too high water pressure may interfere with the device function.
  - ▶ Make sure the water pressure at the water supply installation is a minimum of 50 kPa (0.5 bar) and a maximum of 1000 kPa (10 bar).
  - ▶ When the water pressure reaches the exceeds the given maximum value, a pressure reducing valve must be installed between the drinking water connection and the hose set of the unit.

## Safe use

### PAY ATTENTION!

- s Emerging water vapor can damage built-in furniture.
  - ▶ The device after the end of allow the program to cool down briefly before opening the appliance door.
- s The rinse aid container can be corrode softening salt for dishwashers.
  - ▶ To ensure that spills out of the softening salt from the rinse aid container, the softening salt must be filled into the water softening salt reservoir immediately before the program starts.

- s Dishwasher detergent can damage the water softener.
  - ▶ The reservoir of the softener  
Only fill the water supply with special salt for dishwashers.
- s Unsuitable detergents can damage the appliance.
  - ▶ Do not use a steam cleaner.
  - ▶ To prevent scratches do not use sponges with a rough surface or abrasive cleaning agents on the surface of the appliance.
  - ▶ To prevent corrosion at dishwashers with a stainless steel front do not use sponge cloths or rinse them well several times before using them for the first time.

---

## m environmental protection and savings

### Disposal of the packaging

The packaging materials are environmentally friendly and can be reused.

- ▶ The individual components on kind of separate disposal.

### Save energy

If you follow these instructions, your appliance will use less electricity and water.

Use the Eco 50° program.

- + The Eco 50° program is energy-saving and environmentally friendly.  
→ "Programs", Page 17

If you only need to wash a few dishes, you can use the Half load option.<sup>1</sup>

- + The program is adapted to the lower load and the consumption values are reduced.

→ "Additional Features", Page 18

### Aquasensor

The aquasensor is an optical measuring device (photocell) with which the turbidity of the washing water is measured. Water can be saved with the aqua sensor. The use of the aquasensor depends on the specific program. In case of heavy soiling, the washing-up water is pumped out and replaced with fresh water. In the case of light soiling, the washing water is also used during the next washing phase and the water consumption can be reduced by 3-6 litres. In the automatic programs, the temperature and running time are also adapted to the degree of soiling.

---

<sup>1</sup> Depending on the device version

---

## Set up and connect

Connect the appliance to electricity and water in a professional manner for correct use. Observe the required criteria and the installation instructions.

### Scope of supply

After unpacking, check all parts for transport damage and for completeness of the delivery.

For complaints, please contact the store where you purchased the device or our customer service.

Remark: The device has been checked at the factory for correct operation. Water stains may remain on the device. The water spots disappear after the first wash cycle.

The delivery consists of:

- s Dishwasher
- s Instructions
- s Assembly instructions
- s Other documents containing information
- s Mounting material
- s Power cord
- s Quick Guide

### Setting up and connecting the device

You can install your under-counter or built-in appliance in the kitchen unit between wooden and plastic walls. If you subsequently install the device as a free-standing device, you must secure the device against tipping over, e.g. by screwing it to the wall or installing it under

a continuous worktop that is permanently connected to the adjacent cupboards.

1. "Observe the safety instructions." → *Page 4*
2. "Observe the instructions for the electrical connection." → *Page 13*
3. Check the contents of the package and the condition of the device.
4. The required installation dimensions can be found in the installation instructions.
5. Level the appliance using the adjustable feet.

Pay attention to a firm stand.

6. "Install the waste water connection." → *Page 12*
7. "Install the drinking water connection." → *Page 13*
8. Connect the device to the power.

### Waste water connection

Connect the appliance to a drain water connection so that the contaminated washing water can be drained.

Install waste water connection

1. The necessary steps can be found in the supplied installation manual.
2. Connect the drain hose to the connection nipple of the siphon using the supplied parts.
3. Make sure that the drain hose is not kinked, crushed or tangled.
4. Make sure that the water does not flow out by a sealing cap in the waste water connection.

## Drinking water connection

Connect the device to a drinking water connection.

### Install drinking water connection

#### Note

s When you replace the device, you can use a new water supply hose.

1. The necessary steps can be found in the supplied installation manual.
2. Connect the device to the drinking water connection using the enclosed parts.  
The "technical data"  
→ *Page 54* consider.
3. Make sure that the drinking water connection is not kinked, crushed or entangled.

## Electrical connection

Connect the device to the mains.

### Connecting the appliance

electrically Notes

s Observe the "Safety  
sing" → *Page 4*.

s Only connect the device on an AC voltage of 220 - 240 V and 50 Hz or 60 Hz.

s Please note that the  
The protection system only works when the device is supplied with power.

1. Connect the appliance plug of the connecting cable to the appliance.
2. Plug the appliance into a socket in the vicinity of the appliance.

The connection data of the device can be found on the type plate.

3. Check the plug for tightness.

## Getting to know your device

### Device

Here you will find an overview of the components of your device.

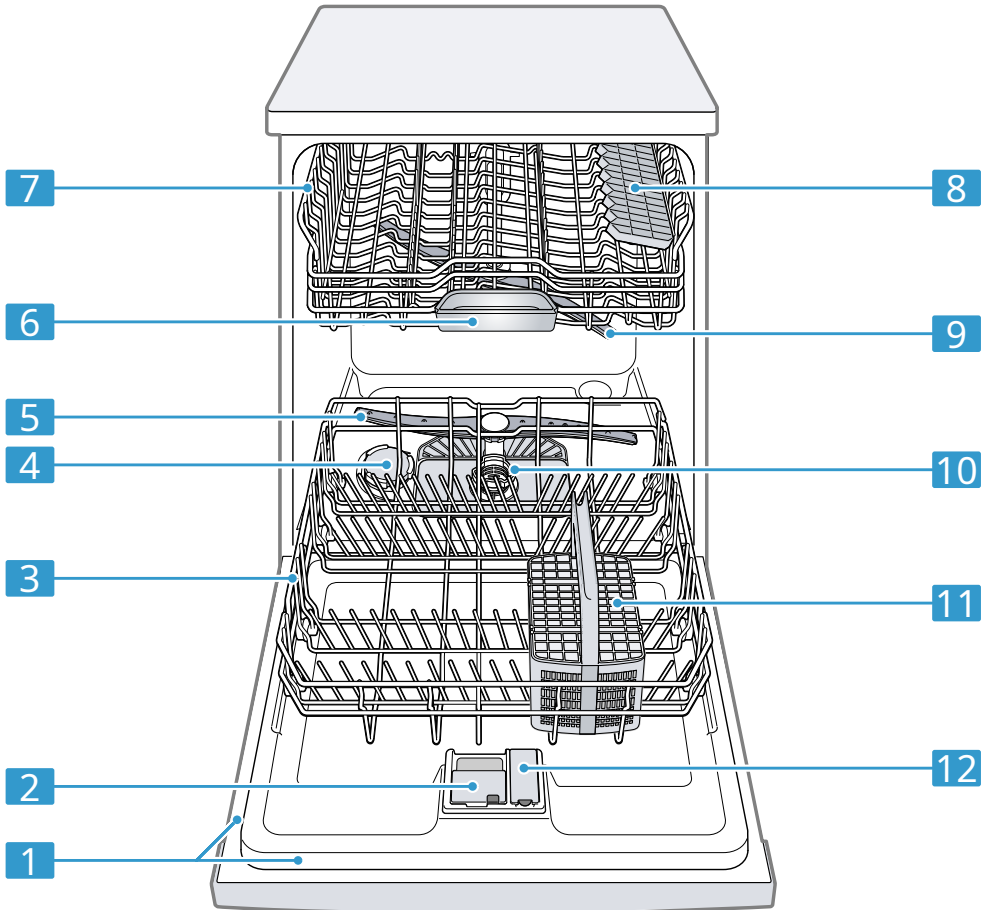

**1** Nameplate

Type plate with "E number and FD number"

→ Page 53.

You need this information for the "service"

→ Page 53.

<sup>1</sup> Depending on the device version

<b>2</b>	Detergent dispenser	Put the "dishwasher detergent" in the detergent dispenser → Page 25.
<b>3</b>	Lower crockery basket	"Lower crockery basket" → Page 19
<b>4</b>	Reservoir for softening salt	Add softening salt to the water softening salt reservoir. → "Softening System", Page 21
<b>5</b>	Lower spray arm	The lower spray arm cleans the dishes in the lower basket. If the dishes do not get optimally clean, clean the spray arms. → "Cleaning the spray arms", Page 37
<b>6</b>	Tablet tray	During the wash cycle, tabs automatically fall from the detergent dispenser into the tablet compartment where the tabs can dissolve optimally.
<b>7</b>	Upper crockery basket	Upper crockery basket
<b>8</b>	Etagère <sup>1</sup>	Etagère
<b>9</b>	Upper spray arm	The upper spray arm cleans the dishes in the upper basket. If the dishes do not get optimally clean, clean the spray arms. → "Cleaning the spray arms", Page 37
<b>10</b>	Sieving System	"Sieve system" → Page 36
<b>11</b>	cutlery basket	"cutlery basket" → Page 20
<b>12</b>	Rinse aid reservoir	Add rinse aid to the rinse aid reservoir.  → "Rinse rinsing system", Page 24

<sup>1</sup> Depending on the device version

## Controls

You can set all functions of your device and obtain information about the operating status via the control panel.

You can perform various functions with a few keys.

## NL Getting to know your device

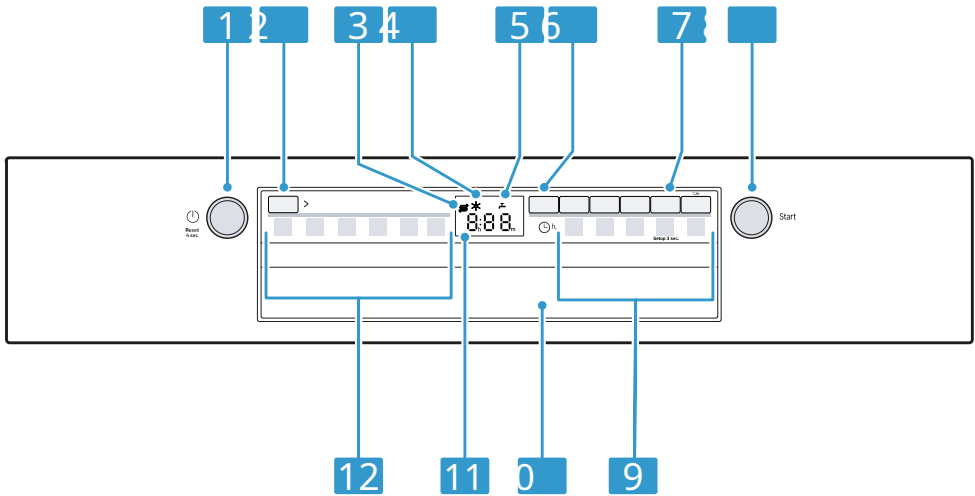

<b>1</b>	ON/OFF button and Reset button Reset 4 sec.	"Turn on device" → Page 30 "Turn off device" → Page 32 "Abort program" → Page 32
<b>2</b>	Program key	"Programs" → Page 17
<b>3</b>	Refill softener salt indicator	"Water softening" → Page 21
<b>4</b>	Refill rinse aid indicator Water	"rinse system" → Page 24
<b>5</b>	supply indicator	Indication for water supply "Create
<b>6</b>	Choose start time	time setting" → Page 31
<b>7</b>	Key Setup 3 sec.	If you press for approx. 3 seconds, open the basic settings.
<b>8</b>	Start button Start	"Start program" → Page 31
<b>9</b>	Program keys and additional functions	"Programs" → Page 17 "Additional Features" → Page 18
<b>10</b>	door opener <sub>1</sub>	Open the appliance door.
<b>11</b>	Display	The display shows information about the time remaining or basic settings. You can change the basic settings via the display and the setting buttons.
<b>12</b>	Programs	"Programs" → Page 17

<sub>1</sub> Depending on the device version







# Programs

Here you will find an overview of the adjustable programs. Depending on the configuration, different programs are offered on the control panel of the device. The running time depends on the selected program. In addition, the running time depends on the water temperature, amount of crockery, degree of soiling and selected additional function. Also a disabled

rinse system or lack of rinse aid affects the run time.

The consumption values can be found in the quick guide. The consumption values apply under normal conditions and a water hardness of 13 - 16 °dH. Various factors, such as water temperature or pipe pressure, can lead to deviations.

Program	Usage	Program sequence	Additional Features
 Intensive 70°	China: s Pots, pans, non-clean delicate crockery and cutlery. Degree of pollution: s Very caked, in-burnt or dried up remove food residues containing starch or protein.	Intensive: s Pre-rinse s Cleaning 70 °C s Intermediate rinse s Rinse aid 69 °C s To dry	All → "Additional Features", Page 18
Auto Auto 45-65°	China: s Mixed crockery and clean cutlery. Degree of pollution: s Slightly dried up, in the household food waste.	Sensor-optimized: s Becomes dependent on the degree of contamination of the washing water is optimized by the sensor system lized.	All → "additional features", Page 18
Eco Eco 50°	China: s Mixed crockery and clean cutlery. Degree of pollution: s Slightly dried up, in the household food waste.	Most economical program: s Pre-rinse s Cleaning 50 °C s Intermediate rinse s Rinse aid 61 °C s To dry	All → "Additional Features", Page 18
 Silent 50	China: s Mixed crockery and clean cutlery. Degree of pollution: s Slightly dried up, in the household food waste.	Sound-optimized: s Pre-rinse s Cleaning 50 °C s Intermediate rinse s Final rinse 63 °C s To dry	All → "Additional Features", Page 18

Program	Usage	Program sequence	Additional Features
 Express 65° - 1h	China: s Mixed crockery and s clean cutlery. Degree of pollution: s Slightly dried up, in the s household usual remove food residues.	Time-optimized: s Cleaning 65 °C s Intermediate rinse s Rinse aid 69 °C s To dry	Extra Dry → "Additional Features", Page 18
 Machine cleaning	Use only with the device removed.	Machine cleaning 70 °C	No

Remark: The relatively longer run time of the Eco 50° program is due to longer soaking and drying times. These enable optimum consumption values.

## Notes for test institutes

Test institutes receive instructions for comparison tests, e.g. according to EN60436.



This concerns the conditions for conducting the tests, not the results or consumption values.

Inquiry by email to:  
[dishwasher@test-appliances.com](mailto:dishwasher@test-appliances.com)  
 The product number (E-No.) and the production number (FD) are required, which you will find on the type plate on the appliance door.

## **E** extra features

Here you will find an overview of the adjustable additional functions. Depending on the configuration, various additional functions are provided on the control panel of the device.

Additional function	Usage
 half load	s With few crockery switch.

Additional function	Usage
 Extra Dry	s Less detergent in the dishwasher then make a bowl for a full load is recommended. s The running time is short. s The water and energy consumption are low.
 Extra Dry	s For an improved dry- the result will be the rinse temperature increased and the drying phase extended. s Particularly suitable for drying plastic parts. s The energy consumption is slightly higher and the maturity increases.

**you**  
**equipment**  
 Here you get an overview of the possible equipment of your device and the way in which you use it. The equipment depends on your device variant.

## Upper crockery basket

Place cups, glasses and small crockery in the upper basket.

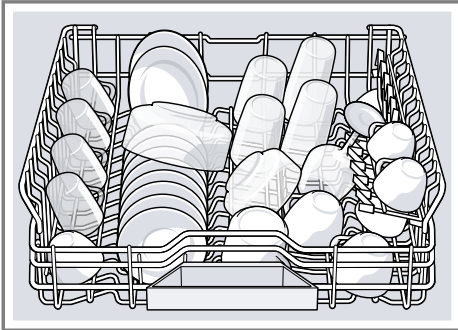

To create space for larger crockery, you can adjust the height of the upper crockery basket.

Adjusting the upper basket with roller pairs

To wash large items of crockery in the crockery baskets, you can adjust the shelf height of the top crockery basket.

1. Pull out the upper basket. Remove
2. the crockery basket.

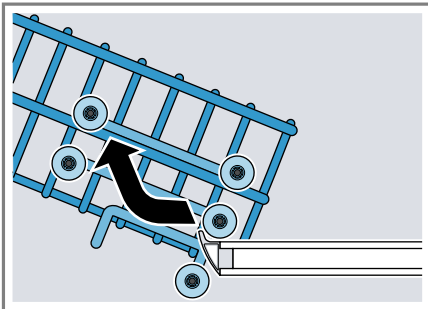

3. Place the basket on the upper rollers (position 3) or the lower rollers (position 1).  
→ "Cutlery basket heights",  
Page 21

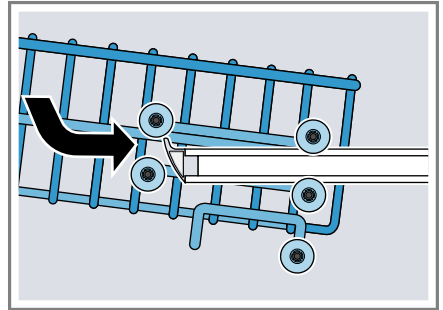

Make sure that the upper crockery basket is level on both sides.

4. Push in the upper basket.

## Lower crockery basket

Place pans and plates in the lower basket.

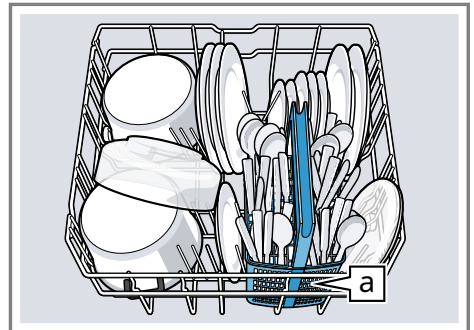

cutlery basket a<sup>1</sup>

Large plates with a diameter of up to 31 cm can be placed in the lower basket as shown.

<sup>1</sup> Depending on the device version

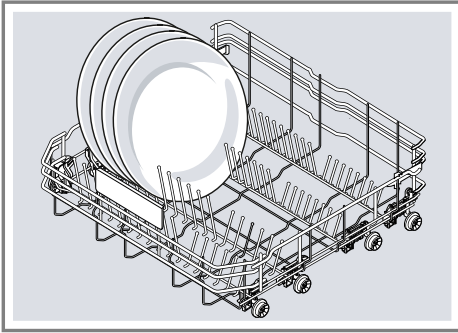

### cutlery basket

Always place the cutlery unsorted with the points downwards in the cutlery basket.

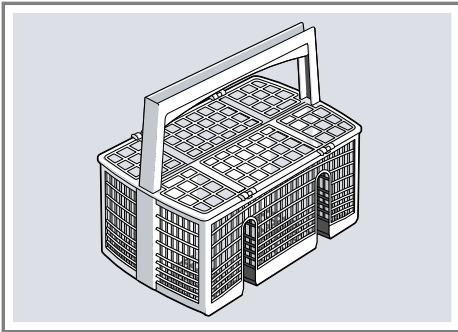

### Foldable plate supports

Use the folding plate supports to safely store crockery such as plates.

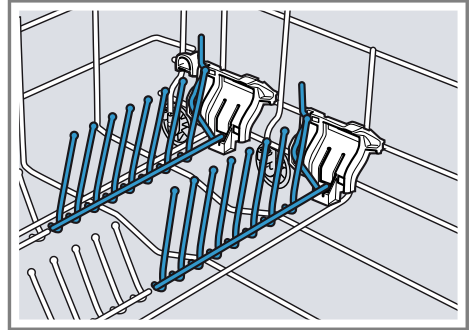

For easier storage of pans, dishes and glasses, you can fold the folding plate supports.<sup>1</sup>

Fold over folding plate supports<sup>1</sup>

If you don't need the flip-up plate supports, flip them over.

1. Push the lever forward and fold over the folding plate supports . ②

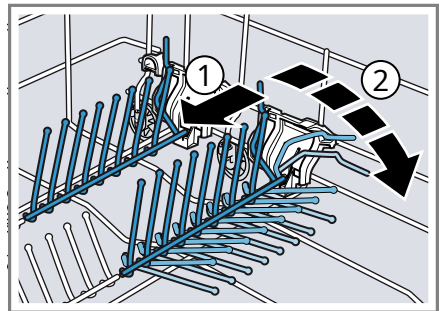

2. To use the folding plate supports again, fold them up.

a The folding plate supports click audibly.

<sup>1</sup> Depending on the device version

## Cutlery basket heights

Adjust the cutlery baskets to the desired height.

Appliance height 81.5 cm with cutlery basket

position	upper basket	lower basket
1 max. ø	22 cm	31 cm
2 max. ø	24.5 cm	27.5 cm
3 max. ø	27 cm	25 cm

## Vfor the first use

<sup>S</sup> set the options for the first use.

### First time use

When using the device for the first time or resetting it to the factory settings, you must make settings.

Required: " The device is set up and connected." → *Page 12*

1. " Fill with softening salt." → *Page 22*
2. " Fill with rinse aid." → *Page 24*
3. " Turn on device." → *Page 30*
4. " Set water softening." → *Page 22*
5. " Set the amount of rinse aid." → *Page 25*
6. The "filling detergent" → *Page 25.*

## Overview of the water hardness settings

Here you will find an overview of the adjustable water hardness values. You can inquire or determine the water hardness from your local water company with a water hardness tester.

Water hardness °dH	Hardness range	mmol/l	Set value
0 - 6	soft	0 - 1.1	H00

7. Start the program with the highest cleaning temperature without dishes.

We recommend that you use the appliance without any dishes before using it for the first time because of possible water stains and other residues.

Tip: You can change these settings and other "basic settings" → *Page 33* change at any time.

## Softening System

Hard, calcareous water leaves limescale residues on the dishes and the rinse aid container and can clog parts of the appliance. For good washing results, you can soften water with the water softener and softening salt. To prevent damage to the device, water with a hardness of more than 7 °dH must be softened.





Water hardness °dH	Hardness range	mmol/l	Set value
7 - 8	soft	1.2 - 1.4	H01
9 - 10	average	1.5 - 1.8	H02
11 - 12	average	1.9 - 2.1	H03
13 - 16	average	2.2 - 2.9	H04
17 - 21	hard	3.0 - 3.7	H05
22 - 30	hard	3.8 - 5.4	H06
31 - 50	hard	5.5 - 8.9	H07

Remark: Set the device to the determined water hardness.  
 → "Setting water softening",  
 Page 22

With a water hardness of 0 - 6 °dH you do not need to use softening salt for dishwashers and you can switch off the water softening.  
 → "Switch off water softening",  
 Page 23

## Set water softening

Set the appliance to the water hardness.

1. Determine the water hardness and the desired setpoint.  
 → "Overview of the water hard-  
 health settings", page 21
  2. on  to press.
  3. Approx. 3 seconds on  Setup 3 sec. Busy-  
 to access the basic settings.
- a The display shows Hxx.  
 a The display shows  to give.
4. Press as many times  until the desired water hardness has been set.  
 The factory setting is H04.
  5. To save the settings, press for approx. 3 seconds  Setup 3 sec.

## softening salt

You can soften the water with softening salt.

### Filling softening salt

If the Refill softener salt indicator lights up, top up the softener salt in the softener salt reservoir immediately before the start of the programme. The required amount of softening salt depends on the water hardness. The higher the water hardness, the greater the amount of softening salt required.

#### PAY ATTENTION!

- s Dishwasher detergent can damage the water damage hardening.
  - ▶ The reservoir of the softener  
 Only fill the water supply with special salt for dishwashers.
- s The rinse aid container can be corrode softening salt for dishwashers.
  - ▶ To ensure that  
 spills out of the softening salt from the rinse aid container, the softening salt must be filled into the water softening salt reservoir immediately before the program starts.

1. Open the lid of the softening salt reservoir and remove it.
2. When using for the first time: fill the reservoir completely with water.
3. Remark: Only use special salt for dishwashers.

Do not use salt tablets. Do not use table salt.

Place the softening salt in the softening salt reservoir.

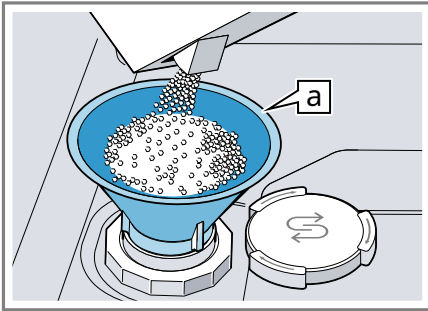

Funnel <sup>a</sup>

Fill the water softening salt reservoir completely with softening salt. The water in the reservoir is displaced and flows away.

4. Fit and close the lid of the reservoir.

## Switch off water softening



If the refilling salt display bothers you, for example if you use a combined dishwasher detergent with a salt component, you can switch off the display.

Remark

To avoid damage to the appliance, only switch off the water softening in the following cases:

s The water hardness is maximum times 21 °dH and you use a combined dishwasher detergent with salt substitutes. According to the manufacturer's instructions, combined dishwasher detergents with salt substitutes can only be used up to a degree of hardness of 21 °dH without adding softening salt.

s The water hardness is 0 - 6 °dH. You do not need to use softening salt.

1. on  to press.
2. Approx. 3 seconds on  Setup 3 sec. Busy- to access the basic settings.

a The display shows Hxx.

a The display shows  to give.

3. Press as many times  until the display shows H00.

4. To save the settings, press for approx. 3 seconds  Setup 3 sec.

a The water softener has been switched on and the refilling salt indicator is deactivated.

<sup>1</sup> Depending on the device version

## Regenerate the softening system

In order to maintain trouble-free operation of the softening system, the device regularly performs a regeneration of the softening system.

The softening system is regenerated in all programs before the end of the main wash cycle. This increases the running time and the consumption values of, for example, water and electricity.

### Overview of the consumption values when regenerating the softening system

Here you will find an overview of the maximum additional runtime and consumption values when regenerating the softening system.

Regenerating the softening system after x washings	6
Additional running time in minutes	7
Additional water consumption in liters	5
Additional electricity consumption in kWh	0.05

The stated consumption values are laboratory measured values, which are determined according to the currently valid standard and based on the Eco 50° program and the factory-set water hardness value of 13 - 16 °dH.

## G lance flushing system

### rinse aid

For optimal drying results it is best to use the rinse aid.

Only use rinse aid for household dishwashers.

### Filling rinse aid

If the rinse aid refill indicator lights up, add rinse aid. Only use rinse aid for domestic dishwashers.

1. Press and lift the tab on the lid of the rinse aid container .  
① ②

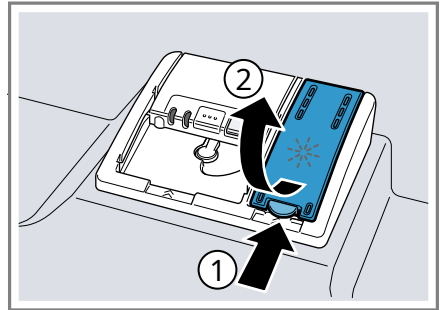

2. Top up the rinse aid up to the max mark.

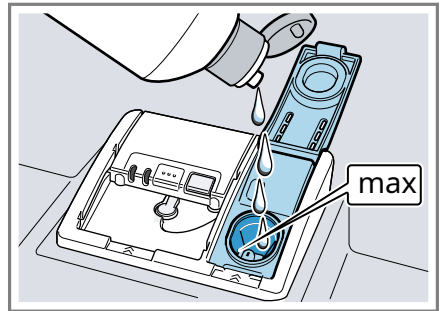



3. If rinse aid has spilled over, it must be removed from the rinse aid container.  
Rinse aid spilled over can cause excessive foaming during the wash cycle.
4. Close the lid of the rinse aid reservoir.  
a The lid audibly clicks into place.





## Set rinse aid amount

If streaks or water spots remain on the dishes, adjust the amount of rinse aid.

1. on  to press.
2. Approx. 3 seconds on  Setup 3 sec. Busy- to access the basic settings.

a The display shows Hxx.

a The display shows  reflected to give.

3. Just as often on  Setup 3 sec. to press until the display shows the factory-set value r05.

4. Press as many times  until the desired amount of rinse aid has been set.

- A low setting adds less rinse aid during the wash cycle, reducing the streaks on the dishes.

- A higher setting adds more rinse aid during the wash cycle, reducing water spots and improving drying results.



5. To save the settings, press for approx. 3 seconds  Setup 3 sec.

## Switch off the rinse system

If the rinse aid refill indicator bothers you, e.g. if you use a combined dishwasher detergent with rinse aid

rinse aid component, you can switch off the rinse aid system.

Tip: The function of the rinse aid is limited in combined detergents. You usually get better results by using rinse aid.

1. on  to press.
2. Approx. 3 seconds on  Setup 3 sec. Busy- to access the basic settings.

a The display shows Hxx.

a The display shows  to give.

3. Press just as often  Setup 3 sec. until the display shows the factory-set value r05.

4. Press as many times  until the display shows r00.

5. To save the settings, press for approx. 3 seconds  Setup 3 sec.

a The rinse aid system is switched on and the rinse aid refill indicator is deactivated.

## V detergent

### Suitable dishwasher detergents

Only use detergents that are suitable for the dishwasher. Suitable for both non-combined and combined dishwashing detergents.

For optimum washing and drying results, use a non-combined detergent in combination with separate "softening salt"  
 → *Page 22* and "rinse agent"  
 → *Page 24*.

Modern, powerful dishwasher detergents usually have a low alkaline recipe with enzymes. Enzymes

break down starch and dissolve proteins. Oxygen-based bleaching agents are usually used to remove colored stains (eg tea or ketchup).

Remark: Follow the manufacturer's instructions for each detergent heed.

Dishwasher detergent	Description
<p><b>Tabs</b></p>	<p>Tabs are suitable for all dishwashing tasks and do not require dosing. With abbreviated "programs" → Page 17 unload tabs may not be completely used, leaving detergent residue. This can negatively affect the cleaning effect.</p>
<p>Dishwasher powder</p>	<p>For abbreviated "programs" → Page 17 is dishwashing powder recommended len. The dosage can be adjusted to the degree of soiling.</p>
<p>liquid dishwashing laundry detergent</p>	<p>Liquid detergents work faster and are used in shortened "programmes". → Page 17 without pre-rinse phase recommended. It may happen that an applied liquid detergent escapes from the detergent dispenser even though it is closed. This is not a malfunction and is not serious if you observe the following:</p> <ul style="list-style-type: none"> <li>s Select only a program without pre-rinse phase.</li> <li>s Do not give time setting for the programs tart in.</li> </ul>

Dishwasher detergent	Description
	<p>The dosage can be adjusted to the degree of soiling.</p>

Tip: Suitable detergents are available online via our website or "service" → *Page 53*.

### Non-combined detergent

Non-combined dishwashing detergents are products which contain no further components in addition to the actual dishwashing detergent. Examples of this are dishwashing powder or liquid dishwashing detergent. With powder and liquid detergent, the dosage can be adjusted to the degree of soiling of the dishes.

For better washing and drying results and to prevent damage to the appliance, it is also recommended to use "softening salt" → *Page 22* and "rinse agent" → *Page 24* to use.

### Combined Dishwasher Detergent

In addition to traditional non-combined dishwashing detergents, a number of products with additional functions are offered. In addition to cleaning agents, these products also contain rinse aid and salt substitutes (3in1) and, depending on the combination (4in1, 5in1, ...) additional components such as glass protection or polish for stainless steel. According to the manufacturer's specifications, combined dishwasher detergents generally only work at water hardness levels of 21 °dH. With a water hardness of more than 21 °dH, you must add softening salt and rinse aid. For optimum washing and drying results, we recommend that you use softening water with a water hardness of 14 °dH or more.

salt and rinse aid. If you use combination detergents, the washing program is automatically adjusted to this to obtain optimum washing and drying results.

## Unsuitable detergent

Do not use detergents that could damage the appliance or harm your health.

Dishwasher detergent	Description
hand dishwashing detergent del	Hand dishwashing liquid can lead to increased foaming and damage to the appliance.
chlorinated dishwasher detergent	Chlorine residue on crockery can endanger health.

## Notes on detergents

Follow the directions for detergents for daily use.

- s Detergents with the indication thing 'Bio' or 'Eco' usually contain (for environmental reasons) smaller amounts of active substances or certain substances even not at all. This may limit the cleaning effect.
- s Adjust the rinse system and the water softening on the uncombined or combined dishwasher detergent used.
- s Combined dishwashing detergents  
According to the manufacturer's instructions, salt substitutes can only be used up to a certain degree of hardness, usually 21 °dH, without adding softening salt. For optimum washing and drying

results, we recommend using softening salt from a water hardness of 14 °dH.

- s Touch dishwashing detergents with an in water-soluble protective packaging only with dry hands and only place it in a dry detergent dispenser to prevent the packaging from sticking.
- s Even when the gloss-top up rinse aid and the top up softener salt indicator lights up, the dishwashing programs are carried out without any problems when combined dishwashing agents are used.
- s The function of the rinse aid del is limited in combination detergents. You usually get better results by using rinse aid.
- s Use tabs with special drying performance.

## Filling detergent

1. Press the lock to open the detergent dispenser.

2. Place detergent in the dry detergent dispenser.

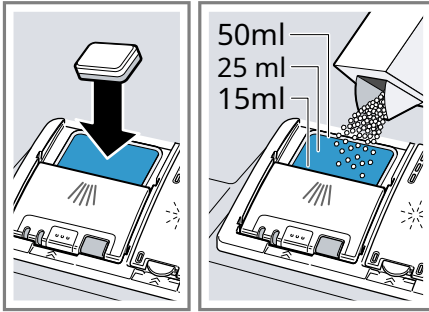

If you use tabs, one tablet is enough. Place tabs across the tray. When using powder or liquid detergent, follow the manufacturer's dosing instructions and the dosing format of the detergent dispenser. With a normal degree of soiling, 20 ml – 25 ml of dishwasher detergent is sufficient. For less soiled crockery, a slightly smaller amount of detergent than indicated is sufficient.

3. Close the lid of the detergent dispenser.

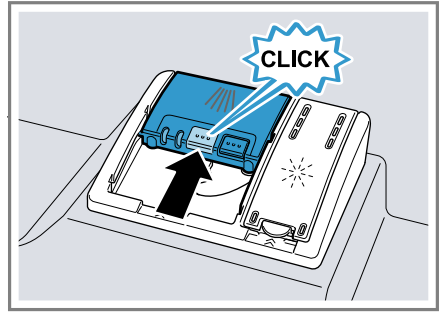

- a The lid audibly clicks into place.
- a The detergent dispenser is depending on the program opens automatically at the optimum time for the program. The dishwashing powder or liquid dishwashing detergent is spread and dissolved in the rinse aid container. Tabs fall into the tablet tray and are dosed dissolved. Do not place any objects in the tablet tray to allow the tab to dissolve evenly.

Tip: If you use powder detergent and select a program with pre-rinse, you can additionally sprinkle some detergent on the inner door of the appliance.

## ~~China~~

Wash only dishwasher-safe crockery in the appliance.

Remark: Glazed crockery and objects made of aluminum and silver can discolour or fade during washing. Sensitive glass can become dull after a few wash cycles.

## Damage to glass and crockery

Prevent damage to glass and ser-dirty stuff.

Cause	Recommendation
The following tableware good is not dishwasher safe: s Pieces of cutlery and crockery from wood s Decorated glass zen, arts and crafts health service and - vases, and antiques crockery s Non heat resistant ge plastic front throw s Crockery from copper and tin s Crockery that with ash, wax, grease and paint is polluted s Very small piece-know crockery	Wash only dishes good that the manufac- turer has ser-resistant is on-marked.
Glass and crockery are not dishwasher safe steadfast.	Only wash glass and porcelain that the manufacturer uses as dishwasher ser-resistant is on-marked.
chemical compound adjustment of the detergent causes damage.	Use a dishwasher medium which has been designated as tableware safe by the manufacturer.

Cause	Recommendation
Highly corrosive alkali chemical or strongly acidic or strongly acidic dishwashing detergents containing dishwashing detergents, in particular detergents used, products for professionals, especially for professional or industrial use, for professional or industrial use in combination use, do not use aluminum with aluminum for minium objects throws are not the washroom of suitable for use in the appliance. the dishwasher.	If you use highly corrosive al-
The water temperature of the program is too high. run.	Select a program with a lower temperature
	Remove glasses and cutlery from the appliance shortly after the end of the programme.

## Sorting out crockery

Arrange the dishes correctly to achieve optimum washing results and to avoid damage to the dishes and the appliance.

### Tips

- s When using the device, you use less energy and water than with manual washing.
- s On our website you will find free examples of how to store the appliance efficiently.
- s To save energy and water load your appliance up to the specified number of standard place settings.  
→ *"Technical data"*,  
Page 54

s For better washing and drying sultaten, place crockery with curves or cavities at an angle so that water can run off.

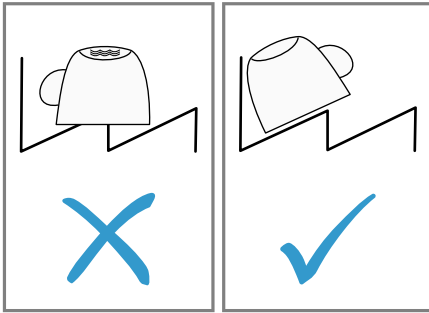

1. Remove coarse food residues from the dishes.

To save natural resources, do not pre-rinse the dishes under running water.

2. Arrange the crockery and observe the following:

- Place heavily soiled crockery such as pans in the lower basket. The stronger spray jet gives you a better washing result.
- Place dishes in a safe and stable position in the appliance to prevent damage to the dishes.
- Arrange cutlery with the pointed and sharp side down to avoid injuries.
- Place dishes with the opening downwards so that no water remains in them.
- Do not block the spray arms so that they can rotate.
- Do not place small objects in the tablet container and do not block this compartment with dishes so as not to block the lid of the detergent dispenser.

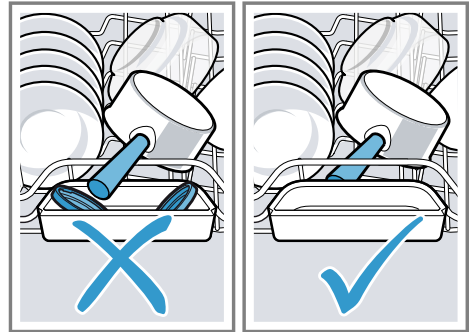

## Clearing crockery

### WARNING

Risk of injury!

Hot dishes can cause burns. Hot crockery is sensitive to impact and can cause injury if broken.

► Crockery after the end of the programme let it cool down for a while and only then remove it.

1. To avoid water drops falling on the dishes, unload the dishes from bottom to top.

2. Check the rinse aid reservoir and accessories for contamination and clean if necessary.

→ "Cleaning and maintenance",  
Page 34

## ~~The Ministry in essence~~

## Switch on device

► on  to press.

The Eco 50° program is preset.

The Eco 50° program is a very environmentally friendly program and ideal for normally soiled crockery. It is

the most efficient program in terms of energy and water consumption for this type of crockery and complies with the EU Ecodesign Regulation.  
If you do not operate the device for 10 minutes, the device will switch off automatically.

## Set program

You can adjust the wash cycle to the degree of soiling of the crockery by setting a suitable programme.

- ▶ Just as often on the program button until the desired program is set.  
→ *"Programs", Page 17*
- a The program is set and the LED flashes.
- a The remaining program run time appears on the display.

## Set additional function

In addition to the selected washing program you can set additional functions.



Remark: The available additional functions depend on the selected program.

→ *"Programs", Page 17*

- ▶ Press the button of the desired extra press function.  
→ *"Additional Features", Page 18*
- a The additional function is set and the button of the additional function flashes.

## Make time setting

You can delay the start of the program for up to 24 hours.

1.  impressions.
- a The display shows "h:01".
2. With  the desired programs set tart.

3. Start impressions.
- a The time setting is activated.

Tip: The time setting is deactivated by pressing  repeatedly until "h:00" appears on the display.

## Start program

- ▶ Press  Start.
- a The program has ended when down the display shows "0h:00m".

### Remarks



- s If you want to add crockery while the appliance is already in operation, do not use the tablet container as a handle for the upper basket. This will allow you to come into contact with the partially dissolved tab.
- s You can view the current program change by canceling the program.

→ *"Abort program", Page 32*

- s To save energy, it is appliance switches off automatically 1 minute after the end of the programme. If you open the door immediately after the program has ended, the appliance will switch off after 4 seconds.

## Activate key lock

The key lock prevents the device from being operated accidentally or improperly while it is in operation.

- ▶ Approx. 3 seconds on  to press.
- a The key lock is activated and is automatically deactivated at the end of the program spring.
- a When the device is operated, flashes on  the display.

## NL The Ministry in essence



- a In the event of a power failure, the key-blocking activated.

## Deactivate key lock

- ▶ Approx. 3 seconds on  to press.

## Pause program

Remark: If you open the appliance door when the appliance has heated up, it is best to leave the appliance door ajar for a few minutes and then close it. In this way you prevent an overpressure occurring in the appliance and the appliance door from jumping open.

1. on  to press.
  - a The program is saved and the device turns off.
2. on  press to continue the program.

## Cancel program

To end a program prematurely or to change a program that has started, you must cancel the active program.

- ▶ Approx. 4 seconds on **Reset 4 sec.** to press.
  - a All indicators are lit.
  - a Once the indicators are off, "0h:01m" appears on the display and the remaining water is dispensed pumps.
  - a The program is aborted and is closed after approx. 1 minute.

## Switch off device

1. The instructions on "safe use" → *Page 10* consider.
2. on  to press.

**Tip:** If you press  is pressed, the current program is interrupted. When you switch on the appliance, the program continues automatically.



## Basic settings

You can set up your device according to your needs.



### Overview of the basic settings

The basic settings depend on the equipment of your appliance.

Basic setting	Display text	Choise	Description
Water hardness	H04 <sup>1</sup>	H00 - H07	Set the water softener to the water hardness. → "Setting water softening", Page 22 At position H00, the water softening is switched off.
rinse aid lilac	r05 <sup>1</sup>	r00 - r06	Set the amount of rinse aid.  → "Amount of rinse aid set", page 25 Switch off the rinse aid with position r00.
Intensive drying	d00 <sup>1</sup>	d00 - d01	When rinsing, the temperature is increased, which results in better drying results. As a result, the run time may increase slightly. Remark: Not suitable for delicate items of crockery. Switch on intensive drying "d01" or switch off "d00".
hot water	A00 <sup>1</sup>	A00 - A01	Set cold water connection or hot water connection. Only set the device to Hot water if the hot water is prepared in an energetically favorable manner and a suitable installation is available, eg a solar boiler with circulation pipe. The water temperature must be a minimum of 40 °C and a maximum of 60 °C. Switch on hot water "A01" or switch off "A00".
Factory setting	re	YES	Reset changed settings to the factory state. The settings for the first start-up must be specified.

<sup>1</sup> Factory setting (may differ depending on the device type)

## Change basic settings

1. on  to press.
2. Approx. 3 seconds on  Setup 3 sec. Busy- to access the basic settings.

a The display shows Hxx.

a The display shows  reflected to give.

3. Just as often on  Setup 3 sec. to press until the display shows the desired setting.

4. Press as many times  until the display shows the desired value.

You can change several settings.

5. To save the settings, approx. 3 seconds on  Setup 3 sec. to press.

## R

### cleaning and maintenance

Carefully clean and maintain your appliance to ensure that it continues to work properly for a long time.

### Cleaning the rinse aid container

 **WARNING**  
Risk of health hazard!

The use of chlorinated cleaning agents can lead to health damage.

- ▶ Never use chlorinated cleaning agents using resources.

### Machine cleaning

Deposits can cause malfunctions in the appliance, eg due to food residues and limescale. To avoid malfunctions and the formation of nasty

1. Remove coarse soiling in the interior with a damp cloth.
2. Pour detergent into the detergent dispenser.
3. Select the program with the highest temperature.  
→ "Programs", Page 17
4. " Start the program without dishes." → Page 31

### Detergent

Only use suitable cleaning agents to clean the appliance.

→ "Safe use", Page 10

### Device maintenance tips

Observe the appliance maintenance tips in order to maintain the function of the appliance for a long time.

Measure	Benefit
The door seals, and operating parts clean and nining panel of the dishwasher regular wipe with a moisturizing cloth and a little washing-up liquid.	This keeps the front and operating parts clean and hygienic.
Open the appliance door stand ajar if the dishwasher longer time is not used.	This prevents the ming of bad smells vortex.

To reduce odours, it is recommended to clean the appliance at regular intervals. Machine cleaning, in combination with machine care products and machine cleaners, is the right program for cleaning the machine.

honeycomb.

Tip: You can order our tested and approved machine care products and machine cleaners for dishwashers via <https://www.bosch-home.com/store> or our service department.

Machine cleaning is a program that removes several deposits in one rinse cycle. The cleaning is done in two stages:

Phase	Remove from	Detergent	Placement
1	Fat and Lime	Liquid machine care product or powdered machine descaler.	Interior of the appliance, e.g. bottle hung in the cutlery basket or powder in the interior.
2	Food Residues and Disposal- things	Machine Cleaner	Detergent dispenser

For optimum cleaning performance, the program doses the cleaners separately from each other in the respective cleaning phase. This requires the correct placement of the cleaning agents.

If the Machine Cleaning indicator on the control panel lights up or the display prompts you to do so, carry out Machine Cleaning without any dishes. After you have performed Machine Cleaning, the indicator will go out. If the device does not have a reminder function, we recommend that you perform the machine cleaning every 2 months.

#### Perform machine cleaning

If the Machine Cleaning indicator on the control panel lights up or the display prompts you to do so, run the Machine Cleaning programme.

#### Remarks

s Run the Machine cleaning program went out without any crockery.

s Use only for dishwashing suitable machine care products and machine cleaners.

s Make sure that there are no aluminum objects, such as grease filters from extractor hoods or aluminum pans, are in the washing compartment of the appliance.

s If you do not complete the Machine Cleaning If you carry out 3 washing cycles, the indicator for Machine cleaning goes out automatically.

s In order to obtain the optimum cleaning performance To obtain this, pay attention to the correct placement of the cleaners.

s Take the safety precautions on the packaging of machine care products and machine cleaners.

1. Remove coarse soiling in the interior with a damp cloth.

2. Clean the seven.

3. Place the machine care product in the interior of the machine.

Only use machine care products especially suitable for dishwashers.

4. Pour the machine cleaner into the detergent dispenser until it is completely filled.

Do not put any additional machine cleaner into the interior of the device.

5.  impressions.

6. Start impressions.

a Machine cleaning is in progress.

a Once the program is complete, the machine cleaning indicator goes out.

### Sieving System

The sieve system filters coarse impurities from the rinsing circuit.

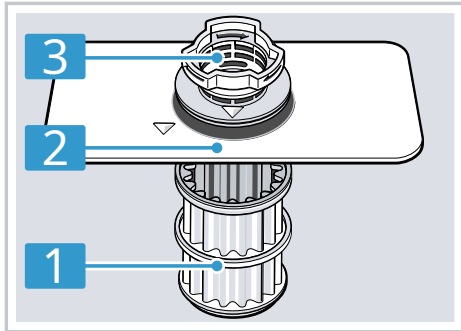

1 micro sieve

2 fine sieve

3 coarse sieve

### Cleaning sieves

Contaminants from the wash water can clog the sieves.

1. After each wash, check the sieves for food residues.

2. Turn the coarse sieve counterclockwise and remove the sieve system take . ②
  - s Make sure that no foreign objects fall into the pump reservoir.

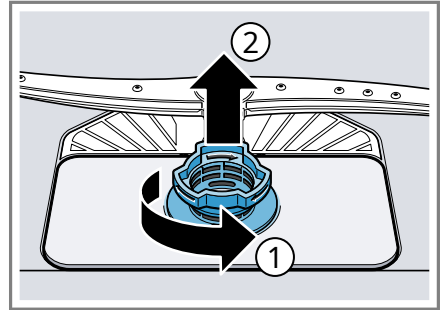

3. Pull the micro sieve downwards.

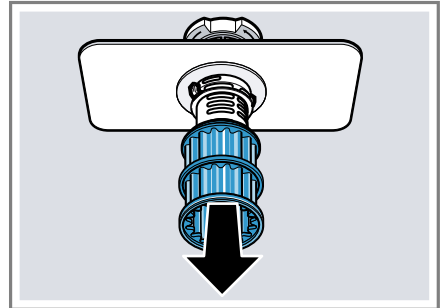

4. Press the locking pieces together and remove the coarse sieve remove upwards . ②

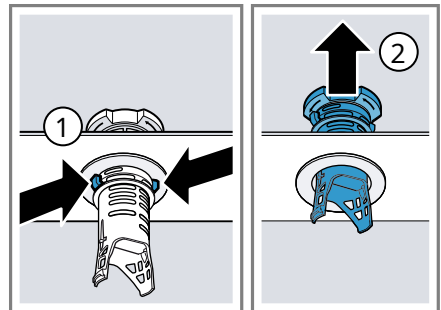

5. Clean the sieve elements under running water.  
Carefully clean the dirt edge between the coarse and fine sieve.
6. Assemble the screening system.  
Check whether the locking lugs of the coarse sieve are engaged.
7. Insert the sieve system into the device and turn the coarse sieve clockwise.  
Check that the arrow marks are opposite each other.

## Cleaning spray arms

Limescale and impurities in the wash water can block the nozzles and bearings of the spray arms. Clean the spray arms regularly.

1. Unscrew the upper spray arm and pull it downwards  
①.  
②.

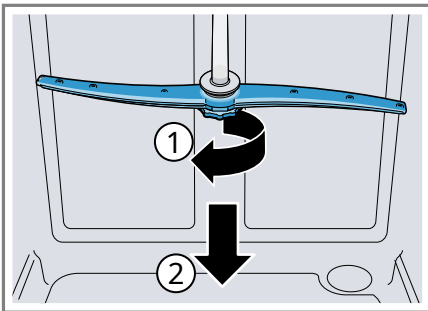

2. Pull the lower spray arm upwards.

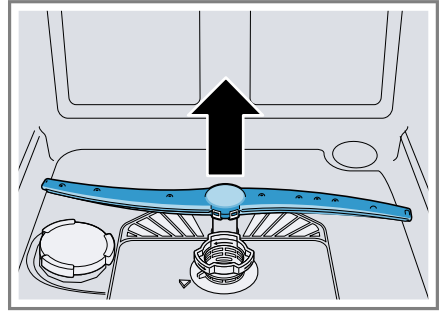

3. Check the nozzles of the spray arms for blockages under running water and remove any foreign objects.
4. Install the lower spray arm.
- a The spray arm audibly clicks into place.
5. Fit and screw on the upper spray arm.

## Troubleshooting

---

You can remedy minor faults on the device yourself. Before contacting customer service, please refer to the troubleshooting information. This way you avoid unnecessary costs.



### WARNING

Risk of electric shock!

Improper repairs are dangerous.

- ▶ Only qualified personnel may carry out repairs on the device to carry out.
- ▶ Only original spare parts may be used for repair of the device.
- ▶ If the power cord of this appliance is damaged, it must be replaced by a special cord available from the manufacturer or service deputy service.



### Error code / error indication / signal

Malfunction	Cause	Troubleshooting
E:20-60 lights up alternately.	The appliance has detected a calcified heating element.	<ol style="list-style-type: none"> <li>1. Descale the appliance.</li> <li>2. Use the appliance with the water softener.<sup>1</sup></li> </ol>
E:30-00 lights up alternately.	Aquastop system is activated.	<ol style="list-style-type: none"> <li>1. Close the tap.</li> <li>2. Contact the "service department" → Page 53.</li> </ol>
E:31-00 lights up alternately.	Aquastop system is activated.	<ol style="list-style-type: none"> <li>1. Close the tap.</li> <li>2. Contact the "service department" → Page 53.</li> </ol>
E:34-00 lights up alternately.	Water flows continuously into the device.	<ol style="list-style-type: none"> <li>1. Close the tap.</li> <li>2. Contact the "service department" → Page 53.</li> </ol>
E:32-00 lights up alternately or the water supply indicator lights up.	Water inlet hose is kinked.	▶ Lay the water inlet hose of kinks.
	Tap is closed.	▶ Turn on the tap.
	Tap is clogged or calcified.	▶ Turn on the tap. The amount of water flowing in when the tap is open is at least 10 l/min.

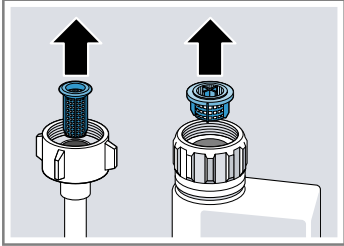
<sup>1</sup> Depending on the device version

Malfunction	Cause	Troubleshooting
E:32-00 lights up alternately or the water supply indicator lights up.	The sieves in the water connection inlet or AquaStop hose are clogged.	<ol style="list-style-type: none"> <li>1. Switch off the device.</li> <li>2. Remove the plug from the socket.</li> <li>3. Turn off the tap.</li> <li>4. Unscrew the water connection.</li> <li>5. Remove the strainer from the inlet hose</li> </ol>  <ol style="list-style-type: none"> <li>6. Clean the strainer.</li> <li>7. Place the strainer in the supply hose.</li> <li>8. Screw on the water connection.</li> <li>9. Check the water connection for leaks.</li> <li>10. Put the plug back in the socket.</li> <li>11. Switch on the device.</li> </ol>
E:92-40 lights up alternately.	Strainers are dirty or clogged.	<p>► Clean the sieves. → "Cleaning Sieves", Page 36</p>
E:61-03 lights up alternately. The water is not pumped out.	Drain hose is clogged or kinked.	<ol style="list-style-type: none"> <li>1. Route the drain hose without kinks.</li> <li>2. Remove the remains.</li> </ol>
	Siphon connection is still closed.	<p>► Check the connection to the fon and open it if necessary.</p>
	Drain pump cover is loose.	<p>► Remove the cover of the "drain pump" → Page 51 well fixed.</p>
E:61-02 lights up alternately.	Drain pump is blocked.	<p>► Clean the drain pump. → "Clean the drain pump", Page 51</p>
	Drain pump cover is loose	<p>► Remove the cover of the "drain pump" → Page 51 well fixed.</p>

## NL Troubleshooting

Malfunction	Cause	Troubleshooting
E:90-01 lights up alternately.	Mains voltage is too low.	<p>There is no error in the device.</p> <ol style="list-style-type: none"> <li>1. Contact an electrician.</li> <li>2. Have the mains voltage and electrical installation checked by the electrician.</li> </ol>
<p>Another one appears error code in the indicator - present.</p> <p>star.</p> <p>E:01-00 to E:90-10</p>	There is a technical malfunction	<ol style="list-style-type: none"> <li>1. Press . </li> <li>2. Disconnect the appliance from the mains or switch off the fuse.</li> <li>3. Wait at least 2 minutes.</li> <li>4. Plug the appliance into a mains socket or switch on the fuse.</li> <li>5. Switch on the device.</li> <li>6. If the problem occurs again: <ul style="list-style-type: none"> <li>s Press </li> <li>s Close the tap.</li> <li>s Remove the plug from the socket.</li> <li>s Contact the "service department" <ul style="list-style-type: none"> <li>→ Page 53 and mention the error code.</li> </ul> </li> </ul> </li> </ol>

## Washing result

Malfunction	Cause	Troubleshooting
Crockery is not dry.	No rinse aid has been used or the dosage is set too low.	<ol style="list-style-type: none"> <li>1. Fill the "rinse agent" <ul style="list-style-type: none"> <li>→ Page 24 Bee.</li> </ul> </li> <li>2. Set the amount of rinse aid. <ul style="list-style-type: none"> <li>→ "Amount of rinse aid set", page 25</li> </ul> </li> </ol>
	The program or program option has no drying phase or a drying phase that is too short.	<p>" Select a program with drying, e.g. Intensive, Strong or ECO program." → Page 17</p> <p>The drying result is reduced with some option buttons, eg Variospeed.</p>

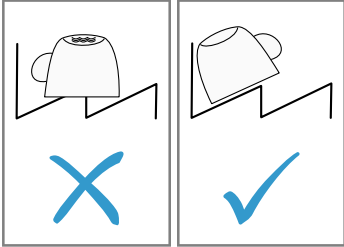

Malfunction	Cause	Troubleshooting
Crockery is not dry.	Water remains in cavities of crockery and cutlery to stand.	<p>▶ Arrange the crockery at an angle as right in.</p> 
	The combined detergent has poor drying performance.	<ol style="list-style-type: none"> <li>1. Use rinse aid to improve drying performance.</li> <li>2. Use another combination detergent with better drying performance.</li> </ol>
	Extra dry for enhanced drying is not activated.	▶ Activate Extra Dry.
	Crockery is out too early cleared or the drying process had not yet ended.	<ol style="list-style-type: none"> <li>1. Wait for the program end.</li> <li>2. Do not remove the dishes until 30 minutes after the end of the programme.</li> </ol>
	Used rinse aid has limited drying performance.	<p>▶ Use a quality rinse aid <small>resource</small>.</p> <p>Eco-products may have a limited effect.</p>
Plastic crockery is not dry.	No fault. Due to a bearing heat storage capacity dries plastic worse.	▶ No solution available.
Cutlery is not dry.	Cutlery is not properly placed in the cutlery basket or drawer.	<p>Drops may form at the touch points of the cutlery.</p> <ol style="list-style-type: none"> <li>1. " If possible, arrange the cutlery separately from each other." → Page 29</li> <li>2. Avoid touch points.</li> </ol>

Malfunction	Cause	Troubleshooting
Insides of the appliance are wet after the wash cycle.	No malfunction. For condensation drying, water drops in the rinse aid container are necessary and desirable. The moisture in the air condenses on the inner walls of the appliance, flows downwards and is pumped out.	No action required. No action required.
Food remains on the crockery.	Crockery is placed too close together or the basket is too full.	<ol style="list-style-type: none"> <li>1. Arrange the crockery with sufficient space between them. The spray jets must be able to reach the surface of the dishes.</li> <li>2. Avoid touch points.</li> </ol>
	Spray arms cannot rotate freely.	▶ Arrange the crockery in such a way that it dishes do not interfere with the rotation of the spray arm.
	Spray arm nozzles are clogged.	▶ Clean the "spray arms" → Page 37.
	The seven are polluted.	▶ Clean the sieves. → "Cleaning Sieves", Page 36
	The strainers are incorrectly fitted and/or not secured.	<ol style="list-style-type: none"> <li>1. Apply the sieves properly. → "Sieve System", Page 36</li> <li>2. Secure the seven.</li> </ol>
	Washing program too weak chosen.	▶ Select a more powerful rinse program <b>mom.</b> → "Programs", Page 17
	Crockery has been pre-cleaned too well. The sensor system therefore opts for a weak washing program. Stubborn dirt cannot be partially removed.	▶ Only remove coarse food residues and do not pre-rinse the dishes.
	High, narrow items of crockery are insufficiently spread out in the corners. flushed.	▶ Ample high, narrow pieces of crockery well not too oblique and not in the corners.
	The upper basket is not set to the same height on the right and left.	▶ Upper basket left and right to the same height.

Malfunction	Cause	Troubleshooting
Detergent residue in the device	<p><b>Detergent Lid</b> The drawer is blocked by crockery and will not open.</p>	<p>1. Arrange the dishes in the upper basket in such a way that the tablet tray is not blocked by dishes. → "Clearing crockery", Page 29</p> <p>Pieces of crockery are blocking the lid of the detergent dispenser.</p> <p>2. Do not place crockery or fragrance dispenser in the tablet container.</p>
	<p>The lid of the detergent dispenser is blocked by the tab and will not open.</p>	<p>▶ Place the tab crosswise in the dishwasher medium tray and not on the narrow side.</p>
	<p>Tabs are used in the quick program or short program. Dissolving time of the tab is not reached.</p>	<p>▶ Choose a more powerful "program" → Page 17 or use "dishwasher powder" → Page 25.</p>
	<p>Cleaning effect and dissolving behavior decrease with longer storage time, or the detergent clots strongly.</p>	<p>▶ Change from "dishwasher detergent" → Page 25.</p>
There are water stains on plastic parts.	<p>Droplet formation on plastic surfaces is physically unavoidable. Water stains are visible after drying.</p>	<p>▶ Choose a more powerful program. → "Programs", Page 17</p> <p>▶ Arrange the crockery at an angle. → "Clearing crockery", Page 29</p> <p>▶ Use rinse aid. → "Rinse aid", Page 24</p> <p>▶ Set the water softener higher.</p>
There are wipeable or water-soluble deposits in the interior or on the door of the appliance.	<p>Components of the detergent are deposited. This deposit usually cannot be removed chemically.</p>	<p>▶ Change from "dishwasher detergent" → Page 25.</p> <p>▶ Clean the device mechanically.</p>
	<p>White deposits form inside the appliance.</p>	<p>1. Set the water softener correctly. In most cases you will need to increase the setting.</p>

## NL Troubleshooting

Malfunction	Cause	Troubleshooting
There are wipeable or water-soluble deposits in the interior or on the door of the appliance.		2. Change the detergent if necessary.
	The softening salt reservoir is not closed.	▶ Turn the softening salt container closed.
	Components of the detergent are deposited. This deposit usually cannot be removed chemically.	▶ Change from "dishwasher detergent" → Page 25. ▶ Clean the device mechanically.
	Water hardness is set incorrectly or water hardness is higher than 50 °dH (8.9 mmol/l).	▶ Set the water softening to the water hardness or top up with softening salt.
	3in1 detergent, biodetergent or eco-detergent is insufficiently effective.	▶ Set the water softening to the water hardness and use separate agents (quality cleaning agent, softening salt, rinse aid).
There is white, difficult removable deposits on the crockery or the interior or door of the appliance.	Detergent is dosed too low.	▶ Increase the dose of the dishwashing detergent or change "dishwasher detergent" → Page 25.
	Washing program too weak chosen.	▶ Select a more powerful rinse program mom. → "Programs", Page 17
	Washing temperature is too low.	▶ Select a program with a high re wash temperature. → "Programs", Page 17
Tea or lipstick residue on the dishes.	Dishwasher detergent has been dosed too low or is unsuitable.	▶ Use a suitable "dishwasher detergent" share" → Page 25 and dose it according to the manufacturer's instructions.
	Crockery has been pre-cleaned too well. The sensor system therefore opts for a weak washing program. Stubborn dirt cannot be partially removed.	▶ Only remove coarse food residues and do not pre-rinse the dishes.

Malfunction	Cause	Troubleshooting
There are colored (blue, yellow, brown), difficult or non-removable deposits in the interior of the appliance or on stainless steel dishes.	Layering occurs due to the components of vegetables (cabbage, celery, potatoes, noodles, ...) or tap water (manganese).	<p>► Clean the device.</p> <p>You can remove the deposits with a "mechanical cleaning" → Page 34 or remove a machine cleaner. The deposit can not always be completely removed, but it is not harmful to health.</p>
	Metal components cause filming on silver or aluminum crockery.	<p>► Clean the device.</p> <p>You can remove the deposits with a "mechanical cleaning" → Page 34 or remove a machine cleaner. The deposit can not always be completely removed, but it is not harmful to health.</p>
There are colored (yellow, orange, brown) deposits that are easy to remove in the interior of the appliance (especially on the bottom).	Layers are formed by components of food residues and tap water (lime), 'soapy'.	<ol style="list-style-type: none"> <li>1. Check the water softening setting.</li> <li>2. Top up with softening salt. → "Filling softening salt", Page 22</li> <li>3. If you use combination detergents (tabs), activate the water softening. Follow the directions for the detergents. → "Notes on detergents share", Page 27</li> </ol>
Plastic parts inside the appliance are discolored.	Plastic parts in the interior may discolour during the life of the dishwasher.	<p>► Discoloration may occur, but they do not adversely affect the operation of the appliance.</p>
Plastic parts are discolored.	<p>Washing temperature is too low.</p> <p>Crockery has been pre-cleaned too well. The sensor system therefore opts for a weak washing program. Stubborn dirt cannot be partially removed.</p>	<p>► Select a program with a high re wash temperature. → "Programs", Page 17</p> <p>► Only remove coarse food residues and do not pre-rinse the dishes.</p>
There are removable smudges on glasses, glassware with a metallic appearance and cutlery.	The amount of rinse aid is set too high.	<p>► Set the rinse system to a lower position.</p>

## NL Troubleshooting

Malfunction	Cause	Troubleshooting
There are removable smudges on glasses, glassware with a metallic appearance and cutlery.	There is no rinse aid ► added.	→ "Fill rinse aid", Page 24
	Residual detergent is present during the rinse cycle part of the program. Detergent dispenser lid was blocked by dishes and did not open fully.	<ol style="list-style-type: none"> <li>1. Arrange the dishes in the upper basket in such a way that the tablet tray is not blocked by dishes. → "Clearing crockery", Page 29 Pieces of crockery are blocking the lid of the detergent dispenser.</li> <li>2. Do not place crockery or fragrance dispenser in the tablet container.</li> </ol>
	Crockery is too good for ► cleaned. The sensor system therefore opts for a weak washing program. Stubborn dirt cannot be partially removed.	Only remove coarse food residues and do not pre-rinse the dishes.
Irreparable glass clouding.	Glasses are not dishwasher- ► chineproof, but only suitable for dishwasher.	Use dishwasher-safe glasses. Glasses are suitable for cleaning in a dishwasher, but long-term wear and changes must be taken into account.
		<ul style="list-style-type: none"> <li>► Avoid a long steam phase (standing time) at the end of the wash cycle.</li> <li>► Use a program with a lower temperature. → "Programs", Page 17</li> <li>► Set the water softening to the water hardness.</li> <li>► Use a dishwasher detergent with glass protection components.</li> </ul>
Rust traces on the cutlery.	Cutlery is not sufficiently rust resistant. Knife blades are often more affected by this.	► Use rust-resistant cutlery.

Malfunction	Cause	Troubleshooting
Rust traces on the cutlery.	Cutlery also rusts when it is together with rusty objects are washed.	▶ Do not wash rusting objects off.
	Salt content in the washing water is too high.	<ol style="list-style-type: none"> <li>1. Remove spilled softening salt from the rinse aid container.</li> <li>2. Tightly close the lid of the softening salt reservoir.</li> </ol>
There are detergent residues in the detergent dispenser or in the tablet dispenser.	The spray arms were blocked by crockery, which prevented the detergent from being rinsed away.	▶ Make sure the spray arms are not locked and free to rotate.
	Dishwasher detergent dispenser laundry damp when filling the detergent.	▶ Only put the detergent in a dry detergent dispenser.
Abnormal foaming present.	There is hand dishwashing liquid in the rinse aid reservoir.	▶ Fill rinse aid directly into the reservoir. → "Fill rinse aid", Page 24
	Rinse aid has been spilled.	▶ Remove the rinse aid with a cloth.
	Used detergent or cleaning product produces too much foam.	▶ Use a different brand of dishwasher resource.

## Display instructions

Malfunction	Cause	Troubleshooting
Indication of softening salt fill is lit.	with - No softening - salt.	▶ Fill in "softening salt" → Page 22 Bee.
	Sensor does not recognize softening salt tablets.	▶ Do not use softening salt bleed.
Indication of softening salt filling does not light up.	Water softening is off switched.	▶ Set water softening
Rinse aid refill indicator lights up.	Rinse aid is missing.	<ol style="list-style-type: none"> <li>1. Fill the "rinse agent" → Page 24 Bee.</li> <li>2. Set the amount of rinse aid.</li> </ol>
		→ "Amount of rinse aid set", page 25

Malfunction	Cause	Troubleshooting
Rinse aid refill indicator is not lit.	Water softening is switched off.	▶ Amount of rinse aid in set.
Display flashes.	Appliance door is not completely closed.	▶ Close the appliance door. <ul style="list-style-type: none"> <li>s Arrange the crockery in such a way that no crockery parts protrude over the crockery basket and prevent the appliance door from closing properly.</li> </ul>

## Malfunctions

Malfunction	Cause	Troubleshooting
There will remain after the program water in the appliance.	Sieve system or space below the sieve is clogged.	<ol style="list-style-type: none"> <li>1. Clean the "seven" → Page 36.</li> <li>2. Clean the "drain pump" → Page 51.</li> </ol>
	Program has not yet ended.	<ul style="list-style-type: none"> <li>▶ Wait for the end of the program or cancel the program with Reset off.</li> <li>▶ → "Abort program", Page 32</li> </ul>
Device cannot be switched on or operated.	Device functions have failed.	<ol style="list-style-type: none"> <li>1. Disconnect the appliance from the mains or switch off the fuse.</li> <li>2. Wait at least 2 minutes.</li> <li>3. Connect the device to the mains.</li> <li>4. Switch on the device.</li> </ol>
The device does not start.	Fuse of the house installation is not OK.	▶ Check the fuse of the house installation.
	Power cord is not connected.	<ol style="list-style-type: none"> <li>1. Check that the socket is working.</li> <li>2. Check whether the connecting cable is properly connected to the mains socket and to the rear of the appliance.</li> </ol>
	Appliance door is not completely closed.	▶ Close the appliance door.
Program starts automatically.	The program has not ended.	▶ → "Abort program", Page 32



Malfunction	Cause	Troubleshooting
Device hangs in a program or cuts out.	Appliance door is not completely closed.	▶ Close the appliance door.
	Power and/or water supply is interrupted.	1. Check the power supply. 2. Check the water supply.
	The upper basket presses against the inner door and prevents the appliance door from closing properly.	▶ Check that the rear wall of the device is being pressed by a socket or an unassembled hose holder.  ▶ Arrange the crockery in such a way that no crockery parts protrude over the crockery basket and prevent the appliance door from closing properly.

## Mechanical damage

Malfunction	Cause	Troubleshooting
Appliance door cannot be closed.	The door lock has tripped.	▶ Close the appliance door with more power.
	Door blocked due to an installation error.	▶ Check whether the device is correctly is built-in.  The appliance door, door panel or attachments must not strike adjacent cupboards and the worktop when closing.
The lid of the detergent dispenser cannot be closed.	Detergent dispenser or lid are blocked by build-up of detergent residue.	▶ Remove the detergent residue.

## Sounds

Malfunction	Cause	Troubleshooting
Clapping noises from the filling valves.	Depending on the house installation. No device error present. Operation of the device is not adversely affected.	▶ The problem can only be solved via the household installation are rectified.
Knocking or rattling sound.	Spray arm hits the crockery.	▶ Arrange the crockery in such a way that the do not hit the spray arms against the dishes.

## NL Troubleshooting

Malfunction	Cause	Troubleshooting
Knocking or rattling sound.	Making water jets at small load direct contact with the rinse aid container.	<ul style="list-style-type: none"><li>▶ Distribute the dishes evenly</li><li>▶ Load more dishes into the appliance</li></ul> <small>honeycomb.</small>
	Light dishes move during rinsing.	<ul style="list-style-type: none"><li>▶ Spacious light pieces of crockery stable in.</li></ul>

## Cleaning the drain pump

Large food particles or objects can block the drain pump. As soon as the washing water is no longer draining properly, you must clean the drain pump.

### WARNING

Risk of injury!

Sharp and pointed objects such as shards of glass can block the drain pump and cause injuries.

► Foreign objects careful remove.

1. Unplug the appliance from the mains.
2. Remove the upper and lower crockery basket.
3. Remove the strainer system.
4. Scoop out the existing water.  
If necessary, use a sponge for this.
5. Lift up the pump cover with a spoon and grasp it by the bracket.

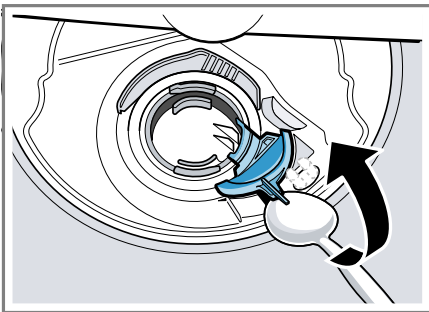

6. Lift the pump cover diagonally inwards and remove it.
7. Remove food residues and foreign objects from the pump impeller.

8. Fit the pump cover and press down . ①

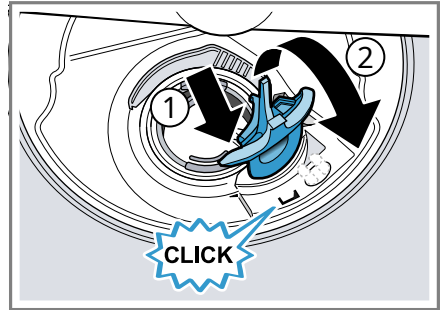

- a The pump cover clicks audibly fixed.
9. Assemble the screening system.
10. Fit the lower and upper crockery basket.

## ~~transport, store~~

## and drain

Here you will find an explanation of how to prepare the device for transport and storage. We also explain how to dispose of old devices.

### Disassemble device

1. Unplug the appliance from the mains.
2. Turn off the water tap.
3. Disconnect the waste water connection.
4. Disconnect the drinking water connection.
5. If present, loosen the fastening screws of the furniture parts.
6. If present, remove the plinth.
7. Carefully pull the device forward, pulling the hose along with it.

## Frost-proof the appliance

If the device is located in a room with a risk of frost, eg in a holiday home, empty the device completely.

- ▶ Empty the device.  
→ *"Transport Device",*  
*Page 52*

## Transporting device

To avoid damage to the device, empty the device before transport.

Remark: To prevent residual water from entering the control unit and damaging the device, only transport the device in an upright position.

1. Remove dishes from the appliance.
2. Secure loose parts.
3. " Turn on the device."  
→ *Page 30*
4. Select the program with the highest temperature.  
→ *"Programs", Page 17*
5. " Start the program."  
→ *Page 31*
6. To empty the appliance, cancel the program after approx. 4 minutes.  
  
→ *"Abort program",*  
*Page 32*
7. " Turn off the device."  
→ *Page 32*
8. Close the tap.
9. To remove the remaining water from the appliance, disconnect the inlet hose and let it drain.

## Disposal of your old appliance

Environmentally friendly disposal means that valuable raw materials can be reused.

 **WARNING**  
Risk of health hazard!

Children can lock themselves in the appliance and endanger their lives.

- ▶ In the case of discarded appliances, the plug  
Unplug the power cord from the socket, then cut the power cord and damage the appliance door lock so that the appliance door no longer closes.

1. Unplug the power cord from the outlet.
2. Cut the power cord.
3. Dispose of the device in an environmentally friendly way.

You can obtain information about the current disposal methods from your dealer and your municipal or district council office.



This appliance is marked in accordance with the European directive 2012/19/EU on waste electrical and electronic equipment (waste electrical and electronic equipment - WEEE). The directive sets the framework for the take-back and disposal of old appliances that is valid in the EU.

---

## S service service

<sup>a</sup> If you have any questions, cannot rectify a fault with the device yourself or if the device needs to be repaired, please contact our customer service.

Original replacement parts that are relevant for the function in accordance with the relevant Ecodesign Regulation can be obtained from our after-sales service for a period of at least 10 years from the time of placing the device on the market within the European Economic Area.

Remark: Calling in the service department within the framework of the manufacturer's warranty conditions is free of charge.

Detailed information about the warranty period and warranty conditions in your country can be obtained from our after-sales service, your dealer or on our website. When contacting the after-sales service, you will need the product number (E-No.), production number (FD) and serial number (Z-No.) of the device.

You can find the contact details of the after-sales service in the supplied service list or on our website.

Product number (E-Nr.),  
production number (FD) and  
serial number (Z-Nr.)

The product number (E-Nr.), the production number (FD) and the serial number (Z-Nr.) can be found on the type plate of the appliance.

The type plate can be found on the inside of the appliance door.

You can make a note of the data so that you can quickly find your device data and service phone numbers.

## AQUA-STOP guarantee

In addition to the warranty claims against the seller based on the purchase agreement and our manufacturer's warranty, you will be compensated if the conditions below are met.

s If due to an error in the AquaStop  
If water damage is caused to the system, we will reimburse private users for damage. To guarantee the water protection system, the appliance must be connected to the mains.

s The liability guarantee  
applies to the life of the device.

s Condition for entitlement to  
there is a guarantee that the device with AquaStop has been set up and connected professionally and in accordance with our installation instructions; this also includes the professionally installed extension of the AquaStop (original accessory). Our warranty does not cover defective supply lines or fittings up to the AquaStop connection on the tap.

s While using an appliance  
In principle, with AquaStop you do not have to keep up with it or turn off the tap after use for safety reasons. The tap should only be turned off if you are away for a longer period of time, for example if you are going on holiday for a few weeks.

## technical data

Weight	Max.: 60 kg
Voltage	220 - 240V, 50Hz or 60Hz
Connection value	2000 - 2400 W
Fuse	10 - 16 A
water pressure	s min. 0.05 MPa (0.5 bar) s max. 1 MPa (10 bar)
Quantity of indoor running water	min. 10 l/min
Water temperature	Cold water. Hot water max.: 60°C
Capacity	12 standard place settings

You can find more information about your model on the Internet at <https://eprel.ec.europa.eu/><sup>1</sup>. This web address refers to the official EU product database EPREL. Then follow the instructions when searching for the model. The model identification consists of the slash character of the E-number (E-No.) on the type plate. Alternatively, you will also find the model identification in the first line of the EU energy label.

## Information about free software and open source software

This product contains software components that are licensed by the intellectual property holders as free software or open source software.

The information about the respective license is stored in the household appliance. In addition, you can consult this license information via the Home Connect app: 'Profile -> Legal information -> License-information'. In addition, you can download the license information from the product website. (Please search the product website for your device model and its documentation.) Alternatively, you can also request the corresponding information via [ossrequest@bshg.com](mailto:ossrequest@bshg.com) or BSH Hausgeräte GmbH, Carl-Wery-Str. 34, D-81739 Munich.

The source code will be made available to you upon request.

Send a request to that effect to [ossrequest@bshg.com](mailto:ossrequest@bshg.com) or BSH Hausgeräte GmbH, Carl-Wery-Str. 34, D-81739 Munich.

Subject: "OSSREQUEST"

The costs for processing your request will be charged to you. This offer is valid for three years from the date of purchase or at least during the period in which we provide support and spare parts for the respective device.

<sup>1</sup> Only applies to countries in the European Economic Area

<sup>2</sup> Depending on the device version





**BOSCH**  
HOME APPLIANCES  
**SERVICE**

**[www.bosch-home.com/service](http://www.bosch-home.com/service)**

Contact data of all countries are listed in the attached service directory.

**Robert Bosch Hausgeräte GmbH**

Carl-Wery-Straße 34

81739 Munich

GERMANY

[www.bosch-home.com](http://www.bosch-home.com)

**\* 9001672778\***

**9001672778** ( 010715) 642 E3 en



## Free Manuals Download Website

<http://myh66.com>

<http://usermanuals.us>

<http://www.somanuals.com>

<http://www.4manuals.cc>

<http://www.manual-lib.com>

<http://www.404manual.com>

<http://www.luxmanual.com>

<http://aubethermostatmanual.com>

Golf course search by state

<http://golfingnear.com>

Email search by domain

<http://emailbydomain.com>

Auto manuals search

<http://auto.somanuals.com>

TV manuals search

<http://tv.somanuals.com>