

# **BOSCH**

## **DISHWASHER Use and Care Manual**

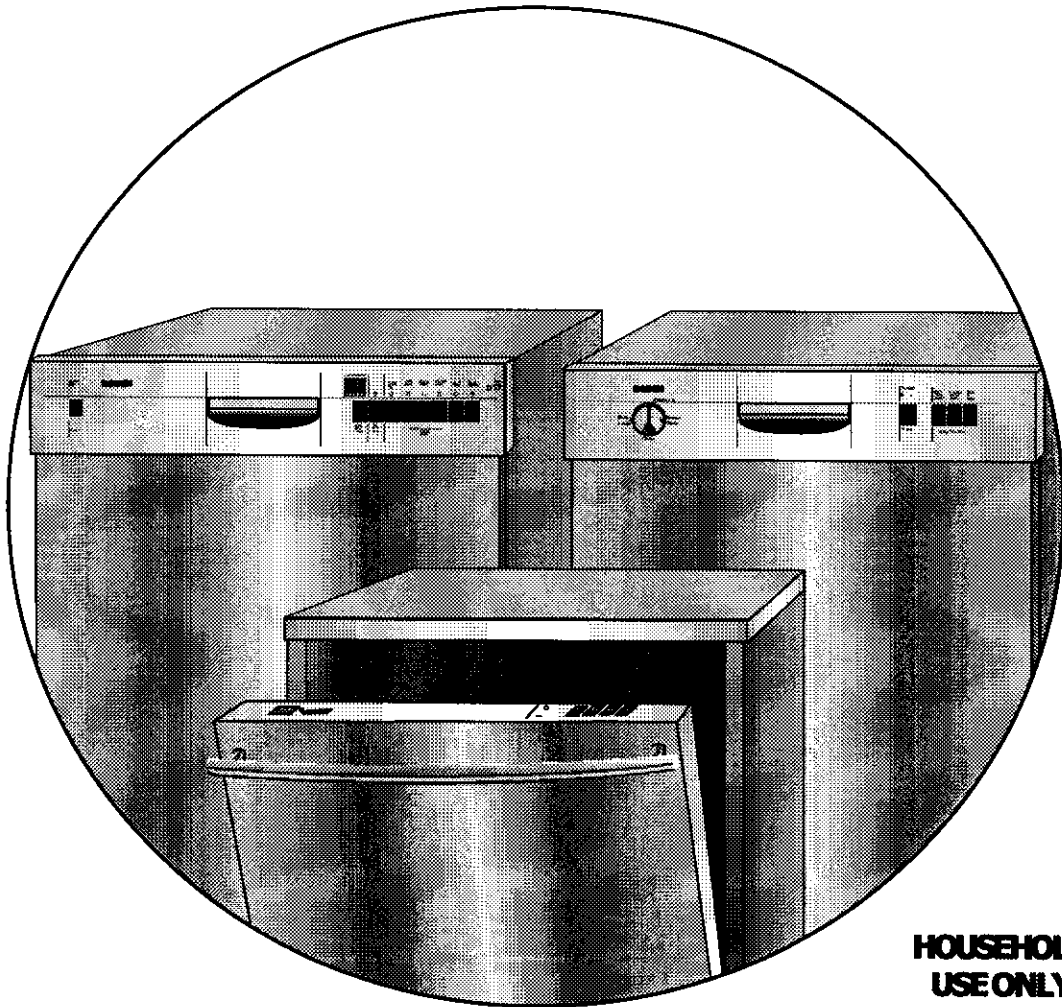

**SHV 6800, 4800, 4300  
SHI 6800, 4300  
SHU 9950, 9920, 9910, 8810, 8800, 6800, 5300,  
4320, 3300, 3131, 3030**

**HOUSEHOLD  
USE ONLY**

**UTILISATION  
DOMESTIQUE  
SEULEMENT**

**USO  
DOMESTICO  
ÚNICAMENTE**

**Congratulations, and Thank You from BOSCH\***

for selecting your dishwasher. You have joined the many consumers who demand quiet and exceptional performance from their dishwashers. This manual was written with your safety and convenience in mind and the information contained herein is very important. We, at BOSCH, highly recommend that you read this manual prior to using your dishwasher for the first time. As an added convenience, a glossary of **BOSCH DISHWASHER FEATURES DESCRIPTIONS** has been added to this manual so you can truly understand and appreciate the philosophy put into this exceptional product.

For even more information, visit our website at **[www.boschappliances.com](http://www.boschappliances.com)** to learn about your dishwasher as well as many other top quality Bosch appliances.

Enjoy!

\*Note: The Bosch dishwasher referred to throughout this manual is manufactured by BSH Home Appliances Corp.

# UNIQUE FEATURES

## UNIQUE FEATURES OF YOUR BOSCH DISHWASHER

### STAINLESS STEEL INTERIOR

- Improves Drying Performance
- Resists Staining/Odors
- Lifetime Warranty (see details on last page of manual)

### TRIPLE FILTER SYSTEM

- 100% of the Wash Water is Filtered Before it Touches Your Dishes
- "Large Object Trap" Prevents Undesirable Objects from Damaging the Pump System

### IN LINE FLOW THROUGH WATER HEATER (BOSCH FlowThroughHeater™)

- Temperatures in excess of 160°F kill harmful germs while dissolving hard to remove fats and soils
- Eliminates an exposed heater element that can damage items that fall from the rack
- Creates More Interior Space (BOSCH Tall Tub™)
- Flexibility to Load Dishwasher Safe Items in Upper or Lower Rack

### LOW NOISE SYSTEM (BOSCH AVS II™)

- Vibration Isolated Pump System Reduces Annoying Noises (BOSCH Suspension Motor™)
- Triple Insulation Creates the BOSCH AVS II Silence Rating
- Side Panels Encapsulate Noise
- Separate Pump Systems, one for washing and one for draining, improve efficiency and reduce noise
- Toe Kick Sound Shield on the SHU 6800 series results in unbelievable sound performance (Bosch Sound Seal™)

### RACKS

- Tall Tub Allows Use of 10" Plates in the Upper Rack and 12" in the Lower Rack
- Extra Tall Item Sprinkler Allows Removal of the Upper Rack and Washing of Items up to 22" Tall
- 12 Place Loading Capacity

### SAFETY

- Side Panels Enclose All Electrical Connections and Conserve Energy
- Water Shutoff Device, Stops the Flow of Incoming Water when it is Detected Under the Dishwasher
- Child Proof Cycle Selection - Cycle Selection Buttons Must be Pressed Twice to Change the Settings

### PRESSURE CONTROLLED FILLING SYSTEM

- Water Consumption is Reduced When Washing Small Loads
- Water Fill Levels Are Consistent Over Various Water Pressures
- Improved Accuracy Over Time-Filled Systems

### DUAL PUMP SYSTEM

- Single Direction Main Pump is More Reliable
- Improved Main Motor Efficiency

### DETERGENT and RINSE AID DISPENSER

- Sliding Detergent Cup Lid Prevents Blockage
- Adjustable Rinse Aid Dispenser for Improved Performance in Various Water Conditions



# **TABLE OF CONTENTS**

Important Safety Instructions .....	4
Dishwasher Components .....	5
Materials Chart.....	6
Loading the Dishwasher .....	7-10
Rack Accessories .....	11
Adding Detergent.....	12
Adding Rinse Agent.....	13
Bosch Dishwasher Controls .....	14-15
Cycle Selection Charts .....	16-18
Selecting a Wash Cycle .....	19
Interrupting, Changing or Cancelling A Cycle .....	20
Program Options and Unloading .....	21
Special Features.....	22-23
Care and Cleaning .....	24-25
Self Help .....	26
Models Features .....	27
Features Descriptions .....	28
Customer Service .....	29
Warranty .....	30



# IMPORTANT SAFETY INSTRUCTIONS



**WARNING** — When using your dishwasher, basic safety precautions should always be followed to reduce the risk of fire, electric shock, and/or injury to persons, including the following:

1. Bosch dishwashers are provided with two manuals; one, Installation Instruction Manual and one, Use and Care Manual. Read all instructions and understand before using the dishwasher.
2. Use the dishwasher only for its intended function.
3. Use only detergents or wetting agents recommended for use in a dishwasher and keep them out of the reach of children.
4. When loading items to be washed:
  - a. Locate sharp items so that they are not likely to damage the door seal; and
  - b. Load knives and other sharp utensils with handles up to reduce the risk of cut-type injuries.
5. Do not wash plastic items unless marked "dishwasher safe" or the equivalent. For plastic items not so marked, check the manufacturer's recommendations.
6. Do not touch the heating element during or immediately after use.
7. Do not operate your dishwasher unless all the enclosure panels are properly in place.
8. Do not tamper with controls.
9. Do not abuse, sit on, or stand on the door or dish rack of the dishwasher.
10. To reduce the risk of injury, do not allow children to play in or on the dishwasher.
11. Under certain conditions, hydrogen gas may be produced in a hot water system that has not been used for two weeks or more. Hydrogen gas is explosive. If the hot water system has not been used for such a period, before using the dishwasher turn on all hot water faucets and let the water flow from each for several minutes. This will release any accumulated hydrogen gas. As the gas is flammable, do not smoke or use an open flame during this time.
12. Remove the door to the washing compartment when removing an old dishwasher from service or discarding.

**SAVE THESE INSTRUCTIONS !**

## GROUNDING INSTRUCTIONS

This appliance must be connected to a grounded metal, permanent wiring system, or an equipment grounding conductor must be run with the circuit conductors and connected to the equipment grounding terminal or lead on the dishwasher.

**WARNING** — This dishwasher must be grounded in accordance with the National Electrical Code and/or local codes. Make sure this dishwasher has been properly grounded and installed by a qualified installer before using.

# DISHWASHER COMPONENTS

Figure 1, below, identifies the components of your dishwasher, and shows the page number(s) in this manual on which more information about the component is available. Familiarize yourself with the various parts of your dishwasher before you attempt to wash the first load of dishes.

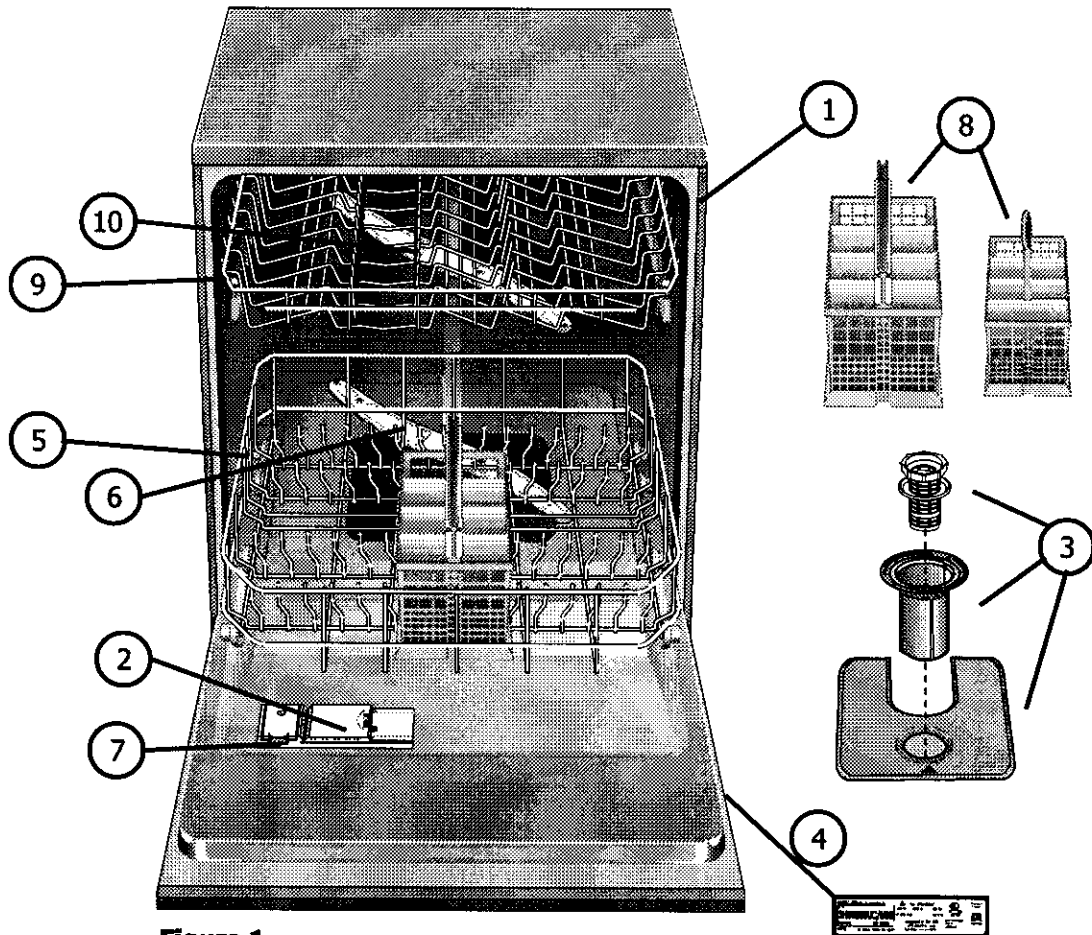

**Figure 1**

## Components:

1. Door gasket
2. Detergent Dispenser
3. Filters (3)
4. Model and Serial Number Label
5. Lower Rack
6. Lower Spray Arm
7. Rinser Agent Dispenser
8. Silverware Baskets (2)
9. Upper Rack
10. Upper Spray Arm

## Page Number:

- |     |     |
|-----|-----|
| Pg. | 24  |
| Pg. | 12  |
| Pg. | 23  |
| Pg. | 28  |
| Pg. | 8   |
| Pg. | 24  |
| Pg. | 13  |
| Pg. | 10  |
| Pg. | 8-9 |
| Pg. | 24  |

# MATERIALS CHART

**Important: Before you wash anything in the dishwasher, check the materials chart shown below in Table 1. Some materials are not dishwasher-safe and should be hand-washed. Others require special loading considerations. Before washing any dishware or cookware, contact the manufacturer of the material to confirm that it is dishwasher-safe.**

## Materials Chart

MATERIAL	DISHWASHER USE	COMMENTS AND/OR SPECIAL INSTRUCTIONS
ACRYLIC	NOT RECOMMENDED	Crazing may occur.
ADHESIVE JOINED ITEMS	NOT RECOMMENDED	Items joined by adhesives, whether plastic, wood, bone, steel, copper or tin, etc. may be loosened.
ALUMINUM	USUALLY SAFE	Colored anodized aluminum may fade over time. Minerals in the water may cause spotting or darkening of aluminum. This can usually be removed by scouring with a soap filled steel wool pad.
BONE HANDLED UTENSILS	NOT RECOMMENDED	Handles may separate.
CHINA, CRYSTAL, & STONEWARE	USUALLY SAFE	Decorated china, stoneware, and crystal that is hand-painted or trimmed may discolor, fade, or spot. You should hand-wash these items. Position fragile glassware so that it will not topple over or come in contact with other dishes during the wash cycle. If you are not sure whether a particular item is dishwasher safe, contact the dish manufacturer.
GLASS	USUALLY SAFE	Milk glass may yellow.
IRON	NOT RECOMMENDED	Iron will rust. Wash by hand and dry immediately.
NON-DISHWARE ITEMS	NOT RECOMMENDED	The Bosch dishwasher is only intended for use in cleaning standard household dishware items.
NON-STICK COATINGS	USUALLY SAFE	After drying the non-stick coating should be covered with a light coating of vegetable oil.
PEWTER, BRASS, & BRONZE	NOT RECOMMENDED	Pewter will tarnish. Wash by hand and dry immediately.
PLASTIC	USUALLY SAFE	Wash only "dishwasher-safe" plastics. Decorated plastics may fade.
STAINLESS STEEL	USUALLY SAFE	Do not let stainless steel items contact copper, sterling silver, silverplate, or dissimilar metal items.
STERLING SILVER & SILVERPLATE	USUALLY SAFE	Do not let sterling silver or silverplate items come in contact with dissimilar metal items.
TIN	NOT RECOMMENDED	Tin will rust. Wash by hand and dry immediately.
WOOD	NOT RECOMMENDED	Wooden bowls, wooden utensils and wood handled utensils can warp, crack, or lose their finish.

Table 1

# LOADING THE DISHWASHER

## Pre-Load Preparation

- Remove large particles of food from the dishes before food has a chance to dry, but rinsing is not necessary.

**Food soils will actually enhance the detergent's performance.**

- Use the Rinse & Hold cycle if waiting an extended period of time before washing.
- Pre-soak and hand-scour pots and pans with burned-on or blackened food.
- **Do not place foreign objects, such as toothpicks, paper products, plastic bags, or packaging materials, into the dishwasher!**

## General Loading Tips

- Load dishwasher so water can circulate freely and reach every part of item.
- Do not allow delicate items to touch - they could be damaged.
- Place items upside down - so water does not collect inside of them.
- Place items so that nothing protrudes through the bottom of the racks - this could block the rotation of the spray arms.

**Before loading the dishwasher, review the materials chart provided on Page 6.**

## Integra Ltd Racks

The dishwasher racks in Figures 4 and 5 are those that come with the Bosch Integra Ltd model (SHU 9950) only. Shown in these figures are the recommended 12 place setting loading patterns to obtain the optimal performance from your dishwasher.

**Standard Bottom Rack**

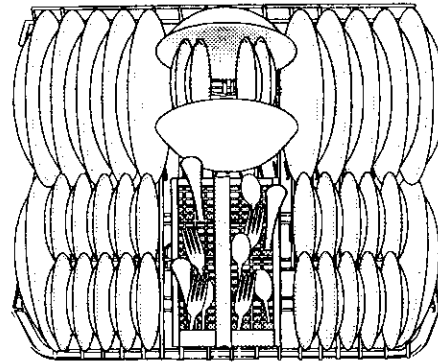

AHAM DW-1 -12 Place Setting

**Figure 2**

**Standard Top Rack**

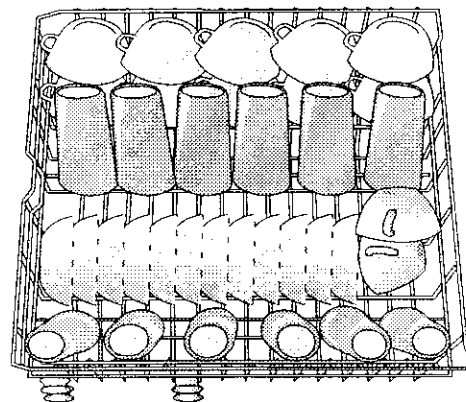

AHAM DW-1 -12 Place Setting

**Figure 3**

**Integra Ltd Bottom Rack**

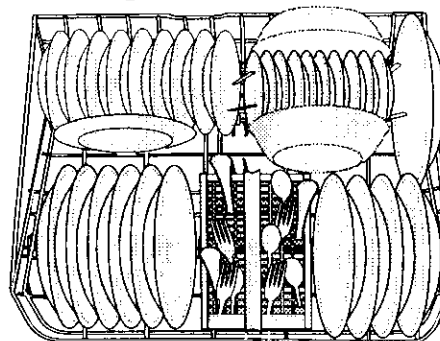

AHAM DW-1 -10 Place Setting

**Figure 4**

**Integra Ltd Top Rack**

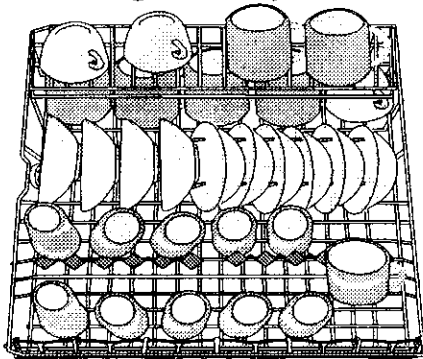

AHAM DW-1 -10 Place Setting

**Figure 5**



# LOADING THE DISHWASHER

## Loading the Bottom Rack

Place large and/or heavily soiled items in the bottom rack of the dishwasher. Load heavily soiled pots and pans face down, as shown in Figure 6. For larger items, fold down the rear tines on the bottom rack. When in the down position, they can hold extra large utensils, such as serving spoons or large knives.

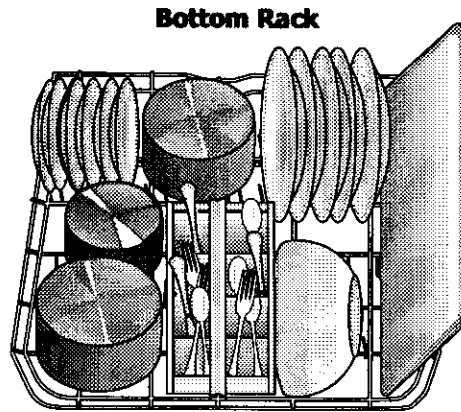

Figure 6

## Loading the Top Rack

The upper rack of the dishwasher has been designed with flexibility in mind. Glasses, cups, plates, bowls and small pots may be loaded in many different positions to fit your needs. Figure 7 shows a typical mixed load for the upper rack.

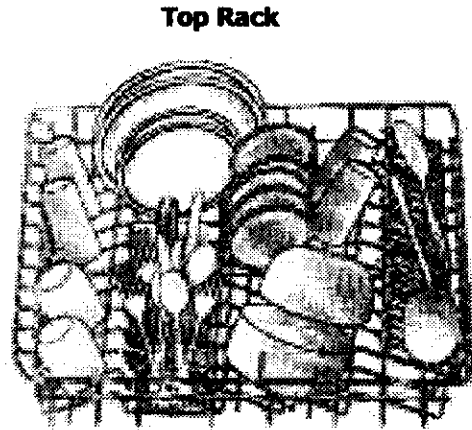

Figure 7

## Cup Shelves

- Flip down cup shelves.
- Place glasses upside down with stems resting in the "V" of the shelves.

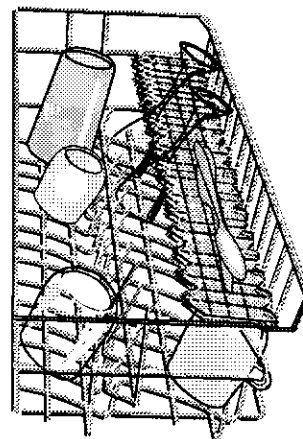

Figure 8

*Note: Some model dishwashers come with accessories. Various Accesories for your dishwasher can be purchased through your local Bosch dealer.*

# LOADING THE DISHWASHER

## Standard Top Rack Adjustment

The top rack height of the Bosch dishwashers is adjustable (in most models.) There is an upper and lower position for the top rack which is used to accommodate items with different heights.

### How to Adjust the Top Rack

1. Pull out (empty) top rack to the point where it can be lifted upward.
2. Pull the rack outward and up until rollers are completely free of channels.
3. Reinsert the rack with the other set of rollers on the channel.

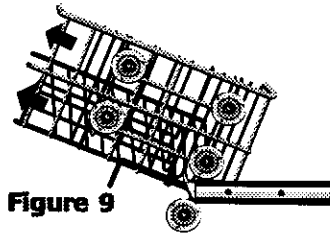

Figure 9

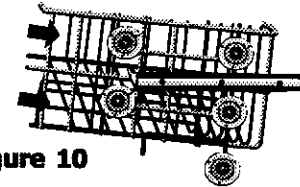

Figure 10

## RackMatic Adjustment (SHU9950 model only)

The top rack height of the Bosch dishwashers is adjustable. There is an upper and lower position for the top rack which is used to accommodate items with different heights.

### How to Lower and Raise the Rack:

- First, pull out the top rack.

#### To Lower Rack

- Press the levers simultaneously (one on the left and one on the right sides of the rack). Always hold the sides of the rack on the upper edge, otherwise it will not drop smoothly (and may damage the utensils).

#### To Raise Rack

- Take hold of the rack on the upper edge and pull upwards.
- Before you re-insert the rack, ensure that it is at the same height on both sides. Otherwise, the appliance door will not close and the upper spray arm will not connect to the water circuit.

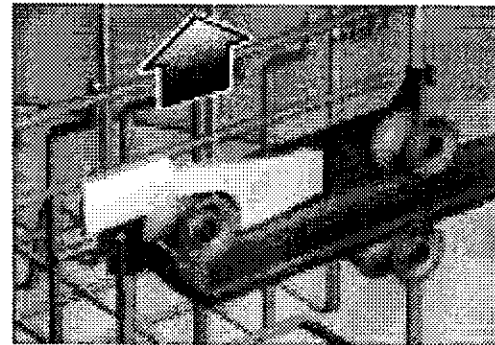

Figure 11

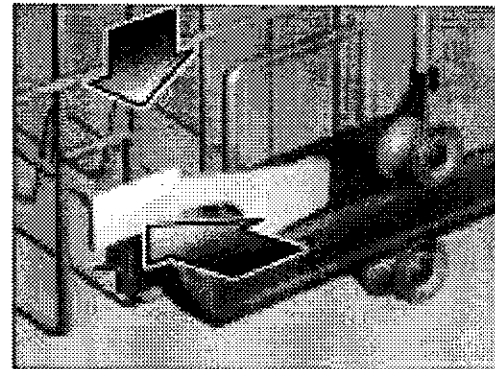

Figure 12

#### Upper Position

Max. height (on top) 8"  
Max. height (on bottom) 14"

#### Lower Position

Max. height (on top) 10"  
Max. height (on bottom) 12"

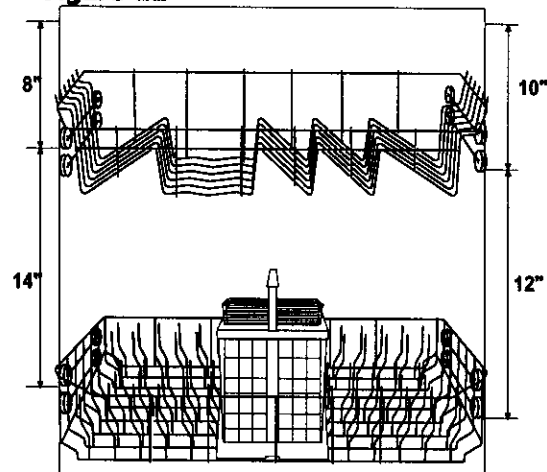

Figure 13

# LOADING THE DISHWASHER

## Loading the Silverware Basket(s)

All Bosch dishwashers have a large silverware basket in the bottom rack. Those models with the TOP RACK ONLY feature have an additional upper small silverware basket.

For personal safety and a top quality clean, place the silverware in the baskets:

- so that they do not nest together.
- place silverware with handles-down, but
- place knives and other potentially dangerous utensils handles-up.

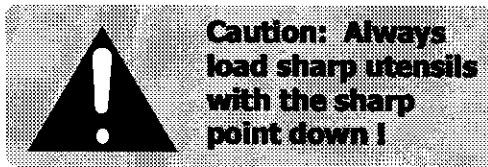

### NESTING SILVERWARE

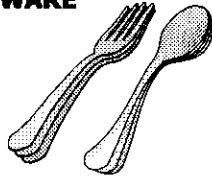

Figure 15

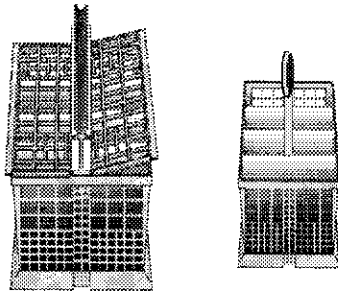

Figure 16

## Large Silverware Basket with Lid

Some models have a large silverware basket with a lid. The lid prevents nesting of silverware. To use, first fold the basket lids down (snap in place), then load silverware. Refer to Figures 17 and 18 for recommended silverware loading.

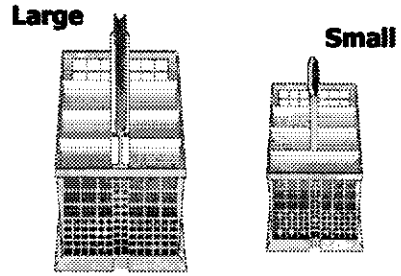

Figure 14

Below is an example of a silverware loading pattern that prevents nesting.

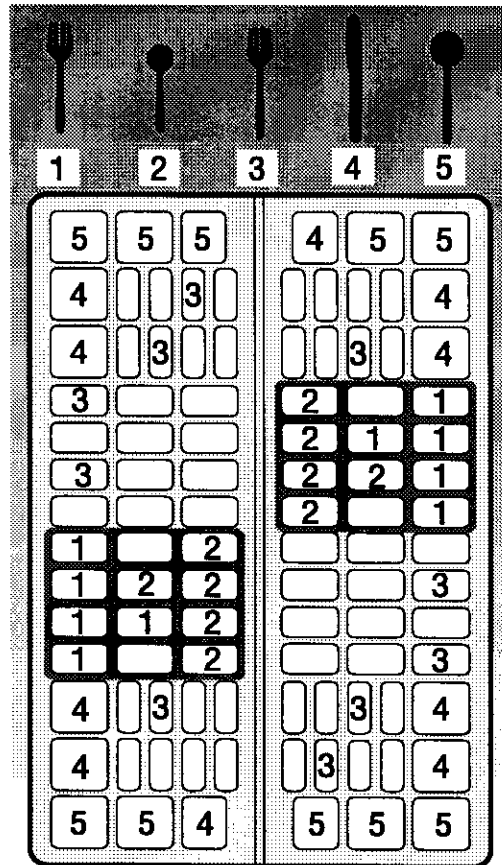

Figure 17

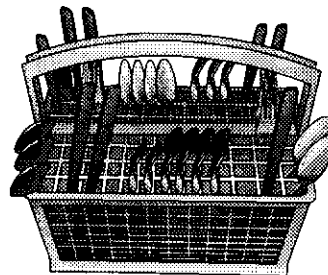
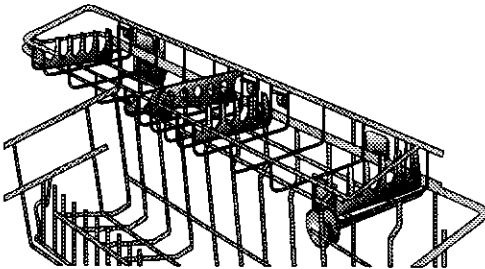

Figure 18

## Rack Accessories

Some Bosch dishwasher models have optional rack accessories. Please refer to the Dishwasher Features Chart on pg. 27 to see which accessories your particular model has.

### Fine Silver & Cutlery Tray



The Fine Silver & Cutlery Tray has been designed for a variety of uses, but primarily for precise loading of fine silver and cutlery, which prevents chipping or scratching.

- To adjust height, lift up and out, then reposition into desired locations.

*\*Note: To load large cups or mugs, adjust both the Upper Rack and Fine Silver & Cutlery Tray into their lower positions to ensure adequate clearance from top of tub. Can be easily removed.*

### Stemware Holder

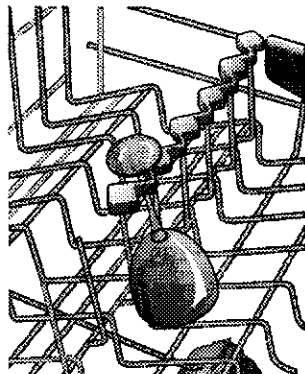

Stemware holders in the upper rack are used for delicate stemware glasses, providing more flexible loading. Can be easily removed.

## RACK ACCESSORIES

### Extra Silverware Basket

This basket can be placed in a variety of positions in the upper rack.

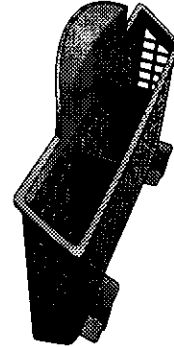

### Flexible Silverware Basket

This flexible silverware basket is intended to be used in the lower rack. To position in the rack, the two slots A and B should fit over the (plate) tines so that it can slide from side to side.

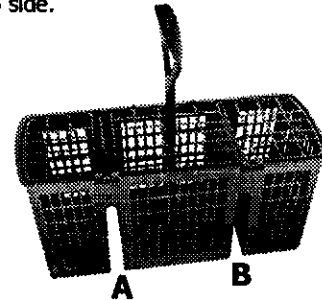

### Lower Silverware Basket

Can be placed in the front middle of the lower rack.

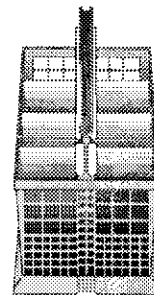

### Upper Silverware Basket

Can be placed in the front middle of the upper rack.



# ADDING DETERGENT

## Selecting the Right Detergent

Use only dishwashing detergent in your Bosch dishwasher. It is highly recommended to use powder detergent that DOES NOT contain a drying agent additive. Use of other types of detergents may result in excessive suds. Concentrated detergents usually call for lower usage than standard detergents. Please refer to Table 2 for recommended detergent usage.

## Filling the Detergent Dispenser

1. Locate the detergent dispenser on the inside door of the dishwasher (see Figure 1).
2. Open the detergent dispenser cover by pushing the release tab.
3. Fill dispenser. Refer to Table 2 to determine the amount of detergent necessary for your water and wash type. Use the measurement lines inside the detergent dispenser as a fill guide.
4. Close dispenser. With fingers on arrow, slide cover over the detergent chamber and press down on the arrow until it clicks shut.

**The detergent will be dispensed automatically during the wash portion of the cycle.**

**For the best washing results it is important to use the correct type and amount of detergent and rinse agent.**

Detergent Dispenser Cover

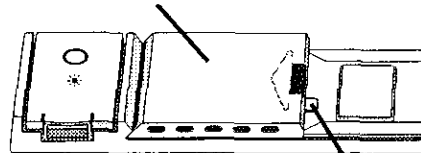

Figure 19

Release Tab

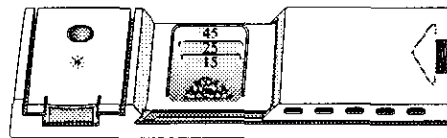

Figure 20

**Important: Too much detergent combined with soft water may cause etching of glassware.**

## Recommended Detergent Usage

WATER TYPE	Power Scrub Plus	Scrub Wash	WASH CYCLE			
			Regular Wash	Delicate/Economy	Quick Wash	Rinse & Hold
Hard	45 ml	45 ml	25-45 ml	25 ml	15-25 ml	None
Medium	45 ml	25-45 ml	25 ml	15-25 ml	15 ml	None
Soft	25-45 ml	25 ml	15-25 ml	15 ml	15 ml	None

Table 2

# ADDING RINSE AGENT

## Rinse Agent

Rinse agent, or a rinse aid, is used to provide optimum drying results and diminish water spotting. **Always** use a rinse agent with the Bosch dishwasher to insure proper drying results. It rinses the dishware and also rinses the internal parts of the dishwasher.

### To Fill the Rinse Agent Reservoir:

1. Open the dishwasher door fully.
2. Open the cover of the rinse agent dispenser by pressing the star on the cover with your index finger while pulling on the tab with your thumb.
3. Add rinse agent to the reservoir until the level indicator turns dark, indicating that the reservoir is full (capacity is approx. 3.5 oz.).

## Rinse Agent Dispenser Regulator

The rinse agent reservoir of the Bosch dishwasher is provided with a regulator calibrated from 1 to 6. (See Figure 21.) This regulator controls the amount of rinse agent dispensed. The dishwasher leaves the factory preset to 4. However,

- if you see streaks, you should turn the regulator to a lower number.
- if you see water spots, you should turn the regulator to a higher number.

## Rinse Agent Indicator Light

Some models are equipped with an additional rinse aid indicator light on the control panel. When the rinse agent dispenser is empty, the indicator light will glow and the level indicator will show a silver background with black lines.

After filling the rinse agent dispenser, close the door and wait a few minutes for the indicator light to register.

### TO ADJUST RINSE AGENT REGULATOR SETTING:

1. OPEN THE COVER OF THE RINSE AGENT DISPENSER.
2. TURN THE SETTING INDICATOR TO THE DESIRED SETTING.

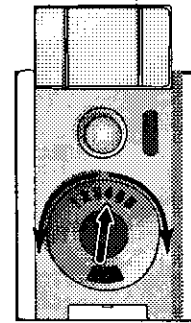

Figure 21

**Note: Refill rinse agent when the level indicator shows a silver background with black lines.**

### Rinse agent level indicator

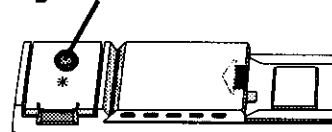

Figure 22

**Rinse agent is available in liquid or solid form. Only use the liquid type of rinse agent in the Bosch dishwasher.**

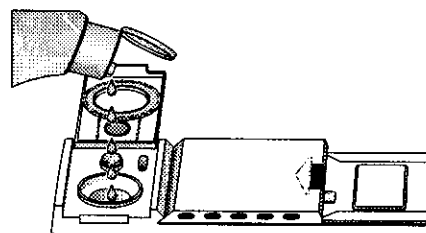
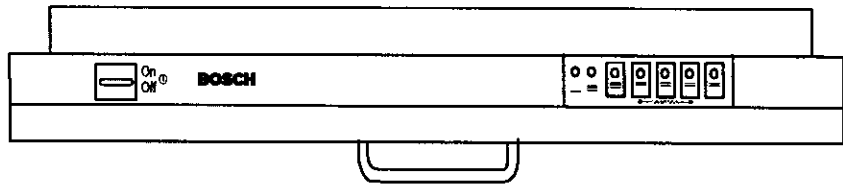

Figure 23

# BOSCH DISHWASHER CONTROLS

**SHV 4800**



**SHV 4300**

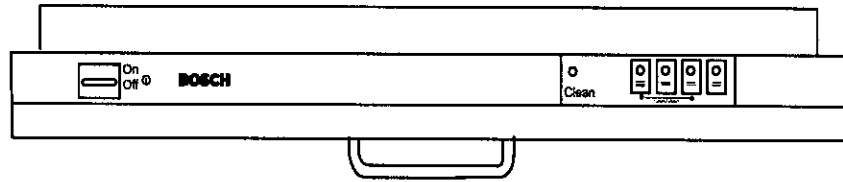

**SHV 6800**

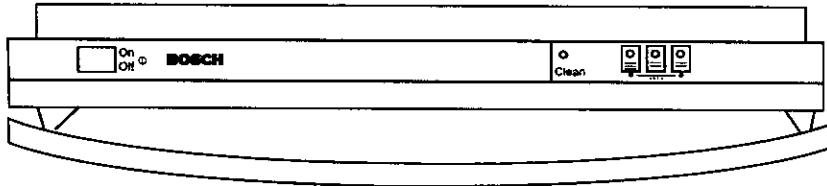

**SHU 8800  
SHU 8810**



**SHU 9910**

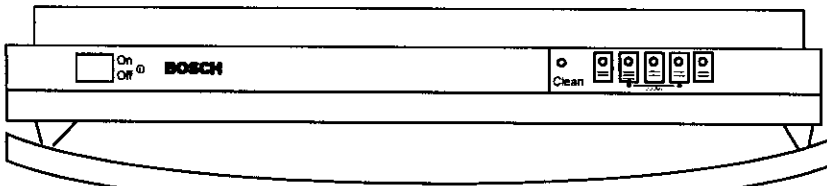

**SHU 9920**

Top view

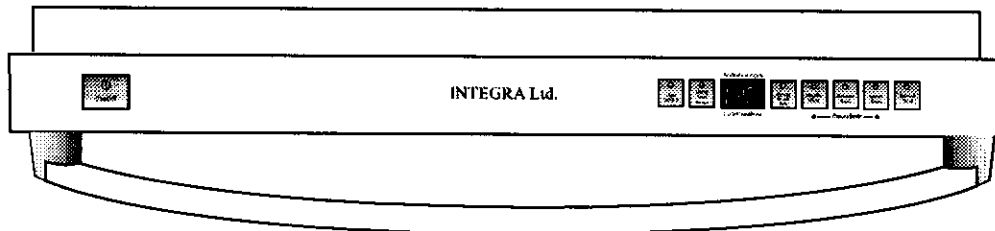

**SHU 9950**

Front view

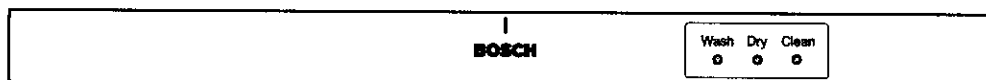

# BOSCH DISHWASHER CONTROLS

**SHU 6800  
&  
SHI 6800**

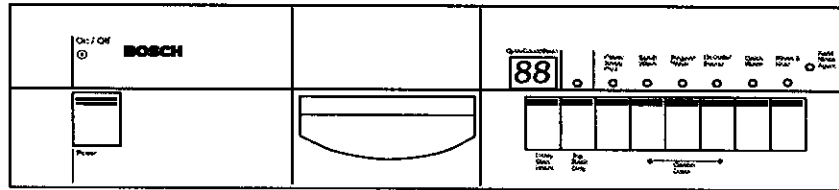

**SHU 5300**

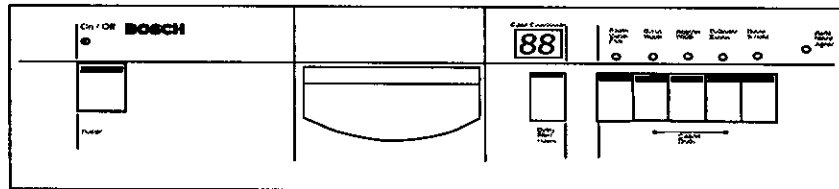

**SHU 4320**

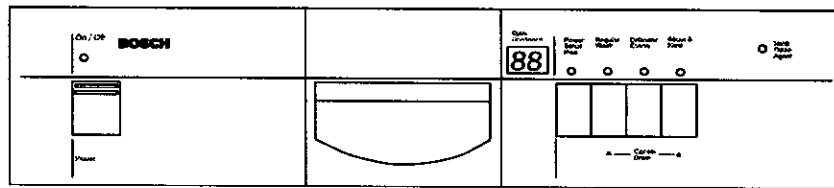

**SHU 3300  
DLX**

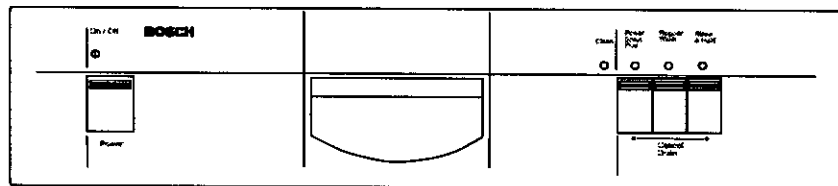

**SHU 3300**

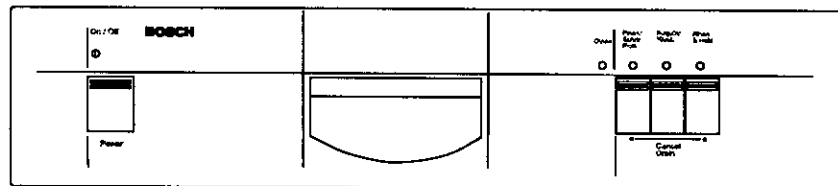

**SHU 3030  
SHU 3131**

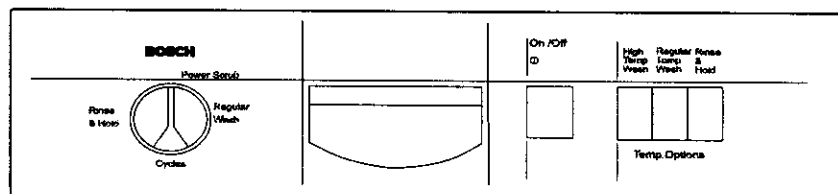



# CYCLE SELECTION CHARTS

## Cycle Selection Chart I Bosch Dishwashers

for SHU9910, SHU9920, SHU8800, SHV4300 and SHV4800 Models

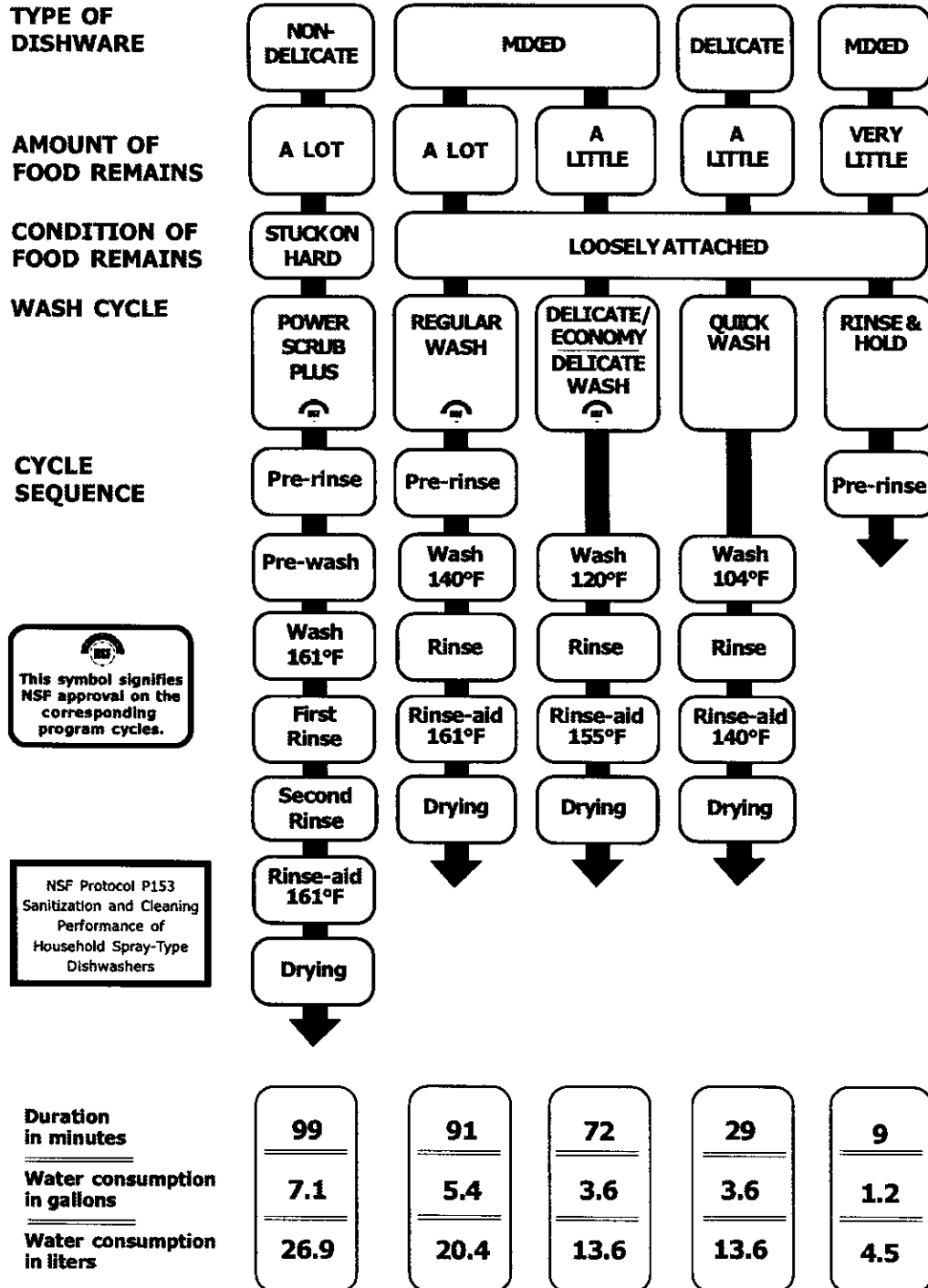

**Table 3**

The duration of the time listed in the chart show the average values while running the dishwasher under normal conditions. Temperature and wash load will alter water consumption and cycle duration.

- For models with the Top Rack only feature, water consumption can be reduced by as much as 30%.

# CYCLE SELECTION CHARTS

## Cycle Selection Chart II Bosch Dishwashers for SHU6800, SHI6800, SHV6800, SHU 9950, SHU4320, SHU3300 Models

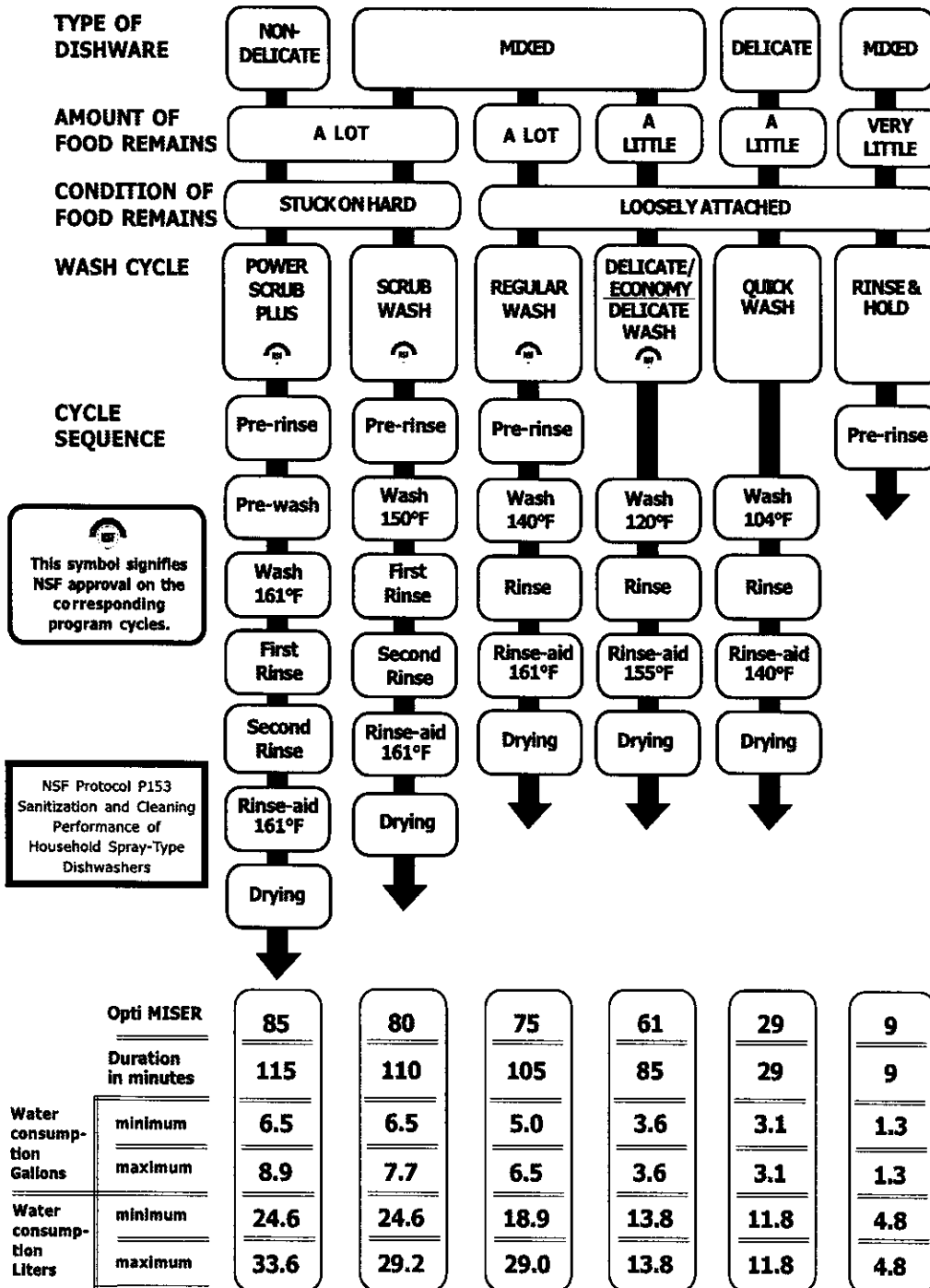

**Table 4**

The duration of the time listed in the chart show the average values while running the dishwasher under normal conditions. Temperature and wash load will alter water consumption and cycle duration.

- In the Sensotronic featured models, the water consumption will be adjusted based on soil load.
- For models with the Top Rack only feature, water consumption can be reduced by as much as 30%.

# CYCLE SELECTION CHARTS

## Cycle Selection Chart III Bosch Dishwashers

for SHU3030 and SHU3131 Models only

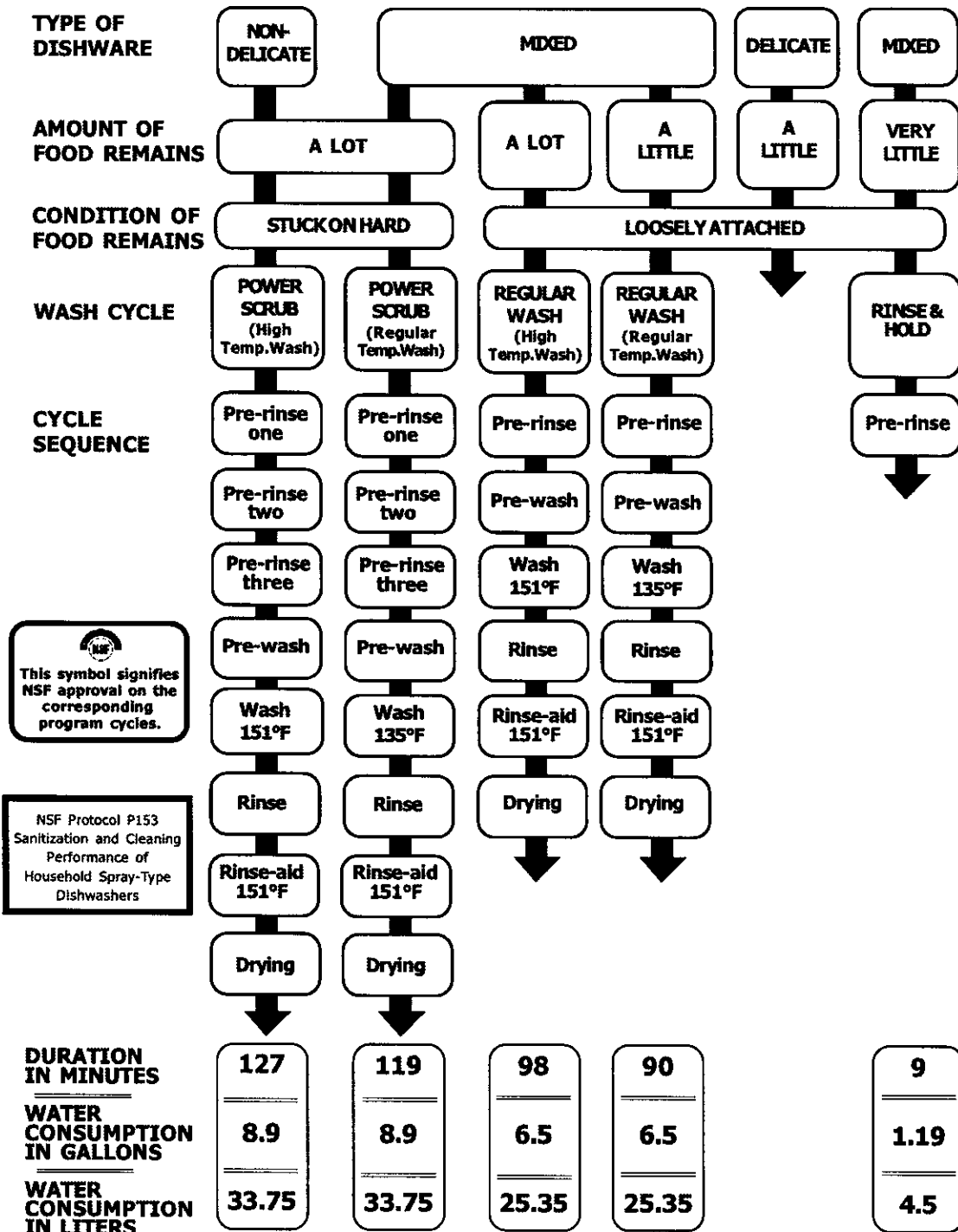

Table 4

Note: On the SHU 3030 and SHU 3130, when you select "Rinse & Hold" on the "Start and Run Knob", you must also select "Rinse & Hold" on the "Temp. Options" button. If not, the unit will go into heat delay, which will cause an extended run time.

**Soap should not be used with the "Rinse & Hold" cycle.**

# SELECTING A WASH CYCLE

## Selecting a Wash Cycle

The dishwasher will wash and dry the contents based on cycle selection made. Refer to Tables 3, 4 and 5: Wash Cycle Selection Chart to select the most appropriate cycle for the wash load.

Follow these steps to select a cycle and start the dishwasher:

### SHU/SHI Models:

1. Close the dishwasher door, making sure that door latches are closed.
2. Press the on/off switch.
3. Select the button for the program desired.\*
4. The dishwasher will start automatically and continue to the end of the selected cycle.
5. At the end of the cycle the dishwasher will stop and either the "Clean" light will become illuminated, the LED display will show "CL" or "0", or the dishwasher will beep.

### SHU 9910/9920/9950/ 8800 & 8810 Models & SHV Models:

1. Open dishwasher door.
2. Press the on/off switch.
3. Push the button once for the program desired.
4. Close door until it latches and the program will begin.
5. Same as #5 above.

**Push the desired button TWO TIMES if another program button is lit up.**

**Note: All indicator lights will remain illuminated until the on/off switch is pressed or the door is opened.**

## Various Model Types

### SHU/SHI

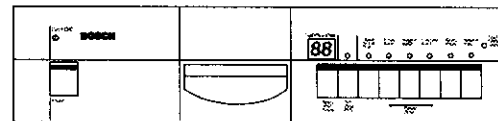

Figure 24

### SHU 9950

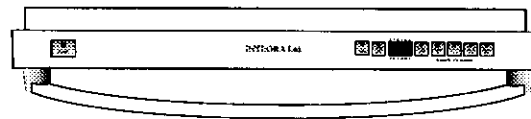

Figure 25

### SHU 9910/9920 & SHV Models

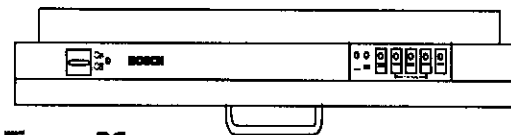

Figure 26

## VARIOUS END OF CYCLE INDICATORS

- \* Clean light illuminates
- \* CL or 0 is displayed on the LED.
- \* Cycle Completion Beeper sounds off

# INTERRUPTING, CHANGING OR CANCELLING A CYCLE

## Cycle Interruption

As a safety feature the dishwasher will automatically turn itself off whenever the door is opened. However, if the door is opened quickly while in a wash or rinse cycle some water may splash out of the dishwasher. For this reason it is recommended that the machine always be switched off before opening the door.

## To Interrupt a Cycle

1. Press the on/off button to stop operation.
2. Wait at least 10 seconds (or until the water noises stop) before opening the door.

## To Resume a Cycle

1. SHU/SHI models, close the door and press the on/off button.
2. SHV models, push the on/off button and close the door.

## Changing a Cycle

For Bosch dishwasher models SHI 6800 and 4320, SHU 5300, 5310 and 6800 press the program button of the desired cycle TWICE. For all other Bosch dishwasher models, press the program button of the desired cycle ONCE. The chosen cycle button (or the light above it) becomes illuminated, showing that it has been selected.

\* SHU 3030 and SHU 3130 models do not have program lights.

## Cancelling a Cycle

Each control panel shows which buttons to simultaneously push to cancel a cycle. Refer to your dishwasher to find the cancel drain buttons on your particular model.

1. Press the indicated buttons at the same time and hold for approximately 3 seconds.
2. When the drain pump noises stop and the LED display or clean light indicate that the end of the cycle has been reached, the dishwasher is reset.
3. Press the on/off button to turn the dishwasher off.
4. The dishwasher is now ready to run a selected cycle. Add more detergent if necessary.

**WARNING**  
**DO NOT PULL DOOR FULLY OPEN WHILE DISHWASHER IS IN OPERATION. QUICKLY OPENING THE DOOR WHILE DISHWASHER IS IN OPERATION COULD RESULT IN SERIOUS SCALDING.**



ON/OFF BUTTON

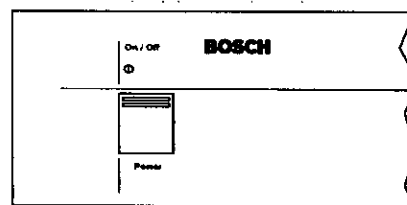

Figure 27

CHANGE CYCLE

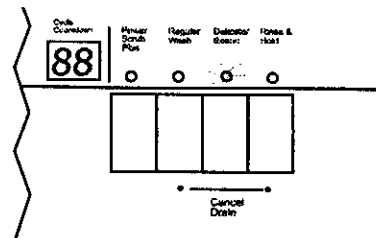

Figure 28

CANCEL CYCLE

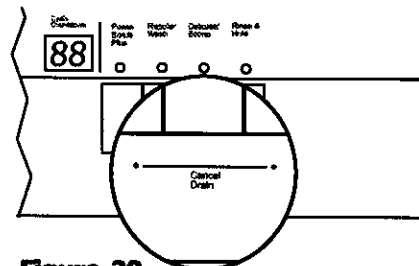

Figure 29

# PROGRAM OPTIONS & UNLOADING

## Program Features for Integra Ltd.

**Wash Light** is illuminated when any wash cycle is in operation up until the completion of the final rinse cycle.

**Dry Light** is illuminated during the condensation drying phase.

**Clean Light** is illuminated when the dishes are cleaned, dried and ready to be unloaded.

## Condensation Drying

The combination of a high final rinse temperature, the tub's cool stainless steel interior and the sheeting action of a Rinse Agent result in effective and efficient drying. The closed condensation drying feature is hygienic, and saves energy and money.

Note: For BEST DRYING results, it is essential to use a RINSE AGENT and keep the Rinse Dispenser FULL. (See Figure 31).

## Additional Drying Temperature for Models SHU9952/5/6UC:

1. Open the door, hold down the "Regular" button and simultaneously turn the dishwasher on. The display will blink with a code of "0" or "1". Release the buttons. You are in program mode.
  2. If the display blinks with a "0", you are programmed for a lower temperature rinse. If the display blinks with a "1", you are programmed for a higher temperature rinse, thus improving dish drying.
  3. To change the program code, press the "Regular" button.
  4. When you have the desired code selected, turn the dishwasher off to take it out of program mode.
- Note: For the SHV 6800 models, push "Power Scrub" button in lieu of "Regular" button.

## Unloading

When unloading the dishwasher always unload the lower rack first and then unload the upper rack. This will minimize the chance of water drops from the upper rack falling on the dishes in the lower rack. The silverware basket(s) of the Bosch dishwasher can be removed for easy unloading.

The dishware tends to get hot immediately following a completed cycle. If the door is opened slightly for a few minutes before unloading, the dishes will cool more quickly.

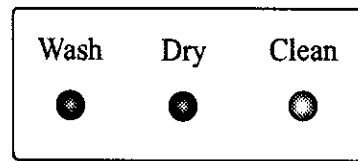

Figure 30



Figure 31

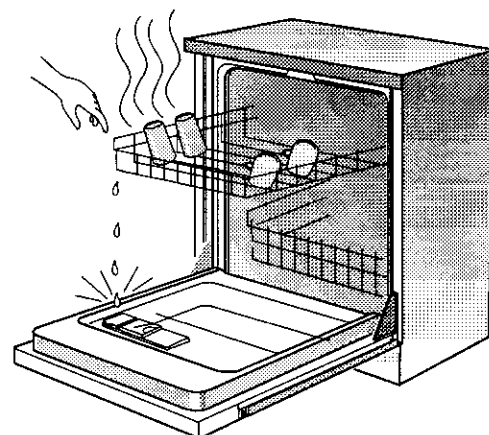

Figure 32

## SPECIAL FEATURES

Please refer to the (pg. 27, Table 6) features chart to determine which special features your particular model dishwasher has.

### Delayed Start

On Bosch dishwashers with a 2 digit LED display, the start of the washing cycle can be delayed for up to 9 hours, and the models with a 3 digit display up to 19 hrs. Follow these steps to delay the start of a wash cycle:

1. For SHU/SHI models, close the door until it snaps shut, for SHV and SHU9950 models open door to reveal LED display.
2. Press the on/off button. The indicator light for the cycle that was last selected illuminates.
3. Immediately press the timer button labeled DELAY-START-HOURS and the LED display will show "1h".
4. Press the DELAY-START-HOURS button as many times as necessary until the LED display shows the desired number of hours. (Ex: 1h, 2h, 3h...).

### DELAY START BUTTON

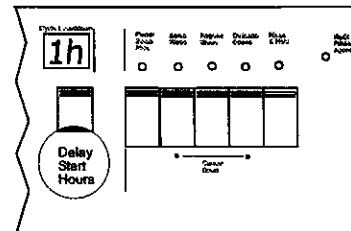

Figure 33

The cycle can be changed at any time during the delay.

### The Top Rack Only™ Cycle

Some BOSCH models have a Top Rack Only cycle that saves energy and water when you have only a small load of dishes. Also, you'll use less detergent for the Top Rack Only cycle. The washing time, however, is not reduced.

The upper rack of the dishwasher has been designed with flexibility in mind. You can load glasses, cups, plates, bowls and small pots in many different positions to fit your needs. Figure 34 shows a typical mixed load placed correctly in the upper rack for the Top Rack Only cycle.

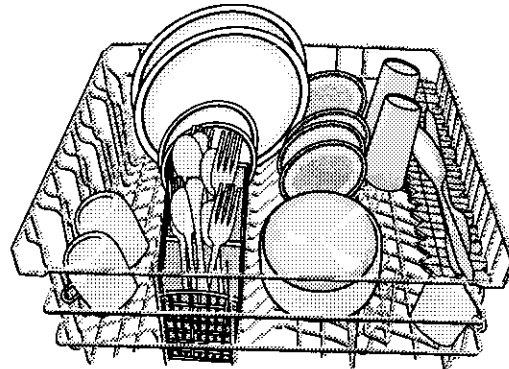

Figure 34

### OptiMISER

(SHU9950 & SHV6800 models only)

The OptiMISER Cycle is used in conjunction with another wash cycle. OptiMISER cuts down the amount of time it takes to wash a load of dishes.

1. Turn dishwasher on.
2. Choose a wash program and push it's button.
3. Then, push the OptiMISER button.



Figure 35

## How to Operate the Cycle Completion Signal

1. Open door, hold down program button (see Beeper Table on right) and simultaneously turn the Dishwasher on.
  2. Release program button.
    - a. **For SHV 6803 and SHU9950 models:**  
The display will blink with a code of "0", "1" or "2". You are in program mode.
      - If the display blinks with a "0", you will hear no signal (indicates OFF).
      - If the display blinks with a "1", you will hear a LOW volume signal.
      - If the display blinks with a "2", you will hear a HIGHER volume signal.
    - b. **For all other models with the beeper function:**
      - If the machine beeps, then the Cycle Completion Signal has been enabled.
      - When you push the button again and it does not beep, it means that the Cycle Completion Signal has been disabled.
  3. To change the program, press the program button until the desired setting is selected.
  4. Turn the Dishwasher off to take it out of program mode.
- \* At the end of a wash cycle, the beeper will sound off two times, and again every 15 minutes until the dishwasher is turned off.

MODEL	Program BUTTON
SHU 9950	Delay Start Hours
SHU 9910/9920	Delicate/Econo
SHU 8800/8810	Quick Wash
SHV 6800	Delay Start Hours
SHV 4800	Delicate/Econo
SHV 4300	Delicate/Econo

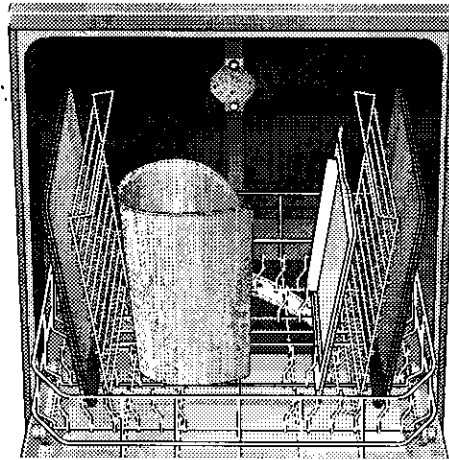

Figure 36

## Accommodating Extra Tall Items

If you have extra tall items that cannot fit in the bottom rack without interfering with the upper spray arm or without hitting the top rack (max. height 22"), you can remove the upper rack. A special accessory, the Extra Tall Item Sprinkler, lets you run the dishwasher with top rack removed. See Figures 36 and 37.

## Installing "Extra Tall Item Sprinkler"

1. With top rack empty, remove it from the dishwasher by pulling the rack toward you to the point where you can lift it up and out, disengaging the wheels from the side rails.
2. Place the "Extra Tall Item Sprinkler" over the top rack spray outlet at the back of the dishwasher tub and turn it clockwise to lock the sprinkler head in place. See Figure 37.
3. Place the extra tall items in the bottom rack for washing, as shown in Figure 36. To remove the Extra Tall Item Sprinkler, turn it counterclockwise and pull it out. Then replace the top rack.

**Note:** Be sure to *remove* the Extra Tall Item Sprinkler before you *reinstall* the top rack, otherwise the door could become damaged and not close properly.

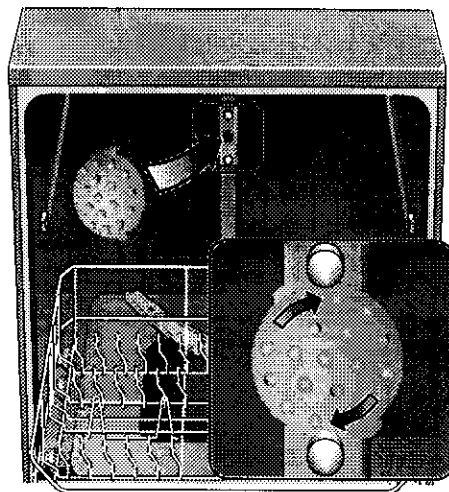

Figure 37



# CARE AND CLEANING

## General Maintenance

Certain areas of your Bosch Dishwasher require periodic owner inspection. The following maintenance tasks can be performed to help assure top performance:

- **Check the Large Object Trap \***
- **Check the Wash Arms**
- **Clean Stainless Steel Inner Door**
- **Clean Door Panel**  
(Stainless Steel or Colored)
- **Clean the Door Gasket**

*These tasks are described in subsequent sections.*

### Check Large Object Trap:

The filter system is self-cleaning. The purpose of the Large Object Trap is to help prevent undesirable objects such as bones, glass, straws and toothpicks from damaging the pump system. Items such as these should be removed from the Large Object Trap.

### To Remove the Large Object Trap:

1. Turn the ring handle (as shown in Figure 38) 1/4 turn counter-clockwise and lift out.
2. Lift out the large object trap for inspection.
3. If large solids, such as bones, large seed(s), or paper labels are present, remove them by hand. The Large Object Trap can also be flushed out by holding it under running water.

### To Re-insert the Large Object

#### Trap in the Dishwasher:

1. Press the filters firmly into position.
2. Turn 1/4 turn clockwise until locked.
3. Pull gently to ensure that it is locked in place.

## Triple Filter System

### 1. Large Object Trap

### 2. Micro Filter

### 3. Fine Filter

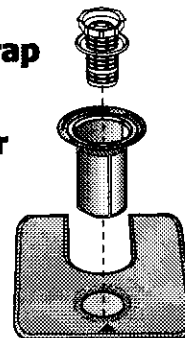

Figure 38

\* Bosch dishwashers have a triple filter system composed of a Microfilter, a Fine Filter and a Large Object Trap.

Turn **left to loosen** (counter-clockwise) and **right to tighten** (clock-wise).

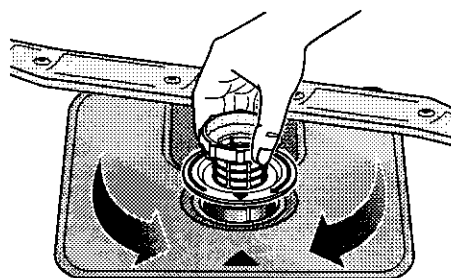

Figure 39

## Check Wash Arms

The wash arms should be checked periodically to ensure that the spray orifices are clear and unobstructed. If the wash arms require cleaning they are easy to remove and replace:

1. The lower wash arm simply snaps into place. Pull gently upwards to remove it.
2. The upper wash arm is held in position by a locking nut. Turn the locking ring approximately 1/8 turn clockwise to release the arm. See Figure 40
3. After cleaning, reinstall the wash arms.

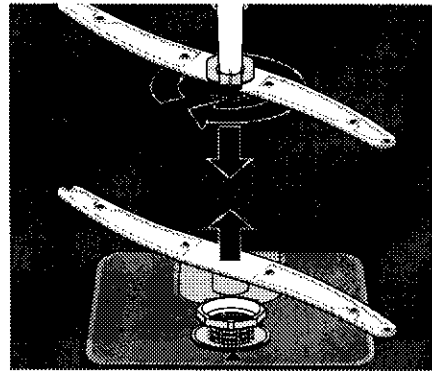

Figure 40

## Clean Stainless Steel Tank and Inner Door

Clean the outer edges of the inside door panel regularly to remove food particles that can gather there from normal loading. If spots begin to appear on the stainless steel tank or inner door, check to make sure that the rinse agent reservoir is full.

## Clean Outer Door

### Colored Doors

Use only soft cloth that is lightly dampened with soapy water. Do not use paper towels or an abrasive cloth.

### Stainless Steel Doors:

Use a soft cloth with a non-abrasive stainless steel cleaner. For best results, apply stainless steel cleaner directly to the cloth, then wipe the surface. Do not use metal scouring pads to clean the stainless steel surfaces as these can scratch the surface and leave metal fragments that can rust.

## Clean Door Gasket

Clean the door gasket regularly to remove food particles that can gather from normal loading. If necessary clean the door gasket using a damp cloth.

### For SHU 6800 Models Only:

Normally, the bottom door seal should not be cleaned. If necessary, wipe only with a dry clean cloth.

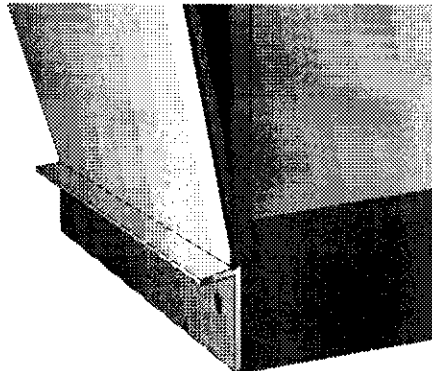

Figure 41

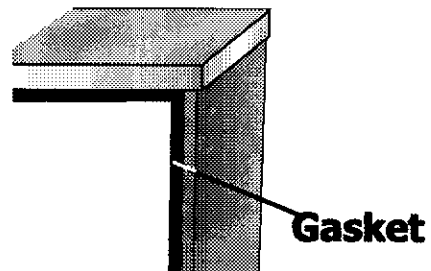

Figure 42

## SELF-HELP

Dishwashers may exhibit problems that are unrelated to a malfunction of the dishwasher itself. The following table may serve to answer your question about a problem you are having without having to call a repair person.

PROBLEM	POSSIBLE CAUSE
<b>Dishes do not dry</b>	Rinse-aid dispenser is empty. Fill rinse-aid dispenser.
<b>Indicator light(s) do not come on</b>	A fuse may have blown or a circuit breaker tripped. Replace fuse or reset circuit breaker at your fuse box/breaker box.
<b>Dishwasher does not start</b>	Door of dishwasher not properly closed. Close dishwasher making sure that door latches.
<b>Dishwasher runs a long time</b>	If the dishwasher completes the cycle, but the run time seems exceptionally long it is probably due to cold incoming water. To avoid this problem it is recommended that before starting the dishwasher: open the hot water faucet at the sink nearest the dishwasher and run the water until it runs hot. Then turn off the water and start the dishwasher.
<b>Machine cycle does not advance to rinse</b>	Water line is closed or inlet filter is blocked. Open water valve and/or check inlet filter.
<b>Water not pumped from dishwasher</b>	Kink in drain hose. Filter clogged. Kitchen sink clogged. Air gap (type installed at sink) clogged. Check drain hose and fine and coarse filters (see section titled CARE and CLEANING). Check kitchen sink to make sure it is draining well. If problem is kitchen sink not draining you may need a plumber rather than a serviceman for the dishwasher.
<b>Detergent dispenser lid will not close</b>	A program was not completely finished.
<b>Lower spray arm does not rotate freely</b>	Remove lower spray arm and clean arm and spray arm mounts.
<b>White deposits left on dishes</b>	Too little rinse-aid.
<b>Streaks on glassware</b>	Too much rinse-aid used.
<b>Rattling noises</b>	Utensils not properly arranged.
<b>Suds in dishwasher</b>	Incorrect type of detergent used. Use only automatic dishwasher detergents.
<b>Unsatisfactory washing result</b>	<ul style="list-style-type: none"> <li>• Incorrect amount of detergent or rinse agent.</li> <li>• Utensils incorrectly arranged or rack overloaded.</li> <li>• Wash arm rotation blocked by utensils.</li> <li>• Filters not properly fitted into position.</li> <li>• Clogged nozzles in wash arm(s)</li> <li>• Unsuitable program selected.</li> </ul>

Table 5

# MODELS FEATURES

Model Features Chart	MODELS															
	SHV 6800	SHU/SHI 6800	SHU 5310	SHV 4800	SHU 4320	SHV 4300	SHU 9910	SHU 9920	SHU 9950	SHU 3300	SHU 3300 DLX	SHU 3030	SHU 5300	SHU 8800	SHU 8810	SHU 3130
<b>FEATURES</b>																
161°F Wash Temperature	•	•	•	•	•	•	•	•	•	•	•	151°F	•	•	•	151°F
Bosch Sensotronic™	•	•	•	•	•	•	•	•	•	•	•	•	•	•	•	•
Bosch Top Rack Only™ Wash	•	•	•	•	•	•	•	•	•	•	•	•	•	•	•	•
Power Scrub Plus Cycle	•	•	•	•	•	•	•	•	•	•	•	•	•	•	•	•
Power Scrub Cycle												•				•
Scrub Wash Cycle	•	•	•										•			
Regular Wash Cycle	•	•	•	•	•	•	•	•	•	•	•	•	•	•	•	•
Delicate &/or Economy Wash Cycle*	•	•	•	•	•	•	•	•	•	•	•	•	•	•	•	•
Quick Wash Cycle	•	•								•				•	•	
Rinse & Hold Cycle	•	•	•	•	•	•	•	•	•	•	•	•	•	•	•	•
Height-Adjustable Upper Rack	•	•	•	•	•	•	•	•	•	•	•	•	•	•	•	•
Flip Tines on Bottom Rack	•	•	•	•	•	•	•	•	•	•	•	•	•	•	•	•
Flip Tines on Top Rack										•						
Electronic Controls	•	•	•	•	•	•	•	•	•	•	•	•	•	•	•	•
Delay Start	•	•	•							•			•			
Digital Countdown Display	•	•	•	•	•	•				•			•			
Bosch AVS II™ Silence Rating	47	46	49	48	52	54	52	48	48	54	52	56	50	46	54	54
"Refill Rinse Agent" Light	•	•	•	•	•	•			•	•			•			
Cycle Completion Signal	•			•		•	•	•	•	•				•	•	
Rackmatic										•						
Opti-MISER	•									•						
Upper Silverware Basket	•	•	•	•	•	•		•								•
Lower Silverware Basket	•	•	•	•	•	•	•	•	•	•	•	•	•	•	•	•
Flexible Silverware Basket										•						
Extra Silverware Basket										•						
Stemware Holder										•						
Fine Silver/Cutlery Tray										•						

## ACCESSORIES CHART

## PART NUMBER

SS door with SS handle (SHV Series only)*	SGZ	1005	UC
SS door frame and front (SHU Series only; accepts SS panel only)*	SGZ	1025	UC
Almond door frame and front (Accepts almond panel only)	SGZ	1024	UC
Heavy-duty white door frame kit** (For 1/8" to 1/4" panels)	SGZ	1042	UC
Heavy-duty black door frame kit** (For 1/8" to 1/4" panels)	SGZ	1046	UC
Adaptor kit for 60 cm cabinet	SGZ	1040	UC
Extra large knife rack	SGZ	1000	UC
Glass rack insert for bottom rack (max. ht. 13.5")	SGZ	2004	UC

Table 6

\*SS = Stainless Steel

## BOSCH DISHWASHER FEATURES DESCRIPTIONS

**Bosch AVS II™ Silence Rating:** A two-pump motor system, suspension motor, and triple insulation make Bosch the quietest dishwashers in North America.

**Bosch SoundSeal™:** An added measure of insulation on the SHU 6800 series in the form of a sound tight seal eliminating noise typically emitted from the toe-kick area.

**Bosch Suspension Motor™:** By suspending the motor in air, any vibration that may be caused is eliminated.

**Condensation Drying:** The combination of a high final rinse temperature, the tub's cool stainless steel interior, and the sheeting action of a Rinse Agent result in effective and efficient drying. The closed condensation drying feature is hygienic, and saves energy and money.

**Cycle Completion Signal:** An optional beeper which lets you know when the cycle is complete.

**Delicate/Economy or "Delicate Wash" Cycle:** Saves water and energy, while removing loosely attached food from delicate dishware.

**Delay Start:** Delay the dishwasher's start for up to nine hours.

**Digital Countdown Display:** Lets you know exactly when the cycle will be complete.

**Electronic Controls:** Easy to use push button controls with programs

**Bosch Flow-Through Heater™:** Water passes through a heating chamber where it is efficiently heated to temperatures up to 161°F.

**Four-level Wash:** Multiple spraying levels provide optimal disbursement of fresh water.

**Height-Adjustable Upper Rack:** Raise or lower the top rack to fit items up to 14" tall in the bottom rack, or up to 10" tall in the top rack.

**LED Sequence Indicator:** Indicates the current point in the wash cycle, so you'll know if it's OK to add a last-minute dish.

**Exceptionally Low Water Usage:** Bosch dishwashers use very little water — as low as 2.5 gallons in the Delicate/Economy cycle.

**Flip Tines:** Fold-down tines in the bottom rack accommodate even large cookware.

**Nylon Racks:** Eliminate cuts and nicks with nylon-coated racks featuring a five-year warranty.

**Power Scrub Plus Cycle:** For heavy loads with stuck-on food, this powerful cycle features an extra 125° pre-wash to soak food loose.

**Quick Wash Cycle:** Cleans lightly soiled dishes in a short 29-minute cycle. Good for glassware, coffee cups, etc.

**"Refill Rinse Agent" Light:** Lets you know when you need to add more rinse agent.

**Regular Wash Cycle:** Good for everyday loads with loosely attached food.

**Rinse & Hold Cycle:** If you don't want to wash right away, use this cycle to rinse the dishware, then hold it until you have a full load.

**Bosch Sensotronic™:** Proven scanning technology checks the condition of the water, then automatically decides whether a second fresh-water fill is necessary.

**Scrub Wash Cycle:** For stuck-on foods that don't require soaking, this powerful cycle uses less water than the Power Scrub Plus Cycle.

**Stainless Steel Bosch Tall Tub™:** Provides the assurance of a lifetime warranty against rust-through with a hygienic interior surface.

**Bosch Top Rack Only™ Wash:** When you don't have a full load of dishes to wash, this feature washes just those on the top rack, saving water.

**Triple Filter System:** Three built-in filters ensure the distribution of clean water throughout the wash cycle, and an added safety feature preventing any foreign materials from clogging the main pump or drain pump.

**OptiMISER™ Cycle:** This cycle is used in conjunction with another program cycle to cut down the program wash time.

**RackMatic™:** To adjust the height of the top rack, simply push the rackmatik side tabs inward to adjust the rack up or down.

## CUSTOMER SERVICE

Your Bosch dishwasher requires no special care other than that described in the care and cleaning chapter. If you are having a problem with your dishwasher, before calling for service please refer to the Self-Help chapter. If service becomes necessary, contact your dealer or installer or an authorized service center. Do not attempt to repair the appliance yourself. Any work performed by unauthorized personnel may void the warranty.

If you are having a problem with your BOSCH dishwasher and are not pleased with the service you have received, please take the following steps (in the order listed below) until the problem is corrected to your satisfaction.

1. Contact your installer or the Bosch Authorized Service Contractor in your area.
2. E-mail us from the customer service section of our web site, **[www.boschappliances.com](http://www.boschappliances.com)**.
3. Write to us at the address below:  
**BSH Home Appliances, Corp.**  
**5551 McFadden Avenue**  
**Huntington Beach, CA 92649**
4. Call us at: **1-800/944-2904**.

Please be sure to include (if writing), or have available (if calling), the following information:

- Model Number
- Serial Number
- Date of Original Purchase
- Date Problem Originated
- Explanation of Problem

Also, if writing, please be sure to include a daytime phone number.

You will find the model number and serial number information on the label located on the right-hand side of the inner door of the dishwasher. See Figure 1 for an example.

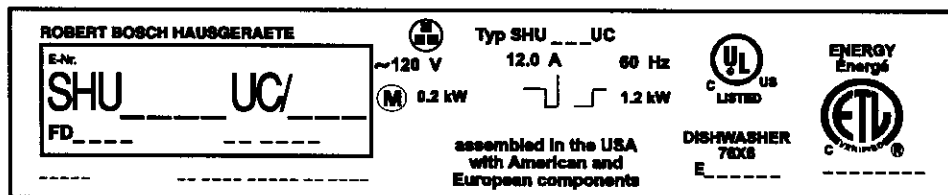

Figure 43

Please make a copy of your invoice and keep it with your manual.

# Statement of Warranties - Bosch Dishwashers

The warranties provided by BSH Home Appliances Corp. ("Bosch") in this Statement of Warranties apply only to Bosch Dishwashers sold to the first using purchaser by Bosch or its authorized dealers, retailers or service centers in the United States or Canada. The Warranties provided herein are not transferable.

LENGTH OF WARRANTY	SCOPE OF WARRANTY
1 Year Full Limited Warranty From Date of Installation*	Bosch will repair or replace any component part that proves defective under conditions of normal home use free of charge, labor and shipping costs included. Repair service must be performed by an Authorized Bosch Service Center (All cosmetic defects must be reported within 30 days of installation).
2 Year Limited Warranty From Date of Installation*	Bosch will provide replacement parts free of charge for any component part that proves defective under conditions of normal home use, labor charges excluded.
5 Year Limited Warranty on Electronics From Date of Installation*	Bosch will repair or replace any microprocessor or printed circuit boards that prove defective under conditions of normal home use during the second through fifth year from the date of original purchase, labor charges excluded.
5 Year Limited Warranty From Date of Installation*	Bosch will replace the upper or lower dish rack (excluding rack components) free of charge, if the rack proves defective in materials or workmanship under conditions of normal home use, labor charges excluded.
Lifetime Limited Warranty against Stainless Steel Rust Through From Date of Installation*	Bosch will replace your dishwasher with the same model or a current model that is equivalent or better in functionality if the inner liner should rust through under conditions of normal home use, labor charges excluded.  Bosch will replace the stainless steel door of any dishwasher if the door should rust through under conditions of normal home use, labor charges excluded.

\* Date of installation shall refer to the earlier of the date the dishwasher is installed or ten business days after the delivery date.

## EXCLUSIONS:

This warranty does not cover service calls or repairs to correct the installation of the dishwasher, to provide instructions on the use of your dishwasher, to replace house fuses or correct plumbing or the electric wiring in your home or to repair any dishwasher that's use was in a manner other than what is normal and customary for home use. In addition, the warranties provided in this Statement exclude any defects or damage arising from accident, alteration, misuse, abuse, improper installation, unauthorized service work, external forces beyond Bosch's control, such as fire, flood, and other acts of God, or installation not in accordance with local electrical or plumbing codes. Labor charges incurred in the repair or replacement of any dishwasher more than one year from date of installation shall not be covered by this warranty. Any and all replaced and/or repaired parts shall assume the identity of the original for purposes of the applicable warranty period.

TO THE EXTENT PERMITTED BY LAW, THIS WARRANTY IS IN LIEU OF ALL OTHER EXPRESS AND IMPLIED WARRANTIES, INCLUDING THE IMPLIED WARRANTIES OF MERCHANTABILITY AND FITNESS FOR A PARTICULAR PURPOSE. BOSCH DOES NOT ASSUME ANY RESPONSIBILITY FOR INCIDENTAL OR CONSEQUENTIAL DAMAGES.

TO OBTAIN WARRANTY SERVICE, CONTACT THE NEAREST BOSCH AUTHORIZED SERVICE CENTER OR CALL 1 - 800 / 944 - 2904, OR WRITE BSH HOME APPLIANCES CORP. DIRECTLY AT: 5551 McFADDEN AVENUE, HUNTINGTON BEACH, CA 92649. BE SURE TO PROVIDE YOUR DISHWASHER'S MODEL, SERIAL NUMBER, PURCHASE DATE AND THE SELLER'S NAME AND ADDRESS.<sup>1</sup>

# **BOSCH**



## Free Manuals Download Website

<http://myh66.com>

<http://usermanuals.us>

<http://www.somanuals.com>

<http://www.4manuals.cc>

<http://www.manual-lib.com>

<http://www.404manual.com>

<http://www.luxmanual.com>

<http://aubethermostatmanual.com>

Golf course search by state

<http://golfingnear.com>

Email search by domain

<http://emailbydomain.com>

Auto manuals search

<http://auto.somanuals.com>

TV manuals search

<http://tv.somanuals.com>