

At your side.
brother®

USER'S GUIDE

MFC-8420

MFC-8820D



At your side.
brother®

THIS EQUIPMENT IS DESIGNED TO WORK WITH A TWO WIRE ANALOGUE PSTN LINE FITTED WITH THE APPROPRIATE CONNECTOR.

APPROVAL INFORMATION

Brother advises that this product may not function correctly in a country other than where it was originally purchased, and does not offer any warranty in the event that this product is used on public telecommunication lines in another country.

Compilation and Publication Notice

Under the supervision of Brother Industries Ltd., this manual has been compiled and published, covering the latest product descriptions and specifications.

The contents of this manual and the specifications of this product are subject to change without notice.





Brother reserves the right to make changes without notice in the specifications and materials contained herein and shall not be responsible for any damages (including consequential) caused by reliance on the materials presented, including but not limited to typographical and other errors relating to the publication.

Safety precautions

To use the MFC safely

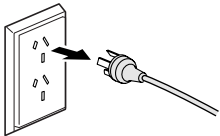
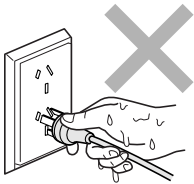
Save these instructions for later reference.

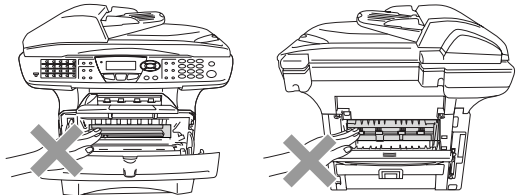
WARNING

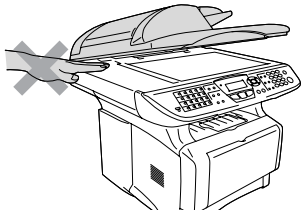
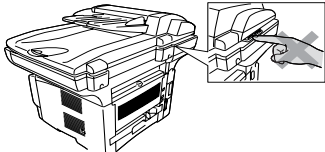
	<p>There are high voltage electrodes inside the machine. Before you clean the MFC or clear a paper jam, make sure you have unplugged the power cord from the power outlet.</p> 	<p>Do not handle the plug with wet hands. Doing this might cause an electrical shock.</p> 
	<p>After you use the MFC, some internal parts are extremely HOT! To prevent injuries, be careful not to put your fingers in the area shown in the illustration.</p> 	
	<p>To prevent injuries, be careful not to put your hands on the edge of the MFC under the document cover.</p> 	<p>To prevent injuries, be careful not to put your fingers in the area shown in the illustration.</p> 

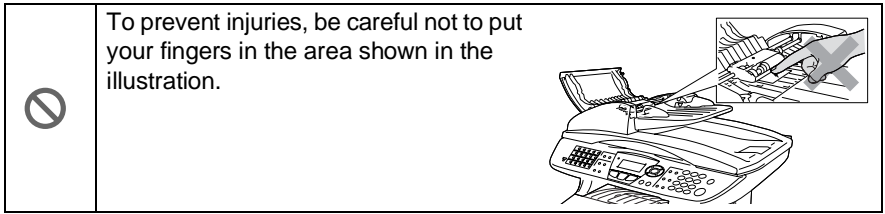

! WARNING

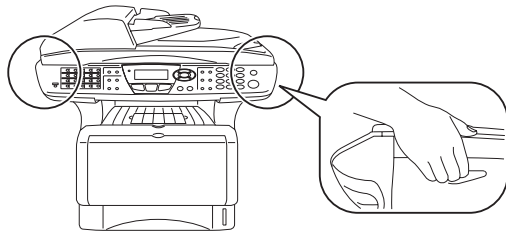

- When you move the MFC, grasp the side handholds that are under the scanner. Do NOT carry the MFC by holding it at the bottom.
- Use caution when installing or modifying telephone lines. Never touch telephone wires or terminals that are not insulated unless the telephone line has been disconnected at the wall socket. Never install telephone wiring during a lightning storm. Never install a telephone socket in a wet location.
- Install equipment with a power cord near a socket/outlet that is easily accessible.
- Do not use a telephone in the vicinity of gas leak to report leak.
- Do not use this product near appliances that use water, in a wet basement or near a swimming pool.
- There may be a remote risk of electric shock from lightning.

! Caution

- Lightning and power surges can damage this product! We recommend that you use a quality surge protection device on the AC power line and on the telephone line, or unplug the lines during a lightning storm.

Choosing a location

Place your MFC on a flat, stable surface that is free of vibration and shocks, such as a desk. Put the MFC near a telephone socket and a standard, grounded power outlet. Choose a location where the temperature remains between 10° and 32.5°C.

! Caution

- Avoid placing your MFC in a high-traffic area.
- Do not place near heaters, air conditioners, water, chemicals, or refrigerators.
- Do not expose the MFC to direct sunlight, excessive heat, moisture, or dust.
- Do not connect your MFC to electrical outlets controlled by wall switches or automatic timers.
- Disruption of power can wipe out information in the MFC's memory.
- Do not connect your MFC to electrical outlets on the same circuit as large appliances or other Equipment that might disrupt the power supply.
- Avoid interference sources, such as speakers or the base units of cordless phones.

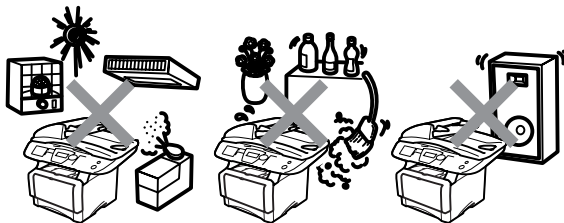

Quick Reference Guide







Sending faxes

Automatic Transmission

- 1 If it is not illuminated in green, press  (**Fax**).
- 2 Place the document face up in the ADF, or face down on the scanner glass.
- 3 Enter the fax number using One-Touch, Speed-Dial, Search or the dial pad.
- 4 Press **Start**.
- 5 If you are using the scanner glass, press **2** or **Start**.

Real Time Transmission

You can send faxes in real time.

- 1 If it is not illuminated in green, press  (**Fax**).
- 2 Place the document face up in the ADF, or face down on the scanner glass.
- 3 Press **Menu, 2, 2, 5**.
- 4 Press  or  to select **On**, and then press **Set**.
—OR—
For the next transmission only, press  or  to select **Next Fax Only**, and then press **Set**.
- 5 For the next fax only, press  or  to select **Next Fax: On**, and then press **Set**.



- 6 Press **1** if you want to choose more settings and the LCD will return to the Setup send menu.

—OR—

- Press **2** to fax.
- 7 Enter the fax number.
- 8 Press **Start**.

Receiving faxes

Select Receive Mode

- 1 Press **Menu, 0, 1**.
- 2 Press  or  to select **Fax Only**, **Manual**, **Fax/Tel** and **External TAD** and then press **Set**.

Storing numbers

Storing One-Touch Dial numbers

- 1 Press **Menu, 2, 3, 1**.
- 2 Press the One-Touch key where you want to store the number.
- 3 Enter a number (up to 20 digits), and then press **Set**.
- 4 Enter a name (up to 15 characters or leave it blank), and then press **Set**.
- 5 Press **Stop/Exit**.

Storing Speed-Dial numbers

- 1 Press **Menu**, **2**, **3**, **2**.
- 2 Enter a three-digit Speed-Dial number, and then press **Set**.
- 3 Enter a number (up to 20 digits), and then press **Set**.
- 4 Enter a name (up to 15 characters or leave it blank), and then press **Set**.
- 5 Press **Stop/Exit**.



Dialing operations

One-Touch Dialing / Speed-Dialing

- 1 If it is not illuminated in green, press  (**Fax**).
- 2 Place the document face up in the ADF, or face down on the scanner glass.
- 3 Press the One-Touch key of the number you want to call.
—OR—
Press **Search/Speed Dial**, press **#**, and then press the three-digit Speed-Dial number.
- 4 Press **Start**.

Using Search

- 1 If it is not illuminated in green, press  (**Fax**).
- 2 Press **Search/Speed Dial**, and then enter the first letter of the name you're looking for.

- 3 Press  or  to search the memory.
- 4 Press **Start**.

Making copies

Single copy

- 1 Press  (**Copy**) to illuminate it in green.
- 2 Place the document face up in the ADF, or face down on the scanner glass.
- 3 Press **Start**.

Sorting multiple copies (Using the ADF)



- 1 Press  (**Copy**) to illuminate it in green.
- 2 Place the document face up in the ADF.
- 3 Use the dial pad to enter the number of copies you want (up to 99).
- 4 Press **Sort**.
- 5 Sort  icon appears on the LCD.
- 6 Press **Start**.

Table of Contents

1

Introduction	1-1
Using this Guide	1-1
Finding information.....	1-1
Symbols used in this Guide.....	1-1
MFC part names and operations	1-2
Control panel overview	1-5
Status LED indications	1-10
About fax machines	1-12
Fax tones and handshake	1-12
ECM (Error Correction Mode).....	1-13
Connecting the MFC.....	1-14
Connecting an external telephone.....	1-14
Connecting an external telephone answering device (TAD)	1-15
Sequence	1-15
Connections	1-16
Recording outgoing message (OGM) on an external TAD	1-17
Custom features on your phone line.....	1-17

2

Paper	2-1
About paper	2-1
Type and size of paper	2-1
Recommended paper	2-1
Choosing acceptable paper	2-2
Paper capacity of the paper trays.....	2-3
Paper specifications for each paper tray	2-4
How to load paper	2-5
To load paper or other media in the paper tray	2-5
To load paper or other media in the manual feed tray (For MFC-8420).....	2-7
To load paper or other media in the multi-purpose tray (MP tray) (For MFC-8820D)	2-9
To use Automatic Duplexing for fax, copy and print operations (For MFC-8820D)	2-11

3

On-screen programming	3-1
User-friendly programming	3-1
Menu table	3-1
Memory Storage	3-1
Navigation keys	3-2

4

Getting started	4-1
Initial Setup	4-1
Setting the Date and Time	4-1
Setting the Station ID	4-2
Entering text	4-3
Inserting spaces	4-3
Making corrections	4-4
Repeating letters	4-4
Special characters and symbols	4-4
General Setup	4-5
Setting the Mode Timer	4-5
Setting the Paper Type	4-6
Setting the Paper Size	4-7
Setting the Ring Volume	4-8
Setting the Beeper Volume	4-8
Setting the Speaker Volume	4-9
Setting the Clock Change	4-9
Toner Save	4-9
Sleep Time	4-10
Turning off the Scanner Lamp	4-10
Power Save	4-11
Setting the Tray Use for Copy mode	4-12
Setting the Tray Use for Fax mode	4-13
Setting the LCD Contrast	4-13
Initial Setup depending on Your Country	4-14
Setting Tone or Pulse dialing mode (Except for New Zealand)	4-14

5

Setup Receive	5-1
Basic receiving operations	5-1
Choosing the Receive Mode	5-1
To select or change your Receive Mode	5-2
Setting the Ring Delay	5-2
Setting the F/T Ring Time (Fax/Tel mode only)	5-3
Fax Detect	5-4
Printing a reduced incoming fax (Auto Reduction)	5-5
Reception into memory	5-6

Printing a fax from the memory	5-7
Setting the Print Density	5-7
Advanced receiving operations	5-8
Operation from extension telephones.....	5-8
For FAX/TEL mode only	5-8
Using a cordless external handset	5-9
Changing the remote codes	5-9
Polling.....	5-10
Secure Polling	5-10
Setup for Polling Receive (Standard)	5-10
Setup for Polling Receive with Secure Code.....	5-11
Setup Delayed Polling Receive	5-11
Sequential Polling.....	5-12
Setting Duplex printing for Fax mode (For MFC-8820D)	5-13
Telephone Service for Australia	5-14
Distinctive Ringing (Telstra® FaxStream® Duet®).....	5-14
Set the Distinctive Ringing to ON	5-15
Caller ID (Caller IDentification)	5-15
Advantages of Caller ID	5-15
How Does the Caller ID Work?.....	5-16
The Caller ID Appears on the Display When Your Telephone Rings.....	5-16
The Caller ID is Stored in Your MFC Memory	5-16
Viewing Caller ID List	5-17
Printing Caller ID List.....	5-17
Telephone Service for New Zealand	5-18
FaxAbility	5-18
How Will the Fax Machine Treat All Other Numbers?	5-18
What is the Advantage of Using the FaxAbility Function?.....	5-18
How Does FaxAbility Work?	5-19
How to Turn FaxAbility OFF or ON	5-20
Caller ID (Caller IDentification)	5-21
Advantages of Caller ID	5-21
How Does the Caller ID Work?.....	5-21
The Caller ID Appears on the Display When Your Telephone Rings.....	5-21
Viewing Caller ID List	5-22
Printing Caller ID List.....	5-22
Telephone Service for Some Countries.....	5-23
Distinctive Ringing (For Singapore and Hong Kong) ..	5-23
Setting the Distinctive Ringing.....	5-23

Caller ID (For Singapore and Hong Kong).....	5-24
Viewing Caller ID List.....	5-25
Printing Caller ID List.....	5-25

6

Setup Send	6-1
How to Fax.....	6-1
Enter Fax mode	6-1
Faxing from the automatic document feeder (ADF)....	6-1
Faxing from the ADF	6-2
Faxing from the scanner glass.....	6-3
Faxing legal size documents from the scanner glass....	6-5
Out of Memory message	6-5
Manual transmission.....	6-5
Automatic transmission.....	6-6
This is the easiest way to send a fax.....	6-6
Sending a fax at the end of a conversation	6-6
Basic sending operations.....	6-7
Sending faxes using multiple settings.....	6-7
Contrast	6-8
Fax Resolution.....	6-9
Manual and automatic fax Redial	6-9
Dual Access.....	6-10
Real Time Transmission	6-11
Checking job status	6-12
Canceling a job while scanning the document.....	6-12
Canceling a scheduled job.....	6-13
Advanced sending operations	6-14
Composing the electronic Cover Page	6-14
Composing your own comments	6-15
Cover page for the next fax only.....	6-15
Send a cover page for all faxes	6-16
Using a printed cover page.....	6-17
Broadcasting.....	6-17
Overseas Mode	6-19
Delayed Fax.....	6-20
Delayed Batch Transmission	6-21
Setup for Polled Transmit (Standard)	6-21
Setup for Polled Transmit with Secure Code.....	6-22
Memory Security.....	6-23
Setting up the password.....	6-24
Turning Memory Security on	6-24
Turning Memory Security off.....	6-24

Auto Dial numbers and dialing options	7-1
Storing numbers for easy dialing	7-1
Storing One-Touch Dial numbers	7-1
Storing Speed-Dial numbers	7-3
Changing One-Touch and Speed-Dial numbers	7-4
Setting up Groups for Broadcasting	7-5
Dialing options	7-7
Search	7-7
One-Touch Dialing.....	7-7
Speed-Dialing	7-8
Manual dialing	7-8
Using an external telephone.....	7-8
Access codes and credit card numbers.....	7-9
Pause	7-10
Tone or Pulse (Except for New Zealand)	7-10

Remote Fax Options	8-1
Fax Forwarding.....	8-1
Programming a Fax Forwarding number.....	8-1
Setting Fax Storage	8-2
Setting your Remote Access Code.....	8-3
Remote retrieval	8-4
Using your Remote Access Code.....	8-4
Remote commands	8-5
Retrieving fax messages	8-6
Changing your Fax Forwarding number	8-6

Printing reports	9-1
MFC settings and activity	9-1
Customizing the Transmission Verification Report.....	9-1
Setting the Journal Period	9-2
Printing reports	9-3
To print a report.....	9-3

Making copies	10-1
Using the MFC as a copier	10-1
Enter Copy mode.....	10-1
Temporary copy settings	10-2
Making a single copy from the ADF.....	10-3
Making multiple copies from the ADF.....	10-3
Single or multiple copies using the scanner glass....	10-4
Out of Memory message	10-5
Using the Copy keys	
(Temporary settings)	10-6

Enlarge/Reduce	10-7
Quality (type of document).....	10-9
Sorting copies using the ADF	10-9
Contrast	10-10
Tray Select.....	10-11
Duplex/N in 1	10-12
Duplex/N in 1 copy.....	10-14
N in 1 copy.....	10-14
Poster	10-16
Duplex (1 in 1) (For MFC-8820D).....	10-17
Duplex (2 in 1) and Duplex (4 in 1) (For MFC-8820D)	10-19
Changing the default copy settings.....	10-20
Quality	10-20
Contrast	10-20

11

Using the MFC as a printer 11-1

Using the Brother MFC-8420, MFC-8820D printer driver.....	11-1
How to print your document.....	11-2
Simultaneous printing and faxing.....	11-3
Two-sided printing (Duplex Printing).....	11-3
Automatic Duplex Printing (For MFC-8820D).....	11-3
Manual Duplex Printing	11-4
Face-down output tray	11-5
Printing on plain paper.....	11-5
The manual feed tray (For MFC-8420).....	11-5
The MP tray (For MFC-8820D).....	11-6
Printing on thicker paper and card stock	11-8
The manual feed tray (For MFC-8420).....	11-8
The multi-purpose tray (MP tray) (For MFC-8820D)	11-10
Printing on envelopes	11-12
Printer operation keys.....	11-17
Job Cancel.....	11-17
Secure key.....	11-17
Setting the Emulation Selection.....	11-18
Printing the Internal Font List.....	11-19
Printing the Print Configuration List	11-19
Restoring factory default settings	11-19

Printer driver settings	12-1
Printer driver settings.....	12-1
How to access the printer driver settings.....	12-1
Features in the Brother Native Driver	12-2
Basic tab.....	12-2
Paper Size.....	12-3
Multiple Page.....	12-3
Orientation.....	12-3
Copies	12-4
Media Type.....	12-4
Advanced tab.....	12-5
Print Quality.....	12-5
Duplex Printing.....	12-6
Watermark.....	12-8
Page Setting.....	12-10
Device Options	12-11
Secure Print.....	12-11
Accessories tab	12-14
Support tab.....	12-16
Features in the PS printer driver (For Windows®)	12-17
Ports tab	12-18
Device Settings tab.....	12-19
Layout tab.....	12-20
Booklet (For MFC-8820D) (For Windows® 2000/XP)	12-20
Paper/Quality tab.....	12-21
Advanced Options	12-22

How to scan using Windows®	13-1
Scanning a document	13-1
TWAIN compliant.....	13-1
How to access the Scanner.....	13-2
Scanning a document into the PC.....	13-3
Scanning a whole page	13-3
Pre Scanning to crop a portion you want to scan....	13-4
Settings in the Scanner window	13-6
Image Type	13-6
Resolution	13-6
Scan Type	13-7
Brightness	13-7
Contrast.....	13-7
Document Size	13-8

Scanning a document (For Windows® XP only)	13-10
WIA compliant.....	13-10
How to access the scanner.....	13-10
Scanning a document into the PC	13-11
Scanning a document using the ADF	13-11
Pre Scanning to crop a portion you want to scan using the scanner glass	13-13
Brother Scanner Utility.....	13-15
Using the scan key (For USB or Parallel interface cable users)	13-16
Scan to E-mail	13-17
Scan to Image	13-17
Scan to OCR.....	13-18
Scan to File.....	13-18
Using ScanSoft® PaperPort® and TextBridge® OCR	13-19
Viewing items.....	13-20
Organizing your items in folders	13-21
Quick links to other applications	13-21
ScanSoft® TextBridge® OCR lets you convert image text into text you can edit.....	13-22
You can Import items from other applications	13-23
You can Export items in other formats.....	13-23
Exporting an image file.....	13-23
How to Uninstall PaperPort® and ScanSoft® TextBridge®	13-24

14

Using the Brother Control Center	14-1
Brother MFL-Pro Control Center.....	14-1
AutoLoad the Brother Control Center	14-2
How to turn off AutoLoad.....	14-2
Brother Control Center features.....	14-3
Auto Configuration	14-3
Scan key operations	14-4
Copy operations.....	14-4
PC-Fax operation.....	14-4
Scanner settings for Scan, Copy and PC-Fax buttons.....	14-5
Global settings.....	14-5
Setting up the scanner configurations	14-6
Perform an operation from the Control Center screen.....	14-7
Scan to File.....	14-8
To access Scan to File Configurations screen	14-8
Scanner settings.....	14-8

Destination folder.....	14-9
Scan to E-mail	14-10
To access Scan to E-mail Configurations screen ...	14-10
Scanner settings.....	14-10
E-mail application	14-11
Send to Options.....	14-11
Scan to OCR (Word Processor)	14-12
To access Scan to OCR Configurations screen	14-12
Scanner settings.....	14-12
Word Processor.....	14-13
Scan to Image	14-14
To access Scan to Image Configurations screen ...	14-14
Scanner Settings.....	14-15
Target Application.....	14-15
Copy	14-16
To access the Copy Configurations screen.....	14-16
Scanner settings.....	14-17
Number of copies	14-17
Send a fax	14-18
To access the Send a fax Configurations screen ...	14-18
Scanner settings.....	14-18
PC-FAX Settings	14-19

15

Using the Windows®-Based Brother SmartUI

Control Center	15-1
Brother SmartUI Control Center	15-1
AutoLoad the Brother Control Center	15-2
How to turn off Auto Load.....	15-2
Brother Control Center features	15-3
Auto Configuration.....	15-4
Hardware Section: Changing the Scan to button configuration	15-5
Scan to E-mail	15-6
Scan to File.....	15-7
Scan to Image	15-8
Scan to OCR	15-10
Software Section	15-12
Scan	15-13
Copy	15-13
Fax.....	15-14
Custom	15-14
Scan to File.....	15-15
Scan to E-mail	15-17
File attachments	15-19

Scanner settings.....	15-20
Scan to OCR (Word Processing program)	15-21
Scan to Graphics application (example: Microsoft Paint)	15-23
Copy	15-25
Fax setting (PC-Fax using the Brother Fax Driver).....	15-27
FAX settings	15-28
Custom: User-defined buttons	15-29
Customizing a user-defined button	15-29
1. Select the Scan Action	15-29
2. Select Configuration for the Scan Type.....	15-30
3. Select Scan Settings.	15-34

16

Using MFC Remote Setup	16-1
MFC Remote Setup.....	16-1

17

Using Brother PC-FAX software	17-1
PC-FAX sending	17-1
Setting up user information.....	17-2
Sending setup.....	17-3
Outside line access.....	17-4
Include header.....	17-4
Address Book file.....	17-4
User interface	17-5
Simple style	17-5
Facsimile style	17-5
Speed-Dial setup	17-6
The Address Book	17-7
Setting up a Member in the Address Book	17-8
Setting up a Group for Broadcasting	17-9
Editing Member information.....	17-10
Deleting a Member or Group	17-10
Exporting the Address Book	17-10
Importing to the Address Book	17-12
Setting up a Cover Page.....	17-14
You can enter information in each field	17-15
Sending a file as a PC-FAX using the Facsimile style	17-16
Redial	17-17
Sending a file as a PC-FAX using the Simple style	17-17
Setting up PC-FAX receiving (Windows® 95/98/98SE/Me/2000 Professional and Windows NT® WS 4.0 only)	17-19

Running PC-FAX Receiving	17-19
Setting up your PC	17-19
Viewing new PC-FAX messages	17-20
Receiving a fax into the PC (Windows® XP only)	17-21
How to receive a fax automatically	17-21
How to view the received faxes	17-26

Using your MFC with a Macintosh®	18-1
Setting up your USB-equipped Apple® Macintosh®	18-1
Using the Brother printer driver with your Apple®	
Macintosh® (Mac OS® 8.6 - 9.2)	18-2
Using the Brother Printer Driver with Your Apple®	
Macintosh® (Mac OS X).....	18-4
Choosing page setup options	18-4
Specific settings.....	18-5
Using the PS driver with your Apple® Macintosh®	18-6
For Mac OS 8.6 to 9.2 Users.....	18-7
For Mac OS X users	18-11
Sending a fax from your Macintosh® application	18-14
For Mac OS 8.6 - 9.2 users	18-14
For Mac OS X users	18-16
Drag a vCard from the Mac® OS X Address Book	
application	18-18
Using the Brother TWAIN scanner driver with your	
Macintosh®	18-20
Accessing the scanner	18-20
Scanning an image into your Macintosh®	18-21
Scanning a whole page	18-21
Pre Scanning an image	18-22
Settings in the Scanner window	18-23
Image	18-23
Scanning Area.....	18-25
Business Card Size	18-25
Adjusting the Image.....	18-26
Using Presto!® PageManager®.....	18-27
Highlights.....	18-27
System requirements.....	18-28
Technical Support.....	18-28
MFC Remote Setup (Mac OS X)	18-29

Network Scanning	19-1
Registering your PC with the MFC	19-1
Using the Scan key.....	19-5
Scan to E-mail (PC).....	19-5
Scan to E-mail (E-mail server).....	19-6
Scan to Image	19-8
Scan to OCR.....	19-9
Scan to File.....	19-10

Brother Network PC-FAX software	20-1
Enable Network PC-FAX	20-1
Sending setup.....	20-2
Extra options in Address Book	20-3
Installing Network PC-FAX	20-4
Windows® 95/98/98SE and Me users.....	20-4
Using the Brother Network PC-FAX software.....	20-6
Quick Tips:.....	20-6
Sending a Network PC-FAX from your Macintosh®	
application	20-7
For Mac OS 8.6 - 9.2 users	20-7
For Mac OS X users	20-7

Important information	21-1
IEC 60825 Specification	21-1
Laser Diode	21-1
Caution	21-1
Important Information for Australia	21-2
Important Safety Instructions	21-2
IMPORTANT-For Your Safety	21-4
Disconnect device	21-4
LAN Connection	21-4
ENERGY STAR® Compliance Statement.....	21-4
Important Information for New Zealand	21-5
Important Safety Instructions	21-5
IMPORTANT-For Your Safety	21-9
Disconnect device	21-9
LAN Connection	21-9
IMPORTANT NOTICE	21-9
Important Information for Some Countries.....	21-10
Important Safety Instructions	21-10
Compilation and Publication Notice	21-12
Trademarks.....	21-13

22

Troubleshooting and routine maintenance	22-1
Troubleshooting	22-1
Error messages	22-1
Document jams.....	22-5
Document is jammed in the top of the ADF unit. ...	22-5
Document is jammed inside the ADF unit.	22-5
Paper jams	22-6
Paper is jammed in the duplex tray (For MFC-8820D)	22-10
If you are having difficulty with your MFC.....	22-12
Improving the print quality	22-17
Packing and shipping the MFC.....	22-21
Routine maintenance.....	22-24
Cleaning the scanner.....	22-24
Cleaning the printer	22-25
Cleaning the drum unit	22-26
Replacing the toner cartridge	22-27
How to replace the toner cartridge	22-27
Replacing the drum unit.....	22-32
Checking the drum life.....	22-35
Page Counter	22-35

23

Optional accessories	23-1
Memory board	23-1
Installing the optional memory board.....	23-2
Network (LAN) board.....	23-5
Before starting installation	23-6
Step 1: Hardware installation.....	23-6
Step 2: Connecting the NC-9100h to an Unshielded Twisted Pair 10BASE-T or 100BASE-TX Ethernet Network	23-9
LED	23-9
TEST SWITCH	23-10
Paper Tray #2.....	23-11

G

Glossary	G-1
-----------------------	------------

Specifications	S-1
Product description	S-1
General	S-1
Print media.....	S-2
Copy	S-2
Fax.....	S-3
Scanner	S-4
Printer	S-5
Interfaces.....	S-5
Computer requirements	S-6
Consumable items	S-7
Network (LAN) board (NC-9100h)	S-8
Index	I-1
Remote Retrieval Access card	R-1

1 Introduction

Using this Guide

Thank you for buying a Brother Multi-Function Center (MFC). Your MFC-8420, MFC-8820D is simple to use, with LCD screen instructions to guide you through programming it. You can make the most of your MFC by taking a few minutes to read this Guide.

Finding information

All the chapter headings and subheadings are listed in the Table of Contents. You will be able to find information about a specific feature or operation by checking the Index at the back of this Guide.

Symbols used in this Guide

Throughout this Guide you'll see special symbols alerting you to important warnings, notes and actions. To make things clearer and to help you press the correct keys, we used special fonts and added some of the messages that will appear in the LCD.

Bold Bold typeface identifies specific keys on the MFC control panel.

Italics Italicized typeface emphasizes an important point or refers you to a related topic.

`Courier New` Courier New typeface identifies the messages on the LCD of the MFC.

 Warnings inform you what to do to avoid possible personal injury or damage to the MFC.

 Cautions specify procedures you must follow or avoid to prevent possible damage to the machine.

 Notes tell you how you should respond to a situation that may arise or give tips about how the current operation works with other features.

 Improper Setup alerts you to devices and operations that are not compatible with the MFC.

MFC part names and operations

■ Front view

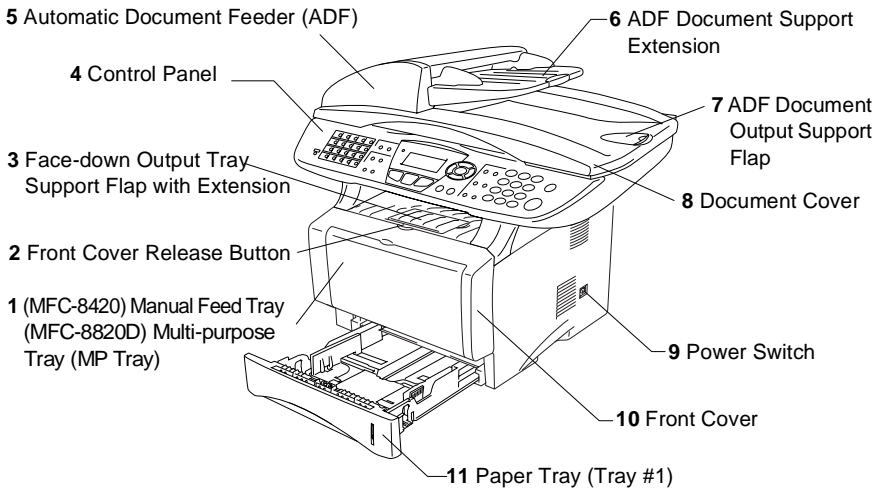

No.	Name	Description
1	(MFC-8420) Manual Feed Tray (MFC-8820D) Multi-purpose Tray (MP Tray)	Load paper here.
2	Front Cover Release Button	Press it to open the front cover.
3	Face-down Output Tray Support Flap with Extension (Support Flap)	Unfold it to prevent the printed paper from sliding off the MFC.
4	Control Panel	Use the keys and display to control the MFC.
5	Automatic Document Feeder (ADF)	Use the ADF unit for multiple page documents.
6	ADF Document Support Extension	Place the document here to use the ADF unit.
7	ADF Document Output Support Flap	Unfold to prevent the scanned pages from sliding off the MFC.
8	Document Cover	Open to place the document on the scanner glass.
9	Power Switch	Switch it on or off.
10	Front Cover	Open to install a toner cartridge or drum unit.
11	Paper Tray (Tray #1)	Load paper here.

■ Back view

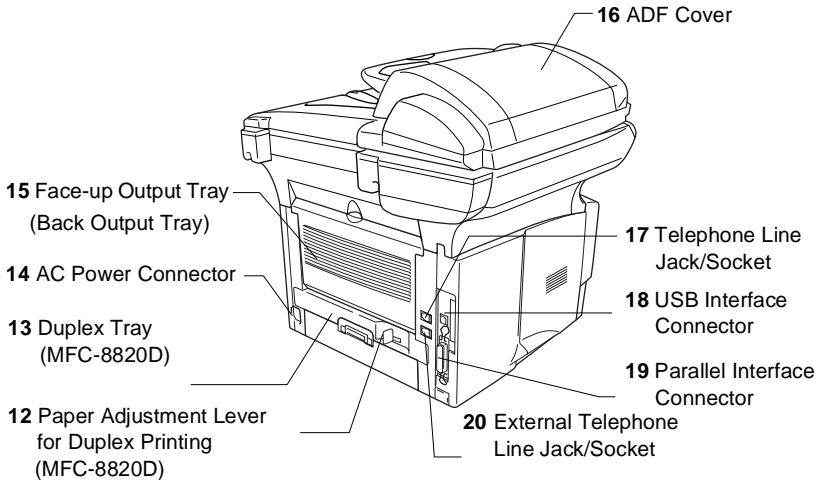

No.	Name	Description
12	Paper Adjustment Lever for Duplex Printing (MFC-8820D)	Use to match your paper size for duplex printing.
13	Duplex Tray (MFC-8820D)	Slide out to remove paper jammed inside the MFC.
14	AC Power Connector	Connect the AC Power Connector here.
15	Face-up Output Tray (Back Output Tray)	Open it when thicker paper is placed in the MP tray or Manual feed tray.
16	ADF Cover	Open to remove paper jammed inside the ADF unit.
17	Telephone Line Jack/Socket	Plug the line cord supplied with the machine here.
18	USB Interface Connector	Connect the USB Cable here.
19	Parallel Interface Connector	Connect the Parallel Cable here.
20	External Telephone Line Jack/Socket (Not for the UK)	Plug in the modular plug on the external telephone line here.

■ Inside view (Document cover open)

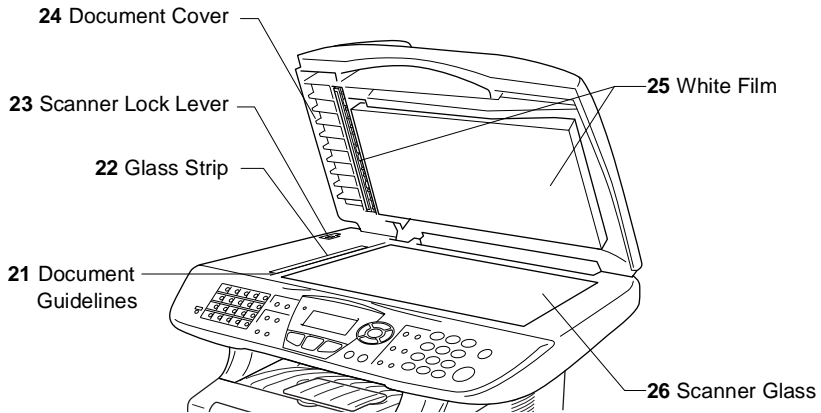

No.	Name	Description
21	Document Guidelines	Use to center the document on the scanner glass.
22	Glass Strip	This is used to scan documents when using the ADF.
23	Scanner Lock Lever	Use to lock/unlock the scanner when relocating the MFC.
24	Document Cover	Open to place the document on the scanner glass.
25	White Film	Clean it for good quality copying and scanning.
26	Scanner Glass	Place the document to be scanned here.

Control panel overview

MFC-8420 and MFC-8820D have similar control panel keys.



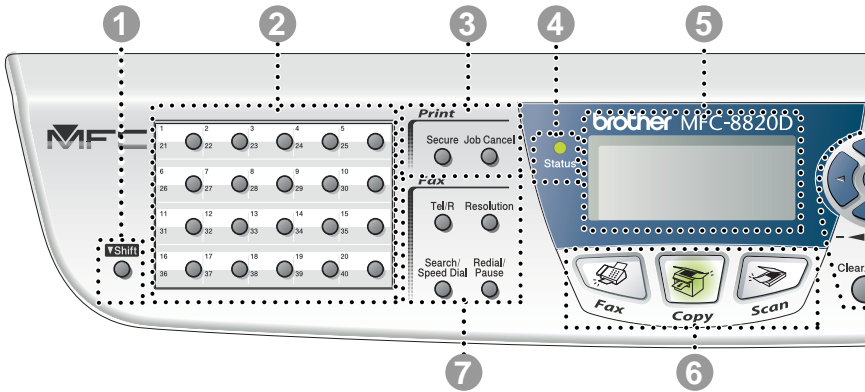

1 Shift

To access memory locations 21 through 40 in the One-Touch keys hold down the Shift key.

2 One-Touch keys

These 20 keys give you instant access to 40 previously stored dial numbers.

3 Print keys:

Secure

Lets you print out data saved in memory by entering your four-digit password.

Job Cancel

Clears data from the printer memory.

4  Status LED

(Light-Emitting Diode)

The LED will flash and change color depending on the MFC status.

5 5-Line Liquid Crystal Display (LCD)

Displays messages on the screen to help you to set up and use your MFC.

6 Mode keys:



Fax

Lets you access Fax mode.



Copy

Lets you access Copy mode.



Scan

Lets you access Scan mode.

7 Fax and telephone keys:

Hook

This key is used to have a telephone conversation having picked up the external handset in F/T pseudo-ringing etc. Also, use this key to gain access to an outside line and/or to recall the operator or transfer a call to another extension when it is connected to a PABX.

Resolution

Sets the resolution when you send a fax.

Search/Speed Dial

Lets you look up numbers that are stored in the dialing memory. It also lets you dial stored numbers by pressing **#** and a three-digit number.

Redial/Pause

Redials the last number you called. It also inserts a pause in auto dial numbers.

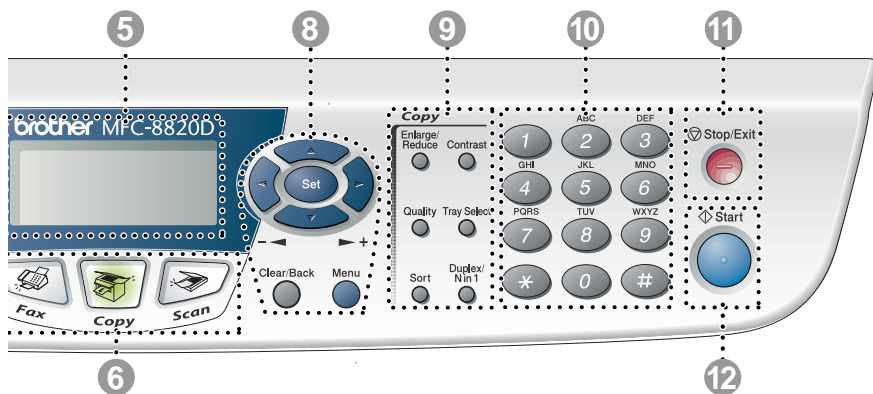

8 Navigation keys:

Menu

Lets you access the Menu to program.

Set

Lets you store your settings in the MFC.

Clear/Back

Deletes entered data or lets you exit the menu by pressing repeatedly.

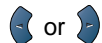

Press to scroll forward or backward to a menu selection.

When using the speaker or ring, you can press these keys to adjust the volume in fax mode.

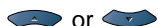

Press to scroll through the menus and options.

Also, you can use these keys to do a numeral search for the names of stored numbers in fax mode.

9 Copy keys

(Temporary settings):

Enlarge/Reduce

Lets you reduce or enlarge copies depending upon the ratio you select.

Contrast

Lets you make a copy that is lighter or darker than the document.

Quality

Lets you select the copy quality for your type of document.

Tray Select

You can select which tray you would like to use for the next copy.

Sort

Lets you sort multiple copies using the ADF.

N in 1 (For MFC-8420)

N in 1 lets you copy 2 or 4 pages onto one page.

Duplex/N in 1 (For MFC-8820D)

You can choose Duplex to copy on both sides of the paper or N in 1 to copy 2 or 4 pages onto one page.

10 Dial Pad

Use these keys to dial telephone and fax numbers and as a keyboard for entering information into the MFC.

The # key lets you temporarily switch the dialing mode during a telephone call from Pulse to Tone.

11 Stop/Exit

Stops a fax, copy and scan operation or exits from the menu.

12 Start





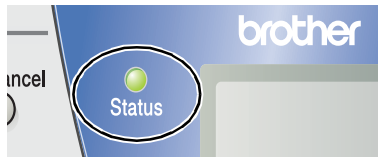

Lets you start sending faxes, making copies or scanning.





Status LED indications



The **Status** LED (Light Emitting Diode) will flash and change color depending on the MFC status.



The LED indications shown in the table below are used in the illustrations in this chapter.

LED				LED status
				LED is off.
	 Green	 Yellow	 Red	LED is on.
	 Green	 Yellow	 Red	LED is blinking.

LED	MFC status	Description
	Sleep Mode	The power switch is off or the MFC is in Sleep mode or Power save mode.
 Green	Warming Up	The MFC is warming up for printing.
 Green	Ready	The MFC is ready to print.
 Yellow	Receiving Data	The MFC is either receiving data from the computer, processing data in memory or printing data.
 Yellow	Data Remaining in Memory	Print data remains in the MFC memory.

LED	MFC status	Description
 Red	Service error	Follow the steps below. 1. Turn off the power switch. 2. Wait a few seconds, and then turn it back on and try to print again. If you cannot clear the error and see the same service call indication after turning the MFC back on, call your dealer or Brother authorized service center.
	 Red	Cover open
 Red	Toner empty	Replace the toner cartridge with a new one. (See <i>Replacing the toner cartridge</i> on page 22-27.)
	Paper error	Put paper in the tray or clear the paper jam. Check the LCD message. (See <i>Troubleshooting and routine maintenance</i> on page 22-1.)
	Scan lock	Check that the scanner lock lever is released. (See <i>Scanner Lock Lever</i> on page 1-4.)
	Others	Check the LCD message. (See <i>Troubleshooting and routine maintenance</i> on page 22-1.)
	Out of memory	Memory is full. (See <i>Error messages</i> on page 22-1.)



When the power switch is off or the MFC is in Sleep mode, the LED is off.

About fax machines

Fax tones and handshake

When someone is sending a fax, the MFC sends fax calling tones (CNG tones). These are quiet, intermittent beeps every 4-seconds. You'll hear them after you dial and press **Start** and they will continue for about 60 seconds after dialing. During that time, the sending machine must begin the "handshake", or connection, with the receiving machine.

Each time you use automatic procedures to send a fax, you are sending CNG tones over the phone line. You'll soon learn to listen for these quiet beeps each time you answer a phone on your fax line, so you will know if you are receiving a fax message.

The receiving fax responds with fax receiving tones, which are loud, chirping sounds. A receiving fax chirps for about 40 seconds over the phone line, and the LCD shows *Receiving*.

If your MFC is set to the *Fax Only* mode, it will answer every call automatically with fax receiving tones. If the other person hangs up, your MFC will continue to send the "chirps" for about 40 seconds, and the LCD continues to show *Receiving*. To cancel receiving, press **Stop/Exit**.

The fax 'handshake' is the time in which the sending machine's CNG tones and the receiving machines "chirps" overlap. This must be for at least 2 to 4 seconds, so both machines can understand how each is sending and receiving the fax. The handshake cannot begin until the call is answered, and the CNG tones only last for about 60 seconds after the number is dialed. So it is important for the receiving machine to answer the call in as few rings as possible.



When you have an external Telephone Answering Device (TAD) on your fax line, your TAD will decide the number of rings before the call is answered.

Pay special attention to the directions for connecting a TAD in this chapter. (See *Connecting an external telephone answering device (TAD)* on page 1-15.)

ECM (Error Correction Mode)

The Error Correction Mode (ECM) is a way for the MFC to check a fax transmission while it is in progress. If the MFC detects errors during fax transmission, it resends the pages of the fax that had an error. ECM transmissions are only possible between fax machines that both have this feature. If they do, you may send and receive fax messages that are continuously being checked by the MFC.

Your MFC must have enough memory for this feature to work.

Connecting the MFC

Connecting an external telephone

Although your MFC does not have a handset, you can connect a separate telephone (or telephone answering device) directly to your MFC as shown in the diagram below.

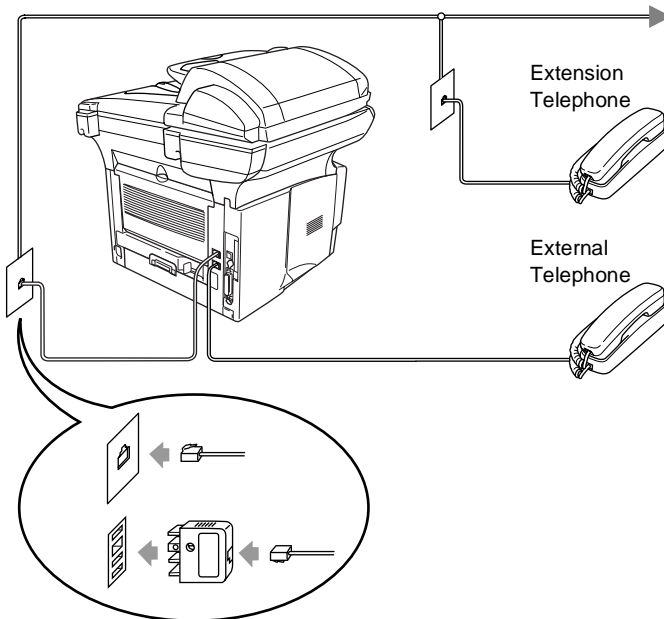

(Example for Australia)

Whenever this phone (or TAD) is in use, the LCD shows Telephone.

Connecting an external telephone answering device (TAD)

Sequence

You may choose to connect an answering device. However, when you have an **external** TAD on the same telephone line as the MFC, the TAD answers all calls and the MFC “listens” for fax calling (CNG) tones. If it hears them, the MFC takes over the call and receives the fax. If it doesn’t hear CNG tones, the MFC lets the TAD continue playing your outgoing message so your caller can leave you a voice message.

The TAD must answer within four rings (the recommended setting is two rings). The MFC cannot hear CNG tones until the TAD has answered the call, and with four rings there are only 8 to 10 seconds of CNG tones left for the fax “handshake”. Make sure you carefully follow the instructions in this guide for recording your outgoing message. We do not recommend using the toll saver feature on your external answering machine if it exceeds five rings.



If you do not receive all your faxes, reduce the Ring Delay setting on your external TAD.

⊘ Do not connect a TAD elsewhere on the same phone line.

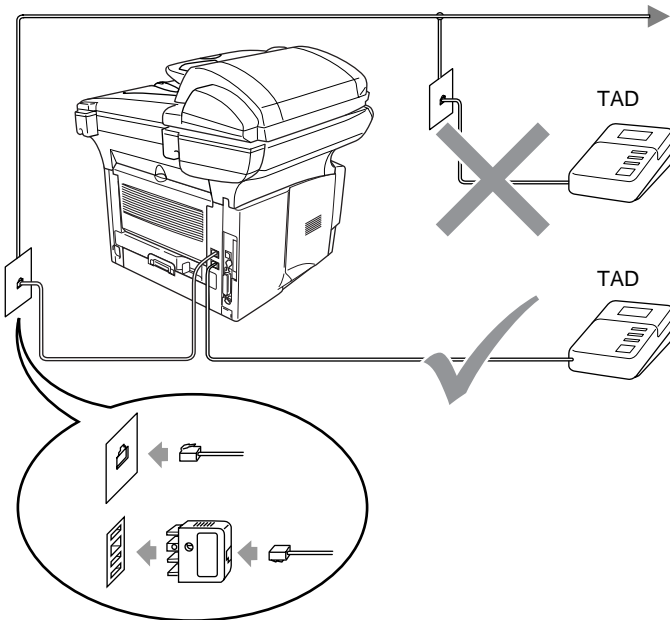

(Example for Australia)

Connections

- 1** Plug the telephone line cord from the wall socket into the back of the MFC, in the socket labeled LINE.
- 2** Plug the telephone line cord from your external TAD into the correct socket on the machine. (Make sure this cord is connected to the TAD at the TAD's telephone *line* socket, and not its telephone socket.)
- 3** Set your external TAD to one or two rings. (The MFC's Ring Delay setting does not apply.)
- 4** Record the outgoing message on your external TAD.
- 5** Set the TAD to answer calls.
- 6** Set the Receive Mode to `External TAD`.
(See *Choosing the Receive Mode* on page 5-1.)

Recording outgoing message (OGM) on an external TAD

Timing is important in recording this message. The message sets up the ways to handle both manual and automatic fax reception.

- 1 Record 5 seconds of silence at the beginning of your message. (This allows your MFC time to listen for the fax CNG tones of automatic transmissions before they stop.)
- 2 Limit your speaking to 20 seconds.
- 3 End your 20-second message by giving your Remote Activation Code for people sending manual faxes. For example:
*“After the beep, leave a message or send a fax by pressing * 51 (* 91 for New Zealand) and Start.”*



We recommend beginning your OGM with an initial 5-second silence because the MFC cannot hear fax tones over a resonant or loud voice. You may try omitting this pause, but if your MFC has trouble receiving, then you must re-record the OGM to include it.

Custom features on your phone line

If you have Voice Mail, Call Waiting, RingMaster, an answering service, an alarm system or other custom feature on one phone line it may create a problem with the operation of your MFC. (See *Custom features on a single line.* on page 22-13.)

2 Paper

About paper

Type and size of paper

The MFC loads paper from the installed paper tray, manual feed tray, multi-purpose tray or optional lower tray (LT-5000).

Tray Type	Model name
Paper tray (Tray #1)	MFC-8420 and MFC-8820D
Manual feed tray	MFC-8420
Multi-purpose tray (MP tray)	MFC-8820D
Optional lower tray (Tray #2)	Option for MFC-8420 and MFC-8820D

Recommended paper

Plain Paper: Xerox Premier 80 gsm
Xerox Business 80 gsm
Mode DATACOPY 80 gsm
IGEPA X-Press 80 gsm

Recycled paper: Xerox Recycled Supreme

Transparency: 3M CG 3300

Labels: Avery laser label L7163

- Before you buy a large amount of paper, please test some to make sure that the paper is suitable.
- Use paper that is made for plain-paper copying.
- Use paper that is 75 to 90 gsm.
- Use neutral paper. Do not use acidic or alkaline paper.
- Use long-grain paper.
- Use paper with a moisture content of approximately 5%.

Caution

Do not use ink jet paper. It may cause a paper jam and damage your MFC.



The output quality depends on the paper type and paper brand. Visit us at <http://solutions.brother.com> and check the latest recommendations for paper that can be used with the MFC-8420 and MFC-8820D.

Choosing acceptable paper

We recommend that you test paper (especially special sizes and types of paper) on the MFC before purchasing large quantities.

- Avoid feeding label sheets that are partly used or your MFC will be damaged.
- Avoid using coated paper, such as vinyl coated paper.
- Avoid using preprinted or highly textured paper, or paper with an embossed letterhead.

For optimum printing, use a recommended type of paper, especially for plain paper and transparencies. For more information on paper specifications, call your nearest authorized sales representative or the place where you purchased your MFC.

- Use labels or transparencies that are designed for use in *laser* printers.
- For the best print quality, we recommend using long-grained paper.
- If you are using special paper and the paper has problems feeding from the paper tray, try again using the manual feed tray or Multi-purpose tray.
- You can use recycled paper in this MFC.

Paper capacity of the paper trays

	Paper size	Number of sheets
Multi-purpose tray (MP tray) (MFC-8820D)	Width: 69.8 to 220 mm Height: 116 to 406.4 mm	Up to 50 sheets (80 gsm)
Manual feed tray (MFC-8420)	Width: 69.8 to 220 mm Height: 116 to 406.4 mm	Single sheet
Paper tray (Tray #1)	A4, Letter, Legal, B5 (ISO), B5 (JIS), Executive, A5, A6, B6 (ISO)	Up to 250 sheets (80 gsm)
Optional lower tray (Tray #2)	A4, Letter, Legal, B5 (ISO), B5 (JIS), Executive, A5, B6 (ISO)	Up to 250 sheets (80 gsm)
Duplex printing	A4, Letter, Legal	—

Paper specifications for each paper tray

Model		MFC-8420	MFC-8820D
Paper types	Multi-purpose tray	N/A	Plain paper, Bond paper, Recycled paper, Envelope* ¹ , Labels* ² , and Transparency* ²
	Manual feed tray	Plain paper, Bond paper, Recycled paper, Envelope, Labels, and Transparency	N/A
	Paper tray	Plain paper, Recycled paper, and Transparency* ²	
	Optional Lower tray	Plain paper, Recycled paper, and Transparency* ²	
Paper weights	Multi-purpose tray	N/A	60 to 161 gsm
	Manual feed tray	60 to 161 gsm	N/A
	Paper tray	60 to 105 gsm	
	Optional Lower tray	60 to 105 gsm	
Paper sizes	Multi-purpose tray	N/A	Width: 69.8 to 220 mm Height: 116 to 406.4 mm
	Manual feed tray	Width: 69.8 to 220 mm Height: 116 to 406.4 mm	N/A
	Paper tray	A4, Letter, Legal, B5 (ISO), B5 (JIS), Executive, A5, A6, B6 (ISO)	
	Optional Lower Tray	A4, Letter, Legal, B5 (ISO), B5 (JIS), Executive, A5, B6 (ISO)	

*1 Up to 3 envelopes

*2 Up to 10 sheets



When printing transparencies, remove each one from the face-down output tray after it exits the MFC.

How to load paper

To load paper or other media in the paper tray

- 1 Pull the paper tray completely out of the MFC.

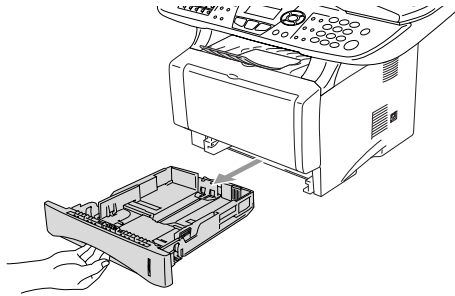

- 2 While pressing the paper guide release lever, slide the adjusters to fit the paper size.

Check that the guides are firmly in the slots.

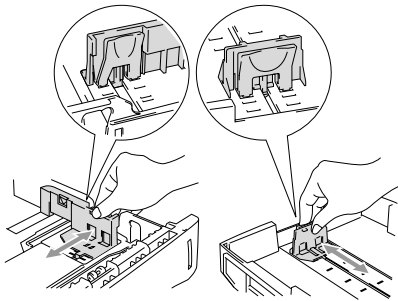

-  For Legal size paper, press the universal guide release button and pull out the back of the paper tray.

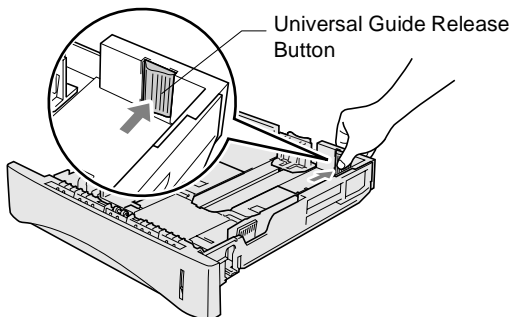

- 3 Fan the stack of paper well to avoid paper jams and misfeeds.
- 4 Put paper in the paper tray.

Check that the paper is flat in the tray, below the maximum paper mark, and that the paper guide is flush against the paper stack.

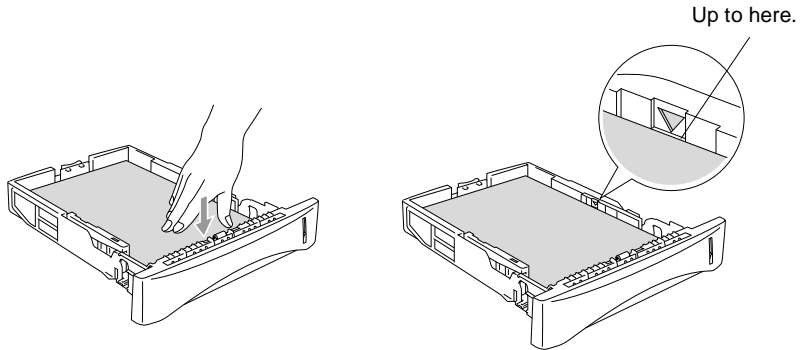

- 5 Put the paper tray firmly back in the MFC and unfold the support flap before you use the MFC.

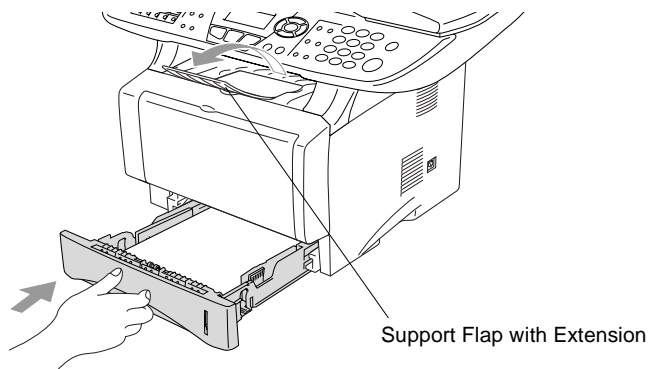

When you put paper in the paper tray, please remember the following:

- The side to be printed on must be face down.
- Put the leading edge (top of the paper) in first and push it gently into the tray.
- To copy or receive faxes on Legal size paper, unfold the support flap extension, too.

To load paper or other media in the manual feed tray (For MFC-8420)

 When printing envelopes and labels you should only use the manual feed tray.

- 1 Open the manual feed tray. Slide the paper guides to fit the paper size.

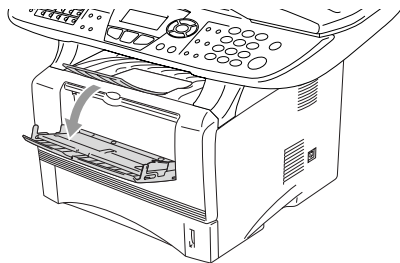

- 2 Using both hands put paper in the manual feed tray until the front edge of the paper touches the paper feed roller. Hold the paper in this position until the MFC automatically feeds the paper in for a short distance, and then let go of the paper.

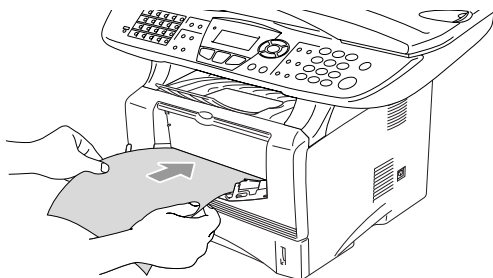



When you put paper in the manual feed, please remember the following:

- The side to be printed on must be face up.
- Put the leading edge (top of the paper) in first and push it gently into the tray.
- Make sure that the paper is straight and in the proper position on the manual feed tray. If it is not, the paper may not be fed properly, resulting in a skewed printout or a paper jam.
- Do not put more than one sheet of paper or envelope in the manual feed tray at any one time, or it may cause a jam.

To load paper or other media in the multi-purpose tray (MP tray) (For MFC-8820D)

 When printing envelopes and labels you should only use the multi-purpose tray.

1 Open the MP tray and lower it gently.

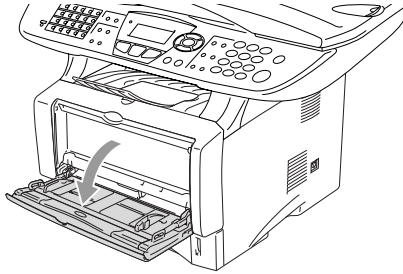

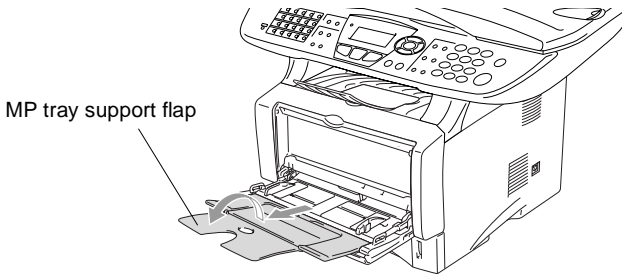

2 Pull out and unfold the MP tray support flap.

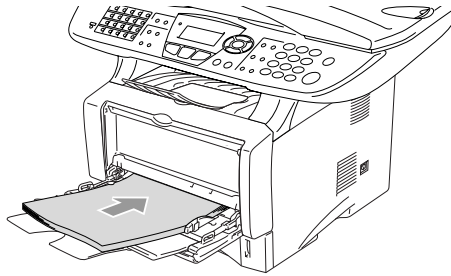

- 3** When loading paper in the MP tray, make sure it touches the back of the tray.



-  Make sure that the paper is straight and in the proper position on the MP tray. If it is not, the paper may not be fed properly, resulting in a skewed printout or a paper jam.
-  You can place up to 3 envelopes or up to 50 sheets of 80 gsm paper in the MP tray.
- 4** While pressing the paper-guide release lever, slide the paper guide to fit the paper size.

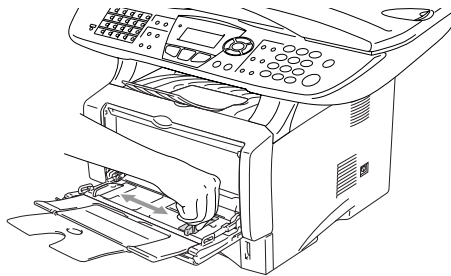

-  When you put paper in the MP tray, please remember the following:
- The side to be printed on must be face up.
 - During printing, the inside tray rises to feed paper into the MFC.
 - Put the leading edge (top of the paper) in first and push it gently into the tray.

To use Automatic Duplexing for fax, copy and print operations (For MFC-8820D)

If you want to print on both sides of the paper using the Duplex feature for fax, copy or print, you will need to set the Paper Adjustment Lever to the size of paper you are using.

This feature is available for A4, Letter or Legal size paper. (See *Setting Duplex printing for Fax mode (For MFC-8820D)* on page 5-13, *Duplex/N in 1* on page 10-12 and *Two-sided printing (Duplex Printing)* on page 11-3.)

- 1 Load paper in the Paper Tray or Multi-purpose Tray.
- 2 Set the Paper Adjustment Lever for Duplex Printing, in the back of the MFC, to match your paper size.

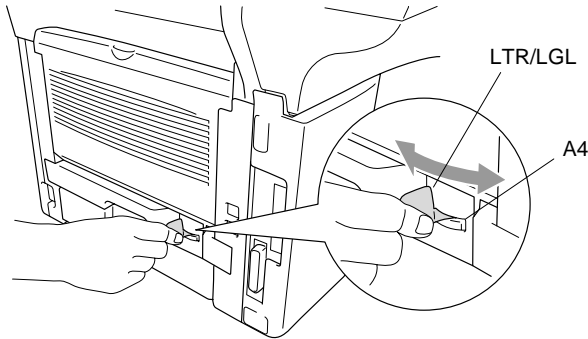

- 3 Your MFC is now ready to print two-sided pages.

3

On-screen programming

User-friendly programming

Your MFC is designed to be easy to use with LCD on-screen programming using the navigation keys. User-friendly programming helps you take full advantage of all the menu selections your MFC has to offer.

Since your programming is done on the LCD, we have created step-by-step on-screen instructions to help you program your MFC. All you need to do is follow the instructions as they guide you through the menu selections and programming options.

Menu table

You can probably program your MFC without the User's Guide. But to help you understand the menu selections and options that are found in the MFC programs, use the Menu table on page 3-4.



You can program your MFC by pressing **Menu** followed by the menu numbers.

For example to set Fax Resolution to Fine:

Press **Menu**, **2**, **2**, **2** and  or  to select Fine.

Press **Set**.

Memory Storage

If there is a power failure, you will not lose your menu settings because they are stored permanently. Temporary settings (such as Contrast, Overseas Mode, and so on) will be lost. You may also have to reset the date and time.

Navigation keys

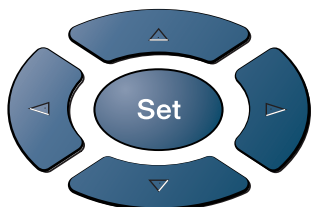

Clear/Back



Menu



Menu



* Access the menu



* Go to the next menu level

* Accept an option

Clear/Back



* Exit the menu by pressing repeatedly

* Go back to the previous menu level



* Scroll through the current menu level



* Go back to the previous menu level



* Go forward to the next menu level

Stop/Exit



* Exit the menu

You can access the menu mode by pressing **Menu**.

When you enter the menu, the LCD scrolls.

Press **1** for General Setup menu

—OR—

Press **2** for Fax menu

—OR—

Press **3** for Copy menu

—OR—

Press **4** for Printer menu

—OR—

Press **5** for Print Reports menu

—OR—



Press **6** for LAN menu

(Only if the optional LAN board (NC-9100h) is installed.)

—OR—

Press **0** for Initial Setup menu

—OR—

You can scroll more quickly through each menu level by pressing the arrow for the direction you want:  or .

Then set an option by pressing **Set** when that option appears on the LCD.



1.General Setup
2.Fax
3.Copy
4.Printer

Select ▲▼ & Set

4.Printer
5.Print Reports
6.LAN
0.Initial Setup

Select ▲▼ & Set

The LCD will then show the next menu level.

Press  or  to scroll to your next menu selection.

Press **Set**.

When you finish setting an option, the LCD shows *Accepted*.



Use  to scroll backward if you passed your choices or want to save keystrokes.

The current setting is always the option with “*”.

Press the Menu numbers.
(ex. Press 1, 1 for Mode Timer)

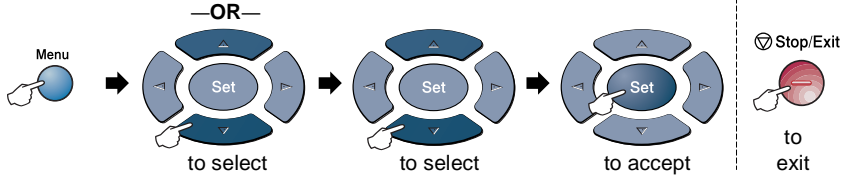

Main Menu	Submenu	Menu Selections	Options	Descriptions	Page
1.General Setup	1.Mode Timer	—	0 Sec 30 Sec 1 Min 2 Mins * 5 Mins Off	Sets how long the MFC will stay in Copy or Scan mode before returning to Fax mode.	4-5
	2.Paper Type	1.MP Tray (MFC-8820D)	Thin Plain * Thick Thicker Transparency	Sets the type of paper in the Multi-purpose tray.	4-6
		2.Tray #1 (For MFC-8420, this menu doesn't appear.)	Thin Plain * Thick Thicker Transparency	Sets the type of paper in paper tray #1.	4-6
		3.Tray #2 (option)	Thin Plain * Thick Thicker Transparency	Sets the type of paper in paper tray #2.	4-6
3.Paper Size	1.Tray #1 (This menu only appears if you have the optional tray #2.)	A4 * Letter Legal Executive A5 A6 B5 B6	Sets the size of paper in paper tray #1.	4-7	

 The factory settings are shown in Bold with *.

Press the Menu numbers.
(ex. Press 1, 1 for Mode Timer)

—OR—

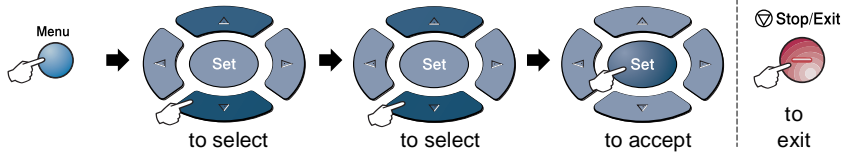

Main Menu	Submenu	Menu Selections	Options	Descriptions	Page
1.General Setup (Continued)	3.Paper Size (Continued)	2.Tray #2 (option)	A4 * Letter Legal Executive A5 B5 B6	Sets the size of paper in paper tray #2.	4-7
		4.Volume	1.Ring	High Med * Low Off	Adjusts the ring volume.
	2.Beeper		High Med * Low Off	Adjusts the volume level of the beeper.	4-8
	3.Speaker		High Med * Low Off	Adjusts the speaker volume.	4-9
	5.Clock Change	—	To Summer Time To Winter Time	Adjusts the MFC's clock by one hour for summer/winter time.	4-9
	6.Ecology	1.Toner Save	On Off *	Increases life of toner cartridge.	4-9
		2.Sleep Time	(00-99) 05Min *	Conserves power	4-10
		3.Power Save	On Off *	Power Save Mode	4-11



The factory settings are shown in Bold with *.

Press the Menu numbers.
(ex. Press 1, 1 for Mode Timer)

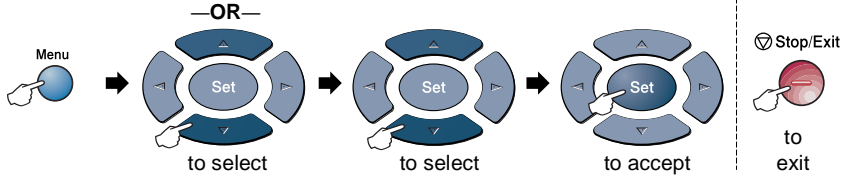

Main Menu	Submenu	Menu Selections	Options	Descriptions	Page
1.General Setup (Continued)	7. Tray Use: Copy (For MFC-8420, this menu doesn't appear.) (If you have optional tray #2, see page 3-17.)	—	Tray#1 Only MP Only Auto *	Selects the tray that will be used for copy.	4-12
	8. Tray Use: Fax (This setting only appears if you have the optional tray #2, see page 3-17.)	—		Selects the tray that will be used for fax.	4-13
	7.LCD Contrast (MFC-8420) 8.LCD Contrast (MFC-8820D) 9.LCD Contrast (With optional tray #2)	—	- 0000 ■ + - 0000 □ + - 00 ■ 00 + * - 0 ■ 000 + - ■ 0000 +		Adjusts the contrast of LCD.
2.Fax	1.Setup Receive (In Fax mode only)	1.Ring Delay	10 09 08 07 06 05 04 03 02 * (Example for Australia)	Sets the number of rings before the MFC answers in FAX or FAX/TEL mode.	5-2
		2.F/T Ring Time	70 40 30 * 20 (Example for Australia)		

The factory settings are shown in Bold with *.

Press the Menu numbers.
(ex. Press 1, 1 for Mode Timer)

—OR—

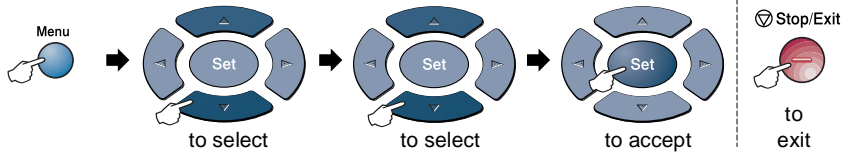

Main Menu	Submenu	Menu Selections	Options	Descriptions	Page
2.Fax (Continued)	1.Setup Receive (In Fax mode only) (Continued)	3.Fax Detect	On* Off	Receives fax messages without pressing the Start key.	5-4
		4.Remote Code	On (*51, #51) (*91, #91 for New Zealand) Off	You can answer all calls at an extension or external phone and use codes to turn the MFC on or off. You can personalize these codes.	5-9
		5.Auto Reduction	On* Off	Reduces the size of incoming faxes.	5-5
		6.Memory Receive	On* Off	Automatically stores any incoming faxes in its memory if it runs out of paper.	5-6
		7.Print Density	- □□□□ + - □□□□ + - □□□□ +* - □□□□ + - □□□□ +	Makes printouts darker or lighter.	5-7
		8.Polling RX	Standard* Secure Timer	Sets up your MFC to poll another fax machine.	5-10
		9.Duplex (MFC-8820D)	On off*	Receives faxes printed on both sides of the paper.	5-13



The factory settings are shown in Bold with *.

Press the Menu numbers.
(ex. Press 1, 1 for Mode Timer)

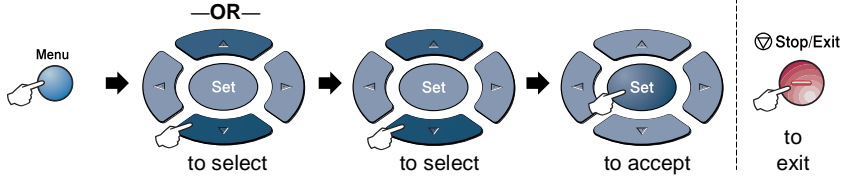

Main Menu	Submenu	Menu Selections	Options	Descriptions	Page
2.Fax (Continued)	2.Setup Send (In Fax mode only)	1.Contrast	Auto * Light Dark	Changes the lightness or darkness of faxes you send.	6-8
		2.Fax Resolution	Standard * Fine S.Fine Photo	Sets the default resolution for outgoing faxes.	6-9
		3.Delayed Fax	—	Set the time of day in 24 hour format that the delayed faxes will be sent.	6-20
		4.Batch TX	On Off *	Combines delayed faxes to the same fax number at the same time of day into one transmission.	6-21
		5.Real Time TX	Off * On Next Fax Only	You can send a fax without using the memory.	6-11
		6.Polled TX	Standard * Secure	Sets up the document on your MFC to be retrieved by another fax machine.	6-21
		7.Coverpg Setup	Next Fax Only On Off * Print Sample	Automatically send a Cover Page you have programmed.	6-14

 The factory settings are shown in Bold with *.

Press the Menu numbers.
(ex. Press 1, 1 for Mode Timer)

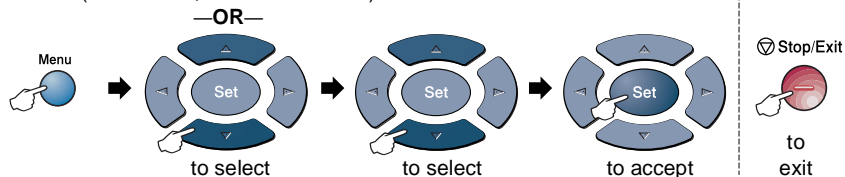

Main Menu	Submenu	Menu Selections	Options	Descriptions	Page
2.Fax (Continued)	2.Setup Send (In Fax mode only) (Continued)	8.Coverpage Note	—	You can set up your own comments for the fax Cover Page.	6-15
		9.Overseas Mode	On Off *	Adjusts for overseas transmissions, which can sometimes cause problems.	6-19
		0.Glass Fax Size	A4/Letter* Legal	Adjusts the scan area of the scanner glass to the size of the document.	6-5
	3.Set Quick-Dial	1.One-Touch Dial		Stores One-Touch Dial numbers, so you can dial by pressing one key (and Start).	7-1
		2.Speed-Dial	—	Stores Speed-Dial numbers, so you can dial by pressing only a few keys (and Start).	7-3
		3.Setup Groups	—	Sets up a Group number for Broadcasting.	7-5
	4.Report Setting	1.Transmission	On On+Image* Off Off+Image	Initial setup for Transmission Verification Report and Journal Report.	9-1
		2.Journal Period	Every 7 Days Every 2 Days Every 24 Hours Every 12 Hours Every 6 Hours Every 50 Faxes* Off		9-2



The factory settings are shown in Bold with *.

Press the Menu numbers.
(ex. Press 1, 1 for Mode Timer)

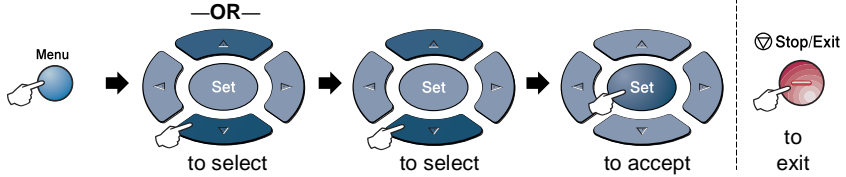

Main Menu	Submenu	Menu Selections	Options	Descriptions	Page
2.Fax (Continued)	5.Remote Fax Opt	1.Fax Forward	On Off *	Sets the MFC to forward fax messages.	8-1
		2.Fax Storage	On Off *	Stores incoming faxes in the memory so you can retrieve them while you are away from your MFC.	8-2
		3.Remote Access	--- *	You must set your own code for Remote Retrieval.	8-3
		4.Print Document	—	Prints incoming faxes stored in the memory.	5-7
	6.Remaining Jobs	—	—	Checks which jobs are in the memory or cancels a delayed fax or polling job.	6-12
	0.Miscellaneous	1.Mem Security	—	Prohibits most functions except receiving faxes into memory.	6-23
		2.Drum Life	—	You can check the percentage of drum life that remains available.	22-35
		3.Page Counter	Total Copy Print List/Fax	Lets you check number of total pages the MFC has printed so far.	22-35
		4.Distinctive (Except for New Zealand)	On Off *	Use with BT Call Sign.	5-14

 The factory settings are shown in Bold with * .

Press the Menu numbers.
(ex. Press 1, 1 for Mode Timer)

—OR—

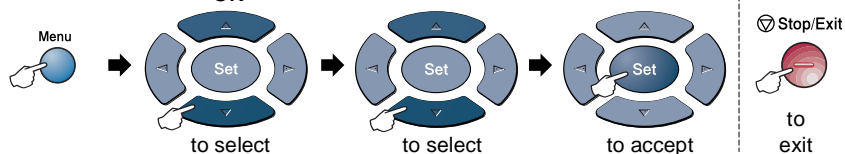

Main Menu	Submenu	Menu Selections	Options	Descriptions	Page
2.Fax (Continued)	0.Miscellaneous (Continued)	4.Faxability (Only for New Zealand)	On Off *	If you have FaxAbility from Telecom, you can use this function to store the ringing pattern of your fax number. And if you set in to ON ,you should use the registered number only.	5-18
		5.Caller ID	Display# Print Report	View or print a list of the last 30 Caller IDs stored in memory.	5-15
3.Copy	1.Quality		Text Photo Auto *	Selects the Copy resolution for your type of document.	10-20
	2.Contrast	—	- □□□■ + - □□□■ + - □□□■ + * - □□□□ + - ■□□□ +	Adjusts the contrast for copies.	10-20
4.Printer	1.Emulation	—	Auto * HP LaserJet BR-Script 3	Selects the Emulation mode.	11-18
	2.Print Options	1.Internal Font	—	Prints a list of the MFC's internal fonts or current printer settings.	11-19
		2.Configuration	—		11-19
	3.Reset Printer	—	—	Returns the MFC to the original factory default settings.	11-19
5.Print Reports	1.Help List	—	—	You can print these lists and reports.	9-3
	2.Quick-Dial	—	—		
	3.Journal	—	—		
	4.XMIT Verify	—	—		
	5.System Setup	—	—		
	6.Order Form	—	—		



The factory settings are shown in Bold with *.

Press the Menu numbers.
(ex. Press 1, 1 for Mode Timer)

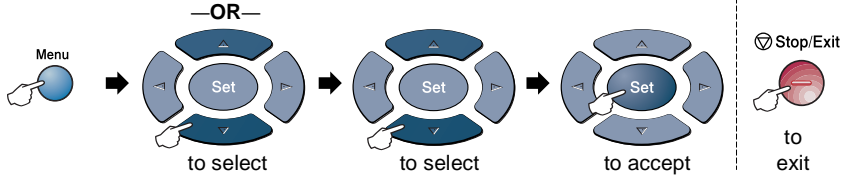

Main Menu	Submenu	Menu Selections	Options	Descriptions	Page
0.Initial Setup	1.Receive Mode	—	Fax Only * Fax/Tel External TAD Manual	You can choose the receive mode that best suits your needs.	5-2
	2.Date/Time	—	—	Puts the date and time on the LCD and in headings of faxes you send.	4-1
	3.Station ID	—	Fax Tel Name	Program your name, fax and telephone number to appear on each page you fax.	4-2
	4.Tone/Pulse (Except for New Zealand)	—	Tone * Pulse	Selects the dialing mode.	4-14



■ The factory settings are shown in Bold with *.

Press the Menu numbers.
(ex. Press 1, 1 for Mode Timer)

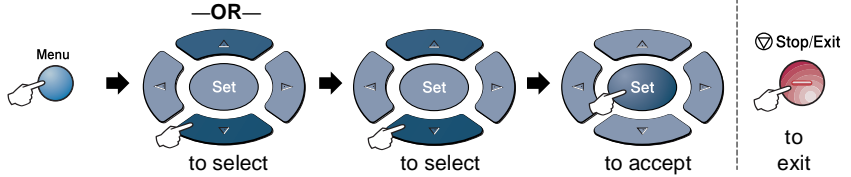

If you installed optional LAN board (NC-9100h), the LCD shows the following LAN menu.

Main Menu	Submenu	Menu Selections	Options	Descriptions	Page
6.LAN (option)	1.Setup TCP/IP	1. BOOT Method	Auto * Static RARP BOOTP DHCP	You can choose the BOOT method that best suits you needs.	See Network User's Guide on the CD-ROM
		2. IP Address	[000-255]. [000-255]. [000-255]. [000-255]	Enter the IP address.	
		3. Subnet Mask	[000-255]. [000-255]. [000-255]. [000-255]	Enter the Subnet mask.	
		4. Gateway	[000-255]. [000-255]. [000-255]. [000-255]	Enter the Gateway address.	
		5. Host Name	BRN_XXXXXX	Enter the Host name.	
		6. WINS Config	Auto * Static	You can choose the WINS configuration mode.	
		7. WINS Server	Primary Secondary	Specifies the IP address of the primary or secondary server.	

The factory settings are shown in Bold with *.

Press the Menu numbers.
(ex. Press 1, 1 for Mode Timer)

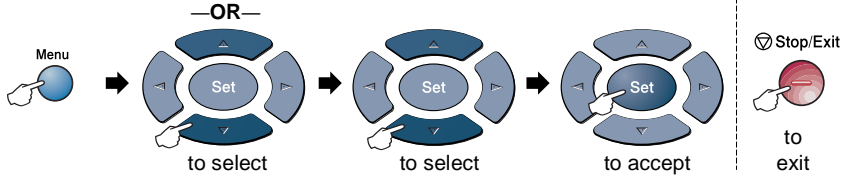

Main Menu	Submenu	Menu Selections	Options	Descriptions	Page
6.LAN (option) (Continued)	1.Setup TCP/IP (Continued)	8.DNS Server	Primary Secondary	Specifies the IP address of the primary or secondary server.	See Network User's Guide on the CD-ROM
		9.APIPA	On * Off	Automatically allocates the IP address from the link-local address range.	
	2.Setup Internet	1.Mail Address	(60 characters)	Enter the mail address.	
		2.SMTP Server	[000-255].[000-255].[000-255]	Enter the SMTP server address.	
		3.POP3 Server	[000-255].[000-255].[000-255]	Enter the POP3 server address.	
		4.Mailbox Name	(up to 20 characters)	Enter the mail box name.	
		5.Mailbox Pwd	Password:*****	Enter the password to login to the POP3 server.	
	3.Setup Mail RX	1.Auto Polling	On * Off	Automatically checks the POP3 server for new messages.	
		2.Poll Frequency	10Min	Sets the interval for checking for new messages on the POP3 server.	

 The factory settings are shown in Bold with *.

Press the Menu numbers.
(ex. Press 1, 1 for Mode Timer)

—OR—

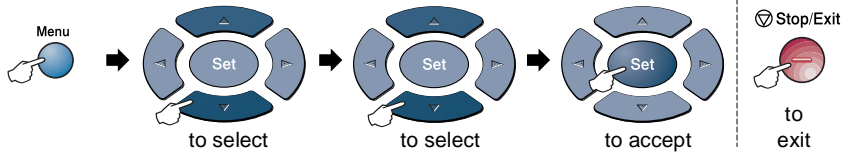

Main Menu	Submenu	Menu Selections	Options	Descriptions	Page
6.LAN (option) (Continued)	3.Setup Mail RX (Continued)	3.Header	All Subject+From+To None *	Selects the contents of the mail header to be printed.	See Network User's Guide on the CD-ROM
		4.Del Error Mail	On * Off	Deletes error mails automatically.	
		5.Notification	On MDN Off *	Sends notification messages.	
	4.Setup Mail TX	1.Sender Subject	—	Displays the subject that is attached to the Internet Fax data.	
		2.Size Limit	On Off *	Limits the size of E-mail documents.	
		3.Notification	On Off *	Sends notification messages.	
	5.Setup Relay	1.Rly Broadcast	On Off *	Relays a document to another fax machine.	
		2.Relay Domain	RelayXX:	Registers the Domain name.	
		3.Relay Report	On off *	Prints the Relay Broadcast Report.	



The factory settings are shown in Bold with *.

Press the Menu numbers.
(ex. Press 1, 1 for Mode Timer)

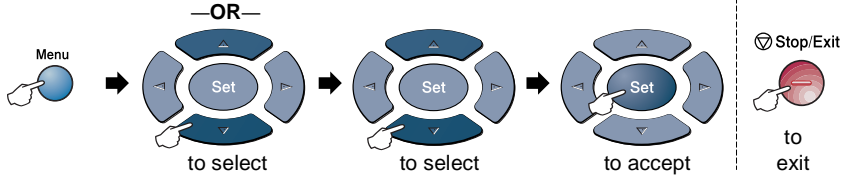

Main Menu	Submenu	Menu Selections	Options	Descriptions	Page
6.LAN (option) (Continued)	6.Setup Misc.	1.Netware	On * Off	Select On to use the MFC on a Netware network.	See Network User's Guide on the CD-ROM
		2.Net Frame	Auto * 8023 ENET 8022 SNAP	Lets you specify the frame type.	
		3.AppleTalk	On * Off	Select on to use the MFC on a Macintosh network.	
		4.DLC/LLC	On * Off	Select On to use the MFC on a DLC/LLC network.	
		5.Net BIOS/IP	On * Off	Select on to use the MFC on a Net BIOS/IP network.	
		6.Ethernet	Auto * 100B-FD 100B-HD 10B-FD 10B-HD	Selects Ethernet link mode.	
		7.Time Zone	GMT-XX:XX	Sets the time zone for your country.	
	7.Scan to E-Mail	—	PDF * JPEG	Selects the file type.	

The factory settings are shown in Bold with *.



If you have the optional paper tray, the LCD displays these options. (**Menu, 1, 7/Menu, 1, 8**)

(For MFC-8420 with the optional paper tray #2)

Main Menu	Submenu	Menu Selections	Options	Descriptions	Page
1.General Setup	7.Tray Use: Copy	—	Tray#1 Only Tray#2 Only Auto*	Select the tray that will be used for copying.	4-12
	8.Tray Use: Fax	—	Tray#1 Only Tray#2 Only Auto*	Select the tray that will be used for faxing.	4-13

(For MFC-8820D with the optional paper tray #2)

Main Menu	Submenu	Menu Selections	Options	Descriptions	Page
1.General Setup	7.Tray Use: Copy	—	Tray#1 Only Tray#2 Only MP Only Auto*	Select the tray that will be used for copying.	4-12
	8.Tray Use: Fax	—	Tray#1 Only Tray#2 Only Auto*	Select the tray that will be used for faxing.	4-13



The factory settings are shown in Bold with *.

4 Getting started

Initial Setup

Setting the Date and Time

Your MFC displays the date and time and if you set up the Station ID it prints on every fax you send. If there is a power failure, you may have to reset the date and time. All other settings will not be affected.

- 1 Press **Menu**, **0**, **2**.
- 2 Enter the last two digits of the year.
Press **Set**.

02.Date/Time
Year:20XX
Enter & Set Key

- 3 Enter two digits for the month.
Press **Set**.

(For example, enter 09 for September, or 10 for October.)

- 4 Enter two digits for the day.
Press **Set**.

(For example, enter 06 for 6th.)

- 5 Enter the time in 24-Hour format.
Press **Set**.

(For example, enter 15:25 for 3:25 P.M.)

- 6 Press **Stop/Exit**.

The LCD now shows the date and time whenever the MFC is in Standby mode.

Setting the Station ID

You should store your name or company name and fax number and telephone number to be printed on all fax pages that you send.

It is important that you enter the fax and telephone numbers in the internationally standardised format, i.e. in accordance with the following strict sequence:

- The “+” (plus) character (by pressing * key)
- Your Country Code (e.g. “61” for Australia, “64” for New Zealand)
- Your local area code minus any leading “0”
- A space
- Your number on the local exchange, using spaces to aid readability as appropriate.

As an example, if the machine is installed in the United Kingdom and the same line is to be used for both fax and voice calls, and your national telephone number is 0161-444 5555, then you must set the fax and telephone number parts of your station ID as: +44 161-444 5555.

- 1 Press **Menu**, **0**, **3**.
- 2 Enter your fax number (up to 20 digits).

Press **Set**.

- 3 Enter your telephone number (up to 20 digits).

Press **Set**.

(If your telephone number and fax number are the same, enter the same number again).



The telephone number you enter is only used for Cover Page features. (See *Composing the electronic Cover Page* on page 6-14.)



You cannot enter a hyphen.

03.Station ID
Fax:
Enter & Set Key

4 Use the dial pad to enter your name (up to 20 characters).
Press **Set**.

5 Press **Stop/Exit**.

The LCD will show the date and time.



If the Station ID has already been programmed, the LCD will ask you to press **1** to make a change or **2** to exit without changing.

Entering text

When you are setting certain functions, such as the Station ID, you may need to type text into the MFC. Most number keys have three or four letters printed above them. The keys for **0**, **#** and ***** do not have printed letters because they are used for special characters.

By pressing the appropriate number key repeatedly, you can access the character you want.

Press Key	one time	two times	three times	four times
2	A	B	C	2
3	D	E	F	3
4	G	H	I	4
5	J	K	L	5
6	M	N	O	6
7	P	Q	R	S
8	T	U	V	8
9	W	X	Y	Z

Inserting spaces

To enter a space, press  once between numbers and twice between characters.

Making corrections

If you entered a letter incorrectly and want to change it, press  to move the cursor under the incorrect character. Then press **Clear/Back**. The letter above the cursor will be deleted. Re-enter the correct character.

Repeating letters

If you need to enter a character that is on the same key as the previous character, press  to move the cursor to the right before you press the key again.

Special characters and symbols

Press *****, **#** or **0**, and then press  or  to move the cursor under the special character or symbol you want. Then press **Set** to select it.



Press *	for	(space) ! " # \$ % & ' () * + , - . / €
Press #	for	: ; < = > ? @ [] ^ _
Press 0	for	Ä Ë Ö Ü À Ç È É 0

General Setup

Setting the Mode Timer

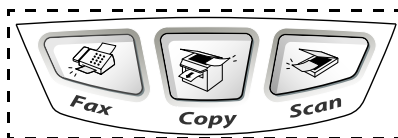
The MFC has three temporary mode keys on the control panel: Fax, Copy and Scan. You can change the number of seconds or minutes the MFC takes after the last Copy or Scan operation before it returns to Fax mode. If you select *Off*, the MFC stays in the mode you used last.



- 1 Press **Menu, 1, 1**.
- 2 Press  or  to select 0 Sec, 30 Secs, 1 Min, 2 Mins, 5 Mins or Off.
- 3 Press **Set**.

11.Mode Timer
▲ 0 Sec
30 Secs
▼ 1 Min
Select ▲▼ & Set

Setting the Paper Type



To get the best print quality, set the MFC for the type of paper you are using.

For MFC-8420

1 Press **Menu, 1, 2**.

—OR—

If you have the optional paper tray, press **Menu, 1, 2, 1** to set the paper type for Tray #1 or **Menu, 1, 2, 2** to set the paper type for Tray #2.

2 Press  or  to select Thin, Plain, Thick, Thicker or Transparency.

3 Press **Set**.

4 Press **Stop/Exit**.

12.Paper Type
▲ Plain
Thick
▼ Thicker
Select ▲▼ & Set

12.Paper Type
1.Tray #1
2.Tray #2
Select ▲▼ & Set

For MFC-8820D



1 Press **Menu, 1, 2, 1** to set the paper type for MP Tray.

—OR—

Press **Menu, 1, 2, 2** to set the paper type for Tray #1.

—OR—

If you have the optional paper tray, press **Menu, 1, 2, 3** to set the paper type for Tray #2.

2 Press  or  to select Thin, Plain, Thick, Thicker or Transparency.

3 Press **Set**.

4 Press **Stop/Exit**.

12.Paper Type
1.MP Tray
2.Tray #1
3.Tray #2
Select ▲▼ & Set



12.Paper Type
1.MP Tray
▲ Plain
▼ Thick
Select ▲▼ & Set



You can select Transparency for Tray #1 and Tray #2 only when A4, Letter or Legal is selected in **Menu, 1, 3**.



Setting the Paper Size

You can use eight sizes of paper for printing copies: A4, letter, legal, executive, A5, A6, B5 and B6 and three sizes of paper for printing faxes: A4, letter and legal. When you change the size of paper in the MFC, you will need to change the setting for Paper Size at the same time so your MFC can fit an incoming fax or reduced copy on the page.

- 1 Press **Menu, 1, 3**.
- 2 Press  or  to select A4, Letter, Legal, Executive, A5, A6, B5 or B6.
Press **Set**.
- 3 Press **Stop/Exit**.

13.Paper Size
▲ A4
Letter
▼ Legal
Select ▲▼ & Set

With optional paper tray

- 1 Press **Menu, 1, 3, 1** to set the paper size for Tray #1.
—OR—
Press **Menu, 1, 3, 2** to set the paper size for Tray #2.
- 2 Press  or  to select A4, Letter, Legal, Executive, A5, A6, B5 and B6.
Press **Set**.
- 3 Press **Stop/Exit**.



13.Paper Size
1.Tray #1
2.Tray #2
Select ▲▼ & Set



- If you are using the optional paper tray, paper size A6 is not available.
- If you select Transparency in **Menu, 1, 2**, you can only select A4, Letter or Legal.

Setting the Ring Volume



You can adjust the ring volume when your MFC is idle (not being used). You can turn the ring *Off* or you can select the ring volume level.

- 1 Press **Menu, 1, 4, 1.**
- 2 Press  or  to select (Low, Med, High or Off).
Press **Set.**

14.Volume
1.Ring
▲ Med
▼ High
Select ▲▼ & Set



- 3 Press **Stop/Exit.**

—OR—

In Fax mode, press  or  to adjust the volume level. Every time you press these keys, the MFC will ring so you can hear the active setting as the LCD shows it. The volume changes with each key press. The new setting will stay until you change it again.

Setting the Beeper Volume

You can change the beeper volume. The default (factory) setting is *Med*. When the beeper is on, the MFC beeps every time you press a key or make a mistake and after a fax is sent or received.



- 1 Press **Menu, 1, 4, 2.**
- 2 Press  or  to select your option.
(Low, Med, High or Off)
Press **Set.**

14.Volume
2.Beeper
▲ Med
▼ High
Select ▲▼ & Set

- 3 Press **Stop/Exit.**

Setting the Speaker Volume



You can adjust the MFC's one-way speaker volume.

- 1 Press **Menu**, **1**, **4**, **3**.
- 2 Press  or  to select (Low, Med, High or Off).
Press **Set**.
- 3 Press **Stop/Exit**.

14. Volume
3. Speaker
▲ Med
▼ High
Select ▲▼ & Set

Setting the Clock Change



You can easily let the machine's clock gain or lose one hour by using this feature.

- 1 Press **Menu**, **1**, **5**.
- 2 Press  or  to select To Summer Time (or To Winter Time).
- 3 Press **Set**.
- 4 Press **1** to change to Winter Time or Summer Time.
—OR—
Press **2** to exit without changing.

15. Clock Change
▲ To Summer Time
▼ To Winter Time
Select ▲▼ & Set

Toner Save

You can conserve toner using this feature. When you set Toner Save to On, print appears somewhat lighter. The default setting is Off.

- 1 Press **Menu**, **1**, **6**, **1**.
- 2 Press  or  to select On (or Off).
- 3 Press **Set**.
- 4 Press **Stop/Exit**.

16. Ecology
1. Toner Save
▲ On
▼ Off
Select ▲▼ & Set

Sleep Time



Setting the Sleep Time reduces power consumption by turning off the fuser inside the MFC, while it is idle. You can choose how long the MFC is idle (from 00 to 99 minutes) before it goes into sleep mode. The timer is automatically reset when the MFC receives a Fax or PC data, or makes a copy. The factory setting is 05 minutes. While the MFC is in sleep mode, you will see **Sleep** on the LCD. If you try to print or copy in sleep mode, there will be a short delay while the fuser warms up to working temperature.

- 1 Press **Menu**, **1**, **6**, **2**.
- 2 Use the dial pad to enter the length of time the MFC is idle before it goes into sleep mode (00 to 99).
- 3 Press **Set**.
- 4 Press **Stop/Exit**.



- If you want to turn sleep mode off, press **Secure** and **Job Cancel** simultaneously in Step 2.
- If the MFC is in Sleep Mode when you change the Sleep Time, the new setting will take effect the next time the MFC copies, prints or is restarted.

Turning off the Scanner Lamp

The scanner lamp stays on for 16 hours before automatically switching off to preserve the life of the lamp. You can turn off the scanner lamp manually if you wish by pressing the  and  keys simultaneously. The scanner lamp will remain turned off until the next time you use the scanning feature.

Turning off the scanner lamp will also reduce the power consumption.





- Please note that turning the lamp off regularly will reduce the lamp's life. Some people prefer to turn the lamp off as they leave the office, or late at night at home. This is not necessary for normal day to day use.
- If the MFC is in Sleep Mode when you change the Sleep Time, the new setting will take effect the next time the MFC copies, prints or is restarted.

Power Save

Setting Power Save mode reduces power consumption. If Power Save Mode is switched On, when the MFC is idle and the scanner lamp is turned off, it drops into power save mode in approx. 10 minutes automatically. In the Power Save Mode, you cannot use the fax detect function or remote activation.

The MFC will not display the date and time in this condition.

- 1 Press **Menu, 1, 6, 3.**
- 2 Press  or  to select On (or Off).
- 3 Press **Set** when the screen displays your selection.
- 4 Press **Stop/Exit.**

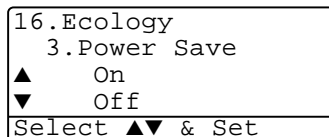



Setting the Tray Use for Copy mode



If your MFC is a MFC-8420 without the optional tray #2, you can skip this setting.

MFC-8420



The default setting of **Auto** allows *¹your MFC to choose the optional Tray #2 when paper is out in Tray #1 or *²when the size of the document will fit best on the paper in Tray #2.

- 1 Press **Menu, 1, 7**.
- 2 Press  or  to select Tray#1 Only, Tray#2 Only, or Auto.
- 3 Press **Set**.
- 4 Press **Stop/Exit**.



17.Tray Use: Copy
▲ Tray#1 Only
Tray#2 Only
▼ Auto
Select ▲▼ & Set

MFC-8820D

The default setting of **Auto** allows *¹your MFC to choose the optional Tray #2 or the MP tray when paper is out in Tray #1 and *²when the size of the document will fit best on the paper in Tray #2.

- 1 Press **Menu, 1, 7**.
- 2 Press  or  to select Tray#1 Only, MP Only, or Auto.

—OR—

If you have the optional paper tray. Press  or  to select Tray#1 Only, Tray#2 Only, MP Only, or Auto.

- 3 Press **Set**.
- 4 Press **Stop/Exit**.

17.Tray Use: Copy
▲ Tray#1 Only
MP Only
▼ Auto
Select ▲▼ & Set

17.Tray Use: Copy
▲ Tray#1 Only
Tray#2 Only
MP Only
Select ▲▼ & Set





*1 Copies will automatically be printed from Tray #2 only if the Paper Size setting for Tray #2 is the same as Tray #1.

*2 When using the ADF, copies will automatically be printed from Tray #2 if the Paper Size setting for Tray #2 is different than Tray #1 and this paper size is more suitable for the scanned original.

Setting the Tray Use for Fax mode

If your MFC doesn't have the optional tray #2, you can skip this setting. The default setting of `Auto` allows your MFC to choose the optional Tray #2 if Tray #1 is out of paper or if incoming faxes will fit best on the paper in Tray #2.

- 1 Press **Menu, 1, 8**.
- 2 Press  or  to select `Tray#1 Only`, `Tray#2 Only`, or `Auto`.
- 3 Press **Set**.
- 4 Press **Stop/Exit**.

18.Tray Use: Fax
▲ Tray#1 Only
Tray#2 Only
▼ Auto
Select ▲▼ & Set



 If Auto Reduction is turned on, incoming faxes will be printed from the tray that is set for Auto Reduction. (See *Printing a reduced incoming fax (Auto Reduction)* on page 5-5.)

Setting the LCD Contrast

You can change the contrast to help the LCD look lighter or darker.

- 1 (MFC-8420) Press **Menu, 1, 7**.
(MFC-8820D) Press **Menu, 1, 8**.
—OR—

If you have the optional tray #2, press **Menu, 1, 9**.



- 2 Press  to increase the contrast.
—OR—
Press  to decrease the contrast.
Press **Set**.
- 3 Press **Stop/Exit**.

19.LCD Contrast
-□□■□□+
Select ◀▶ & Set

Initial Setup depending on Your Country

Setting Tone or Pulse dialing mode (Except for New Zealand)

Your machine comes set for Tone dialing service (multi-frequency). If you have Pulse dialing service (rotary), you need to change the dialing mode.

- 1 Press **Menu, 0, 4**.
- 2 Press  or  to select Pulse (Or Tone).
Press **Set**.
- 3 Press **Stop/Exit**.

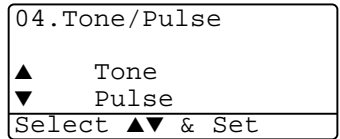

5 Setup Receive

Basic receiving operations

Choosing the Receive Mode

There are four different Receive Modes for your MFC. You can choose the mode that best suits your needs.



LCD	How it works	When to use it
Fax Only* (automatic receive)	The MFC automatically answers every call as a fax.	For dedicated fax lines.
Fax/Tel (fax and telephone) (with an external or extension telephone)	The MFC controls the line and automatically answers every call. If the call is a fax it will receive the fax. If the call is not a fax it will ring (pseudo/double ring) for you to pick up the call.	Use this mode if you expect to receive lots of fax messages and few telephone calls. You cannot have an answering machine on the same line, even if it is on a separate wall socket/phone socket on the same line. You cannot use the telephone company's Voice Mail in this mode.
External TAD (with an external answering machine)	The external answering machine (TAD) automatically answers every call. Voice messages are stored on the external TAD. Fax messages are printed.	Use this mode if you have an external answering machine on your phone line. The TAD setting works only with an external answering machine. Ring Delay and F/T Ring Time do not work in this setting.
Manual (manual receive) (with an external or extension telephone or with Distinctive Ring)	You control the phone line and must answer every call yourself.	Use this mode when you are using a computer modem on the same line or if you don't receive many fax messages or with Distinctive Ring. If you hear fax tones, wait until the MFC takes over the call, then hang up. (See <i>Fax Detect</i> on page 5-4.)

* In Fax/Tel mode you must set the Ring Delay and F/T Ring Time.



The MP tray is not available with Fax Receive.

To select or change your Receive Mode

- 1 Press **Menu, 0, 1.**
- 2 Press  or  to select Fax Only, Fax/Tel, External TAD or Manual.

01.Receive Mode
▲ Fax Only
Fax/Tel
▼ External TAD
Select ▲▼ & Set

Press **Set.**

- 3 Press **Stop/Exit.**



 If you are changing the Receive Mode while in another operation, the LCD will return to that operation.

01/03/2003 18:15
External TAD
Dial & Start

Fax Only
Fax/Tel
External TAD
Manual

Setting the Ring Delay

The Ring Delay sets the number of times the MFC rings before it answers in Fax only or Fax/Tel mode. If you have extension phones on the same line as the MFC or subscribe to the telephone company's Distinctive Ring service, keep the Ring Delay setting of 4. (See *Fax Detect* on page 5-4 and *Operation from extension telephones* on page 5-8.)

- 1 If it is not illuminated in green, press  (**Fax**).
- 2 Press **Menu, 2, 1, 1.**
- 3 Press  or  to select how many times the line rings before the MFC answers (02-10 for Australia, 01-10 for New Zealand, 00-10 for some countries).

21.Setup Receive
1.Ring Delay
▲ 03
▼ 04
Select ▲▼ & Set

Press **Set.**

(If you select 00, the line won't ring at all.)

- 4 Press **Stop/Exit.**



Setting the F/T Ring Time (Fax/Tel mode only)

If you set the Receive Mode to Fax/Tel, you'll need to decide how long the MFC will signal you with its special pseudo/double-ring when you have a *voice* call. (If it's a fax call, the MFC prints the fax.)

This pseudo/double-ring happens after the initial ringing from the phone company. Only the MFC rings (for 20, 30, 40 or 70 seconds, for 20, 30, 40 or 55 seconds for New Zealand) and no other phones on the same line will ring with the special pseudo/double-ring. However, you can still answer the call on any extension phone (in a separate wall socket/phone socket) on the same line as the MFC. (See *Operation from extension telephones* on page 5-8.)

1 If it is not illuminated in green, press  **(Fax)**.

2 Press **Menu, 2, 1, 2**.

3 Press  or  to select how long the MFC will ring to alert you that you have a voice call.

21.Setup Receive
2.F/T Ring Time
▲ 20
▼ 30
Select ▲▼ & Set

Press **Set**.

4 Press **Stop/Exit**.

 Even if the caller hangs up during the pseudo/double-ringing, the MFC will continue to ring for the set time.



Fax Detect

When you use this feature, you don't have to press **Start** or the Remote Activation Code ***51** (***91** for NewZealand) when you answer a fax call. Selecting **On** allows the MFC to receive fax calls automatically, even if you lift the handset of an extension or external phone. When you see **Receiving** on the LCD or when you hear 'chirps' through the handset of an extension phone connected to another wall socket/phone socket, just replace the handset and your MFC will do the rest. Selecting **Off** means you'll have to activate the MFC yourself by lifting the handset of an external or extension phone, and then press **Start** on the MFC—**OR**—by pressing ***51** (***91** for NewZealand) if you are not at your MFC. (See *Operation from extension telephones* on page 5-8.)



If this feature is set to **On**, but your MFC doesn't connect a fax call when you lift a extension or external phone handset, press the Remote Activation Code ***51** (***91** for NewZealand).

If you send faxes from a computer on the same phone line and the MFC intercepts them, set **Fax Detect** to **Off**.

- 1 If it is not illuminated in green, press  (**Fax**).
- 2 Press **Menu, 2, 1, 3**.
- 3 Use  or  to select **On** (or **Off**).
Press **Set**.
- 4 Press **Stop/Exit**.



21.Setup Receive
3.Fax Detect
▲ On
▼ Off
Select ▲▼ & Set

Printing a reduced incoming fax (Auto Reduction)

If you choose **On**, the MFC automatically reduces an incoming fax to fit on one page of letter, legal or A4 size paper, regardless of the paper size of the document. The MFC calculates the reduction ratio by using the page size of the document and your Paper Size setting (**Menu, 1, 3**).

1 If it is not illuminated in green, press  (**Fax**).

2 Press **Menu, 2, 1, 5**.

3 If you have the optional paper tray #2, press  or  to select Tray #1 or Tray #2.

Press **Set**.

4 Use  or  to select **On** (or **Off**).

Press **Set**.

5 Press **Stop/Exit**.

 If you receive faxes that are split onto two pages, turn on this setting.

21.Setup Receive
5.Auto Reduction
▲ On
▼ Off
Select ▲▼ & Set

Reception into memory



As soon as the paper tray becomes empty during fax reception, the screen will display *Check Paper*; please put some paper in the paper tray. (See Quick Setup Guide.)

If the Memory Receive switch is ON at this time...

The current fax reception will continue, with the remaining pages being stored in memory, if it is available. Subsequent incoming faxes will also be stored into memory until the memory is full, following with no further incoming fax calls will be automatically answered. To print all data, put paper in the paper tray.

If the Memory Receive switch is OFF at this time...

The current fax reception will continue, with the remaining page(s) being stored in memory, subject to available memory. Subsequent incoming fax calls will not be automatically answered until fresh paper is put in the paper tray. To print the last fax received, load paper in the paper tray.

- 1 If it is not illuminated in green, press  (**Fax**).
- 2 Press **Menu, 2, 1, 6**.
- 3 Use  or  to select On (or Off).
Press **Set**.
- 4 Press **Stop/Exit**.

21.Setup Receive
6.Memory Receive
▲ On
▼ Off
Select ▲▼ & Set

Printing a fax from the memory

If you set Fax Storage to ON for Remote Retrieval, you can still print a fax from the memory when you are at your MFC. (See *Setting Fax Storage* on page 8-2.)



- 1 Press **Menu**, **2**, **5**, **4**.
- 2 Press **Start**.
- 3 After printing has finished, press **Stop/Exit**.

25.Remote Fax Opt 4.Print Document

Press Start

Setting the Print Density

You can adjust print density, making your printed pages darker or lighter.

- 1 If it is not illuminated in green, press  (**Fax**).
- 2 Press **Menu**, **2**, **1**, **7**.
- 3 Press  to make the print darker.
—OR—
Press  to make the print lighter.
Press **Set**.
- 4 Press **Stop/Exit**.

21.Setup Receive 7.Print Density

-□□■□□+

Select ◀▶ & Set

Advanced receiving operations

Operation from extension telephones

If you answer a fax call on an extension telephone, or an external telephone into the correct socket on the machine, you can make your MFC take the call by using the Remote Activation Code. When you press the Remote Activation Code ***51** (***91** for NewZealand), the MFC starts to receive a fax.

(See *Fax Detect* on page 5-4.)

If the MFC answers a voice call and pseudo/double-rings for you to take over, use the Deactivation Code **#51** (**#91** for NewZealand) to take the call at an extension phone. (See *Setting the F/T Ring Time (Fax/Tel mode only)* on page 5-3.)

If you answer a call and no one is on the line, you should assume that you're receiving a manual fax.

- At an extension phone (on a separate telephone wall socket/phone socket), press ***51** (***91** for NewZealand), wait for fax-receiving tones (chirps), and then hang up.
- At an external phone (connected to the MFC's EXT socket), press ***51** (***91** for NewZealand) and wait for the phone to be disconnected before you hang up (the LCD shows *Receiving*).

Your caller will have to press **Start** to send the fax.

For FAX/TEL mode only

When the MFC is in FAX/TEL mode, it will use the F/T Ring Time (pseudo/double-ringing) to alert you to pick up a voice call.

Lift the external telephone's handset, and then press **Hook** to answer.

If you're at an extension phone, you'll need to lift the handset during the F/T Ring Time and then press **#51** (**#91** for NewZealand) between the double rings. If no one is on the line, or if someone wants to send you a fax, send the call back to the MFC by pressing ***51** (***91** for NewZealand).

Using a cordless external handset

If your cordless telephone is connected to the correct socket on the MFC and you typically carry the cordless handset elsewhere, it is easier to answer calls during the Ring Delay. If you let the MFC answer first, you will have to go to the MFC so you can press **Hook** to transfer the call to the cordless handset.

Changing the remote codes

Remote Codes might not work with some telephone systems. The preset Remote Activation Code is * **5 1** (* **9 1** for New Zealand). The preset Deactivation Code is # **5 1** (# **9 1** for New Zealand).

 If you are always disconnected when accessing your external TAD remotely, try changing the Remote Activation Code and Deactivation Code to another three-digit code (such as **###** and **999**).

1 If it is not illuminated in green, press  (**Fax**).

2 Press **Menu, 2, 1, 4**.

3 Press  or  to select On (or Off).

Press **Set**.

21.Setup Receive
4.Remote Code
▲ On
▼ Off
Select ▲▼ & Set

4 If you want to, enter a new Remote Activation Code.

Press **Set**.

5 If you want to, enter a new Deactivation Code.

Press **Set**.

6 Press **Stop/Exit**.

Polling

Polling is the process of retrieving faxes from another fax machine. You can use your machine to 'poll' other machines, or you can have someone poll your machine.

Everyone who is involved in Polling needs to set up their fax machines for Polling. When someone polls your machine to receive a fax, they pay for the call. If you poll someone's fax machine to receive a fax, you pay for the call.





Some fax machines do not respond to the Polling feature.

Secure Polling

Secure Polling is a way to keep your documents and others from falling into the wrong hands while the machine is set up for polling. You can use Secure Polling only with another Brother fax machine. Anyone who polls to receive a fax must enter the polling secure code.

Setup for Polling Receive (Standard)

Polling Receive is when you call another fax machine to receive a fax from it.



- 1 If it is not illuminated in green, press  (**Fax**).
- 2 Press **Menu, 2, 1, 8**.
- 3 Press  or  to select **Standard**.
Press **Set**.
- 4 Enter the fax number you are polling. Press **Start**.

Setup for Polling Receive with Secure Code

You need to make sure you are using the same secure code as the other party.

1 If it is not illuminated in green, press  (**Fax**).

2 Press **Menu, 2, 1, 8**.

3 Press  or  to select **Secure**.

Press **Set**.

21.Setup Receive
8.Polling RX
▲ Standard
▼ Secure
Select ▲▼ & Set

4 Enter a four-digit secure code.

This is the same as the security code of the fax machine you are polling.

5 Press **Set**.

6 Enter the fax number you are polling.



7 Press **Start**.

Setup Delayed Polling Receive

You can set the MFC to begin Polling Receive at a later time.

1 If it is not illuminated in green, press  (**Fax**).

2 Press **Menu, 2, 1, 8**.

3 Press  or  to select **Timer**.

Press **Set**.

21.Setup Receive
8.Polling RX
▲ Standard
▼ Secure
Select ▲▼ & Set

4 The screen prompts you to enter the time you want to begin polling.

5 Enter the time (in 24-hour format) you want to begin polling.
For example, enter 21:45 for 9:45 PM.

6 Press **Set**.

7 The screen prompts you to enter the fax number you are polling and then to press **Start**.



The MFC makes the polling call at the time you entered.



You can set up only one Delayed Polling.

Sequential Polling

The MFC can request documents from several fax units in a single operation. You just specify several destinations in Step 4. Afterward, a Sequential Polling Report will be printed.

- 1 If it is not illuminated in green, press  (**Fax**).
- 2 Press **Menu, 2, 1, 8**.
- 3 Press  or  to choose *Standard*, *Secure* or *Timer*. Press **Set** when the screen displays the setting you want.
- 4 If you selected *Standard*, go to Step 5.
 - If you selected *Secure*, enter a four-digit number and press **Set**, and then go to Step 5.
 - If you selected *Timer*, enter the time (in 24-hour format) you want to begin polling and press **Set**, and then go to Step 5.
- 5 Specify the destination fax machines (up to 390), which you wish to poll by using *Speed-Dial*, *Search*, a *Group* (see *Setting up Groups for Broadcasting* on page 7-5) or the dial pad. You must press **Set** between each location.
- 6 Press **Start**.

The MFC polls each number or group in turn for a document.

 Press **Stop/Exit** while the MFC is dialing to cancel the polling process.

To cancel all sequential polling receive jobs, press **Menu, 2, 6**. (See *Canceling a scheduled job* on page 6-13.)

Setting Duplex printing for Fax mode (For MFC-8820D)

If you set Duplex to **On** for fax receive, the MFC prints received faxes on both sides of the paper.

You can use three sizes of paper for this function - letter, legal and A4.

1 If it is not illuminated in green, press  (**Fax**).

2 Press **Menu, 2, 1, 9**.

3 Press  or  to select **On** (or **Off**).

Press **Set**.

4 Press **Stop/Exit**.

 While the Duplex printing for fax is working, auto reduction is also **On** temporarily.

21.Setup Receive
9.Duplex
▲ On
▼ Off
Select ▲▼ & Set

Telephone Service for Australia

Distinctive Ringing (Telstra[®] FaxStream[®] Duet[®])

This machine feature lets you use the Distinctive Ringing subscriber service offered by Telstra's FaxStream[®] Duet[®], which allows you to have two separate telephone numbers on the one phone line. Each phone number has its own Distinctive Ringing pattern, so you know which phone number is ringing. This is one way you can have a separate phone number for your MFC.

Your MFC has a Distinctive Ringing function, allowing you to dedicate one phone number just for receiving faxes.



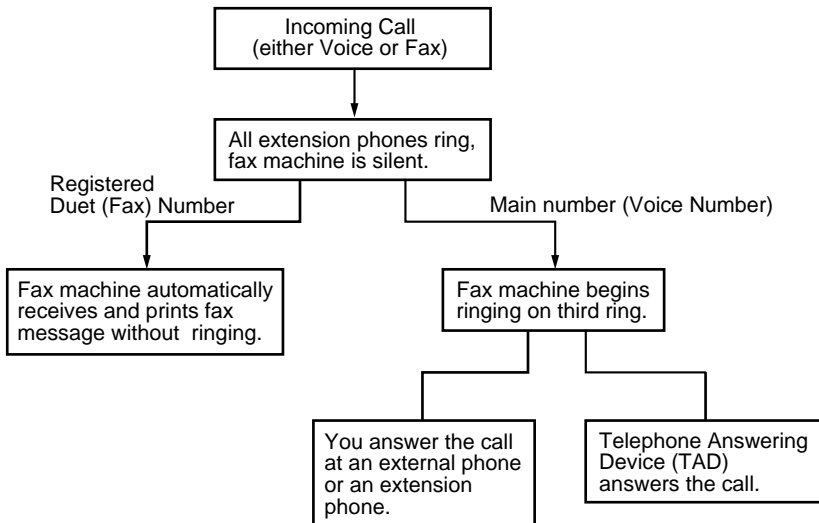

After you have set the Distinctive Ring feature to **ON**, the receive mode is set to **MANUAL** automatically. Unless you have a TAD or Voice Mail set up on the Distinctive Ring number, **MANUAL** mode means you must answer all the call yourself. You can not change the receive mode to the other mode while the Distinctive Ring is set to on.

Flowchart Sequence of Incoming call



Set the Distinctive Ringing to ON

- 1 Press **Menu, 2, 0, 4**. The screen displays the current setting of this feature.
- 2 Press  or  to select On (or Off).
- 3 Press **Set**.
- 4 Press **Stop/Exit**.

20.Miscellaneous
4.Distinctive
▲ On
▼ Off
Select ▲▼ & Set

Caller ID (Caller IDentification)

Caller ID is a telephone service that allows the subscriber to see a display of the caller's phone number or name as the telephone rings. It is a fast way to screen your calls. You can respond quickly to calls you missed, because Caller IDs are received and stored in your MFC memory.



To get the Caller ID Service: apply for the Caller ID service at your local telephone company, if available.

Advantages of Caller ID

For Business

All businesses profit from a quicker response to customer calls. Businesses that provide mail order services, money-lending services or provide confidential information, can protect themselves from false orders or acceptance of false identification.

At Home

Residential customers can protect themselves from unwanted calls.

How Does the Caller ID Work?

The Caller ID Appears on the Display When Your Telephone Rings

As your telephone rings, the display shows you the caller's phone number or name. Once you pick up the handset, the caller's ID disappears. You will see up to the first 16 characters of the number on the display.



- If `Out of Area` appears on the display, it means that the call came from outside your caller ID service area or a public phone. *
- If `Private Call` appears on the display, it means the caller intentionally blocked the transmission of his/her ID. *

* Depends on network Function.

The Caller ID is Stored in Your MFC Memory

The MFC can store a maximum of the last 30 incoming caller IDs in the memory, along with the time and date of reception. The 31st call will cause the oldest ID to be erased.



The Caller ID information stored in the memory can be used for the following.

- **Selecting a Caller ID from the Memory for Call Reply.**
You can scroll through the Caller IDs on the display and select one for your MFC to dial.
- **Printing the Caller ID List.**
You can review calls you received by checking the Caller IDs in memory. This report will list the Date, Time, Phone Number (Caller ID), and type of Call (Comment).

Viewing Caller ID List



Caller ID memory stores information for up to thirty calls; when the thirty-first call comes in, information about the first call is erased. You can scroll through Caller ID information to review those calls made to your MFC.

1 Press **Menu, 2, 0, 5.**



2 Press  or  to select Display# and press **Set.**

If the name was not received, it will not be displayed.

20.Miscellaneous
5.Caller ID
▲ Display#
▼ Print Report
Select ▲▼ & Set

3 Press  or  to scroll through the Caller ID memory to select the Caller ID you want to view and press **Set.**



The next screen shows the caller's telephone number and the date and time of the call.

4 Press  or  to return to the Caller ID listing
—OR—

Press **Stop/Exit** to exit.

Printing Caller ID List

1 Press **Menu, 2, 0, 5.**

2 Press  or  to select Print Report.

3 Press **Set.**

4 Press **Start.**

Telephone Service for New Zealand

FaxAbility

FaxAbility is a service offered by Telecom that allows you to have an additional number on one phone line, with its own distinctive ring pattern. This way, when you get an incoming call, you can identify the number being called by its ring.

How Will the Fax Machine Treat All Other Numbers?

FaxAbility mode ensures that the machine will answer calls to the FaxAbility (secondary) number. When a call comes in to your main number, all the phones will ring. You can set an external answering device (TAD) to answer calls on the other number(s). (See the chart in the following page.)

What is the Advantage of Using the FaxAbility Function?

Using FaxAbility is the most efficient way to receive both fax and telephone calls on the same line. It is much easier for your callers who dial manually. The fax machine will answer with receiving tones so they will not have to press an activation code. And the people who call to talk on your main number will not have to talk to your fax machine. Basically, it gives you two independent numbers without the higher cost of a second line.

How Does FaxAbility Work?

Your telephone number will have the standard ring pattern of long, long tone, while the new number will have a ring pattern of long, silence, long, etc. When FaxAbility is **On**, you will not hear the first ring of all incoming calls on the fax machine. Extension phones will ring as usual. If the fax machine recognizes the ring pattern, all ringing will stop and the fax machine will answer and automatically receive the fax message. Otherwise, you will hear the extension phones and the fax machine continue to ring. The fax machine always listens to the ring pattern before it answers, so do not pick up the phone during that time. You will quickly learn to recognize the ring pattern for faxes, so you will not be tempted to answer that number. Either you or a telephone answering device can answer the main number(s).

Flowchart Sequence of Incoming call

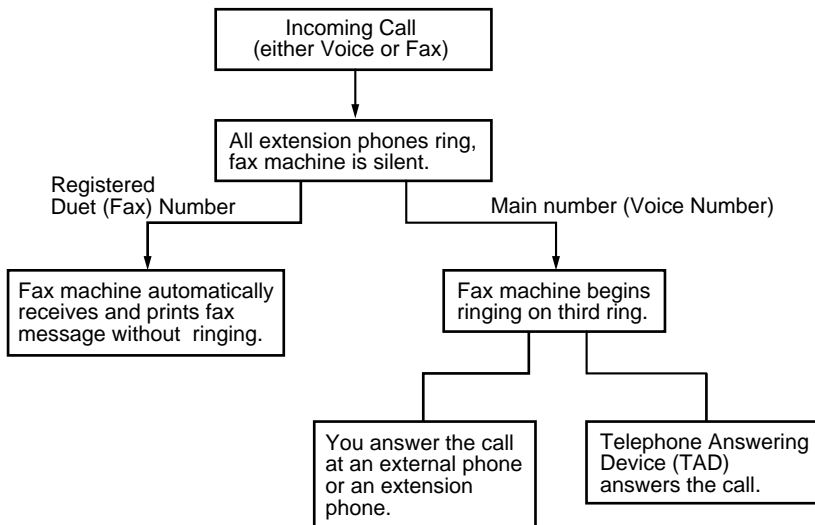

After you have set the FaxAbility feature to **ON**, the receive mode is set to **Manual** automatically. Unless you have a TAD or Voice Mail set up on the FaxAbility number, **Manual** mode means you must answer all the call yourself. You can not change the receive mode to the other mode while the FaxAbility is set to **on**.



How to Turn FaxAbility OFF or ON

The FaxAbility function is designed to accommodate the FaxAbility service provided by Telecom. To change the setting, repeat Steps 1-3; Step 2 is where you can select either *On* or *Off*.

Call Waiting beeps caused by incoming calls on your main number can affect fax transmissions. If you have FaxAbility Service but don't have Call Waiting, you need do nothing at this stage. If you do have Call Waiting as well as FaxAbility, set the Call Waiting menu option to *On*. See below.



- 1 Press **Menu, 2, 0, 4**.

The screen displays

- 2 Press  or  to set FaxAbility to *On* or *Off*.

20.Miscellaneous
4.Faxability
▲ On
▼ Off
Select ▲▼ & Set

If you have FaxAbility service, select *On*.

- 3 Press **Set**.
- 4 Press  or  to set Call Waiting to *On* or *Off*. If you have Call Waiting service, select *On* to avoid the trouble caused by Call Waiting.
- 5 Press **Set**.
- 6 Press **Stop/Exit**.

Caller ID (Caller Identification)

Caller ID is a telephone service that allows the subscriber to see a display of the caller's phone number as the telephone rings. It is a fast way to screen your calls. You can respond quickly to calls you missed, because Caller IDs are received and stored in your MFC memory.



To get the Caller ID Service: apply for the Caller ID service at your local telephone company, if available.

Advantages of Caller ID

For Business

All businesses profit from a quicker response to customer calls. Businesses that provide mail order services, money-lending services or provide confidential information, can protect themselves from false orders or acceptance of false identification.

At Home

Residential customers can protect themselves from unwanted calls.

How Does the Caller ID Work?

The Caller ID Appears on the Display When Your Telephone Rings

As your telephone rings, the display shows you the caller's phone number. Once you pick up the handset, the caller's ID disappears. You will see up to the first 16 characters of the number on the display.





- If `Out of Area` appears on the display, it means that the call came from outside your caller ID service area. *
- If `Private Call` appears on the display, it means the caller intentionally blocked the transmission of his/her ID. *

* Depends on network Function.



Viewing Caller ID List

Caller ID memory stores information for up to thirty calls; when the thirty-first call comes in, information about the first call is erased. You can scroll through Caller ID information to review those calls made to your MFC.



1 Press **Menu, 2, 0, 5.**

2 Press  or  to select Display# and press **Set.**

If the name was not received, it will not be displayed.

3 Press  or  to scroll through the Caller ID memory to select the Caller ID you want to view and press **Set.**

The next screen shows the caller's telephone number and the date and time of the call.

4 Press  or  to return to the Caller ID listing



—OR—

Press **Stop/Exit .**

20.Miscellaneous
5.Caller ID
▲ Display#
▼ Print Report
Select ▲▼ & Set

Printing Caller ID List

1 Press **Menu, 2, 0, 5.**

2 Press  or  to select Print Report.

3 Press **Set.**

4 Press **Start.**



If you use the Caller ID for Dial back...

- Please be sure that you use appropriate dialing procedures for local and national call.
- Please be sure that you make sure of the details of the exact number to be called back, and the need to insert prefix(es) for manual dialing.
- Please understand that your MFC may not display precisely the digits to be called.

Telephone Service for Some Countries

Distinctive Ringing (For Singapore and Hong Kong)

This MFC feature lets you use the Distinctive Ringing subscriber service offered by some telephone companies, which allows you to have several telephone numbers on one phone line. Each phone number has its own Distinctive Ringing pattern, so you'll know which phone number is ringing. This is one way you can have a separate phone number for your MFC.

Your MFC has a Distinctive Ringing function, allowing you to dedicate one phone number just for receiving faxes. You'll need to set Distinctive Ringing to **On**.





You can switch it off temporarily, then turn it back on. When you get a new fax number, make sure you reset this function.

- The MFC will answer only calls to the Distinctive Ringing number.



After you have set the Distinctive Ring feature to **On**, the receive mode is set to **Manual** automatically. Unless you have a TAD or Voice Mail set up on the Distinctive Ring number, **Manual** mode means you must answer all the call yourself. You can not change the receive mode to the other mode while the Distinctive Ring is set to **on**.

Setting the Distinctive Ringing

- 1 Press **Menu, 2, 0, 4**.
- 2 Press  or  to select **On** (or **Off**).
- 3 Press **Set**.
- 4 Press **Stop/Exit**.

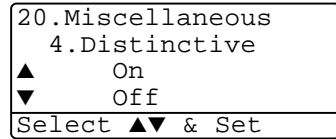

Caller ID (For Singapore and Hong Kong)

The Caller ID feature of this MFC lets you use the Caller ID subscriber service offered by many local phone companies. This service provides you, by means of the screen display, the telephone number (or name) of your caller as the line rings. (See *Printing Caller ID List* on page 5-25.)

After a few rings, the screen displays the telephone number of your caller (or name, if available). Once you pick up the handset, the Caller ID information disappears from the screen, but the call information remains stored in the Caller ID memory.

- You will see the first 16 characters of the number or name.
- *Out of Area* display means call originates outside your Caller ID service area.
- *Private Call* display means the caller has intentionally blocked transmission of information.





If both the name and number are received, the screen displays only the name. You can print a list of Caller ID information received by your MFC.

Caller ID service varies with different carriers. Call your local phone company to determine the kind of service available in your area.

Viewing Caller ID List



Caller ID memory stores information for up to thirty calls; when the thirty-first call comes in, information about the first call is erased. You can scroll through Caller ID information to review those calls made to your MFC.

1 Press **Menu, 2, 0, 5.**



2 Press  or  to select Display#? and press **Set.**

If the name was not received, it will not be displayed.

20.Miscellaneous
5.Caller ID
▲ Display#
▼ Print Report
Select ▲▼ & Set

3 Press  or  to scroll through the Caller ID memory to select the Caller ID you want to view and press **Set.**

The next screen shows the caller's telephone number and the date and time of the call.



4 Press  or  to return to the Caller ID listing

—OR—

Press **Stop/Exit.**

Printing Caller ID List

1 Press **Menu, 2, 0, 5.**

2 Press  or  to select Print Report? and press **Set.**



3 Press **Start.**

6 Setup Send

How to Fax

You can send faxes from the ADF (Automatic Document Feeder) or from the scanner glass.

Enter Fax mode

Before sending faxes, make sure  (**Fax**) is illuminated in green. If not, press  (**Fax**) to enter Fax mode. The default setting is Fax.

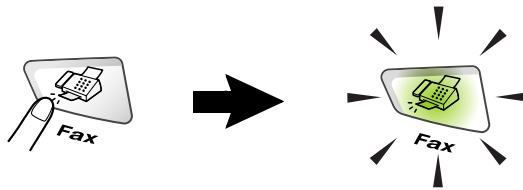

Faxing from the automatic document feeder (ADF)

The ADF can hold up to 50 pages and feeds each sheet individually. Use standard (75 gsm) paper and always fan the pages before putting them in the ADF.

- ⊘ DO NOT use paper that is curled, wrinkled, folded, ripped, stapled, paper clipped, pasted or taped.
DO NOT use cardboard, newspaper or fabric. (To fax this kind of document, see *Faxing from the scanner glass* on page 6-3.)
- Make sure documents written with ink are completely dry.
- The documents to be faxed must be from 148 to 216 mm wide and 148 to 356 mm long.

Faxing from the ADF

1 If it is not illuminated in

green, press



(**Fax**). Pull out the ADF Document Support Extension.

2 Unfold the ADF Document Output Support Flap.

3 Fan the pages well and stagger them at an angle. Make sure you put the documents **face up, top edge first** in the ADF until you feel them touch the feed roller.

4 Adjust the paper guides to fit the width of your documents.

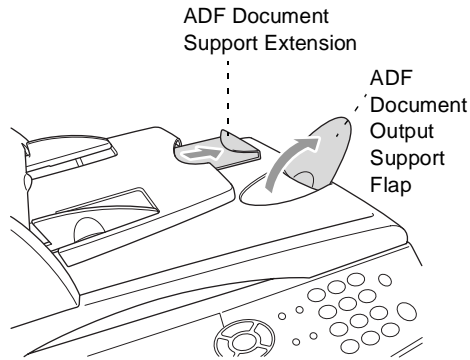

The documents are Face Up in the ADF

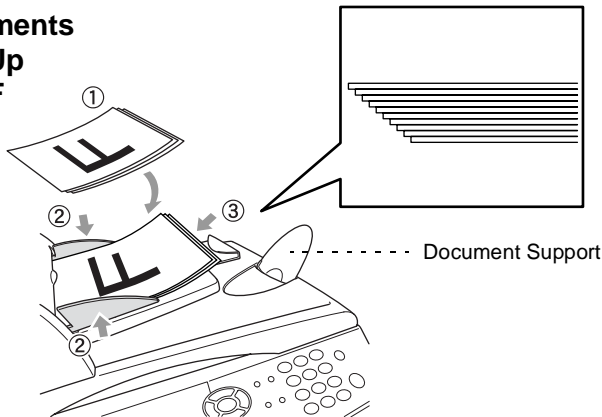

5 Dial the fax number.

Press **Start**. The MFC starts scanning the first page.

Faxing from the scanner glass

You can use the scanner glass to fax pages of a book or one page at a time. The documents can be up to letter, A4 or legal size (216 mm to 356 mm). To cancel, press **Stop/Exit**.

- 1 If it is not illuminated in green, press  (**Fax**). Lift the document cover.

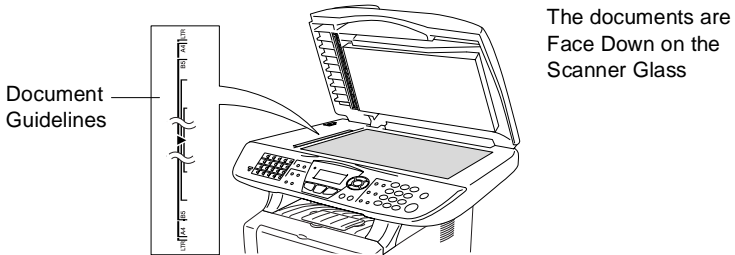

- 2 Using the document guidelines on the left, center the document face down on the scanner glass.
 - 3 Close the document cover.
-  If the document is a book or is thick, do not slam the cover or press on it.
- 4 Dial the fax number.
Press **Start**.
The MFC starts scanning the first page.

5 To send a single page, press **2** (or press **Start** again). The MFC starts sending the document.

—OR—

To send more than one page, press **1** and go to Step 6.

6 Place the next page on the scanner glass.

Press **Set**.

The MFC starts scanning. (Repeat Steps 5 and 6 for each additional page.)

Flatbed Fax: Next Page? ▼ 1.Yes ▲ 2.No(Send) Select ▲▼ & Set
--





- If the memory is full and you are faxing a single page, it will be sent in real time.
- If you need to cancel before the fax is sent, press **Stop/Exit**.

Flatbed Fax: Set Next Page Then Press Set

Faxing legal size documents from the scanner glass

When documents are legal size, you need to set the size to *Legal*. If you do not, the bottom portion of the faxes will be missing.

- 1 If it is not illuminated in green, press  (**Fax**).
- 2 Press **Menu**, **2**, **2**, **0**.
- 3 Press  or  to select *Legal*.
Press **Set**.
- 4 Press **Stop/Exit**.

Out of Memory message

If you get an *Out of Memory* message while scanning the first page of a fax, press **Stop/Exit** to cancel the scan. If you get an *Out of Memory* message while scanning a subsequent page, you will have the option to press **Start** to send the pages scanned so far, or to press **Stop/Exit** to cancel the operation.

Manual transmission

Manual transmission lets you hear the dialing, ringing and fax-receiving tones while sending a fax.

- 1 If it is not illuminated in green, press  (**Fax**). Place the document face up in the ADF, or face down on the scanner glass.
- 2 Pick up the handset of the external phone and listen for a dial tone.
- 3 On the external phone, dial the fax number you want to call.
- 4 When you hear the fax tone, press **Start**.

If you are using the ADF, go to Step 6.

If you are using the scanner glass, go to Step 5.

- 5 Press **1** to send a fax.
- 6 Replace the handset of the external phone.

Send or Receive?

- ▲ 1.Send
- ▼ 2.Receive

Select ▲▼ & Set

Automatic transmission

This is the easiest way to send a fax.

- 1 If it is not illuminated in green, press  (**Fax**). Place the document face up in the ADF, or face down on the scanner glass.
- 2 Enter the fax number using the dial pad, One-Touch, Speed-Dial or Search.
(See *One-Touch Dialing* on page 7-7 and *Speed-Dialing* on page 7-8.)
- 3 Press **Start**.
- 4 If you are using the scanner glass, press **2** or **Start**.

Sending a fax at the end of a conversation

At the end of a conversation you can send a fax to the other party before you both hang up.

- 1 Ask the other party to wait for fax tones (beeps) and then to press **Start** before hanging up.
- 2 If it is not illuminated in green, press  (**Fax**). Place the document face up in the ADF, or face down on the scanner glass.
Press **Start**.
The LCD shows:
- 3 Press **1** to send the fax.
- 4 Replace the external handset.

Send or Receive?
▲ 1.Send
▼ 2.Receive
Select ▲▼ & Set

Basic sending operations

Sending faxes using multiple settings

When you send a fax you can choose any combination of these settings: cover page, contrast, resolution, overseas mode, delayed fax timer, polling transmission or real time transmission. If it is not

illuminated in green, press  (**Fax**) before pressing **Menu**.

After each setting is accepted, the LCD will ask if you want to enter more settings:

Press **1** to select more settings. The LCD will return to the Setup Send menu.

—OR—

Press **2** if you have finished choosing settings and go to the next step.

22.Setup Send
Next?
▲ 1.Yes
▼ 2.No
Select ▲▼ & Set

Contrast

If your document is very light or very dark, you may want to set the contrast.

Use **Light** to make the fax darker.

Use **Dark** to make the fax lighter.

1 If it is not illuminated in green, press  (**Fax**). Place the document face up in the ADF, or face down on the scanner glass.

2 Press **Menu**, **2**, **2**, **1**.

3 Press  or  to select **Auto**, **Light** or **Dark**.

Press **Set**.

22.Setup Send
1.Contrast
▲ Auto
▼ Light
Select ▲▼ & Set

4 Press **1** if you want to choose more settings and the LCD will return to the **Setup Send** menu.

—OR—

Press **2** if you have finished choosing settings for this page, and then go to Step 5.

5 Enter a fax number.

6 Press **Start** to send the fax from the ADF.

The MFC starts scanning the first page.

If you are using the scanner glass, go to Step 7.

7 To send a single page, press **2** (or press **Start** again).

The MFC starts sending the document.

—OR—

To send more than one page, press **1** and go to Step 8.

8 Place the next page on the scanner glass.

Press **Set**.



The MFC starts scanning and returns to Step 7. (Repeat Step 7 and 8 for each additional page).

Fax Resolution

When you have a document in the ADF or on the scanner glass you can use the **Resolution** key to change the setting temporarily (for this fax only). If it is not illuminated in green, press  (**Fax**). Press **Resolution** repeatedly until the LCD shows the setting you want.

—OR—

You can change the default setting.

- 1 If it is not illuminated in green, press  (**Fax**).
- 2 Press **Menu, 2, 2, 2**.
- 3 Press  or  to select the resolution you want.
Press **Set**.
- 4 Press **Stop/Exit**.

22.Setup Send
2.Fax Resolution
▲ Standard
▼ Fine
Select ▲▼ & Set

Standard: Suitable for most typed documents.

Fine: Good for small print and transmits a little slower than Standard resolution.

S.Fine: Good for small print or artwork and transmits slower than Fine resolution.

Photo: Use when the document has varying shades of gray. This has the slowest transmission time.

Manual and automatic fax Redial

If you are sending a fax manually and the line is busy, press **Redial/Pause**, and then press **Start** to try again. If you want to make a second call to the last number dialed, you can save time by pressing **Redial/Pause** and **Start**.

Redial/Pause only works if you dialed from the control panel.

If you are sending a fax automatically and the line is busy, the MFC will automatically redial up to three times at five minutes intervals.

Dual Access

You can dial a number, and begin scanning the fax into memory—even when the MFC is receiving, sending or printing a fax from memory. The LCD shows the new job number.

 If you get a *Out of Memory* message while scanning the first page of a fax, press **Stop/Exit** to cancel scanning. If you get a *Out of Memory* message while scanning a subsequent page, you can press **Start** to send the pages scanned so far, or press **Stop/Exit** to cancel the operation.

1 If it is not illuminated in green, press  (**Fax**). Place the document face up in the ADF, or face down on the scanner glass.

2 Enter the fax number.

3 Press **Start** to send the fax.

The MFC starts scanning the first page and the LCD shows the job number (#XXX) of the fax. You can repeat Steps 1 to 3 for the next fax.

—OR—

If you are using the scanner glass, go to Step 4.

4 To send a single page, press **2** (or press **Start** again).

The MFC starts sending the document.

—OR—

To send more than one page, press **1** and go to Step 5.

5 Place the next page on the scanner glass. Press **Set**.

The MFC starts scanning, and then returns to Step 4. (Repeat Steps 4 and 5 for each additional page). To send the next fax, go to Step 1.

Flatbed Fax: Next Page? ▲ 1.Yes ▼ 2.No(Send) Select ▲▼ & Set
--

Flatbed Fax: Set Next Page Then Press Set

Real Time Transmission

When you are sending a fax, the MFC will scan the documents into the memory before sending. Then, as soon as the phone line is free, the MFC will start dialing and sending.



If the memory becomes full, the MFC will send the document in real time (even if Real Time TX is set to Off).

Sometimes, you may want to send an important document immediately, without waiting for memory transmission. You can set Real Time TX to On for all documents or for the next fax only.

If you want to fax multiple pages, use ADF.

1 If it is not illuminated in green, press  (**Fax**). Place the document face up in the ADF, or face down on the scanner glass.

2 Press **Menu**, **2**, **2**, **5**.



3 To change the default setting, press  or  to select On (or Off).

22.Setup Send
5.Real Time TX
▲ Next Fax Only
▼ On
Select ▲▼ & Set



Press **Set**.

Go to Step 5.

—OR—

For the next fax transmission only, press  or  to select Next Fax Only.

Press **Set**.

4 Press  or  to select Next Fax:On (or Next Fax:Off).

Press **Set**.

5 Press **1** if you want to choose more settings and the LCD will return to the Setup Send menu.

—OR—

Press **2** if you have finished choosing settings for this page, and then go to Step 6.

6 Enter the fax number.

7 Press **Start** to send the fax.





In Real Time Transmission using the scanner glass, the auto redial function doesn't work.

Checking job status

Check which jobs are still waiting in the memory to be sent. (If there are no jobs, the LCD shows No Jobs Waiting.)

1 Press **Menu, 2, 6**.

2 If you have more than one job waiting, press  or  to scroll through the list.

3 Press **Stop/Exit**.

26.Remaining Jobs		
▲	#001 12:34	BROTHER
	#002 15:00	BIC
▼	#003 17:30	ABCDEFG
Select ▲▼ & Set		

Canceling a job while scanning the document



You can cancel a job while you are scanning it into memory by pressing **Stop/Exit**.

Canceling a scheduled job

You can cancel a fax job that is stored and waiting in memory.

1 Press **Menu**, **2**, **6**.

Any jobs that are waiting will appear on the LCD.

2 If you have more than two jobs waiting, press  or  to select the job you want to cancel.

Press **Set**.

—OR—

If you only have one job waiting, go to Step 3.

3 Press **1** to cancel.

—OR—

Press **2** to exit without canceling.

To cancel another job go to Step 2.

4 Press **Stop/Exit**.

26.Remaining Jobs		
▲	#001 12:34	BROTHER
	#002 15:00	BIC
▼	#003 17:30	ABCDEFG
Select ▲▼ & Set		

Advanced sending operations

Composing the electronic Cover Page

The Cover Page is created at the receiving machine. Your Cover Page includes the name stored in the One-Touch or Speed-Dial memory. If you're dialing manually, the name is left blank.

The Cover Page shows your Station ID and the number of pages you're sending. (See *Setting the Station ID* on page 4-2.) If you have Cover Page set to ON (**Menu, 2, 2, 7**), the number of pages is left blank.

You can select a comment to include on your Cover Page.

- 1.Note Off
- 2.Please Call
- 3.Urgent
- 4.Confidential

Instead of using one of the preset comments, you can enter two personal messages of your own, up to 27 characters long. Use the chart on page 4-3 for help entering characters.

(See *Composing your own comments* on page 6-15.)

- 5.(User Defined)
- 6.(User Defined)

Most of the Setup Send settings are temporary to allow you to make changes for each fax you send.



However, when you set up your Cover Page and Cover Page Comments, you are changing the default settings so they will be available while faxing.

Composing your own comments

You can set up two comments of your own.

1 If it is not illuminated in green, press  **(Fax)**.

2 Press **Menu, 2, 2, 8**.

3 Press  or  to choose 5 or 6 for your own comment.

Press **Set**.

4 Use the dial pad to enter your customized comment.

Press **Set**.

(See *Entering text* on page 4-3.)

5 Press **1** if you want to choose more settings and the LCD will return to the *Setup Send* menu.

—OR—

Press **2** to exit.

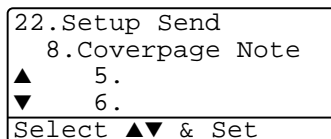

Cover page for the next fax only



This feature does not work without the Station ID. So make sure it has been set. (See *Setting the Station ID* on page 4-2.) If you only want to send a Cover Page with a particular fax, this Cover Page will include the number of pages in your document.

1 If it is not illuminated in green, press  **(Fax)**. Place the document face up in the ADF, or face down on the scanner glass.



2 Press **Menu, 2, 2, 7**.

3 When LCD shows *Next Fax Only*.

Press **Set**.

4 Press  or  to select *Next Fax: On* (or *Next Fax: Off*).

Press **Set**.

5 Press  or  to select one of the standard or your own comments.

Press **Set**.

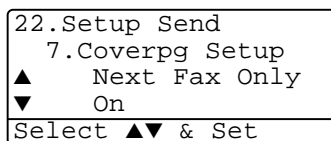





- 6 Enter two digits to show the number of pages you are sending. Press **Set**.
(For example, press **0, 2** for 2 pages or enter **0 0** to leave the number of pages blank. If you make a mistake, press  to back up and re-enter the number of pages.)
- 7 Press **1** if you want to choose more settings and the LCD will return to the *Setup Send* menu.
—OR—
Press **2** if you have finished choosing settings.
- 8 Enter the fax number you're calling.
- 9 Press **Start**.

Send a cover page for all faxes

This feature does not work without the Station ID. Please be sure it has been set before continuing. (See *Setting the Station ID* on page 4-2.)

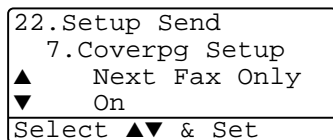

You can set the MFC to send a cover page whenever you send a fax. The number of pages in your fax is not included when you use this setting.

- 1 If it is not illuminated in green, press  (**Fax**).
- 2 Press **Menu, 2, 2, 7**.
- 3 Press  or  to select **On**.
Press **Set**.
- 4 If you selected **On**, Press  or  to select one of the standard or your own comments.
Press **Set**.
- 5 Press **1** if you want to choose more settings and the LCD will return to the *Setup Send* menu.
—OR—
Press **2** to exit if you have finished choosing settings.



Using a printed cover page

If you prefer to use a printed cover page that you can write on, you can print the sample page and attach it to your fax.

- 1 If it is not illuminated in green, press  (**Fax**).
- 2 Press **Menu, 2, 2, 7**.
- 3 Press  or  to select Print Sample.
Press **Set**.
- 4 Press **Start**. Your MFC prints a copy of your cover page.
- 5 Press **Stop/Exit**.

22.Setup Send
7.Coverpg Setup
▲ Off
▼ Print Sample
Select ▲▼ & Set

Broadcasting

Broadcasting is when the same fax message is automatically sent to more than one fax number. Using the **Set** key, you can include Groups, One-Touch, Speed-Dial numbers and up to 50 manually dialed numbers. If you did not use up any of the numbers for Groups, access codes or credit card numbers, you can 'broadcast' faxes to as many as 390 different numbers. However, the available memory will vary depending on the types of jobs in the memory and the number of locations used for broadcasting. If you broadcast to the maximum numbers available, you will not be able to use Dual Access and Delayed fax.

To include One-Touch or Speed-Dial numbers and manually dialed numbers in the same broadcast, you must press **Set** between each of the numbers. Use **Search/Speed Dial** to help you choose the numbers easily.

(See *Setting up Groups for Broadcasting* on page 7-5.)

After the broadcast is finished, a Broadcast Report will be printed to let you know the results.

- Enter the long dialing sequence numbers as you would normally, but remember that each One-Touch and Speed-Dial number counts as one number, so the number of locations you can store becomes limited.

- If the memory is full, press **Stop/Exit** to stop the job or if more than one page has been scanned, press **Start** to send the portion that is in the memory.

1 If it is not illuminated in green, press  (**Fax**). Place the document face up in the ADF, or face down on the scanner glass.

2 Enter a number using One-Touch, Speed-Dial, a Group number, Search or manual dialing using the dial pad.

(Example: Group number)

3 When the LCD displays the fax number of the other party, press **Set**.

You will be asked to press the next number.

4 Enter the next number.

(Example: Speed-Dial number)

5 When the LCD displays the fax number of the other party, press **Set**.

6 Enter another fax number.

(Example: Manual dialing using the dial pad.)

7 Press **Start**.

If you are using the scanner glass, go to Step 8.

8 To send a single page, press **2** (or press **Start** again).

The MFC starts sending the fax.

—OR—

To send more than one page, press **1** and go to Step 9.

9 Place the next page on the scanner glass.

Press **Set**.

The MFC starts scanning and returns to Step 8. (Repeat Step 8 and 9 for each additional page.)

Overseas Mode

If you are having difficulty sending a fax overseas due to possible interference on the phone line, we recommend that you turn on the Overseas Mode. After you send a fax using this feature, the feature will turn itself off.

1 If it is not illuminated in green, press  (**Fax**). Place the document face up in the ADF, or face down on the scanner glass.

2 Press **Menu, 2, 2, 9**.

3 Press  or  to select On (or Off).

Press **Set**.

22.Setup Send
9.Overseas Mode
▲ On
▼ Off
Select ▲▼ & Set

4 Press **1** if you want to choose more settings and the LCD will return to the Setup Send menu.

—OR—

Press **2** if you have finished choosing settings, and then go to Step 5.

5 Enter the fax number you're calling.

6 Press **Start**.

If you are using the scanner glass, go to Step 7.

7 To send a single page, press **2** (or press **Start** again).

The MFC starts sending the fax.

—OR—

To send more than one page, press **1** and go to Step 8.

8 Place the next page on the scanner glass.

Press **Set**.

The MFC starts scanning and returns to Step 7. (Repeat Steps 7 and 8 for each additional page.)

Delayed Fax

During the day you can store up to 50 faxes in the memory to be sent within 24 hours. These faxes will be sent at the time of day you enter in Step 3. Press **Set** to accept it, or enter another time for the faxes to be sent.

1 If it is not illuminated in green, press  (**Fax**). Place the document face up in the ADF, or face down on the scanner glass.

2 Press **Menu**, **2**, **2**, **3**.

3 Enter the time you want the fax to be sent (in 24-hour format).

Press **Set**.

22.Setup Send
3.Delayed Fax
Set Time=00:00
Enter & Set Key

(For example, enter 19:45 for 7:45 PM.)

4 Press **1** if you want to choose more settings and the LCD will return to the Setup Send menu.

—OR—

Press **2** if you have finished choosing settings, and then go to Step 5.

5 Enter the fax number.

6 Press **Start**.

If you are using the scanner glass, go to Step 7.

7 To send a single page, press **2** (or press **Start** again).

The MFC starts scanning the document.

—OR—

To send more than one page, press **1** and go to Step 8.

8 Place the next page on the scanner glass.

Press **Set**.



The MFC starts scanning and returns to Step 7. (Repeat Step 7 and 8 for each additional page.)



The number of pages you can scan into the memory depends on the amount of data that is printed on each page.

Delayed Batch Transmission



Before sending the delayed faxes, your MFC will help you economize by sorting all the faxes in the memory by destination and scheduled time. All delayed faxes that are scheduled to be sent at the same time to the same fax number will be sent as one fax to save transmission time.

- 1 If it is not illuminated in green, press  (**Fax**).
- 2 Press **Menu, 2, 2, 4**.
- 3 Press  or  to select On (or Off).
Press **Set**.
- 4 Press **Stop/Exit**.

22.Setup Send
4.Batch TX
▲ On
▼ Off
Select ▲▼ & Set

Setup for Polled Transmit (Standard)

Polled Transmit is when you set up the machine to wait with a document so another fax machine can retrieve it.

- 1 If it is not illuminated in green, press  (**Fax**). Place the document face up in the ADF, or face down on the scanner glass.
- 2 Press **Menu, 2, 2, 6**.
- 3 Press  or  to select Standard.
Press **Set**.
- 4 Press **1** if you want to select additional settings. The display returns to the Setup Send menu.
—OR—
Press **2** if you finished selecting settings, and go to Step 5.
- 5 Press **Start**.
The MFC starts scanning the document.
- 6 If you placed the document in the ADF, wait for the fax to be polled.
—OR—
If you placed it on the scanner glass, go to Step 7.

7 To send a single page, press **2** (or press **Start** again), wait for the fax to be polled.

—OR—

To send more than one page, press **1** and go to Step 8.

8 Place next page on the scanner glass.

Press **Set**.

The MFC starts scanning and returns to Step 7. (Repeat Step 7 and 8 for each additional page.)



The document will be stored and can be retrieved from any other fax machine until you delete the fax in memory by using the Canceling a Job function. (See *Canceling a scheduled job* on page 6-13.)

Setup for Polled Transmit with Secure Code

When you choose *Secure*, anyone who polls the machine must enter the polling secure code.

1 If it is not illuminated in green, press  (**Fax**). Place the document face up in the ADF, or face down on the scanner glass.

2 Press **Menu, 2, 2, 6**.

3 Press  or  to select *Secure*.

Press **Set**.

4 Enter a four-digit number.

Press **Set**.

5 Press **1** if you want to select additional settings. The display returns to the *Setup Send* menu.

—OR—

Press **2** if you finished selecting settings, and go to Step 6.

6 Press **Start**.

The MFC starts scanning the document.

7 If you placed the document in the ADF, wait for the fax to be polled.

—OR—

If you placed it on the scanner glass, go to Step 8.

8 To send a single page, press **2** (or press **Start** again), wait for the fax to be polled.

—OR—

To send more than one page, press **1** and go to Step 9.

9 Place next page on the scanner glass.

Press **Set**.

The MFC starts scanning and returns to Step 8. (Repeat Step 8 and 9 for each additional page.)



You can use Secure Polling only with another Brother fax machine.

Memory Security

Memory Security lets you prevent unauthorized access to the MFC. You will not be able to continue to schedule Delayed Faxes or Polling jobs. However, any pre-scheduled Delayed Faxes will be sent when you turn Memory Security **On**, so they won't be lost.

If Fax Storage is **On** *before* you turn Memory Security **On**, then Fax Forwarding and Remote Retrieval will continue to work.

While Memory Security is **On** the following operations are available:

- Receiving faxes into memory (limited by memory capacity)
- Fax Forwarding (If Fax Storage was already **On**)
- Remote Retrieval

While Memory Security is **On** the following operations are NOT available:

- Sending faxes
- Printing received faxes
- Copy
- PC printing
- PC scanning



To print the faxes in memory, turn Memory Security **Off**.

Setting up the password



If you forget the Memory Security password, please call your Brother dealer for service.

Security password is very important for operation. If you lost, a reset procedure must be done by Brother with service charge.



- 1 Press **Menu**, **2**, **0**, **1**.
- 2 Enter a 4-digit number for the password.
Press **Set**.

20.Miscellaneous
1.Mem Security
New Passwd:xxxx
Enter & Set Key

If you are entering the password for the first time, the LCD shows *Verify*:

- 3 Re-enter the password.
Press **Set**.

Turning Memory Security on

- 1 Press **Menu**, **2**, **0**, **1**.
- 2 Press  or  to select *Set Security*.
Press **Set**.

20.Miscellaneous
1.Mem Security
▲ Set Security
▼ Set Password
Select ▲▼ & Set

- 3 Enter the registered 4-digit password.
Press **Set**.

The MFC goes offline and the LCD shows *Secure Mode*.



If there is a power failure, the data in the memory will remain for up to 4 days.

Turning Memory Security off

- 1 Press **Menu**.
Enter the registered 4-digit password and press **Set**.
- 2 Memory Security is automatically turned off and the LCD shows the Date and Time.



If you enter the wrong Password, the LCD shows *Wrong Password* and stays offline. The MFC will stay in *Secure Mode* until the registered password is entered.

7

Auto Dial numbers and dialing options

Storing numbers for easy dialing

You can set up your MFC to do three types of easy dialing: One-Touch, Speed-Dial and Groups for Broadcasting faxes.



If you lose electrical power, the auto dial numbers that are in the memory will not be lost.

Storing One-Touch Dial numbers

Your MFC has 20 One-Touch keys where you can store 40 fax or phone numbers for automatic dialing. To access numbers 21 to 40, hold down **Shift** as you press the One-Touch key. When you press a One-Touch key the LCD shows the name, if you stored it, or the number. (See *One-Touch Dialing* on page 7-7.)

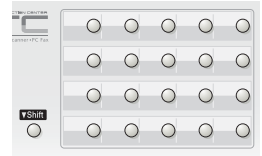

One-Touch keys are the 20 keys (numbers 01–40) located on the left side of the control panel.



- 1 Press **Menu**, **2**, **3**, **1**.
- 2 Press the One-Touch key where you want to store a number.
If you have not installed the optional LAN board (NC-9100h), go to Step 4.

```
23.Set Quick-Dial
  1.One-Touch Dial

One-Touch:
Select One-Touch
```

—OR—

If you have installed optional LAN board (NC-9100h), the MFC will ask you if the One-Touch key is for a fax/telephone number or an e-mail address. Go to Step 3.

- 3 Press  or  to select Fax/Tel.
Press **Set**.

```
23.Set Quick-Dial
 *007
▲ Fax/Tel
▼ E-Address
Select ▲▼ & Set
```

4 Enter a number (up to 20 digits).

Press **Set**.

- If you want to enter a pause in the dialing sequence (for example, to access an outside line), press **Redial/Pause** as you are entering the digits.

Each key press of **Redial/Pause** enters a 3.5 second pause when the number is dialed, and a dash appears on the screen.

5 Use the dial pad to enter the name (up to 15 characters).

Press **Set**.

(You can use the chart on page 4-3 to help you enter letters.)

—OR—

Press **Set** to store the number without a name.

6 Go to Step 2 to store another One-Touch number.

—OR—

Press **Stop/Exit**.

When you dial an auto dial number, the LCD shows the name and number you've stored, or, if you haven't stored a name, only the number you've stored.

Storing Speed-Dial numbers

You can store Speed-Dial numbers, so that when you dial you will only have to press a few keys (**Search/Speed Dial**, **#**, the three-digit number, and **Start**). The MFC can store 300 Speed-Dial numbers.

- 1 Press **Menu**, **2**, **3**, **2**.
- 2 Use the dial pad to enter a three-digit Speed-Dial number (001-300).



(For example, press **005**.)

Press **Set**.

If you have not installed the optional LAN board (NC-9100h), go to Step 4.

—OR—

If you have installed optional LAN board (NC-9100h), the MFC will ask you if have the Speed-Dial is for a fax/telephone number or an e-mail address. Go to Step 3.

- 3 Press  or  to select Fax/Tel.
- 4 Enter the phone or fax number (up to 20 digits).

Press **Set**.

- 5 Use the dial pad to enter the name (up to 15 characters).

Press **Set**.

(You can use the chart on page 4-3 to help you enter letters.)

—OR—

Press **Set** to store the number without a name.

- 6 Go to Step 2 to store another Speed-Dial number.

—OR—

Press **Stop/Exit**.

23.Set Quick-Dial 2.Speed-Dial

Speed-Dial? #

Enter & Set Key

23.Set Quick-Dial #100

▲ Fax/Tel

▼ E-Address

Select ▲▼ & Set

Changing One-Touch and Speed-Dial numbers

If you try to store a One-Touch or Speed-Dial number where a number has already been stored, the LCD will show the name that has been stored there (or number) and will ask you to do one of the following:

- 1 Press **1** to change the stored number.



—OR—



Press **2** to exit without making a change.

- 2 Enter a new number.

Press **Set**.

- To erase the whole number or whole name, press **Clear/Back** repeatedly until all digits or letters are deleted.

To erase one digit or letter, use  or  to position the cursor under it, and then press **Clear/Back**.

- If you want to insert characters, use  or  to position the cursor where you want to insert them, and then type.

- 3 Follow the directions beginning at Step 4 in Storing One-Touch Dial numbers and Storing Speed-Dial numbers. (See *Storing One-Touch Dial numbers* on page 7-1 and *Storing Speed-Dial numbers* on page 7-3.)

23.Set Quick-Dial
*005:MIKE
▲ 1.Change
▼ 2.Exit
Select ▲▼ & Set

Setting up Groups for Broadcasting

Groups, which can be stored on a One-Touch key or a Speed-Dial location, allow you to send the same fax message to many fax numbers by pressing only a One-Touch key and **Start** or **Search/Speed Dial**, #, the three-digit location and **Start**.

First, you'll need to store each fax number as a One-Touch or Speed-Dial number. Then, you can combine them into a Group, Each Group uses up a One-Touch key or a Speed-Dial location. Finally, you can have up to six small Groups, or you can assign up to 339 numbers to one large Group.

(See *Storing Speed-Dial numbers* on page 7-3 and *Changing One-Touch and Speed-Dial numbers* on page 7-4.)

1 Press **Menu**, **2**, **3**, **3**.

2 Decide where you wish to store the Group.

—**AND**—

Press a One-Touch key.

—**OR**—

Press **Search/Speed Dial** and enter the three-digit location, and then press **Set**.

(For example, press One-Touch key 2 for Group 1.)

3 Use the dial pad to enter the Group number.

Press **Set**.

(For example, press **1** for Group 1.)

23.Set Quick-Dial 3.Setup Groups Group Dial: Press Speed Dial ...
--

23.Set Quick-Dial *002 Group#:0 Enter No. & Set
--

- 4** To include One-Touch or Speed-Dial numbers in the Group, enter them as if you were dialing.
For example, for One-Touch key **05**, press One-Touch key **05**. For Speed-Dial location 009, press **Search/Speed Dial**, then press **009** on the dial pad. The LCD shows * 005, #009.
 - 5** Press **Set** to accept the numbers for this Group.
 - 6** Use the dial pad and the chart on page 4-3 to enter a name for the Group.
Press **Set**.
(For example, NEW CLIENTS)
 - 7** Press **Stop/Exit**.
-  You can print a list of all One-Touch and Speed-Dial numbers. (See *Printing reports* on page 9-3.) Group numbers will be marked in the column of "GROUP".

Dialing options











When you dial using an auto dial number, the LCD shows the name and fax number you've stored.

Search

You can search for names you have stored in the One-Touch and Speed-Dial memory.



(See *Storing One-Touch Dial numbers* on page 7-1 and *Storing Speed-Dial numbers* on page 7-3.)

- 1 If it is not illuminated in green, press  (**Fax**). Place the document face up in the ADF, or face down on the scanner glass.
 - 2 Press **Search/Speed Dial**.
 - 3 Press  or .
- To search alphabetically through the names that are stored, enter the first letter of the name you're looking for and press  or .
- OR—
- Press  or .
- To search for numbers numerically, press  or .
- 4 When the LCD shows the name you want to call, Press **Start**.

One-Touch Dialing

- 1 If it is not illuminated in green, press  (**Fax**). Place the document face up in the ADF, or face down on the scanner glass.
- 2 Press the One-Touch key of the location you want to call.
- 3 Press **Start**.

Speed-Dialing

- 1** If it is not illuminated in green, press  (**Fax**). Place the document face up in the ADF, or face down on the scanner glass.
 - 2** Press **Search/Speed Dial**, #, and then the three-digit Speed-Dial number. (See *Storing Speed-Dial numbers* on page 7-3.)
 - 3** Press **Start**.
-  If you try to use a One-Touch or Speed-Dial location with no number stored in it, you hear a warning sound, and LCD shows **Not Registered**. The LCD returns to normal after 2 seconds.

Manual dialing

Manual dialing means pressing all of the digits of the phone number.

Using an external telephone

The easiest way to use your external telephone is to pick up the handset and dial the number on the external telephone as you normally would.

- 1** Pick up the handset of the external telephone.
- 2** Dial the number on the external telephone.
- 3** To hang up, replace the handset.

Access codes and credit card numbers

Sometimes you may want to choose from several long distance carriers when you make a call. Rates may vary depending on the time and destination. To take advantage of low rates, you can store the access codes or long-distance carriers and credit card numbers as One-Touch and Speed-Dial numbers. You can store these long dialing sequences by dividing them and setting them up on separate keys in any combination. You can even include manual dialing using the dial pad.

The combined number will be dialed in the order that you entered it as soon as you press **Start**.

(See *Storing One-Touch Dial numbers* on page 7-1.)

For example, you can store '555' on One-Touch key 03 and '7000' on One-Touch key 02. If you press One-Touch key **03**, One-Touch key **02**, and **Start**, you will dial '555-7000'.

To temporarily change a number, you can substitute part of the number with manual dialing using the dial pad.

For example, to change the number to 555-7001 you could press One-Touch key **03** and then press **7001** using the dialing pad.



If you must wait for another dial tone or signal at any point in the dialing sequence, store a pause there in the number by pressing **Redial/Pause**. Each key press adds a 3.5-second delay.

Pause

Press **Redial/Pause** to insert a 3.5-second pause between numbers. If you are dialing overseas, you can press **Redial/Pause** as many times as needed to increase the length of the pause.

Tone or Pulse (Except for New Zealand)

If you have a Pulse dialing service, but need to send Tone signals (for example, for telephone banking), follow the instructions below. If you have Touch Tone service, you will not need this feature to send tone signals.

- 1** Lift the handset of an external phone.
- 2** Press **#** on the control panel of your MFC. Any digits dialed after this will send tone signals.
- 3** When you hang up, the MFC will return to the Pulse dialing service.

8

Remote Fax Options

Fax Forwarding



After you have selected Fax Forwarding, Fax Storage is set to On automatically.

Programming a Fax Forwarding number

When Fax Forwarding is set to On, your MFC stores the received fax in the memory. Then it dials the fax number you've programmed and forwards the fax message.

1 Press **Menu**, **2**, **5**, **1**.

2 Press  or  to select On (or Off).

Press **Set**.

The LCD will ask you to enter the fax number to which faxes will be forwarded.

3 Enter the forwarding number (up to 20 digits).

Press **Set**.

4 Press **Stop/Exit**.

25.Remote Fax Opt
1.Fax Forward
▲ On
▼ Off
Select ▲▼ & Set

Setting Fax Storage

If you set Fax Storage to ON, you will be able to retrieve fax messages from another location using Fax Forwarding, Remote Retrieval operations. The LCD will show when you have a fax stored in memory.

1 Press **Menu, 2, 5, 2.**

The LCD will ask you to choose a fax setting.

2 Press  or  to select On (or Off).

Press **Set.**

3 Press **Stop/Exit.**

25.Remote Fax Opt
2.Fax Storage
▲ On
▼ Off
Select ▲▼ & Set

 If there are faxes in the memory when you turn Fax Storage OFF, the LCD will ask if you want to erase the faxes in the memory.

If you press **1**, all fax data is erased and Fax Storage is turned off.

If you press **2**, faxes are not erased and Fax Storage stays on.

(See *Polling* on page 5-10.)

-  ■ After you have selected Fax Forwarding feature, Fax Storage is set to On automatically. If you bring Fax Forwarding feature back to Off, Fax Storage stays on.
- If there is a power failure, you will not lost the data in memory up to 4 days.

Setting your Remote Access Code

The remote access code lets you access the Remote Retrieval features when you are away from your MFC. Before you use the remote access and retrieval features, you have to set up your own code. The default code is inactive code (--- *).

- 1 Press **Menu, 2, 5, 3**.
- 2 Enter a three-digit code using numbers **0-9, *** or **#**.
Press **Set**. (The preset ' * ' cannot be changed.)

25.Remote Fax Opt 3.Remote Access Access Code:---* Enter & Set Key



Do not use the same digits that appear in your Remote Activation Code (* **51**) or Deactivation Code (**#51**).
(See *Operation from extension telephones* on page 5-8.)

- 3 Press **Stop/Exit**.



You can change your code at any time by entering a new one. If you want to make your code inactive, press **Clear/Back** in Step 2 to restore the inactive setting (--- *).

Remote retrieval

You can call your MFC from any telephone or fax machine using touch tone, then use the Remote Access Code and remote commands to retrieve fax messages. Be sure to cut out the Remote Retrieval Access Card on the last page and keep it with you at all times.

Using your Remote Access Code

- 1** Dial your fax number from a telephone or another fax machine using touch tone.
- 2** When your MFC answers, immediately enter your Remote Access Code (3 digits followed by *).
- 3** The MFC signals if it has received fax messages:
1 long beep — Fax messages
No beeps — No fax messages
- 4** The MFC gives two short beeps, which tells you to enter a command. The MFC will hang up if you wait longer than 30 seconds to enter a command. The MFC will beep three times, if you enter an invalid command.
- 5** Press **90** to reset the MFC when you've finished.
- 6** Hang up.



If your MFC is set to `Manual` mode and you want to use the remote retrieval features, you can access your MFC by waiting about 2 minutes after it starts ringing, and then entering the Remote Access Code within 30 seconds.

Remote commands

Follow the commands below to access features when you are away from the MFC. When you call the MFC and enter your Remote Access Code (3 digits followed by *), the system will give two short beeps and you must enter a remote command.

Remote commands	Operation details
95 Change the Fax Forwarding settings	
1 OFF	If you hear one long beep, the change has been accepted. If you hear three short beeps, you cannot change it because the conditions have not been met. You can register your Fax Forwarding number by entering 4. (See <i>Changing your Fax Forwarding number</i> on page 8-6). Once you have registered the number, Fax Forwarding will be set to On.
2 Fax Forwarding	
4 Fax Forwarding number	
6 Fax Storage ON	You can turn Fax Storage to On (or Off after you have retrieved or erased all your messages).
7 Fax Storage OFF	
96 Retrieve a fax	
2 Retrieve all faxes	Enter the number of a remote fax machine to receive stored fax messages. (See <i>Retrieving fax messages</i> on page 8-6.)
3 Erase faxes from the memory	If you hear one long beep, you can erase fax messages from the memory.
97 Check the receiving status	
1 Fax	You can check whether your MFC has received any faxes. If it has, you will hear one long beep. If it hasn't, you will hear three short beeps.
98 Change the Receive Mode	
1 External TAD	If you hear one long beep, you can change the Receive Mode.
2 Fax/Tel	
3 Fax Only	
90 Exit	After a long beep, you can exit Remote Retrieval.

Retrieving fax messages

- 1 Dial your fax number.
 - 2 When your MFC answers, immediately enter your Remote Access Code (3 digits followed by *). If you hear one long beep, you have messages.
 - 3 As soon as you hear two short beeps, use the dial pad to press **962**.
 - 4 Wait for the long beep, and then use the dial pad to enter the number of the remote fax machine where you want your fax messages sent to followed by **##** (up to 20 digits).
-  You cannot use * and # as dial numbers. However, press # if you want to store a pause.
- 5 Hang up after you hear your MFC beep. Your MFC will call the other machine, which will then print your fax messages.

Changing your Fax Forwarding number

You can change the default setting of your fax forwarding number from another telephone or fax machine using Touch Tone.

- 1 Dial your fax number.
 - 2 When your MFC answers, immediately enter your Remote Access Code (3 digits followed by *). If you hear one long beep, you have messages.
 - 3 When you hear two short beeps, use the dial pad to press **954**.
 - 4 Wait for the long beep, and then use the dial pad to enter the new number of the remote fax machine where you want your fax messages forwarded followed by **##** (up to 20 digits).
-  You cannot use * and # as dial numbers. However, press # if you want to store a pause.
- 5 Hang up after you hear your MFC beep.

9 Printing reports

MFC settings and activity

You need to set up the Transmission Verification Report and Journal Period in the menu table.

Press **Menu, 2, 4, 1.**

—OR—

Press **Menu, 2, 4, 2.**

24.Report Setting
1.Transmission
2.Journal Period
Select ▲▼ & Set

Customizing the Transmission Verification Report



You can use the Transmission Report as proof that you sent a fax. This report lists the time and date of transmission and whether the transmission was successful (OK). If you select **On** or **On+Image**, the report will print for every fax you send.

If you send a lot of faxes to the same place, you may need more than the job numbers to know which faxes you must send again. Selecting **On+Image** or **Off+Image** will print a section of the fax's first page on the report to help you remember.



When the feature is **OFF**, the Report will only print it there is a transmission error. (NG).

1 Press **Menu, 2, 4, 1.**

2 Press  or  to select **Off**, **Off+Image**, **On** or **On+Image**.

Press **Set**.

3 Press **Stop/Exit**.



24.Report Setting
1.Transmission
▲ On
▼ On+Image
Select ▲▼ & Set

Setting the Journal Period

You can set the MFC to print a journal at specific intervals (every 50 faxes, 6, 12 or 24 hours, 2 or 7 days). If you set the interval to **Off**, you can print the report by following the Steps on the next page.

The default setting is **Every 50 Faxes**.

1 Press **Menu, 2, 4, 2**.

2 Press  or  to choose an interval.

Press **Set**.

(If you choose 7 days, the LCD will ask you to choose a day on which to begin the 7-day countdown.)

3 Enter the time to begin printing in 24-hour format.

Press **Set**.

(For example: enter 19:45 for 7:45 PM.)

4 Press **Stop/Exit**.

 If you select 6, 12, 24 hours, 2 or 7 days, the MFC will print the report at the selected time and then erase all jobs from its memory. If the MFC's memory becomes full with 200 jobs before the time you selected has passed, the MFC will print the Journal early and then erase all jobs from memory. If you want an extra report before it is due to print, you can print it without erasing the jobs from memory.

 If you select **Every 50 Faxes**, the MFC will print the Journal when the MFC has stored 50 jobs.

24.Report Setting
2.Journal Period
▲ Every 50 Faxes
▼ Every 6 Hours
Select ▲▼ & Set



Printing reports

Five reports are available:

- | | |
|-----------------|---|
| 1. Help List | Prints the Help List so you can see at-a-glance how to quickly program your MFC. |
| 2. Quick-Dial | Lists names and numbers stored in the One-Touch and Speed-Dial memory, in numerical order. |
| 3. Journal | Lists information about the last incoming and outgoing faxes.
(TX means Transmit.) (RX means Receive.) |
| 4. XMIT Verify | Prints a Transmission Verification Report for your last transmission. |
| 5. System Setup | Lists your settings. |
| 6. Order Form | You can print an accessories order form to fill out and send to Brother dealer. |

To print a report

1 Press **Menu**, **5**.

2 Press  or  to select the report you want.

Press **Set**.

—**OR**—

Enter the number of the report you want to print.

For example, press **1** to print the Help List.



3 Press **Start**.

10 Making copies

Using the MFC as a copier

You can use your MFC as a copier, making up to 99 copies at a time.

Enter Copy mode

Before making copies, make sure that  (**Copy**) is illuminated in green. If it is not, press  (**Copy**) to enter **Copy** mode. The default setting is Fax. You can change the number of seconds or minutes that the MFC stays in Copy mode after a copy operation. (See *Setting the Mode Timer* on page 4-5.)

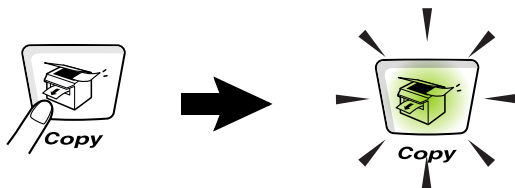

The printable area of your MFC begins at approximately 2 mm from the both ends and 3 mm from the top or bottom of the paper.

Ex: A4 (Document) → A4 (Paper)

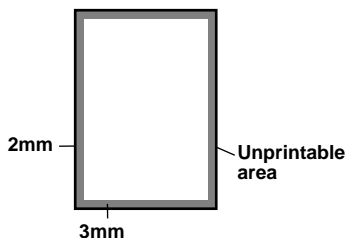

Temporary copy settings

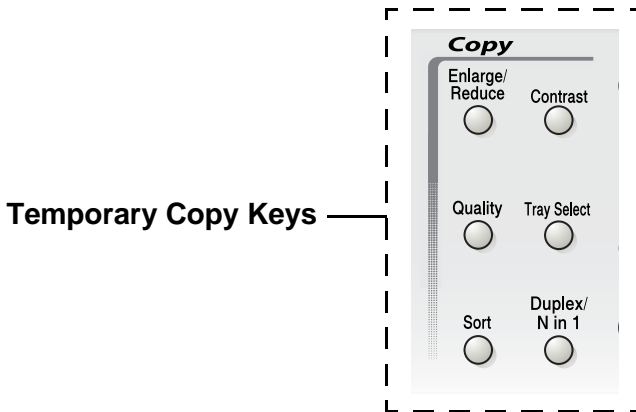

You can improve your copies by using the Temporary Copy Keys: **Enlarge/Reduce**, **Contrast**, **Quality**, **Tray Select**, **Sort** and **N in 1** (For MFC-8420) or **Duplex/N in 1** (For MFC-8820D). These settings are temporary, and the MFC returns to Fax mode 1 minute after it finishes copying. If you want to use these temporary settings again, place the next document in the ADF or on the scanner glass within that time.

However, if you have set the Mode Timer for Copy and Scan modes to 0 or 30 seconds, the MFC returns to the default settings after the number of seconds that has been set for Mode Timer. (See *Setting the Mode Timer* on page 4-5 and *Using the Copy keys (Temporary settings)* on page 10-6.)





 While the MFC is copying, incoming faxes will be received into the memory instead of being printed.

Making a single copy from the ADF

- 1 Press  (**Copy**) to illuminate it in green. Place the document face up in the ADF.
 - 2 Press **Start**.
Do **NOT** pull on the document while copying is in progress.
-  To stop copying and eject the document, press **Stop/Exit**.

Making multiple copies from the ADF

- 1 Press  (**Copy**) to illuminate it in green. Insert the document face up in the ADF.
 - 2 Use the dial pad to enter the number of copies you want (up to 99).
 - 3 Press **Start**.
-  To sort the copies, press the **Sort** key.

Single or multiple copies using the scanner glass

You can make multiple copies using the scanner glass. Multiple copies will be stacked (all copies of page 1, then all copies of page 2, and so on). Use the Temporary Copy keys to choose more settings. (See *Using the Copy keys (Temporary settings)* on page 10-6.)

- 1 Press  (**Copy**) to illuminate it in green. Lift the Document Cover.

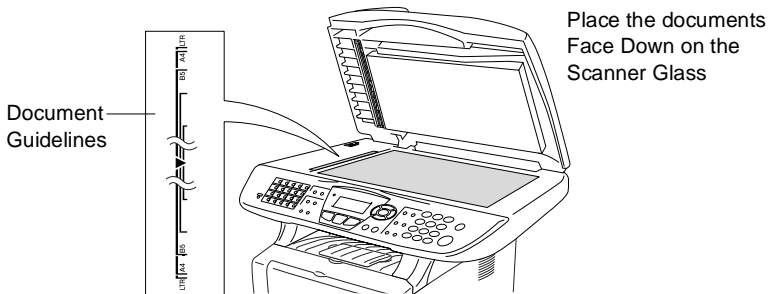

- 2 Using the document guidelines on the left, center the document face down on the scanner glass and close the document cover.
- 3 Using the dial pad, enter the number of copies you want (up to 99).
For example, press **3 8** for 38 copies.
- 4 Press **Start**.
The MFC will start scanning the document.

 If you want to sort multiple copies, use the ADF.
(See *Making a single copy from the ADF* on page 10-3.)

Out of Memory message

If the Out of Memory message appears, press **Stop/Exit** to cancel or press **Start** to copy scanned pages. You will need to clear some jobs from the memory before you can continue.

Out of Memory
Copy: Press Start
Quit: Press Stop



To gain extra memory, you can turn off Fax Storage.
(See *Setting Fax Storage* on page 8-2.)

—OR—

Print the faxes that are in the memory.
(See *Printing a fax from the memory* on page 5-7.)

When you get an Out of Memory message, you may be able to make copies if you first print incoming faxes in the memory to restore the memory to 100%.



Then if this error message appears more than once you may wish to consider increasing the memory size. For more information on how to increase the memory size, see *Memory board* on page 23-1.

Using the Copy keys (Temporary settings)

When you want to change the settings only for the next copy, use the Temporary Copy keys.

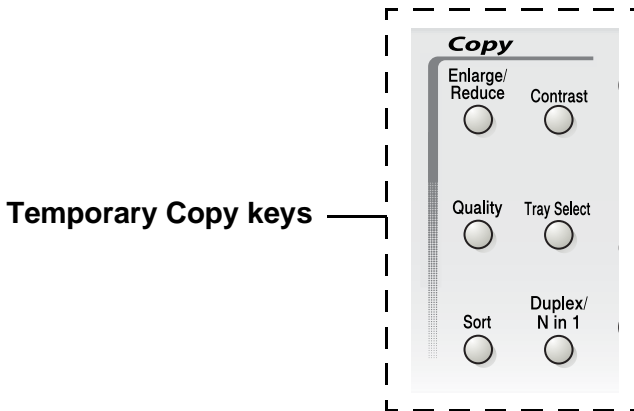

You can use different combinations. The large LCD shows your current Copy mode settings.

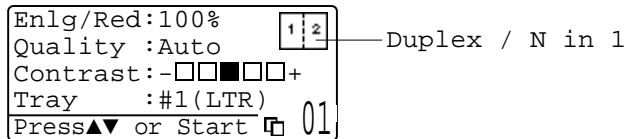

Example of Copy mode LCD

Enlarge/Reduce



You can select the following enlargement or reduction ratios.

Auto sets the MFC to calculate the reduction ratio that fits the size of your paper.

Custom allows you to enter a ratio from 25% to 400%.



Press Enlarge/Reduce	
	100%
	104% (EXE → LTR)
	141% (A5 → A4)
	200%
	Auto
	Custom (25 - 400%)
	50%
	70% (A4 → A5)
	78% (LGL → LTR)
	83% (LGL → A4)
	85% (LTR → EXE)
	91% (Full Page)
	94% (A4 → LTR)
	97% (LTR → A4)

 Auto appears only when you place the document in the ADF.

- 1 Press  (**Copy**) to illuminate it in green. Place the document face up in the ADF, or face down on the scanner glass.
- 2 Use the dial pad to enter the number of copies you want (up to 99).
- 3 Press **Enlarge/Reduce**.
- 4 Press **Enlarge/Reduce** or .

Enlg/Red:100%
Quality :Auto
Contrast:-□□■□□+
Tray :#1(A4)

01

5 Press  or  to select the enlargement or reduction ratio you want.

Press **Set**.

—OR—

You can select **Custom** and press **Set**.

Use the dial pad to enter an enlargement or reduction ratio from 25% to 400%.

Press **Set**.

(For example, press **5 3** to enter 53%.)

6 Press **Start**.

—OR—

Press other temporary copy keys for more settings.





■ Special Copy Options (2in1, 4in1 or Poster) are not available with **Enlarge/Reduce**.

■ **Auto** is not available with the scanner glass.

Quality (type of document)

You can select the Quality for your type of document. The default setting is **Auto**, which is used for documents that contain both text and photographs. **Text** is used for documents containing only text. **Photo** is used for copying photographs.

- 1 Press  (**Copy**) to illuminate it in green. Place the document face up in the ADF, or face down on the scanner glass.
- 2 Use the dial pad to enter the number of copies you want (up to 99).
- 3 Press **Quality**.
- 4 Press  or  to choose the type of document (**Auto**, **Text** or **Photo**).
Press **Set**.
- 5 Press **Start**.
—OR—
Press other Temporary Copy keys for more settings.



Sorting copies using the ADF

If you want to sort multiple copies, use the ADF. Pages will be printed in the order 123, 123, 123, and so on.

- 1 Press  (**Copy**) to illuminate it in green. Place the document face up in the ADF.
- 2 Use the dial pad to enter the number of copies you want (up to 99).
- 3 Press **Sort**.
- 4 Press **Start**.
—OR—
Press other Temporary Copy keys for more settings.

Contrast

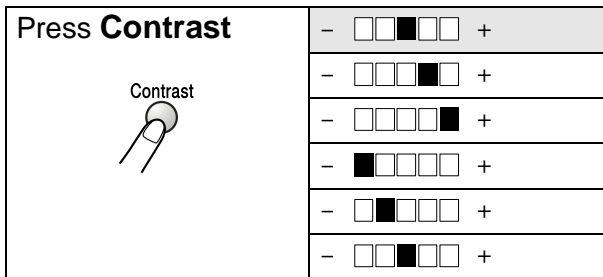

You can adjust copy contrast to make copies darker or lighter.

- 1 Press  (**Copy**) to illuminate it in green. Place the document face up in the ADF, or face down on the scanner glass.
- 2 Use the dial pad to enter the number of copies you want (up to 99).
- 3 Press **Contrast**.
- 4 Press  to make a copy lighter.
—OR—
Press  to make a copy darker.
Press **Set**.
- 5 Press **Start**.
—OR—
Press other Temporary Copy keys for more settings.



Tray Select

You can change the tray use only for the next copy.

- 1 Press  (**Copy**) to illuminate it in green. Place the document face up in the ADF, or face down on the scanner glass.
- 2 Use the dial pad to enter the number of copies you want (up to 99).
- 3 Press **Tray Select**.
- 4 Press  or  to select the tray usage.
Press **Set**.
- 5 Press **Start**.
—OR—
Press other Temporary Copy keys for more settings.

(For MFC-8420 with the optional paper tray #2)

Press Tray Select Tray Select 	Auto
	#1 (XXX)*
	#2 (XXX)*

(For MFC-8820D with the optional paper tray #2)

















Press Tray Select Tray Select 	Auto
	#1 (XXX)*
	#2 (XXX)*
	MP Tray

* XXX is the paper size you set in **Menu, 1. 3**.

 For MFC-8420 the LCD displays the tray use selections only if the optional paper tray is installed.

Duplex/N in 1

'Duplex' prints on both sides of the paper.



Temporary key	Level 1	Level 2	Option	document → Finished Layout	
Press Duplex/N in 1 (MFC-8820D) N in 1 (MFC-8420) Duplex/ N in 1 	N in 1	—	2 in 1 (P)	 → 	
			2 in 1 (L)	 → 	
			4 in 1 (P)	 → 	
			4 in 1 (L)	 → 	
	Duplex(1 in 1) (MFC-8820D)	Portrait1	—	—	 → 
				Portrait2	Single Sided
		Landscape1	—	Single Sided	 → 
				Double Sided	 → 
		Landscape2	—	—	 → 

Temporary key	Level 1	Level 2	Option	document → Finished Layout
Press Duplex/N in 1 (MFC-8820D) N in 1 (MFC-8420) Duplex/ N in 1 	Duplex(2 in 1) (MFC-8820D)	—	Portrait1	→
			Portrait2	→
			Landscape1	→
			Landscape2	→
	Duplex(4 in 1) (MFC-8820D)	—	Portrait1	→
			Portrait2	→
			Landscape1	→
			Landscape2	→
	Poster	—		→
	Off	—	—	—

Duplex/N in 1 copy

N in 1 copy

You can save paper by copying either two or four pages onto one page. Please make sure paper size is set to A4, Letter or Legal.

- 1 Press  (**Copy**) to illuminate it in green. Place the document face up in the ADF, or face down on the scanner glass.
- 2 Use the dial pad to enter the number of copies you want (up to 99).
- 3 Press **Duplex/N in 1**.
Press **Set** to select N in 1.
- 4 Press  or  to select 2 in 1 (P), 2 in 1 (L), 4 in 1 (P) or 4 in 1 (L).



Press **Set**.

- 5 If you are ready to copy, go to Step 7.

—OR—

Press  or  to select Quality, Contrast or Tray.

Press **Set**.

- 6 Press  or  to select a new setting.

Press **Set**.

- 7 Press **Start**.

If you are using the ADF, the MFC scans the originals and prints the copies.

—OR—

If you are using the scanner glass, the MFC scans the page. Place the next original on the scanner glass.

- 8 Select **1** and press **Set**, or press **1**, to copy next page.

- 9 Repeat Step 7 and 8 for each page of the layout.

Enlg/Red:100%
Quality :Auto
Contrast:- 00000 +
Tray :#1(LTR)
Press▲▼ or Start 01

Flatbed Copy:
Next Page?
▲ 1.Yes
▼ 2.No
Select▲▼ & Set

10 After all the pages of the document have been scanned, select **2** and press **Set**, or press **2**, to print the copies.



(P) means Portrait and (L) means Landscape.



You can also combine the N in 1 and Duplex operations. (See *Duplex (2 in 1) and Duplex (4 in 1) (For MFC-8820D)* on page 10-19.)





For 2 in 1 (P), 2 in 1 (L), 4 in 1 (P) or 4 in 1 (L), you can not use the Enlarge/Reduce setting.

Poster

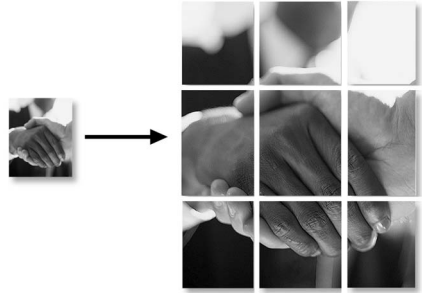
You can make a poster size copy of a photograph. You must use the scanner glass.



- 1 Place the original face down on the scanner glass.
- 2 Press **Duplex/N in 1** and  or  to select Poster.
Press **Set**.
- 3 Press **Start**.





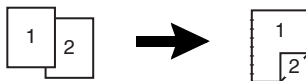

The MFC starts scanning the original and prints the pages for the poster.

 For poster copies, you cannot make more than one copy or use the Enlarge/Reduce setting.

Duplex (1 in 1) (For MFC-8820D)







Make a double-sided copy from a single-sided document

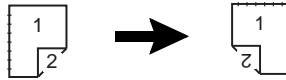





- 1** Press  (**Copy**) to illuminate it in green. Place the document face up in the ADF, or face down the scanner glass.
- 2** Use the dial pad to enter the number of copies you want (up to 99).
- 3** Press **Duplex/N in 1** and  or  to select Duplex(1 in 1).
Press **Set**.
- 4** Press  or  to select Portrait1, Portrait2, Landscape1 or Landscape2.
—OR—
If you select Portrait1 or Landscape2, go to Step6.
Press **Set**.
- 5** Press  or  to select Single Sided for the document (If you are using the scanner glass or changed the number of copies at Step 2, this option will not appear).
Press **Set**.
- 6** Press **Start** to scan the document.
If you placed the document in the ADF, the MFC starts printing.
—OR—
If you placed the document on the scanner glass, go to Step 7.
- 7** Place the next document on the scanner glass.
Select **1** and press **Set** or press **1** to copy next page.
After all the pages of the document have been scanned, select **2** and press **Set**, or press **2** to print.

Make a double-sided copy from a double-sided document (Not available for multiple copies)



- 1 Press  (**Copy**) to illuminate it in green. Place the document face up in the ADF.
- 2 Press **Duplex/N in 1** and  or  to select Duplex(1 in 1).
Press **Set**.
- 3 Press  or  to select Portrait2 or Landscapel1.
Press **Set**.
- 4 Press  or  to select Double Sided for the document.
Press **Set**.
- 5 Press **Start**.
- 6 Make sure that you have put the documents in the ADF as shown on the LCD and press **Start**.
- 7 After all the pages of the document have been scanned on one side, turn the other side of the document face up in the ADF.
Press **Start**.

Duplex (2 in 1) and Duplex (4 in 1) (For MFC-8820D)



- 1 Press  (**Copy**) to illuminate it in green. Place the document face up in the ADF, or face down on the scanner glass.
- 2 Use the dial pad to enter the number of copies you want (up to 99).
- 3 Press **Duplex/N in 1** and  or  to select Duplex(2 in 1) or Duplex(4 in 1).
Press **Set**.
- 4 Press  or  to select Portrait1, Portrait2, Landscape1 or Landscape2.
Press **Set**.
- 5 Press **Start** to scan the document.
If you placed the document in the ADF, the MFC starts printing.
—OR—
If you placed the document on the scanner glass, go to Step 6.
- 6 Place the next document on the scanner glass.
Select **1** and press **Set** or press **1** to copy next page.
- 7 After all the pages of the document have been scanned, select **2** and press **Set** or press **2** to print.

Changing the default copy settings

You can adjust the copy settings that are shown in the chart. These settings will stay until you change them again.

Submenu	Menu Selections	Options	Factory Settings
1.Quality	—	Text	Auto
		Photo	
		Auto	
2.Contrast	—	- □□□□ + - □□□□ + - □□□□ + - □□□□ + - □□□□ +	- □□□□ +



Quality

- 1 Press **Menu, 3, 1.**
- 2 Press  or  to select Text, Photo Or Auto.
Press **Set.**
- 3 Press **Stop/Exit.**



Contrast

You can change the contrast to help an image look lighter or darker.

- 1 Press **Menu, 3, 2.**
- 2 Press  to make lighter.
—OR—
Press  to make darker.
Press **Set.**
- 3 Press **Stop/Exit.**

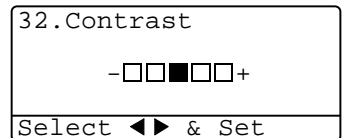

11 Using the MFC as a printer

Using the Brother MFC-8420, MFC-8820D printer driver

A Printer Driver is software that translates data from the format used by a computer into the format required by a particular printer, using a printer command language or page description language.

The printer drivers are on the CD-ROM we have supplied. Install the drivers first by following the Quick Setup Guide. Also, the latest printer driver can be downloaded from the Brother Solutions Center at:

<http://solutions.brother.com>

Windows® Printing

The dedicated printer driver and TrueType™ compatible fonts for Microsoft® Windows® 95/98/98SE/Me/2000 Professional/XP and Windows NT® workstation 4.0 are available on the CD-ROM supplied with your MFC. You can install them easily into your Windows® system using our installer program. The driver supports our unique compression mode to enhance printing speed in Windows® applications, and allows you to set various printer settings, including economy printing mode and custom paper size.

Popular Printer Emulation Support

The MFC supports HP LaserJet (PCL level 6) and BR-Script 3 (Post Script 3) printer emulation mode. If you use DOS application software, you can use HP LaserJet (PCL level 6) and BR-Script 3 (Post Script 3) emulation mode for printer operations.

How to print your document

When the MFC receives data from your computer, it begins printing by picking up paper from the paper tray. The paper tray can feed many types of paper and envelopes.

1 From your computer select the Print command.

If your computer is also connected to any other printers, select **Brother MFC-8420** or **MFC-8820D (USB) Printer** as your printer driver from the Print or Print Settings menu in your software application, and then click on OK to begin printing.

2 Your computer sends a print command and data to the MFC.

3 The LED blinks in yellow and the MFC starts to print.



You can select the paper size, and orientation in your application software.

If your application software does not support your custom paper size, select the next largest paper size.

Then adjust the print area by changing the right and left margins in your application software.

Simultaneous printing and faxing

Your MFC can print from your computer while sending or receiving a fax, and scanning the document into the computer. Fax sending will not be stopped during PC printing.

Two-sided printing (Duplex Printing)

The supplied printer driver supports duplex printing. (For more information, see *Duplex Printing* on page 12-6.)

Automatic Duplex Printing (For MFC-8820D)

In this mode, the MFC prints on both sides of the A4, Letter or Legal paper automatically.

- 1 Open the Properties dialog box in the printer driver.
- 2 Select Duplex Printing mode in the Advanced tab, make sure that '**Use Duplex Unit**' has been selected, and then click the **OK** button. (See *Duplex Printing* on page 12-6.) The printer will print on both sides of the paper automatically.



- When you select **Use Duplex Unit**, HQ1200 is not available.
- If you also want to use Duplex Printing for fax and copy operations, see *To use Automatic Duplexing for fax, copy and print operations (For MFC-8820D)* on page 2-11.

Manual Duplex Printing

The MFC prints all the even-numbered pages on one side of the paper first.

Then, the Windows® driver instructs you (with a pop-up message) to reinsert the paper. Before reinserting the paper, straighten it well, or you may get a paper jam. Very thin or very thick paper is not recommended.

We recommend 75 to 90 gsm paper.

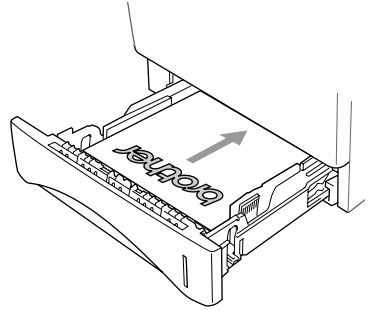

Face-down output tray

The MFC ejects paper with printed surfaces *face down* into the output tray in the front of the MFC. Unfold the support flap to support the printed pages.



When printing transparencies, remove each one from the support flap after it exits the MFC.

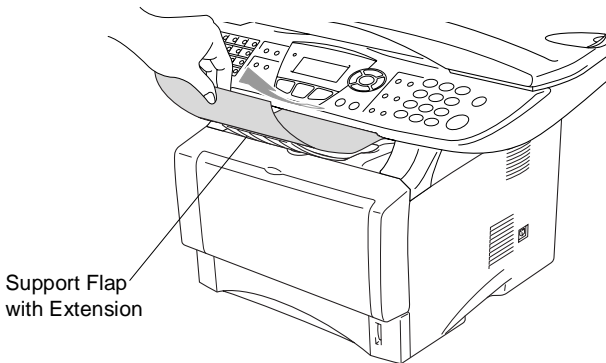

Printing on plain paper

The manual feed tray (For MFC-8420)



The MFC automatically turns on the Manual Feed mode when you put paper in the manual feed tray.

- 1 Select the **Paper Size**, **Media Type**, **Paper Source**, and other settings in the printer driver.

Media Type: Plain Paper

Paper Source: Manual

- 2 Send the print data to the MFC.
- 3 Open the manual feed tray. Slide the paper guides to fit the paper size.

- 4 Using both hands put paper in the manual feed tray until the front edge of the paper touches the paper feed roller and the MFC grips the paper.

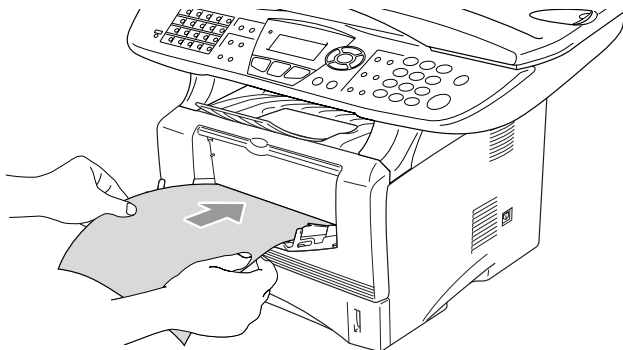



- Make sure that the paper is straight and in the proper position on the manual feed tray. If it is not, the paper may not be fed properly, resulting in a skewed printout or a paper jam.
 - Do not put more than one piece of paper in the manual feed tray at any one time, or it may cause a jam.
- 5 After the printed page comes out of the MFC, put in the next sheet of paper as in Step 4 above. Repeat for each page that you want to print.

The MP tray (For MFC-8820D)

- 1 Select the **Paper Size**, **Media Type**, **Paper Source**, and other settings in the printer driver.
Media Type: Plain Paper
Paper Source: MP Tray
- 2 Open the MP tray and lower it gently.
- 3 Pull out the MP tray support flap.

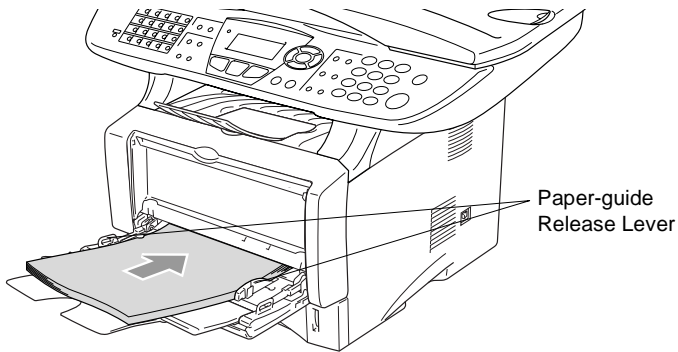
- 4** When loading paper in the MP tray, make sure it touches the back of the tray.



-  Make sure that the paper is straight and in the proper position on the MP tray. If it is not, the paper may not be fed properly, resulting in a skewed printout or a paper jam.

- 5** While pressing the paper-guide release lever, slide the paper guide to fit the paper size.

-  When you put paper in the MP tray, please remember the following:

- The side to be printed on must be face up.
- During printing, the inside tray rises to feed paper into the MFC.
- Put the leading edge (top of the paper) in first and push it gently into the tray.

- 6** Send the print data to the MFC.

Printing on thicker paper and card stock

When the back output tray is pulled down, the MFC has a straight paper path from the manual feed tray or the MP tray through to the back of the MFC. Use this paper feed and output method when you want to print on thicker (106 - 161 gsm) paper or card stock.

The manual feed tray (For MFC-8420)

- 1 Select the **Paper Size**, **Media Type**, **Paper Source**, and other settings in the printer driver.

Media Type: Thick paper or Thicker paper

Paper Source: Manual

- 2 Open the back output tray.

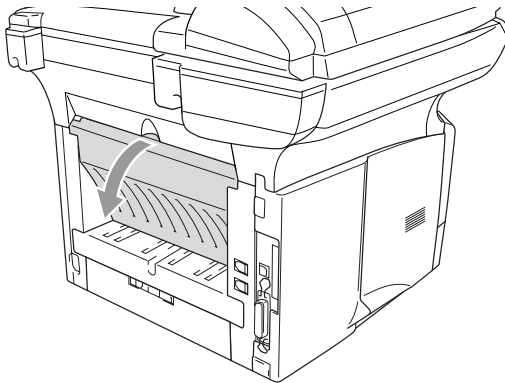

- 3 Open the manual feed tray. Slide the paper guides to fit the paper size.

4 Using both hands put the paper in the manual feed tray until the front edge of the paper touches the paper feed roller and the MFC grips the paper.



■ Make sure that the paper is straight and in the proper position in the manual feed tray. If it is not, the paper may not be fed properly, resulting in a skewed printout or a paper jam.

■ Do not put more than one piece of paper in the manual feed tray at any one time, or it may cause a jam.

5 Send the print data to the MFC.

6 After the printed page comes out of the MFC, put in the next sheet of paper as in Step 4 above. Repeat for each page that you want to print.

7 When you have finished the print job, close the back output tray.

! Caution

Remove each sheet immediately after printing. Stacking the sheets may cause a paper jam or the paper to curl.

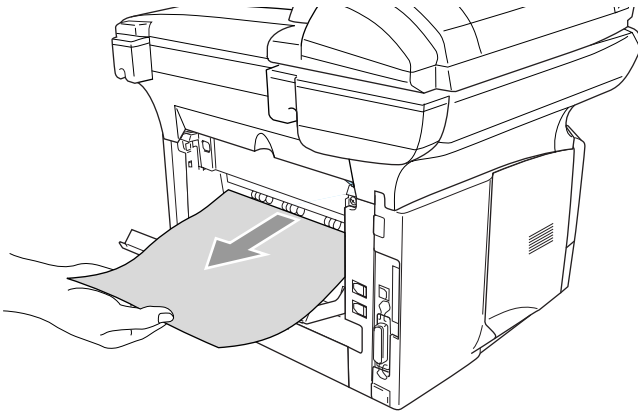

The multi-purpose tray (MP tray) (For MFC-8820D)

- 1 Select the **Paper Size**, **Media Type**, **Paper Source**, and other settings in the printer driver.

Media Type: Thick paper or Thicker paper

Paper Source: MP Tray

- 2 Open the back output tray, and then pull out the face-up output tray support if necessary.

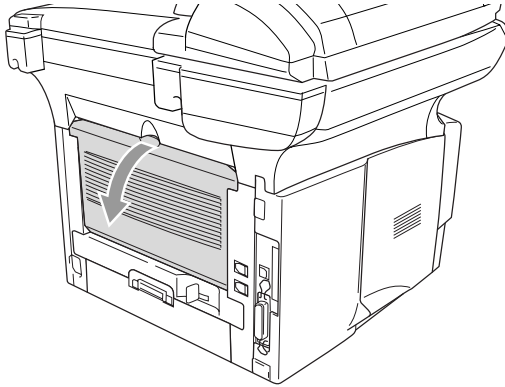

- 3 Open the MP tray and lower it gently.
- 4 Pull out the MP tray support flap.
- 5 When putting paper in the MP tray, make sure it touches the back of the tray.

 Make sure that the paper is straight and in the proper position in the MP tray. If it is not, the paper may not be fed properly, resulting in a skewed printout or a paper jam.

6 While pressing the paper-guide release lever, slide the paper guide to fit the paper size.



When you put paper in the MP tray, please remember the following;

- During printing, the inside tray rises to feed paper into the MFC.
- The side to be printed on must be face up.
- Put the leading edge (top of the paper) in first and push it gently into the tray.

7 Send the print data to the MFC.

8 When you have finished the print job, close the back output tray.

! **Caution**

Remove each sheet immediately after printing. Stacking the sheets may cause a paper jam or the paper to curl.

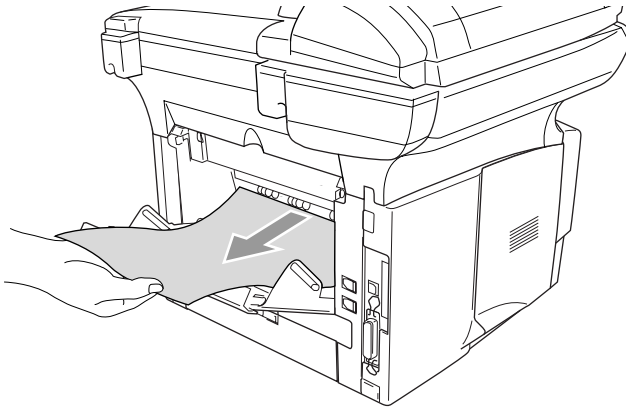

Printing on envelopes

To print on envelopes use manual feed tray or multi-purpose tray.



- The MFC automatically turns on the Manual Feed mode when you put paper in the manual feed tray.
- All sides should be properly folded without any wrinkles or creases.

1 Select the **Paper Size**, **Media Type**, **Paper Source**, and other settings in the printer driver.

Media Type: Envelope, Env.thin or Env.thick

For MFC-8420:

- 2 Open the back output tray.

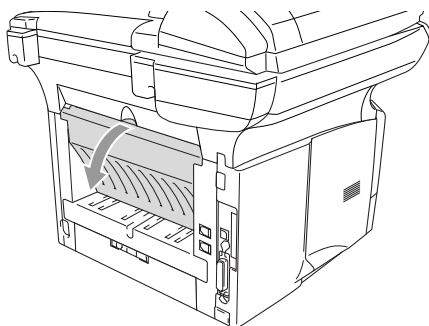

- 3 Open the manual feed tray. Slide the paper guides to fit the envelope size.



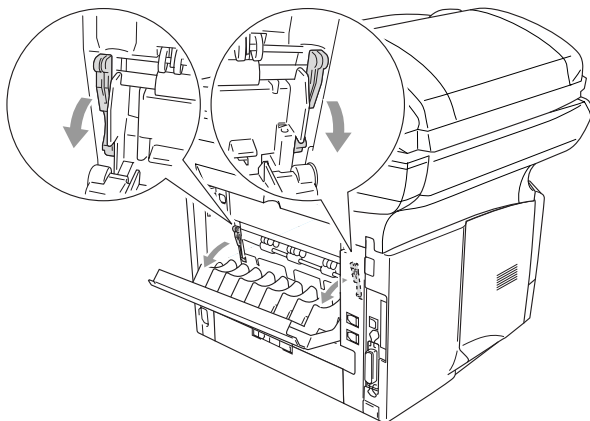

If envelopes are creased after they have been printed:

At the back of the MFC, open the back output tray and push down the blue tabs at the left and right hand sides (as shown in the figure on the next page). When you have finished printing your envelopes, close the back output tray to reset the two blue tabs back to their original position.

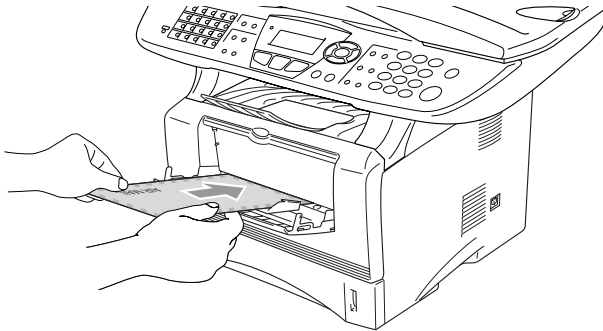

- 4** Using both hands put the envelope in the manual feed tray until the front edge of the envelope touches the paper feed roller and the MFC will grip the envelope.



-  ■ Make sure the envelope is straight as you insert it in the manual feed tray. If it is not, the envelope may not be fed properly, resulting in a skewed printout or a jam.
 - Do not put more than one envelope in the manual feed tray at any one time, or it may cause a jam.
 - Put the envelope in the manual feed tray, making sure that the side to be printed on is face up in the tray.
- 5** After the printed envelope comes out of the MFC, the MFC will wait until you put in the next envelope. Repeat Step 4 for each envelope you want to print.
- 6** Send the print data to the MFC.
- 7** After you finish the print job, close the back output tray.

For MFC-8820D:

- 2 Open the back output tray, and then unfold the face-up output tray support if necessary.

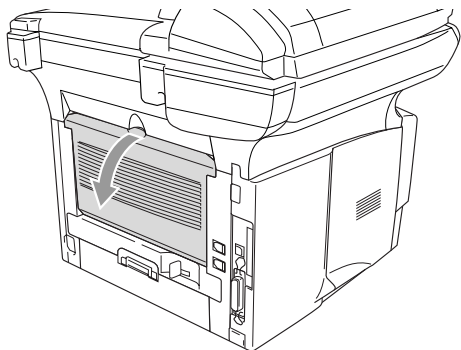

- 3 Open the MP tray and lower it gently.

- 4 Pull out the MP tray support flap.



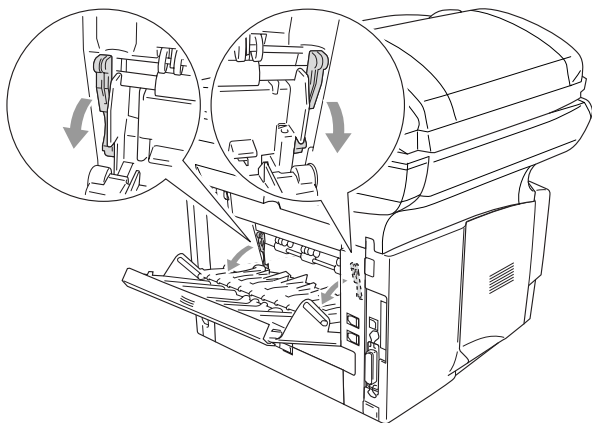

If envelopes are creased after they have been printed:

At the back of the MFC, open the back output tray and push down the blue tabs at the left and right hand sides (as shown in the figure on the next page). When you have finished printing your envelopes, close the back output tray to reset the two blue tabs back to their original position.

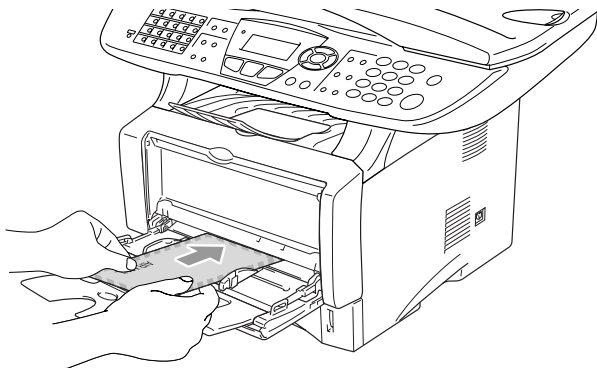

- 5** Put the envelopes in the MP tray so that they touch the back of the tray. Do not put more than 3 envelopes in the MP tray at any one time, or it may cause a jam.



-  Make sure that the envelopes are neatly stacked and in the proper position in the MP tray. If they are not, the envelopes may not be fed properly, resulting in a skewed printout or a jam.

- 6** Press and slide the paper-width guide to fit the envelope size.

-  When you put envelopes in the MP tray, please remember the following;

- During printing, the inside tray rises to feed envelopes into the MFC.
- The side to be printed on must be face up.
- Put the leading edge (top of the envelope) in first and push it gently into the tray.

- 7** Send the print data to the MFC.

- 8** After you finish the print job, close the back output tray.

Printer operation keys

Job Cancel

You can clear data from the memory.

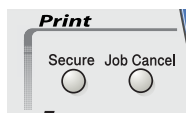

Secure key



Secured data is protected by a password. Only those people that know the password will be able to print the data. The MFC will not print secure data until the password is entered. After the document is printed, the data will be cleared from the memory. To use this function, you need to set your password in the printer driver dialog box. (See *Device Options* on page 12-11.)

 The **Secure** Key function is not available when using the Brother BR-Script driver.



1 Press **Secure**.

—OR—

The LCD displays `No Data !` if there is no secured data in the memory.

2 Press  or  to select the user name.

Press **Set**. The LCD displays job selections.

3 Press  or  to select the job.



Press **Set**. The LCD prompts you to enter your four-digit password.

```
Secure Print
  User?
▲  MIKE
▼  ANDY
-----
Select ▲▼ & Set
```

```
Secure Print
  Job?
▲  Test1
▼  Test2
-----
Select ▲▼ & Set
```



4 Enter your password using the control panel.

Press **Set**.

5 Press  or  to select Print.

Press **Set**. The MFC prints the data.

—OR—

If you want to delete the secured data press  or  to select Delete.

Press **Stop/Exit**.

Secure Print Test1
Password:XXXX
Enter & Set Key





■ If you turn the power switch Off, the secured data saved in memory will be cleared.

■ After you print the secured data it will be cleared from memory.

Setting the Emulation Selection

This MFC has an Automatic Emulation Selection function. When the MFC receives information from the PC, it automatically chooses the emulation mode. This function has been set at the factory to AUTO. You can change the default emulation mode manually by using the control panel.

1 Press **Menu, 4, 1**.

2 Press  or  to select Auto, HP LaserJet Or BR-Script 3.

Press **Set**.

3 Press **Stop/Exit**.

41.Emulation
▲ Auto
HP LaserJet
▼ BR-Script 3
Select ▲▼ & Set



Try this function with your application software or network server. If the function does not work properly, either select the required emulation mode manually using the MFC panel buttons or use the emulation selection commands in your software.

Printing the Internal Font List

You can print a list of the MFC's internal (or resident) fonts to see how each font looks before you select it.

- 1 Press **Menu, 4, 2, 1**.
- 2 Press **Start**. The MFC prints the list.
- 3 Press **Stop/Exit**.

42.Print Options 1.Internal Font
Press Start

Printing the Print Configuration List

You can print a list of current printer settings.

- 1 Press **Menu, 4, 2, 2**.
- 2 Press **Start**. The MFC prints the settings.
- 3 Press **Stop/Exit**.

42.Print Options 2.Configuration
Press Start

Restoring factory default settings

You can return the MFC to the original factory settings. Fonts and macros in the temporary settings are cleared.

- 1 Press **Menu, 4, 3**.
- 2 Press **1** to restore the factory settings.
—OR—

43.Reset Printer
▲ 1.Reset
▼ 2.Exit
Select ▲▼ & Set

Press **2** to exit without making a change.

- 3 Press **Stop/Exit**.



Only the printer settings will be returned to the original factory settings.

12 Printer driver settings

(Windows® Only)

Printer driver settings

You can change the following printer settings when you print from your computer:

- **Media Type**
- **Multiple Page**
- **Duplex**
- **Watermark***1*2
- **Scaling***2
- **Print Date & Time***1*2
- **Quick Print Setup***1*2
- **Secure Print***1

*1 These settings are not available with the BR-Script driver.

*2 These settings are not available with the Universal printer driver.

How to access the printer driver settings

- 1 Select **Print** from the **File** menu in your application software.
- 2 Select **Brother MFC-8420** or **MFC-8820D (USB) Printer** as your printer and click **Properties (Preference)**. The **Printing Preferences***3 dialog box will appear.



- The way you access the printer driver settings depends on your operating system and software applications.
- *3 The screens shown in this section are from Windows® XP. The screens on your Computer may vary depending on your Windows® Operating System.
- Some descriptions in this chapter are based on the MFC-8820D. These descriptions also apply to the MFC-8420.

Features in the Brother Native Driver

The Brother Native driver is a printer driver developed exclusively by Brother. This driver includes more features than the Microsoft® Windows® Universal printer driver.

Basic tab

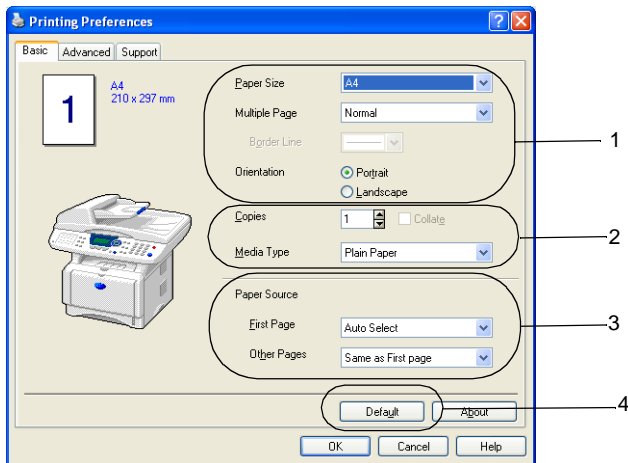

- 1 Select the **Paper Size**, **Multiple Page**, **Border Line** (if any) and **Orientation**.
- 2 Select number of **Copies** and **Media Type**.
- 3 Select **Paper Source** (**First Page** and **Other Pages**).
Auto Select allows the printer driver to select a suitable tray for **Paper Size** automatically.
You can set the paper size for each tray in the Accessories tab. (See *Accessories tab* on page 12-14.)
- 4 To return to the default settings, click the **Default** button.

Paper Size

From the drop-down box select the Paper Size you are using.

Multiple Page

The Multiple Page selection can reduce the image size of a page allowing multiple pages to be printed on one sheet of paper or enlarging the image size for printing one page on multiple sheets of paper.

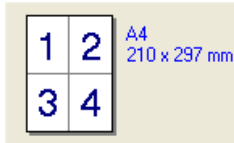

Ex. 4 in 1



Ex. 1 in 2 x 2 pages

Border Line

When printing multiple pages on one sheet with the Multiple Page feature you can select to have a solid border, dash border or no border around each page on the sheet.

Orientation

Orientation selects the position of how your document will be printed (**Portrait** or **Landscape**).



Portrait



Landscape

Copies

The copies selection sets the number of copies that will be printed.

Collate

With the **Collate** check box selected, one complete copy of your document will be printed and then repeated for the number of copies you selected. If the **Collate** check box is not selected, then each page will be printed for all the copies selected before the next page of the document is printed.

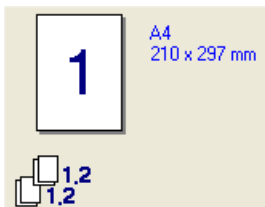

Collate box checked

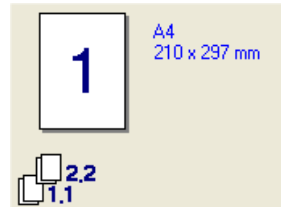

Collate box not checked

Media Type

You can use the following types of media in your MFC. For the best print quality, select the type of media that you wish to use.

Plain Paper

Thin Paper

Thick Paper

Thicker Paper

Bond Paper

Transparencies

Envelopes

Env. Thick

Env. Thin



When using ordinary plain paper (70 to 95 gsm), select **Plain Paper**. When using heavier weight paper, envelopes or rough paper select **Thick Paper** or **Thicker Paper**. For bond paper, select **Bond Paper** and for OHP transparencies, select **Transparencies**.

Advanced tab

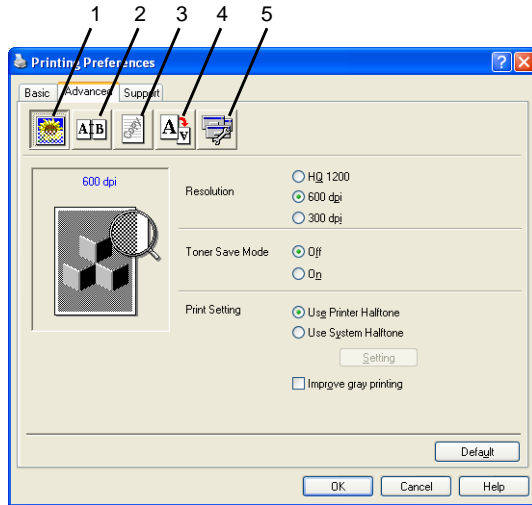

To return to the default settings, click the **Default** button.

Change the tab settings by selecting one of the following icons:

- 1 **Print Quality**
- 2 **Duplex**
- 3 **Watermark**
- 4 **Page Setting**
- 5 **Device Options**

Print Quality

Resolution

You can change the resolution as follows:

- HQ 1200
- 600 dpi
- 300 dpi



When you select **Use Duplex Unit**, HQ1200 is not available.

Toner Save Mode

You can save running costs by turning on the Toner Save Mode, which reduces the print density.

Print Setting

For Windows® 95/98/98SE/Me

Print Setting is used for optimizing your print quality for the type of document being printed (Photos, Graphics or Scanned Images). When you choose **Auto (Recommended)**, the printer automatically prints with the most suitable print settings.

With the Print Setting set to Manual, you can change the Brightness, Contrast and Graphics Quality options manually.

For Windows® 2000/XP/NT® WS 4.0

- Check **Use Printer Halftone** to print using Halftone.
- Check **Use System Halftone** to print using Halftone of the system. To change the setting, press **Setting**.
- If the halftone cannot be printed correctly, check **Improve gray printing**.

Duplex Printing

Choosing the Duplex Printing icon displays the Duplex features available.

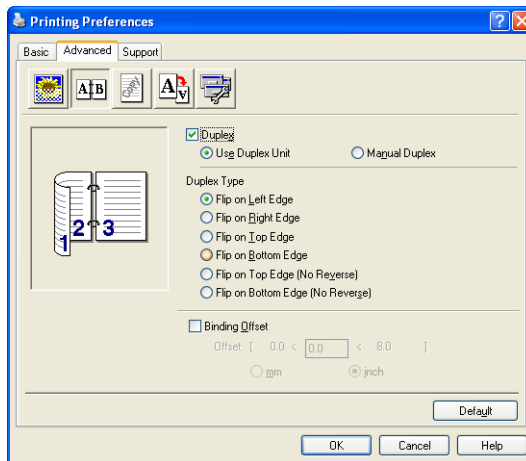

Use Duplex Unit (For MFC-8820D)

Check the Duplex box and then select **Use Duplex Unit**. In this mode the MFC prints on both sides of the paper automatically.

Manual Duplex

Check the Duplex box and then select **Manual Duplex**. In this mode, the MFC prints all the even numbered pages first. Then the printer driver stops and shows the instructions required to re-install the paper. When you click OK the odd numbered pages are printed.

Duplex Type

You can select **Duplex Type**. There are six types of duplex directions available for each orientation.

Flip on Left Edge



Flip on Right Edge



Flip on Top Edge



Flip on Bottom Edge



Flip on Top Edge (No Reverse)



Flip on Bottom Edge (No Reverse)



Binding Offset

Check the Binding Offset option, you can specify the offset value of the binding side in inches or millimeters (0 - 8 inches) [0 - 203.2 mm].

Watermark

You can place a logo or text into your document as a Watermark. You can select one of the preset Watermarks, or you can use a bitmap file or text file that you have created.

Check **Use Watermark**, and then select the watermark you want to use.

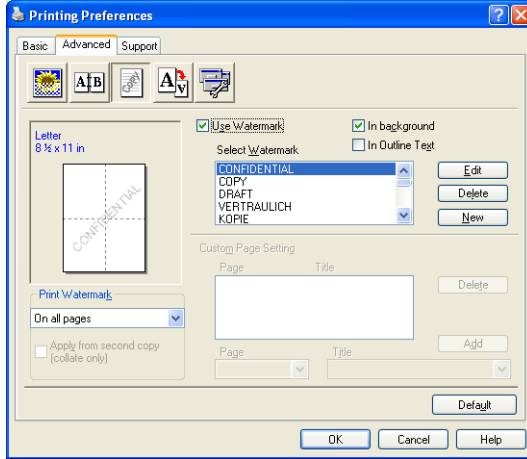

In background

Check **In background** to print the watermark image in the background of your document. If this feature is not checked then the Watermark will be printed on top of your document.

In Outline Text

(Window® 2000 Professional/XP/NT® WS 4.0 Only)

Check **In Outline Text** if you only want to print an outline of the watermark.

Print Watermark

The **Print Watermark** feature offers the following print choices:

- **On all pages**
- **On first page only**
- **From second page**
- **Custom**

Watermark Setting

You can change the Watermark's size and position on the page by selecting the Watermark, and clicking the **Edit** button. If you want to add a new Watermark, click the **New** button, and then select **Text** or **Bitmap** in the **Watermark Style**.

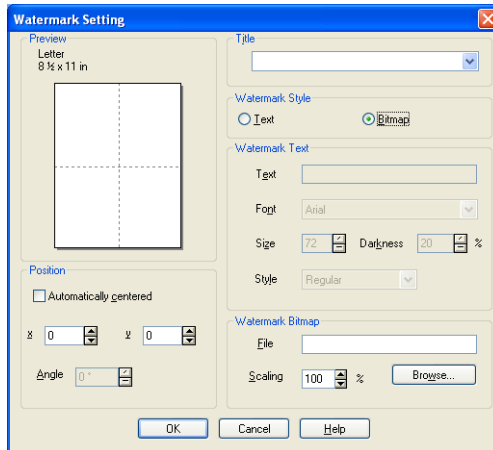

- **Title**

You can select the **CONFIDENTIAL**, **COPY** or **DRAFT** as the standard title or enter a title you like in the field.

- **Watermark Text**

Enter your Watermark text into the **Text** Box, and then select the **Font**, **Size**, **Darkness** and **Style**.

- **Watermark Bitmap**

Enter the file name and location of your bitmap image in the **File** box, or **Browse** for the file location. You can also set the scaling size of the image.

- **Position**

This setting offers you the control for where the Watermark is to be positioned on the page.

Page Setting

You can change the print size of your document with the Scaling feature.

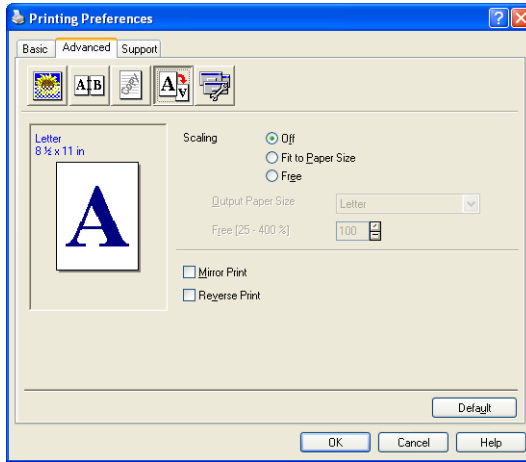

- Check **Off** if you want to print the document as it appears on your screen.
- Check **Fit to Paper Size**, if your document has an unusual size, or if you have only the standard size paper.
- Check the **Free** box if you want to manually reduce or enlarge the output.
- You can also use the **Mirror Print** or **Reverse Print** feature for your page setting.

Device Options

Lets you set the following Printer Functions:

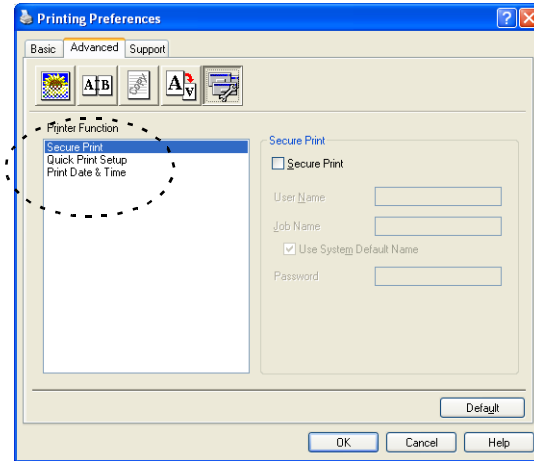

Secure Print

Secure documents are documents that are password protected when they are sent to the MFC. Only the people who know the password will be able to print them. Since the documents are secured at the MFC, you must use the control panel of the MFC (with the password) to print them.

To send a secured document:

- 1 Select **Secure Print** from **Printer Function** and check **Secure Print**.
- 2 Enter your password, user name and job name and click OK.
- 3 You must print the secured documents from the control panel of the MFC. (See *Secure key* on page 11-17.)

To delete a secured document:

- 1 You need to use the control panel of the MFC to delete a secured document. (See *Secure key* on page 11-17.)



You can store up to 8 MB of secured data in the MFC's memory.

Quick Print Setup

The Quick Print Setup feature allows you to quickly select driver settings. To view setting, simply click your mouse button on the task tray  icon. This feature can be set to ON or OFF from the Device Options section.

 The factory setting is OFF

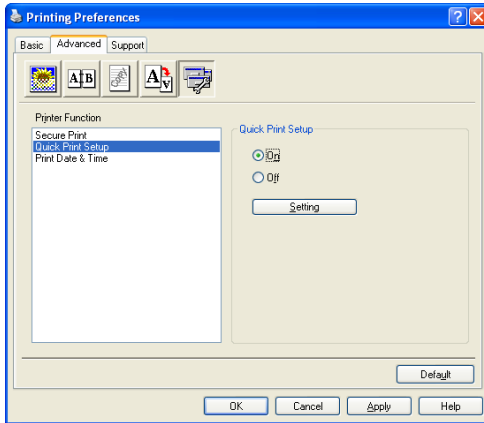

Administrator (For Windows® 95/98/98SE/Me Users Only)

The administrator selection permits the Copy, Scaling and Watermark features to be locked and password protected.

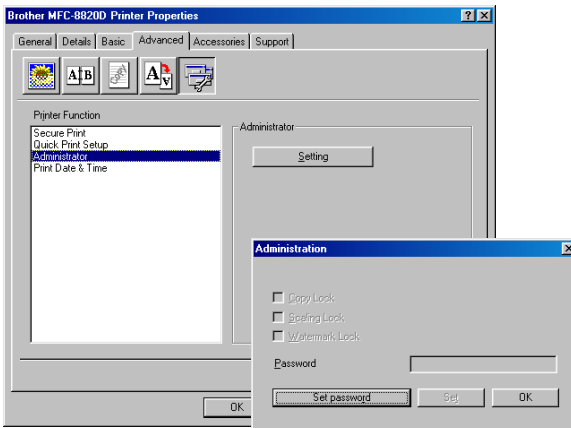

 Record your password and keep it in a safe place for future reference. If you forget your password these settings can not be accessed.

Print Date & Time

When enabled the **Print Date and Time** feature will automatically print the date and time from your computers system clock on your document.

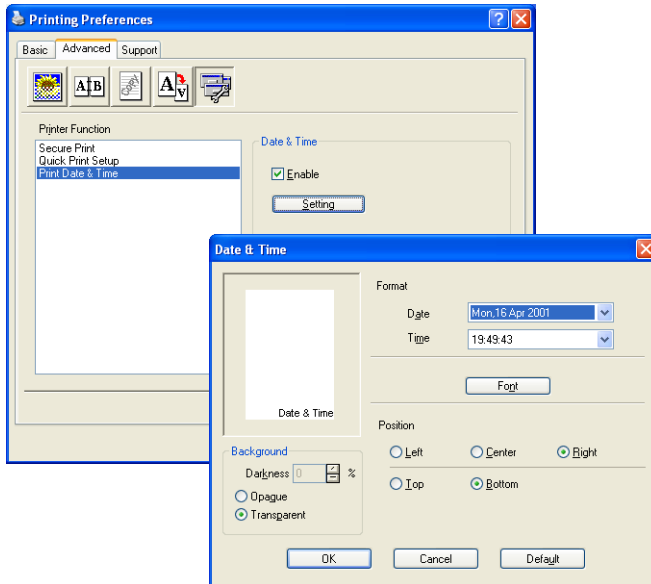

Click the **Setting** button to change the **Date** and **Time** Format. You can change the **Font** by clicking the **Font** button or the **Position**. To include a background with the **Date** and **Time** select **Opaque**. When **Opaque** is selected you can set the **Darkness** of the **Date** and **Time** background by changing the percentage.

 The Date and Time indicated in the selection box represents the format that will be printed. The actual Date and Time printed on your document is automatically retrieved from the settings of your computer.

Accessories tab

The **Accessories** Tab includes the settings for configuring the printer driver for the size of paper loaded in each paper source. This tab also installs any additional options into the driver settings.

Paper Source Setting

To configure the paper size for each paper source, highlight the source in the **Paper Source Setting** list. Select the **Paper Size** from the pull-down box and click **Update**. When Auto Select (default Paper Source) is set in the Basic tab of the printer driver (See *Basic tab* on page 12-2), the printer driver will automatically use the **Paper Source Setting** to select a tray which matches the **Paper Size** setting in the printer driver.

Default Source

The **Default Source** allows you to choose the paper source that will be used when the paper size of the document being sent does not match the Paper Source settings.

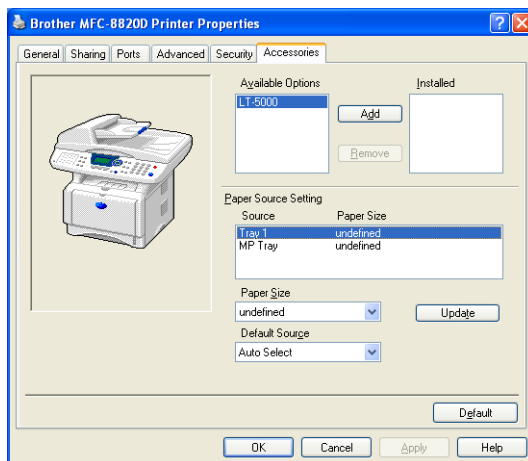

Available Options

In order to access the optional 2nd paper tray the option must be installed in the driver. Highlight the model number from the **Available Options** list and click **Add**. The optional tray will then be listed in the **Installed** box, **Paper Source Setting** list and the screen illustration will display the 2nd tray.

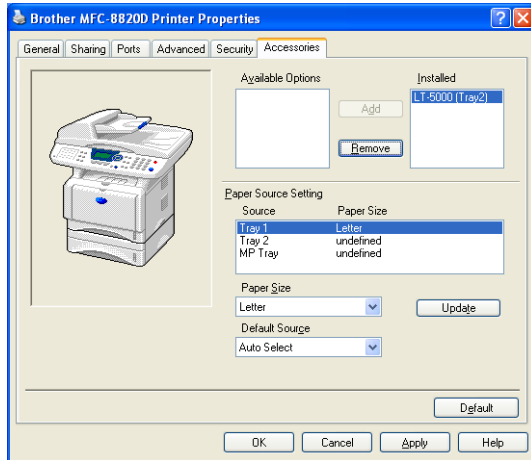

Support tab

The **Support** Tab provides driver version and setting information. In addition there are links to the **Brother Solutions Center** and the Driver Update Web sites.

Click the **Support** tab to display the following screen:



Brother Solutions Center

The **Brother Solutions Center** is a Web site offering information about your Brother product including FAQs (Frequently Asked Questions), User Guides, Driver Updates and Tips for using your MFC.

Web Update

Web Update checks the Brother web site for updated drivers, and automatically downloads and updates the printer driver on your computer.

Check Setting

The **Check Setting** selection displays a list of your current driver settings.

Features in the PS printer driver (For Windows®)

The Windows® 95/98/98SE/Me/2000 Professional/XP and Windows NT® 4.0 utilizes BR-Script 3(PostScript® 3 language emulation) driver.

To install the PS driver

If you have already installed the printer driver following the instruction in the Quick Setup Guide, insert the CD-ROM into the CD-ROM drive on your PC and click **Install Software**. Choose **MFL-Pro Suite** and follow the on-screen instructions. When the **Select Components** screen appears, check **PS Printer Driver**, and then continue following the on-screen instructions.

If you have not previously installed the driver and software, insert the CD-ROM into the CD-ROM drive on your PC and click **Install Software**. Choose **MFL-Pro Suite** and follow the on-screen instructions. When the **Setup Type** screen appears, select **Custom** and check the **PS Printer Driver**. Then continue following on-screen instructions.

You can download the latest driver by accessing the Brother Solutions Center at <http://solutions.brother.com>

For more information, please see the **help** text in the printer driver.



The screens in this section are from Windows® XP.

The screens on your PC will vary depending on your Operating System.

Ports tab

Select the port where your printer is connected or the path to the network printer you are using.

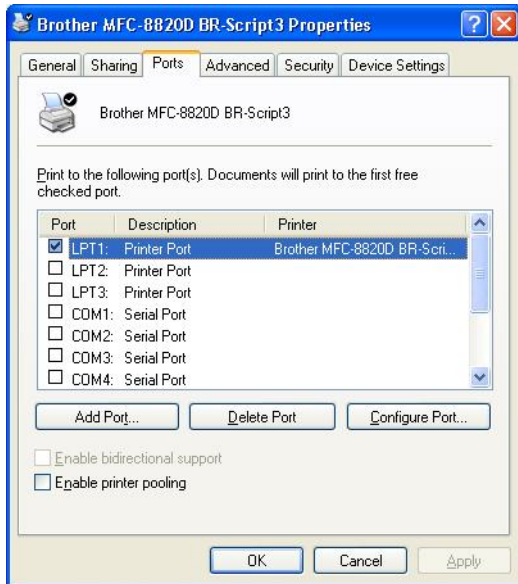

Device Settings tab

Select the options you installed.



Layout tab

 If you are using Windows NT[®] 4.0, Windows[®] 2000 or XP, you can access the **Layout** tab by clicking **Printing Preferences...** in the **General** tab of the **Brother BR-Script3 Properties** screen.

You can change the Layout setting by selecting the setting in the **Orientation**, **Page Order** and **Pages Per Sheet**.

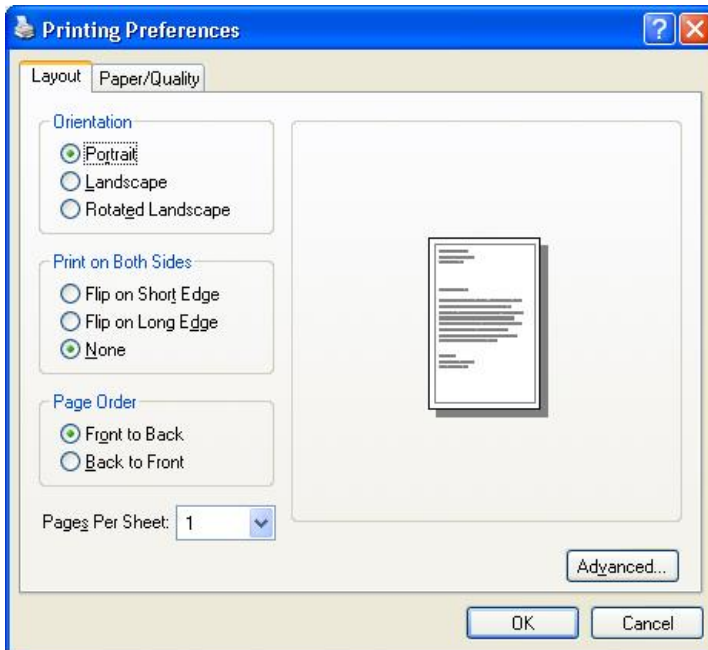

Booklet (For MFC-8820D) (For Windows[®] 2000/XP)

You can print a booklet by selecting **Booklet** from **Pages Per Sheet** list.

Paper/Quality tab

 If you are using Windows NT® 4.0, Windows® 2000 or XP, you can access the **Paper/Quality** tab by clicking **Printing Preferences...** in the **General** tab of the **Brother BR-Script3 Properties** screen.

Select the **Paper Source**.

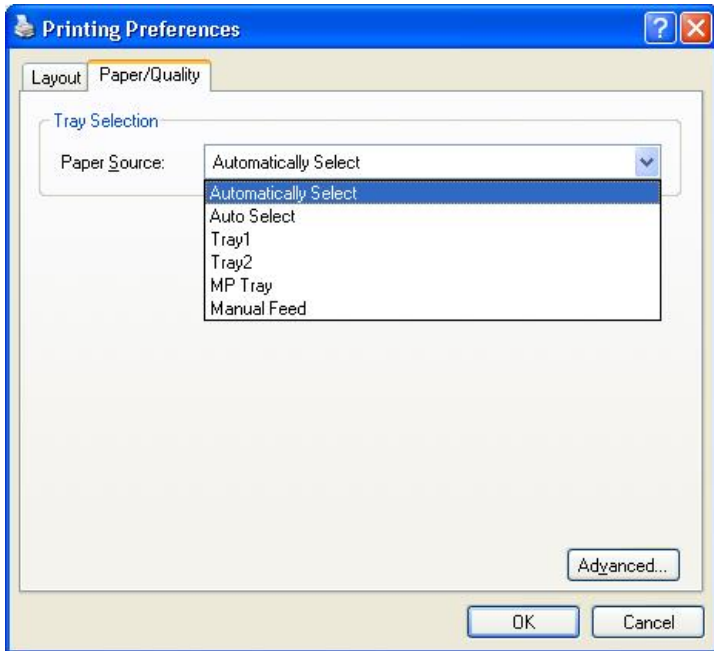

Advanced Options

 If you are using Windows NT[®] 4.0, Windows[®] 2000 or XP, you can access the **Advanced Options** tab by clicking **Advanced...** button in the **Layout** tab or the **Paper/Quality** tab.

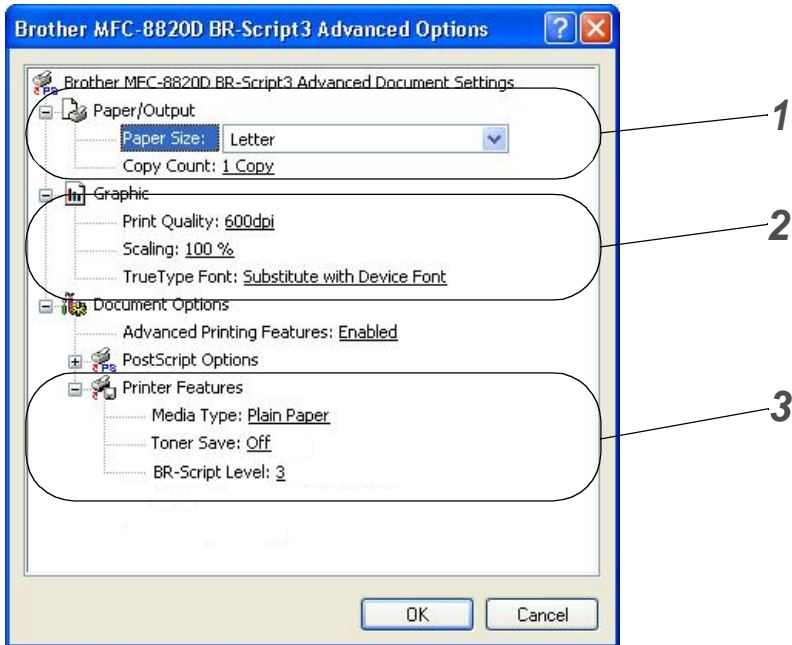

- 1 Select the **Paper Size** and **Copy Count**.
- 2 Set the **Print Quality**, **Scaling** and **TrueType Font** setting.
- 3 You can change settings by selecting the setting in the Printer Features list:
 - **Media Type**
 - **Toner Save**
 - **BR-Script Level**

13 How to scan using Windows®



The scanning operations and drivers will be different depending on your operating system.

For Windows® 95/98/98SE/Me/2000 Professional and Windows NT® Workstation 4.0

The MFC uses a TWAIN Compliant driver for scanning documents from your applications. (See *Scanning a document, TWAIN compliant* on page 13-1.)

For Windows® XP

The MFC uses Windows® Imaging Acquisition (WIA) for scanning documents. (See *Scanning a document (For Windows® XP only)* on page 13-10.)



For ScanSoft®, PaperPort® and TextBridge® OCR

Go to *Using ScanSoft® PaperPort® and TextBridge® OCR* on page 13-19.

Scanning a document

TWAIN compliant

The Brother MFL-Pro Suite software includes a TWAIN compliant scanner driver. TWAIN drivers meet the standard universal protocol for communicating between scanners and software applications. This means that not only can you scan images directly into the PaperPort® viewer that Brother included with your MFC, but you can also scan images directly into hundreds of other software applications that support TWAIN scanning. These applications include popular programs like Adobe® Photoshop®, Adobe® PageMaker®, CorelDraw® and many more.

How to access the Scanner

1 Open the software application (ScanSoft® PaperPort®) to scan a document.

 The instructions for scanning in this Guide are for when you use ScanSoft® PaperPort® 8.0SE.

2 Select **Scan** from the **File** drop-down menu or select the **Scan** button. The **Scan** pane appears in the left panel.

3 Select **Brother MFC-8820D**, **Brother MFC-8820D USB** or **Brother MFC-8820D LAN** from the **Scanner** drop-down list box.

 If the MFC is connected via:

Parallel-use **Brother MFC-8820D**

USB-use **Brother MFC-8820D USB**

LAN-use **Brother MFC-8820D LAN**

4 Click **Scan**.

The **Brother MFC-8820D**, **Brother MFC-8820D USB** or **Brother MFC-8820D LAN Scanner Setup** dialog box will appear:

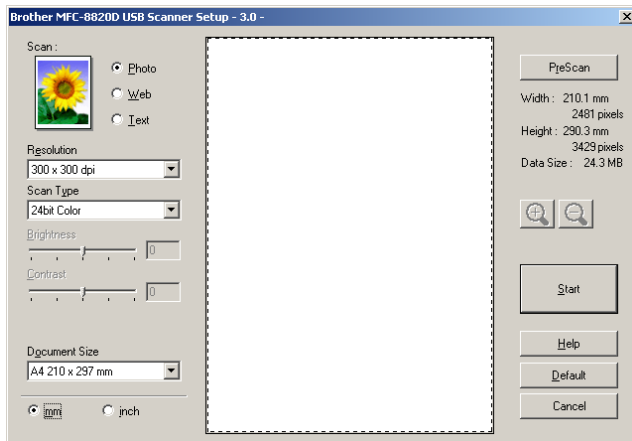

Scanning a document into the PC

You can scan a whole page

—OR—

Scan a portion of the page after pre scanning the document.

Scanning a whole page

- 1 Place the document face up in the ADF (automatic document feeder), or face down on the scanner glass.
- 2 Adjust the following settings, if required, in the Scanner window:
 - **Image Type**
 - **Resolution**
 - **Scan Type**
 - **Brightness**
 - **Contrast**
 - **Document Size**



After you select a document size, you can adjust the scanning area further by clicking the left mouse button and dragging it. This is required when you want to crop an image when scanning.

See *Settings in the Scanner window* on page 13-6.

- 3 Click the **Start** button in the scanner window. When scanning is completed, click **Cancel** to return to the PaperPort® window.

Pre Scanning to crop a portion you want to scan

The **PreScan** button is used to preview an image for cropping any unwanted areas from the image. When you are satisfied with the preview, click the **Start** button in the scanner window to scan the image.

- 1 Place the document face up in the ADF, or face down on the scanner glass.

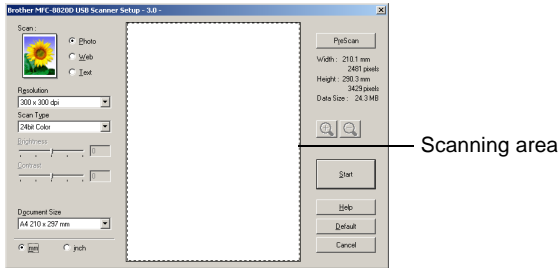

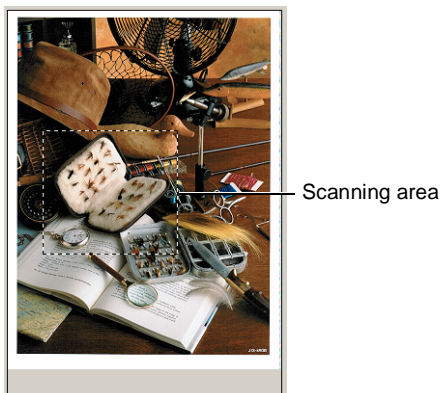

- 2 Select the settings for **Image Type**, **Resolution**, **Scan Type**, **Brightness** and **Contrast**, as needed.
- 3 In the **Brother MFC-8820D**, **Brother MFC-8820D USB** or **Brother MFC-8820D LAN Scanner Setup** dialog box, click the **PreScan** button.

The entire document will be scanned into the PC and will appear in the Scanning Area.



4 Select the portion you want to scan by clicking the left mouse button and dragging it.



You can enlarge the portion you selected by pressing  to check it. If you want to select the different portion, use  to undo the image.

5 If you have used the ADF in Step 1, please place the document face up in the ADF again.

6 Click **Start**.

This time only the selected area of the document will appear in the PaperPort® window (or your software application window).

7 In the PaperPort® window, use the options available to refine the image.

Settings in the Scanner window

Image Type

Select the image type of output from **Photo**, **Web** or **Text**.

Resolution and **Scan Type** will be altered for each default setting.

The default settings are:

Image Type		Resolution	Scan Type
Photo	Select for scanning photo images.	300 x 300 dpi	24-bit color
Web	Select for attaching the scanned image to web pages.	100 x 100 dpi	24-bit color
Text	Select for scanning text documents.	200 x 200 dpi	Black & White

Resolution

You can change the scanning resolution from the **Resolution** drop down list. Higher resolutions take more memory and transfer time, but can achieve a finer scanned image. The following table shows the resolution you can choose and the available colors.

Resolution	Black & White / Gray (Error Diffusion)	256 color	True Gray / 24 bit color
100 x 100 dpi	Yes	Yes	Yes
150 x 150 dpi	Yes	Yes	Yes
200 x 200 dpi	Yes	Yes	Yes
300 x 300 dpi	Yes	Yes	Yes
400 x 400 dpi	Yes	Yes	Yes
600 x 600 dpi	Yes	Yes	Yes
1200 x 1200 dpi	Yes	No	Yes
2400 x 2400 dpi	Yes	No	Yes
4800 x 4800 dpi	Yes	No	Yes
9600 x 9600 dpi	Yes	No	Yes

Scan Type

Black & White: Set the Scan Type to **Black & White** for text or line art.

Gray Scale: Set the Scan Type to **Gray (Error Diffusion)** or **True Gray** for photographic images.

Colors: Set either:

256 Color, which scans up to 256 colors, or **24 bit Color** which scans up to 16.8 million colors.

Although using **24 bit Color** creates an image with the most accurate colors, the image file will be approximately three times larger than a file created with **256 Color**.

Brightness

Adjust this settings (-50 to 50) to obtain the best image. The default value is 0, representing an 'average'.

You can set the level by dragging the slide bar to the right or left to lighten or darken the image. You can also type a value in the box for the setting.

If the scanned image is too light, set a lower brightness value and scan the document again. If the image is too dark, set a higher brightness value and scan the document again.

Contrast

This setting is adjustable only when you have selected one of the gray scale settings. It is not available when **Black & White** and **Color** settings are selected as the **Scan Type**.

You can increase or decrease the contrast level by moving the slide bar to the left or right. An increase emphasizes dark and light areas of the Image, while a decrease reveals more detail in gray areas. You can also type a value in the box for the setting.

Document Size

Set the Size to one of the following:

- Letter (8 1/2 x 11 in.)
- A4 (210 x 297 mm)
- Legal (8 1/2 x 14 in.)
- A5 (148 x 210 mm)
- B5 (182 x 257 mm)
- Executive (7 1/4 x 10 1/2 in.)
- Business Card (90 x 60 mm)
- Photo 3.5 x 5 in. (9 x 13 cm)
- Photo 5 x 7 in. (13 x 18 cm)
- APS C 4 x 6 in. (10 x 15 cm)
- Custom (User adjustable from 0.35 x 0.35 in. to 8.5 x 14 in or 8.9 x 8.9 mm to 215.9 x 355.6 mm.)

To scan photographs or business cards, select the document size, and then place the document face down at the center of scanner glass.

When scanning photographs or other images for use in a word processor or other graphics application. You should try different settings for the contrast and resolution modes to see which best suits your needs.

If you selected **Custom** as the size, The **Custom Document Size** dialog box will appear.

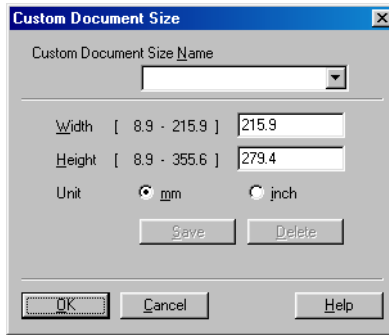

Type the **Name**, **Width** and **Height** for the document.

You can choose “mm” or “inch” as the unit for Width and Height.



You can see the actual paper size you selected on the screen.

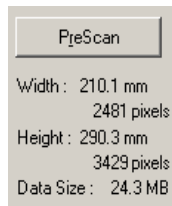

- **Width:** shows the width of scanning area
- **Height:** shows the height of scanning area
- **Data Size:** shows the approximate data size calculated in a Bitmap format. The size will be different for other file formats such as JPEG.

Scanning a document (For Windows® XP only)

WIA compliant

Windows® XP uses Windows® Image Acquisition (WIA) for scanning images from the MFC. You can scan images directly into the PaperPort® viewer that Brother included with your MFC or you can scan images directly into any other software application that supports WIA or TWAIN scanning.

How to access the scanner

- 1 Open your software application to scan a document.



The instructions for scanning in this Guide are for when you use ScanSoft® PaperPort® 8.0. The steps for scanning from another application may vary.

- 2 Select **Scan** from the **File** drop-down menu or select the Scan button.

The **Scan** pane appears in the left panel.

- 3 Select the scanner you are using from the **Scanner** drop-down list box.

- 4 Click **Scan**.

The Scan dialog box will appear:

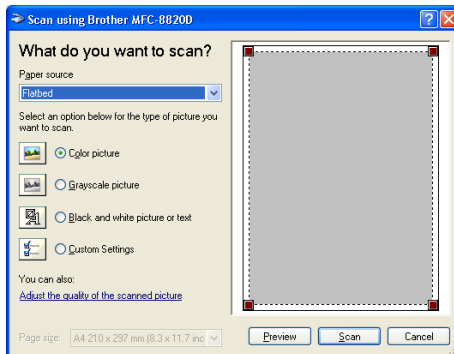

Scanning a document into the PC

There are two ways in which you can scan a whole page. You can either use the ADF or the Flatbed scanner glass.

If you would like to scan and then crop a portion of the page after pre scanning the document you will need to use the scanner glass (Flatbed).

Scanning a document using the ADF

- 1 Place the document face up in the ADF (automatic document feeder).

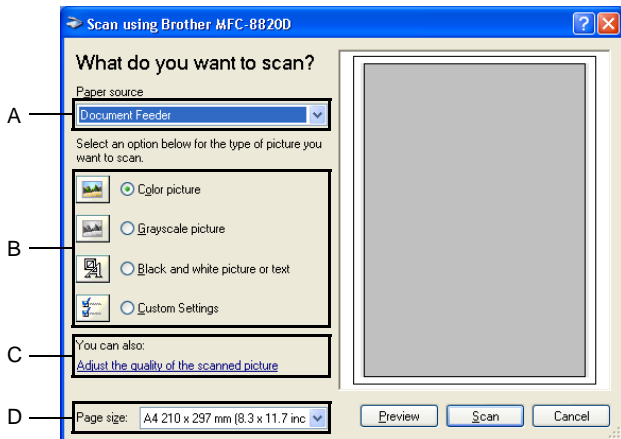

- 2 Select the **Document Feeder** from the **Paper source** drop-down list box (A).
- 3 Select the picture type (B).
- 4 Select the **Paper size** from the drop-down list box (D).

- 5 If you require advanced settings, click on the tab **Adjust the quality of the scanned picture (C)**. You can select **Brightness**, **Contrast**, **Resolution** and **Picture Type** from the **Advanced Properties**. Click the **OK** button after you choose your settings.

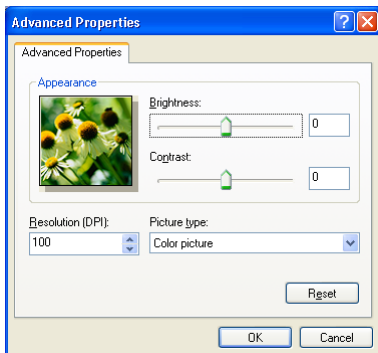

- The scanner resolution you can select is up to 1200 × 1200 dpi.
 - For resolutions greater than 1200dpi, use the Brother Scanner Utility. (See *Brother Scanner Utility* on page 13-15.)
- 6 To start scanning your document, click the **Scan** button in the Scan dialog box.

Pre Scanning to crop a portion you want to scan using the scanner glass

The **Preview** button is used to preview an image for cropping any unwanted portions from the image. When you are satisfied with the preview, click the **Scan** button from the scanner window to scan the image.

- 1 Place the document face down on the scanner glass.
- 2 Make sure you selected **Flatbed** in the Paper source pull-down box (A).

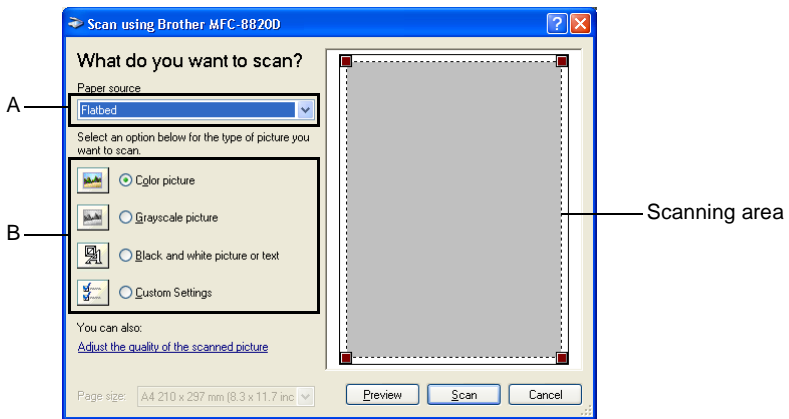

- 3 Select the picture type (B).
- 4 In the Scan dialog box, click the **Preview** button. The entire document will be scanned into the PC and will appear in the scanning area.

- 5 Select the portion you want to scan by clicking the left mouse button and dragging it over the area.

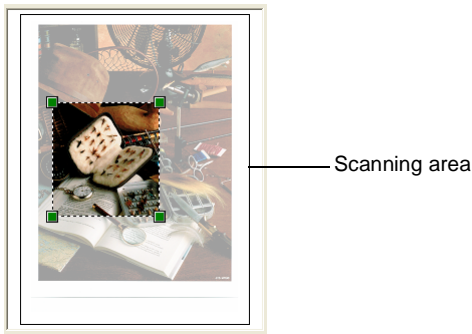

- 6 If you require advanced settings, click **Picture Type** from the **Adjust the quality of the scanned picture (C)**. You can select **Brightness, Contrast, Resolution** and **Advanced Properties**. Click the **OK** button after you choose your settings.

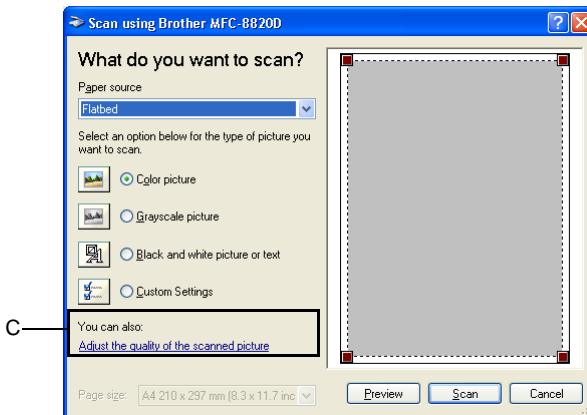

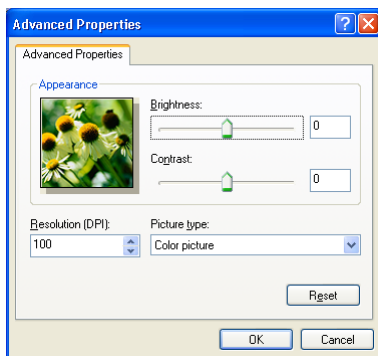

- 7 To start scanning your document, click the **Scan** button in the Scan dialog box.
The selected area of the document will appear in the PaperPort® window (or your software application window).

Brother Scanner Utility

The Brother Scanner Utility is used for configuring the scanner driver for resolutions greater than 1200dpi and for changing the paper size. If you want to set Legal size as the default size, change the setting using this utility. You must restart your PC for the new settings to take effect.

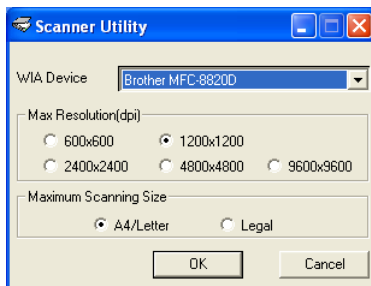

To run the utility:

You can run the utility by selecting the **Scanner Utility** located in the **Start/All Programs/Brother/Brother MFL-Pro Suite** menu.



If you scan the original at resolution of greater than 1200dpi, the file size maybe very large. Please make sure that you have sufficient memory and hard disk space for the size of the file you are trying to scan. If the memory & hard disk is not sufficient then your computer may freeze and you could lose your file.

Using the scan key (For USB or Parallel interface cable users)

You can use  (**Scan**) on the control panel to scan documents into your word processing, graphics or E-mail applications or your computer folder. The advantage of using  (**Scan**) is that you avoid the mouse clicks required to scan from your computer.



For Scan to E-mail, Scan to Image, Scan to OCR and Scan to File

Before you can use  (**Scan**) on the control panel, you must have connected the MFC to your Windows® based computer and loaded the appropriate Brother Drivers for your version of Windows®.

When you are ready to use  (**Scan**), make sure the Brother Control Center application is running on your computer. For details about how to configure the Brother Control Center buttons to launch the application of your choice using

 (**Scan**), go to the appropriate chapter:

- For Windows® 95/98/98SE/Me/2000 Professional and Windows NT® WS 4.0, see *Using the Brother Control Center* on page 14-1.
- For Windows® XP, see *Using the Windows®-Based Brother SmartUI Control Center* on page 15-1.
- If your MFC is connected with both a USB and a Parallel cable, you need to select USB or Parallel as the destination in each step.

Scan to E-mail



You can either scan a black and white or color document into your E-mail application as a file attachment. You can change the



(Scan) configuration. (See *Scan to E-mail* on page 14-10 to 14-11.) (For Windows® XP: See *Hardware Section: Changing the Scan to button configuration* on page 15-5 to 15-11.)

1 Place the document face up in the ADF, or face down on the scanner glass.

2 Press  **(Scan)**.

3 Press  or  to select Scan to E-Mail.

Press **Set**.

The MFC will scan the document, create a file attachment, and launch your E-mail application, displaying the new message waiting to be addressed.

▲Scan to E-Mail
Scan to Image
Scan to OCR
▼Scan to File
Select ▲▼ & Set

Scan to Image

You can scan a color picture into your graphics application for viewing and editing. You can change the  **(Scan)**

configuration. (See *Scan to Image* on page 14-14.) (For Windows® XP: See *Hardware Section: Changing the Scan to button configuration* on page 15-5 to 15-11.)

1 Place the document face up in the ADF, or face down on the scanner glass.

2 Press  **(Scan)**.

3 Press  or  to select Scan to Image.

Press **Set**.

The MFC will start the scanning process.

▲Scan to E-Mail
Scan to Image
Scan to OCR
▼Scan to File
Select ▲▼ & Set

Scan to OCR

If your document is text, you can have it converted by ScanSoft® TextBridge® to an editable text file and then have the result displayed in your word processing application for viewing and editing. You can change the  (**Scan**) configuration. (See *Scan to OCR (Word Processor)* on page 14-12 to 14-13.) (For Windows® XP: See *Hardware Section: Changing the Scan to button configuration* on page 15-5 to 15-11.)

1 Place the document face up in the ADF, or face down on the scanner glass.

2 Press  (**Scan**).

3 Press  or  to select Scan to OCR.

Press **Set**.

The MFC will start the scanning process.

▲Scan to E-Mail
Scan to Image
Scan to OCR
▼Scan to File
Select ▲▼ & Set

Scan to File

You can scan a black and white or a color document into your computer and save it as a file in the folder you choose. The file type and specific folder are based on the settings you have chosen in the Scan to File screen of the Brother MFL-Pro Control Center. (See *Scan to File* on page 14-8 to 14-9.) (For Windows® XP: See *Hardware Section: Changing the Scan to button configuration* on page 15-5 to 15-11.)

1 Place the document face up in the ADF, or face down on the scanner glass.

2 Press  (**Scan**).

3 Press  or  to select Scan to File.

Press **Set**.

The MFC will start the scanning process.

▲Scan to E-Mail
Scan to Image
Scan to OCR
▼Scan to File
Select ▲▼ & Set

Using ScanSoft® PaperPort® and TextBridge® OCR

ScanSoft® PaperPort® for Brother is a document management application. You will use PaperPort® to view scanned documents. PaperPort® has a sophisticated, yet easy-to-use, filing system that will help you organize your graphics and text documents. It allows you to combine or “stack” documents of different formats for printing, faxing or filing.

ScanSoft® PaperPort® can be accessed through the ScanSoft® PaperPort® program group.

See *Documentation for ScanSoft® PaperPort® on the CD-ROM.*

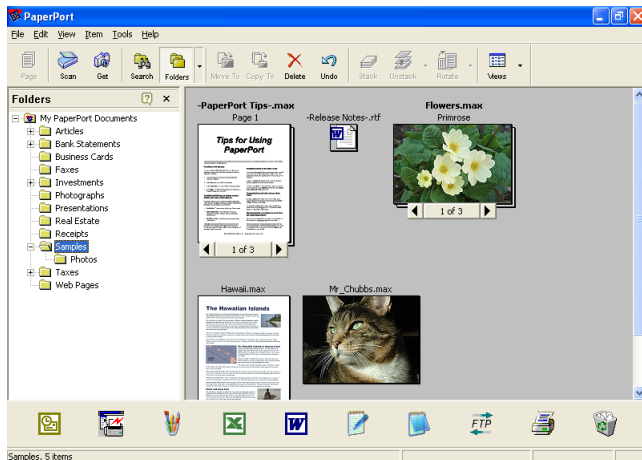

The complete ScanSoft® PaperPort® Users Guide, including ScanSoft® TextBridge® OCR, is in the documentation on the CD-ROM.

This chapter is only an introduction to the basic operations.

When you install MFL-Pro Suite, ScanSoft® PaperPort® for Brother and ScanSoft® TextBridge® OCR are installed with it automatically.

 If you are using Windows® XP, Windows NT® 4.0 or Windows® 2000 Professional, we recommend that you are logged on with administrator rights.

Viewing items

ScanSoft® PaperPort® provides several ways to view items:

Desktop View displays a thumbnail (a small graphic that represents each item in a Desktop or folder).

Items in the selected folder appear on the PaperPort® Desktop. You can see PaperPort® items (MAX files) and non-PaperPort® items (files created using other applications).

Non-PaperPort® items include an icon that indicates the application that was used to create the item; a non-PaperPort® item is represented by a small rectangular thumbnail and not an actual image.

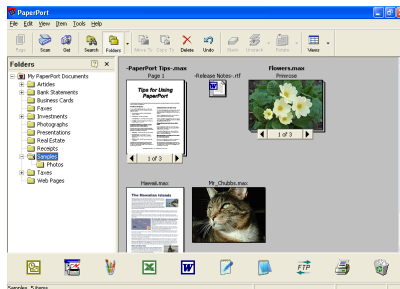

Desktop View displays items as thumbnails

Page View displays a close-up of a single page and you can open a PaperPort® item by double-clicking on it.

As long as you have the appropriate application on your computer to display it, you can also double-click a non-PaperPort® item to open it.

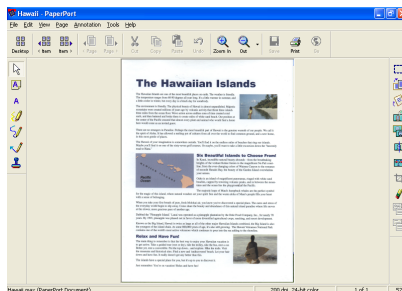

Page View displays each item as a full page

Organizing your items in folders

PaperPort® has an easy-to-use filing system for organizing your items. The filing system consists of folders and items that you select to view in Desktop View. An item can be a PaperPort® item or a non-PaperPort® item:

- Folders are arranged in a “tree” structure in the Folder View. You use this section to select folders and view their items in Desktop View.
- You can simply drag and drop an item onto a folder. When the folder is highlighted, release the mouse button and the item is stored in that folder.
- Folders can be “nested”—that is, stored in other folders.
- When you double-click a folder, its items (both PaperPort® MAX files and non paperport® files) appear on the Desktop.
- **You can also use Windows® Explorer to manage the folders and items shown in Desktop View.**

Quick links to other applications

ScanSoft® PaperPort® automatically recognizes many other applications on your computer and creates a “working link” to them. The Send To Bar at the bottom of the Desktop view shows icons of those linked applications.

To use a link, drag an item onto one of the icons to start the application represented by the icon. A typical use of the Send To Bar is to select an item and then fax it.

This sample Send To Bar shows several applications with links to PaperPort®.



If PaperPort® does not automatically recognize one of the applications on your computer, you can manually create a link using the **Add to Send To Bar...** command.

(See PaperPort® in the Documentation section on the CD-ROM for more information about creating new links.)

ScanSoft® TextBridge® OCR lets you convert image text into text you can edit

Software by:



ScanSoft® TextBridge® OCR is installed automatically with PaperPort® when you install MFL-Pro Suite on your computer.

ScanSoft® PaperPort® can quickly convert the text on a ScanSoft® PaperPort® item (which is really just a picture of the text) into text that you can edit with a word processing application.

PaperPort® uses the optical character recognition application ScanSoft® TextBridge®, which comes with PaperPort®

—OR—

PaperPort® can use your preferred OCR application if it is already on your computer. You can convert the entire item, or by using the **Copy Text** command, you can select only a portion of the text to convert.

Dragging an item onto a word-processing link icon starts PaperPort®'s built-in OCR application, or you can use your own OCR application.



You can Import items from other applications

In addition to scanning items, you can bring items into PaperPort® in a variety of ways and convert them to PaperPort® (MAX) files in several different ways:

- Print to the Desktop View from another application, such as Microsoft® Excel.
- Import files saved in other file formats, such as Windows® Bitmap (BMP) or Tag Image File Format (TIFF).

You can Export items in other formats

You can export or save PaperPort® items in several popular file formats, such as BMP, JPEG, TIFF, or self-viewing.

For example, to create a file for an Internet Web site, export it as a JPEG file. Web pages often use JPEG files for displaying images.

Exporting an image file

- 1 Select the Save As command from the File pull-down menu in the PaperPort® window. The Save 'XXXXX' as dialog box will be displayed.
- 2 Select the drive and directory where you want to store the file.
- 3 Enter the new file name and choose the file type or select a name from the File Name text box. (You can scroll through the Directories and File Name listing for prompting.)
- 4 Select the **OK** button to save your file, or **Cancel** to return to the PaperPort® without saving it.

How to Uninstall PaperPort® and ScanSoft® TextBridge®

For Windows® 95/98/98SE, and Windows NT® Workstation 4.0 and Windows® Me:

Select **Start, Settings, Control Panel, Add/Remove Programs** and the **Install/Uninstall** tab.

Select **Brother Extensions for Paperport®** and click the **Add/Remove** button.

Select **PaperPort® 8.0 SE** from the list and click the **Add/Remove** button.

For Windows® 2000 Professional:

Select **Start, Settings, Control Panel** and **Add/Remove Programs**.

Select **Brother Extensions for Paperport®** and click the **Change/Remove** button.

Select **PaperPort® 8.0 SE** from the list and click the **Change** button.

For Windows® XP:

Select **Start, Control Panel, Add or Remove Programs** and the **Change or Remove Programs** icon.

Select **PaperPort® 8.0 SE** from the list and click the **Change** button.

14 Using the Brother Control Center

(For Windows® 95/98/98SE/Me/2000 Professional and Windows NT® WS 4.0)

 If you are using Windows® 2000 Professional or Windows NT® 4.0, we recommend that you are logged on with administrator rights.

Brother MFL-Pro Control Center

The Brother Control Center is a software utility that pops up on the PC screen whenever paper is put in the ADF of the MFC. This allows you to quickly and with very few mouse clicks, to access the most frequently used scanning applications. Using the Control Center stops the need to manually startup any specific applications.

The Brother Control Center provides three operations (Scan, Copy and PC-Fax):

- Scan directly to a file, E-mail, word processor or graphic application of your choice
- Copy
- PC Faxing using the Brother PC-FAX software





AutoLoad the Brother Control Center

The Control Center is loaded every time Windows® is started.

When the Control Center is loaded, the **Control Center**  icon will appear on the task bar.

If you don't want the Control Center to load automatically, you can turn off AutoLoad.

 If the **Control Center**  icon does not appear on your task bar, you will have to launch the software.

Double-click the **Control Center**  icon on the desktop or from the **Start** menu, select **Programs, ScanSoft® PaperPort® 8.0**, and then click **Brother SmartUI POPUP**.

How to turn off AutoLoad

- 1 Left-click the Control Center  icon and click **Show**.
- 2 When the Control Center window appears, left click the **Configuration**  **Control Center** button.

A dialog box will appear:

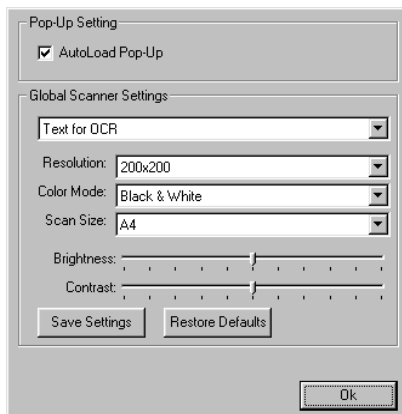

- 3 Uncheck the 'AutoLoad' Pop-Up check box.

Brother Control Center features

Auto Configuration

During installation the Control Center will check your system to set up the default applications for E-mail, word processing and the graphics viewer/editor.

For example, if you are using Outlook as your default E-mail application, the Control Center will create a link and a scanning application button for Outlook.

You can change a default application. Right-click the appropriate Control Center button to display *Configurations* and then click it. Select a different application.

For example, you can change a scan button from MS Word Pad



to MS Word



by changing the application that is listed for the Word Processor.

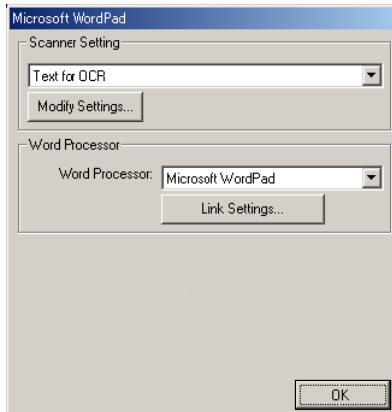

Scan key operations

Scan to File—Allows you to scan directly to a file on your computer. You can change the file type and directory for the document you are scanning.

Scan to E-mail—Allows you scan a picture or text document directly into an E-mail application as a standard attachment. You can choose the file type and resolution for the attachment.

Scan to OCR (Word Processor)—Allows you to scan a text document, run ScanSoft® TextBridge® OCR, and insert the text document (not a graphic image) into a word processing file. You can choose the word processing application, such as Word Pad, MS Word, and so on.

Scan to Image—Allows you to scan an image directly into any graphic viewer/editor application. You can choose the graphics application, such as Microsoft Paint.

Copy operations

Copy—Allows you use the PC and any Windows® printer driver for enhanced copy operations.

You can scan the page on the Brother MFC and print the copies using any of the features of the Brother MFC printer driver.

—OR—

You can send the copy output to any standard Windows® printer driver that is on your PC.

PC-Fax operation

Send a Fax—Allows you scan a picture or text document and send the image as a fax from the PC using the Brother PC-FAX software.

Scanner settings for Scan, Copy and PC-Fax buttons

When the Pop-Up screen appears, you can access the Scanner Settings window.

Click the **Configuration**  **Control Center** icon at the top right of the Brother Control Center screen

—OR—

Click the **Modify Settings** button on any of the Configuration screens.

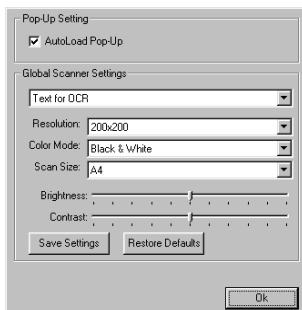

Global settings

AutoLoad Pop-Up—Select this checkbox if you want Brother MFL Control Center to load when you turn on your computer.

Setting up the scanner configurations

The Pop-Up application stores eight different scanning modes. Each time you scan a document, you can choose the most appropriate scanning mode from the following:

Faxing, Filing and Copying

Text for OCR

Photos

Photos (High Quality)

Photos (Quick Scan)

Custom

Draft Copy

Fine Copy

Each mode has its own set of stored settings. You can keep the factory default settings or change them at any time:

Resolution—From the pull-down list, select the scanning resolution you most often use.

Color Mode—From the pull-down list, select the color settings you most often use.

Scan Size—From the pull-down list, select the scan size you most often use.

Brightness—Slide the adjuster from 0% to 100%

Contrast—Slide the adjuster from 0% to 100%



Click **OK** to save your changes. If you make a mistake or want the original default setting, just click the **Restore Defaults** button when the scanning mode is displayed.

Perform an operation from the Control Center screen

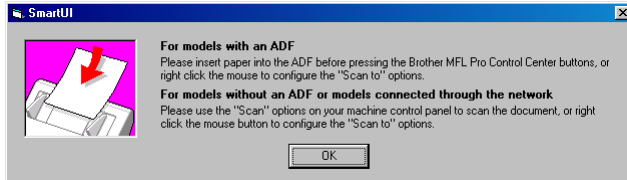
If you see this screen it means you left-clicked a button in the Control Center window without first placing a document in the ADF.



Place the document in the MFC's ADF, and then click **OK** to go to the Control Center screen.

 If you want to scan the document from the scanner glass, please use  (**Scan**) on the control panel of the MFC.

Scan to File

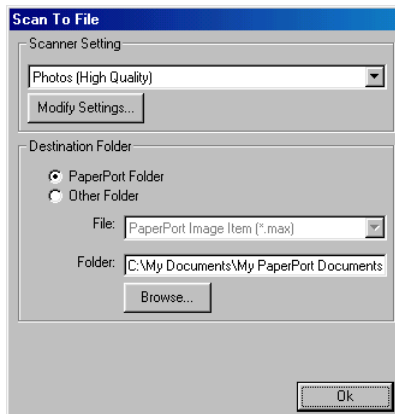

To access Scan to File Configurations screen

- 1 Place the document face up in the ADF. The Brother Control Center screen will pop up.
- 2 Right-click Scan to File and click on *Configuration*. Click the **Modify Settings** button to view the configuration screen of the **Control Center**.
- 3 To save your settings, click **OK**.
—OR—
To go back to the factory default settings, click the **Restore Defaults** button.

Scanner settings

From the pull-down list, select the scanning mode that is appropriate for the type of file: **Faxing, Filing and Copying; Text for OCR; Photos; Photos (High Quality); Photos (Quick Scan); Custom; Draft Copy or Fine Copy.**

To change any of the settings for the mode, click **Modify Settings**.

Destination folder

PaperPort® Folder—Select this checkbox to scan the document into your PaperPort® folder.

Other Folder—Select this checkbox, to scan the document as another file type or to store it in another directory/folder.

File—If you selected Other folder from the pull-down list, select the type of file:

- PaperPort® Image Item (*.max)
- PaperPort® Self-Viewing (*.exe)
- PaperPort® Browser-Viewable (*.htm)
- PaperPort® 5.0 Image Item (*.max)
- PaperPort® 4.0 Image Item (*.max)
- PaperPort® 3.0 Image Item (*.max)
- Windows Bitmap (*.bmp)
- PC Paintbrush (*.pcx)
- PCX Multi-page (*.dcx)
- JPEG (*.jpg)
- TIFF-Uncompressed (*.tif)
- TIFF-Group 4 (*.tif)
- TIFF-Class F (*.tif)
- TIFF Multi-page - Uncompressed (*.tif)
- TIFF Multi-page - Group 4 (*.tif)
- TIFF Multi-page - Class F (*.tif)
- Portable Network Graphics (*.png)
- FlashPix (*.fpx)

To Search your system for the directory and folder you want, click the **Browse** button. Click **OK** to save your settings.

Scan to E-mail

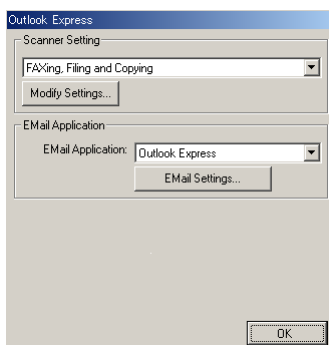

To access Scan to E-mail Configurations screen

- 1 Place the document face up in the ADF. The Brother Control Center screen will pop up.
- 2 Right-click the E-mail application button and click on *Configuration*. Click the **Modify Settings** button to view the configuration screen of the **Control Center**.
- 3 To save your settings, click **OK**.

—OR—

To go back to the factory default settings, click the **Restore Defaults** button.

Scanner settings

From the pull-down list, select the scanning mode that is appropriate for the type of file: **Faxing, Filing and Copying**; **Text for OCR**; **Photos**; **Photos (High Quality)**; **Photos (Quick Scan)**; **Custom**; **Draft Copy** or **Fine Copy**.

To change any of the settings for this mode, click **Modify Settings**.

E-mail application

E-mail Application—From the pull-down list, select your E-mail application.

E-mail Settings—Click the **E-Mail Settings** button to set up links. The **Send To Options** window will appear:

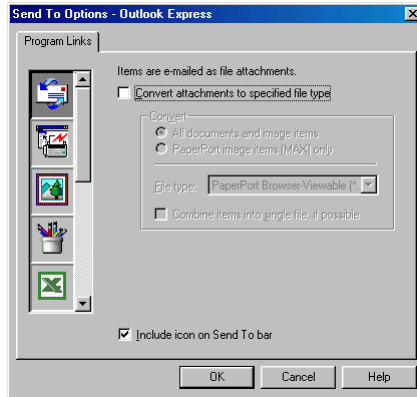

Send to Options

Convert attachments to specified file type—Converts items to the type in the **File type** box. Clear this check box to keep files in their source format; for example, to keep Word documents in the .doc format and JPEG images in the .jpg format.

All documents and image items—Converts all items regardless of the program in which the item was created; for example, converts all Word (doc) files and JPEG (.jpg) files to the file type.

PaperPort® image items (MAX) only—Converts only PaperPort® image items (.max) files. PaperPort® does not convert other file types, such as JPEG images and Word documents.

File type—Identifies the format in which to convert items; for example, JPEG or TIFF.

Combine items into single file, if possible—Combines all selected items into a single file that contains multiple pages. This option is available only when the file type supports multiple pages, such as multi-page TIFF.

Scan to OCR (Word Processor)

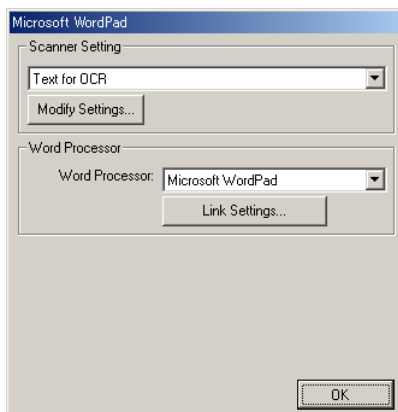

To access Scan to OCR Configurations screen

- 1 Place the document face up in the ADF. The Brother Control Center screen will pop up.
- 2 Right-click the word processor application button and click on *Configuration*. Click the **Modify Settings** button to view the configuration screen of the **Control Center**.
- 3 To save your settings, click **OK**.
—OR—
To go back to the factory default settings, click the **Restore Defaults** button.

Scanner settings

From the pull-down list, select the scanning mode that is appropriate for the type of file: **Faxing, Filing and Copying; Text for OCR; Photos; Photos (High Quality); Photos (Quick Scan); Custom; Draft Copy** or **Fine Copy**.

To change any of the settings for this mode, click **Modify Settings**.

Word Processor

Word Processor—From the pull-down list, select the word processor you want to use.

Click the **Link Settings** button to display the screen to set up the document format you want to use and identify the OCR program:

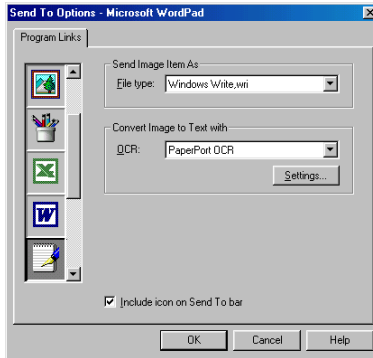

File type—From the pull-down list, select the file type you want to use for your word processor or text documents.

OCR—Identify the OCR program to use to convert scanned document images to editable documents. This option is available only when you have an OCR program other than the one provided with PaperPort®. (PaperPort® 8.0 SE uses the same OCR engine that is in ScanSoft®'s TextBridge® Pro Millennium product.)

Click the **Settings** button to choose how the OCR application will read the pages that you scan into your word processor application.

The **OCR Settings** window will appear:

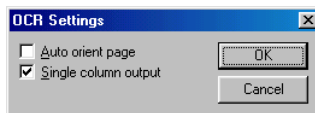

Select your setting and click **OK**.

- *Auto orient page*—Click this checkbox to automatically rotate pages so that the text is upright.
- *Single column output*—Click this checkbox if you want to remove columns from multi-column documents so that converted text appears in a one-column format.

Scan to Image

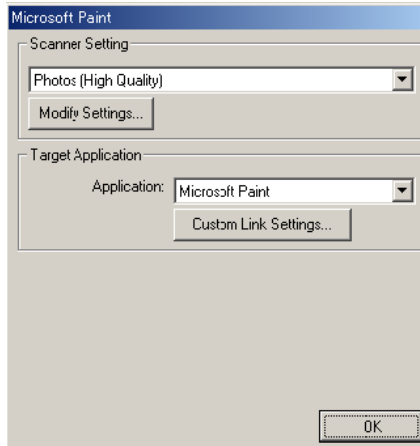

To access Scan to Image Configurations screen

- 1 Place the document face up in the ADF. The Brother Control Center screen will pop up.
 - 2 Right-click the graphic application button and click on *Configuration*. Click the **Modify Settings** button to view the configuration screen of the **Control Center**.
 - 3 To save your settings, click **OK**.
- OR—
- To go back to the factory default settings, click the **Restore Defaults** button.

Scanner Settings

From the pull-down list, select the scanning mode that is appropriate for the type of file: **Faxing, Filing and Copying; Text for OCR; Photos; Photos (High Quality); Photos (Quick Scan); Custom; Draft Copy** or **Fine Copy**.

To change any of the settings for this mode, click **Modify Settings**.

Target Application

Application—From the pull-down list, select the application you want to add to this Pop-Up screen.

Click the **Custom Link Settings** button to set up links for your user-defined application.

Copy

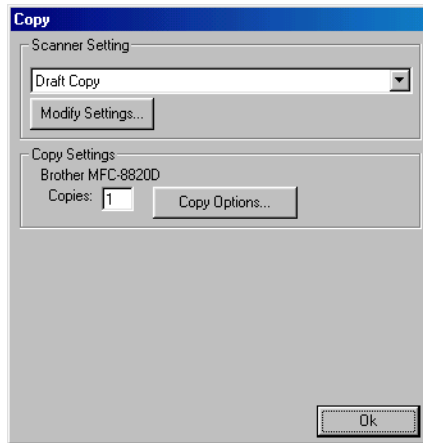

To access the Copy Configurations screen

- 1 Place the document face up in the ADF. The Brother Control Center screen will pop up.
- 2 Right-click the Copy and click on *Configuration*. Click the **Modify Settings** button to view the configuration screen of the **Control Center**.
- 3 To save your settings, click **OK**.
—OR—
To go back to the factory default settings, click the **Restore Defaults** button.

Scanner settings

From the pull-down list, select the scanning mode that is appropriate for the type of file: **Draft Copy** or **Fine Copy**.

To change any of the settings for this mode, click **Modify Settings**.

Number of copies

Copies—Enter the number of copies you want to print.

To change the copy options, click the **Copy Options** button.

Click **OK** to save your Copy settings.

Send a fax

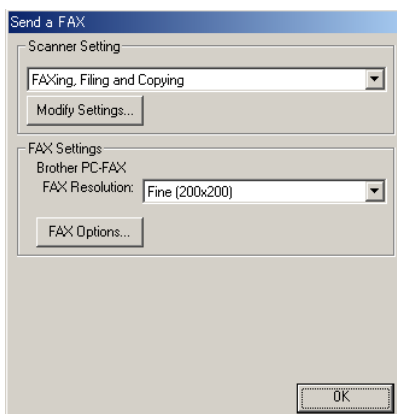

To access the Send a fax Configurations screen

- 1 Place the document face up in the ADF. The Brother Control Center screen will pop up.
- 2 Right-click the Send a fax and click on *Configuration*. Click the **Modify Settings** button to view the configuration screen of the **Control Center**.
- 3 To save your settings, click **OK**.
—OR—
To go back to the factory default settings, click the **Restore Defaults** button.

Scanner settings

From the pull-down list, select the scanning mode that is appropriate for the type of file: **Faxing, Filing and Copying**; **Text for OCR**; **Photos**; **Photos (High Quality)**; **Photos (Quick Scan)**; **Custom**; **Draft Copy** or **Fine Copy**.

To change any of the settings for this mode, click **Modify Settings**.

PC-FAX Settings

Brother PC-Fax

FAX Resolution—Fine (200 × 200)

- 1 To change the fax options, click the **FAX Options** button. The Brother PC-FAX Properties screen appears:

For Windows® 95/98/98SE/Me and Windows NT® WS 4.0

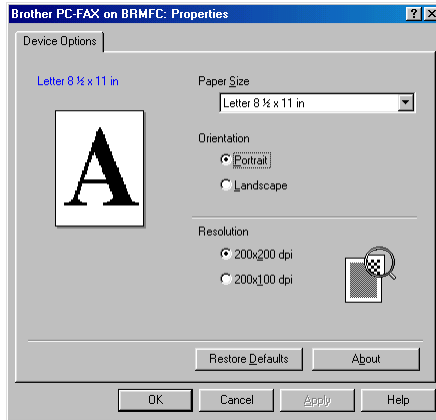

For Windows® 2000 Professional

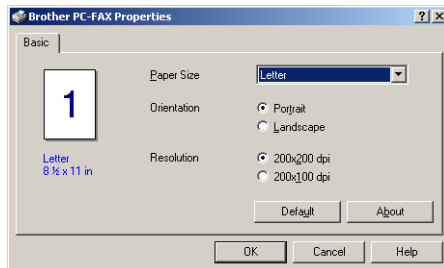

- 2 Select the Paper Size and Orientation (Portrait or Landscape) and click **OK**.

 To go back to the factory default settings, click the **Restore Defaults** or **Default** button.

15 Using the Windows®-Based Brother SmartUI Control Center

(For Windows® XP)

Brother SmartUI Control Center

The Brother Control Center is a software utility that allows you to quite easily, with very few mouse clicks, access the most frequently used scanning applications. Using the Control Center eliminates the need to manually launch the specific applications and allows you to scan a document directly to a folder on your computer. The Brother Control Center provides four categories of operations:

- 1 Scan directly to a file, E-mail, word processor or graphics application of your choice.
- 2 Enhanced copy functions, such as Four/Two or One-on-One Copying.
- 3 PC Faxing using the Brother PC-Fax software.
- 4 Custom buttons allow you to configure a button to meet your own application requirements.

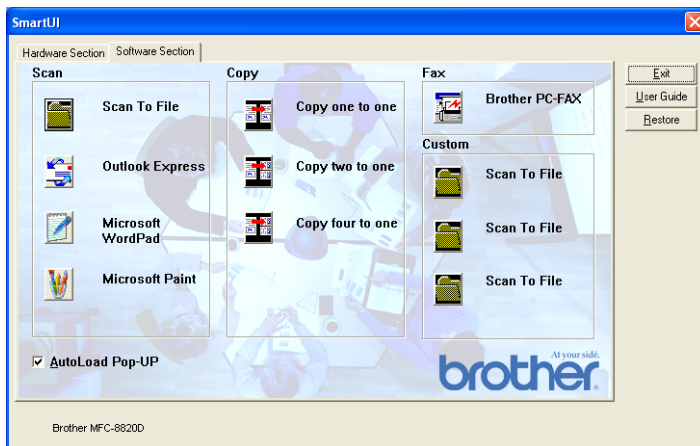

In the Task Tray right-click on the Control Center  icon and select **Show** to have access to the Brother SmartUI Control Center window.

AutoLoad the Brother Control Center

The Control Center is initially configured to automatically load each time Windows® is started. When the Control Center is loaded the Control Center  icon will appear in the task bar. If you don't want the Control Center to load automatically, you can turn AutoLoad off.

How to turn off Auto Load

- 1 Right-click the Control Center  icon in the Task Tray and select **Show**.
- 2 The main SmartUI Control Center window appears. Please look at the bottom of the window for a check box labeled “AutoLoad Pop-up”.



- 3 Uncheck the AutoLoad Pop-Up option to prevent the SmartUI from automatically loading every time Windows® is started.

Brother Control Center features

The SmartUI control center gives you the ability to configure the hardware **Scan** key on your MFC such as “Scan to File”. The “Scan to File” feature allows you to scan a document directly to your hard disk and choose the file format and destination folder without having to run any other applications. Select which section you want by clicking on the appropriate tab.

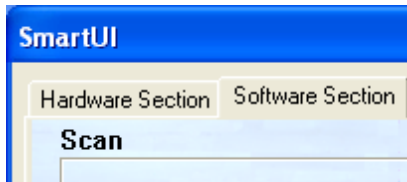

Auto Configuration

During the installation process the Control Center checks your system to determine the default applications for E-mail, word processing and graphics viewer/editor.

For example, if you are using Outlook as your default E-mail application, the Control Center automatically will create a link and a scanning application button for Outlook.

You can change the default application by right-clicking on any of the scan buttons in the Control Center and then clicking *Configuration*. Select the Configuration tab and from the Application pull down menu select a different application. For example, you can change the E-mail scan button from Outlook Express to Outlook by changing the application that is listed.

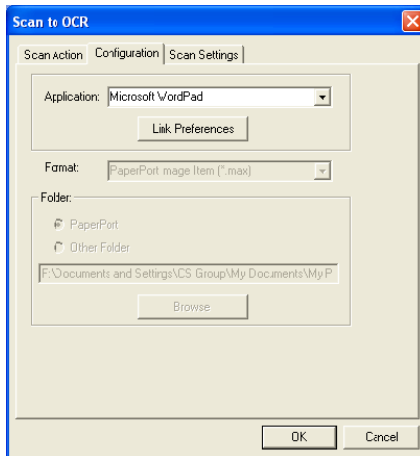

Hardware Section: Changing the Scan to button configuration

When the SmartUI Control Center is displayed, you can access the Hardware Section window to reconfigure the  (**Scan**) button on your MFC. Click the Hardware Section tab at the top left of the SmartUI Control Center screen. (See *Using the scan key (For USB or Parallel interface cable users)* on page 13-16.)

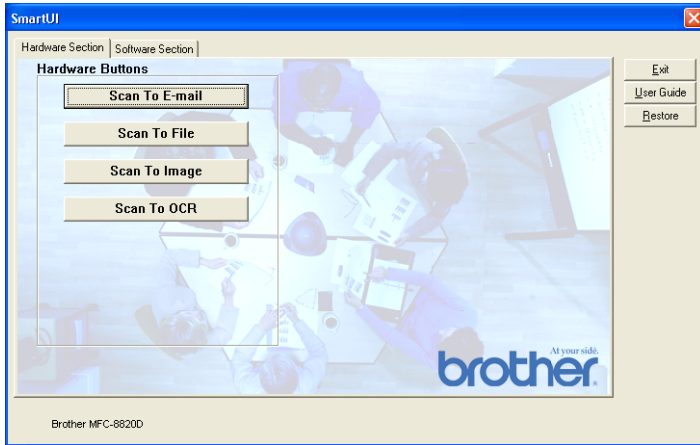

Scan to E-mail

To configure the Scan to E-mail feature left-click on the **Scan to E-mail** button and the following screen will appear. You have the ability to change the configuration that includes the destination E-mail application, attachment file and the scanner settings.

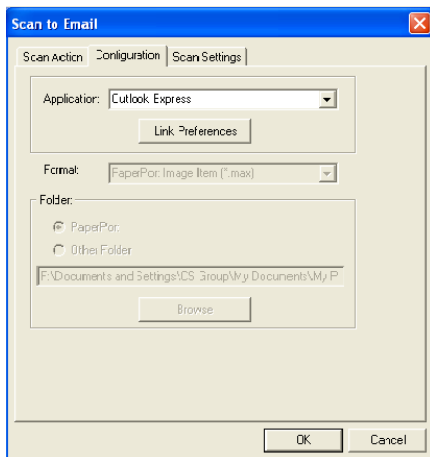

To change the destination E-mail application you use the Application pull down list to select the compatible E-mail application, which is installed on your system.

If you wish to change the attachment file type click on the **Link Preferences** button to display a list of file types.

Scan to File

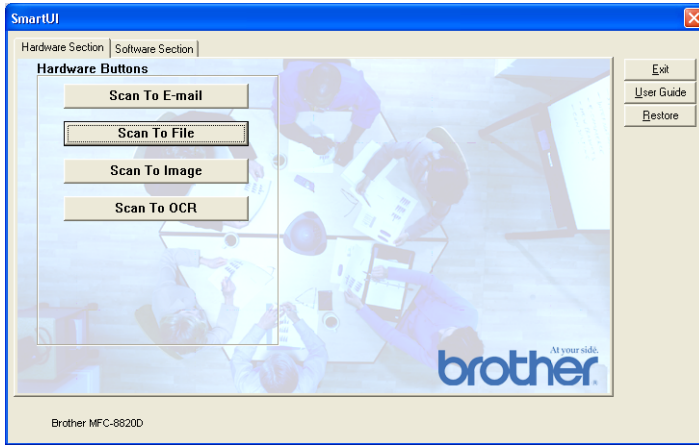

To configure the Scan to File feature, left click on the Scan to File button and the following screen will appear.

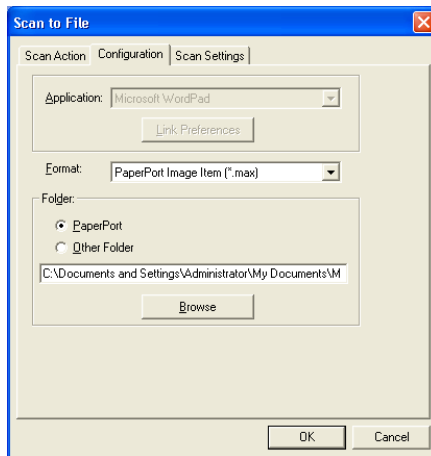

Select the file type for the saved image by selecting from the Format pull down list. You can save the file to the default PaperPort® folder so the file appears in PaperPort® or you can select another folder/directory by clicking the Browse button.

Scan to Image

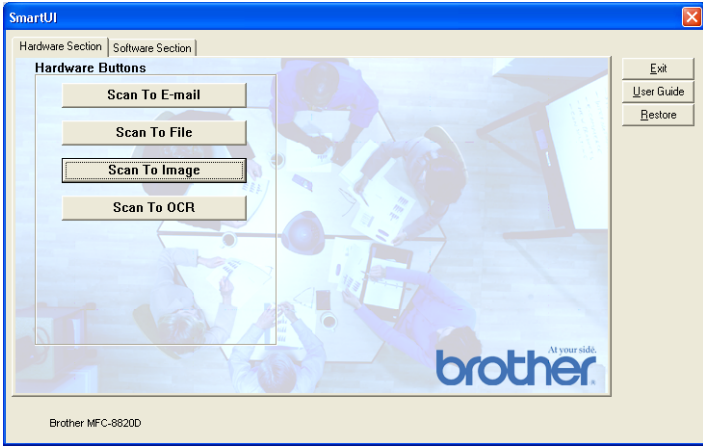

To configure the Scan to Image feature left-click on the **Scan to Image** button and the following screen will appear. You can change the configuration, which includes the destination image format or document application.

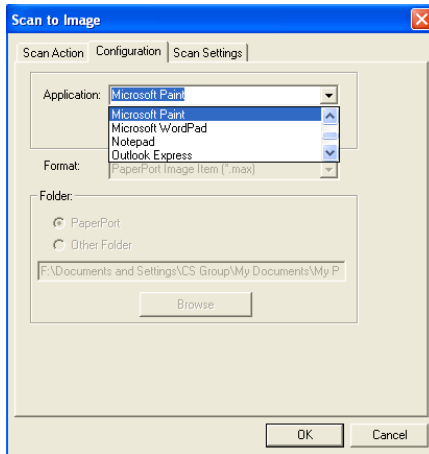

To change the default settings of the scan, click on the **Scan Settings** tab.

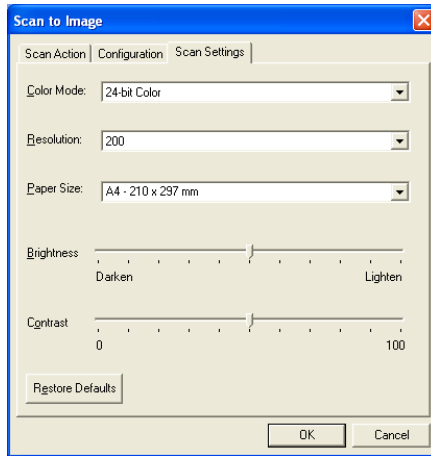

You can set the Color Mode to Black & White, 8-bit Gray or 24-bit Color.

The resolution can be changed from 100 to 1200 dpi. You can define the size of the paper you're using, and you can adjust the brightness and contrast of the image before scanning.

Scan to OCR



To configure the Scan to OCR feature left-click on the **Scan to OCR** button and the following screen will appear. You can change the configuration, which includes the destination applications.

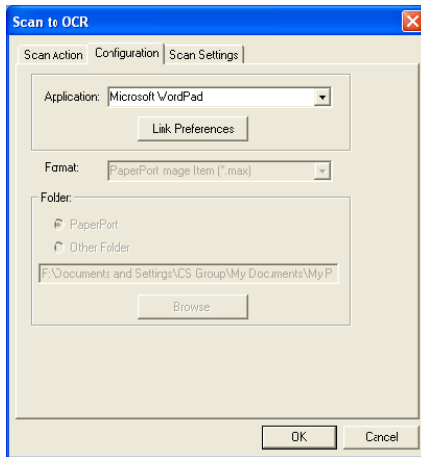

You have the option to send your scan as a different file type. You can select the application from the File Type window according to your needs.

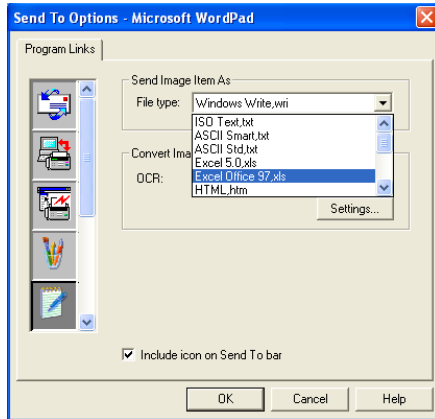

You have the option to choose your OCR setting from **Single column output** to **Auto orient page**.

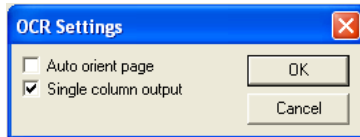

Software Section

The Software Section contains four groups of scan to buttons. Each section has a number of different buttons which are predefined for the most frequently used applications. The **Scan** section contains four buttons for Scan to File, Scan to E-mail, Scan to Word Processor and Scan to Image applications. The **Copy** section contains four buttons for N to 1 copying. The **Fax** section button is for sending faxes using the Brother PC-FAX application and the **Custom** section contains three buttons with which you can assign your own function.



Scan

*1 *Scan to File*—enables you to scan directly to a disk file. You can change the file type and destination directory, as needed.

*2 *Scan to E-mail (Default: Outlook Express)*—enables you to scan a page or document directly into an E-mail application as a standard attachment. You have the option of selecting the file type and resolution for the attachment.

*3 *Scan to Word Processor (Default: MS WordPad)*—enables you to scan a page or document, automatically run ScanSoft® TextBridge® OCR and insert the text (not graphic image) into a word processing program. You have the option of selecting the destination word processing program, such as WordPad, MS Word, Word Perfect or whichever word processing program is installed on your computer.

*4 *Scan to Graphic Application (Default: MS Paint)*—enables you to scan a page directly into any graphic viewer/editor application. You can select the destination application, such as MS Paint, Corel PhotoPaint, Adobe PhotoShop, or any kind of image editor application you already have installed on your computer.

Copy

Copy (Copy one to one)—allows you to use the PC and any Windows® printer driver for enhanced copy operations. You can scan the page on the MFC and print the copies using any of the features of the MFC printer driver—**OR**—you can direct the copy output to any standard Windows® printer driver installed on the PC including network printers.

Four/Two to One Copy—enables you to use the Four/Two on One-page features of the Brother printer driver to copy four/two document pages onto a single output page.

Fax

Send a Fax (Brother PC-FAX)—enables you to scan a page or document and automatically send the image as a fax from the PC using the Brother PC-FAX software.

Custom

Scan to File—These buttons have been pre-programmed for the Scan to File feature. You can change the configuration of each of these buttons to meet your specific requirements by right-clicking on a button and following the configuration menus.

Scan to File

The Scan to File button allows you to scan an image and save it in a specific file type to any directory on your hard disk. This allows you to easily archive your paper documents. To configure the file type and save to directory right-click on the Scan to File button and click Configuration.

The Scan Action tab is set to File and should not be changed.

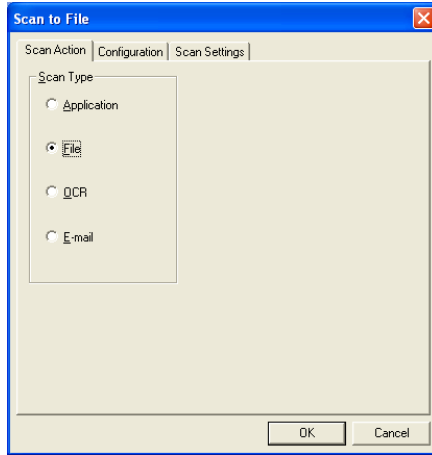

To change the configuration click on the Configuration tab.

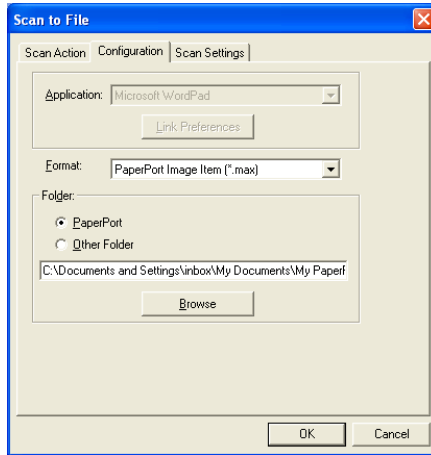

Select the file type for the saved image by selecting from the Format pull down list. You can save the file to the default PaperPort® folder so the file appears in PaperPort®, or you can select another folder/directory by clicking the Browse button.

You can change the default setting by selecting the Other Folder button and then clicking Browse and selecting the folder in which you wish to save your files.

Scan to E-mail

The Scan To E-mail is automatically configured to your default E-mail application. To change the default E-mail application or attachment file type, right-click on the E-mail button and select “Configuration”.

The Scan Action tab is set to E-mail and should not be changed.

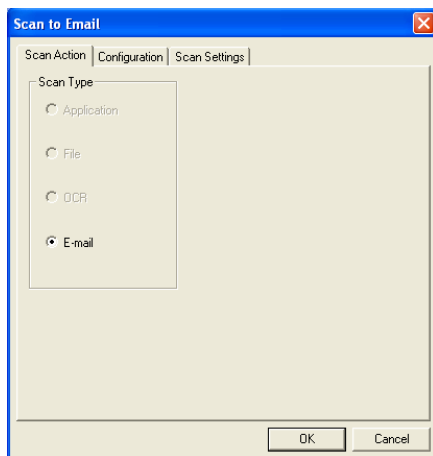

To change the E-mail application click on the Configuration tab. From the Application pull down list, select your preferred E-mail application.

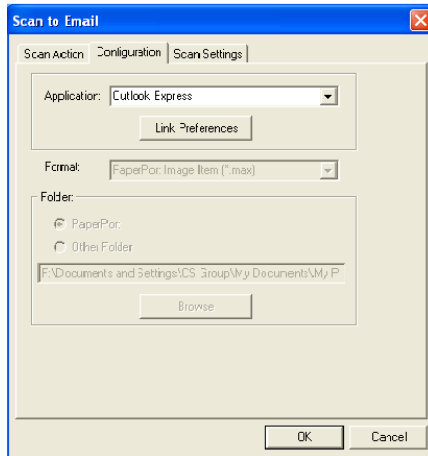

To change the file type of the attachment click the **Link Preferences** button to set up links. Check the **Convert attachments to specified file type** box and then select the appropriate file type from the pull down list.

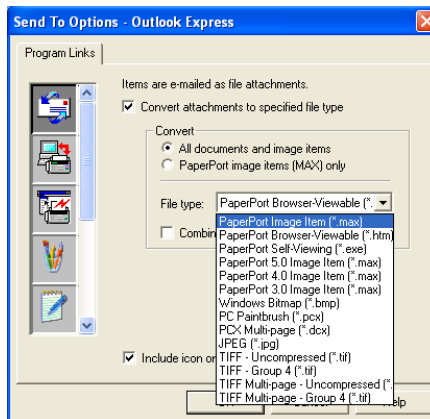

File attachments

Items are mailed as file attachments using the file type you have selected.

Convert attachments to specified file type—Click this check box if you want to change the file type of attachments.

All documents and image items—Click this check box if you want to convert all scanned images to the same file type.

PaperPort® image items (MAX) only—Click this check box if you want to convert only attachments that are PaperPort® MAX files.

Combine items into single file, if possible—Click this check box if you want to combine all the attachments into one file. With this box unchecked each scanned page will be saved in its own individual file.

File type—Select from the pull-down list the type of file you want the scanned images to be saved in.

- PaperPort® Image Item (*.max)
- PaperPort® Browser-Viewable (*.htm)
- PaperPort® Self Viewing (*.exe)
- PaperPort® 5.0 Image Item (*.max)
- PaperPort® 4.0 Image Item (*.max)
- PaperPort® 3.0 Image Item (*.max)
- Windows Bitmap (*.bmp)
- PC Paintbrush (*.pcx)
- PCX Multi-page (*.dcx)
- JPEG (*.jpg)
- TIFF-Uncompressed (*.tif)
- TIFF Group 4 (*.tif)
- Multi-Page -Uncompressed (*.tif)
- Multi-Page - Group 4 (*.tif)

Scanner settings

You have the ability to change the scanner settings used to create the file attachments. Click on the Scan Settings tab and select the appropriate settings.

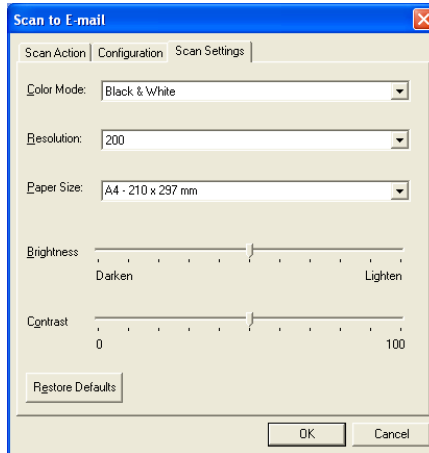

Scan to OCR (Word Processing program)

Scan to OCR converts the graphic page image data to text which can be edited by any word processor program. You can change the default word processor program (example: Word Pad instead of Word) and file type. You can also choose another OCR software package besides the TextBridge® OCR which is built into PaperPort®.

To configure Scan to OCR right-click on the WordPad button and select Configuration. The Scan Action tab is set to OCR and should not be changed.

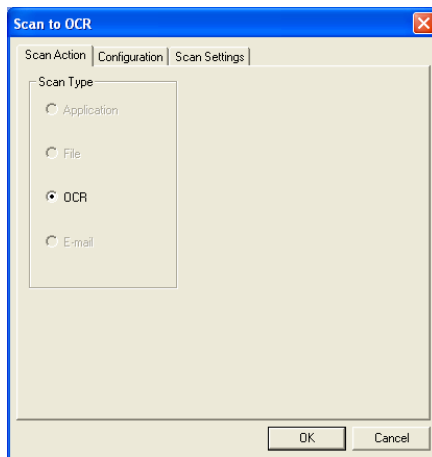

To change the word processing application click on the Configuration Tab. You can select the destination word processing application from the Application pull down list.

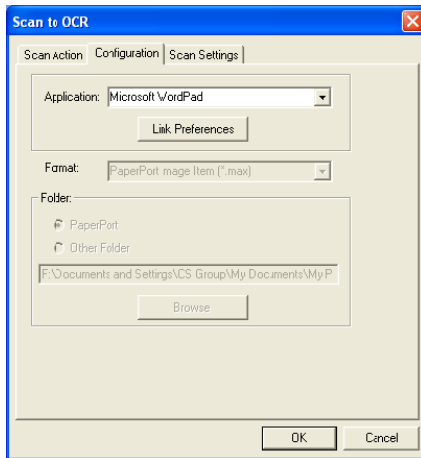

To change the program link preferences click the Link Preferences button.

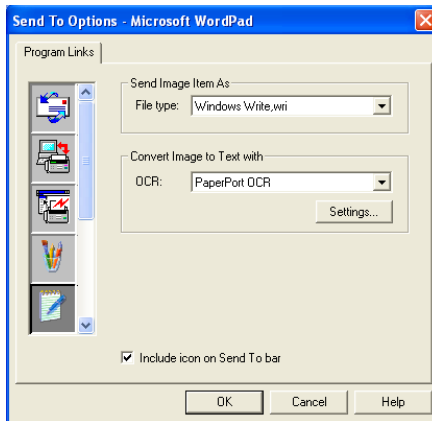

File Type—From the pull-down list, select the file format you want to use for documents.

OCR—Select the OCR application from the OCR pull down list.

Scan to Graphics application (example: Microsoft Paint)

The Scan to Graphics Application allows you to scan an image so you can edit the image. To change the default graphics application right-click on the button and select Configuration.

The Scan Action tab is set to Application and should not be changed.

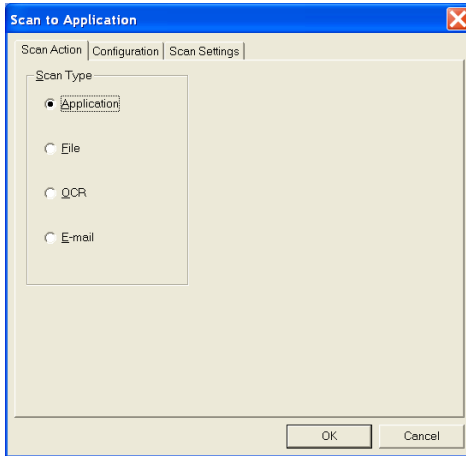

To change the configuration of the destination application click on the Configuration Tab.

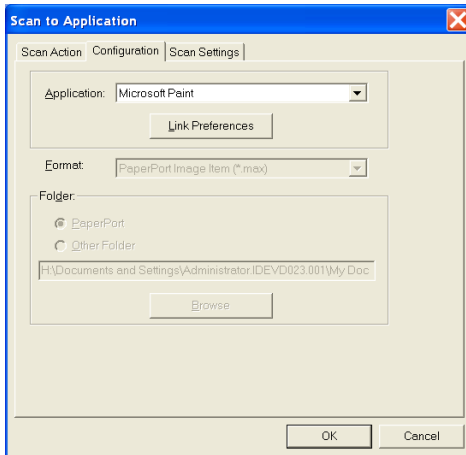

To change the destination application select the appropriate application from the Application pull down list.

To change the other configuration options click the Link Preferences button.

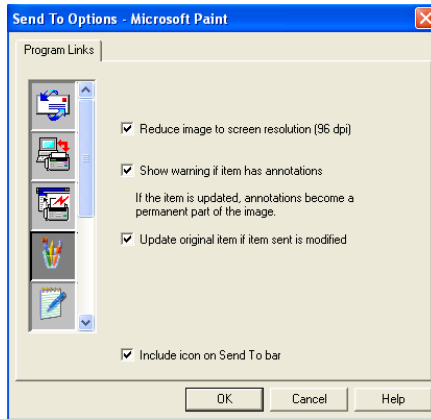

This option enables you to reduce image to screen resolution (96dpi), show a warning if the item has annotations, update the original item if sent item is modified, if needed.

Copy

The copy buttons can be customized to allow you to take advantage of the features built into the Brother printer drivers to do advanced copy functions such as n-in-1 printing.

The Copy buttons are automatically linked to the default Windows® printer driver. You can set any printer as the default printer including non-Brother printers. Before you can use the Copy buttons you must first configure the printer driver by right-clicking on a Copy button and selecting Configuration.

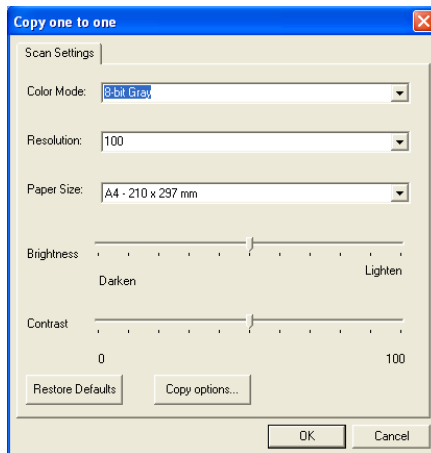

In the Scan Settings window you can select the color mode, resolution, paper size, brightness and contrast settings to be used. To finish the Copy button configuration you must set the printer driver. Click the Copy options button to display the printer driver settings.



The copy options screen will vary depending upon which Brother model you purchased.

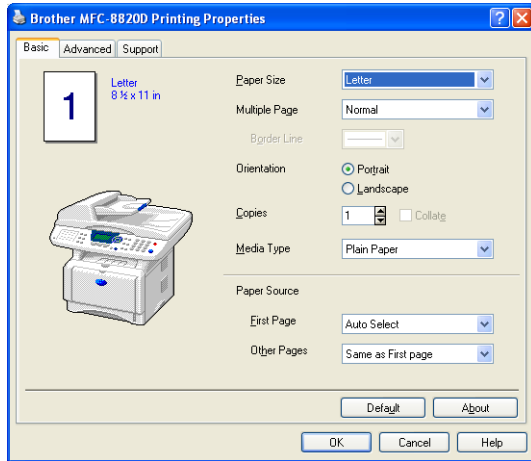

Select the number of Pages Per Sheet from the Scaling selections. As an example to configure the section Copy button to copy two pages to one you must select 2 in 1.



You must configure each of the copy buttons before they can be used.

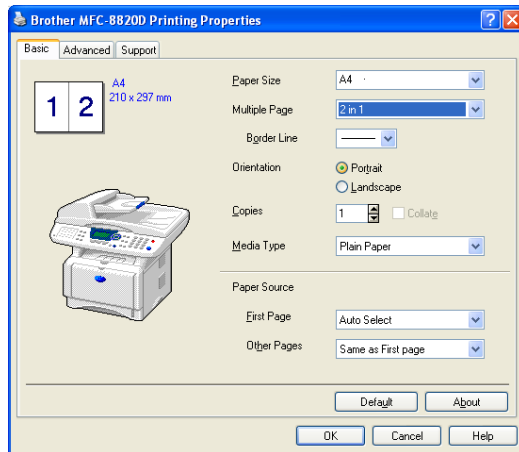

Fax setting (PC-Fax using the Brother Fax Driver)

The MFC includes a PC-Fax driver, which allows any Windows® Application to send a Fax as simply as printing a document. The Brother SmartUI automatically configures the Fax button to use the Brother PC-FAX driver no user configuration is required.

The Scan Action tab is set to Application and should not be changed.

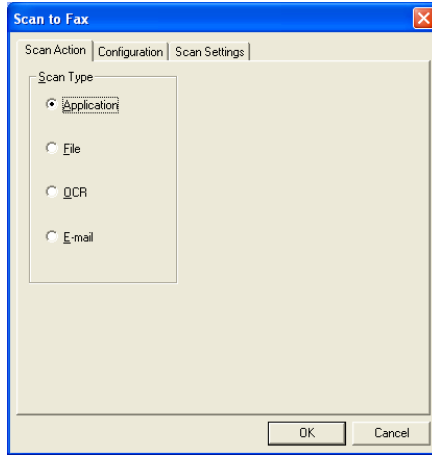

To change the PC-FAX settings click the Link Preferences button, found in the Configuration tab.

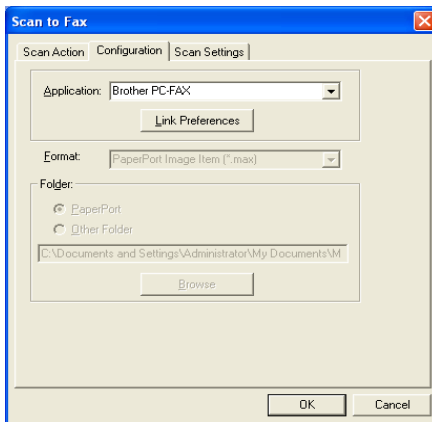

FAX settings

Brother PC-FAX

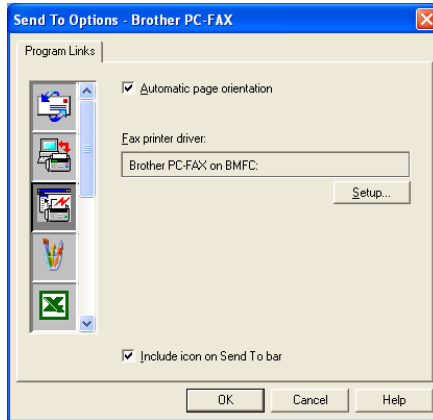

To change the driver settings, click on the Setup button.

Select the *Paper Size*, *Paper Source*. If you need more customized setup, click on the Options button.

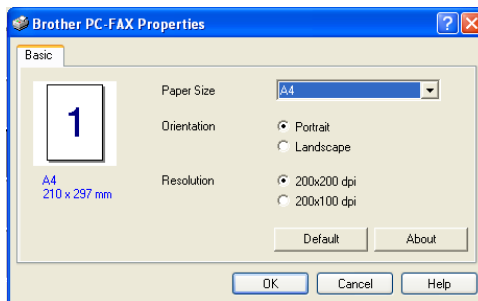
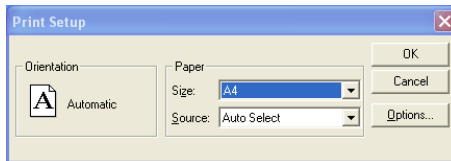

Select the *Paper Size*, *Orientation* (Portrait or Landscape) and *Resolution* (200x200 dpi or 200x100 dpi), and click **OK**.

To return to the factory default settings, click the **Default** button.

Custom: User-defined buttons

There are up to three Custom buttons on the Brother SmartUI Control Center. (NOTE: The number of Custom buttons depends on which Brother model you purchased.) You can set your own preferences and configuration to fit your required application.

To configure a Custom Button right click on the button and then click Configuration. The configuration window will appear. You have four function choices Application, File, OCR and E-mail.

Application: This setting will link the Control Panel button to any button which appears on the PaperPort® Send to Bar. Please see the PaperPort® help file for more information regarding PaperPort® compatible applications.

File: This setting allows you to save a scanned image to any directory on local or network hard disk. You can also select the file format to be used.

OCR: Scanned documents will be converted to editable text files. If you have a third party OCR software package installed on your PC you can select it. The default OCR software is TextBridge® which is built into PaperPort® 8.0 SE. You can also select the destination word processor and file format for the editable text.

E-mail: Scanned images will be attached to an E-mail message. You can choose which E-mail package to use if you have more than one installed on your system. You can also select the file type for the attachment and create a quick send list of E-mail addresses chosen from your default E-mail address book.

Customizing a user-defined button

To configure a Custom button right-click on the button and then click Configuration. Please follow the following guide lines for Custom Button configuration.

1. Select the Scan Action

Select the type of scan by clicking the appropriate button.

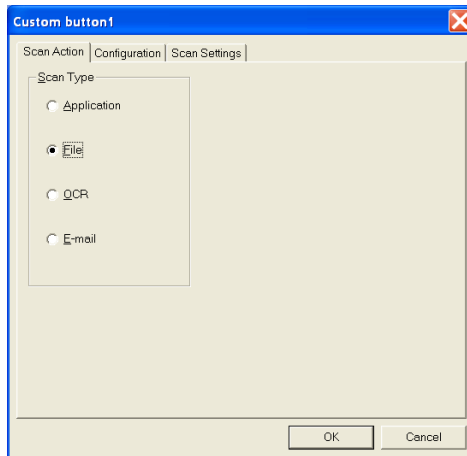

2. Select Configuration for the Scan Type.

To configure the scan operation click on the Configuration Tab. Depending upon which Scan Type button you selected you will see a different Configuration Tab list of settings.

Application:

Select the destination application program from the pull down list.

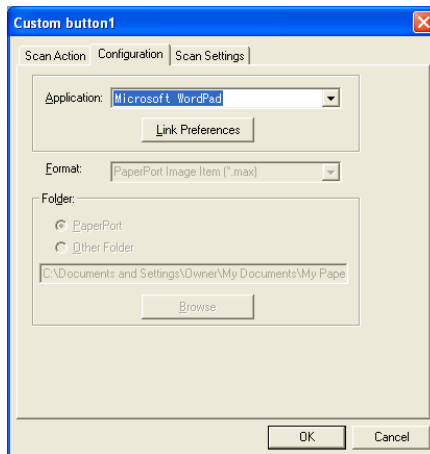

Click on Link Preferences to set the Send to options. You can select the application from the scroll menu on the left.

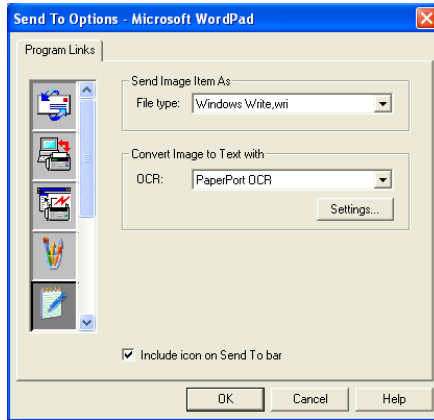

File:

Select the file format from the Format pull down list. You can either send the file to the default PaperPort® directory or select your own destination directory by selecting Other Folder. Use the Browse button to select the destination directory.

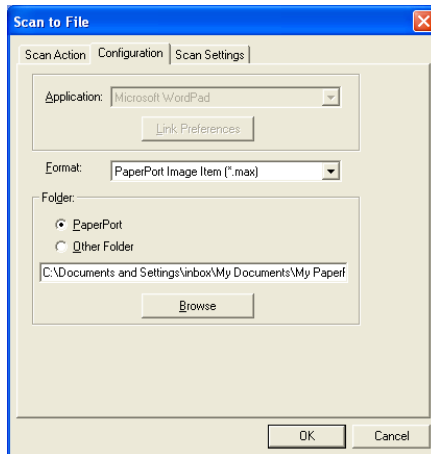

OCR:

Select the destination word processing application program from the pull down list.

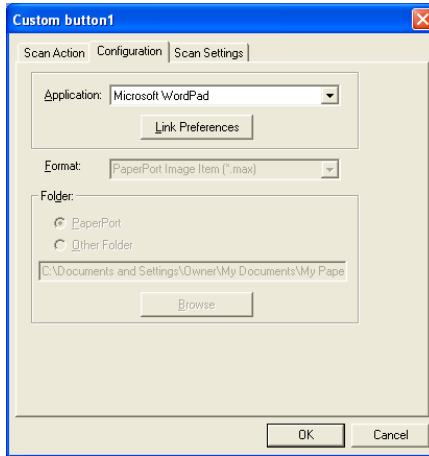

Click on Link Preferences and select the destination Application from the scroll menu on the left. Select the File Type from the File Type pull down list. You can also choose another OCR application from the OCR pull down list if another is installed on you system. Scansoft® TextBridge® is installed as part of the PaperPort® 8.0 SE application.

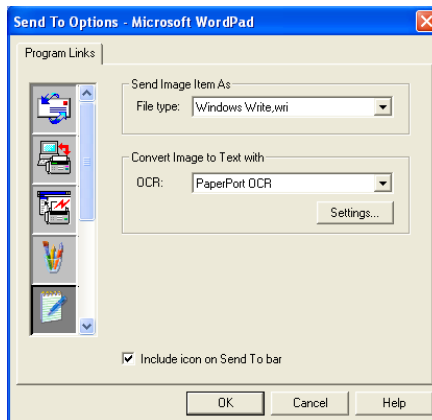

E-mail:

Select the destination E-mail application program from the pull down list.

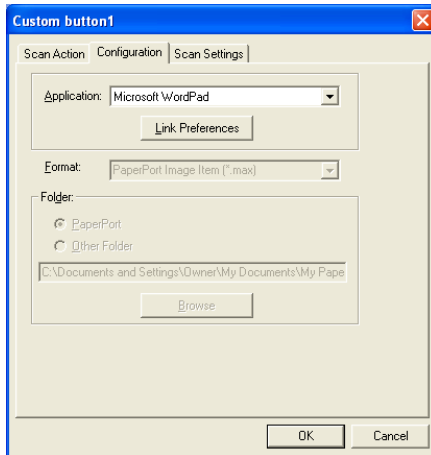

Click on the **Link Preferences** button to configure the Send To E-mail options. You can select the File type and Quick Send E-mail address list.

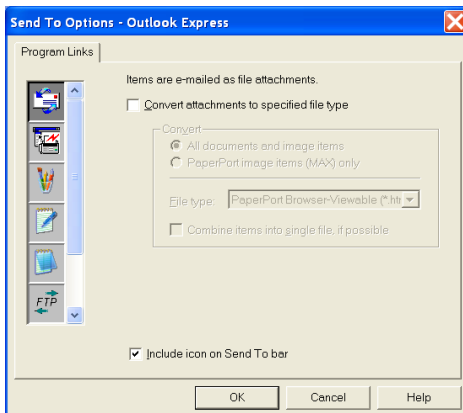

3. Select Scan Settings.

You can select the scanner settings from each of the Scan Type options for the Custom buttons. You have the option to select Color Mode, Resolution, Paper Size and Brightness and Contrast settings.

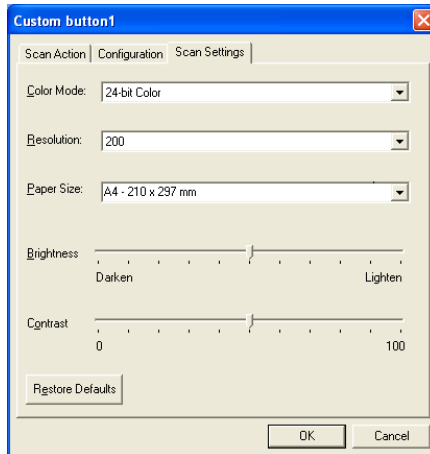

16 Using MFC Remote Setup

(For Windows®)

MFC Remote Setup

The MFC Remote Setup application lets you set up your MFC by using the ease and speed of programming on your PC. When you access this application, the settings on your MFC will be downloaded to your PC and displayed on your computer screen. If you change the settings, you can upload them directly to the MFC.



You can't use the MFC Remote Setup application if your MFC is only connected to a Network with the optional Network LAN board (NC-9100h). (See Web Based Management in the NC-9100h User's Guide.)

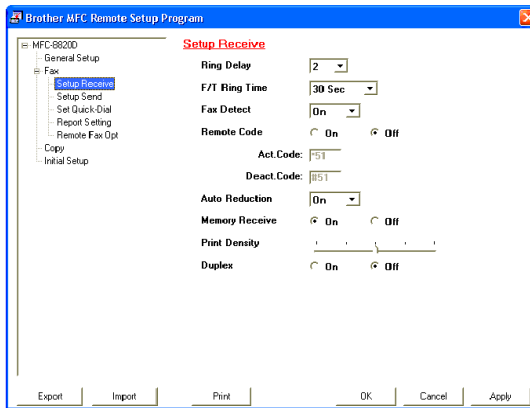

OK button

When you click **OK**, the process of uploading the data to the MFC begins. The MFC Remote Setup program is closed if an error message is displayed, enter the correct data again and then click **OK**.

Cancel button

The **Cancel** button clears your changes and exits the MFC Remote Setup application without uploading any data to the MFC.

Apply button

The **Apply** button uploads the data to the MFC, but stays in the Remote Setup application so you can make more changes.

Print button

The **Print** button prints the selected items on the MFC. You cannot print the MFC Remote Setup changes until you click the **Apply** button to upload the new data to the MFC. Then you can click the **Print** button to get an up-to-date printout.

Export button

Click the **Export** button to save your current settings to a file.

Import button

Click the **Import** button to read the settings from your saved file into the MFC Remote Setup screen.



You can use the **Export** and **Import** buttons to save and use several sets of settings for your MFC.

Using Brother PC-FAX software

(For Windows®)

PC-FAX sending

The Brother PC-FAX feature lets you send a file from your PC.

You can create a file in any application on your PC, and then send it as a PC-FAX. You can even attach a cover page note.

All you have to do is set up the receiving parties as Members or Groups in your PC-FAX Address Book. Then you can use the Address Book Search feature to quickly find them to address your fax.



- PC-FAX is available in Black & White only.
- If you are using Windows® XP, Windows NT® 4.0 or Windows® 2000 Professional, we recommend that you are logged on with administrator rights.

Setting up user information



You can access the User Information from the FAX Sending dialog box by clicking .

(See *Sending a file as a PC-FAX using the Facsimile style* on page 17-16.)

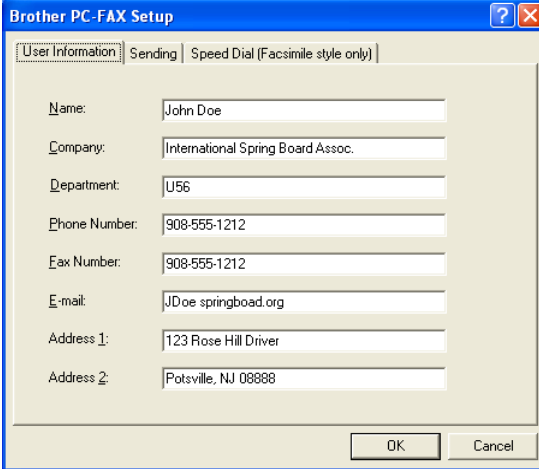

The screenshot shows the 'Brother PC-FAX Setup' dialog box with the 'User Information' tab selected. The dialog box contains the following fields and values:

Field	Value
Name:	John Doe
Company:	International Spring Board Assoc.
Department:	U56
Phone Number:	908-555-1212
Fax Number:	908-555-1212
E-mail:	JDoe@springboard.org
Address 1:	123 Rose Hill Drive
Address 2:	Potsville, NJ 08888

At the bottom of the dialog box are 'OK' and 'Cancel' buttons.

- 1 From the **Start** menu, select **Programs, Brother, Brother MFL-Pro Suite**, and then select **PC-FAX Setup**. The **Brother PC-FAX Setup** dialog box will appear:
- 2 You must enter this information to create the Fax Header and Cover Page.
- 3 Click **OK** to save the **User Information**.

Sending setup

From the **Brother PC-FAX Setup** dialog box, click the **Sending** tab to display the screen below.

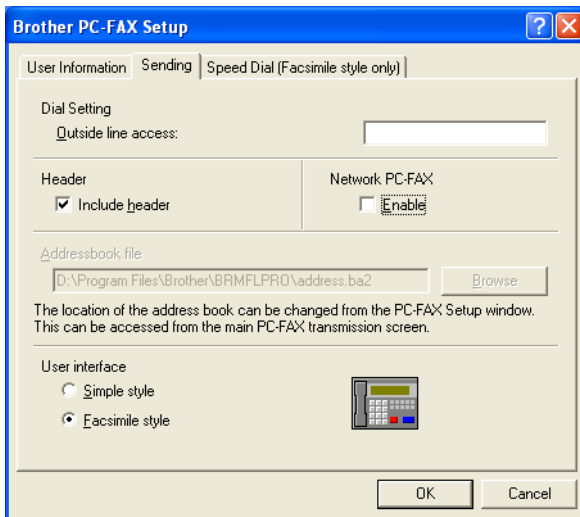

The include header option sends an additional page of information along with fax or E-mail data which contains user and subject information.

The user has the choice of two user interfaces: Simple style or Facsimile style. To change the user interface select the interface setting you want: Simple style or Facsimile style.

Outside line access

If you need to enter a number to access an outside line, enter it here. This is sometimes required by a local PBX telephone system (for example, if you must dial 9, to get an outside line in your office).

Include header

To add header information to the top of the fax pages you send, check the Include header box.

Address Book file

You can select more than one database file to use with the Address Book. To select you must enter the path and file name of the database file.

—OR—

Use the **Browse** button to find the database to select.

User interface

In the **Sending** tab, select user interface.

You can choose the **Simple Style** or the **Facsimile Style**.

Simple style

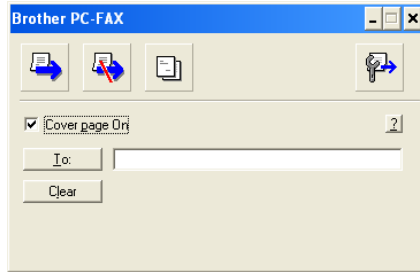

Facsimile style



Speed-Dial setup

From the **Brother PC-FAX Setup** dialog box, click the **Speed Dial** tab. (To use this feature you must select the **Facsimile Style** user interface.)

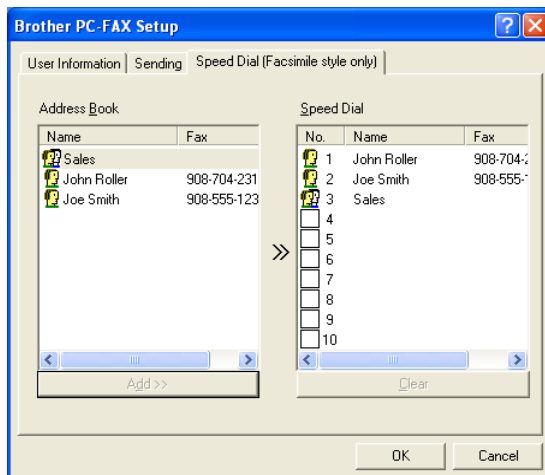

You can register a Member or Group on each of the ten Speed-Dial buttons.

To register an address in a Speed-Dial button:

- 1 Click the Speed-Dial button you want to program.
- 2 Click the Member or Group you want to store on the Speed-Dial button.
- 3 Click **Add >>** to save it.

To clear a Speed-Dial button:

- 1 Click the Speed-Dial button you want to clear.
- 2 Click **Clear** to erase it.

The Address Book

From the **Start** menu, select **Programs, Brother, Brother MFL-Pro Suite**, and then click **PC-FAX Address Book**.

The **Brother Address Book** dialog box will appear:

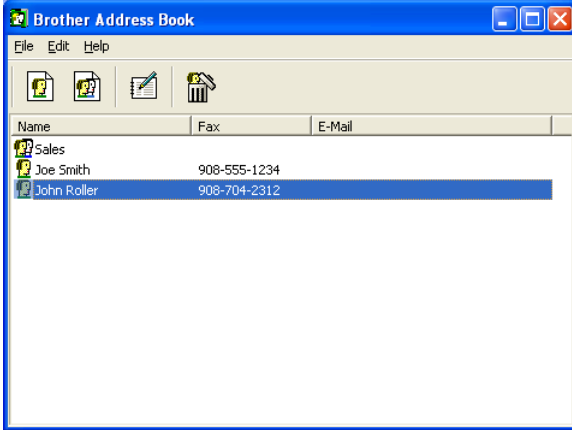



Setting up a Member in the Address Book

In the **Brother Address Book** dialog box you can add, edit and delete stored information of Members and Groups.

- 1 In the Address Book dialog box, click the  icon to add a Member.

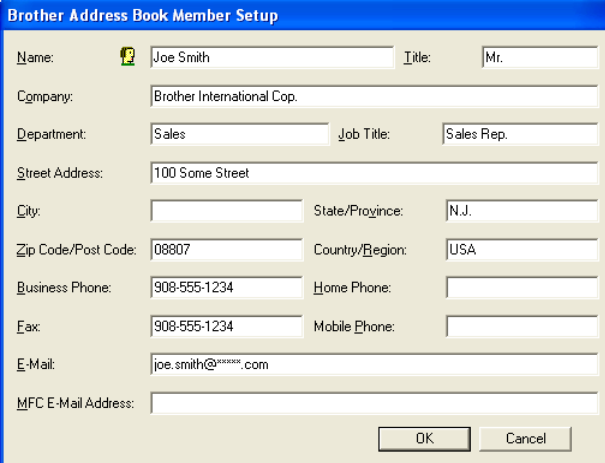
The **Brother Address Book Member Setup** dialog box will appear:



Name:	 Joe Smith	Title:	Mr.
Company:	Brother International Cop.		
Department:	Sales	Job Title:	Sales Rep.
Street Address:	100 Some Street		
City:		State/Province:	N.J.
Zip Code/Post Code:	08807	Country/Region:	USA
Business Phone:	908-555-1234	Home Phone:	
Fax:	908-555-1234	Mobile Phone:	
E-Mail:	joe.smith@*****.com		
MFC E-Mail Address:			

OK Cancel

- 2 In the Member Setup dialog box, type the Member's information. **Name** is a required field. Click **OK** to save the information.

Setting up a Group for Broadcasting

If you often send the same PC-FAX to several Members, you can combine them in a Group.

- 1 In the **Brother Address Book** dialog box, click the  icon to create a Group.

The Group Setup dialog box appears:

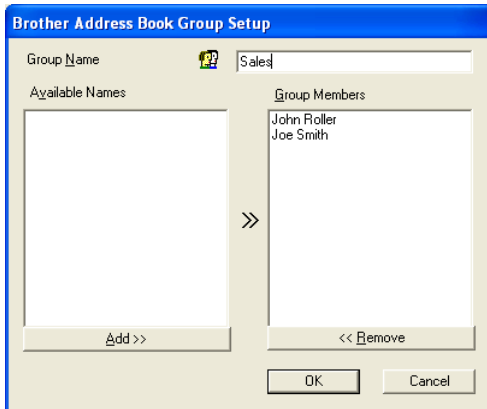

- 2 Type the name of the new Group in the **Group Name** field.
- 3 In the **Available Names** box, select each Member to be included in the Group, and then click **Add >>**.
Members you add to the Group will be added to the **Group Members** box.
- 4 After all the members you want have been added, click **OK**.

Editing Member information

- 1 Select the Member or Group you want to edit.
- 2 Click the edit  icon.
- 3 Change the Member or Group information.
- 4 Click **OK** to save your changes.



Deleting a Member or Group

- 1 Select the Member or Group you want to delete.
- 2 Click the delete  icon.
- 3 When the **Confirm Item Delete** dialog box appears, click **OK**.

Exporting the Address Book

You can export the whole Address Book to an ASCII text file (*.csv). Or if you wish, you can select and create a Vcard that will be attached to that Member's outgoing E-mail. (A Vcard is an electronic business card that contains the sender's contact information.)

To export the whole current Address book:

-  If you are creating a Vcard, you must first select the member.
If you select Vcard in Step 1, **Save as type:** will be **Vcard (*.vcf)**.
- 1 From the Address Book select **File**, point to **Export**, and then click **Text**.
—OR—
Click **Vcard** and go to Step 5.
 - 2 From the **Available Items** column, select the data fields you wish to Export and then click **Add >>**.
-  Select the items in the order you want them listed.

- 3 If you are exporting to an ASCII file, select the **Divide Character - Tab** or **Comma**. This selects between a **Tab** or **Comma** to separate the data fields.
- 4 Select **OK** to save the data.

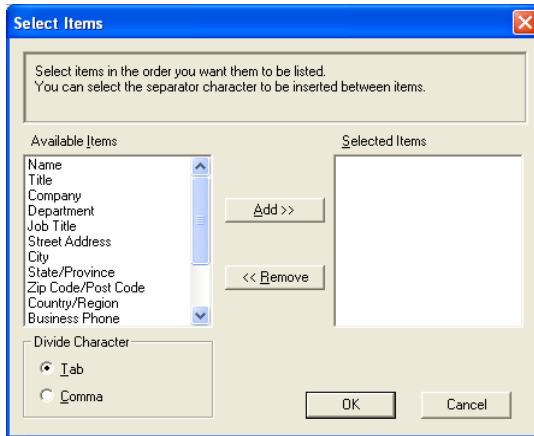

- 5 Type the name of the file, and then select **Save**.

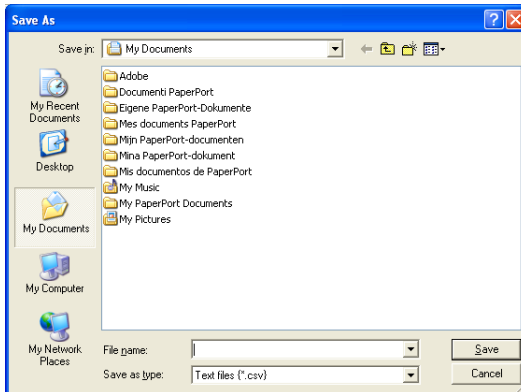

Importing to the Address Book

You can import ASCII text files (*.csv) or Vcards (electronic business cards) into your Address Book.

To import an ASCII text file:

- 1 From the Address Book select **File**, point to **Import**, and then click **Text**.

—OR—

Click **Vcard** and go to Step 5.

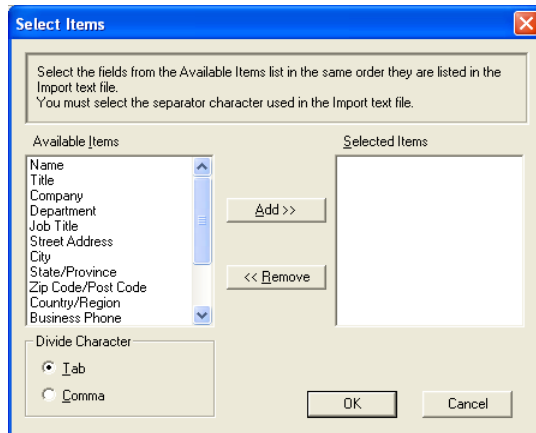

- 2 From the **Available Items** column select the data fields you want to Import, and click **Add >>**.
-  From the Available Items list select the fields in the same order they are listed in the Import text file.
- 3 Select the **Divide Character** - **Tab** or **Comma** based on the file format you are importing.
- 4 To import the data click **OK**.

5 Type the name of the file, and then select **Open**.

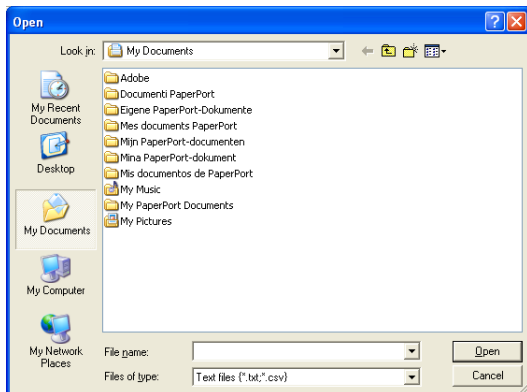

 If you selected a text file in Step 1, the **Files of type:** will be **Text file (*.csv)**.



Setting up a Cover Page

From the PC-FAX dialog box click . To access the PC-Fax Cover page setup screen. (See *Sending a file as a PC-FAX using the Facsimile style* on page 17-16.)

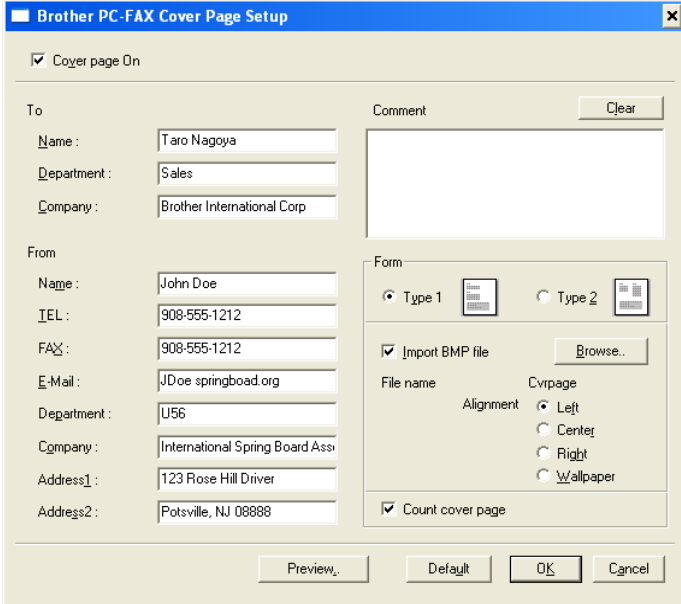
The **Brother PC-FAX Cover Page Setup** dialog box will appear:



The dialog box is titled "Brother PC-FAX Cover Page Setup" and has a close button (X) in the top right corner. It contains the following fields and options:

- Cover page On
- To:**
 - Name: Taro Nagoya
 - Department: Sales
 - Company: Brother International Corp
- Comment:** A large empty text area with a "Clear" button to its right.
- From:**
 - Name: John Doe
 - TEL: 908-555-1212
 - FAX: 908-555-1212
 - E-Mail: JDoe.springboard.org
 - Department: U56
 - Company: International Spring Board Ass
 - Address1: 123 Rose Hill Driver
 - Address2: Potsville, NJ 08888
- Form:**
 - Type 1 (selected)  Type 2 
 - Import BMP file 
 - File name: _____
 - Alignment: Left Center Right
 - Cvrpage: Wallpaper
 - Count cover page

Buttons at the bottom:

You can enter information in each field



If you are sending a fax to more than one recipient, the recipient information will not be printed on the Cover Page.

To

From

Comment

Type the comment you want to add to the cover page.

Select Cover Page Form

Select the cover page format you want to use.

Import BMP file

You can insert a bitmap file, such as your company logo, in the cover page.

Use the browse button to select the BMP file, and then select the alignment style.

Count cover page

When the Count Cover Page box is checked, the Cover Page will be included in the page numbering. When this box is not checked, the Cover Page will not be included.

Sending a file as a PC-FAX using the Facsimile style

- 1 Create a file in Word, Excel, Paint, Draw or any other application on your PC.
- 2 From the **File** menu, select **Print**.
The **Print** dialog box will appear:

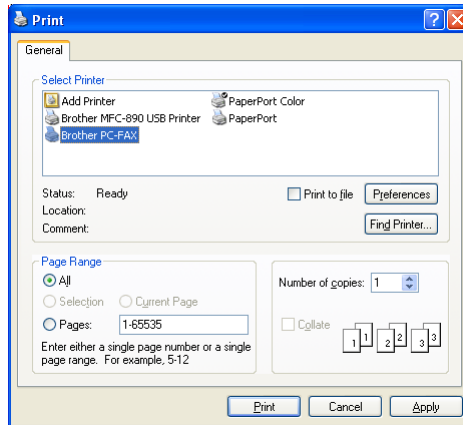



- 3 Select **Brother PC-FAX** as your printer, and then click **OK**.
The Fax Sending dialog box will appear.



- 4 Enter the fax number using any of the following methods:
 - Using the dial pad enter the number.
 - Click any of the 10 **Speed-Dial** buttons.
 - Click the **Address Book** button, and then select a Member or Group from the Address Book.



If you make a mistake you can click **Clear** to delete all the entries.

- 5 To include a Cover Page, click  **Cover Page On**, and then click the Cover Page  icon to enter or edit the Cover Page information.

- 6 Click **Start** to send the fax.



If you want to cancel the fax, click **Stop**.

Redial

If you want to redial a number, click **Redial** to scroll through the last five fax numbers, and then click **Start**.

Sending a file as a PC-FAX using the Simple style

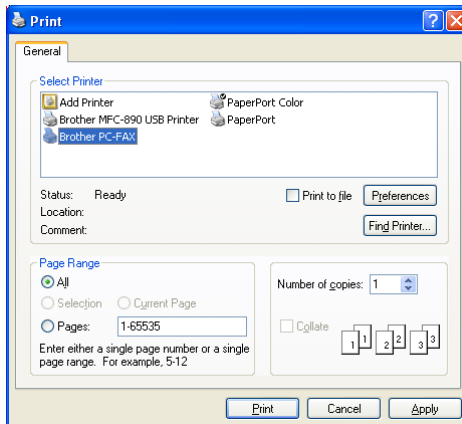

- 1 Create a file in Word, Excel, Paint, Draw or any other application on your PC.
- 2 From the **File** menu, select **Print**.
The **Print** dialog box will appear:



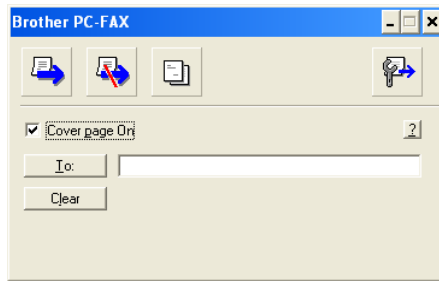

- 3** Select **Brother PC-FAX** as your printer, and then click **OK**.
The FAX Sending dialog box will appear:



- 4** In the **To:** field, type the fax number of the recipient. You can also use the Address Book to select destination fax numbers by clicking the **To:** button. If you made a mistake entering a number, click the **Clear** button to delete all the entries.
- 5** To send a Cover Page and note, click the **Cover Page On** check box.

 You can also click the  icon to create or edit a cover page.

6 When you are ready to send your fax, click the Send .

7 If you wish to cancel the fax, click the Cancel .

Setting up PC-FAX receiving (Windows® 95/98/98SE/Me/2000 Professional and Windows NT® WS 4.0 only)

Running PC-FAX Receiving

From the **Start** menu, select **Programs, Brother, Brother MFL-Pro** and then select '**PC-FAX Receiving**'.

The PC-FAX  icon will appear on your PC Task bar for this Windows® session.

Setting up your PC

- 1 Right-click the PC-FAX  icon on your PC Task Bar, and then click **PC-Fax RX Setup**.
- 2 The PC-Fax RX Setup dialog box will appear:

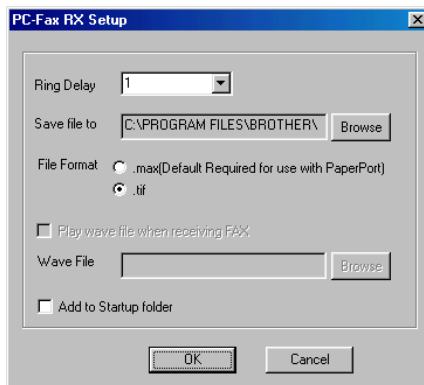

- 3 In **Ring Delay**, select the number of rings before you want your PC to answer Incoming calls.
- 4 In **Save file to**, use the Browse button if you want to change the path where PC-FAX files will be saved.

- 5 In **File Format**, select **.tif** or **.max** for the format the received document will be saved in. The default format is **.tif**.
- 6 If you want to, you can check the **Play wave file when receiving FAX** check box, and then enter the path.
- 7 To load PC FAX receiving automatically when you start up Windows®, select the **Add to Startup folder** check box.

Viewing new PC-FAX messages

Each time you start to receive a PC-FAX, the icon will flash  blue and red. Once the fax has been received the icon will remain red. The red icon will change to green once the received fax has been received.

- 1 Run PaperPort®.
- 2 Open the Fax Received folder.
- 3 Double-click any of the new faxes to open and view them.

 The title of your unread PC message will be the date and time until you assign a file name.

For example “Fax 2-20-2002 16:40:21.tif”

Receiving a fax into the PC (Windows® XP only)

How to receive a fax automatically

Before you can start receiving faxes, please install the appropriate Windows® XP driver (Windows® XP In-box driver or Brother Windows® XP driver). After the driver is installed, refer to the following information to configure your Windows® XP PC for Fax receiving.

- 1 To activate Fax receiving, click **Set up faxing** in the **Printer Tasks** menu.

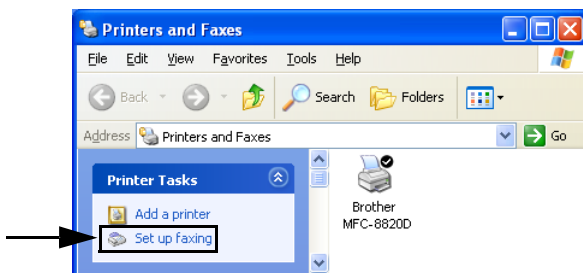

- 2 The FAX services will be installed on your PC.

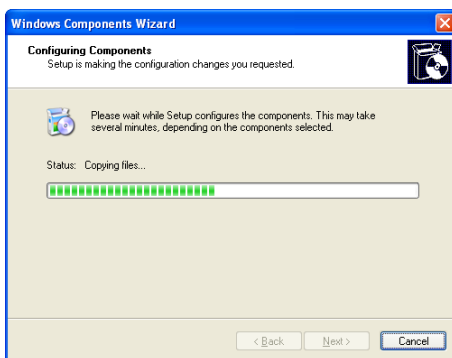

- 3 A **Fax** icon will then appear in the **Printers and Faxes** folder. If the **Fax** icon does not appear, click **Install a local fax printer** in the **Printer Tasks** menu.

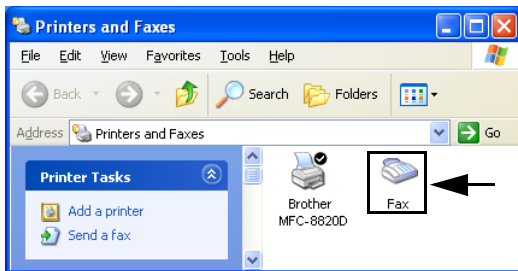

- 4 Select the **Start, All Programs, Accessories, Communications, Fax, Fax Console**.



If you have not configured your fax connection, the following screen will be displayed.

Enter your details, ensuring you specify the outside line access number if necessary and click **OK**.

Select the **My location** button if it is not selected and then click **OK**.

- 5 The **Fax Configuration Wizard** starts. Click **Next**.

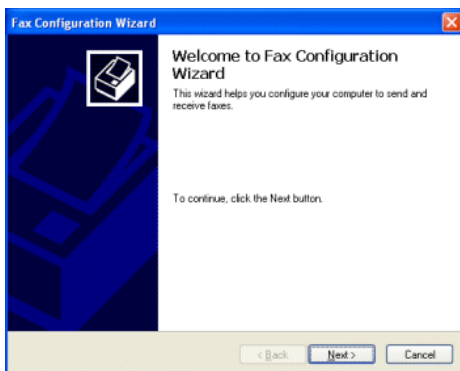

6 Enter the sender information, and then click **Next**.

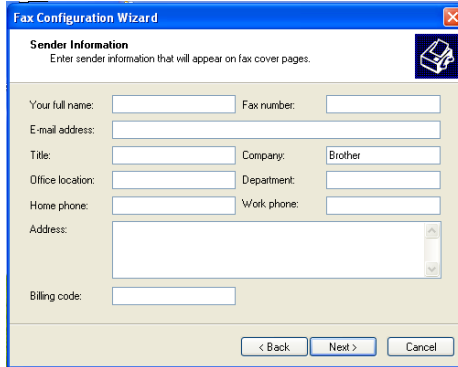

The screenshot shows the 'Sender Information' step of the Fax Configuration Wizard. The window title is 'Fax Configuration Wizard'. Below the title bar, the text reads 'Sender Information' and 'Enter sender information that will appear on fax cover pages.' There is a printer icon in the top right corner. The form contains several input fields: 'Your full name:', 'Fax number:', 'E-mail address:', 'Title:', 'Company:' (with 'Brother' entered), 'Office location:', 'Department:', 'Home phone:', 'Work phone:', 'Address:' (a text area), and 'Billing code:'. At the bottom, there are three buttons: '< Back', 'Next >', and 'Cancel'.

7 Select **Brother MFC-8420** or **MFC-8820D** in the **Please select the fax device** pull-down list. Click to select **Enable Receive** check box. Specify the number of rings before your MFC will attempt to answer the fax. Click **Next**.

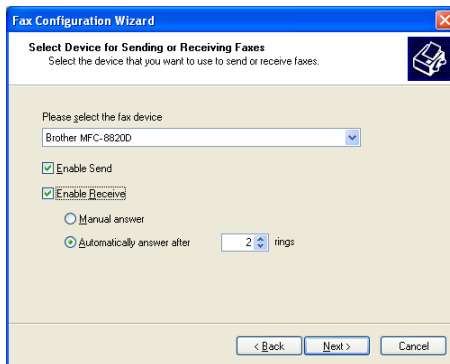

The screenshot shows the 'Select Device for Sending or Receiving Faxes' step of the Fax Configuration Wizard. The window title is 'Fax Configuration Wizard'. Below the title bar, the text reads 'Select Device for Sending or Receiving Faxes' and 'Select the device that you want to use to send or receive faxes.' There is a printer icon in the top right corner. The form contains a pull-down menu labeled 'Please select the fax device' with 'Brother MFC-8820D' selected. Below the menu are two checked checkboxes: 'Enable Send' and 'Enable Receive'. Under 'Enable Receive', there are two radio button options: 'Manual answer' and 'Automatically answer after'. The 'Automatically answer after' option is selected, and a spin box next to it shows the number '2' with 'rings' to its right. At the bottom, there are three buttons: '< Back', 'Next >', and 'Cancel'.

- 8 Enter the **Transmitting Subscriber Identification (TSID)**, and then click **Next**.

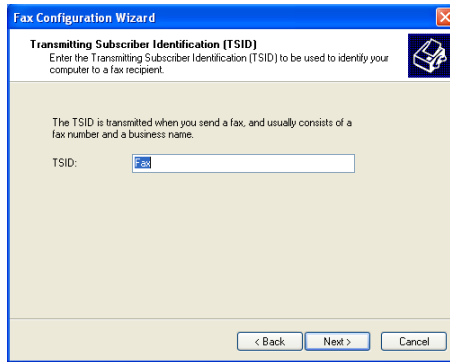

- 9 Enter the **Called Subscriber Identification (CSID)**, and then click **Next**.

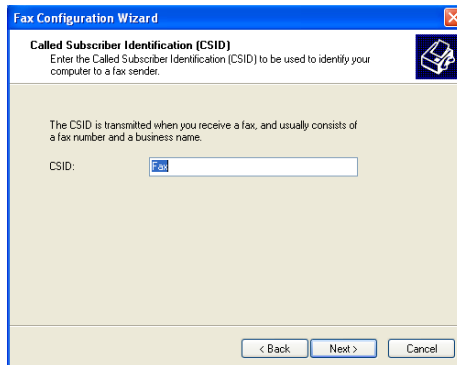

10 Select if you print a received fax or save it in a folder, and then click **Next**.

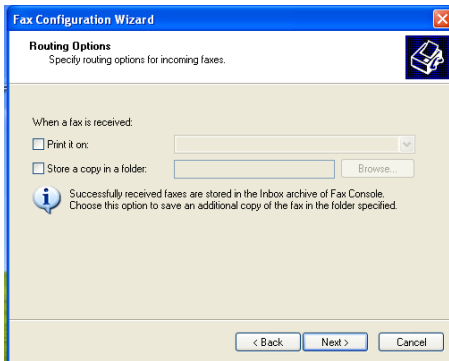

11 Click **Finish**.



When PC-FAX Receiving is active, you cannot run the Remote Setup utility. To use Remote Setup, check off **Enable Receive** in Step 7.

For information on how to use PC-FAX Sending and Receiving, please refer to Help in the **Fax Console**.

The PC-FAX installation is now complete.

How to view the received faxes

Faxes that are received into the PC will appear in the Fax Console. Click **Start**, point to **All Programs, Accessories, Communications, Fax**, and then click **Fax Console** to open the **Fax Console**. In the left pane, expand the Fax folder (if it is not already expanded).

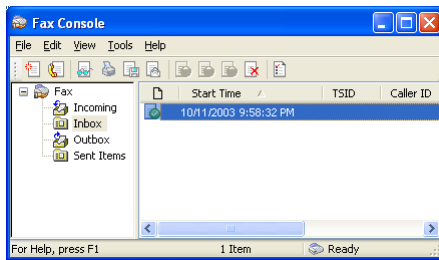

The Fax folder contains the following folders:

- The Incoming folder contains faxes that are currently being received.
- The Inbox folder contains faxes that have been received.
- The Outbox folder contains faxes that are scheduled to be sent.
- The Sent Items folder contains faxes that have been successfully sent.

18 Using your MFC with a Macintosh®

Setting up your USB-equipped Apple® Macintosh®



- Before you can connect the MFC to your Macintosh®, you must buy a USB cable that is not longer than 1.8 metres. **Do not connect the MFC to a USB port on a key board or a non-powered USB hub.**
- Some descriptions in this chapter are based on the MFC-8820D. These descriptions also apply to the MFC-8420.

The features supported by the MFC will depend on the operating system you are using. The chart below shows which features are supported.

Feature	Mac OS®		Mac OS® X	
	8.6	9.X	10.1	10.2.1 or greater*1
Printing	Yes	Yes	Yes	Yes
Scanning (TWAIN)	Yes	Yes	No	Yes
PC-FAX sending	Yes	Yes	Yes	Yes
Remote Setup	No	No	Yes	Yes

*1 For Mac OS® X 10.2 users, please upgrade to Mac OS® X 10.2.1 or greater. (For the latest information for Mac OS® X, please visit at: <http://solutions.brother.com>)

Using the Brother printer driver with your Apple® Macintosh® (Mac OS® 8.6 - 9.2)

To select a Printer:

- 1 Open the **Chooser** from the Apple menu.

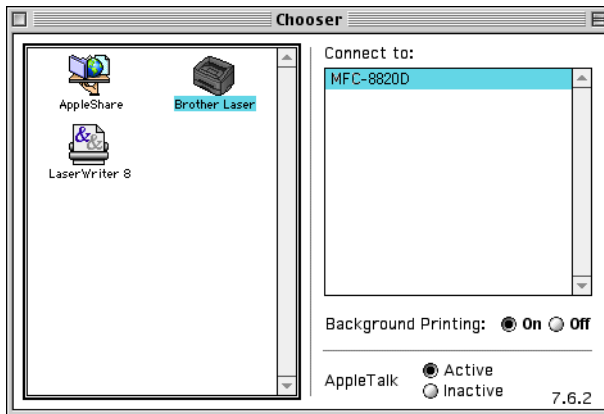

- 2 Click the **Brother Laser** icon. On the right side of the **Chooser** window, click the printer you want to print to. Close the **Chooser**.

To print a document:

- 1 From the application software such as Presto!® PageManager®, click **File** menu and select **Page Setup**. You can change the settings for **Paper Size**, **Orientation**, and **Scaling**, and then click **OK**.

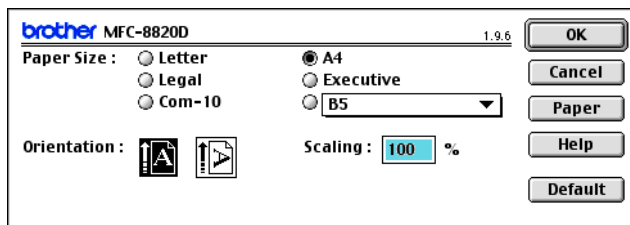

- 2 From application software such as Presto!® PageManager®, click **File** menu and select **Print**. Click **Print** to start printing.

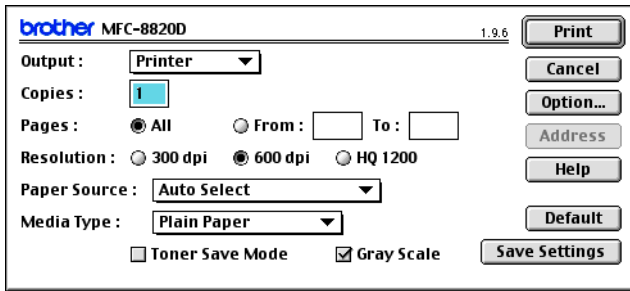

If you want to change **Copies**, **Pages**, **Resolution**, **Paper Source** and **Media Type**, select your settings before clicking **Print**.

Device Options allows you to select **Duplex**.

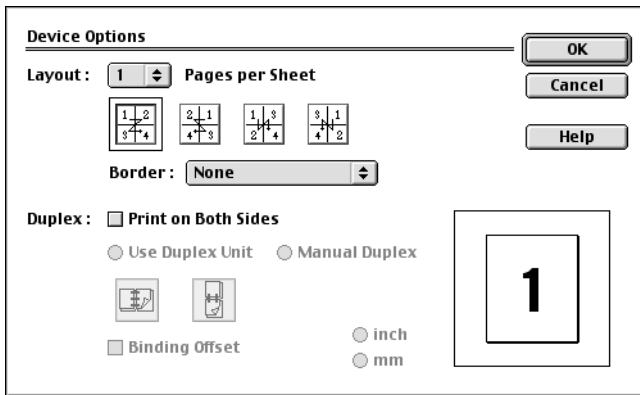

Automatic Duplex is only available with the MFC-8820D.

Using the Brother Printer Driver with Your Apple® Macintosh® (Mac OS X)

Choosing page setup options

- 1 From application software such as Presto!® PageManager®, click the **File** menu and select **Page Setup**. Make sure *MFC-8420* and *MFC-8820D* is selected in the **Format for** pop-up menu. You can change the settings for **Paper Size**, **Orientation** and **Scaling**, then click **OK**.

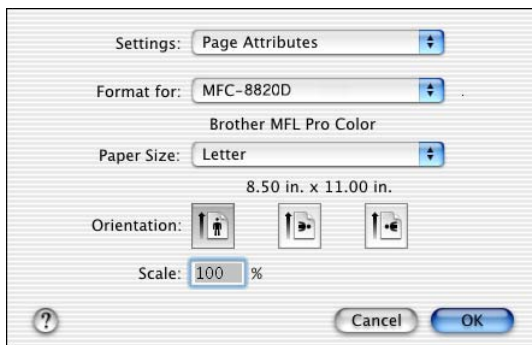

- 2 From application software such as Presto!® PageManager®, click **File** menu and select **Print**. Click **Print** to start printing.

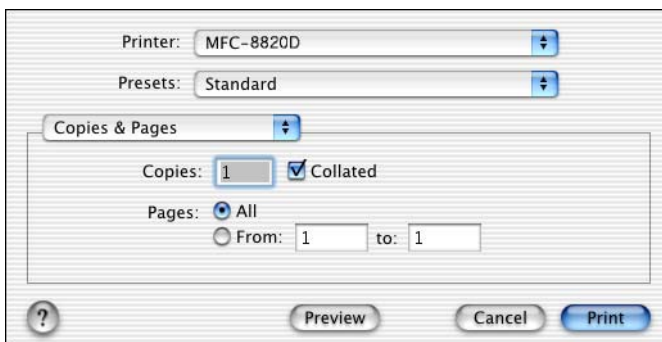

Specific settings

Set the **Media Type**, **Resolution**, and other settings.

Press **Copies & Pages** to select settings you want to change.

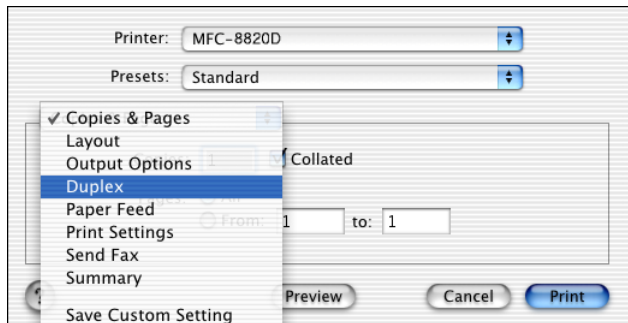

Duplex

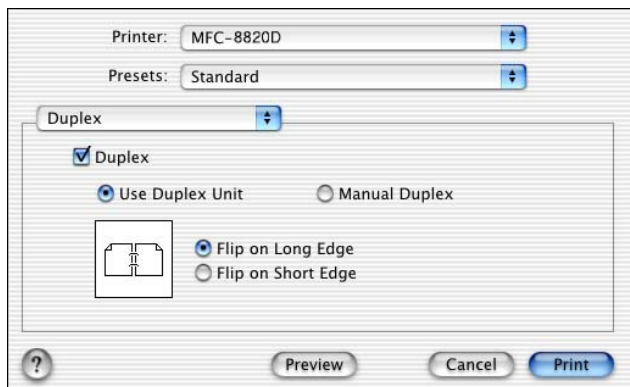

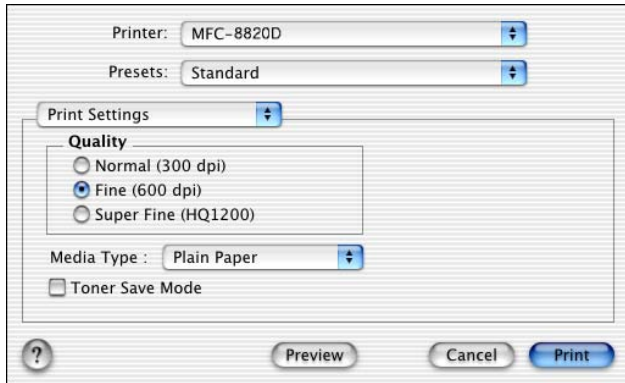

Automatic Duplex is only available with the MFC-8820D.

Print settings



Using the PS driver with your Apple[®] Macintosh[®]

-  To use the PS driver on a Network, see the NC-9100h Network User's Guide on CD-ROM.
-  To use the PS driver with a USB cable, you need to set the Emulation to BR-Script 3 (**Menu, 4, 1**) before connecting the USB cable. (See *Setting the Emulation Selection* on page 11-18.)
-  The PS driver does not support the following functions:
 - HQ 1200
 - Secure Print
 - PC-Fax Sending

For Mac OS 8.6 to 9.2 Users

1 For Mac® OS 8.6 to 9.04 Users:

Open the **Apple Extras** folder. Open the **Apple LaserWriter Software** folder.

For Mac® OS 9.1 to 9.2 Users:

Open the **Applications** (Mac® OS 9) folder. Open the **Utilities** folder.*

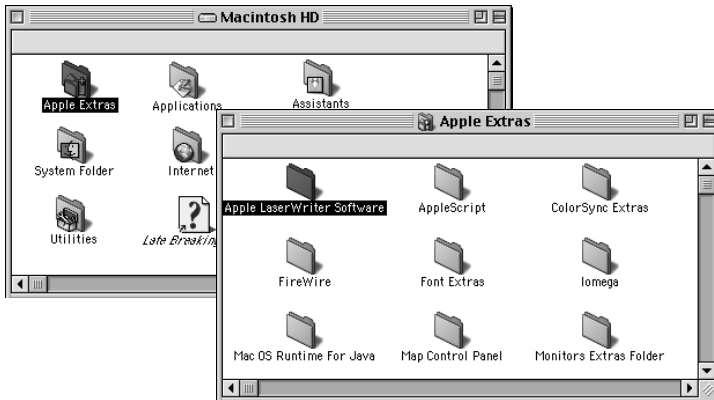

* The screens are based on Mac® OS 9.04.

2 Open the **Desktop Printer Utility** icon.

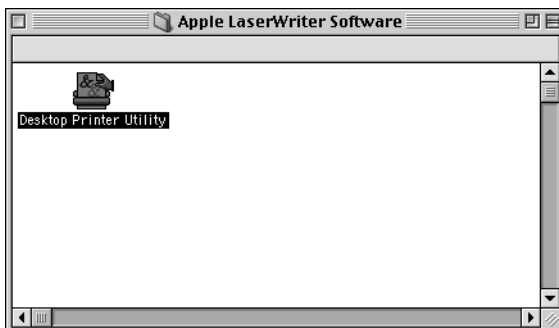

- 3 Select **Printer (USB)**, and then click **OK**.



- 4 Click **Change...** in the PostScript™ Printer Description (PPD) file.
Select **Brother MFC-8820D**, and then click **Select**.

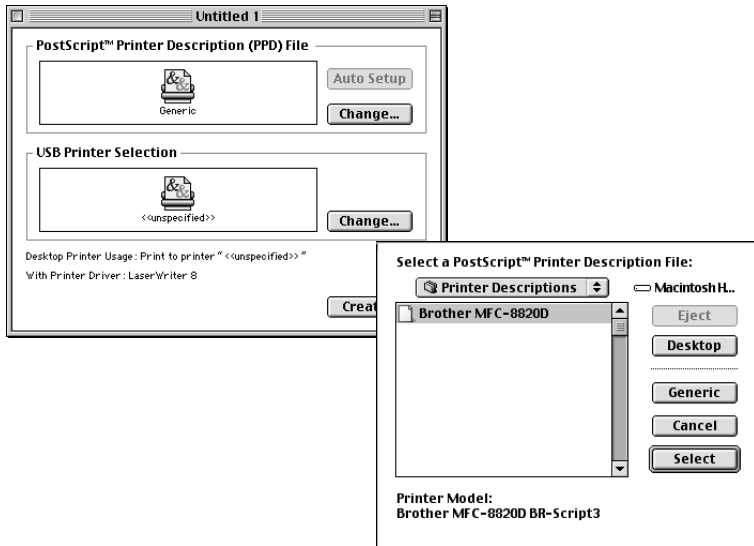

- 5 Click **Change...** in the **USB Printer Selection**.
Select **Brother MFC-8820D**, and then click **OK**.

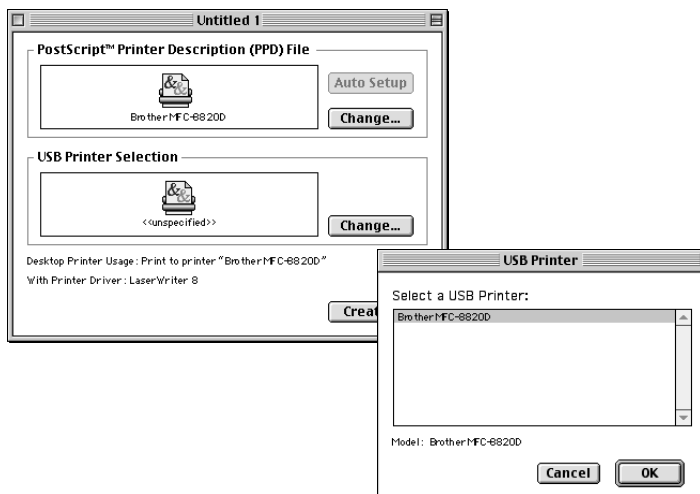

- 6 Click **Create...**

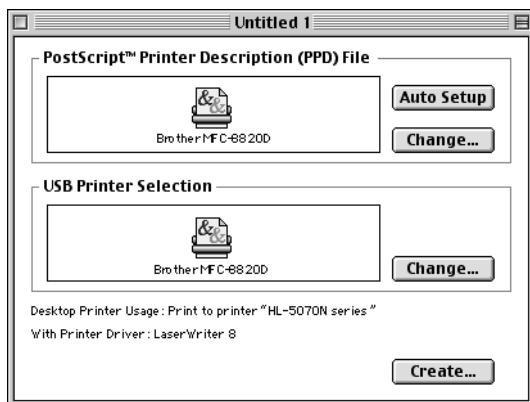

7 Enter your MFC name (MFC-8820D), and then click **Save**.

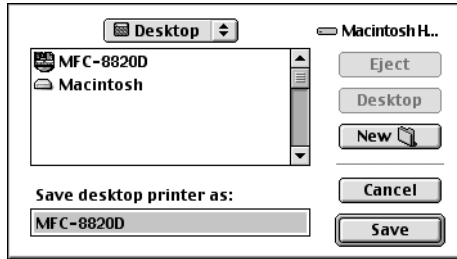

8 Select **Quit** from the **File** menu.



9 Click the **MFC-8820D** icon on the Desktop.

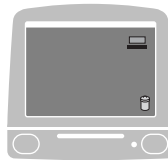



10 Select **Set Default Printer** from the **Printing** menu.



For Mac OS X users

You need to install the PS driver using the following instructions.

 If you use a USB cable and your Macintosh is “Mac OS X”, only one printer driver for an MFC can be registered in Print Center.

 If a Brother Native Driver (MFC-8420/8820D) is already listed in Printer list, you will need to delete it and then install the PS driver.

 To use the PS driver with a USB cable, you need to set the Emulation to BR-Script 3 (**Menu, 4, 1**) before connecting the USB cable. (See *Setting the Emulation Selection* on page 11-18.)

1 Select **Applications** from the **Go** menu.

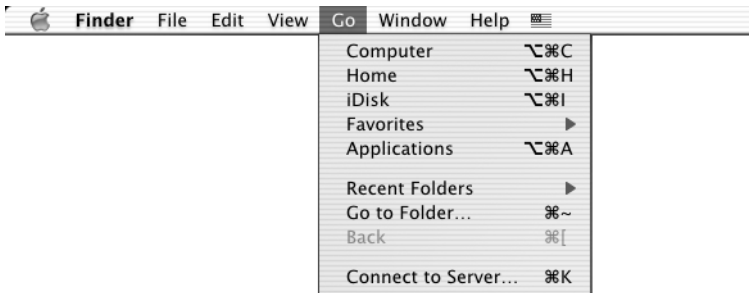

2 Open the **Utilities** folder.

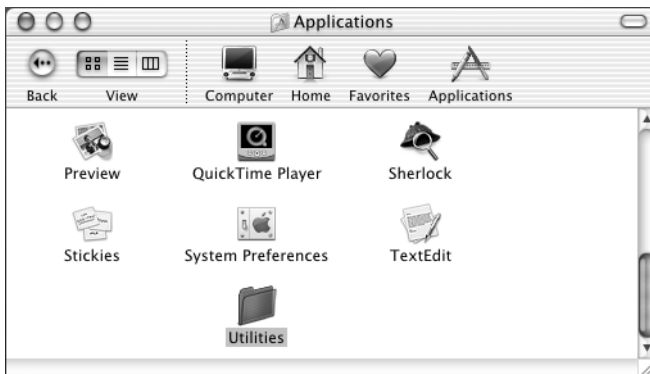

3 Open the **Print Center** icon.



4 Click **Add Printer...**

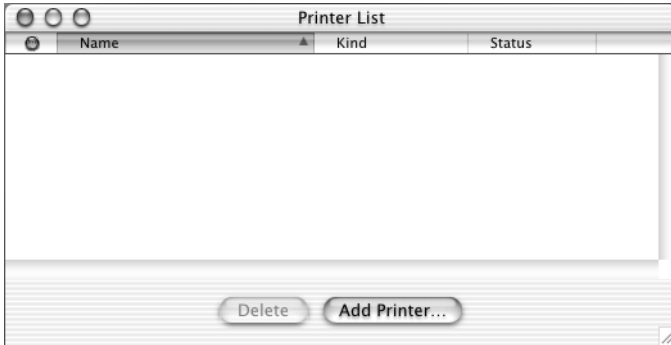

5 Select **USB**.



6 Select **MFC-8820D**, and then click **Add**.

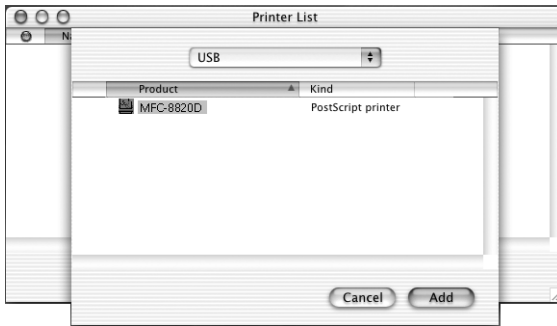

7 Select **Quit Print Center** from the **Print Center** menu.

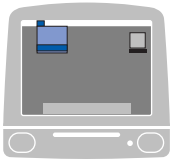

Sending a fax from your Macintosh[®] application

For Mac OS 8.6 - 9.2 users

You can send a fax directly from a Macintosh[®] application by doing the following:

- 1 Create a document in a Macintosh application.
- 2 To send a fax, select **Print** from the **File** menu.

The Printer dialog box will appear:

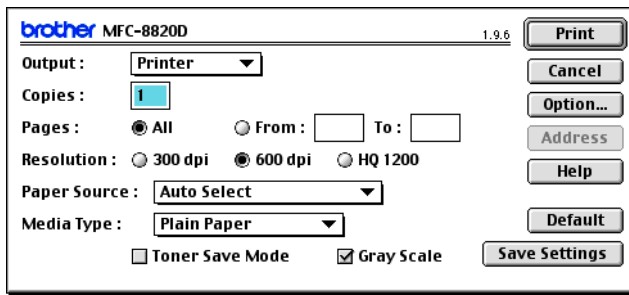

When *Printer* is selected, the top button shows **Print** and the **Address** button is grayed.

- 3 From the **Output** pull-down menu, select *Facsimile*.

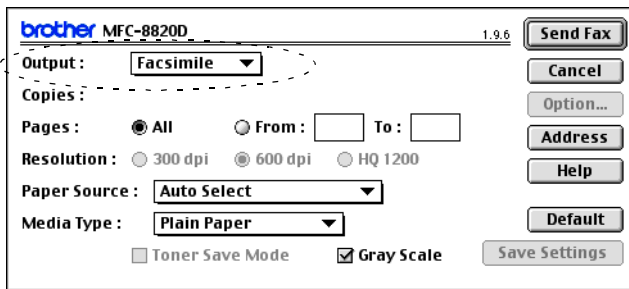

When *Facsimile* is selected, the top button changes to **Send Fax** and the **Address** button will be available.

4 Click **Send Fax**.

The **Send Fax** dialog box appears:

Stored Fax Numbers :	
Barbie	908-477-8888
Bob	908-869-8888
Frank	908-236-8888
Tony	908-569-8888

The **Send Fax** dialog box has two list boxes. The left box shows all the previously **Stored Fax Numbers** and the right box shows the **Destination Fax Numbers** as you select them.

5 To address the fax, type a fax number in the **Input Fax Number** box.

6 When you are finished addressing your fax, click **Send Fax**.

 To select and only send certain pages of the document, click **OK** to go to the Print dialog box.

 If you click **Send Fax** without addressing your fax, the following error message will appear:

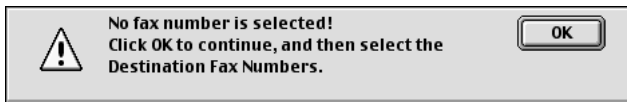

Click **OK** to go to the **Send Fax** dialog box.

For Mac OS X users

You can send a fax directly from a Macintosh® application by doing the following:

- 1 Create a document in a Macintosh application.
- 2 To send a fax, select **Print** from the **File** menu.

The Printer dialog box will appear:

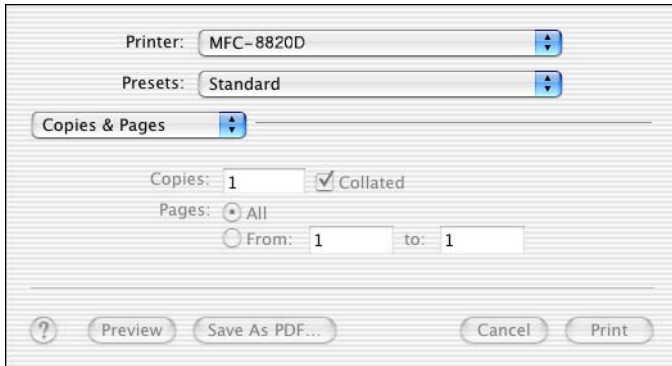

- 3 Select **Send Fax** from the pull-down menu.

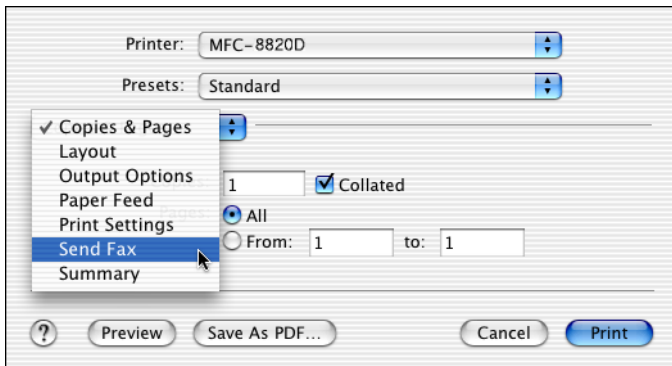

4 Select **Facsimile** from the **Output** pull-down menu.

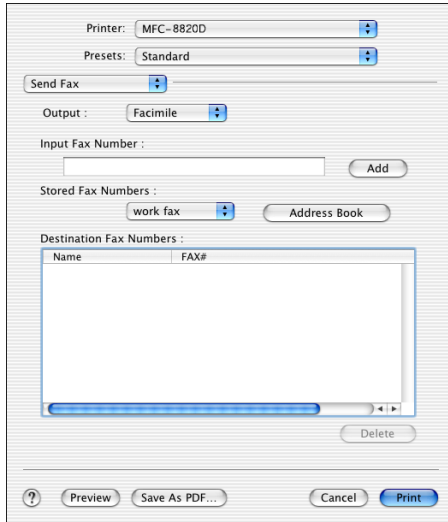

5 To address the fax, type a fax number in the **Input Fax Number** box, and the click **Print**.



If you want to send a fax to more than one number, click **Add** after entering the first fax number. The destination fax numbers will be listed in the dialog box.

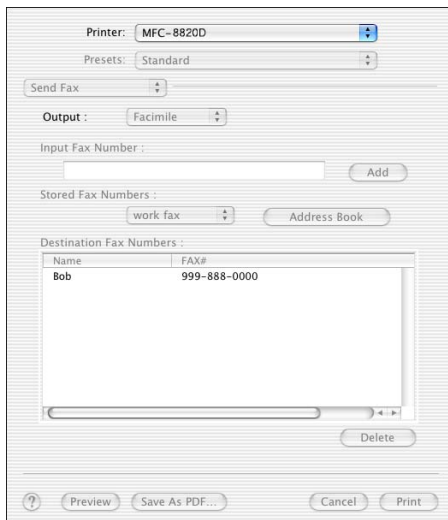

Drag a vCard from the Mac® OS X Address Book application

- 1 Click **Address Book** button.
- 2 Drag a vCard from the Mac® OS X **Address Book** application to the **Destination Fax Numbers** field.

When you are finished addressing your fax, click **Print**.

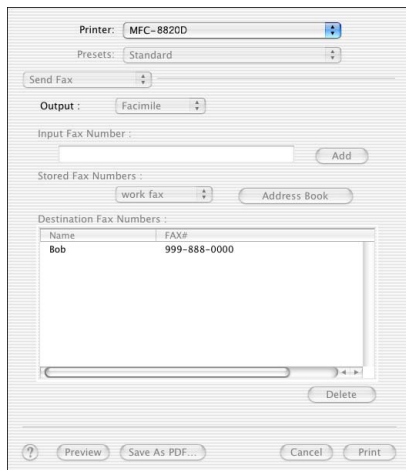
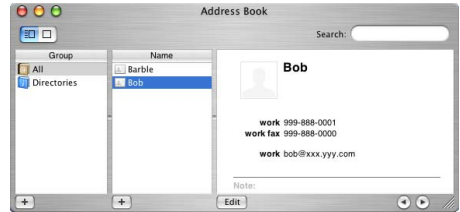
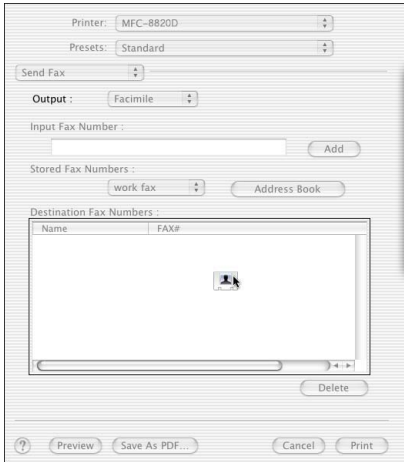



The vCard used must contain a **work fax** or **home fax** number.



When you choose **work fax** or **home fax** from the **Stored Fax Numbers** pull-down list, only the fax number stored in the Mac OS X Address Book for the selected category will be used. If the fax number is stored in only one of the Mac OS X Address Book categories, the number will be retrieved no matter which category you have selected (work or home).

Using the Brother TWAIN scanner driver with your Macintosh®

The Brother MFC software includes a TWAIN Scanner driver for Macintosh®. You can use this Macintosh® TWAIN Scanner driver with any applications that support the TWAIN specifications.

 Mac OS X Scanning is supported in Mac OS X 10.2.1 or greater.

Accessing the scanner

Run your Macintosh® TWAIN-compliant application software. The first time you use the Brother TWAIN driver (MFL Pro/P2500), set it as the default by choosing **Select Source** (or the other menu name to select the device). Afterwards, for each document you scan choose **Acquire Image** or **Scan**. The scanner setup dialog box will appear.

 The screen shown in this section are from Mac OS 9. The screen on your Macintosh® may vary depending on your Operating System.

 The method of selecting the source or choosing to scan may vary depending on the application software you are using.

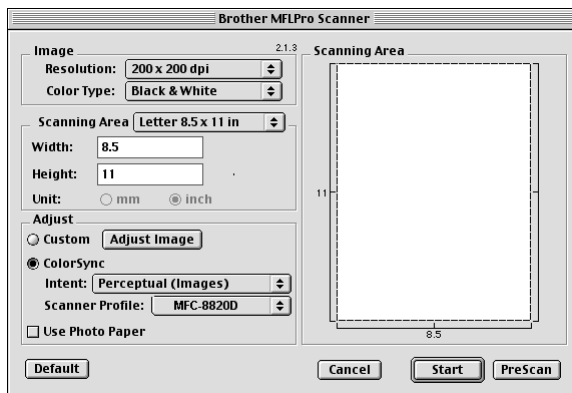

(OS 8.6–9.2)

Scanning an image into your Macintosh®

You can scan a whole page

—OR—

scan a portion after pre scanning the document.

Scanning a whole page

- 1 Place the document face up in the ADF, or face down on the scanner glass.
- 2 Adjust the following settings, if needed, in the Scanner Setup dialog box:
 - Resolution**
 - Color Type**
 - Scanning Area**
 - Brightness**
 - Contrast**
- 3 Click **Start**.

When scanning has finished, the image will appear in your graphics application.

Pre Scanning an image

Pre Scanning allows you to scan an image quickly at a low resolution. A thumbnail version will appear in the **Scanning Area**. This is only a preview of the image, so you can see how it will look. The **PreScan** button will allow you to crop unwanted areas from the images. When you are satisfied with the preview, click **Start** to scan the image.

- 1 Insert the document face up in the ADF, or face down on the scanner glass.
- 2 Click **PreScan**.
The whole image will be scanned into your Macintosh® and will appear in the **Scanning Area** of the Scanner dialog box:
- 3 To scan a portion of the prescanned image, click and drag the mouse to crop it.

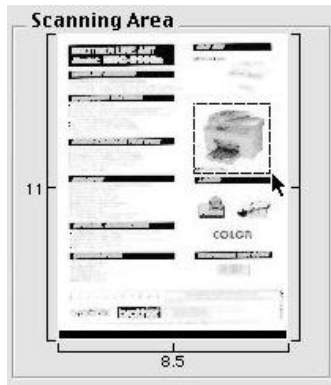

- 4 Insert document in the ADF, if you are using ADF.
- 5 Make your adjustments to the settings for **Resolution**, **Color Type** (Gray Scale), **Brightness**, **Contrast**, and **Size** in the Scanner Setup dialog box.
- 6 Click **Start**.
This time only the cropped area of the document will appear in the Scanning Area.
- 7 In your editing software, you can refine the image.

Settings in the Scanner window

Image

Resolution

From the **Resolution** pop-up menu choose the scanning resolution. Higher resolutions use more memory and transfer time, but produce a finer scanned image.

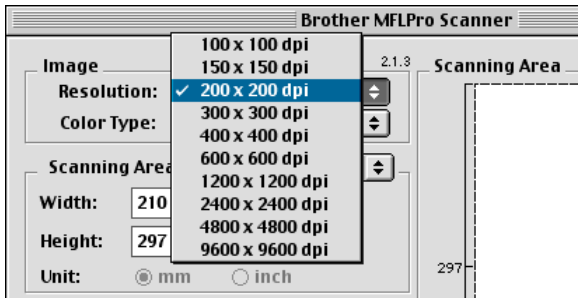

Color Type

Black & White—Set the image Type to *Black and White* for text or line art. For photographic images, set the image type to Gray (Error diffusion) or True Gray.

Gray (Error Diffusion)—is used for documents with photographic images or graphics. (Error Diffusion is a method for creating simulated gray images by placing black dots instead of the true gray dots in a specific matrix instead of true gray dots.)

True Gray—is used for documents with photographic images or graphics. This mode is more exact because it uses up to 256 shades of gray. It requires the most memory and takes the longest transfer time.

Colors—Choose either 8-bit Color, which scans up to 8-bit Color or 24-bit color which scans up to 16.8 million colors. Although using 24-bit color creates an image with the most accurate colors, the image file will be about three times larger than a file created with 8-bit Color.

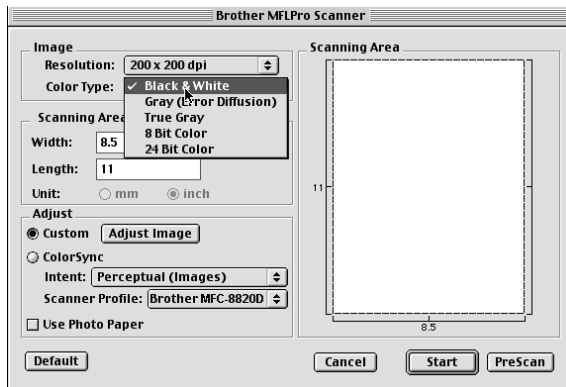

Scanning Area

Set the **Size** to one of the following:

- *Letter 8.5 x 11 in*
- *A4 210 x 297 mm*
- *Legal 8.5 x 14 in*
- *A5 148 x 210 mm*
- *B5 182 x 257 mm*
- *Executive 7.25 x 10.5 in*
- *Business Card 90 x 60 mm*
- *Custom (User adjustable from 0.35 x 0.35 in. to 8.5 x 14 in. or 8.9 x 8.9 mm to 216 x 356 mm)*

After you choose a custom size, you can adjust the scanning area. Click and hold the mouse button as you drag the mouse to crop the image.

Width: Enter the width of the custom size.

Height: Enter the height of the custom size.

Business Card Size

To scan business cards, select the Business Card size (90 x 60 mm) and place the business card at the center of scanner glass.

When you are scanning photographs or other images to use in a word processor or other graphics application, it is a good idea to try different settings for the Contrast, Mode and Resolution to determine which settings look the best.

Adjusting the Image

Brightness

Adjust the **Brightness** setting to get the best image. The Brother TWAIN Scanner driver offers 100 Brightness levels (-50 to 50). The default value is 0, representing an 'average' setting.

You can set the **Brightness** level by dragging the slide bar to the right to lighten the image or to the left to darken the image. You can also type a value in the box to set the level. Click **OK**.

If the scanned image is too light, set a lower Brightness level and scan the image again.

If the image is too dark, set a higher Brightness level and scan the image again.

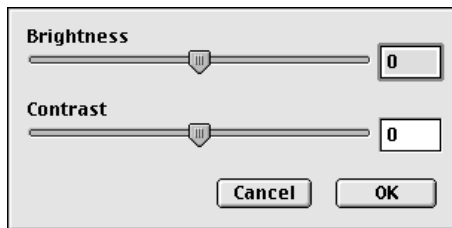

Contrast

You can only adjust the **Contrast** level when you have selected one of the Gray Scale settings, it is not available when you have selected Black & White as the selected **Color Type**.

Increasing the **Contrast** level (by dragging the slide bar to the right) emphasizes dark and light areas of the image, while reducing the **Contrast** level (by dragging the slide bar to the left) reveals more detail in the gray areas. Instead of using the slide bar, you can type a value in the box to set the Contrast. Click **OK**.

Using Presto!® PageManager®

Presto!® PageManager® is application software for managing the documents in your computer. Since it is compatible with most image editors and word processing programs, Presto!® PageManager® gives you unmatched control over your computer files. You can easily manage your documents and edit your E-mail and files and create documents with the OCR software built into Presto!® PageManager®.

If you use the MFC as a scanner, we recommend that you install Presto!® PageManager®. To install Presto!® PageManager®, see the Quick Setup Guide.



The complete NewSoft Presto!® PageManager® 4.0 User's Guide can be found on the Macintosh CD-ROM supplied with your MFC.

Highlights

- **OCR:** In one step scan an image, recognize the text, and edit it with a word processor.
- **Scan Buttons:** Scan documents and open them with a designated program in one step.
- **Image Editing:** Enhance, crop and rotate images, or open them with an image-editing program of your choice.
- **Annotation:** Add removable notes, stamps and drawings to images.
- **Treeview Window:** View and arrange your folder hierarchy for easy access.
- **Thumbnail Window:** View files as thumbnails for easy identification.

System requirements

- PowerPC processor
- System 8.6, 9X, 10.1, or greater
- CD-ROM drive
- Hard disk drive with at least 120 MB of free disk space

Recommended:

- 8-bit Color or higher video adapter.
- Eudora Mail, or Outlook Express electronic mail software

Technical Support

Company name: NewSoft Technology Corp.

E-mail Address: support@newsoft.com.tw

(in English or Chinese)

MFC Remote Setup (Mac OS X)

The MFC Remote Setup application allows you to quickly set up your MFC by taking advantage of the ease and speed of programming on your Macintosh®. When you access this application, the settings on your MFC will be downloaded automatically to your Macintosh® and displayed on your computer screen. If you change the settings, you can upload them directly to the MFC.



The 'MFC Remote Setup' application icon is in Macintosh HD/Library/Printers/Brother/Utility.

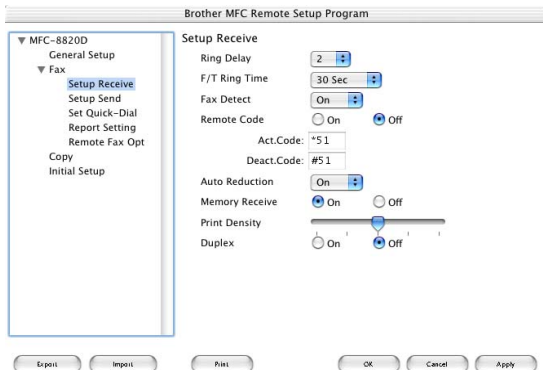

OK

This starts the process of uploading the data to the MFC and exiting the remote setup program. If an error message is displayed enter the correct data again. Click **OK**.

Cancel

This exits the remote setup application without uploading the data to the MFC.

Apply

This uploads the data to the MFC, but does not exit the remote setup application.

Print

This command prints the selected items on the MFC. You can not print the data until it is uploaded to the MFC. Click **Apply** to upload the new data to the MFC and click **Print**.

Export

This command saves the current configuration settings to a file.

Import

This command reads the settings from a file.

19 Network Scanning

(Windows® 98/98SE/Me/2000 Professional and XP only)

To use the MFC as a Network Scanner, the NC-9100h Network board should be installed into the MFC and configured with TCP/IP and mail server settings if you use Scan to E-mail (E-mail server). You can set or change NC-9100h settings from the control panel or with the Professional utility or Web Management BRAdmin. (Please see the NC-9100h User's Guide on the CD-ROM.)

Registering your PC with the MFC

If you need to change the MFC that was registered to your PC during the installation of MFL-Pro (see the Quick Setup Guide on page 38), follow the steps below.

1 *For Windows® 98/Me/2000*

From the Start menu, select **Control Panel, Scanners and Cameras**, and then right-click Scanner Device icon and select **Properties** to view the Network Scanner Properties dialog box.

For Windows® XP

From the **Start** menu, select **Control Panel, Printers and Other Hardware, Scanner and Cameras** (or **Control Panel, Scanners and Cameras**).

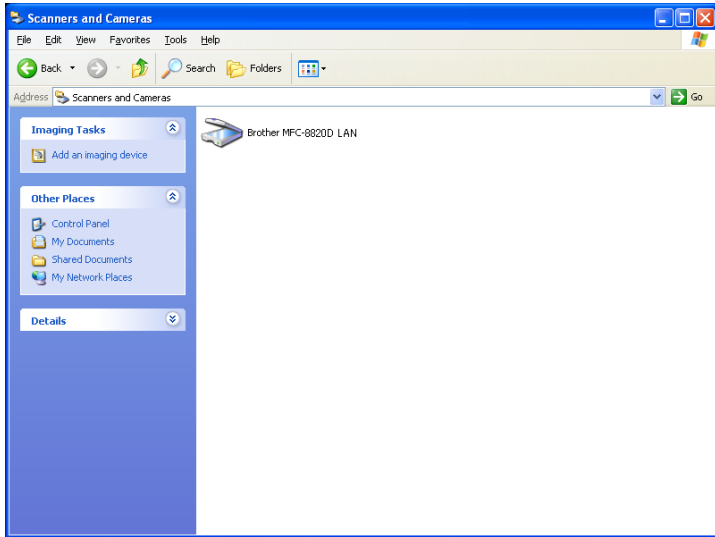

Right-click Scanner Device icon and select properties to view the Network Scanner Properties dialog box.

- 2 Click the **Network Setting** tab in the dialog box and select a method to specify the MFC as a Network scanner for your PC.

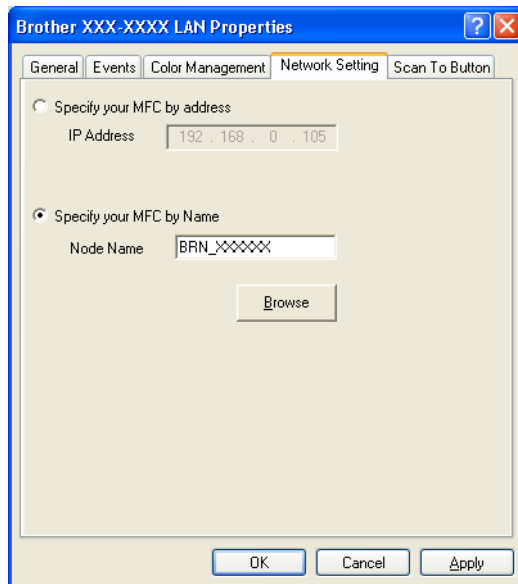

Specify your MFC by address

Enter the actual IP address of the MFC in the IP Address field.

Click **Apply** and then **OK**.

Specify your MFC by Name

Enter the MFC Node name in the Node Name field.

Click **Apply** and then **OK**.

Search from a list of available device

Click Browse and select the appropriate device you want to use.

Click **OK**.

Click **Apply** and then **OK**.

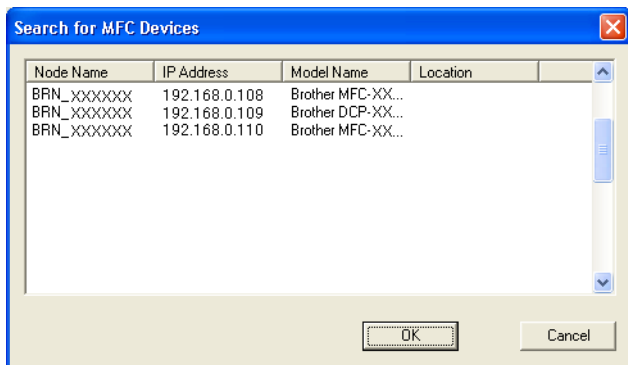

- 3 Click the **Scan To Button** tab in the dialog box and enter your PC Name in the Display Name field. The MFC's LCD displays the Name you enter. Default setting is your PC Name. You can enter a name if you like.

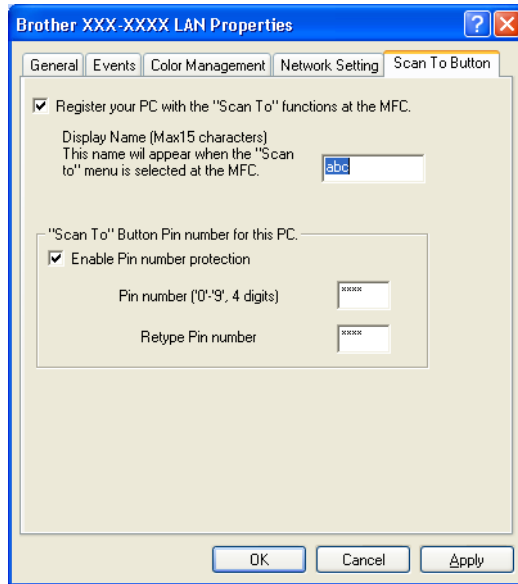



- 4 You can avoid receiving unwanted documents by setting a 4-digit PIN Number. Enter your PIN Number in the PIN Number and Retype PIN Number field. To send data to a PC protected by a PIN Number, the LCD prompts to enter the PIN Number before the document can be scanned and sent to the MFC. (See *Using the Scan key* on page 19-5 to 19-10.)

Using the Scan key

Scan to E-mail (PC)



When you select Scan to E-mail (PC) your document will be scanned and sent directly to the PC you designated on your network. The Brother SmartUI will activate the default E-mail application on the designated PC for addressing to the recipient. You can scan a black and white or color document and it will be sent with the E-mail from the PC as an attachment.

 For Network Scanning the Brother Control Center (SmartUI) selections are used only for configuring the Scan button. You will not be able to initiate a Network scan from the Brother Control Center (SmartUI).

You can change the  (**Scan**) configuration. For Windows® 98/98SE/Me/2000: (See *Scan to E-mail* on page 14-10 to 14-11.) (For Windows® XP: See *Hardware Section: Changing the Scan to button configuration* on page 15-5 to 15-9.)

1 Place the document face up in the ADF, or face down on the scanner glass.

2 Press  (**Scan**).

3 Press  or  to select Scan to E-Mail.

Press **Set**.



4 Press  or  to select PC.

Press **Set**.

—OR—

If there is not other selection, go to Step 5.

▲Scan to E-Mail
Scan to Image
Scan to OCR
▼Scan to File
Select ▲▼ & Set

- 5 Press  or  to select the destination PC you want to use for E-mailing your document.

Press **Set**.

If the LCD prompts you to enter a PIN Number, enter the 4-digit PIN Number for the destination PC on the control panel.

Press **Set**.

The MFC will start the scanning process.



Scan to E-mail (E-mail server)

When you select Scan to E-mail (E-mail server) you can scan a black and white or color document and send it directly to an E-mail address from the MFC. Your document is sent as an E-mail attachment in a TIFF format for Black and White or you can choose PDF or JPEG for color.

 Scan to E-mail (E-mail server) requires SMTP/POP3 mail server support. (See *NC-9100h User's Guide* on the CD-ROM.)

- 1 Place the document face up in the ADF, or face down on the scanner glass.

- 2 Press  (**Scan**).

- 3 Press  or  to select Scan to E-Mail.

Press **Set**.



- 4 Press  or  to select E-mail Server.

Press **Set**.

—OR—

▲Scan to E-Mail
Scan to Image
Scan to OCR
▼Scan to File
Select ▲▼ & Set

If there is not other selection, go to Step 5.

- 5 Press  or  to select Change Quality.

Press **Set**.

- 6** Press  or  to select Color 150 dpi, Color 300 dpi, Color 600 dpi, B/W 200 dpi or B/W 200×100 dpi.
Press **Set**.

If you select B/W 200 dpi or B/W 200×100 dpi in Step 6, go to Step 8.

—OR—

If you select Color 150 dpi, Color 300 dpi or Color 600 dpi in Step 6, go to Step 7.

- 7** Press  or  to select PDF or JPEG.

Press **Set**.

- 8** The LCD prompts you to enter an address. Enter the destination E-mail address from the dial pad or use the One-Touch key or Speed-Dial key.

- 9** Press **Start**.

The MFC will start the scanning process.

Scan to Image

When you select Scan to Image your document will be scanned and sent directly to the PC you designated on your network. The Brother SmartUI will activate the default graphics application on the designated PC. You can change the **Scan** configuration. (For Windows® 98/Me/2000: See *Scan to Image* on page 14-14.) (For Windows® XP: See *Hardware Section: Changing the Scan to button configuration* on page 15-5 to 15-10.)





For Network Scanning the Brother Control Center (SmartUI) selections are used only for configuring the Scan button. You will not be able to initiate a network scan from the Brother Control Center (SmartUI).

1 Place the document face up in the ADF, or face down on the scanner glass.

2 Press  (**Scan**).

3 Press  or  to select Scan to Image.

Press **Set**.

4 Press  or  to select a destination you want to send.

Press **Set**.

If the LCD prompts you to enter a PIN Number, enter the 4-digit PIN Number for the destination PC on the control panel.

Press **Set**.

The MFC will start the scanning process.

▲Scan to E-Mail
Scan to Image
Scan to OCR
▼Scan to File
Select ▲▼ & Set

Scan to OCR

When you select Scan to OCR your document will be scanned and sent directly to the PC you designated on your network. The Brother SmartUI will activate ScanSoft® TextBridge® and convert your document into text for viewing and editing from a word processing application on the designated PC. You can change the **Scan** configuration.

(For Windows® 98/Me/2000: See *Scan to OCR (Word Processor)* on page 14-12 to 14-13.) (For Windows® XP: See *Hardware Section: Changing the Scan to button configuration* on page 15-5 to 15-11.)



 For Network Scanning the Brother Control Center (SmartUI) selections are used only for configuring the Scan button. You will not be able to initiate a network scan from the Brother Control Center (SmartUI).

1 Place the document face up in the ADF, or face down on the scanner glass.

2 Press  (**Scan**).

3 Press  or  to select Scan to OCR.

Press **Set**.

4 Press  or  to select a destination you want to send.

Press **Set**.

If the LCD prompts you to enter a PIN Number, enter the 4-digit PIN Number for the destination PC on the control panel.

Press **Set**.

The MFC will start the scanning process.

▲Scan to E-Mail
Scan to Image
Scan to OCR
▼Scan to File
Select ▲▼ & Set

Scan to File

When you select Scan to File you can scan a black and white or color document and send it directly to a PC you designate on your network. The file will be saved in the folder and file format that you have configured in the Brother SmartUI on the designated PC. You can change the **Scan** configuration.

(For Windows® 98/Me/2000: See *Scan to File* on page 14-8 to 14-9.)

(For Windows® XP: See *Hardware Section: Changing the Scan to button configuration* on page 15-5 to 15-11.)





For Network Scanning the Brother Control Center (SmartUI) selections are used only for configuring the Scan button. You will not be able to initiate a network scan from the Brother Control Center (SmartUI).

- 1 Place the document face up in the ADF, or face down on the scanner glass.

- 2 Press  (**Scan**).

- 3 Press  or  to select Scan to File.

Press **Set**.

- 4 Press  or  to select a destination you want to send.

Press **Set**.

If the LCD prompts you to enter a PIN Number, enter the 4-digit PIN Number for the destination PC on the control panel.

Press **Set**.

The MFC will start the scanning process.



Max. 25 clients can be connected to one MFC on a Network. For example, if 30 clients try to connect at a time, 5 clients will not be shown on the LCD.

▲Scan to E-Mail
Scan to Image
Scan to OCR
▼Scan to File
Select ▲▼ & Set

20 Brother Network PC-FAX software

Enable Network PC-FAX

To use the MFC as a Network PC-FAX, the NC-9100h Network board should be installed into the MFC and configured with TCP/IP and mail server settings if you use Scan to E-mail (E-mail server). (See *Using Brother PC-FAX software* on page 17-1.)

Note: The items described in this chapter are specific items relating to the Network version of PC-FAX software that is installed from the "Optional network applications" on the CD-ROM supplied with your MFC.

Brother Network PC-FAX can be configured through PC-FAX Setup, Sending tab.

Sending setup

In order to use the full functionality of Network PC-FAX it is strongly recommended that you enable the Network PC-FAX Setup option on the Sending tab Brother PC-FAX Setup.

- 1 Access the Sending Tab from the PC-FAX dialog box by clicking



—OR—

From the Start menu, select **All programs, Brother, Brother MFL Pro Suite**, and then select **PC-FAX Setup**.

- 2 Check **Enable** box.

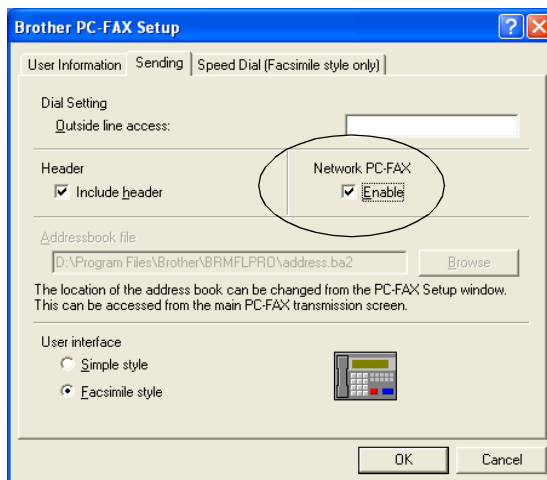

This software can be used in a network environment and with a locally connected machine. It is important that when used in a network environment the Network PC Fax is set to enable.

Extra options in Address Book

When the Enable Network PC-FAX option is selected, three additional options appear in the address book contact window.

- 1 In the Address Book dialog box, click the  icon to add a member.

The Brother Address Book Member Setup dialog box will appear:

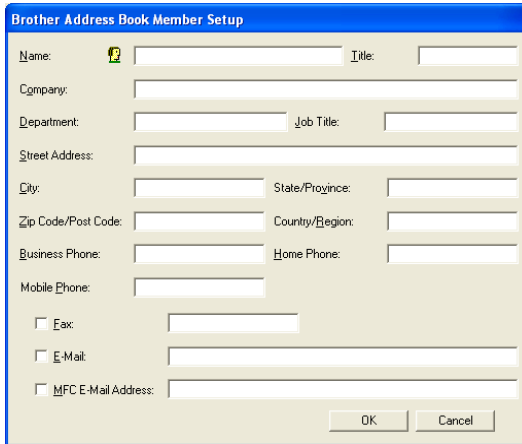

Brother Address Book Member Setup

Name: Title:

Company:

Department: Job Title:

Street Address:

City: State/Province:

Zip Code/Post Code: Country/Region:

Business Phone: Home Phone:

Mobile Phone:

Fax:

E-Mail:

MFC E-Mail Address:

OK Cancel

- 2 In the **Brother Address Book Member Setup** dialog box, type the member's information.

Name is required field. You can also enter an E-mail contact address and MFC address for the address book member.

- 3 To send to this contact it is necessary to specify which is the preferred method of sending a document to this contact by checking the Fax, E-mail or MFC E-mail Address box next to the contact.

- 4 Click the OK button to save the member's information.



If you wish to send a document to this contact by more than one method you must create a second contact and select a different option, Fax, E-Mail or MFC Address.

To use the MFC for Network PC-FAX, see *Using Brother PC-FAX software* on page 17-1.

Installing Network PC-FAX

Insert the CD-ROM supplied with your Brother MFC, the installer screen will automatically start. From the installer screen select your model and language (if these options are present), then select Network Applications for (optional NC-9100h Print / Fax Server), then select Brother PC-FAX and follow the screen prompts. When prompted reboot your PC.

Windows® 95/98/98SE and Me users

It is now necessary to download the Brother Network Print Software from the Brother Solution Center at: <http://solutions.brother.com>. Select Network Applications for (optional NC-9100h Print / Fax Server), then select Network Print Software. Follow the screen prompts, you will be prompted for the IP address of the NC-9100h. If in any doubt contact your Network Administrator.



If you have already installed the MFC as a network printer you may have already installed the Brother Network Print Software.

To check select **Start**, **Settings** and **Printers**

Highlight the Brother PC-FAX driver from the list and right click the mouse button and select **Properties** then select the **Ports** tab.

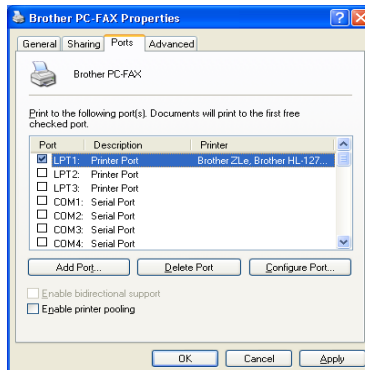

Select the “Print to Following Port” as illustrated above, if Brother LPR Port is listed for your MFC you can just specify for Brother Network Fax to use this previously installed port. If you have multiple Brother LPR ports please ensure that you select the correct port address. If in any doubt please contact your Network Administrator.



If the installer screen does not appear automatically select **Start, Run** and type X:/setup.exe

(X:/ should be the drive letter of your CD ROM drive on your PC).

Using the Brother Network PC-FAX software

The Brother Network PC-FAX feature allows you to use your PC to send any application or document file as a standard fax. You can create a file in any application on your PC, and then send it as a Network PC-FAX. You can even attach a cover page note. All you have to do is set up the receiving parties as Members or Groups in your PC-FAX Address Book or simply enter the destination address or fax number into the User Interface. You can use the Address Book Search feature to quickly find members to send your fax.



Please check Brother Solutions Center for the latest updates available for Brother Network PC-FAX. Visit <http://solutions.brother.com/>

Quick Tips:

Please see *Enable Network PC-FAX* on page 20-1 before using Brother Network PC-FAX.

- 1** Ensure that Network PC-FAX is set to “Enable” in the Sending tab of Setup. (See *Enable Network PC-FAX* on page 20-1.)
- 2** To send an E-mail from Brother Network PC-FAX you can either enter the E-mail address in the To: field or in the display for Facsimile Style using the PC keyboard or select the member from the Address Book. The member must have E-mail selected as the chosen destination for that member.
- 3** To send an Internet Fax from Brother Network PC-FAX you can either enter the Internet Fax address in the To: field or in the display for Facsimile style using the PC keyboard or select the member from the Address Book. The member must have MFC Mail Address selected as the chosen destination for that member.
- 4** To send a Network Fax simply select a member from the address book or enter the fax number into the User Interface with the PC keyboard. The member must have Fax selected as the chosen destination for that member.



Sending a Network PC-FAX to an E-mail address or sending an Internet Fax requires SMTP/POP3 mail server support.

Sending a Network PC-FAX from your Macintosh® application

You can send a fax directly from your Macintosh® application using the following steps:

For Mac OS 8.6 - 9.2 users

- 1** Follow the steps in the Quick Setup Guide.
- 2** Follow the steps on pages 18-14.

For Mac OS X users

- 1** Follow the steps in the Quick Setup Guide.
- 2** Follow the steps on page 18-16.

21 Important information

IEC 60825 Specification

This machine is a Class 1 laser product as defined in IEC 60825 specifications. The label shown below is attached in countries where required.

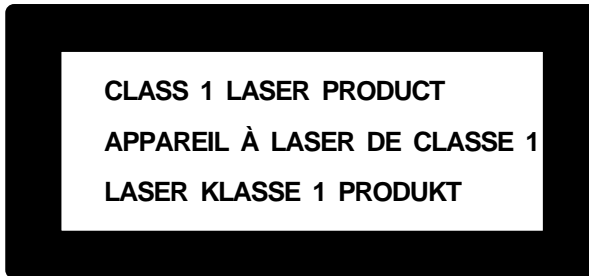

This machine has a Class 3B Laser Diode which emits invisible laser radiation in the Scanner Unit. The Scanner Unit should not be opened under any circumstances.

Laser Diode

Wave length: 760 - 810 nm

Output: 5 mW max.

Laser Class: Class 3B

Caution

Use of controls, adjustments or performance of procedures other than those specified in this manual may result in hazardous radiation exposure.

Important Information for Australia

Important Safety Instructions

- 1** Read all of these instructions.
- 2** Save them for later reference.
- 3** Follow all warnings and instructions marked on the product.
- 4** Switch off before cleaning. Do not use liquid or aerosol cleaners. Use a damp cloth for cleaning.
- 5** Do not place this product on an unstable surface, stand, or table. The product may fall, causing serious damage to the product.
- 6** Slots and openings in the cabinet and the back or bottom are provided for ventilation; to ensure reliable operation of the product and to protect it from overheating, these openings must not be blocked or covered. The openings should never be blocked by placing the product on a bed, sofa, rug, or other similar surface. This product should never be placed near or over a radiator or heater. This product should not be placed in a built-in installation unless proper ventilation is provided.
- 7** This product should be operated from the type of power source indicated on the label. If you are not sure of the type of power available, consult with your dealer or local power company.
- 8** This product is equipped with a 3-wire earthed plug. This plug will fit into only an earthed socket. This is a safety feature. If you are unable to insert the plug into the outlet, contact your electrician to replace your obsolete socket. Do not defeat the purpose of an earthed plug.
- 9** Do not allow anything to rest on the power cord. Do not locate this product where people can walk on the cord.
- 10** Do not place anything in front of the MFC that will block received faxes. Do not place anything in the path of received faxes.
- 11** Do not touch a document during printing.

- 12** Never push objects of any kind into this product through cabinet slots, since they may touch dangerous voltage points or short out parts resulting in a risk of fire or electric shock. Never spill liquid of any kind on the product.
- 13** Do not attempt to service this product yourself, because opening or removing covers may expose you to dangerous voltage points and/or other risks. Refer all servicing to service personnel.
- 14** Unplug this product from the mains power and telephone line sockets, and refer servicing to qualified Service Personnel under the following conditions:
- When the power cord is damaged or frayed.
 - If liquid has been spilled into the product.
 - If the product has been exposed to rain or water.
 - If the product does not operate normally when the operating instructions are followed. Adjust only those controls that are covered by the operating instructions. Improper adjustment of other controls may result in damage and will often require extensive work by a qualified technician to restore the product to normal operation.
 - If the product has been dropped or the cabinet has been damaged.
 - If the product exhibits a distinct change in performance, indicating a need for service.

IMPORTANT-For Your Safety.

To ensure safe operation the three-pin plug supplied must be inserted only into a standard three-pin power point which is effectively grounded through the normal household wiring.

Extension cords used with the equipment must be three-conductor and be correctly wired to provide connection to ground. Incorrectly wired extension cords are a major cause of fatalities.

The fact that the equipment operates satisfactorily does not imply that the power is grounded and that the installation is completely safe. For your safety, if in any doubt about the effective grounding of the power, consult a qualified electrician.

Disconnect device

This machine must be installed near a power outlet, which is easily accessible. In case of emergencies, you must disconnect the power cord from the power outlet in order to shut off power completely.

LAN Connection

Caution: Connect this product to the LAN connection which is not subjected to overvoltages.

ENERGY STAR® Compliance Statement

As an ENERGY STAR® Partner, Brother Industries, Ltd. has determined that this product meets the ENERGY STAR® guidelines for energy efficiency.



Important Information for New Zealand

Important Safety Instructions

- 1** Read all of these instructions.
- 2** Save them for later reference.
- 3** Follow all warnings and instructions marked on the product.
- 4** Switch off before cleaning. Do not use liquid or aerosol cleaners. Use a damp cloth for cleaning.
- 5** The grant of a Telepermit for any item of terminal equipment indicates only that Telecom has accepted that the item complies with minimum conditions for connection to its network. It indicates no endorsement of the product by Telecom, nor does it provide any sort of warranty. Above all, it provides no assurance that any item will work correctly in all respects with another item of Telepermitted equipment of a different make or model, nor does it imply that any product is compatible with all of Telecom's network services.
- 6** This equipment does not fully meet Telecom's impedance requirements. Performance limitations may occur when used in conjunction with some parts of the network. Telecom will accept no responsibility should difficulties arise in such circumstances.
- 7** If a charge for local calls is acceptable, the "Dial Button" should not be used for local calls. Only the 7-digits of the local number should be dialled from your telephone. Do not dial the area code digit or the "0" prefix.
- 8** This equipment shall not be set to make automatic calls to the Telecom '111' Emergency Service.
- 9** This equipment should not be used under any circumstances which may constitute a nuisance to other Telecom customers.
- 10** Not all telephones will respond to incoming ringing when connected to the extension socket.
- 11** The answer delay setting of this equipment shall not be set to less than the default setting as this will destroy Caller ID information.

- 12** All persons using this device for recording telephone conversations shall comply with New Zealand law. This requires that at least one party to the conversation is to be aware that it is being recorded. In addition, the Principles enumerated in the Privacy Act 1993 shall be complied with in respect to the nature of the personal information collected, the purpose for its collection, how it is to be used and what it disclosed to any other party.
- 13** The Caller ID Information is presented in the form: Area Code + Directory number
When dialling back, always insert a zero in front of the area code for a toll call and omit the area code for a local call, If a zero is inserted in front of the area code for a local call, the call will still proceed correctly but if the line has non-code access to another toll carrier, you should check with that carrier before inserting zero on a local call.
- 14** Do not place this product on an unstable surface, stand, or table. The product may fall, causing serious damage to the product.
- 15** Slots and openings in the cabinet and the back or bottom are provided for ventilation; to ensure reliable operation of the product and to protect it from overheating, these openings must not be blocked or covered. The openings should never be blocked by placing the product on a bed, sofa, rug, or other similar surface. This product should never be placed near or over a radiator or heater. This product should not be placed in a built-in installation unless proper ventilation is provided.
- 16** This product should be operated from the type of power source indicated on the label. If you are not sure of the type of power available, consult with your dealer or local power company.
- 17** This product is equipped with a 3-wire earthed plug. This plug will fit into only an earthed socket. This is a safety feature. If you are unable to insert the plug into the outlet, contact your electrician to replace your obsolete socket. Do not defeat the purpose of an earthed plug.
- 18** Do not allow anything to rest on the power cord. Do not locate this product where people can walk on the cord.
- 19** Do not place anything in front of the MFC that will block received faxes. Do not place anything in the path of received faxes.

- 20** Do not touch a document during printing.
- 21** Never push objects of any kind into this product through cabinet slots, since they may touch dangerous voltage points or short out parts resulting in a risk of fire or electric shock. Never spill liquid of any kind on the product.
- 22** Do not attempt to service this product yourself, because opening or removing covers may expose you to dangerous voltage points and/or other risks. Refer all servicing to service personnel.
- 23** Unplug this product from the mains power and telephone line sockets, and refer servicing to qualified Service Personnel under the following conditions:
- If the power cord is damaged or frayed.
 - If liquid has been spilled into the product.
 - If the product has been exposed to rain or water.
 - If the product does not operate normally when the operating instructions are followed. Adjust only those controls that are covered by the operating instructions. Improper adjustment of other controls may result in damage and will often require extensive work by a qualified technician to restore the product to normal operation.
 - If the product has been dropped or the cabinet has been damaged.
 - If the product exhibits a distinct change in performance, indicating a need for service.
- 24** This unit will only work in conjunction with a tone signalling (DTMF) telephone, but some telephones are not compatible. Since noise or speech from the telephone can upset dialling from this unit, errors may result if the devices are used together in other than quiet conditions.
- 25** Where it is necessary to dial prefix digits, such as a Caller Display override code (“0196” or “0197”), this unit will have to be used in conjunction with an associated tone signalling (DTMF) telephone.

- 26** Note that some telephones are not compatible with this unit and dialling errors may result if the two devices are used together in other than quiet conditions. The Telecom Faults Service is not to be called should such problems arise. In such cases, it is recommended that the prefix and wanted number are dialled manually.
- 27** This equipment may not provide for the effective hand-over of a call to another device connected to the same line.
- 28** Immediately disconnect this equipment should it become physically damaged, and arrange for its disposal or repair.
- 29** Some parameters required for compliance with Telecom's Telepermit requirements are dependent on the equipment (PC) associated with this device. The associated equipment shall be set to operate within the following limits for compliance with Telecom's Specifications:-
- There shall be no more than 10 call attempts to the same number within any 30 minute period for any single manual call initiation, and,
- The equipment shall go on-hook for a period of not less than 30 seconds between the end of one attempt and the beginning of the next attempt.
- 30** Some parameters required for compliance with Telecom's Telepermit requirements are dependent on the equipment (PC) associated with this device. In order to operate within the limits for compliance with Telecom's Specifications, the associated equipment shall be set to ensure that automatic calls to different numbers are spaced such that there is no less than 5 seconds between the end of one call attempt and the beginning of another.
- 31** The call log incorporated in this equipment may not record all answered calls. The call log, therefore may not agree with the Telecom account.
- 32** When using the Caller Line Identification incorporated in this device, verify the integrity of the recorded digits prior to dialling.

IMPORTANT-For Your Safety

To ensure safe operation the three-pin plug supplied must be inserted only into a standard three-pin power point which is effectively grounded through the normal household wiring.

Extension cords used with the equipment must be three-conductor and be correctly wired to provide connection to ground. Incorrectly wired extension cords are a major cause of fatalities.

The fact that the equipment operates satisfactorily does not imply that the power is grounded and that the installation is completely safe. For your safety, if in any doubt about the effective grounding of the power, consult a qualified electrician.

Disconnect device

This machine must be installed near a power outlet, which is easily accessible. In case of emergencies, you must disconnect the power cord from the power outlet in order to shut off power completely.

LAN Connection

Caution: Connect this product to the LAN connection which is not subjected to overvoltages.

IMPORTANT NOTICE

Under power failure conditions, this fax may not operate. Please ensure that a separate telephone, not dependant on local power, is available for emergency use.

Important Information for Some Countries

Important Safety Instructions

- 1** Read all of these instructions.
- 2** Save them for later reference.
- 3** Follow all warnings and instructions marked on the product.
- 4** Switch off before cleaning. Do not use liquid or aerosol cleaners. Use a damp cloth for cleaning.
- 5** Do not place this product near water.
- 6** Do not place this product on an unstable cart, stand, or table. The product may drop, causing serious damage to the product.
- 7** Slots and openings in the cabinet and the back or bottom are provided for ventilation; to ensure reliable operation of the product and to protect it from overheating, these openings must not be blocked or covered. The openings should never be blocked by placing the product on a bed, sofa, rug, or other similar surface. This product should never be placed near or on a radiator or heater. This product should never be placed in a built-in installation unless proper ventilation is provided.
- 8** This product should be operated from the type of power source indicated on the label. If you are not sure of the type of power available, consult with your dealer or local power company.
- 9** This product is equipped with a 2-wire grounding type plug or a 3-wire grounding type plug (Only for Singapore, Malaysia, Hong Kong and India), a plug having two or three pins. This plug will only fit into only a grounding-type power outlet. This is a safety feature. If you are unable to insert the plug into the outlet, contact your electrician to replace your obsolete outlet. Do not defeat the purpose of the grounding-type plug.
- 10** Do not allow anything to rest on the power cord. Do not place this product where people can walk on the cord.
- 11** If an extension cord is used with this product, make sure that the total ampere ratings on the products plugged into the extension cord do not exceed the extension cord ampere rating.

- 12** Do not place anything in front of the MFC that will block received faxes. Do not place anything in the path of received faxes.
- 13** Do not touch a document during printing.
- 14** Never push objects of any kind into this product through cabinet slots, since they may touch dangerous voltage points or short out parts resulting in the risk of fire or electric shock. Never spill liquid of any kind on the product.
- 15** Do not attempt to service this product yourself, as opening or removing covers may expose you to dangerous voltage points and/or other risks, and may void your warranty. Please refer all servicing to our Authorized Service Personnel. A list of Authorized Service Centres has been included for your convenience, or you may contact the Brother Dealer for Service.
- 16** Unplug this product from the wall outlet and refer servicing to Authorized Service Personnel under the following conditions:
 - If the power cord is damaged or frayed.
 - If the product has been spilled by liquid.
 - If the product has been exposed to rain or water.
 - If the product does not operate normally when the operating instructions are followed. Adjust only those controls that are covered by the operating instructions. Improper adjustment of other controls may result in damage and will often require extensive work by a qualified technician to restore the product to normal operation.
 - If the product has been dropped or the cabinet has been damaged.
 - If the product exhibits a distinct change in performance, indicating a need for service.
- 17** To protect your product against power surges, we recommend the use of a power protection device (Surge Protector).

 For protection against the risk of electrical shock, always disconnect all cables from the wall outlet before servicing, modifying or installing the equipment.

This equipment may not be used on coin service lines provided by the telephone company or connected to party lines.

Brother cannot accept any financial or other responsibilities that may be the result of your use of this information, including direct, special or consequential damages. There are no warranties extended or granted by this document.

Compilation and Publication Notice

Under the supervision of Brother Industries Ltd., this manual has been compiled and published, covering the latest product descriptions and specifications.

The contents of this manual and the specifications of this product are subject to change without prior notice.

Brother reserves the right to make changes without notice in the specifications and materials contained herein and shall not be responsible for any damages (including consequential) caused by reliance on the materials presented, including but not limited to typographical and other errors relating to the publication.

Trademarks

The Brother logo is a registered trademark of Brother Industries, Ltd.

Brother is a registered trademark of Brother Industries, Ltd.

Multi-Function Link is a registered trademark of Brother International Corporation.

© Copyright 2003 Brother Industries, Ltd. All rights reserved.

Windows, Microsoft and Windows NT are registered trademarks of Microsoft in the U.S. and other countries.

Macintosh, QuickDraw, iMac and iBook are trademarks or registered trademarks of Apple Computer, Inc.

Postscript and Postscript Level 3 are registered trademarks or trademarks of Adobe Systems Incorporated.

PaperPort and TextBridge are registered trademarks of ScanSoft, Inc.

Presto! PageManager is a registered trademark of NewSoft Technology Corporation.

Each company whose software title is mentioned in this manual has a Software License Agreement specific to its proprietary programs.

All other brand and product names mentioned in this User's Guide are registered trademarks of their respective companies.

22 Troubleshooting and routine maintenance

Troubleshooting

IMPORTANT

For technical help, you must call the country where you bought the MFC. Calls must be made **from within** that country.

Error messages

As with any sophisticated office product, errors may occur. If this happens, your MFC identifies the problem and displays an error message. The most common error messages are shown below.

ERROR MESSAGES		
ERROR MESSAGE	CAUSE	ACTION
Change Drum Soon	The drum unit is near the end of its life.	Use the drum unit until you have a print quality problem; then replace the drum unit with a new one.
	The drum counter was not reset.	1. Open the front cover, and then press Clear/Back . 2. Press 1 to reset.
Check Original	The documents were not inserted or fed properly, or document scanned from ADF was longer than about 90cm.	See <i>Document jams</i> on page 22-5.
Check Paper Check Paper #1 Check Paper #2	The MFC is out of paper or paper is not properly loaded in the paper tray.	Refill the paper in the paper tray or MP tray. —OR— Remove the paper and load it again.
Check Paper MP	Paper in the MP tray runs out.	Reload paper. (See <i>To load paper or other media in the multi-purpose tray (MP tray)</i> (For MFC-8820D) on page 2-9.)

ERROR MESSAGES		
ERROR MESSAGE	CAUSE	ACTION
Check Paper Size	When you see this error, the paper in the paper tray does not match the paper size you set in Menu, 1, 3.	Load the appropriate size paper or change the default setting. (See <i>Setting the Mode Timer</i> on page 4-5).
Check Scan Lock	The scanner lock is locked.	Release the scanner lock lever, and then press Stop/Exit .
Comm. Error	Poor phone line quality caused communication error.	Try the call again. If problem continues, call Telephone Company to check your phone line.
Connection Fail	You tried to poll a fax machine that is not in Polled Waiting mode.	Verify the other party's polling setup.
Cooling Down Wait for a while	The temperature of the drum unit or toner cartridge is too hot. The MFC will pause its current print job and go in to cooling down mode. During the cooling down mode, you will hear the cooling fan running while the display on the MFC shows <i>Cooling Down, and Wait for a while.</i>	You must wait 20 minutes for it to cool.
Cover Open Pls Close Cover	The front cover was not completely closed.	Close the front cover for the drum unit.
Disconnected	The other party or other party's fax machine terminated the call.	Try to transmit or receive again.
DX Lever Error	The paper adjustment lever for duplex printing is not correctly set for the paper size.	Set the duplex lever to the correct position. (See <i>To use Automatic Duplexing for fax, copy and print operations (For MFC-8820D)</i> on page 2-11.)
Face Up Open	The face-up output tray is open.	Please close the face-up output tray.
Fuser Open	The fuser cover is open.	Please close the jam clear cover. (See <i>Paper jams</i> on page 22-6.)
Machine Error XX	MFC has a mechanical problem.	Call Brother or your dealer for service.
No DX Tray	You tried to make duplex printing with duplex cover open.	Install the duplex tray correctly. (See <i>Paper is jammed in the duplex tray (For MFC-8820D)</i> on page 22-10.)
No Response/Busy	The number you dialed does not answer or is busy.	Verify the number and try again.

ERROR MESSAGES		
ERROR MESSAGE	CAUSE	ACTION
Not Registered	You tried to access a One-Touch or Speed-Dial number that is not programmed.	Set up the One-Touch or Speed-Dial number. (See <i>Storing One-Touch Dial numbers</i> on page 7-1 and <i>Storing Speed-Dial numbers</i> on page 7-3.)
Out of Memory	You can't store data in the memory.	<p>(Fax sending in process) Press Stop/Exit and wait until the other operations in progress finish and then try again. —OR— Clear the data in the memory. (See <i>Out of Memory message</i> on page 10-5.)</p> <p>(Copy operation in process) Press Stop/Exit and wait until the other operations in process finish and then try again. —OR— Clear the data in the memory. (See <i>Out of Memory message</i> on page 10-5.) —OR— Add an optional memory. (See <i>Memory board</i> on page 23-1.)</p> <p>(Printing operation in process) Reduce print resolution. (See <i>Print Quality</i> on page 12-5.) —OR— Clear the data in the memory. (See <i>Out of Memory message</i> on page 10-5.) —OR— Add an optional memory. (See <i>Memory board</i> on page 23-1.)</p>
Paper Jam	The paper is jammed in the MFC.	See <i>Paper jams</i> on page 22-6 and <i>Paper is jammed in the duplex tray (For MFC-8820D)</i> on page 22-10.

ERROR MESSAGES		
ERROR MESSAGE	CAUSE	ACTION
Pls Open Cover	A page, piece of paper or paper clip, etc. may be jammed inside the MFC.	Open the front cover. If you see any jammed paper or other item, gently pull it out, then close the front cover. If the error message remains, open and close the front cover again. If the MFC cannot reset itself and return to the date and time prompt, it will display <i>Machine Error XX</i> . Then contact your Brother dealer for service.
Toner Empty	Toner cartridge is not installed. —OR— Toner is used up and printing is not possible.	Reinstall the toner cartridge. —OR— Replace the toner cartridge with a new one. (See <i>Replacing the toner cartridge</i> on page 22-27.)
Toner Low	If the LCD shows <i>Toner Low</i> , you can still print. But the toner is depleted and the MFC is telling you that the toner will soon run out.	Order a new toner cartridge now.

Document jams

Based upon where the document is jammed, follow the appropriate set of instructions to remove it.

Document is jammed in the top of the ADF unit.

- 1 Take out any paper from the ADF that is not jammed.
- 2 Lift the ADF cover.
- 3 Pull the jammed document out to the right.
- 4 Close the ADF cover.
- 5 Press **Stop/Exit**.

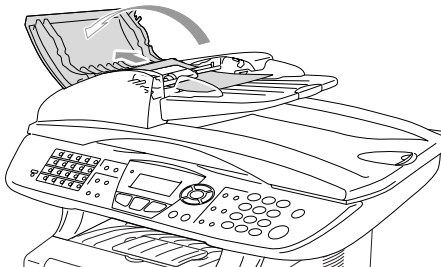

Document is jammed inside the ADF unit.

- 1 Take out any paper from the ADF that is not jammed.
- 2 Lift the document cover.
- 3 Pull the jammed document out to the right.
- 4 Close the document cover.
- 5 Press **Stop/Exit**.

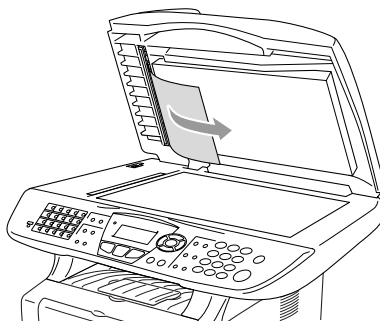

—OR—

- 1 Take the ADF support out of the ADF unit.
- 2 Pull the jammed document out to the right.
- 3 Press **Stop/Exit**.

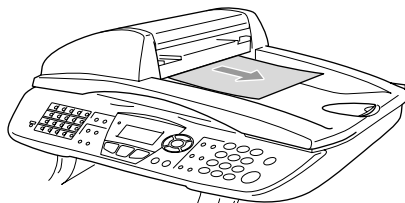

Paper jams

To clear paper jams, please follow the steps in this section.

WARNING

After you have just used the MFC, some parts inside the MFC are extremely hot. When you open the front cover or back output tray of the MFC, never touch the shaded parts shown in the following diagram.

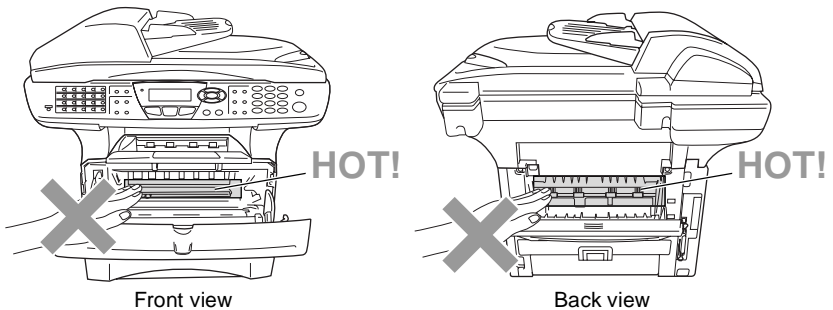

Clear the jammed paper as follows.

If the jammed paper is removed completely by using the information in the following steps, you can install the paper tray first, and then close the front cover and the MFC will resume printing automatically.



- If a paper jam occurs when using the optional lower tray unit, check for correct installation of the upper paper tray.
- Always remove all paper from the paper tray and straighten the stack when you add new paper. This helps prevent multiple sheets of paper from feeding through the MFC at one time and reduces paper jams.

- 1 Pull the paper tray completely out of the MFC.
- 2 Pull the jammed paper up and out of the MFC.

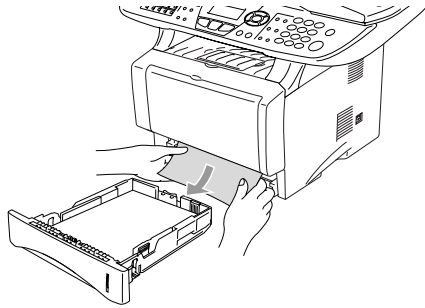

- 3 Press the cover release button and then open the front cover.
- 4 Pull out the drum unit assembly. Pull the jammed paper up and out of the MFC. If you cannot remove the drum unit assembly easily at this time, do not use extra force. Instead, pull the edge of the jammed paper from the paper tray.

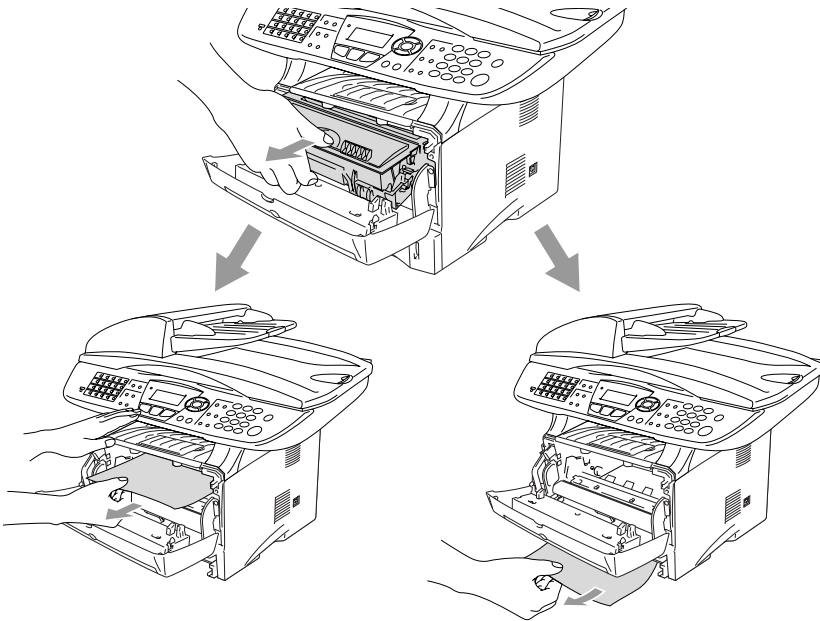

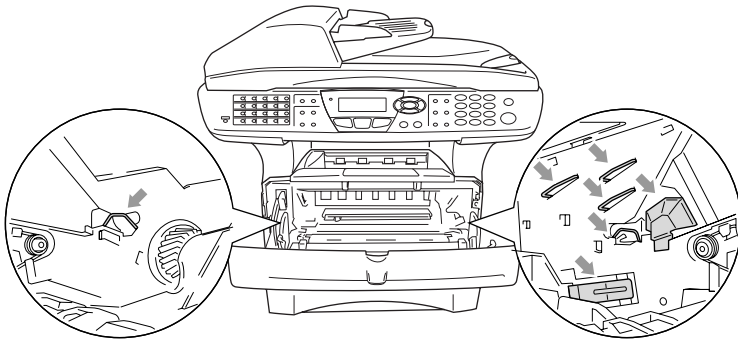

⚠ WARNING

To prevent damage to the MFC caused by static electricity, do not touch the electrodes shown in the following diagram.

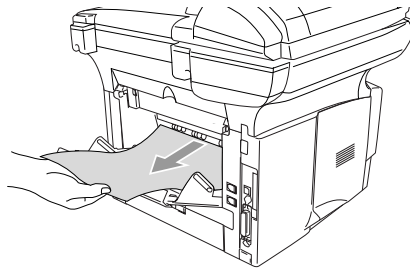

- 5** Open the back output tray. Pull the jammed paper out of the fuser unit. If the paper jam can be cleared, go to Step 7.



-  If you have to pull the paper toward the back of the MFC, the fuser may get dirty with toner powder and it may scatter on the next printouts. Print a few copies of the test page until the scattering of toner stops.

⚠ WARNING

After you have just used the MFC, some internal parts of the MFC are extremely **HOT!** Wait for the MFC to cool down before you touch the internal parts of the MFC.

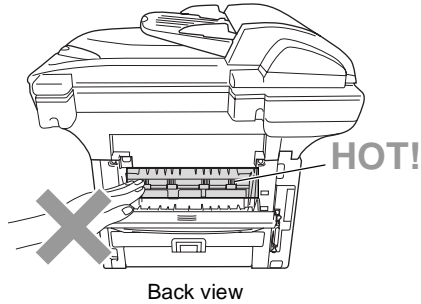

- 6** Open the jam clear cover (fuser cover). Pull the jammed paper out of the fuser unit.

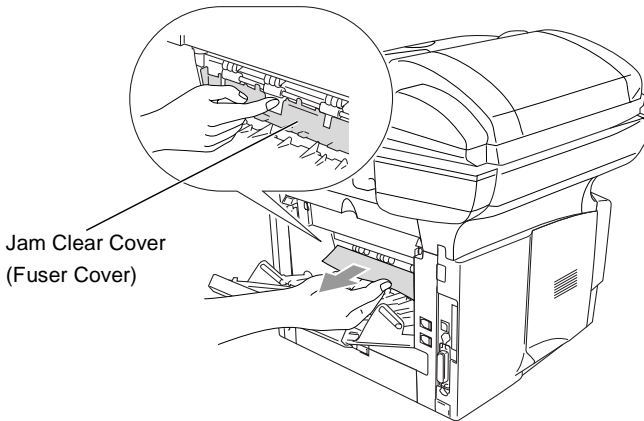

- 7** Close the jam clear cover. Close the back output tray.

- 8 Push the lock lever down and take the toner cartridge out of the drum unit assembly. Take out the jammed paper if there is any inside the drum unit.

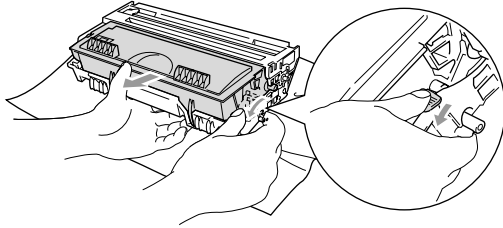

- 9 Put the drum unit assembly back in the MFC.
- 10 Put the paper tray in the MFC.
- 11 Close the front cover.

Paper is jammed in the duplex tray (For MFC-8820D)

- 1 Pull the duplex tray and paper tray out of the MFC.

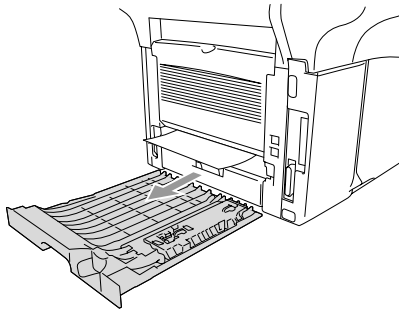

- 2 Pull the jammed paper out of the MFC.

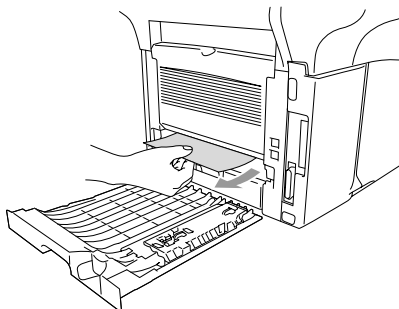

3 Put the duplex tray and paper tray back into the MFC.

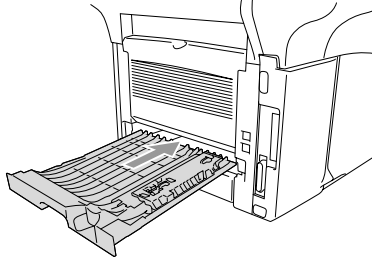

- The **Jam Duplex** message appears if you remove a sheet of paper from the Face Down Output Tray after only one side has printed.
- If the Paper Adjustment Lever for Duplex Printing is not set correctly for the paper size, paper jams may occur and the printing will be out of position on the page.

If you are having difficulty with your MFC

If you think there is a problem with the way your faxes look, *make a copy first*. If the copy looks good, the problem is probably not your MFC. Check the chart below and follow the troubleshooting tips.

DIFFICULTY	SUGGESTIONS
Printing or Receiving Faxes	
Condensed print and horizontal streaks or the top and bottom of sentences are cut off.	If your copy looks good, you probably had a bad connection, with static or interference on the telephone line. If the copy looks bad, clean the scanner area. If there is still problem, call Brother or your dealer for service.
Poor quality print.	See <i>Improving the print quality</i> on page 22-17.
Vertical black lines when receiving.	Sometimes you may see vertical streaks/black lines on the faxes you receive. Your MFC's primary corona wire for printing may be dirty, or the sending party's fax scanner may be dirty. Clean your primary corona wire (See <i>Cleaning the drum unit</i> on page 22-26), or ask the sender to make a copy to see if the problem is with the sending machine. Try receiving from another fax machine. If the problem continues call your dealer for service.
Horizontal streaks; lines are missing.	You may get a fax with horizontal streaks or with missing lines. Usually this is caused by a poor telephone connection. Ask the other party to send the fax again.
Received faxes appear as split or blank pages.	If the received data is divided and printed on two pages or if you get an additional blank page, your Paper Size setting may not be correct for the paper you are using (See <i>Type and size of paper</i> on page 2-1). Make sure that auto reduction function setting is turned on. (See <i>Printing a reduced incoming fax (Auto Reduction)</i> on page 5-5.)
Phone Line or Connections	
Dialing does not work	Check for a dial tone. Change Tone/Pulse setting. (See <i>Setting Tone or Pulse dialing mode (Except for New Zealand)</i> on page 4-14.) Check all line cord connections. Check power cord connection. Send a manual fax by lifting the external handset and dialing the number. Wait to hear fax receiving tones before pressing Start .
The MFC does not answer when called.	Make sure the MFC is in the correct receiving mode for your setup. (See <i>Basic sending operations</i> on page 6-7.) Check for a dial tone. If possible, call your MFC to hear it answer. If there is still no answer, check the telephone line cord connection. If there is no ringing when you call your MFC, ask your telephone company to check the line.

DIFFICULTY	SUGGESTIONS
Sending Faxes	
Poor sending quality.	Try changing your resolution to <i>Fine</i> or <i>S. Fine</i> . Make a copy to check your MFC's scanner operation. If copy quality is not good, clean the scanner. (See <i>Cleaning the scanner</i> on page 22-24.)
Transmission Verification Report says 'RESULT:NG' or 'RESULT:ERROR'.	There is probably temporary noise or static on the line. Try sending the fax again. If you send a PC FAX message and get 'RESULT:NG' or, on the Transmission Verification Report, your MFC may be out of memory. To gain extra memory, you can turn off Fax Storage (see <i>Setting Fax Storage</i> on page 8-2), print fax messages in memory (see <i>Polling</i> on page 5-10) or cancel a Delayed Fax or Polling Job (see <i>Canceling a job while scanning the document</i> on page 6-12). If the problem continues, ask the telephone company to check your phone line.
Vertical black lines when sending.	If the copy you made shows the same problem, your scanner is dirty. (See <i>Cleaning the scanner</i> on page 22-24.)
Handling Incoming Calls	
MFC 'Hears' Voice as CNG Tone.	If your MFC is set to Fax Detect ON, it is more sensitive to sounds. Your MFC may mistakenly interpret certain voices or music on the line as a calling fax machine and respond with fax receiving tones. Deactivate the fax by pressing Stop/Exit . Try avoiding this problem by turning Fax Detect to OFF. (See <i>Fax Detect</i> on page 5-4.)
Sending a Fax Call to the MFC.	If you answered at the MFC, press Start and hang up immediately. If you answered on an external or extension phone, enter your Remote Activation Code (default setting is *51 (*91 for New Zealand). When your MFC answers, hang up.
Custom features on a single line.	If you have Call Waiting, Call Waiting/Caller ID, RingMaster, Voice Mail, an answering machine, an alarm system or other custom feature on a single phone line with your MFC, it may create a problem sending or receiving fax data.
Menu Setting Difficulties	
The MFC beeps when you try to access the Setup Receive and Setup Send menu.	Make sure that MFC is in Fax mode. If the Fax  key is not illuminated, press it to turn on Fax mode. Setup Receive Setting (Menu, 2, 1) and Setup Send Setting (Menu, 2, 2) are available only when the MFC is in Fax mode.
Copy Quality Difficulties	
Vertical streaks appear in copies.	Sometimes you may see vertical streaks on your copies. Either the scanner or the primary corona wire for printing is dirty. Clean them both. (See <i>Cleaning the scanner</i> on page 22-24 and <i>Cleaning the drum unit</i> on page 22-26.)







DIFFICULTY	SUGGESTIONS
Printer Difficulties	
The MFC does not print.	Check the following: <ul style="list-style-type: none"> • The MFC is plugged in and the power switch turned On. (See the Quick Setup Guide on page 5.) • The toner cartridge and drum unit are installed properly. (See <i>Replacing the drum unit</i> on page 22-32.) • The interface cable is securely connected between the MFC and computer. (See the Quick Setup Guide.) • Check to see if LCD is showing an error message. (See <i>Error messages</i> on page 22-1.)
The MFC prints unexpectedly or it prints garbage.	Reset the MFC or turn it off and then on again. Check the primary settings in your application software to make sure it is set up to work with your MFC.
The MFC prints first couple of pages correctly, then some pages have text missing.	Your computer is not recognizing the printer's input buffer full signal. Please make sure to connect the MFC cable correctly.
The MFC cannot print full pages of a document. Out of Memory message occurs.	Reduce the printing resolution. Reduce the complexity of your document and try again. Reduce the graphic quality or the number of font sizes within your application software.
My headers or footers appear when I view my document on the screen but do not appear when I print them.	Most laser printers have a restricted area that will not accept print. Usually these are the first two lines and last two lines, leaves 62 printable lines. Adjust the top and bottom margins in your document to allow for this.
Scanning Difficulties	
TWAIN errors appear while scanning.	Make sure the Brother TWAIN driver is selected as the primary source. In PaperPort®, click Scan in the File menu and select the Brother TWAIN driver.
Software Difficulties	
Cannot perform '2 in 1 or 4 in 1' printing.	Check that the paper size setting in the application and in the printer driver are the same.
Cannot print when using Adobe Illustrator.	Try to reduce the print resolution.
When using ATM fonts, some characters are missing or some characters are printed in their place.	If you are using Windows® 95/98/98SE/Me, select 'Printer Settings' from the 'Start' menu. Select the properties of the 'Brother MFC-8420 or MFC-8820D (USB) Printer'. Click 'Spool Setting' on the 'Details' tab. Select 'RAW' from 'Spool Data Format.'

DIFFICULTY	SUGGESTIONS
"Unable to write to LPT1" or "LPT1 already in use" Error Message appears.	1. Make sure the MFC is on (plugged into the AC power outlet and turned the power switch on) and that it is connected directly to the computer using the bundled IEEE-1284 bi-directional parallel cable. The cable must not go through another peripheral device (such as a Zip Drive, External CD-ROM Drive, or Switch box).
"MFC is Busy" or "MFC Connect Failure" Error Message appears.	2. Make sure the MFC is not displaying an error message on the LCD Display. 3. Make sure no other device drivers, which also communicate through the parallel port, are running automatically when you boot up the computer (such as, drivers for Zip Drives, External CD-ROM Drive, etc.) Suggested areas to check: (Load=, Run=command lines in the win.ini file or the Statup Group) 4. Check with your computer manufacturer to confirm that the computer's parallel port settings in the BIOS are set to support a bi-directional machine; i.e. (Parallel Port Mode – ECP)
"MFC Connect Failure"	If the MFC is not connected to your PC and you have loaded the Brother software, the PC will show 'MFC Connect Failure' each time you restart Windows®. You can ignore this message or you can turn it off as follows. Double-click "tool\WarnOFF.REG" from the supplied CD-ROM. The Scan key on the MFC's control panel will not work unless you restart your PC with the MFC connected. To turn it back on, Double-click "tool\WarnON.REG" from the supplied CD-ROM.
Paper Handling Difficulties	
The MFC does not load paper. The LCD shows Check Paper or Paper Jam.	Check to see if the Check Paper or Paper Jam message appears on the LCD. If it is empty, load a new stack of paper into the paper tray. If there is paper in the paper tray, make sure it is straight. If the paper is curled, you should straighten it. Sometimes it is helpful to remove the paper, turn the stack over and put it back into the paper tray. Reduce the amount of paper in the paper tray, and then try again. Check that the manual feed mode or MP tray or MP mode is not selected in the printer driver.
The MFC does not feed paper from the manual feed tray.	Reinsert the paper firmly, load one sheet at a time. Make sure that manual feed mode or MP mode is selected in the printer driver.
How can I load envelopes?	You can load envelopes from the manual feed or MP tray. Your application software must be set up to print the envelope size you are using. This is usually done in the Page Setup or Document Setup menu of your software. Refer to your software application manual.
What paper can I use?	You can use plain paper, envelopes, transparencies and labels that are made for laser machines. (For information on paper you can use, see <i>Printer operation keys</i> on page 11-17.)
How can I clear paper jams?	See <i>Paper jams</i> on page 22-6.



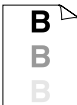



DIFFICULTY	SUGGESTIONS
Print Quality Difficulties	
Printed pages are curled.	Thin or thick paper below the standard can cause this problem. Make sure you select the Paper Type that suits the media type you use. (See <i>Setting the Paper Type</i> on page 4-6 and <i>Media Type</i> on page 12-4.)
Printed pages are smeared.	The Paper Type setting may be incorrect for the type of print media you are using— OR —The print media may be too thick or have a rough surface. (See <i>Setting the Paper Type</i> on page 4-6 and <i>Media Type</i> on page 12-4.)
Printouts are too light.	Set Toner Save mode to off in the Advance tab in the printer driver. (See <i>Toner Save Mode</i> on page 12-6.)
Network Difficulties	
I cannot print over the Network	Make sure that your MFC is powered on and is On Line and in Ready mode. Press the Test switch. Then the current settings of the NC-9100h are printed. Verify that the cabling and Network connections are good. If possible, try connecting the MFC to a different port on your hub using a different cable. Check to see if there is any LED activity. The NC-9100h has a two color LED for diagnosing problems.

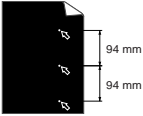
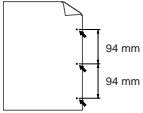
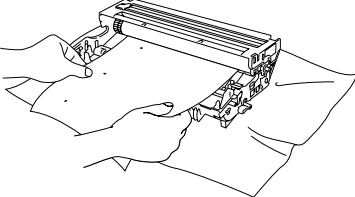
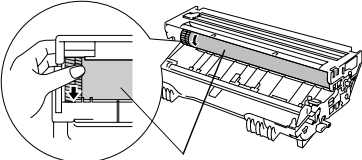
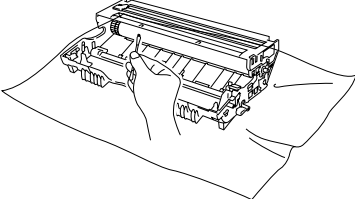

Improving the print quality

This section provides information on the following topics:

Examples of poor print quality	Recommendation
 <p>Faint</p>	<p>Check the printer's environment. Conditions such as humidity, high temperatures, and so on may cause this print fault. (See <i>Choosing a location</i> on page iv.)</p> <p>If the whole page is too light, Toner Save mode may be on. Turn off Toner Save mode in the printer Properties tab of the driver.</p> <p>—OR—</p> <p>If your MFC is not connected to a computer, turn off Toner Save mode in the MFC itself. (See <i>Toner Save</i> on page 4-9.)</p> <p>Try installing a new toner cartridge. (See <i>Replacing the toner cartridge</i> on page 22-27.)</p> <p>Try installing a new drum unit. (See <i>Replacing the drum unit</i> on page 22-32.)</p>
 <p>Gray background</p>	<p>Make sure that you use paper that meets the recommended specifications. (See <i>About paper</i> on page 2-1.)</p> <p>Check the printer's environment - high temperatures and high humidity can increase the amount of background shading. (See <i>Choosing a location</i> on page iv.)</p> <p>Use a new toner cartridge. (See <i>Replacing the toner cartridge</i> on page 22-27.)</p> <p>Use a new drum unit. (See <i>Replacing the drum unit</i> on page 22-32.)</p>
 <p>Ghost</p>	<p>Make sure you use paper that meets our specifications. Rough-surfaced paper or thick print media may cause this problem.</p> <p>Make sure that you choose the appropriate media type in the printer driver. (See <i>About paper</i> on page 2-1.)</p> <p>Try using a new drum unit. (See <i>Replacing the drum unit</i> on page 22-32.)</p>
 <p>Toner specks</p>	<p>Make sure that you use paper that meets our specifications. Rough-surfaced paper may cause the problem. (See <i>About paper</i> on page 2-1.)</p> <p>The drum unit may be damaged. Put in a new drum unit. (See <i>Replacing the drum unit</i> on page 22-32.)</p>
 <p>Hollow print</p>	<p>Make sure that you use paper that meets our specifications. (See <i>About paper</i> on page 2-1.)</p> <p>Choose Thick Paper mode in the printer driver, or use thinner paper than you are currently using.</p> <p>Check the printer's environment because conditions such as high humidity can cause hollow print. (See <i>Choosing a location</i> on page iv.)</p>
 <p>All black</p>	<p>You may clear the problem by cleaning the primary corona wire inside the drum unit by sliding the blue tab. Make sure you return the blue tab to the home position (▲). (See <i>Cleaning the drum unit</i> on page 22-26.)</p> <p>The drum unit may be damaged. Put in a new drum unit. (See <i>Replacing the drum unit</i> on page 22-32.)</p>

Examples of poor print quality	Recommendation
 <p>White Spots on black text and graphics at 94 mm intervals</p>  <p>Black Spots at 94 mm intervals</p>	<p>If the problem is not solved after printing a few pages, the drum unit may have glue from label stock on the OPC drum surface.</p> <p>Clean the drum unit as follows:</p> <ol style="list-style-type: none"> 1 Position the print sample in front of the drum unit, and find the exact position of the poor print.  <p>! Caution Be careful not to touch the photosensitive drum with your fingers.</p>  <p>Photosensitive drum</p> <ol style="list-style-type: none"> 3 When you have located the mark on the drum that matches the print sample, wipe the surface of the OPC drum with a cotton swab until the dust or paper powder on the surface comes off.  <p>! Caution Do not try to clean the surface of the photosensitive drum with a sharp object, such as a ball-point pen, and so on.</p> <p>The drum unit may be damaged. Put in a new drum unit. (See <i>Replacing the drum unit</i> on page 22-32.)</p>

Examples of poor print quality	Recommendation
 <p>Black toner marks across the page</p>	<p>The drum unit may be damaged. Put in a new drum unit. (See <i>Replacing the drum unit</i> on page 22-32.)</p> <p>Make sure that you use paper that meets our specifications. (See <i>About paper</i> on page 2-1.)</p> <p>If you use label sheets for laser printers, the glue from the sheets may sometimes stick to the OPC drum surface. Clean the drum unit. (See <i>Cleaning the drum unit</i> on page 22-26.)</p> <p>Do not use paper that has clips or staples because they will scratch the surface of the drum.</p> <p>If the unpacked drum unit is in direct sunlight or room light, the unit may be damaged.</p>
 <p>White lines across the page</p>	<p>Make sure that you use paper that meets our specifications. A rough surfaced paper or thick print media can cause the problem.</p> <p>Make sure that you select the appropriate media type in the printer driver.</p> <p>The problem may disappear by itself. Try printing multiple pages to clear this problem, especially if the printer has not been used for a long time.</p> <p>The drum unit may be damaged. Put in a new drum unit. (See <i>Replacing the drum unit</i> on page 22-32.)</p>
 <p>Lines across the page</p>	<p>Clean the inside of the printer and the primary corona wire in the drum unit. (See <i>Cleaning the drum unit</i> on page 22-26.)</p> <p>The drum unit may be damaged. Put in a new drum unit. (See <i>Replacing the drum unit</i> on page 22-32.)</p>
 <p>Black lines down the page</p> <p>Printed pages have toner stains down the page.</p>	<p>Clean the primary corona wire of the drum unit.</p> <p>Make sure the primary corona wire cleaner is at the home position (▲).</p> <p>The drum unit may be damaged. Install a new drum unit. (See <i>Replacing the drum unit</i> on page 22-32.)</p> <p>The toner cartridge may be damaged. Put in a new toner cartridge. (See <i>Replacing the toner cartridge</i> on page 22-27.) Make sure that a torn piece of paper is not inside the printer covering the scanner window.</p> <p>The fixing unit may be smudged. Call Customer Service.</p>
 <p>White lines down the page</p>	<p>You may clear the problem by wiping the scanner window with a soft cloth. (See <i>Cleaning the printer</i> on page 22-25.)</p> <p>The toner cartridge may be damaged. Put in a new toner cartridge. (See <i>Replacing the toner cartridge</i> on page 22-27.)</p>
 <p>Page skewed</p>	<p>Make sure the paper or other print media is loaded properly in the paper tray and that the guides are not too tight or too loose against the paper stack.</p> <p>Set the paper guides correctly.</p> <p>If you are using the manual feed tray (or the multi-purpose tray). (See <i>How to load paper</i> on page 2-5.)</p> <p>The paper tray may be too full.</p> <p>Check the paper type and quality. (See <i>About paper</i> on page 2-1.)</p>

Examples of poor print quality	Recommendation
 <p data-bbox="230 293 344 312">Curl or wave</p>	<p data-bbox="434 170 1021 212">Check the paper type and quality. High temperatures and high humidity will cause paper to curl.</p> <p data-bbox="434 217 1021 300">If you don't use the printer very often, the paper may have been in the paper tray too long. Turn over the stack of paper in the paper tray. Also, try fanning the paper stack and then rotating the paper 180° in the paper tray.</p> <p data-bbox="434 304 1021 346">Try printing using the straight-through output path. (See <i>How to load paper</i> on page 2-5.)</p>
 <p data-bbox="199 485 378 504">Wrinkles or creases</p>	<p data-bbox="434 362 770 383">Make sure that paper is loaded properly.</p> <p data-bbox="434 387 983 408">Check the paper type and quality. (See <i>About paper</i> on page 2-1.)</p> <p data-bbox="434 413 1021 454">Try printing using the straight-through output path. (See <i>How to load paper</i> on page 2-5.)</p> <p data-bbox="434 459 1021 501">Turn over the stack of paper in the tray or try rotating the paper 180° in the input tray.</p>



The drum unit is a consumable item and it is necessary to replace it periodically.

Packing and shipping the MFC

Whenever you transport the MFC, use the packing materials that came with your machine. If you do not pack the MFC correctly, you may void your warranty.

- 1 Turn the MFC power switch off.
- 2 Unplug the MFC from the telephone wall socket.
- 3 Unplug the MFC from the AC outlet.

Lock the Scanner Lock

- 4 Push the Scanner Lock Lever up to lock the scanner. This lever is located on the left of the scanner glass.

Scanner Lock Lever

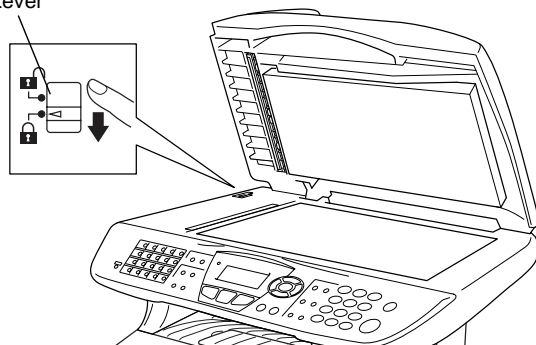

! Caution

Damage caused to your MFC by failure to lock the scanner before moving and shipping may void your warranty.

- 5 Open the front cover.

- 6** Remove the drum unit and toner cartridge assembly. Leave the toner cartridge installed in the drum unit.

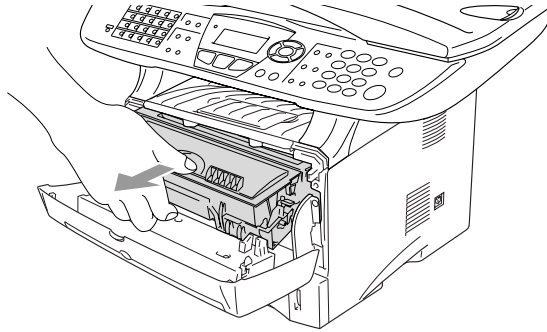

- 7** Place the drum unit and toner cartridge assembly into the plastic bag and seal the bag.

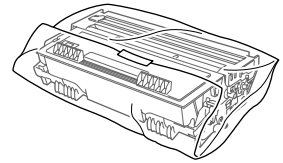

- 8** Close the front cover. Fold down the face-down output tray flap. Remove the telephone line cord.

- 9** Wrap the MFC in the plastic bag and place it in the original carton with the original packing material.

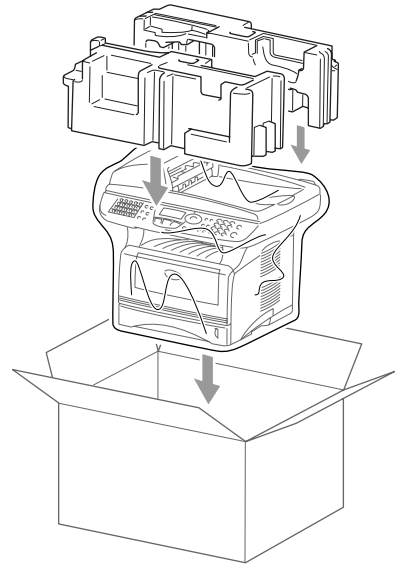
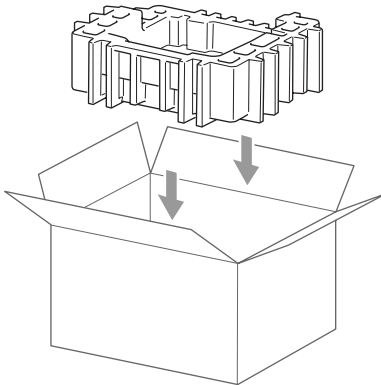

- 10** Pack the drum unit and toner cartridge assembly, telephone line cord, AC cord and printed materials in the original carton as shown below:

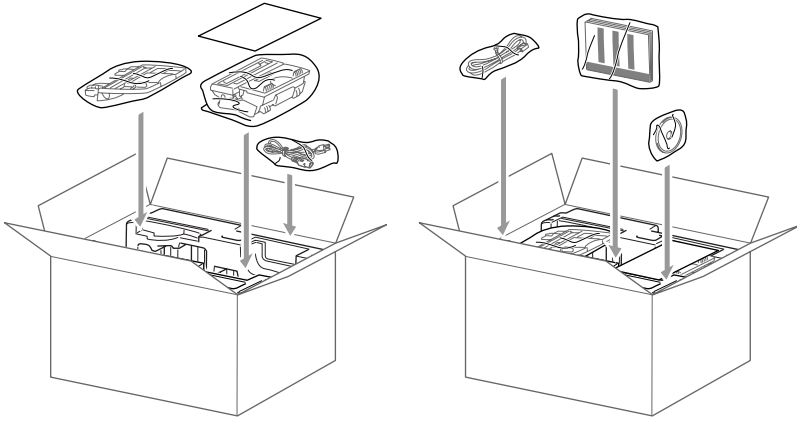

- 11** Close the carton and tape it shut.

Routine maintenance

Cleaning the scanner

Turn the MFC power switch off and lift the document cover. Clean the scanner glass and glass strip with dry cloth and the white film with isopropyl alcohol on a lint free cloth.

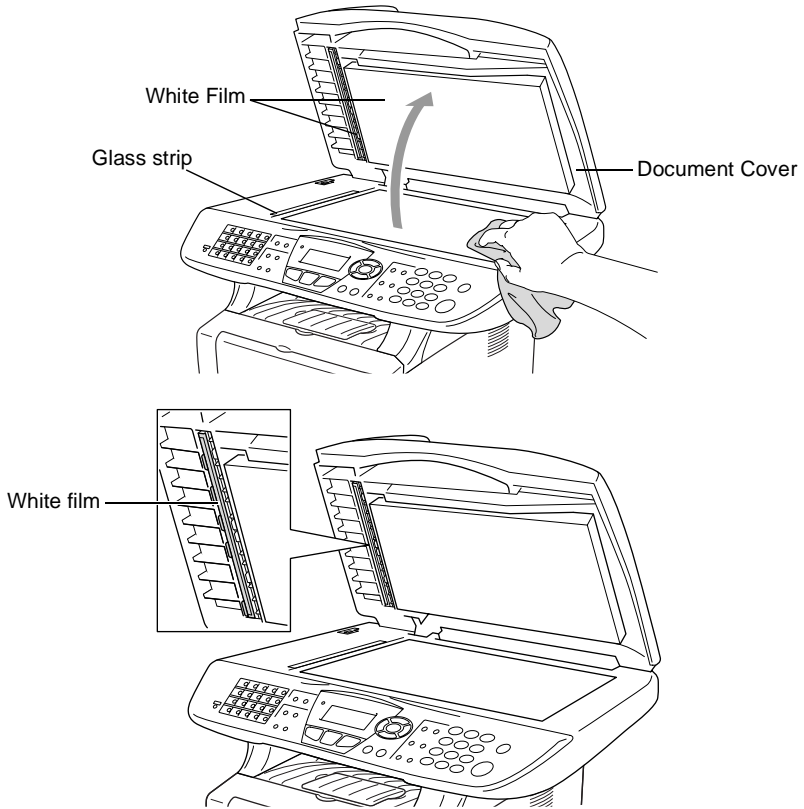

Cleaning the printer

! Caution

- Do *not* use isopropyl alcohol to remove dirt from the control panel. It may crack the panel.
 - Do *not* use isopropyl alcohol to clean the laser scanner window.
 - Do *not* touch the scanner window with your finger.
 - The drum unit contains toner, so handle it carefully. If toner scatters and your hands or clothes get dirty, immediately wipe or wash it off with cold water.
- 1 Turn the MFC power switch off and open the front cover.
 - 2 Remove the drum unit and toner cartridge assembly.

! WARNING

Just after you have used the MFC, some internal parts of the machine are extremely **HOT!** When you open the front cover of the MFC, never touch the shaded parts shown in the diagram below.

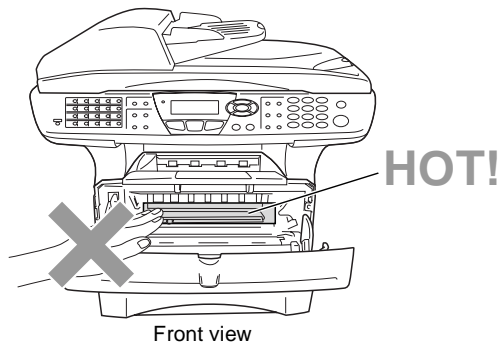

- 3 Gently clean the scanner window by wiping it with a clean soft dry cloth. Do *not* use isopropyl alcohol.

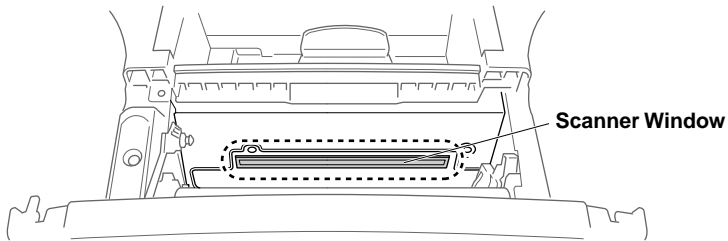

Cleaning the drum unit

We recommend placing the drum unit and toner cartridge assembly on a cloth or large disposable paper to avoid spilling and scattering toner.

- 1 Clean the primary corona wire inside the drum unit by gently sliding the blue tab from right to left several times.
- 2 Return the blue tab and snap it into the Home position (▼).

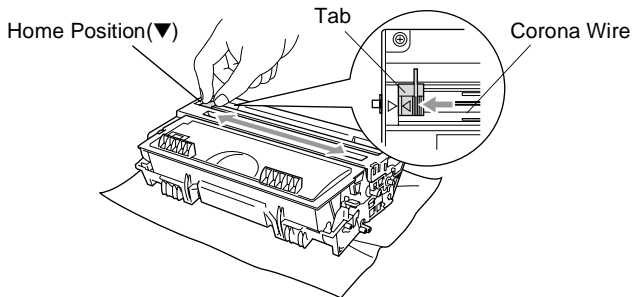

! Caution

If the blue tab is not at Home position (▼), printed pages may have vertical stripes.

- 3 Reinstall the drum unit and toner cartridge assembly into the MFC. (See *Replacing the drum unit* on page 22-32.)
- 4 Close the front cover.
- 5 Plug in the power cord *first*, then the telephone cord.

Replacing the toner cartridge

The MFC can print *up to 6,500* pages using a *high yield* toner cartridge. When the toner cartridge is running low, the LCD shows `Toner Low`. The MFC is supplied with a *standard* toner cartridge that must be replaced after approximately 3,300 pages. Actual page count will vary depending on your average type of document (i.e., standard letter, detailed graphics).

 It is a good idea to keep a new toner cartridge ready for use when you see the `Toner Low` warning.

Discard the used toner cartridge according to local regulations, keeping it separate from domestic waste. Be sure to seal the toner cartridge tightly so toner powder does not spill out of the cartridge. If you have questions, call your local waste disposal office.

We recommend that you clean the MFC when you replace the toner cartridge.

How to replace the toner cartridge

WARNING

Just after you use the MFC, some internal parts of the machine will be extremely **HOT!** So, never touch the shaded parts shown in the illustration.

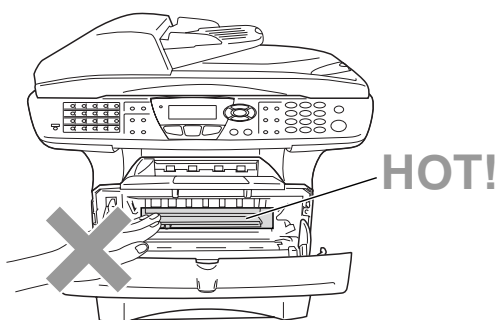

1 Open the front cover and pull out the drum unit.

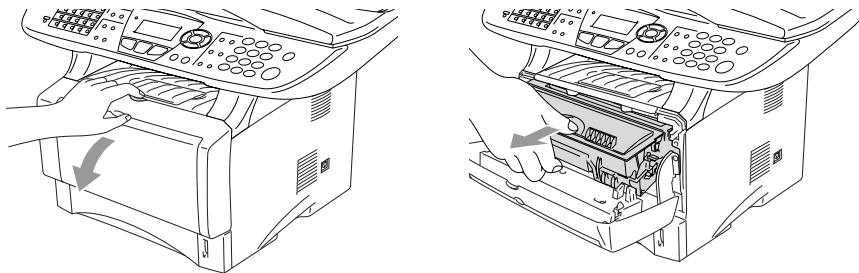

! Caution

- Place the drum unit on a drop cloth or large piece of disposable paper to avoid spilling and scattering the toner.
- To prevent damage to the MFC from static electricity, do not touch the electrodes shown below.

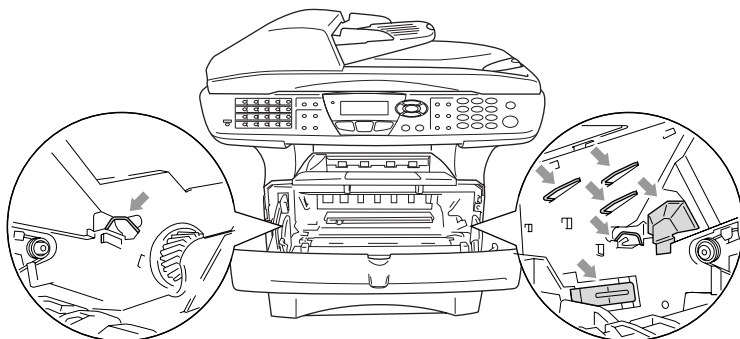

- 2 Hold down the lock lever on the right and pull the toner cartridge out of the drum unit.

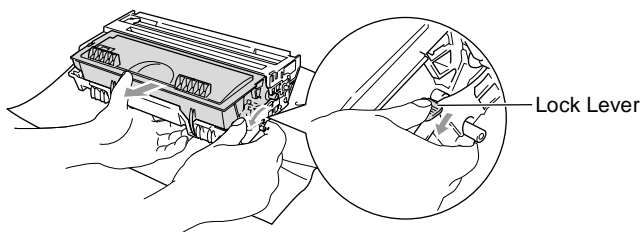

! Caution

Handle the toner cartridge carefully. If toner scatters on your hands or clothes, immediately wipe it off or wash it with cold water.

- 3 Unpack the new toner cartridge. Place the used toner cartridge into the aluminum bag and discard it according to local regulations.

! Caution

- Wait to unpack the toner cartridge until immediately before you install it in the MFC. If a toner cartridge is left unpacked for a long period of time, the toner life is shortened.
- Brother multifunction machines are designed to work with toner of a particular specification and work to a level of optimum performance, when used with genuine Brother toner cartridges. Brother cannot guarantee this optimum performance if toner or toner cartridges of other specifications are used. Brother does not therefore recommend the use of cartridges other than genuine Brother cartridges with this machine nor does it recommend the refilling of empty cartridges with toner from other sources. If damage is caused to parts of this machine as a result of the use of toner or toner cartridges other than genuine Brother products due to the incompatibility or lack of suitability of those products with the machine, any repairs required as a result will not be covered by the warranty.

- 4** Gently rock the toner cartridge from side to side five or six times to distribute the toner evenly inside the cartridge.

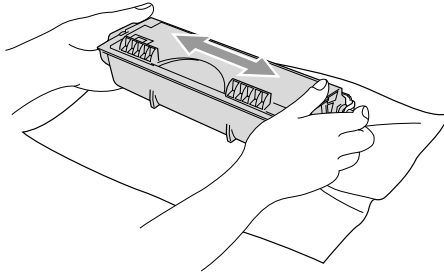

- 5** Remove the protective cover.

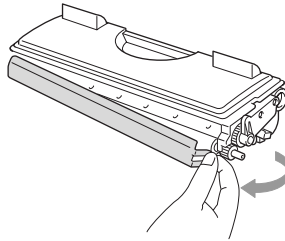

- 6** Insert the new toner cartridge in the drum unit until it clicks into place. If you put it in properly, the lock lever will lift automatically.

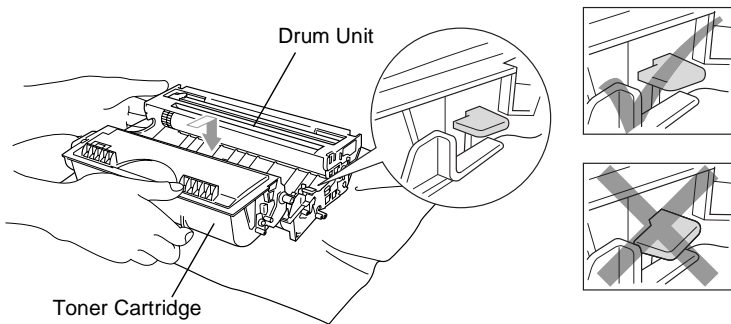

- 7** Clean the primary corona wire inside the drum unit by gently sliding the blue tab from right to left several times. Return the blue tab to the Home position (▼) before reinstalling the drum unit and toner cartridge assembly.

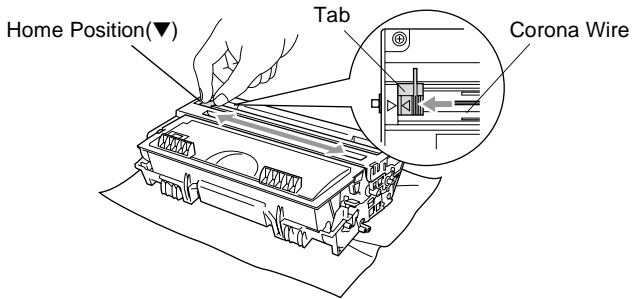

- 8** Reinstall the drum unit and toner cartridge assembly and close the front cover.

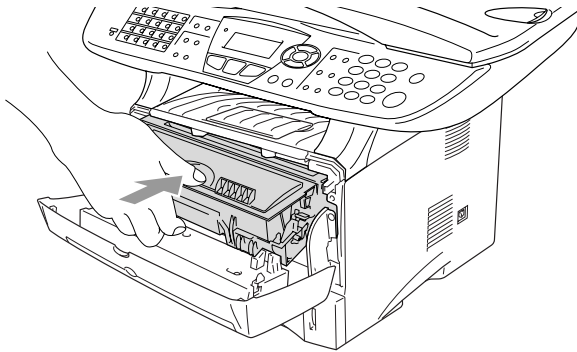

Replacing the drum unit

The MFC uses a drum unit to create print images on paper. If the LCD shows *Change Drum Soon*, the drum unit is near the end of its life and it is time to purchase a new one.

Even if the LCD shows *Change Drum Soon*, you may be able to continue printing without having to replace the drum unit for a while. However, if there is a noticeable deterioration in the output print quality (even before *Change Drum Soon* appears), then the drum unit should be replaced. You should clean the MFC when you replace the drum unit. (See *Cleaning the drum unit* on page 22-26.)

! Caution

When removing the drum unit, handle it carefully because it contains toner. If toner scatters and your hands or clothes get dirty, immediately wipe or wash with cold water.

 The actual number of pages your drum will print may be significantly less than these estimates. Because we have no control over the many factors that determine the actual drum life, we cannot guarantee a minimum number of pages that will be printed by your drum.

! WARNING

Just after you have used the MFC, some internal parts of the MFC are extremely **HOT!** So please be careful.

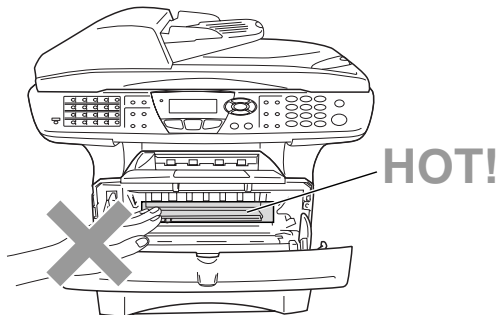

Follow these steps to replace the drum unit:

- 1** Press the cover release button and then open the front cover.
- 2** Remove the old drum unit and toner cartridge assembly. Place it on a drop cloth or disposable paper to avoid scattering toner.

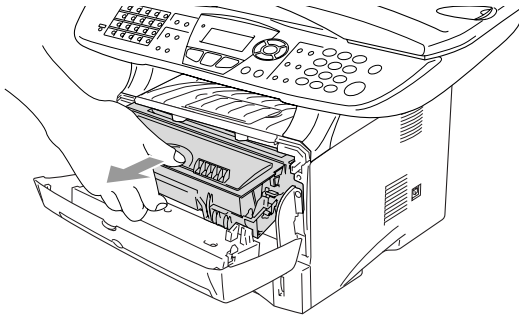

! Caution

To prevent damage to the printer from static electricity, do not touch the electrodes shown below.

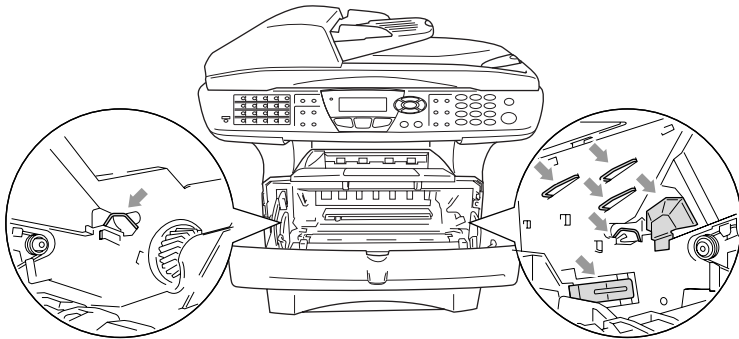

- 3 Hold down the lock lever on the right and pull the toner cartridge out of the drum unit. (See *Replacing the toner cartridge* on page 22-27.)

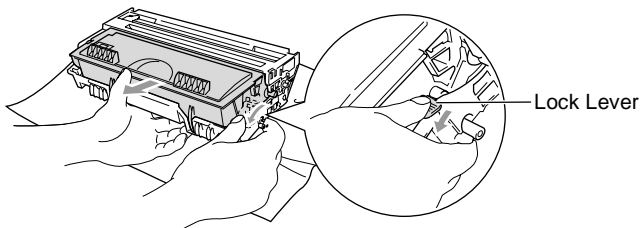

- 4 Discard the used drum unit according to local regulations, keeping it separate from domestic waste. Be sure to seal the drum unit tightly so toner powder does not spill out of the unit. If you have questions, call your local waste disposal office.
- 4 Wait to unpack the new drum unit until immediately before installing it. Place the old drum unit into the plastic bag and discard it according to local regulations.
- 5 Reinstall the toner cartridge into the new drum unit. (See *Replacing the toner cartridge* on page 22-27.)
- 6 Reinstall the new drum unit, keeping the front cover *open*.
- 7 Press **Clear/Back**.
- 8 Press **1** and when the LCD shows *Accepted*, and close the front cover.



! Caution

If toner scatters and your hands or clothes get dirty, immediately wipe off or wash with cold water.

Checking the drum life

You can see the percentage of the drum's life that remains available.

- 1 Press **Menu, 2, 0, 2.**
- 2 For five seconds, the LCD shows the available percentage of drum life.

20.Miscellaneous
2.Drum Life
Remaining:100%



Even if the remaining drum life is 0%, you may continue to use the drum unit until you have a print quality problem.

Page Counter

You can see number of total pages, copy pages, print pages and List/Fax (total fax print + total list print) pages that your MFC has printed.

- 1 Press **Menu, 2, 0, 3.**
- 2 The LCD shows number of pages for **Total** and **Copy**.
Press  to see **Print** and **List/Fax**.
- 3 Press **Stop/Exit**.

20.Miscellaneous
3.Page Counter
▲ Total :123456
▼ Copy :120002

23 Optional accessories

Memory board

The memory board is installed on the main controller board inside the MFC. When you add the optional memory board, it increases the performance for both copier and printer operations.

Model Name	Optional Memory
MFC-8420 (32 MB Standard Memory)	32MB TECHWORKS 12457-0001
MFC-8820D (32 MB Standard Memory)	64MB TECHWORKS 12458-0001
	128MB TECHWORKS 12459-0001

In general, the DIMM must have the following specifications:

Type: 100 pin and 32 bit output

CAS Lantency: 2 or 3

Clock Frequency: 100MHz or more

Capacity: 32, 64, 128MB

Height: 35mm or less

Parity: NONE

DRAM Type: SDRAM 4 Bank

Some DIMMs might not work with this MFC. For the latest information from Brother visit:

<http://solutions.brother.com>

Installing the optional memory board

⚠ WARNING

- DO NOT touch the surface of the main board within 15 minutes after turning off the power.
 - Before installing the optional memory board, make sure there are no faxes in the memory.
- 1 Disconnect the telephone line cord, turn the MFC power switch off, unplug the MFC power cord from the AC outlet, and then disconnect the interface cable.

⚠ WARNING

Turn the MFC power switch off, before installing (or removing) the memory board.

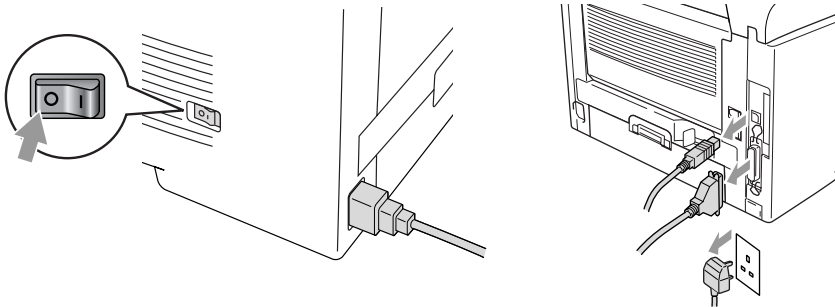

- 2 Remove the side cover. Loosen the two screws, and then remove the metal shield plate.

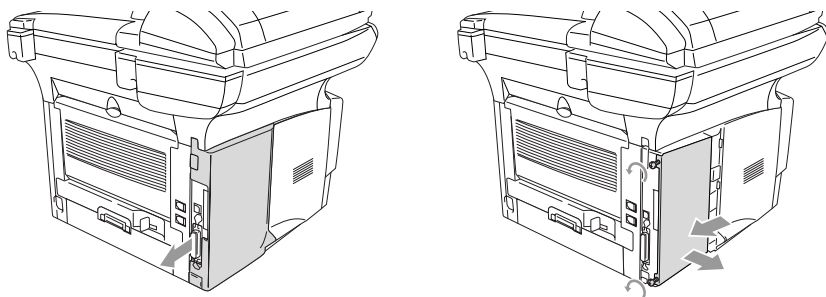

- 3 Unpack the DIMM and hold it by the edges.

⚠ WARNING

DIMM boards can be damaged by even a small amount of static electricity. Do not touch the memory chips or the board surface. Wear an antistatic wrist strap when you install or remove the board. If you do not have an antistatic wrist strap, frequently touch the bare metal on the printer.

- 4 Hold the DIMM with your fingers on the side edges and your thumb on the back edge. Line up the notches on the DIMM with the DIMM slot. (Check that the locks on each side of the DIMM slot are open or facing outwards.)

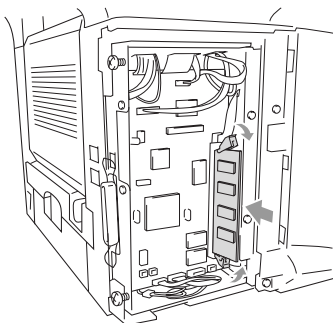

- 5 Press the DIMM straight into the slot (press firmly). Make sure the locks on each side of the DIMM click into place. (To remove a DIMM, you must release the locks.)
- 6 Put the metal plate back on and secure the metal plate with the two screws.
- 7 Put the side cover back on.
- 8 Reconnect the telephone line cord.
- 9 Reconnect any additional interface cables that you removed.
- 10 Reconnect the power cable and then turn on the MFC power switch.



- To check that you have installed the DIMM correctly, print the printer settings by using the selection in the driver and check the printout to make sure it shows the additional memory.
- You can check the current memory size in the user setting list. (See the *NC-9100h Network User's Guide* on the CD-ROM.)

 WARNING

If the Status LED turns Red for a Service Error, please call your dealer or Brother authorized service center.

Network (LAN) board

When you add the optional Network (LAN) Board (NC-9100h), you can connect your MFC into the network to use the Internet FAX, Network Scanner, Network Printer and Network Management operations.

WARNING

DO NOT touch the surface of the main board within 15 minutes after turning off the power.

For more details about how to configure the Network board, please see the NC-9100h Network User's Guide on the CD-ROM supplied with the MFC.

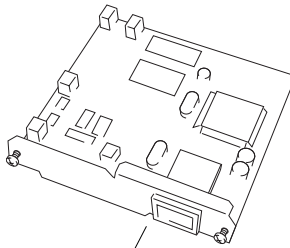

NC-9100h
Print/Fax Server

Before starting installation

Be careful when handling the NC-9100h. There are many delicate electronic components that are susceptible to damage from static electricity. To avoid such damage, use the following precautions when handling the board.

- Leave the NC-9100h in its anti-static bag until you are ready to install it.
- Make sure that you are adequately grounded before touching the NC-9100h. Use an anti-static wrist strap and a grounding mat if possible. If you do not have an anti-static wrist strap, touch the bare metal surface on the back of the machine before handling the NC-9100h.
- Avoid moving around the work area in order to eliminate static charge build-up.
- If possible, do not work on a carpeted area.
- Do not flex the board and do not touch the components on the card.

Tools Required:

Phillips Screwdriver 

Step 1: Hardware installation

WARNING

DO NOT touch the surface of the main boards within 15 minutes after turning off the power.

- 1 Disconnect the telephone line cord, turn the MFC power switch off, unplug the MFC power cord from the AC outlet, and then disconnect the interface cable.

⚠ WARNING

Turn the MFC power switch off, before installing (or removing) the NC-9100h board.

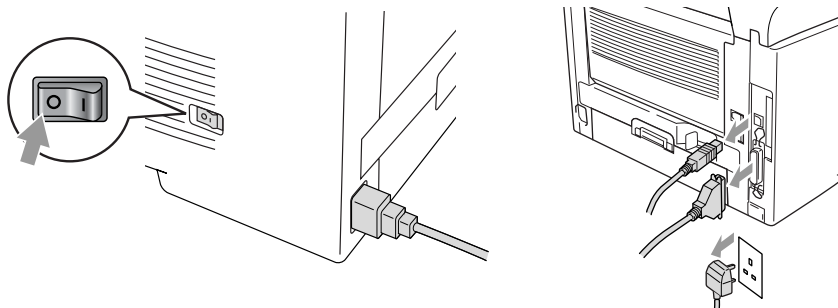

- 2** Remove the side cover. Loosen the two screws, and then remove the metal shield plate.

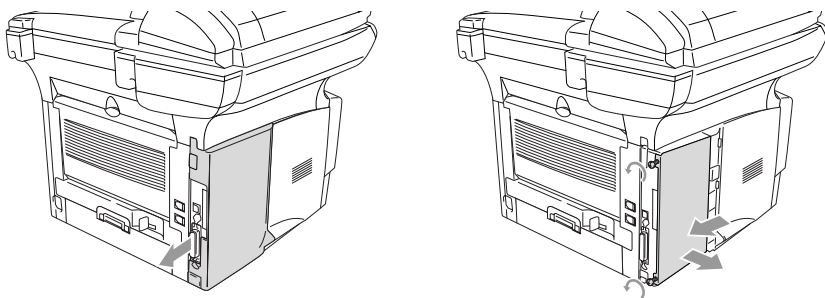

- 3** Loosen the two screws, and then remove the metal cover plate.

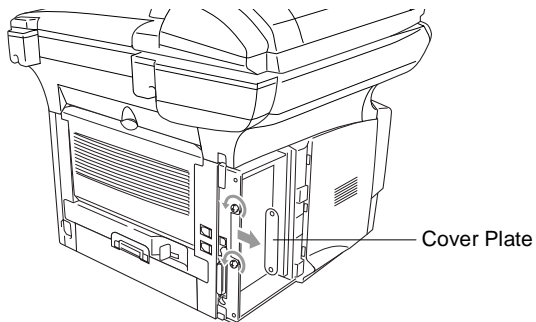

- 4 Plug the NC-9100h into connector P1 located on the main board as shown in the illustration (press firmly) and secure the NC-9100h with the two screws.

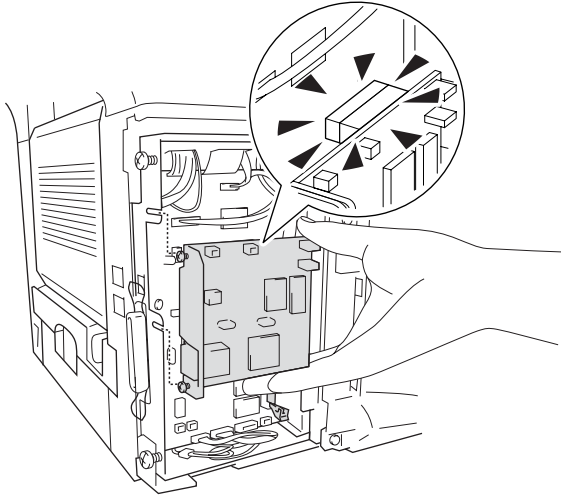

- 5 Put the metal shield plate back on and secure it with the two screws.
- 6 Put the side cover back on.
- 7 Reconnect the telephone line cord.
- 8 Reconnect any additional interface cables that you removed.
- 9 Reconnect the power cable and then turn on the MFC power switch.
- 10 Press the Test switch and print a network configuration page. (See *TEST SWITCH* on page 23-10.)

Step 2: Connecting the NC-9100h to an Unshielded Twisted Pair 10BASE-T or 100BASE-TX Ethernet Network

To connect the NC-9100h to a 10BASE-T or 100BASE-TX Network, you must have an Unshielded Twist Pair Cable. One side of the cable must be connected to a free port on your Ethernet hub and the other side must be connected to the 10BASE-T or 100BASE-TX connector (an RJ45 Connector) of the NC-9100h.

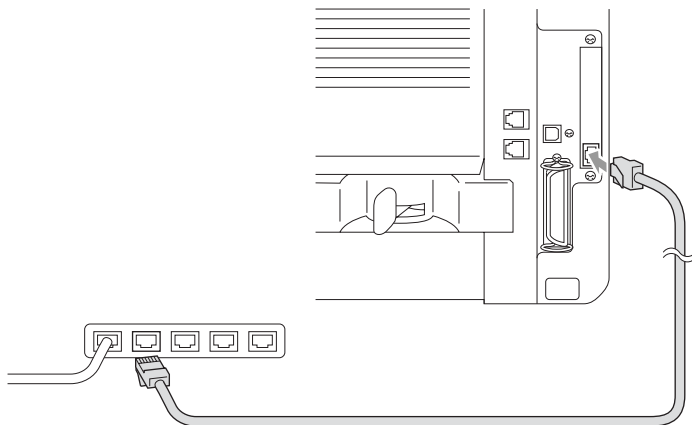

Verifying successful hardware Installation:

Plug in the AC power cord. After initialization and warm-up (this may take several seconds), the machine will come to a Ready state.

LED

No light:

If both of the two LEDs are off, then the print server is not connected to the network.

Link/Speed LED is orange: Fast Ethernet

This Link/Speed LED will be orange if the print server is connected to a 100BASETX Fast Ethernet network.

Link/Speed LED is green: 10 BASE T Ethernet

This Link/Speed LED will be green if the print server is connected to a 10 BASE T Ethernet.

Active LED is yellow:

The Active LED will blink if the print server is receiving or transmitting data.

 If there is a valid connection to the network, the LED will blink orange or green.

TEST SWITCH

Short push: Prints the network configuration page.

Long push (more than 5 seconds): Reset the network configuration back to the factory default settings.

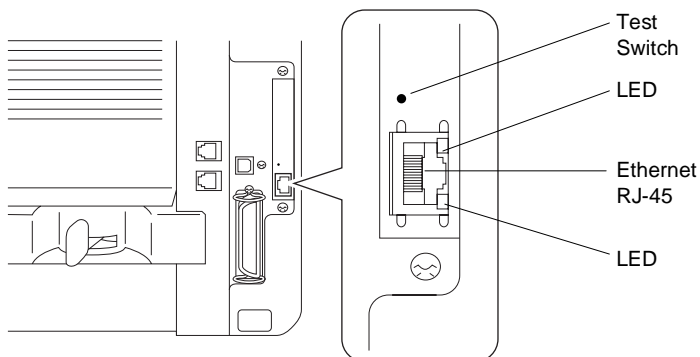

 To set up the MFC on the Network, see the *NC-9100h Network User's Guide* on the CD-ROM.

Paper Tray #2

You can purchase the Paper Tray #2 accessory (LT-5000) to use as a third paper source. Tray #2 holds up to 250 sheets of 80 gsm paper.

Paper Tray #2	Holds approx. 250 sheets of 80 gsm
Basis Weight	60 to 105 gsm
Moisture Content	4% to 6% by weight
We Recommend:	Xerox 4200 DP 80 gsm
Cut sheet:	Hammermill Laser Paper 90 gsm

G Glossary

ADF (Automatic Document Feeder) The document can be placed in the ADF and scanned one page at a time automatically.

Auto Reduction Reduces the size of incoming faxes.

Automatic fax transmission Sending a fax without picking up the handset of an external phone.

Automatic Redial A feature that enables your MFC to redial the last fax number if the fax did not go through because the line was busy.

Batch Transmission As a cost savings feature, all delayed faxes to the same fax number will be sent as one transmission.

Beeper The sound the keys make when they are pressed, an error occurs, or a fax has been received or sent.

Beeper volume Volume setting for the beep when you press a key or make an error.

Broadcasting The ability to send the same fax message to more than one location.

Caller ID A service purchased from the Telephone Company that lets you see the number (or name) of the party calling you.

CNG tones The special tones (beeps) sent by fax machines during automatic transmission to tell the receiving machine that they are from a fax machine.

Coding Method Method of coding the information contained in the document. All fax machines must use a minimum standard of Modified Huffman (MH). Your MFC is capable of greater compression methods, Modified Read (MR), Modified Modified Read (MMR) and JBIG, if the receiving machine has the same capability.

Communication error (or Comm. Error) An error during fax sending or receiving, usually caused by line noise or static.

Compatibility Group The ability of one fax unit to communicate with another. Compatibility is assured between ITU-T Groups.

Contrast Setting to compensate for dark or light documents, by making faxes or copies of dark documents lighter and light documents darker.

Cover Page Prints a page at the other party's fax machine that contains the sender and recipient's name and fax number, number of pages and comment. You can generate an electronic cover page at the other end with pre-programmed information from memory or you can print a sample cover page to fax with your document.

Cover Page Message The comment that is on the Cover Page. This is a programmable feature.

Deactivation Code (Fax/Tel mode) When the MFC answers a voice call, it pseudo/double-rings. You can pick up at an extension phone by pressing this code **#51** (**#91** for New Zealand).

Delayed Fax Sends your fax at a later time that day.

Distinctive Ring A service purchased from the Telephone Company that provides another phone number on an existing phone line. The Brother fax machine uses the new number to simulate a dedicated fax line.

Drum Unit A printing device for the MFC.

Dual Access Your MFC can scan outgoing faxes or scheduled jobs into memory at the same time it is sending a fax or receiving or printing an incoming fax.

ECM (Error Correction Mode) Detects errors during fax transmission and resends the pages of the fax that had an error.

Extension phone A telephone on the fax number that is plugged into a separate wall socket.

External phone A TAD (telephone answering device) or telephone that is plugged into the correct socket on the MFC.

F/T Ring Time The length of time that the Brother MFC rings (when the Receive Mode setting is Fax/Tel) to notify you to pick up a voice call that it answered.

FaxAbility A service purchased from the Telephone Company that provides another phone number on an existing phone line. The Brother fax machine uses the new number to simulate a dedicated fax line.

Fax Detect Enables your MFC to respond to CNG tones if you interrupt a fax call by answering it.

Fax Forwarding Sends a fax received into the memory to another preprogrammed fax number.

Fax Storage You can print stored faxes later, or retrieve them from another location using Fax Forwarding, or Remote Retrieval operations.

Fax tones The signals sent by sending and receiving fax machines while communicating information.

Fax/Tel You can receive faxes and telephone calls. Do not use this mode if you are using a telephone answering device (TAD).

Fine resolution Resolution is 203 × 196 dpi. It is used for small print and graphs.

Gray scale The shades of gray available for copying and faxing photographs.

Group number A combination of One-Touch, Speed-Dial numbers that are stored as a Speed-Dial number for Broadcasting.

Help list A printout of the complete Menu that you can use to program your MFC when you do not have the User's Guide with you.

Journal Lists information about the last 200 incoming and outgoing faxes. TX means Transmit. RX means Receive.

Journal Period The preprogrammed time period between automatically printed Journal Reports. You can print Journal on demand without interrupting this cycle.

LCD (liquid crystal display) The display screen on the MFC that shows interactive messages during On-Screen Programming and shows the date and time when the MFC is idle.

Manual fax When you lift the handset of your external telephone or press **Hook** so you can hear the receiving fax machine answer before you press Start to begin transmission.

Menu mode Programming mode for changing your MFC's settings.

MFL-Pro Suite Turns your MFC into a printer and a scanner and enables PC faxing using the MFC.

OCR (optical character recognition) The bundled ScanSoft® TextBridge® software application converts an image of text to text you can edit.

One-Touch Keys on the MFC control panel where you can store numbers for easy dialing. You can store a second number on each key if you press **Shift** and the One-Touch Key together.

Out of Paper Reception Receives faxes into the MFC's memory when the machine is out of paper.

Overseas Mode Makes temporary changes to the fax tones to accommodate noise and static on overseas phone lines.

Pause Allows you to place a 3.5 second delay in the dialing sequence stored on Speed-Dial numbers. Press **Redial/Pause** as many times as needed for longer pauses.

Photo resolution A resolution setting that uses varying shades of gray for the best representation of photographs.

Polling The process of a fax machine calling another fax machine to retrieve waiting fax messages.

Pulse A form of rotary dialing on a telephone line.

Quick Dial List A listing of names and numbers stored in Speed-Dial memory, in numerical order.

Real Time Transmission When memory is full, you can send faxes in real time.

Remaining jobs You can check which jobs are waiting in memory and cancel jobs individually.

Remote Access Code Your own four-digit code that allows you to call and access your MFC from a remote location.

Remote Activation Code Press this code ***51** (***91** for New Zealand) when you answer a fax call from an extension or external phone to transfer the call to the MFC.

Remote Retrieval Access The ability to access your MFC remotely from a touch tone phone.

Resolution The number of vertical and horizontal lines per inch. See: Standard, Fine, Super Fine and Photo.

Ring Delay The number of rings before the MFC answers in FAX mode.

Ring Volume Volume setting for the MFC's ring.

Scanning The process of sending an electronic image of a paper document into your computer.

Search An electronic, alphabetical listing of stored One-Touch, Speed-Dial and Group numbers.

Speed-Dial A preprogrammed number for easy dialing. You must press the **Search/Speed Dial** key and then **#**, and the three digit code to start the dialing process.

Standard resolution 203 x 97 dpi. It is used for regular size text and quickest transmission.

Station ID The stored information that appears on the top of faxed pages. It includes the sender's name and fax number.

Super fine resolution 203 x 391 dpi. Best for very small print and line art.

System Setup List A printed report that shows the current settings of the MFC.

TAD (telephone answering device) You can connect an external TAD to the EXT. socket of the MFC.

Temporary Settings You can select certain options for each fax transmission and copy without changing the default settings.

Tone A form of dialing on the telephone line used for Touch Tone telephones.

Toner cartridge An accessory that holds toner for the drum unit on Brother laser models.

Toner Save A process that causes less toner to be affixed to the page to extend the life of the toner assembly. This will make the receiving document significantly lighter.

Transmission The process of sending faxes over the phone lines from your MFC to the receiving fax machine.

True Type fonts The fonts that are used in the Windows® operating systems. If you install the Brother True Type fonts, more types of fonts will be available for Windows® applications.

Xmit Report (Transmission Verification Report) A listing for each transmission, that shows its date, time and number.

S

Specifications

Product description

The MFC-8420 and MFC-8820D are **5 in 1** Multi-Function Centers: Printer, Copier, Color Scanner, Fax, and PC Fax (via your PC). The MFC-8820D includes Duplex Printing.

General

Memory Capacity	32 MB
Optional Memory	1 DIMM slot; Memory expandable up to 160 MB
Automatic Document Feeder (ADF)	Up to 50 pages Temperature: 20°C - 30°C Humidity: 50% - 70% Paper: 75 gsm A4 size
Paper Tray	250 Sheets (80 gsm)
Multi-Purpose Tray	50 Sheets (80 gsm) (MFC-8820D only)
Manual Feed Tray	Single sheet (80 gsm) (MFC-8420 only)
Printer Type	Laser
Print Method	Electrophotography by semiconductor laser beam scanning
LCD (Liquid Crystal Display)	22 characters × 5 lines
Warm-up	Max. 18 seconds at 23°C
Power Source	220 - 240V AC 50/60Hz
Power Consumption	Average Operating (Copying): 440W or less (25°C) Peak: 1090W or less Sleep: 14W or less 16W or less (When Network LAN board (NC-9100h) is installed.) Standby: 75W or less (25°C)
Dimensions	532 × 444 × 469 (mm)
Weight	Without Drum/Toner Unit: MFC-8420: 16.6 kg MFC-8820D: 18.1 kg
Noise	Operating: 53 dB A or less Standby: 30 dB A or less

General (continued)

Temperature	Operating: 10 - 32.5°C
	Storage: 0 - 40°C
Humidity	Operating: 20 to 80% (without condensation)
	Storage: 10 to 90% (without condensation)

Print media

Paper Input

Paper Tray

- Paper type:
Plain paper, recycled paper and transparencies, envelopes (Manual Feed/Multi-purpose Tray)
- Paper size:
A4, Letter, Legal, B5 (ISO), B5 (JIS), Executive, A5, A6, B6 (ISO)
Weight: 60 - 105 gsm (Paper Tray)
For more details, see *Paper specifications for each paper tray* on page 2-4.
- Maximum paper tray capacity: Approx. 250 sheets of 80 gsm plain paper
- Maximum multi-purpose tray capacity: Approx. 50 sheets of 80 gsm plain paper (MFC-8820D only)

Manual Feed Tray/Multi-Purpose Tray

- Paper size:
Width: 69.8 - 220.0 mm
Height: 116.0 - 406.4 mm
Weight: 60 - 161 gsm

Paper Output

Up to 150 sheets of plain paper (Face down print delivery to the output paper support)

Copy

Color/Monochrome

Monochrome

Copy Speed

Up to 16 copies/minute (A4 paper)

Multiple Copies

Stacks or Sorts up to 99 pages

Enlarge/Reduce

25% to 400% (in increments of 1%)

Resolution

Max. 1200 x 600 dpi

Fax

Compatibility	ITU-T Group 3
Coding System	MH/MR/MMR/JBIG
Modem Speed	33600-2400 bps Automatic Fallback
Document Size	ADF Width: 148 mm to 216 mm ADF Height: 148 mm to 356 mm Scanner Width: Max. 212 mm Scanner Height: Max. 356 mm
Scanning Width	208 mm
Printing Width	208 mm
Gray Scale	64 levels
Polling Types	Standard, Secure, Timer, Sequential
Contrast Control	Automatic/Light/Dark (manual setting)
Resolution	<ul style="list-style-type: none">• Horizontal 8 dot/mm• Vertical<ul style="list-style-type: none">• Standard 3.85 line/mm• Fine, Photo 7.7 line/mm• Superfine 15.4 line/mm
One-Touch Dial	40 (20 × 2)
Speed-Dial	300 stations
Automatic Redial	3 times at 5 minute intervals
Auto Answer	2, 3, 4, 5, 6, 7, 8, 9 or 10 rings (for Australia) 1, 2, 3, 4, 5, 6, 7, 8, 9 or 10 rings (for New Zealand) 0, 1, 2, 3, 4, 5, 6, 7, 8, 9 or 10 rings (for some countries)
Communication Source	Public switched telephone network.
Memory Transmission	Up to 600* ¹ /500* ² pages
Out of Paper Reception	Up to 600* ¹ /500* ² pages

*1 "Pages" refers to the "Brother Standard Chart No. 1" (a typical business letter, Standard resolution, JBIG code). Specifications and printed materials are subject to change without prior notice.

*2 "Pages" refers to the "ITU-T Test Chart #1" (a typical business letter, Standard resolution, JBIG code). Specifications and printed materials are subject to change without prior notice.

Scanner

Color/Monochrome

Color/Monochrome

TWAIN Compliant

Yes (Windows® 95/98/98SE/Me/2000 Professional and Windows NT® Workstation Version 4.0)

Mac OS 8.6-9.2/OS X 10.2.1 or greater

WIA Compliant

Yes (Windows® XP)

Resolution

Up to 9,600 × 9,600 dpi (interpolated)*

Up to 600 × 2,400 dpi (optical)

* Maximum 1200 x 1200 dpi scanning with Windows® XP (resolution up to 9600 x 9600 dpi can be selected by using the Brother scanner utility)

Document Size

ADF Width: 148 mm to 216 mm

ADF Height: 148 mm to 356 mm

Scanner Glass Width: Max. 216 mm

Scanner Glass Height: Max. 356 mm

Scanning Width

212 mm

Gray Scale

256 levels



Scanning directly to a networked PC is available with Windows® 98/98SE/Me/2000 Professional and XP.



OS X scanning is supported in OS X 10.2.1 or greater.

Printer

Emulation	PCL6 (Brother Printing System for Windows® emulation mode of HP LaserJet) and BR-Script (PostScript®) Level 3
Printer Driver	Windows® 95/98/98SE/Me/2000 Professional/XP and Windows NT® Workstation Version 4.0 driver supporting Brother Native Compression mode and bi-directional capability Apple® Macintosh® QuickDraw® Driver and PostScript (PPD) for OS 8.6-9.2/OS X 10.1/10.2.1 or Greater
Resolution	HQ1200 (Max. 2400 × 600 dots/inch)
Print Quality	Normal printing mode Economy printing mode (saves toner usage)
Print Speed	Up to 16 pages/minute A4 size (when loading paper from paper tray)
Duplex Printing	Up to 8.5 pages/minute: (MFC-8820D only) (8.5 sides per minute, 4.25 sheets per minute)
First Print	Up to 12 seconds (using A4 size paper in paper tray)

Interfaces

Interface	Recommended Cable
Parallel	A bi-directional shielded parallel cable that is IEEE 1284 compliant and not longer than 2 m.
USB	A Hi-Speed USB 2.0 cable that is not longer than 2 m.



Please make sure that you use a Hi-Speed USB 2.0 certified cable if your computer uses a Hi-Speed USB 2.0 interface.



Even if your computer has a USB 1.1 interface you can connect the MFC.

Computer requirements

Minimum System Requirements						
Computer Platform & Operating System Version		Processor Minimum Speed	Minimum RAM	Recommended RAM	Available Hard Disk Space	
					Driver	Application Software ^{*1}
Windows® Operating System	95, 98, 98SE	Pentium 75MHz	24 MB	32 MB	80 MB	100 MB
	Me	Pentium 150 MHz	32 MB	64 MB		
	NT® Workstation 4.0	Pentium 75MHz				
	2000 Professional	Pentium 133MHz	64 MB	128 MB		
	XP	Pentium 233MHz			180 MB	
Apple® Macintosh® Operating System	Mac OS® 8.6 - 9.2 (Printing, Scanning and PC-FAX Send Only)	All base models meet minimum Requirements	32 MB	64 MB	50 MB	200 MB
	Mac OS® X 10.1/10.2.1 or greater (Printing, Scanning ^{*2} , PC-FAX Send and Remote Setup Only)		128 MB	160 MB		
<p>NOTE: USB is not supported under Windows® 95 or Windows NT® WS 4.0. All registered trademarks referenced herein are the property of their respective companies.</p>						
<p>For the latest drivers, go to the Brother Solutions Center at http://solutions.brother.com/</p>						



*1 Application Software is different for Windows® and Macintosh®

*2 Scanning is supported in 10.2.1 or greater.

Consumable items

Toner Cartridge Life Expectancy

TN-7300: Standard Toner Cartridge - Up to 3,300* pages

TN-7600: High Yield Toner Cartridge - Up to 6,500* pages

*(when printing letter size or A4 paper at 5% print coverage)



Toner life expectancy will vary depending upon the type of average print job.

Drum Unit Life Expectancy

Up to 20,000 pages/drum unit (DR-7000)



There are many factors that determine the actual drum life, such as temperature, humidity, type of paper, toner you use and number of pages per print job.

Network (LAN) board (NC-9100h)

MFC-8420 (Option) MFC-8820D (Option)

When you add the optional Network (LAN) Board (NC-9100h), you can connect your MFC into the network to use the Internet FAX, Network Scanner, Network Printer and Network Management software.



SMTP/POP3 E-mail Services are required for Internet Fax.

Support for:

Windows® 95/98/Me/NT® 4.0/2000/XP
Novell NetWare 3.X, 4.X, 5.X
Mac OS 8.6 - 9.2, X 10.0-10.2.1 or Greater
Ethernet 10/100 BASE-TX Auto Negotiation
TCP/IP, IPX/SPX, AppleTalk, DLC/LLC
RARP, BOOTP, DHCP, APIPA, NetBIOS, WINS
LPR/LPD, Port9100, SMTP/POP3
SMB(NetBIOS/IP), IPP, SSDP, Rendezvous, FTP
MIBII as well as Brother private MIB
TELNET, SNMP, HTTP, TFTP

Included Utilities:

BRAdmin Professional and Web Based Management



- Scanning directly to a networked PC is not supported in Windows® 95, NT® and Mac OS.
- BRAdmin Professional is not supported in Mac OS.

Index

A

- Access codes, storing and dialing 7-9
- ADF (Automatic Document Feeder) 6-1
- ADF cover 22-5
- Automatic
 - fax receive 5-1
 - fax redial 6-9
 - transmission 6-6

B

- Broadcasting 6-17
 - setting up Groups for 7-5
- Brother Control Center
 - using and configuring 14-1

C

- Canceling
 - fax forwarding 8-5
 - fax jobs in memory 6-12
 - jobs awaiting redial 6-13
- Cleaning (routine maintenance)
 - drum unit 22-26
 - printer 22-25
 - scanner 22-24
- CNG tones 1-12
- Combine items into single file, if possible 14-11
- Connecting
 - external TAD 1-15
 - external telephone 1-14
- Control panel, overview 1-5
- Copy
 - contrast 10-20
 - default settings, changing 10-20

- Duplex/N in 1 10-12
 - Enlarge/Reduce 10-7
 - enter Copy mode 10-1
 - keys 10-6
 - multiple 10-4
 - paper 2-1
 - Quality (type of document)
 - 10-9
 - scanner glass 10-4
 - single 10-3, 10-4
 - Sort (ADF only) 10-9
 - temporary settings
 - 10-2, 10-6
 - Tray Select 10-11
 - tray use 4-12
 - using ADF 10-3
- Cover page
- composing 6-14
 - custom comments 6-15
 - for all faxes 6-16
 - for next fax only 6-15
 - printed form 6-17
- Credit Card Numbers 7-9
- Custom telephone features
..... 1-17

D

- Date and Time 4-1
- Delayed Batch Transmission
..... 6-21
- Delayed Fax 6-20
- Dialing
 - a pause 7-10
 - access codes and credit card numbers 7-9
 - automatic fax redial 6-9
 - Groups 6-17

- Search7-7
- Speed Dial numbers7-8
- Drivers
 - printer 12-1
 - TWAIN Compliant 13-1
 - Windows®
 - printer 11-1
- Drum unit
 - checking remaining life
 -22-35
 - replacing22-32
- Dual Access6-10
- Duplex/N in 1 key 10-12
 - Duplex/1 in 1 10-17
 - Duplex/2 in 1 10-19
 - Duplex/4 in 1 10-19

E

- ECM (Error Correction Mode)
 - 1-13
- Ecology
 - Scanner lamp4-10
 - Sleep Time4-10
- Entering text4-3
- Envelopes2-3
- Error messages on LCD22-1
 - Check Paper22-1
 - Comm. Error22-2
 - Not Registered22-3
 - Out of Memory22-3
 - while scanning a document
 - 10-5
- Extension telephone, using
 -5-8
- External telephone 1-14

F

- Fax codes
 - Remote Access Code8-3
 - Remote Activation Code5-8

- Remote Deactivation Code
 -5-8
- Fax Detect5-4
- Fax Forwarding
 - changing remotely 8-5, 8-6
- Fax Storage8-2
 - printing from5-7
 - turning on8-2
- Fax, stand-alone
 - receiving5-1
 - difficulty22-12
 - duplex printing5-13
 - forwarding8-5
 - reducing to fit on paper5-5
 - retrieving from a remote
 - site8-6
 - ring delay, setting5-2
 - sending
 - at end of conversation6-6
 - automatic transmission6-6
 - canceling from memory
 -6-13
 - contrast6-8
 - delayed6-20
 - from ADF6-1
 - from memory
 - (dual access)6-10
 - from scanner glass6-3
 - legal size from scanner glass
 -6-5
 - manual transmission6-5
 - overseas6-19
- Real Time Transmission
 -6-11
 - resolution6-9
- Fax/Tel mode5-1
 - answering at extension
 - phones5-8
 - double-ringing (voice calls)
 -5-3

receiving faxes 5-8
Remote Activation Code ... 5-8
Remote Deactivation Code
..... 5-8
Setting F/T Ring Time 5-3
Setting Ring Delay 5-2

G

Gray scale S-3, S-4
Groups for Broadcasting 7-5

H

HELP 3-1
Help List 9-3

J

Jams
document 22-5
paper 22-6

L

LAN Configuration 3-13, 3-14
LCD (Liquid Crystal Display)
..... 1-5, 9-3
LCD Contrast 4-13

M

Maintenance, routine 22-24
Manual
receive 5-1
transmission 6-5
Manual feed tray 11-5, 11-8
Memory Security 6-23
Memory Storage 3-1
Menu table 3-1
Multi-purpose tray (MP tray)
..... 2-1

O

OCR, changing setting 15-11
One Touch numbers
storing 7-1

P

Page Counter 22-35
Paper S-2
capacity 2-3
document size 6-1
jam 22-5
Size 4-7
PaperPort®
accessing 13-2
exporting 13-23
importing 13-23
PC FAX (For Windows®) 17-1
receiving 17-19
sending
address book 17-7
cover page 17-14
facsimile style 17-16
group 17-9
setting up 17-14
simple style 17-17
Phone line
connections 1-16
difficulties 22-12
Power
failure 3-1
Print
area 10-1
difficulty 22-12
driver 12-1
emulation
Windows®
..... 11-1, 11-18, 12-17
Emulation Selection 11-18
envelopes 11-12
fax from memory 5-7

improving the print quality 22-17
 jams 22-6
 manual feed tray 11-5
 multi-purpose tray 11-6
 on thick paper 11-8
 reports and lists 11-19
 resolution S-5
 Secure key 11-17
 specifications S-5
 two-sided (duplex printing)
 11-3
 Print media 2-1
 Printer driver 12-17
 PS printer driver 12-17

Q

Quality key (copying) 10-6

R

Receive mode
 External TAD 5-1
 Fax Only 5-1
 Fax/Tel 5-1
 Manual 5-1
 Redial/Pause 1-7, 6-9
 Reducing
 copies 10-7
 Incomig faxes 5-5
 Remote Retrieval 8-4
 access code 8-3, 8-4
 commands 8-5
 getting your faxes 8-6
 Reports 9-1
 Transmission Verification
 9-1
 Resolution
 fax (standard, Fine,
 superFine, Photo) S-3
 print S-5

Scan 13-6, S-4
 setting for next fax 6-9
 Ring Delay, setting 5-2

S

Safety Instructions ii
 Scanner Lamp 4-10
 Scanner Lock 22-21
 Scanning into PC 13-3
 ScanSoft® PaperPort® ... 13-19
 Scansoft® TextBridge®
 OCR 13-22
 Search, for stored numbers ... 7-7
 Setup
 Date and Time 4-1
 Station ID (fax header) 4-2
 Shipping the machine 22-21
 Sockets
 EXT. socket
 external telephone 1-14
 TAD (answering machine)
 1-15
 Software
 Brother Control Center 14-1
 ScanSoft® Paper Port® ... 13-19
 Speed Dial 1-5
 dialing 7-8
 storing 7-1

T

TAD (Telephone Answering
 Device), external 1-15, 5-1
 connecting 1-14
 Receive Mode 5-1
 Telstra® FaxStream® Duet
 5-14
 Temporary Copy Settings
 10-6
 Text, entering 4-3
 Special Characters 4-4

- To change the default setting of the scan, click on the Scan Settings tab 15-9
- Tone signals on Pulse line 7-10
- Toner cartridge replacing 22-27
- Tray use, setting
 - copy 4-12
 - fax 4-13
- Troubleshooting 22-1
 - error messages on LCD 22-1
 - if you are having difficulty
 - incoming calls 22-13
 - paper handling 22-15
 - phone line difficulties .. 22-12
 - printer difficulties 22-14
 - printing or receiving faxes 22-12

V

- Volume, setting 4-8
 - beeper 4-8
 - ring 4-8
 - speaker 4-9

Remote Retrieval Access card

If you plan to receive fax messages while away from your MFC, carrying the Remote Retrieval Access Card printed below will serve as a convenient reminder of the retrieval procedures. Simply cut out the card and fold it to fit your wallet or organizer. Keeping it handy will help you derive the full benefit of your MFC's Forwarding and Remote Retrieval features.

REMOTE RETRIEVAL ACCESS CARD	
CHECK RECEIVING STATUS Press 971 1 long beep — Fax messages 3 short beeps — No messages	Using Remote Access Code 1 Dial your fax number from a telephone or fax machine using touch tone. 2 When your MFC answers, immediately enter your Remote Access Code (3 digits followed by *). 3 Your MFC signals the kinds of messages it received: 1 long beep — Fax messages No beeps — No messages. 4 After 2 short beeps, enter a command. 5 Press 90 to reset your MFC when you finish. 6 Hang up.
CHANGE RECEIVE MODE Press 98 then/for External TAD, press 1. Fax/Tel, press 2. Fax Only, press 3.	
EXIT REMOTE OPERATION Press 90 .	

Changing Remote Access Code

When you are at the machine:

- 1 Press **Menu 2, 5, 3.**
- 2 Enter a three-digit number from 000 to 999.
The * cannot be changed.
- 3 Press **Set.**
- 4 Press **Stop/Exit.**

Remote Commands

CHANGE FAX FORWARDING SETTING

Press **95.**

Then to Turn feature **Off**, press **1.**

Select Fax Forwarding, press **2.**

Fold

Program Fax Forwarding Number, press **4.** Enter the new fax number where you want your fax messages forwarded followed by **##.**

Turn Fax Storage On, press **6.**

Turn Fax Storage Off, press **7.**

RETRIEVE A FAX

Press **96.**

Then to

Retrieve all faxes, press **2.**

then enter the number of remote fax machine followed by **##.**

After the beep, hang up and wait.

Erase all fax messages, press **3.**

Fold



This machine is approved for use in the country of purchase only, local Brother companies or their dealers will only support machines purchased in their own countries.

Free Manuals Download Website

<http://myh66.com>

<http://usermanuals.us>

<http://www.somanuals.com>

<http://www.4manuals.cc>

<http://www.manual-lib.com>

<http://www.404manual.com>

<http://www.luxmanual.com>

<http://aubethermostatmanual.com>

Golf course search by state

<http://golfingnear.com>

Email search by domain

<http://emailbydomain.com>

Auto manuals search

<http://auto.somanuals.com>

TV manuals search

<http://tv.somanuals.com>