

Online User's Guide

PJ-722
PJ-723
PJ-762
PJ-763
PJ-763MFi
PJ-773

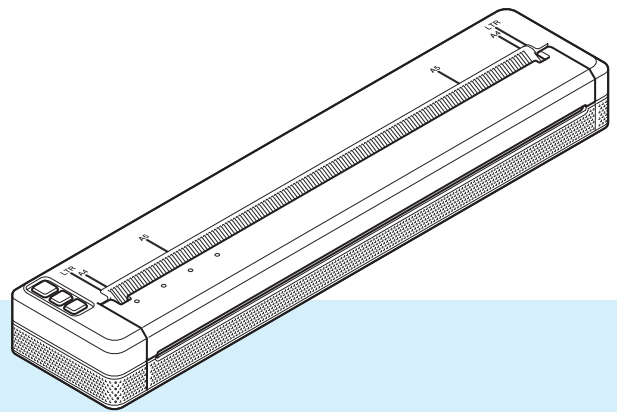

Before using this printer, make sure you read this *Online User's Guide*.
We recommend that you keep this document nearby for future reference.

Introduction

Important Notice

- The contents of this document and the specifications of this product are subject to change without notice.
- Brother reserves the right to make changes without notice in the specifications and materials contained herein and shall not be responsible for any damages (including consequential) caused by reliance on the materials presented, including but not limited to typographical and other errors relating to the publications.
- Screen images in this document may differ depending on your computer's operating system.
- Before using the printer, make sure you read all documents included with the printer for information about safety and proper operation.
- The printer shown in the illustrations may be different from your printer.

Available Manuals

You can download the latest manuals from the Brother support website at support.brother.com.





Product Safety Guide ¹	This guide provides safety information; read it before you use the printer.
User's Guide ¹	This guide provides basic information about using the printer along with detailed troubleshooting tips.
Online User's Guide ²	This guide includes the contents of the <i>User's Guide</i> , and additional information about the printer settings and operations, network connection and settings, troubleshooting tips, and maintenance instructions.
AirPrint Guide ²	This guide provides information for using AirPrint to print from a Mac or iOS device.
Google Cloud Print Guide ²	This guide provides details on how to use Google Cloud Print™ services for printing over the Internet.
Mobile Print/Scan Guide for Brother iPrint&Scan ²	This guide provides useful information about printing from your mobile device when the printer and the device are connected using Bluetooth or Wi-Fi®.
P-touch Template Manual ²	This manual provides information on P-touch Template.
Raster Command Reference ²	This manual provides information about printer control commands for controlling the printer directly.

¹ Printed manual in the box

² PDF manual on the Brother support website

Symbols Used in This Guide

The following symbols are used throughout this guide:

 WARNING	Tells you what to do to avoid the risk of injury.
 CAUTION	Tells you about procedures you must follow to avoid minor personal injury or damage to the printer.
 Important	Indicates information or directions that should be followed. Ignoring them may result in damage, or failed operations.
 Note	Indicates notes that provide information or directions that can help you better understand and use the product more efficiently.

IMPORTANT NOTE

- This product is approved for use in the country of purchase only. Do not use this product outside the country of purchase as it may violate the wireless telecommunication and power regulations of that country.
- Windows Vista in this document represents all editions of Windows Vista.
- Windows 7 in this document represents all editions of Windows 7.
- Windows 8 in this document represents all editions of Windows 8.
- Windows 8.1 in this document represents all editions of Windows 8.1.
- Windows 10 in this document represents Windows 10 Home, Windows 10 Pro, Windows 10 Enterprise, and Windows 10 Education.
Windows 10 in this document does not represent Windows 10 Mobile, Windows 10 Mobile Enterprise, or Windows 10 IoT Core.
- Windows Server 2008 in this document represents all editions of Windows Server 2008 and Windows Server 2008 R2.
- Windows Server 2012 in this document represents all editions of Windows Server 2012 and Windows Server 2012 R2.
- Not all models are available in all countries.

Table of Contents

Section I Basic Operations

1	Setting Up the Printer	2
	General Description	2
	LED Indicators	3
	Indicator Warnings.....	7
	Button Functions.....	8
	Use the Rechargeable Li-ion Battery (Optional).....	10
	Installing the Rechargeable Li-ion Battery.....	10
	Removing the Rechargeable Li-ion Battery.....	12
	Charging the Rechargeable Li-ion Battery	12
	Stopping Rechargeable Li-ion Battery Charging	13
	Notes on Using the Rechargeable Li-ion Battery	13
	Rechargeable Li-ion Battery Characteristics	13
	Connect the Printer to External Power	14
	Connecting to an AC Power Outlet (Optional).....	14
	Connecting to a DC Power Outlet (Optional).....	15
	Turning the Printer On or Off	16
	Loading Paper in the Printer	17
	Notes on Using Paper	18
	Install Software to Your Computer or Mobile Device	19
	Available Software.....	19
	Installing the Printer Driver and Software (When Using a Windows PC or Mac)	24
	Connect the Printer to a Computer or Mobile Device	25
	Connecting Using USB.....	25
	Connecting Using Bluetooth (PJ-762/PJ-763/PJ-763MFi Only).....	26
	Connecting Using Wi-Fi (PJ-773 Only).....	27
2	Using the Printer	31
	Printing from a Windows PC or Mac.....	31
	Printing with the Printer Driver.....	31
	Setting Printer Driver Options.....	32
	Settings That Can Be Changed Using the Windows Printer Driver (Examples).....	32
	Settings That Can Be Changed Using the Mac Printer Driver (Examples)	37
	Printing with Google Cloud Print™ (PJ-773 Only).....	39
	Printing with AirPrint (Only When Using PJ-773 with a Mac)	39
	Printing from an iOS Device	40
	Printing with iPrint&Scan (PJ-763MFi/PJ-773 Only).....	40
	Printing with AirPrint (PJ-773 Only).....	41
	Printing with Google Cloud Print™ (PJ-773 Only).....	41
	Printing from an Android™ Device	42
	Printing with iPrint&Scan (PJ-762/PJ-763/PJ-763MFi/PJ-773 Only).....	42
	Printing with Mopria™ (PJ-773 Only).....	43
	Printing with Google Cloud Print™ (PJ-773 Only).....	44

3 Changing the Printer Settings **45**

Printer Setting Tool (for Windows PCs).....	45
Before Using the Printer Setting Tool.....	45
Using the Printer Setting Tool (for Windows PCs).....	46
Communication Settings (PJ-762/PJ-763/PJ-763MFi/PJ-773 Only).....	48
Settings Dialog Box.....	48
Menu Bar.....	50
General Tab.....	53
Bluetooth Tab (PJ-762/PJ-763/PJ-763MFi Only).....	56
Wireless LAN Tab (PJ-773 Only).....	58
Wireless Direct Tab (PJ-773 Only).....	62
Applying Setting Changes to Multiple Printers.....	63
Device Settings.....	64
Settings Dialog Box.....	64
Menu Bar.....	66
Settings Tabs.....	68
Applying Setting Changes to Multiple Printers.....	75
P-touch Template Settings.....	76
P-touch Template.....	76
P-touch Template Settings Dialog Box.....	77
Printer Setting Tool (for Mac Computers).....	79
Before Using the Printer Setting Tool.....	79
Using the Printer Setting Tool (for Mac Computers).....	79
Settings Dialog Box.....	80
Paper Settings Tab.....	82
Print Settings Tab.....	84
Printer Settings Tab.....	85
Bluetooth Settings Tab (PJ-762/PJ-763/PJ-763MFi Only).....	87
Wireless LAN Tab (PJ-773 Only).....	88
Applying Setting Changes to Multiple Printers.....	89
Changing Settings When Printing from a Mobile Device.....	90
Confirm the Printer Settings.....	91

4 Other Functions **92**

Mass Storage Mode.....	92
Description.....	92
Using the Mass Storage Mode.....	92
JPEG Printing.....	93

5 Printer Maintenance **94**

Cleaning the Platen Roller.....	94
Cleaning the Printer's Surface.....	95
Clearing a Paper Jam.....	95

Section II Application

6	How to Use P-touch Editor (Windows Only)	97
	Using P-touch Editor.....	97
	Using P-touch Editor.....	97
7	How to Use P-touch Transfer Manager & P-touch Library (Windows Only)	101
	Using P-touch Transfer Manager.....	102
	Transferring the Template to P-touch Transfer Manager	102
	Transferring Templates or Other Data from the Computer to the Printer via USB	105
	Backing up Templates or Other Data Saved in the Printer.....	110
	Deleting All the Printer Data	111
	Using P-touch Library	112
	Starting P-touch Library.....	112
	Opening and Editing Templates	113
	Printing Templates.....	114
	Searching for Templates or Other Data.....	114
8	Transferring Templates with P-touch Transfer Express (Windows Only)	116
	Preparing P-touch Transfer Express	116
	Transferring the Template to P-touch Transfer Manager	117
	Saving the Template as a Transfer Package File (.pdz).....	118
	Distributing the Transfer Package File (.pdz) and P-touch Transfer Express to the User	120
	Transferring the Transfer Package File (.pdz) to Your Printer.....	121
9	How to Update Printer Software Using Windows and Mac Computers	124
	Updating P-touch Editor.....	124
	Updating the Firmware	126

Section III Wireless Network (PJ-773 Only)

10	Introduction	129
	Network Features	129
11	Changing Your Printer's Network Settings	130
	Changing Your Printer's Network Settings	
	(IP Address, Subnet Mask and Gateway) Using Windows.....	130
	Using the BRAdmin Light Utility.....	130
	Other Management Utilities	132
	Using the Web Based Management (Web Browser).....	132
	Using the BRAdmin Professional Utility (Windows Only)	132

12 Web Based Management 133

Overview.....133
Configuring the Printer Settings Using Web Based Management (Web Browser).....134

Section IV Appendix

13 Product Specifications 136

14 Troubleshooting 138

Overview.....138
Paper Problems.....139
Printed Image Problems.....139
Pages Do Not Print.....141
Pages Are Partially Printed.....142
Network Setup Problems.....142
Printer Cannot Print over the Network
Printer Is Not Found on the Network Even after Successful Installation143
Security Software Problems144
Checking the Operation of Network Devices.....144

15 Supported Protocols and Security Features 145

16 Network Terms and Information 146

Types of Network Connections and Protocols.....146
Types of Network Connections.....146
Configuring Your Printer for a Network.....148
IP Addresses, Subnet Masks and Gateways148
Wireless Network Terms and Concepts150
Security Terms150

17 Product Dimensions 155



Basic Operations

Setting Up the Printer	2
Using the Printer	31
Changing the Printer Settings	45
Other Functions	92
Printer Maintenance	94





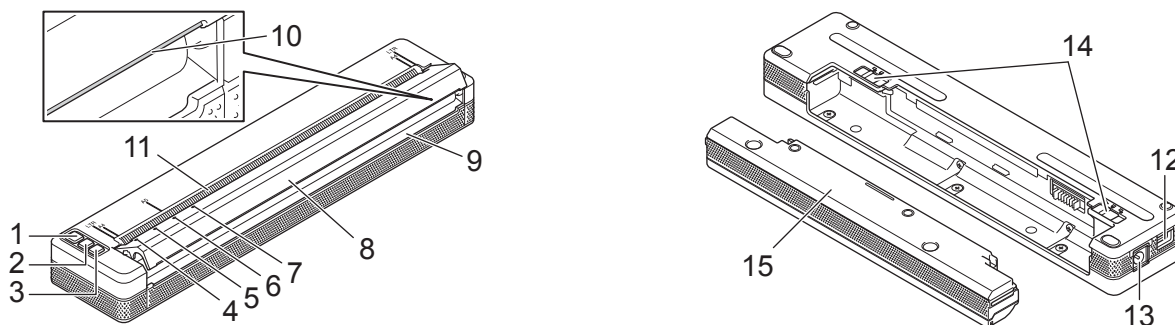

1

Setting Up the Printer

1

General Description



- 1  (Power) button
- 2  (Feed) button
- 3  (Bluetooth) button (PJ-762/PJ-763/PJ-763MFi only)
 (Wi-Fi) button (PJ-773 only)
- 4 POWER indicator
- 5 DATA indicator
- 6 STATUS indicator
- 7  (Bluetooth) indicator (PJ-762/PJ-763/PJ-763MFi only)
 (Wi-Fi) indicator (PJ-773 only)
- 8 Release cover
- 9 Paper outlet slot
- 10 Tear bar
- 11 Paper input slot
- 12 USB port
- 13 DC connector
- 14 Battery latches
- 15 Battery cavity mounting block

LED Indicators

PJ-722/PJ-723

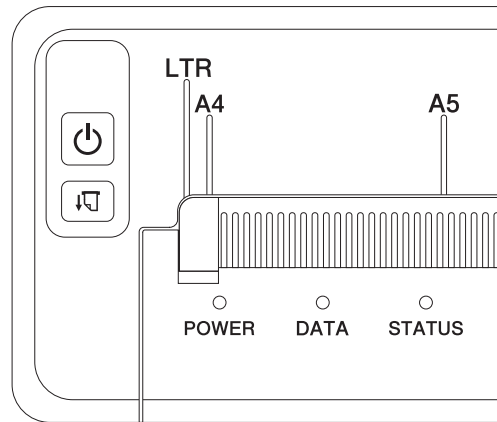

PJ-762/PJ-763/PJ-763MFi

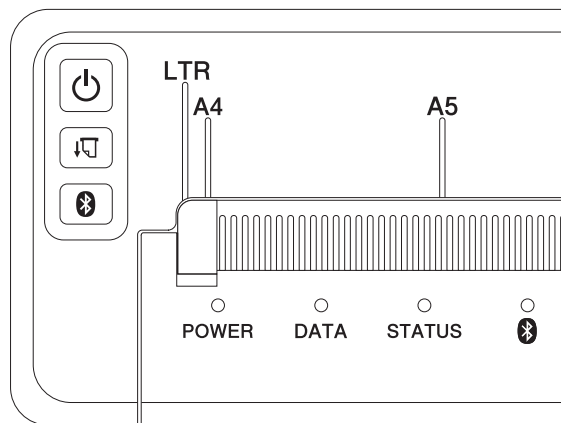



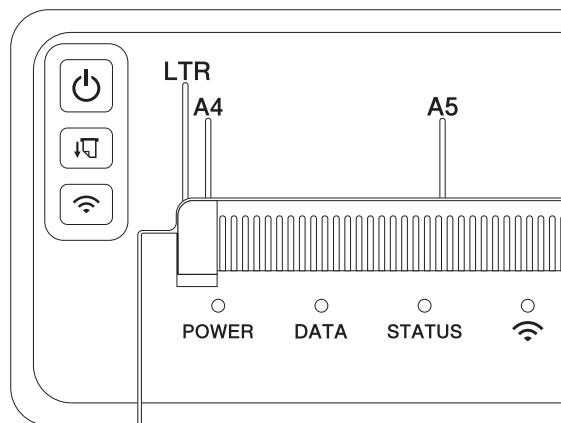





PJ-773

















































The indicators light and flash to indicate the printer's status. Each indicator may light or flash in green, red, orange or blue.

The symbols used in this section explain the meaning of the different indicator colors and patterns:

















 or  or  or  Indicator is lit in the color shown
 or  or  or  Indicator is flashing in the color shown
 Indicator is lit or flashing in any color
 Indicator is off

For more information on error causes and solutions, see *Indicator Warnings* on page 7 or *Troubleshooting* on page 138.





















POWER	DATA	STATUS	Bluetooth ¹	Wi-Fi ²	Description
	<input type="checkbox"/>	<input checked="" type="checkbox"/>	<input type="checkbox"/>	<input type="checkbox"/>	Battery charging completed with the AC adapter or car adapter connected
	<input type="checkbox"/>		<input type="checkbox"/>	<input type="checkbox"/>	Battery charging
	<input type="checkbox"/>	<input checked="" type="checkbox"/>	<input type="checkbox"/>	<input type="checkbox"/>	Rechargeable Li-ion battery in use, battery charge is full
	<input type="checkbox"/>	 (Once every four seconds)	<input type="checkbox"/>	<input type="checkbox"/>	Rechargeable Li-ion battery in use, battery charge is half-full
	<input type="checkbox"/>	 (Twice every four seconds)	<input type="checkbox"/>	<input type="checkbox"/>	Rechargeable Li-ion battery in use, battery charge is low
	<input checked="" type="checkbox"/>	 (Once every second)	<input type="checkbox"/>	<input type="checkbox"/>	Rechargeable Li-ion battery in use, charge the battery
<input checked="" type="checkbox"/>	<input type="checkbox"/>		<input type="checkbox"/>	<input type="checkbox"/>	Battery charging while printer is turned off
 /  ³	<input checked="" type="checkbox"/>	<input type="checkbox"/>	<input type="checkbox"/>	<input type="checkbox"/>	Printer in idle mode
 /  ³		<input type="checkbox"/>	<input type="checkbox"/>	<input type="checkbox"/>	Receiving data
 /  ³		<input type="checkbox"/>	<input type="checkbox"/>	<input type="checkbox"/>	Printing, or buffer contains unprinted data
 /  ³	 (Once every second)	<input checked="" type="checkbox"/>	<input type="checkbox"/>	<input type="checkbox"/>	Transferring data

POWER	DATA	STATUS	Bluetooth ¹	Wi-Fi ²	Description
 ³			<input type="checkbox"/>	<input type="checkbox"/>	Updating a template or program
 ³		<input type="checkbox"/>	<input type="checkbox"/>	<input type="checkbox"/>	Maintenance mode/self printing/cleaning
 ³					Printer in boot mode
 ³	 (Once every two seconds)	 (Once every two seconds)	<input type="checkbox"/>	<input type="checkbox"/>	Printer cooling down
 (Once every second)			<input type="checkbox"/>	<input type="checkbox"/>	Communication error No template error Memory full error Access point search error ² Access point connection error ² Security error ²
					Mass storage error
					System error

Bluetooth indicator ¹

POWER	DATA	STATUS	 (Bluetooth)	Description
				Bluetooth on, connected
			 (Once every second)	Pairing with Bluetooth
			 (Once every two seconds)	Connecting to an Apple device (iPad, iPhone, or iPod touch)
				Bluetooth module error

Wi-Fi indicator ²

POWER	DATA	STATUS	 (Wi-Fi)	Description
			 (Once every three seconds)	Wi-Fi on, not connected
				Wi-Fi on, connected
			 (Once every second)	WPS setup
		 (Once every second)	 (Once every second)	WPS setup failed
			 (Once every second)	Wi-Fi module error

¹ PJ-762/PJ-763/PJ-763MFi only



² PJ-773 only

³ When the AC adapter or car adapter is used to power the printer, the indicator is lit in green; when the rechargeable Li-ion battery is installed to power the printer, the indicator is lit in orange.

Indicator Warnings

Problem	Solution
The POWER indicator does not light	<p>The printer is receiving no power.</p> <p>If you are using AC or DC power, connect the AC adapter or car adapter correctly (see <i>Connect the Printer to External Power</i> on page 14) and turn the AC or DC power outlet on.</p> <p>If you are using a rechargeable Li-ion battery, make sure the battery is firmly installed in the printer and is fully charged.</p>
Received data in buffer	<p>Print data is saved in the buffer. If the printer receives incomplete data (for example because of a lost Wi-Fi connection), printing will not start. Turn the printer off, and then turn it on again.</p>
Head or motor is cooling down	<p>The thermal head or motor is too hot.</p> <p>Head: The printer stops and resumes printing only after the thermal head has cooled down. The head may become too hot if you are printing a large number of documents with high text content.</p> <p>If the thermal head becomes too hot, it may produce imaging on the paper in areas not intended to be printed.</p> <p>To avoid or delay overheating, use a lighter density setting, reduce the amount of black space being printed (for example, remove background shading and colors in graphs and presentation documents), and make sure the printer has adequate ventilation and is not located in an enclosed space.</p> <p>Motor: Continuously using the printer will cause the motor to heat up. If it becomes too hot, the printer will stop and resume printing after the motor has cooled down.</p> <p> Note This condition may occur more often when the printer is used at high altitude (more than 10,000 ft (3,048 m)) due to a lower air density available to cool the printer.</p>
Data reception error	<p>With unstable communication, it may not be possible to receive data correctly. Improve the communication conditions, and then establish the connection again.</p>
Printer is in boot mode	<p>To resolve the issue, contact your Brother dealer or Brother Customer Service for assistance.</p>

Button Functions

 (Power) button function	Operation
Turn the printer on	Press and hold the button for about one second until the POWER indicator turns on.
Turn the printer off	Press and hold the button for about one second or press it quickly two times depending on the setting specified in the Printer Setting Tool (see <i>Changing the Printer Settings</i> on page 45). (If the [Auto Power Off] feature is enabled in the Printer Setting Tool, the printer will turn itself off automatically after the selected period of inactivity.)
Start up the printer in Mass Storage Mode	If you press and hold the button while also pressing the  (Feed) button, the printer starts up in mass storage mode (see <i>Mass Storage Mode</i> on page 92).

 (Feed) button function	Operation
Feed paper	<p>Load the paper and press the button to feed the paper.</p> <p>If you continue to hold down the button after about 1/2 inch (12.7 mm) of paper has been fed, about one page length of paper is fed at high speed. The amount of paper fed is determined by the [Form Feed Mode] setting in the Printer Setting Tool (see <i>Changing the Printer Settings</i> on page 45).</p> <p>To ensure that printing is complete, wait five seconds after the printer has received the data before using a form feed.</p>
Print the printer settings (see <i>Confirm the Printer Settings</i> on page 91)	<p>To print the printer settings without connecting the printer to a computer or mobile device:</p> <ol style="list-style-type: none"> 1 Turn the printer on and make sure no paper is loaded. 2 Press and hold the button until the DATA indicator lights in red. 3 Load paper.

 (Bluetooth) button function (PJ-762/PJ-763/PJ-763MFi only)	Operation
Enable/disable the Bluetooth function	Press and hold the button for one second to enable or disable the Bluetooth function of the printer.

 (Wi-Fi) button function (PJ-773 only)	Operation
Enable/disable the Wi-Fi function	Press and hold the button for one second to enable or disable the Wi-Fi function of the printer.
Use WPS to configure Wi-Fi settings easily	Press and hold the button for about five seconds to configure the Wi-Fi settings using WPS.

Use the Rechargeable Li-ion Battery (Optional)

Installing the Rechargeable Li-ion Battery

- 1 Move battery latch 1 to the unlock position.
- 2 While holding battery latch 2 in the unlock position, remove the battery cavity mounting block.

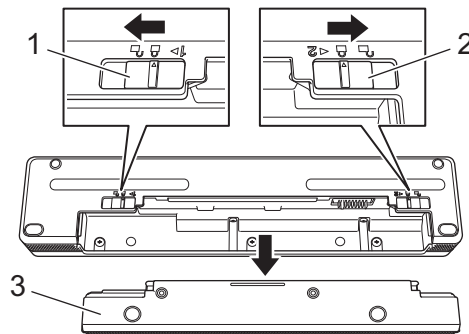

- 1 **Battery latch 1**
- 2 **Battery latch 2**
- 3 **Battery cavity mounting block**

- 3 Release battery latch 2.
Battery latch 2 moves back to the lock position.
- 4 Insert the battery into the battery cavity until it locks into place.

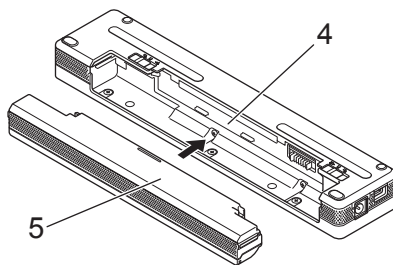

- 4 **Battery cavity**
- 5 **Rechargeable Li-ion battery**

- 5 Move battery latch 1 to the lock position.

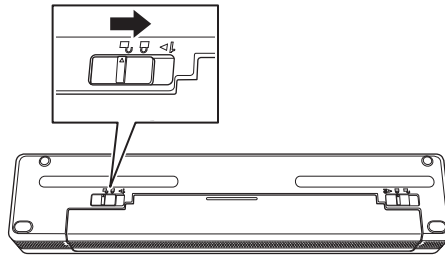

Note

- The voltage supplied by the rechargeable Li-ion battery may vary. The printing speed may also vary depending on the voltage.
- When the battery is being used, the battery cavity mounting block is not needed. Keep it in a safe place to avoid losing it.

Removing the Rechargeable Li-ion Battery

1

- 1 Move the battery latches to the unlock position, and then remove the battery.

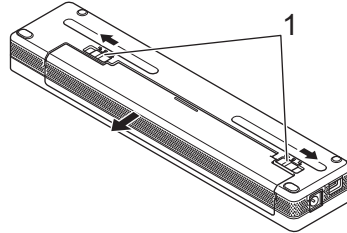

1 Battery latches

- 2 Insert the battery cavity mounting block into the battery cavity until it locks into place.
- 3 Move battery latch 1 to the lock position.

Charging the Rechargeable Li-ion Battery



Note

- Charge the battery immediately after purchase using the following procedure.
- Up to three hours are needed to fully charge the rechargeable Li-ion battery. When fully charged, the battery will print about 600 pages.

- 1 Turn the printer off and install the battery.
- 2 Use the AC adapter and AC power cord to connect the printer to an AC power outlet (see *Connecting to an AC Power Outlet (Optional)* on page 14), or use the car adapter to connect the printer to a DC power outlet (see *Connecting to a DC Power Outlet (Optional)* on page 15).

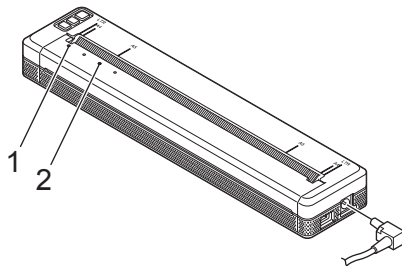

- 1 **POWER** indicator
- 2 **STATUS** indicator

- 3 When the battery is fully charged, the STATUS indicator turns off. Disconnect the AC adapter or car adapter from the DC connector.

Stopping Rechargeable Li-ion Battery Charging

To stop the battery charging, disconnect the AC adapter or car adapter from the DC connector.

1

Notes on Using the Rechargeable Li-ion Battery

- Fully charge the battery before use. Do not use it before it is fully charged.
- High density (dark) printing discharges the battery faster than low density printing.
Adjust the print density setting in the printer driver's dialog box, or in the Printer Setting Tool (see *Changing the Printer Settings* on page 45).
- The battery charging must take place in 32°F - 104°F (0°C - 40°C) environments, otherwise the battery will not be charged, and the STATUS indicator will remain lit.
- If you use the printer when both the battery is installed and the AC adapter or car adapter is connected, the STATUS indicator may turn off and charging may stop even if the battery has not been fully charged.

Rechargeable Li-ion Battery Characteristics

To ensure the highest performance and longest life from the battery:

- Do not use or store the battery in a location exposed to extreme high or low temperatures as it may discharge more quickly. This may happen when using a rechargeable Li-ion battery with a high charge (charged 90% or more) in a location exposed to high temperatures.
- Remove the battery when storing the printer for long periods of time.
- Store batteries with less than a 50% charge in a cool dry place out of direct sunlight.
- Recharge the battery every six months if it is stored for long periods of time.

Connect the Printer to External Power

Connecting to an AC Power Outlet (Optional)

Connect the printer to a nearby AC power outlet to power the printer or charge the rechargeable Li-ion battery using AC power.

- 1 Connect the AC adapter to the printer.
- 2 Connect the AC power cord to the AC adapter.
- 3 Connect the AC power cord to a nearby AC power outlet (100 - 240 VAC, 50 - 60 Hz).

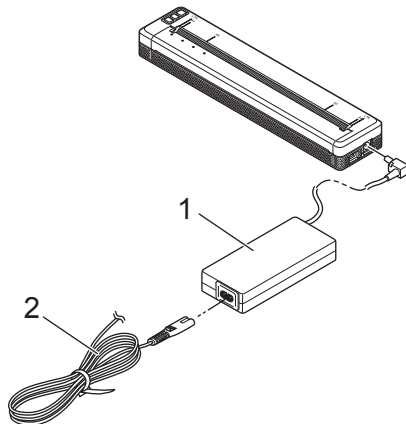

- 1 AC adapter
- 2 AC power cord



Note

The AC adapter and AC power cord are optional accessories. When purchasing, choose an adapter and power cord appropriate for the region where the printer will be used.

Connecting to a DC Power Outlet (Optional)

1

Connect the printer to your vehicle's 12 V DC power outlet (cigarette lighter or similar) to power the printer or charge the rechargeable Li-ion battery using the vehicle's DC power.

- 1 Connect the car adapter to the vehicle's 12 V DC power outlet.
- 2 Connect the car adapter to the printer.

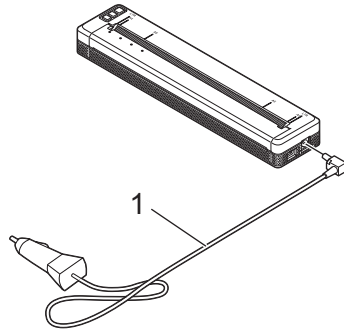

1 Car adapter



Note

- The car adapter is an optional accessory.
 - The voltage supplied by a vehicle may fluctuate, and printing speed may vary.
 - The maximum voltage is 12 V DC.
 - The car adapter plug is not compatible with other outlets that are not the 12 V cigarette type.
 - When the car adapter is connected to charge the rechargeable Li-ion battery, the amount of voltage required to fully charge the battery may not be supplied by the DC power socket.
- If 9 hours have passed since charging started, the STATUS indicator turns off and charging stops even if the rechargeable Li-ion battery has not been fully charged.

Turning the Printer On or Off

On:

- 1 Make sure the printer is correctly powered. Use a fully charged battery, or connect the printer to an AC or DC power outlet.
- 2 Press and hold the  (Power) button for about one second to turn the printer on. The POWER indicator lights in green (if the printer is connected to an AC or DC power outlet) or in orange (if the rechargeable Li-ion battery is used).

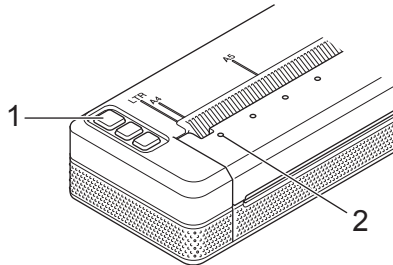

- 1  (Power) button
- 2 POWER indicator

To turn the printer off: Press and hold the  (Power) button until the POWER and STATUS indicators light in orange.



Note

When turning the printer off, do NOT remove the battery or disconnect the AC adapter or car adapter until the POWER and STATUS indicators turn off.

Loading Paper in the Printer

Use both hands to hold the paper straight, and then carefully insert the paper into the printer's input slot until the roller pulls it into the starting position. For best results, use genuine Brother paper.

1

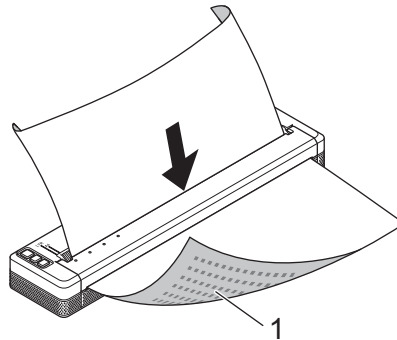

1 Print surface (faces downward)

When loading fanfold paper

Insert the fanfold paper with the black marks positioned as shown in the illustration.

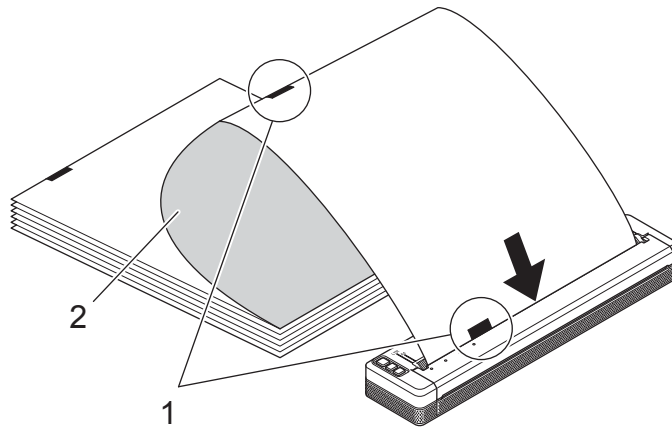

1 Black marks

2 Print surface



Note

- The bottom edge of the paper must be parallel to the roller.
- Only one side of the paper can be printed on. Check the paper, and load it so that the smooth, thermal side faces down.

Notes on Using Paper

You can set the paper type to **[Cut Sheet]**, **[Roll]** or **[Perforated Roll]** in the printer driver.

1

Cutting Paper

Use the tear bar of the printer to cut the paper. Pull one edge of the ejected paper up and towards the other edge diagonally.

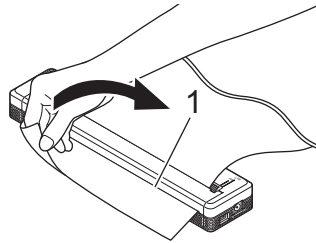

1 Tear bar

⚠ Important

The tear bar is sharp. To avoid injury, do not touch the tear bar.

Install Software to Your Computer or Mobile Device

Several printing methods are available depending on your printer model and the computer or mobile device you use to print from.

Refer to the following tables and install other applications on your computer or mobile device as needed.

Available Software

For Windows PCs

To connect the printer to your computer, the printer driver must be installed. For more information on downloading and installing the printer driver and applications, see *Installing the Printer Driver and Software (When Using a Windows PC or Mac)* on page 24.

Software		PJ-722	PJ-723	PJ-762	PJ-763	PJ-763MFi	PJ-773	Features	
		—		Bluetooth			Wi-Fi		
		—			MFi				
		USB							
1	Printer driver	✓	✓	✓	✓	✓	✓	—	
2	Printer Setting Tool	Communication Settings	—	—	✓	✓	✓	✓	Allows you to specify the printer's communication settings and device settings from the computer.
		Device Settings	✓	✓	✓	✓	✓	✓	
		P-touch Template Setting Tool	✓	✓	✓	✓	✓	✓	Allows you to configure the P-touch Template settings. P-touch Template provides functions for inserting data from a device (such as a barcode reader connected to the printer) into text and barcode objects in layouts saved on the printer, useful for printing templates and barcodes.
3	P-touch Editor	✓	✓	✓	✓	✓	✓	Allows you to design custom documents, store templates, connect to databases, and use a large library of labels and tags.	

Software		PJ-722	PJ-723	PJ-762	PJ-763	PJ-763MFi	PJ-773	Features
		—		Bluetooth			Wi-Fi	
				—	MFi			
		USB						
4	P-touch Transfer Manager	✓	✓	✓	✓	✓	✓	Allows you to transfer files created with P-touch Editor to a printer and store the files in the printer's memory. You can print them from the printer's memory without connecting to your computer.
5	Transfer Express	✓	✓	✓	✓	✓	✓	Allows you to transfer documents to the printer easily.
6	P-touch Update Software	✓	✓	✓	✓	✓	✓	Allows you to update the firmware and software.
7	BRAdmin Professional	—	—	—	—	—	✓	BRAdmin Professional has more powerful features for managing network printers than BRAdmin Light. You can easily configure and check the status of your network connected printers, and transfer the template to the printer via a network.
8	BRAdmin Light	—	—	—	—	—	✓	Allows you to configure the initial settings of network connected printers.
9	BRAgent	—	—	—	—	—	✓	Allows you to manage printers in different segments*, and send data to the PC on which BRAdmin Professional is installed. * A segment is the area managed by a single router.
10	Web Based Management	—	—	—	—	—	✓	Allows you to use a standard web browser to manage a printer on your network using HTTP.

For Mac computers

To download and install the printer driver and applications, see *Installing the Printer Driver and Software (When Using a Windows PC or Mac)* on page 24.

Software		PJ-722	PJ-723	PJ-762	PJ-763	PJ-763MFi	PJ-773	Features
		—		Bluetooth			Wi-Fi	
				—	MFi			
		USB						
1	Printer driver	✓	✓	✓	✓	✓	✓	—
2	Printer Setting Tool	✓	✓	✓	✓	✓	✓	Allows you to specify the printer's communication settings and device settings from the computer.
3	P-touch Update Software	✓	✓	✓	✓	✓	✓	Allows you to update the firmware and software.
4	Web Based Management	—	—	—	—	—	✓	Allows you to use a standard web browser to manage a printer on your network using HTTP.
5	AirPrint	—	—	—	—	—	✓	AirPrint allows you to easily print from a Mac or iOS device (iPad, iPhone, or iPod touch) without installing additional applications.

For iOS devices

Software		PJ-722	PJ-723	PJ-762	PJ-763	PJ-763MFi	PJ-773	Features
		—		Bluetooth			Wi-Fi	
		—			MFi			
1	iPrint&Scan	—	—	—	—	✓	✓	Brother iPrint&Scan allows you to use features of your printer directly from your mobile device. Use your iOS device to download iPrint&Scan from the App Store. * Scanning is not available for PJ-7 series.
2	Mobile Transfer Express	—	—	—	—	✓	✓	Mobile Transfer Express is an application that allows you to use a mobile device to transfer files (templates, databases and images) which were prepared using P-touch Transfer Manager (Windows version), to a printer.
3	AirPrint	—	—	—	—	—	✓	AirPrint allows you to easily print from a Mac or iOS device (iPad, iPhone, or iPod touch) without installing additional applications.
4	Google Cloud Print™	—	—	—	—	—	✓	Google Cloud Print™ is a service provided by Google that allows you to print to a printer registered to your Google account using a network-compatible device, such as a mobile phone or computer, without installing the printer driver on the device.
5	Web Based Management	—	—	—	—	—	✓	Allows you to use a standard web browser to manage a printer on your network using HTTP.

A software development kit (SDK) is also available.

Visit the Brother Developer Center (www.brother.com/product/dev/index.htm).

For Android™ devices

Software		PJ-722	PJ-723	PJ-762	PJ-763	PJ-763MFi	PJ-773	Features
		—		Bluetooth			Wi-Fi	
		—			MFi			
1	iPrint&Scan	—	—	✓	✓	✓	✓	<p>Brother iPrint&Scan allows you to use features of your printer directly from your mobile device. Use your Android™ device to download iPrint&Scan from the Google Play Store.</p> <p>* Scanning is not available for PJ-7 series.</p>
2	Mobile Transfer Express	✓	✓	✓	✓	✓	✓	<p>Mobile Transfer Express is an application that allows you to use a mobile device to transfer files (templates, databases and images), which were prepared using P-touch Transfer Manager (Windows version), to a printer.</p>
3	Mopria™	—	—	—	—	—	✓	<p>Mopria™ Print Service is a print functionality on Android™ phones and tablets (Android™ version 4.4 or later) developed by the Mopria Alliance. With this service, you can connect to the same network as the printer and print without additional setup.</p>
4	Google Cloud Print™	—	—	—	—	—	✓	<p>Google Cloud Print™ is a service provided by Google that allows you to print to a printer registered to your Google account using a network-compatible device, such as a mobile phone or computer, without installing the printer driver on the device.</p>
5	Web Based Management	—	—	—	—	—	✓	<p>Allows you to use a standard web browser to manage a printer on your network using HTTP.</p>

A software development kit (SDK) is also available.

Visit the Brother Developer Center (www.brother.com/product/dev/index.htm).

Installing the Printer Driver and Software (When Using a Windows PC or Mac)

1

To print from your Windows PC or Mac, install the printer driver, P-touch Editor and other applications to your computer.

- 1 Visit our website (install.brother) and download the installer for the software and documents.
- 2 Double-click the downloaded .exe file and follow the on-screen instructions to proceed with the installation. Select the software you want in the installer's software selection window.

Connect the Printer to a Computer or Mobile Device

The printer can be connected to your computer or mobile device using a USB cable or via a Bluetooth connection (PJ-762/PJ-763/PJ-763MFi only) or Wi-Fi connection (PJ-773 only).

1

Connecting Using USB

- 1 Make sure the printer is turned off before connecting the USB cable.
- 2 Connect the printer end of the USB cable to the USB port on the side of the printer.
- 3 Connect the other end of the USB cable to the USB port on the computer.

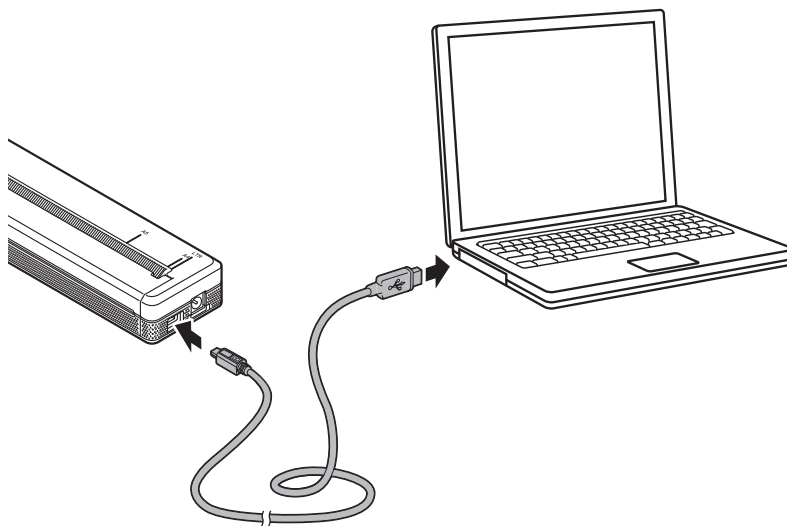



Connecting Using Bluetooth (PJ-762/PJ-763/PJ-763MFi Only)



Note

- Follow the recommendations of the manufacturer of your Bluetooth-equipped devices (computers and mobile devices) or Bluetooth adapter and install any necessary hardware and software.
 - The Bluetooth connection settings are saved even after the printer is turned off.
-

Use this procedure to pair the printer with the computer or mobile device using the Bluetooth management software.

- 1 Press and hold the  (Power) button to turn the printer on, and then press and hold the  (Bluetooth) button.
- 2 Use your Bluetooth device management software to discover the printer.



Note

You can change the printer's network settings using the Printer Setting Tool (see *Changing the Printer Settings* on page 45).

Connecting Using Wi-Fi (PJ-773 Only)

The following Wi-Fi connection methods are available:

- Wireless Direct
- Infrastructure Mode
- Ad-hoc Mode
- WPS (Wi-Fi Protected Setup™)



Note

- To connect using the Ad-hoc Mode, see [FAQs & Troubleshooting] on the Brother support website (support.brother.com).
- Not all computers, mobile devices, and operating systems, may support Ad-hoc mode.

Wireless Direct



Wireless Direct allows you to connect the printer to your computer or mobile device directly without a Wi-Fi access point/router; the printer serves as a Wi-Fi access point.

- 1 Confirm the Wireless Direct settings of the printer. When you connect to a mobile device, use a Windows PC or Mac to confirm the settings.
 - For Windows PCs

Connect the printer and computer with a USB cable. Start the Printer Setting Tool on your computer, and click the [Communication Settings] button. Confirm that [Wireless Direct] is selected for [Selected Interface] in the [General] tab. (This is selected as the factory default settings.)

See *Communication Settings (PJ-762/PJ-763/PJ-763MFi/PJ-773 Only)* on page 48 for more information on the Communication Settings.
 - For Mac computers

Connect the printer and computer with a USB cable. Start the Printer Setting Tool on your computer, and confirm that [WirelessDirect] is set to [On] in the [Wireless LAN] tab. (This is selected as the factory default settings.)

See *Printer Setting Tool (for Mac Computers)* on page 79 for more information on the Printer Setting Tool.
- 2 Press and hold the  (Wi-Fi) button on your printer for one second to turn the Wi-Fi function on. The  (Wi-Fi) indicator starts flashing in blue once every three seconds.
- 3 Use your computer or mobile device to select the SSID of your printer ("DIRECT-*****_PJ-773" where "*****" is the last five digits of the product serial number) and enter the password ("773*****"). When the connection is established, the  (Wi-Fi) indicator lights in blue.



Note

- If you press the  (Wi-Fi) button for five seconds or more, the printer will enter the WPS mode (see *WPS (Wi-Fi Protected Setup™)* on page 30) and any connection using Wireless Direct will fail.

- You can change the printer's network settings using the Printer Setting Tool (see *Changing the Printer Settings* on page 45).
- The Printer Setting Tool also allows you to easily apply the network settings changes to multiple printers. (See *Applying Setting Changes to Multiple Printers* on page 63 when using Windows PCs or page 89 when using Mac computers.)
- You can find the serial number label on the back of the printer or in the battery cavity.
You can also confirm the serial number by printing the printer settings (see *Confirm the Printer Settings* on page 91).
- You cannot connect to the Internet via Wi-Fi while using Wireless Direct. To use the Internet, use a wired connection (when a computer is connected), or connect using Infrastructure Mode.





Infrastructure Mode

Infrastructure Mode allows you to connect the printer to a computer or mobile device via a Wi-Fi access point/router.

■ Before You Begin

First you must configure the Wi-Fi settings of your printer to communicate with your Wi-Fi access point/router. After the printer is configured, computers or mobile devices on your network will have access to the printer.

❗ Important



- If you are going to connect the printer to your network, we recommend that you contact your system administrator prior to installation. You must confirm your Wi-Fi settings before you proceed with this installation.
- To configure the Wi-Fi settings again, or if the status of the Wi-Fi connection for your printer is not clear, reset the Wi-Fi settings of the printer.
 - 1 Confirm that the printer is turned off.
 - 2 While holding down the  (Feed) button, press the  (Power) button three times, and then release the  (Feed) button.
The POWER indicator starts flashing in orange.
 - 3 Press the  (Feed) button twice.

Note

To achieve the best results with normal everyday document printing, use the printer as close to the Wi-Fi access point/router as possible with minimal obstructions. Large objects and walls between the two devices as well as interference from other electronic devices can affect the data transfer speed of your documents.

■ Connecting the printer to your Wi-Fi access point/router

- 1 First, write down the SSID (network name) and password (network key) of your Wi-Fi access point/router.
- 2 Connect the printer and computer with a USB cable.

3 Press and hold the  (Wi-Fi) button on your printer for one second to turn the Wi-Fi function on. The  (Wi-Fi) indicator starts flashing in blue once every three seconds.

4 Configure the Infrastructure Mode settings of the printer.

■ For Windows PCs

Start the Printer Setting Tool on your computer, and click the [**Communication Settings**] button. Select [**Wireless LAN**] for [**Selected Interface**] in the [**General**] tab, and select [**Infrastructure**] for [**Communication Mode**] in [**Wireless Settings**] in the [**Wireless LAN**] tab.

See *Communication Settings (PJ-762/PJ-763/PJ-763MFi/PJ-773 Only)* on page 48 for more information on the Communication Settings.

■ For Mac computers

Start the Wireless Device Setup Wizard included in the Printer Driver Package, and then follow the on-screen instructions.

If you have not downloaded the Printer Driver Package, visit your model's **Downloads** page on the Brother support website at support.brother.com to download the package. Double-click the downloaded file. The Wireless Device Setup Wizard can be found in the [**Utilities**] folder.

5 Enter the SSID that you wrote down, or click [**Search**] and select the SSID from the displayed list.

6 Enter the password as [**Passphrase**].



Note

The required information depends on the authentication method and encryption mode; enter only the information relevant to your network environment.

7 Click [**Apply**].

When the connection between the printer and your Wi-Fi access point/router is established, the  (Wi-Fi) indicator lights in blue. Computers and mobile devices that are on the same network as the printer will have access to the printer.



Note



- To change any other network settings, use the Printer Setting Tool (see *Changing the Printer Settings* on page 45).
- To connect your mobile device to the Wi-Fi access point/router, select the SSID and enter the password of the Wi-Fi access point/router to establish the connection between the mobile device and Wi-Fi access point/router.

WPS (Wi-Fi Protected Setup™)

If your Wi-Fi access point/router supports WPS, settings and connections can be configured easily.

- 1 First, confirm that your Wi-Fi access point/router has the WPS symbol.



- 2 Place your printer within the range of your Wi-Fi access point/router. The range may differ depending on your environment. See the instructions provided with your Wi-Fi access point/router.
- 3 Press the WPS button on your Wi-Fi access point/router, and press and hold the  (Wi-Fi) button on the printer for about five seconds.
The  (Wi-Fi) indicator on the printer flashes in blue once every second.
When the connection is established, the  (Wi-Fi) indicator lights in blue. Computers and mobile devices that are on the same network as the printer will have access to the printer.



Note

Your printer will try to connect using WPS for two minutes. If the  (Wi-Fi) button is held down for another five seconds during that time, the printer will continue trying to connect for an additional two minutes.

Printing from a Windows PC or Mac

Printing with the Printer Driver

- 1 Open the document you want to print.
- 2 Turn the printer on.
- 3 Connect the printer to a computer using USB, Bluetooth or Wi-Fi (see *Connect the Printer to a Computer or Mobile Device* on page 25).
- 4 Load paper.

**Note**

If necessary, change the printer settings in the printer driver's dialog box, or in the Printer Setting Tool (see *Changing the Printer Settings* on page 45).

- 5 Print from the application.
The DATA indicator flashes in green to indicate that the printer is receiving data, and then the document is printed.
- 6 Turn the printer off.

**Note**

- If paper is loaded and the DATA indicator remains green without flashing, the printer has not received enough data to print an entire page. Turn the printer off, and then turn it on again.
 - The paper can be loaded after the print job has been sent. If the paper is skewed after the printer pulls it into the starting position, open the release cover completely, remove the paper, and then close the cover and load the paper again (see *Clearing a Paper Jam* on page 95).
 - To print a JPEG image without using the printer driver, see *JPEG Printing* on page 93.
-

Making Prints Lighter or Darker

You can make prints lighter or darker by adjusting the print density setting in the printer driver's dialog box, or in the Printer Setting Tool (see *Changing the Printer Settings* on page 45).

When using the battery, changing the print density setting may result in slight changes in printing speed and the number of pages that can be printed on a single charge.

Setting Printer Driver Options

You can configure various settings such as paper size and number of copies, in the printer driver screen. To use the functions indicated with an asterisk (*), install the printer driver that will be available in February 2016 and thereafter. The newest version can be downloaded from the Brother support website: support.brother.com.



Note

You can also use the Printer Setting Tool (see *Changing the Printer Settings* on page 45) to configure advanced settings.

Settings That Can Be Changed Using the Windows Printer Driver (Examples)

Basic Tab

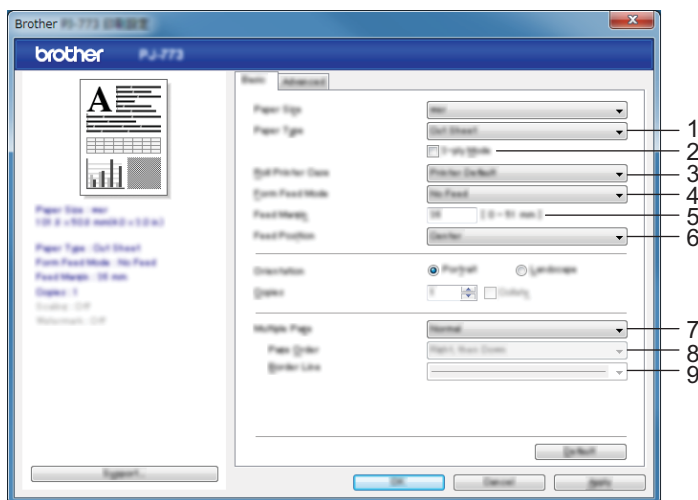

* This screen image may be different from your screen.

1 Paper Type

Specifies the type of paper that is loaded.

Available settings: [Cut Sheet], [Roll], [Perforated Roll]

2 2-ply Mode

Specifies the setting for using 2-ply paper.

Available settings: [Enable], [Disable]

3 Roll Printer Case

Specifies the setting for using the optional roll printer case. If [PA-RC-001] or [PA-RC-001 (Without Anti Curl)] is selected, you can adjust the feed value or amount of paper retraction for the roll printer case.

Available settings: [Printer Default], [None], [PA-RC-001], [PA-RC-001 (Without Anti Curl)]

4 **Form Feed Mode**

Specifies how the printer responds to form feed commands received from any source.

Available settings: **[No Feed]**, **[Fixed Page]**, **[End of Page]**, **[End of Page Retract]**

- **No Feed** - Paper is not fed at the end of a job. Because additional paper is not ejected at the end of the document, use this setting when printing on non-perforated roll paper. Make sure to set **[Paper Type]** to **[Roll]**.
- **Fixed Page** - Paper is fed at the end of a job to suit the vertical length of the selected page size (for example: letter, legal, A4, or user-defined size). Select this setting when using cut sheet paper. Make sure to set **[Paper Type]** to **[Cut Sheet]** or **[Roll]**.
- **End of Page** - Paper is fed until the paper sensor detects a pre-printed end-of-page mark on the paper or the end of the sheet, or until 14" (355.6 mm) of paper has been fed. Use this setting when **[Paper Type]** is set to **[Cut Sheet]** or **[Perforated Roll]**.
- **End of Page Retract** - Paper is fed until the paper sensor detects a pre-printed end-of-page mark on the paper. Then, the paper is fed back to the starting position before the next page is printed. Use this setting when **[Paper Type]** is set to **[Perforated Roll]**.

5 **Feed Margin**

Specifies the feed margin for the last page of the print job. Use this option when **[Form Feed Mode]** is set to **[No Feed]**.

Available settings: 0" - 2" (0 mm - 51 mm)

6 **Feed Position**

Specifies the paper feed position for printing on custom paper.

Available settings: **[Center]**, **[Left Alignment]**

7 **Multiple Page**

Prints more than one page on a single sheet of paper.

Available settings: **[Normal]**, **[2 in 1]**, **[4 in 1]**, **[9 in 1]**

8 **Page Order**

Specifies the page order when a setting other than **[Normal]** is specified for **[Multiple Page]**.

9 **Border Line**

Specifies the border line between pages when a setting other than **[Normal]** is specified for **[Multiple Page]**.

Available settings: **[Solid]**, **[Dashed]**, **[None]**

Advanced Tab

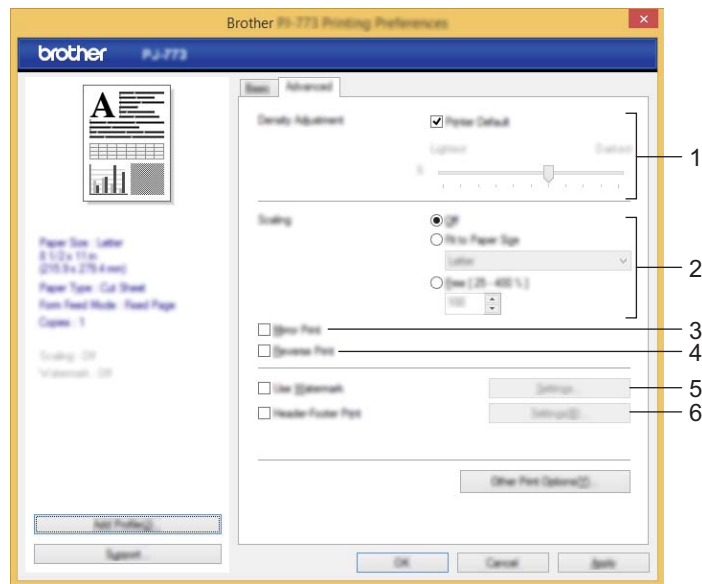

1 Density Adjustment

Specifies the printing density.

Available settings: **[Printer Default]**, 0-10

2 Scaling

Specifies the reduction or enlargement ratio for printing.

Available settings: **[Off]**, **[Fit to Paper Size]**, 25% - 400%

3 Mirror Print

Prints your document in reverse.

Available settings: **[Enable]**, **[Disable]**

4 Reverse Print

Rotates your document 180 degrees.

Available settings: **[Enable]**, **[Disable]**

5 Use Watermark

Prints a logo or text as a watermark on your document. You can use preset watermarks, add a new watermark, or use an image file you have created.

Available settings: **[Enable]**, **[Disable]**

6 Header-Footer Print

Prints the date, time, and ID in the header or footer.

Available settings: **[Enable]**, **[Disable]**

Administrator*

Locks the following settings so that they cannot be changed.

- Copy Count
- Multi Page & Scaling
- Watermark
- Header-Footer Print

Other Print Options Screen

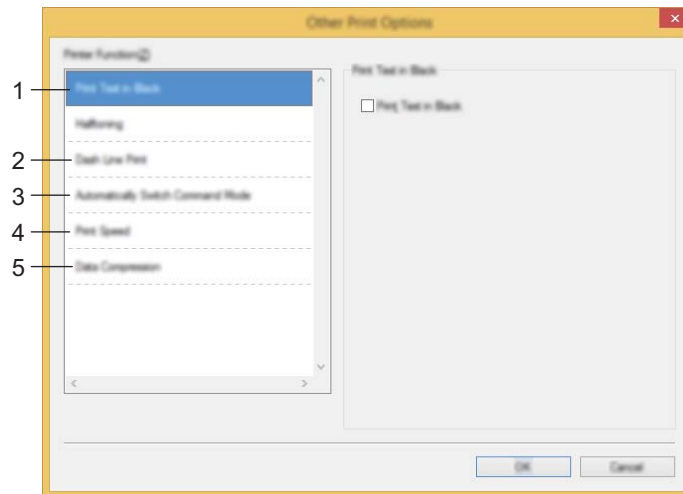

1 Print Text in Black

Prints color text in black.

Available settings: [Disable], [Enable]

2 Dash Line Print

Prints dash lines between pages, useful when printing on roll paper. Set [Form Feed Mode] to [Fixed Page] and [Paper Type] to [Roll], and then select [Enable]. Note that dash lines are printed on the paper; they are not punched into the paper.

Available settings: [Disable], [Enable]

Print Archive*

Saves print data as a PDF file to your computer.

Available settings: [Disable], [Enable]

3 Automatically Switch Command Mode

Specifies whether the mode switching command is automatically sent when the commands are switched while using the printer.

When using PJ-7 series, select the check box for this item.

Because this function is an optional function for using previous models, you should usually clear this check box when using previous models.

Available settings: [Disable], [Enable]

4 **Print Speed**

Specifies the printing speed in inches or millimeters per second. Reducing the printing speed improves the print quality.

Available settings: [**Printer Default**], [**1.1 ips / 27 mm/s**], [**1.6 ips / 41 mm/s**], [**1.9 ips / 48 mm/s**], [**2.5 ips / 65 mm/s**]

5 **Data Compression**

When using PJ-7 series, select the check box for this item.

Because this function is an optional function for using previous models, you should usually clear this check box when using previous models.

Available settings: [**Disable**], [**Enable**]

Roll Paper Pause*

Displays a confirmation message for each page when printing.

Available settings: [**Disable**], [**Enable**]

Other Functions

Print Profiles*

Print Profiles are presets designed to give you quick access to frequently used printing configurations. In addition, frequently used printing settings can be added as Print Profiles.

Settings That Can Be Changed Using the Mac Printer Driver (Examples)

Basic pop-up menu

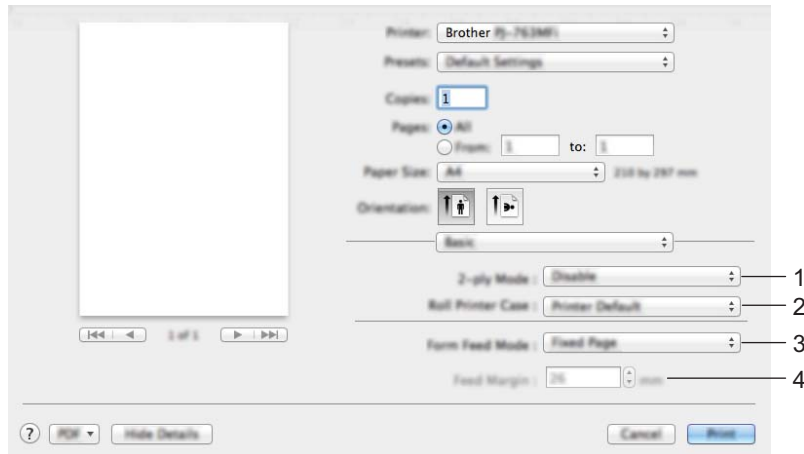

1 **2-ply Mode**

Specifies the setting for using 2-ply paper.

Available settings: [Enable], [Disable]

2 **Roll Printer Case**

Specifies the setting for using the optional roll printer case. If [PA-RC-001] or [PA-RC-001 (Without Anti Curl)] is selected, you can adjust the feed value or amount of paper retraction for the roll printer case.

Available settings: [Printer Default], [None], [PA-RC-001], [PA-RC-001 (Without Anti Curl)]

3 **Form Feed Mode**

Specifies how the printer responds to form feed commands received from any source.

Available settings: [No Feed], [Fixed Page], [End of Page], [End of Page Retract]

4 **Feed Margin**

Specifies the feed margin for the last page of the print job. Use this option when [Form Feed Mode] is set to [No Feed].

Available settings: 0" - 2" (0 mm - 51 mm)

Advanced pop-up menu

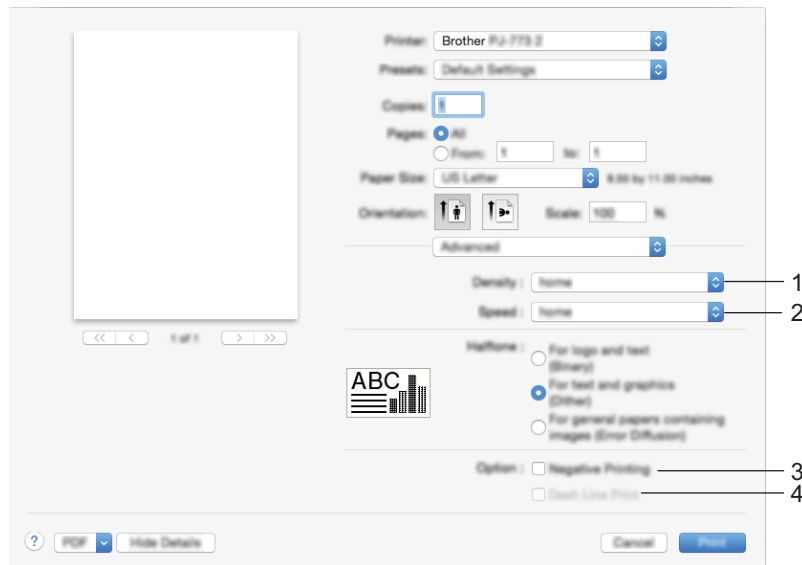

1 Density

Specifies the printing density.

Available settings: **[Printer Default]**, 0-10

2 Print Speed

Specifies the printing speed in inches or millimeters per second. Reducing the printing speed improves the print quality.

Available settings: **[Printer Default]**, **[1.1 ips / 27 mm/s]**, **[1.6 ips / 41 mm/s]**, **[1.9 ips / 48 mm/s]**, **[2.5 ips / 65 mm/s]**

3 Negative Printing

Prints with black and white inverted.

4 Dash Line Print

Prints dash lines between pages, useful when printing on roll paper. Set **[Form Feed Mode]** to **[Fixed Page]** and **[Paper Type]** to **[Roll]**, and then select **[Enable]**. Note that dash lines are printed on the paper; they are not punched into the paper.

Available settings: **[Disable]**, **[Enable]**

Printing with Google Cloud Print™ (PJ-773 Only)

Google Cloud Print™ is a Google-provided service that allows you to print to a printer registered to your Google account using a network-compatible device (such as a mobile phone or computer) without installing a printer driver on the device.

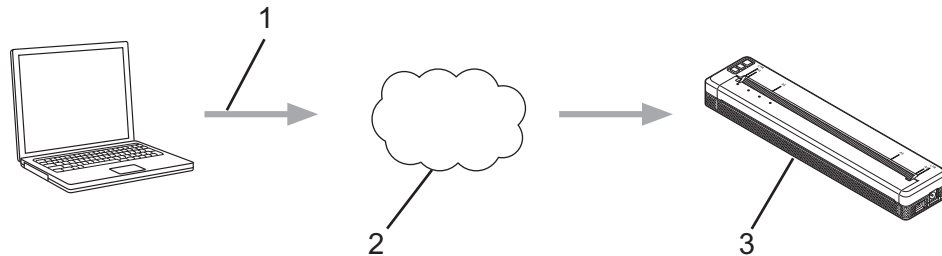

- 1 Print request
- 2 Google Cloud Print™
- 3 Your printer

For more information, see the *Google Cloud Print Guide*. Visit your model's **Manuals** page on the Brother support website at support.brother.com to download the guide.

Printing with AirPrint (Only When Using PJ-773 with a Mac)

Use AirPrint to wirelessly print photos, emails, web pages, and documents from your Mac, iPad, iPhone and iPod touch without installing a printer driver on the device.

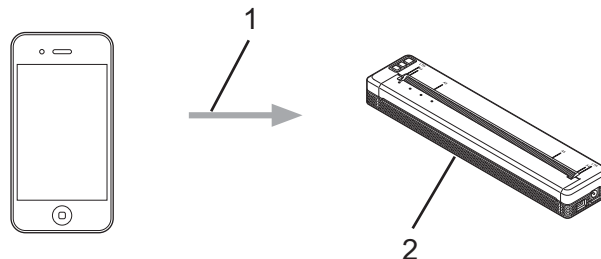

- 1 Print request
- 2 Your printer

For more information, see the *AirPrint Guide*. Visit your model's **Manuals** page on the Brother support website at support.brother.com to download the guide.

Printing from an iOS Device

Printing with iPrint&Scan (PJ-763MFi/PJ-773 Only)

Use Brother iPrint&Scan to print from your iOS device.

Brother iPrint&Scan allows you to use features of your printer directly from your iPhone, iPod touch, iPad, and iPad mini™, without using a computer.

Download and install Brother iPrint&Scan from the App Store.

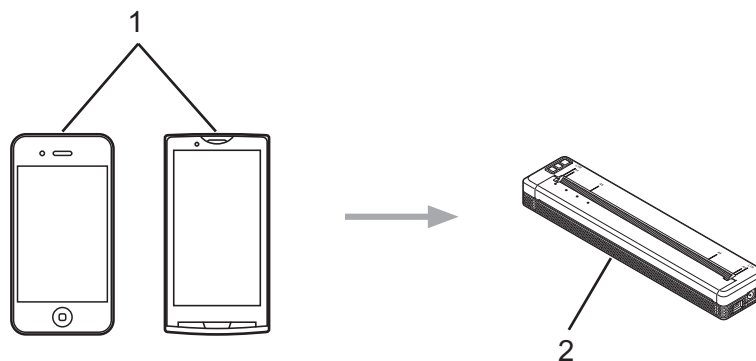

1 Mobile device

2 Your printer

For more information, see the *Mobile Print/Scan Guide for Brother iPrint&Scan (iOS)*. Visit your model's **Manuals** page on the Brother support website at support.brother.com to download the guide.



Note

Scanning is not available for PJ-7 series.

Printing with AirPrint (PJ-773 Only)

Use AirPrint to wirelessly print photos, emails, web pages, and documents from your Mac, iPad, iPhone and iPod touch without installing a printer driver on the device.

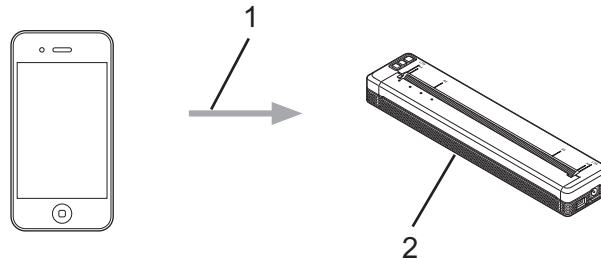

1 Print request

2 Your printer

For more information, see the *AirPrint Guide*. Visit your model's **Manuals** page on the Brother support website at support.brother.com to download the guide.

Printing with Google Cloud Print™ (PJ-773 Only)

Google Cloud Print™ is a Google-provided service that allows you to print to a printer registered to your Google account using a network-compatible device (such as a mobile phone or computer) without installing a printer driver on the device.

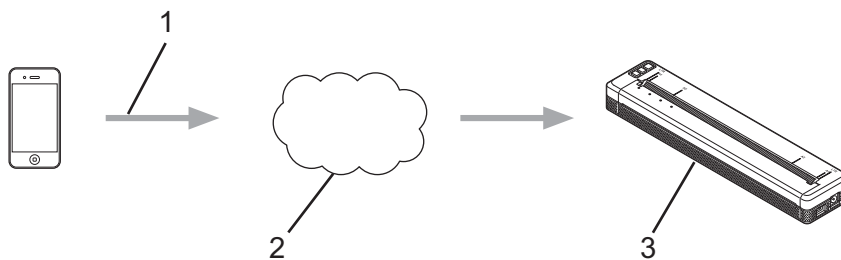

1 Print request

2 Google Cloud Print™

3 Your printer

For more information, see the *Google Cloud Print Guide*. Visit your model's **Manuals** page on the Brother support website at support.brother.com to download the guide.

Printing from an Android™ Device

Printing with iPrint&Scan (PJ-762/PJ-763/PJ-763MFi/PJ-773 Only)

Use Brother iPrint&Scan to print from your Android™ device.

Brother iPrint&Scan allows you to use features of your printer directly from your Android™ device, without using a computer.

Download and install Brother iPrint&Scan from the Google Play™ Store.

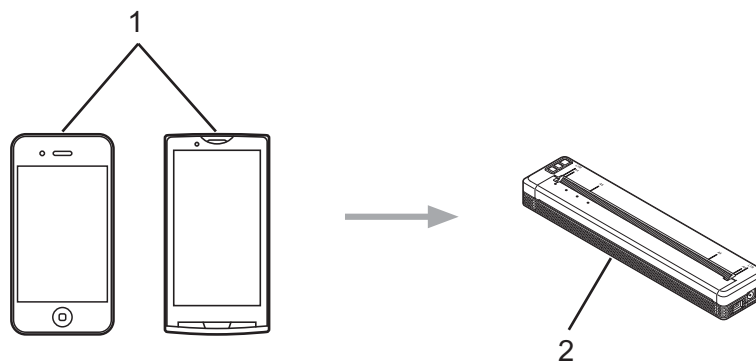

1 Mobile device

2 Your printer

For more information, see the *Mobile Print/Scan Guide for Brother iPrint&Scan (Android™)*. Visit your model's **Manuals** page on the Brother support website at support.brother.com to download the guide.



Note

Scanning is not available for PJ-7 series.

Printing with Mopria™ (PJ-773 Only)

Mopria™ Print Service is a print functionality on Android™ phones and tablets (Android™ version 4.4 or later) developed by the Mopria Alliance. With this service, you can connect to the same network as the printer and print without additional setup. Many native Android™ apps, including Google Chrome™, Gmail and Gallery, support printing.

2

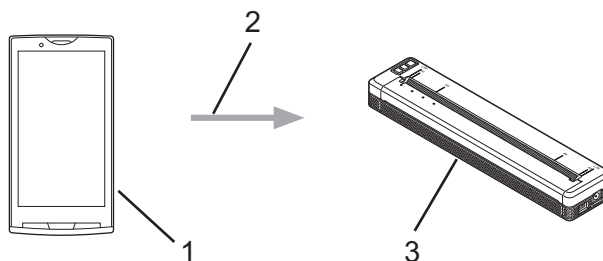

- 1 Android™ 4.4 or later**
- 2 Wi-Fi Connection**
- 3 Your printer**

You must download the Mopria Plug-in from the Google Play™ Store app and install it on your Android™ device. Make sure you turn the service on before using this functionality.

Printing with Google Cloud Print™ (PJ-773 Only)

Google Cloud Print™ is a Google-provided service that allows you to print to a printer registered to your Google account using a network-compatible device (such as a mobile phone or computer) without installing a printer driver on the device.

2

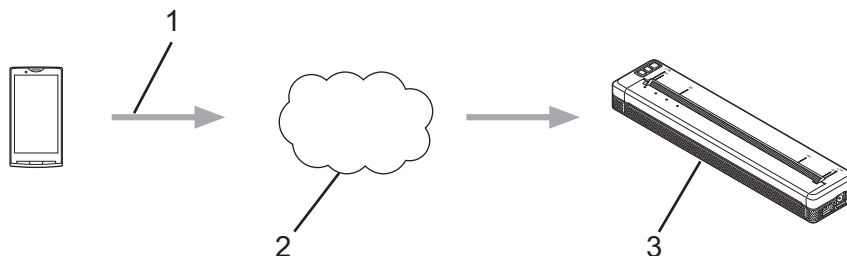

- 1 Print request
- 2 Google Cloud Print™
- 3 Your printer

For more information, see the *Google Cloud Print Guide*. Visit your model's **Manuals** page on the Brother support website at support.brother.com to download the guide.

Printer Setting Tool (for Windows PCs)

Using the “**Printer Setting Tool**”, you can specify the printer’s communication settings, device settings and P-touch Template settings from a Windows PC.



Note

- The “**Printer Setting Tool**” is installed at the same time as other software, such as the printer driver. For more information, see *Installing the Printer Driver and Software (When Using a Windows PC or Mac)* on page 24.
- For more information on P-touch Template, download the *P-touch Template Manual/Raster Command Reference* (English only) from the Brother support website: support.brother.com.



Important

The “**Printer Setting Tool**” is available only with compatible Brother printers.

Before Using the Printer Setting Tool

- Make sure the AC adapter is connected to an AC power outlet, the car adapter is connected to a DC power outlet, or the fully-charged battery is installed.
- Make sure the printer driver has been installed and is functional.
- Connect this printer to a computer with a USB cable or via a Bluetooth connection.
With this tool, settings cannot be specified using Wi-Fi.
- The P-touch Template Setting Tool can be configured only via USB.

Using the Printer Setting Tool (for Windows PCs)

- 1 Connect the printer you want to configure to the computer.
- 2 For Windows Vista / Windows 7 / Windows Server 2008 / Windows Server 2008 R2:
From the Start menu, click **[All Programs] - [Brother] - [Label & Mobile Printer] - [Printer Setting Tool]**.

For Windows 8 / Windows 8.1 / Windows Server 2012 / Windows Server 2012 R2:
Click the **[Printer Setting Tool]** icon on the **[Apps]** screen.

For Windows 10:

From the Start button, select all applications, and then click **[Brother] - [Label & Mobile Printer] - [Printer Setting Tool]**.

The main window appears.

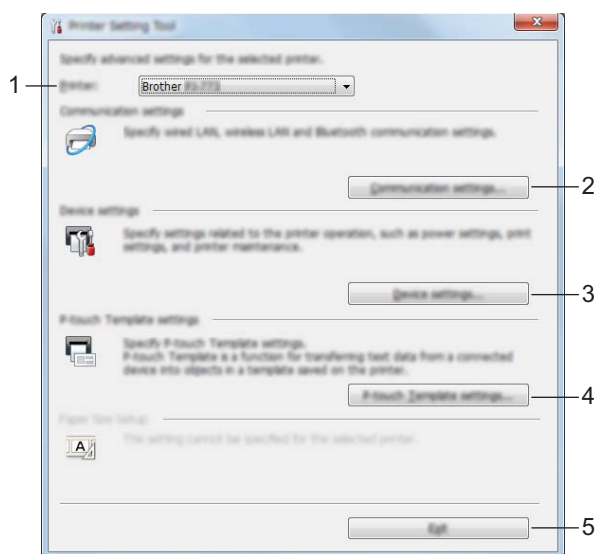

1 Printer

Lists the connected printers.

2 Communication Settings (PJ-762/PJ-763/PJ-763MFi/PJ-773 only)

Specifies wireless LAN and Bluetooth communication settings.

3 Device Settings

Specifies printer device settings, such as power settings and printer settings.

4 P-touch Template Settings

Specifies P-touch Template settings.

For more information on P-touch Template, download the *P-touch Template Manual/Raster Command Reference* (English only) from the Brother support website: support.brother.com.

5 Exit

Closes the window.

- 3 Check that the printer you want to configure appears beside [**Printer**]. If a different printer appears, select the printer you want from the drop-down list.



Note

If only one printer is connected, it is unnecessary to make a selection since only that printer is available.

- 4 Select the setting you want to change, and then specify or change the settings in the dialog box. For more information on the settings dialog boxes, see *Communication Settings (PJ-762/PJ-763/PJ-763MFi/PJ-773 Only)* on page 48, *Device Settings* on page 64 or *P-touch Template Settings* on page 76.
- 5 Click [**Apply**] - [**Exit**] in the settings dialog box to apply the settings to the printer.
- 6 Click [**Exit**] in the main window to finish specifying settings.



Important

Use the “**Printer Setting Tool**” to configure the printer only when the printer is in standby. The printer may malfunction if you attempt to configure it while it is handling a job.

Communication Settings (PJ-762/PJ-763/PJ-763MFi/PJ-773 Only)

With **[Communication Settings]** in the “**Printer Setting Tool**”, the printer communication information can be specified or changed when connecting the printer and computer with a USB cable or via a Bluetooth connection. Not only can you change the communication settings for one printer, but you can also apply the same settings to multiple printers.

Settings Dialog Box

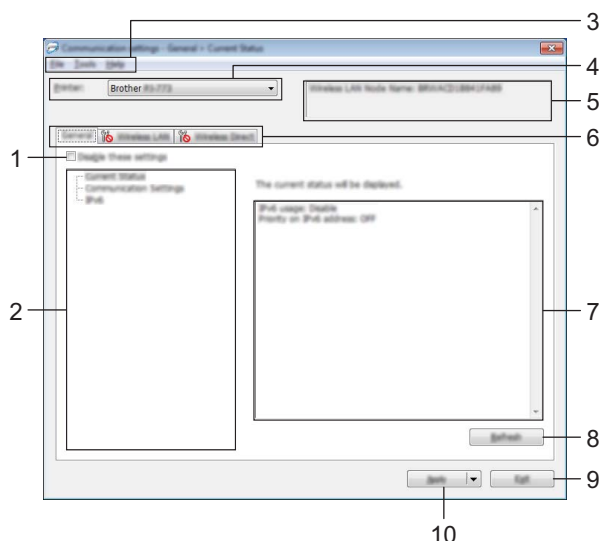

1 Disable these settings

When this check box is selected,  appears in the tab, and the settings can no longer be specified or changed.

Settings in a tab where  appears will not be applied to the printer even if **[Apply]** is clicked. In addition, the settings in the tab will not be saved or exported when the **[Save in Command File]** or **[Export]** command is executed.

To apply the settings to the printer or save or export them, make sure you clear the check box.

2 Items

When **[Current Status]** is selected, the current settings appear in the settings display/change area. Select the item for the settings that you want to change.

3 Menu Bar

4 Printer

Lists the connected printers.

5 Node Name

Displays the node name (nodes can be renamed). (See *7 Change Node Name/Bluetooth Device Name in Menu Bar* on page 50.)

6 Settings Tabs

Contain settings that may be specified or changed.

If  appears in the tab, the settings in that tab will not be applied to the printer.

7 Settings Display/Change Area

Displays the current settings for the selected item.

8 Refresh

Updates the displayed settings with the most recent information.

9 Exit

Exits [**Communication Settings**], and returns to the main window of the “**Printer Setting Tool**”.

! Important

Settings are not applied to printers if the [**Exit**] button is clicked without clicking the [**Apply**] button after changing settings.

10 Apply

Applies the settings to the printer.

To save the specified settings in a command file, select [**Save in Command File**] from the drop-down menu. The saved command file can be used with the mass storage mode to apply the settings to a printer. (See *Mass Storage Mode* on page 92.)

! Important

Clicking [**Apply**] applies all settings in all tabs to the printer.

If the [**Disable these settings**] check box is selected, the settings in that tab are not applied.

Menu Bar

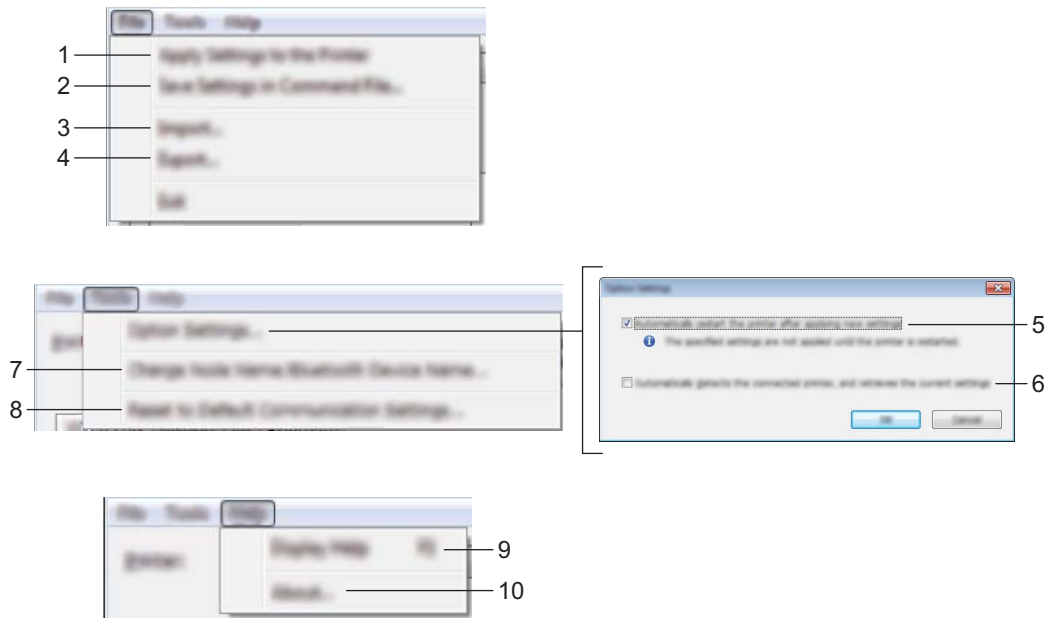

1 Apply Settings to the Printer

Applies the settings to the printer.

2 Save Settings in Command File

Saves the specified settings in a command file. The file extension is .bin.

The saved command file can be used with the mass storage mode to apply the settings to a printer. (See *Mass Storage Mode* on page 92.)



Note

If the **[Disable these settings]** check box is selected, the settings in that tab are not saved.

Important

- The following information is not saved with the settings commands:
 - Node name
 - IP address, subnet mask and default gateway (when the IP address is set to **[STATIC]**)
- The saved communication settings commands are only intended to be used for applying settings to a printer. The settings cannot be applied by importing this command file.
- Saved command files contain authentication keys and passwords. Take necessary measures to protect saved command files, such as saving them in a location that cannot be accessed by other users.
- Do not send the command file to a printer whose model was not specified when the command file was exported.

3 Import

■ Import from the current computer wireless settings

Imports the settings from the computer.



Note

- When importing the computer wireless settings, administrator privileges for the computer are required.
- Only personal security authentication settings (open system, public key authentication and WPA/WPA2-PSK) can be imported. Enterprise security authentication (such as LEAP and EAP-FAST), WPA2-PSK (TKIP) and WPA-PSK (AES) settings cannot be imported.
- If multiple wireless LANs are enabled for the computer you use, the first wireless settings (only personal settings) that are detected will be considered for the import data.
- Only the settings (communication mode, SSID, authentication method, encryption mode and authentication key) from the **[Wireless LAN]** tab - **[Wireless Settings]** pane can be imported.

■ Select a Profile to import

Imports the exported file and applies the settings to a printer.

Click **[Browse]** and select the file you want to import. The settings in the selected file appear in the settings display/change area.



Note

- All settings, such as wireless settings or TCP/IP settings, can be imported, except for node names.
- Only profiles that are compatible with the selected printer can be imported.
- If the imported profile's IP address is set to **[STATIC]**, change the IP address of the imported profile, if necessary, so that it does not duplicate the IP address of an existing configured printer on the network.

4 Export

Saves the current settings in a file.



Note

If the **[Disable these settings]** check box is selected, the settings in that tab are not saved.



Important

Exported files are not encrypted.

5 Automatically restart the printer after applying new settings

If this check box is selected, the printer automatically restarts after communication settings are applied.

If this check box is cleared, you must restart the printer manually.



Note

When configuring multiple printers, you can reduce the time required to change settings by clearing this check box. In this case, we recommend selecting this check box when configuring the first printer so that you can confirm that each setting is operating as intended.

6 Automatically detects the connected printer, and retrieves the current settings.

If this check box is selected and a printer is connected to the computer, the printer is automatically detected and the printer's current settings are displayed in the [**Current Status**] pane.



Note

If the model of the connected printer is different from that of the printer shown in the [**Printer**] drop-down list, the settings available on all tabs change to match the connected printer.

7 Change Node Name/Bluetooth Device Name

Allows renaming a node.

8 Reset to Default Communication Settings

Returns the communication settings to their factory settings.

9 Display Help

Displays the Help.

10 About

Displays the version information.

General Tab

Communication Settings (for PJ-762/PJ-763/PJ-763MFi)

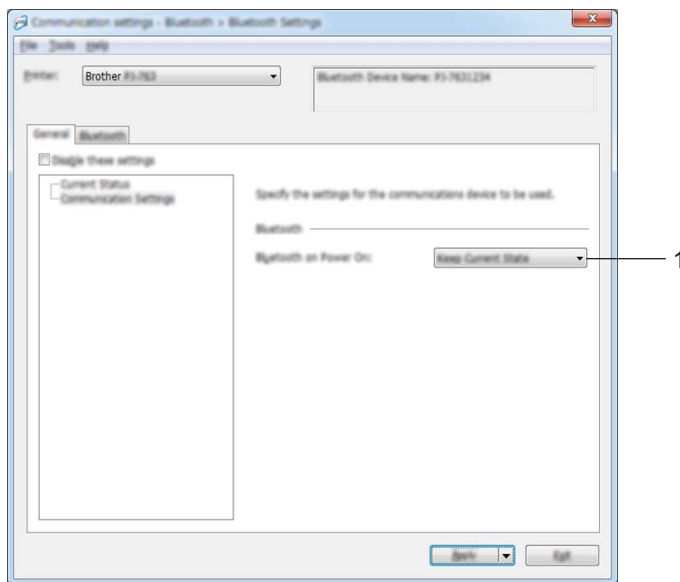

1 Bluetooth on Power On

Specifies the conditions for connecting via Bluetooth when the printer is turned on. Select **[On by default]**, **[Off by default]** or **[Keep Current State]**.

Communication Settings (for PJ-773)

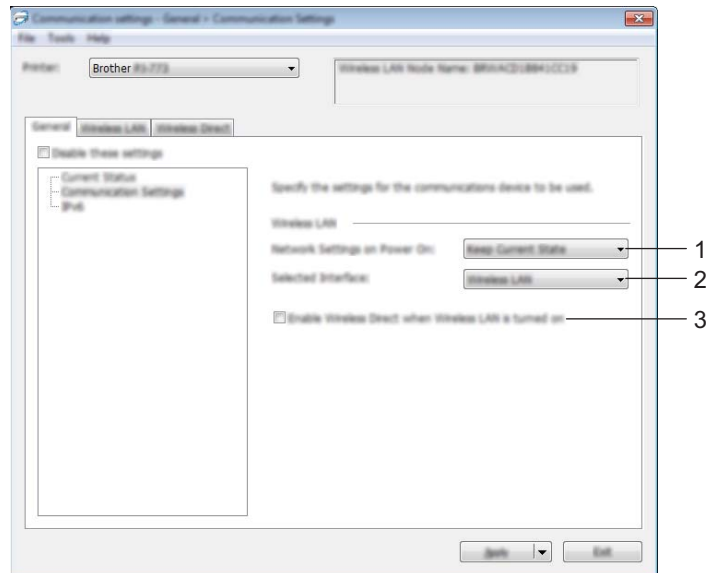

1 Network Settings on Power On

Specifies the conditions for connecting via Wi-Fi when the printer is turned on. Select **[On by Default]**, **[Off by Default]** or **[Keep Current State]**.

2 Selected Interface

Select **[Wireless LAN]** or **[Wireless Direct]**.

3 Enable Wireless Direct when Wireless LAN is turned on

Allows to enable the Infrastructure and Wireless Direct modes at the same time. This check box appears when you select **[Wireless LAN]** for **[Selected Interface]**.

IPv6 (PJ-773 Only)

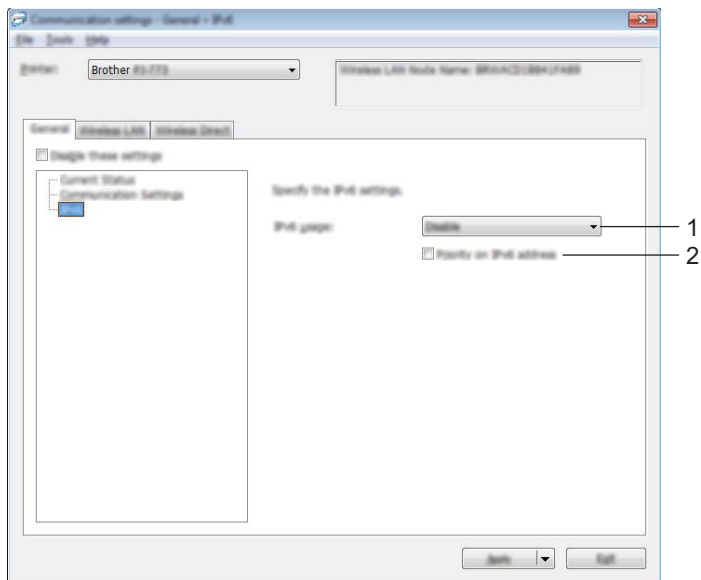

1 IPv6 usage

Select [Enable] or [Disable].

2 Priority on IPv6 address

Select to give priority to an IPv6 address.

Bluetooth Tab (PJ-762/PJ-763/PJ-763MFi Only)

Bluetooth Settings

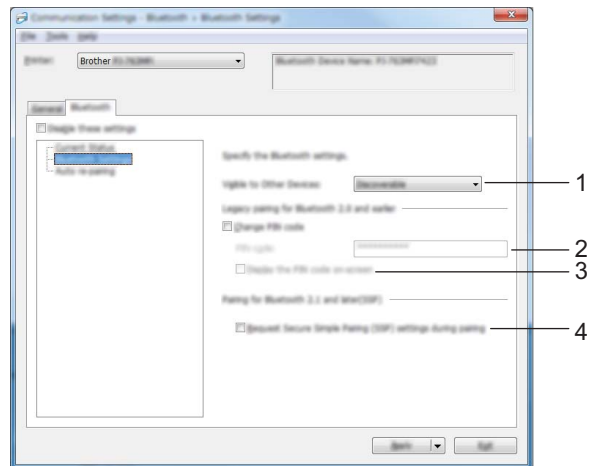

1 Visible to Other Devices

Allows the printer to be “discovered” by other Bluetooth devices.

Available settings: **[Discoverable]**, **[Not Discoverable]**

2 PIN code

Specifies the PIN code that will be used when pairing with devices that are compliant with Bluetooth 2.0 or earlier.

3 Display the PIN code on-screen

If this check box is selected, your computer displays PIN codes by default.

4 Request Secure Simple Pairing (SSP) settings during pairing

If this check box is selected, pairing can be performed using the printer buttons for devices that are compliant with Bluetooth 2.1 or later.

Auto re-pairing (PJ-763MFi only)

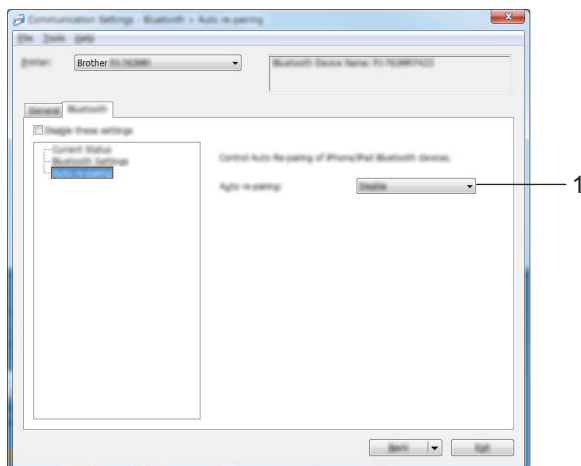

1 Auto re-pairing

Sets whether or not to automatically reconnect to previously connected Apple device (iPad, iPhone or iPod touch).

Available settings: **[Enable]**, **[Disable]**

Wireless LAN Tab (PJ-773 Only)

TCP/IP (Wireless)

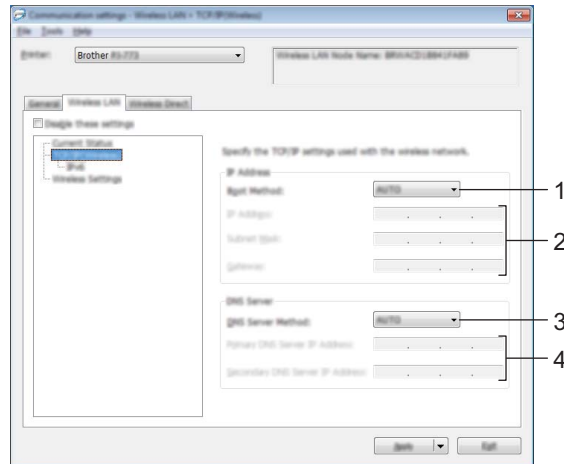

1 Boot Method

Select [AUTO], [BOOTP], [DHCP], [RARP] or [STATIC].

2 IP Address/Subnet Mask/Gateway

Specifies the various networking values.

You can only enter these settings when the IP address is set to [STATIC].

3 DNS Server Method

Select [AUTO] or [STATIC].

4 Primary DNS Server IP Address/Secondary DNS Server IP Address

You can only enter these settings when the DNS server is set to [STATIC].

IPv6

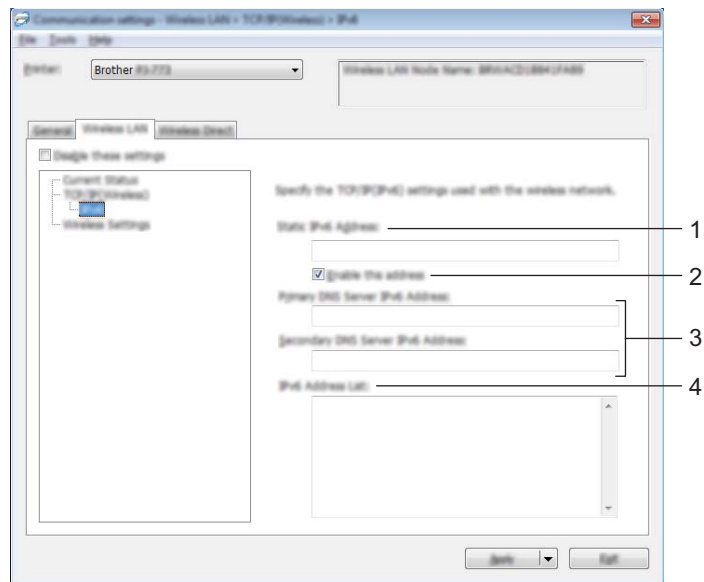

- 1 Static IPv6 Address**
Specifies the IPv6 address.
- 2 Enable this address**
Enables the specified static IPv6 address.
- 3 Primary DNS Server IPv6 Address/Secondary DNS Server IPv6 Address**
Specifies the DNS server IPv6 addresses.
- 4 IPv6 Address List**
Displays the list of IPv6 addresses.

Wireless Settings

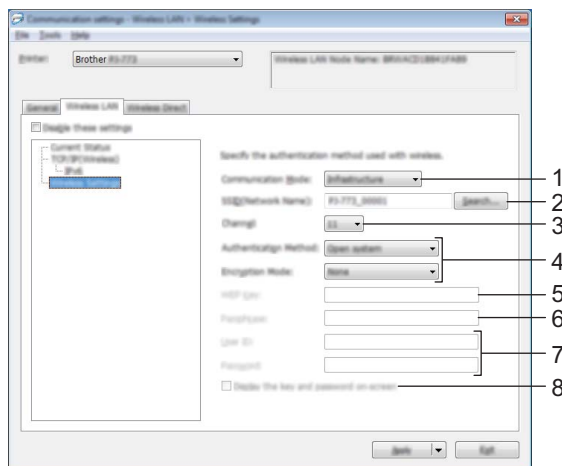

1 Communication Mode

Select [Infrastructure] or [Ad-hoc].

2 SSID (Network Name)

Clicking the [Search] button displays the SSID selections in a separate dialog box.

3 Channel

Lists available channels.



Note

- This setting is valid only in Ad-hoc mode.
- Not all computers, mobile devices, and operating systems, may support Ad-hoc mode.

4 Authentication Method/Encryption Mode

The supported encryption modes for the various authentication methods are as shown in *Communication Modes and Authentication Methods/Encryption Modes* on page 61.

5 WEP Key

You can only specify a setting when WEP is selected as the encryption mode.

6 Passphrase

You can only specify a setting when WPA/WPA2-PSK is selected as the authentication method.

7 User ID/Password

You can only specify settings when LEAP, EAP-FAST, PEAP, EAP-TTLS or EAP-TLS is selected as the authentication method. In addition, with EAP-TLS, it is not necessary to register a password, but a client certificate must be registered. To register a certificate, connect to the printer from a web browser, and then specify the certificate. For more information on using a web browser, see *Web Based Management* on page 133.

8 Display the key and password on-screen

If this check box is selected, keys and passwords are displayed in plain (non-encrypted) text.

Communication Modes and Authentication Methods/Encryption Modes

- When [Communication Mode] is set to [Ad-hoc]

Authentication Method	Encryption Mode
Open System	None / WEP

- When [Communication Mode] is set to [Infrastructure]

Authentication Method	Encryption Mode
Open System	None / WEP
Shared Key	WEP
WPA/WPA2-PSK	TKIP+AES / AES
LEAP	CKIP
EAP-FAST/NONE	TKIP+AES / AES
EAP-FAST/MS-CHAPv2	TKIP+AES / AES
EAP-FAST/GTC	TKIP+AES / AES
PEAP/MS-CHAPv2	TKIP+AES / AES
PEAP/GTC	TKIP+AES / AES
EAP-TTLS/CHAP	TKIP+AES / AES
EAP-TTLS/MS-CHAP	TKIP+AES / AES
EAP-TTLS/MS-CHAPv2	TKIP+AES / AES
EAP-TTLS/PAP	TKIP+AES / AES
EAP-TLS	TKIP+AES / AES

! Important

To specify higher level security settings:

When performing certificate verification with EAP-FAST, PEAP, EAP-TTLS or EAP-TLS authentication methods, the certificate cannot be specified from the "**Printer Setting Tool**". After the printer is configured to connect to the network, specify the certificate by accessing the printer from a web browser.

For more information on using a web browser, see *Web Based Management* on page 133.

Wireless Direct Tab (PJ-773 Only)

Wireless Direct Settings

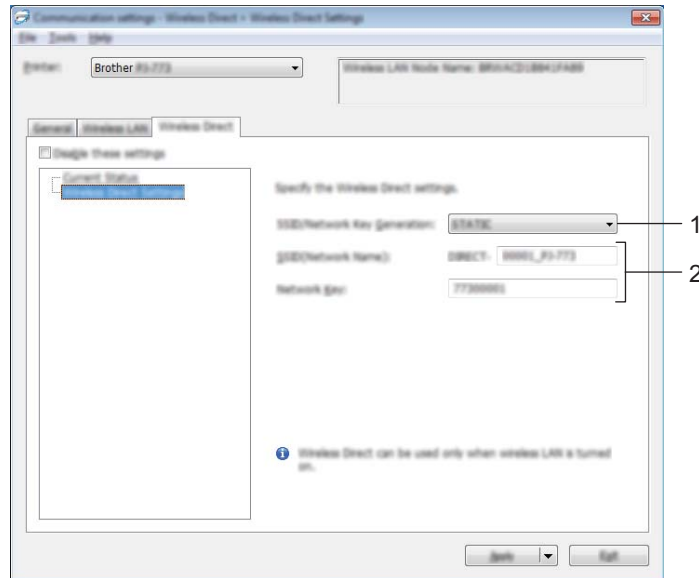

1 SSID/Network Key Generation

Select [AUTO] or [STATIC].

2 SSID (Network Name)/Network Key

Specifies the SSID (25 ASCII characters or fewer) and the network key (63 characters or fewer) you want to use in the Wireless Direct mode.

You can only specify a setting when [STATIC] is selected as [SSID/Network Key Generation].



Note

The factory default SSID and password are as follows:

SSID: "DIRECT-*****_PJ-773" where "*****" is the last five digits of the product serial number.
(You can find the serial number label on the bottom of the printer.)

Password (Network key): 773*****

Applying Setting Changes to Multiple Printers

- 1 After applying settings to the first printer, disconnect the printer from the computer, and then connect the second printer to the computer.
- 2 Select the newly connected printer from the **[Printer]** drop-down list.

 **Note**

If the **[Automatically detects the connected printer, and retrieves the current settings.]** check box in the **[Option Settings]** dialog box is selected, the printer connected with the USB cable is automatically selected.

For more information, see *Communication Settings (PJ-762/PJ-763/PJ-763MFi/PJ-773 Only)* on page 48.

- 3 Click the **[Apply]** button.
The same settings that were applied to the first printer are applied to the second printer.

 **Note**

If the **[Automatically restart the printer after applying new settings]** check box is cleared, the printers will not be restarted after the settings are changed, reducing the time required to configure the printers. However, we recommend selecting the **[Automatically restart the printer after applying new settings]** check box when configuring the first printer so that you can confirm that a connection with the Wi-Fi access point/router can be correctly established with the settings. For more information, see *Communication Settings (PJ-762/PJ-763/PJ-763MFi/PJ-773 Only)* on page 48.

- 4 Repeat steps 1 – 3 for all the printers whose settings you wish to change.

 **Important**

If the IP address is set to **[STATIC]**, the printer's IP address will also be changed to the same address as the first printer.
Change the IP address if necessary.

 **Note**

To save the current settings in a file, click **[File] - [Export]**.

The same settings can be applied to another printer by clicking **[File] - [Import]**, then selecting the exported settings file. (See *Communication Settings (PJ-762/PJ-763/PJ-763MFi/PJ-773 Only)* on page 48.)

Device Settings

With [Device Settings] in the “Printer Setting Tool”, printer settings can be specified or changed when connecting the printer and computer with a USB cable or via a Bluetooth connection. Not only can you change the device settings for one printer, but you can also apply the same settings to multiple printers.

When printing from a computer application, various printing settings can be specified from the printer driver; however, using [Device Settings] in the “Printer Setting Tool”, more advanced settings can be specified.

When [Device Settings] is opened, the printer’s current settings are retrieved and displayed. If the current settings could not be retrieved, the previous settings are displayed. If the current settings could not be retrieved and previous settings have not been specified, this tool’s default settings are displayed.

Settings Dialog Box

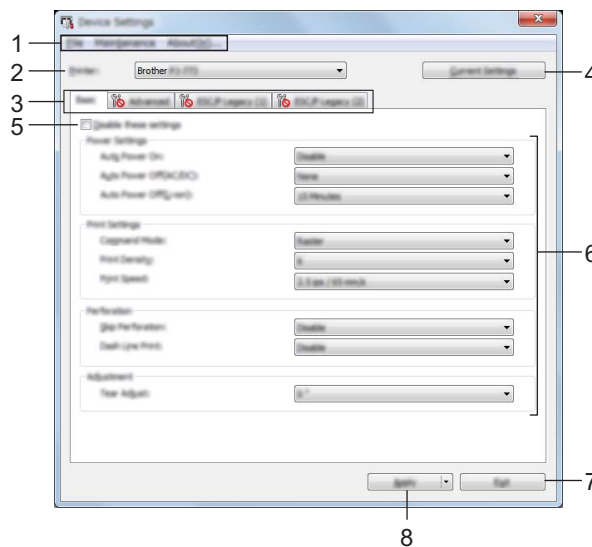

1 Menu Bar

2 Printer

Lists the connected printers.

3 Settings Tabs

Contain settings that may be specified or changed.



Note

If  appears in the tab, the settings in that tab cannot be specified or changed. In addition, the settings in the tab will not be applied to the printer even if [Apply] is clicked. The settings in the tab will also not be saved or exported when the [Save in Command File] or [Export] command is executed.

4 Current Settings

Retrieves the settings from the currently connected printer and displays them in the dialog box. Settings will also be retrieved for parameters on tabs with .

5 Disable these settings

When this check box is selected,  appears in the tab, and the settings can no longer be specified or changed.

Settings in a tab where  appears will not be applied to the printer even if **[Apply]** is clicked. In addition, the settings in the tab will not be saved or exported when the **[Save in Command File]** or **[Export]** command is executed.

To apply the settings to the printer or save or export them, make sure you clear the check box.

The ESC/P Legacy (1) and (2) tabs are linked. When the check box in one of the tabs is selected, the settings in the other tab also cannot be specified.

6 Parameters

Displays the current settings.

7 Exit

Exits **[Device Settings]**, and returns to the main window of the “**Printer Setting Tool**”.

8 Apply

To confirm the current settings, select **[Check Setting...]** from the drop-down menu.

Applies the settings to the printer.

To save the specified settings in a command file, select **[Save in Command File]** from the drop-down menu.

The saved command file can be used with the mass storage mode to apply the settings to a printer. (See *Mass Storage Mode* on page 92.)

Menu Bar

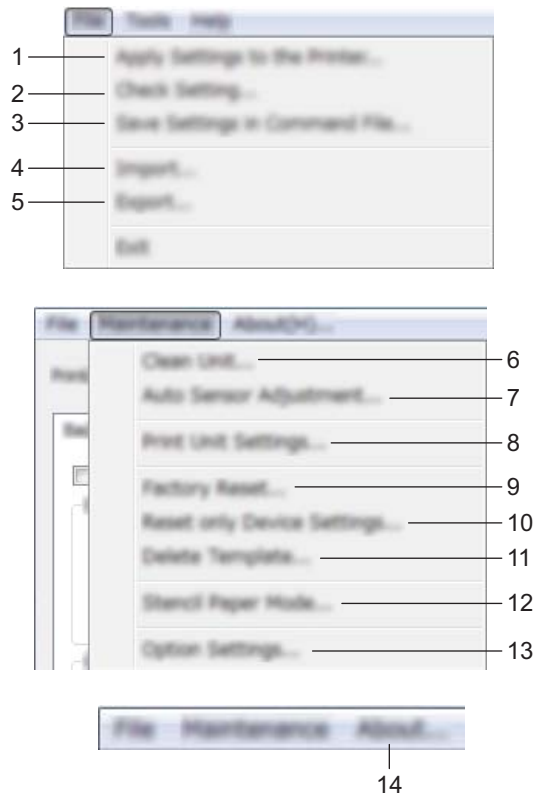

1 Apply Settings to the Printer

Applies the settings to the printer.

Performs the same operation as when the **[Apply]** button is clicked.

2 Check setting...

3 Save Settings in Command File

Saves the specified settings in a command file.

Performs the same operation as when **[Save in Command File]** is selected from the **[Apply]** drop-down menu.

4 Import

Imports the exported file.

5 Export

Saves the current settings in a file.

6 Clean Unit

Cleans the platen roller of the printer by feeding the dedicated cleaning sheet. See *Cleaning the Platen Roller* on page 94.

7 Auto Sensor Adjustment

Adjusts the paper detection sensor automatically.

8 Print Unit Settings

Prints a report containing firmware version, paper size, and configuration information, as shown below. The Bluetooth settings (PJ-762/PJ-763/PJ-763MFi only) or Wi-Fi settings (PJ-773 only) are printed on this page.

<Print image>

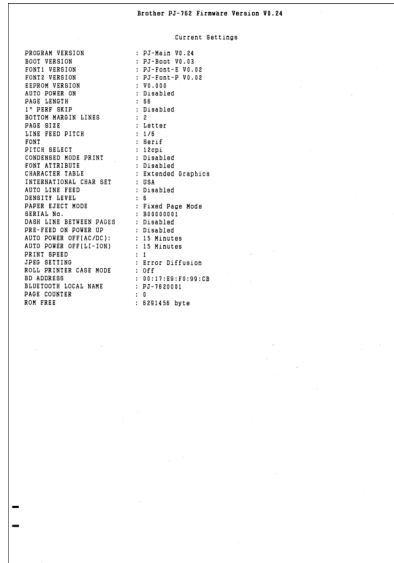

You can also print this report using the  (Feed) button (see *Confirm the Printer Settings* on page 91).

9 Factory Reset

Resets all of the printer settings to the factory settings.

10 Reset only Device Settings

Resets only the settings that can be specified using the Device Settings to the factory settings.

11 Delete Template

Deletes all the templates stored in the printer.

12 Stencil Paper Mode

13 Option Settings

If the [**Do not display an error message if the current settings cannot be retrieved at startup**] check box is selected, a message will not be displayed next time.

14 About

Displays the version information.

Settings Tabs

Basic Tab

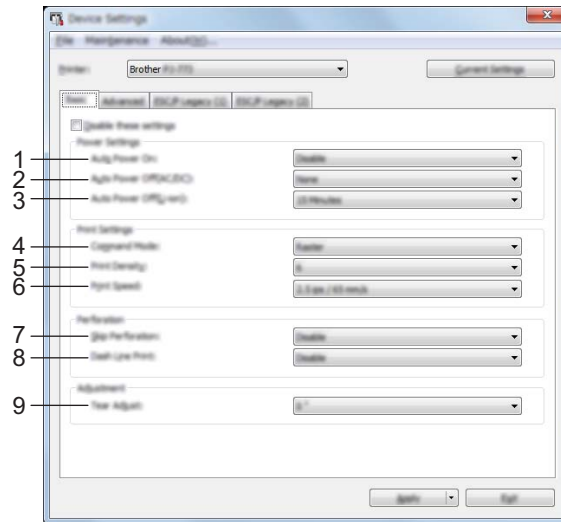

1 Auto Power On

Specifies how the printer responds when connected to an AC or DC power outlet or when the battery is installed.

Available settings: [Disable], [Enable], [Enable (No Main Button)]

2 Auto Power Off (AC/DC)

Specifies the amount of time that passes before the printer turns off automatically when connected to an AC or DC power outlet.

Available settings: [None], 1/2/3/4/5/6/7/8/9/10/15/20/25/30/40/50/60/90/120 minutes

3 Auto Power Off (Li-ion)

Specifies the amount of time that passes before the printer turns off automatically when powered by the rechargeable Li-ion battery.

Available settings: [None], 1/2/3/4/5/6/7/8/9/10/15/20/25/30/40/50/60/90/120 minutes

4 Command Mode

Specifies the printer's command format.

Available settings: [Raster], [ESC/P Legacy], [ESC/P Brother], [P-touch Template]

5 Print Density

Specifies the printing density.

Available settings: 0-10

6 Print Speed

Specifies the printing speed in inches or millimeters per second.

Available settings: [1.1 ips / 27 mm/s], [1.6 ips / 41 mm/s], [1.9 ips / 48 mm/s], [2.5 ips / 65 mm/s]

7 Skip Perforation

Leaves a one-inch (25.4 mm) margin at the top and bottom of the paper.

Use it when printing on perforated roll paper so that the printer does not print on the perforation.

Available settings: **[Enable]**, **[Disable]**

8 Dash Line Print

Prints dash lines between pages, useful when printing on roll paper. Set **[Form Feed Mode]** to **[Fixed Page]**, and then select **[Enable]**. Note that dash lines are printed on the paper; they are not punched into the paper.

Available settings: **[Enable]**, **[Disable]**

9 Tear Adjust

Adjust the tear bar tear off position for paper media.

Available settings: **[+0.08"]**, **[+0.06"]**, **[+0.04"]**, **[+0.02"]**, **[0"]**, **[-0.02"]**, **[-0.04"]**, **[-0.06"]**, **[-0.08"]**
(**[+2.0 mm]**, **[+1.5 mm]**, **[+1.0 mm]**, **[+0.5 mm]**, **[0 mm]**, **[-0.5 mm]**, **[-1.0 mm]**, **[-1.5 mm]**, **[-2.0 mm]**)



Note

For the following settings, the printer driver settings have priority:

- Print Density
- Print Speed
- Dash Line Print

Advanced Tab

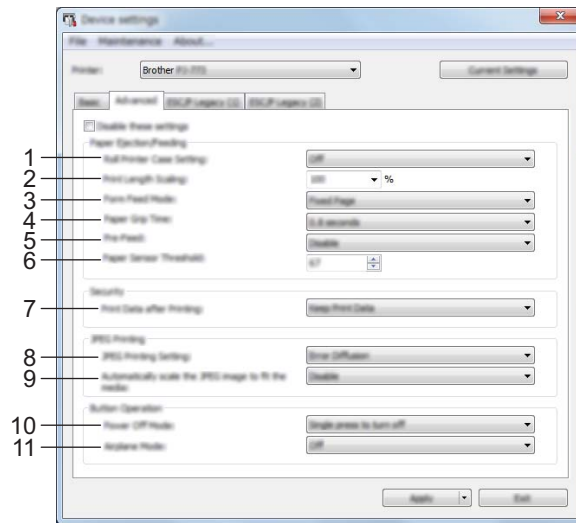

1 Roll Printer Case Setting

Specifies the setting for using the optional roll printer case. If **[On]** is selected, you can adjust the feed value or amount of paper retraction for the roll printer case.

Available settings: **[On]**, **[On (Without Anti Curl)]**, **[On (Short Feed)]**, **[Off]**

2 Print Length Scaling

Specifies the reduction or enlargement ratio for printing.

Available settings: 95% - 105% (in increments of 0.5%)

3 Form Feed Mode

Specifies how the printer responds to form feed commands received from any source.

Available settings: **[No Feed]**, **[Fixed Page]**, **[End of Page]**, **[End of Page Retract]**

For more information on the options, see *Settings That Can Be Changed Using the Windows Printer Driver (Examples)* on page 32.

4 Paper Grip Time

Specifies the delay before the printer grabs the paper.

Available settings: **[0.5 seconds]**, **[0.8 seconds]**, **[1.2 seconds]**

5 Pre-Feed

If **[Enable]** is selected, the printer ejects a short length of paper when the printer turns on. When using perforated roll paper or roll paper that is pre-printed, we recommend setting this parameter to **[Disable]**.

Available settings: **[Enable]**, **[Disable]**

6 Paper Sensor Threshold

Specifies the threshold of the paper detection sensor.

Available settings: 0-255

7 Print Data after Printing

Allows to erase print data after it is printed.

Available settings: **[Erase All Print Data]**, **[Keep Print Data]**

8 JPEG Printing Setting

Specifies the JPEG printing setting.

Available settings: [Simple Binary], [Error Diffusion]

9 Scale JPEG images to fit media

Allows enlarging or reducing a JPEG image to fit the paper size.



Available settings: [Enable], [Disable]

10 Power Off Mode

Choose how you want to turn off the printer.

Available settings: [Single press to turn off], [Double press to turn off]

11 Airplane Mode

Allows disabling the  (Bluetooth) or  (Wi-Fi) button. This function is useful when you use the printer in a place where signal transmissions are not allowed.

Available settings: [On], [Off]



Note

For the following settings, the printer driver settings have priority:

- Roll Printer Case Setting
 - Form Feed Mode
-

ESC/P Legacy (1) Tab

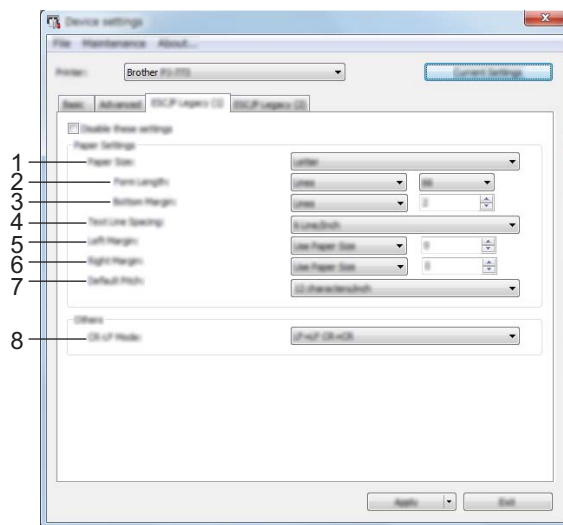

1 Paper Size

Specifies the default paper size.

Available settings: [Letter], [Legal], [A4], [Custom]



Note

If this parameter is changed in the printer driver's dialog box, that setting has priority.

2 Form Length

This parameter can be set only when [Paper Size] is set to [Custom].

Form length is determined by specifying the number of lines per page, or the length in inches of each page.

The available settings differ depending on the selected [Text Line Spacing] settings.

Text Line Spacing	Lines	Inches
[6 Lines/Inch]	6-127	1.00-21.16
[8 Lines/Inch (0.125")] or [8 Lines/Inch (0.12")]	8-127	1.00-15.87

3 Bottom Margin

The setting specified for this parameter takes effect only when [Paper Size] is set to [Custom].

The height of the bottom margin is expressed in lines of text.

The available settings differ depending on the selected [Text Line Spacing] setting.

Text Line Spacing	Lines
[6 Lines/Inch]	3-126
[8 Lines/Inch (0.125")] or [8 Lines/Inch (0.12")]	4-126

4 Text Line Spacing

Specifies the height of each line of text.

Available settings: [6 Lines/Inch], [8 Lines/Inch (0.125")], [8 Lines/Inch (0.12")]

5 **Left Margin**

Specifies the left margin.

Available settings: [**Use Paper Size**], [**Columns**]

6 **Right Margin**

Specifies the right margin.

Available settings: [**Use Paper Size**], [**Columns**]

7 **Default Pitch**

Specifies character width.

Available settings: [**10 characters/inch**], [**12 characters/inch**], [**15 characters/inch**], [**Proportional**]

8 **CR-LF Mode**

Specifies how the printer responds when LF (line feed) and CR (carriage return) commands (ASCII characters 10 and 13) are received.

Available settings: [**LF=LF CR=CR**], [**LF=CR+LF CR=CR+LF**]

ESC/P Legacy (2) Tab

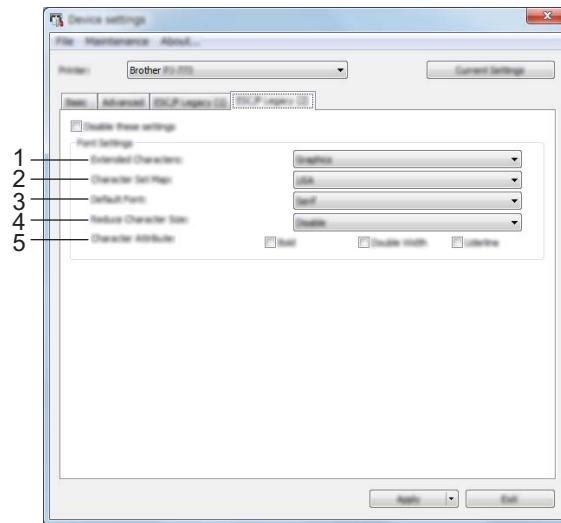

1 Extended Characters

Specifies which characters are used when printing ASCII characters 128 to 255.

Available settings: **[Italic]**, **[Graphics]**

2 Character Set Map

Specifies which character set is used, allowing you to print special characters appropriate for the language selected.

Available settings: **[USA]**, **[France]**, **[Germany]**, **[United Kingdom]**, **[Denmark I]**, **[Sweden]**, **[Italy]**, **[Spain I]**, **[Japan]**, **[Norway]**, **[Denmark II]**, **[Spain II]**, **[Latin America]**, **[Korea]**, **[Legal]**

3 Default Font

Specifies which built-in font is used.

Available settings: **[Serif]**, **[Sans Serif]**

4 Reduce Character Size

Specifies whether text is printed at a reduced size.

Available settings: **[Enable]**, **[Disable]**

5 Character Attributes

Specifies the attributes used for printed text.

Available settings: **[Bold]**, **[Double Width]**, **[Underline]**

Applying Setting Changes to Multiple Printers

- 1 After applying settings to the first printer, disconnect the printer from the computer, and then connect the second printer to the computer.
- 2 Select the newly connected printer from the **[Printer]** drop-down list.
- 3 Click the **[Apply]** button.
The same settings that were applied to the first printer are applied to the second printer.
- 4 Repeat steps 1 – 3 for all the printers whose settings you wish to change.



Note

To save the current settings in a file, click **[File]** - **[Export]**.

The same settings can be applied to another printer by clicking **[File]** - **[Import]**, then selecting the exported settings file. (See *Device Settings* on page 64.)

P-touch Template Settings

P-touch Template mode provides functions for inserting data from a device (such as a barcode reader connected to the printer) into text and barcode objects in layouts saved on the printer, useful for printing templates and barcodes.

With [**P-touch Template Settings**] in the “**Printer Setting Tool**”, settings for using the P-touch Template functions can be specified or changed.

P-touch Template

The following are the P-touch Template functions:

Basic operations

- Preset template printing

If frequently used templates are stored in the printer, they can be reprinted by simply scanning the barcode for each template.

- Barcode printing

A barcode scanned with the barcode reader can be printed with the protocol and size of a previously created template.

- Database-assisted template printing

By linking objects in a template to a database, then scanning the key barcodes for the database, the template can be printed with objects in the template replaced with database data.

Advanced operations

- Numbering function (serialized number) printing

Templates can be printed while automatically incrementing a number or barcode in the templates.



Note

If a command reference is used, see the *P-touch Template Manual/Raster Command Reference*. You can download the latest versions from the Brother support website.

support.brother.com

Select the product, and then select [**Manuals**].

P-touch Template Settings Dialog Box

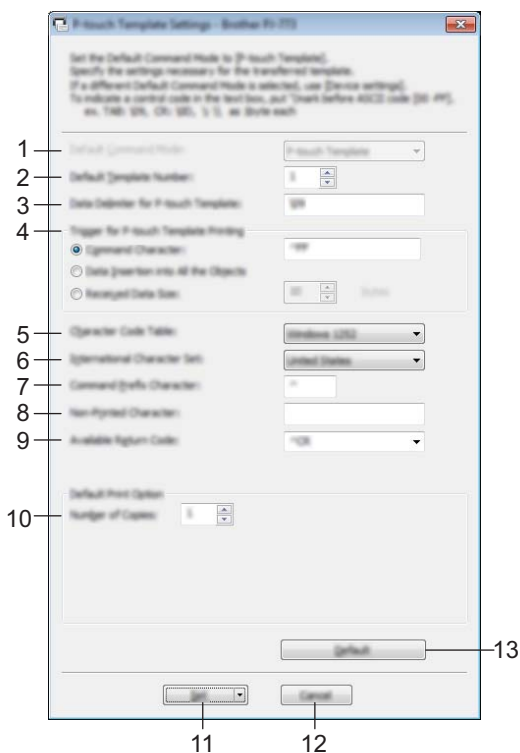

1 Default Command Mode

Specifies the P-touch Template mode as the default mode.
To change the mode, use the Device Settings.

2 Default Template Number

Specifies a template number to select as default when the printer is turned on.
However, if a template is not to be transferred to the printer, do not specify a template number.

3 Data Delimiter for P-touch Template

A symbol used to indicate when to move to the next object in the data being sent. Between 1 and 20 characters can be specified.

4 Trigger for P-touch Template Printing

You can specify a trigger to begin printing from a number of options.

[Command Character]: Printing starts when the command character specified here is received.

[Data Insertion into All the Objects]: Printing starts when the delimiter for the last object is received.

[Received Data Size]: Printing starts when the number of characters specified here is received. However, delimiters are not counted in the number of characters.

5 Character Code Table

Select one of the following three character code sets.

Available settings: **[Windows 1251]**, **[Windows 1252]**, **[Windows 1250 Eastern Europe]**, **[Brother standard]**

6 International Character Set

Lists countries for the character set.

Available settings: [United States], [France], [Germany], [Britain], [Denmark], [Sweden], [Italy], [Spain], [Japan], [Norway], [Denmark II], [Spain II], [Latin America], [Korea], [Legal]

The following 12 codes are switched depending on the country selected from the list above:

23h 24h 40h 5Bh 5Ch 5Dh 5Eh 60h 7Bh 7Ch 7Dh 7Eh

For switched characters, see the *P-touch Template Manual/Raster Command Reference* (which can be downloaded from the Brother support website).

7 Command Prefix Character

Specifies the prefix character code, which identifies commands used in P-touch Template mode.

8 Non-Printed Character

Characters specified here are not printed when data is received. Specify 1 to 20 characters.

9 Available Return Code

The line feed code is used when feeding data to indicate that the following data should be moved to the next line in a text object. One of the following four line feed codes can be selected, or 1 to 20 characters can be specified as the line feed code.

Available settings: [^CR], [\0D\0A], [\0A], [\0D]

10 Number of Copies

Sets the number of copies. A number between 1 and 99 can be specified.

11 Set

Saves the settings as an .ini file when the dialog box is closed.

To save the specified settings in a command file, select [**Save in Command File**] from the drop-down menu. The saved command file can be used with the mass storage mode to apply the settings to a printer. (See *Mass Storage Mode* on page 92.)

12 Cancel

Cancels the settings and closes the dialog box. The settings will remain unchanged.

13 Default

Returns to the factory settings.

Printer Setting Tool (for Mac Computers)

Using the "**Printer Setting Tool**", you can specify the printer's communication settings and device settings from a Mac. Not only can you change the device settings for one printer, but you can also apply the same settings to multiple printers.



Note

The "**Printer Setting Tool**" is installed at the same time as other software such as the printer driver. For more information, see *Installing the Printer Driver and Software (When Using a Windows PC or Mac)* on page 24.



Important

The "**Printer Setting Tool**" is available only with compatible Brother printers.

Before Using the Printer Setting Tool

- Make sure the AC adapter is connected to an AC power outlet, the car adapter is connected to a DC power outlet, or the fully-charged battery is installed.
- Make sure the printer driver has been installed and is functional.
- Connect this printer to a computer with a USB cable. With this tool, settings cannot be specified using Bluetooth or Wi-Fi.

Using the Printer Setting Tool (for Mac Computers)

- 1 Connect the printer you want to configure to the computer.
- 2 Click **[Macintosh HD] - [Applications] - [Brother] - [Printer Setting Tool] - [Printer Setting Tool.app]**. The **[Printer Setting Tool]** window appears.
- 3 Check that the printer you want to configure appears beside **[Printer]**. If a different printer appears, select the printer you want from the drop-down list.



Note

If only one printer is connected, it is unnecessary to make a selection since only that printer will appear.

- 4 Select a setting tab, and then specify or change the settings.
- 5 Click **[Apply Settings to the Printer]** in the setting tab to apply the settings to the printer.
- 6 Click **[Exit]** to finish specifying settings.



Important

Use the "**Printer Setting Tool**" to configure the printer only when the printer is in standby. The printer may malfunction if you attempt to configure it while it is handling a job.

Settings Dialog Box

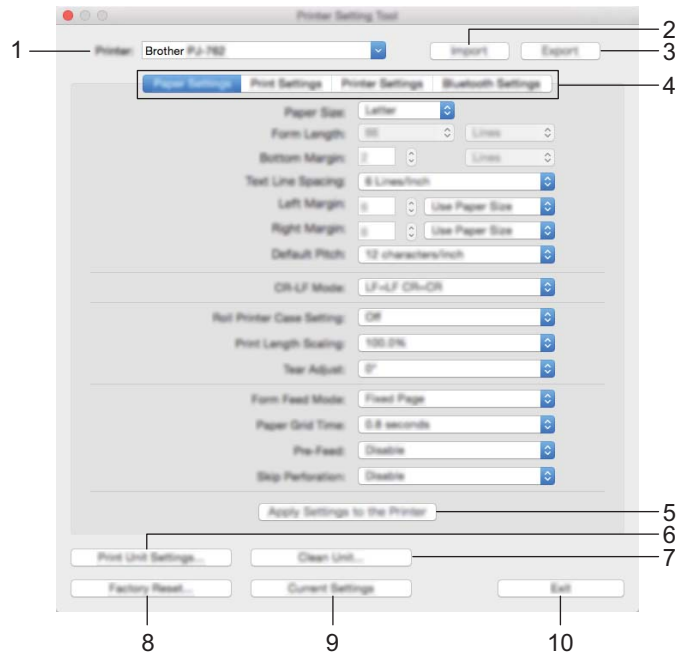

- 1 Printer**
Lists the connected printers.
- 2 Import**
Imports settings from a file.
- 3 Export**
Saves the current settings in a file.
- 4 Setting Tabs**
Contain settings that may be specified or changed.
- 5 Apply Settings to the Printer**
Applies the settings to the printer.

6 Print Unit Settings

Prints a report containing firmware version, paper size, and configuration information, as shown below. The Bluetooth settings (PJ-762/PJ-763/PJ-763MFi only) or Wi-Fi settings (PJ-773 only) are printed on this page.

<Print image>

```

Brother PJ-762 Firmware Version V9.04
-----
Current Settings
-----
PROGRAM VERSION : PJ-Main V9.04
BOOT VERSION : PJ-Boot V9.03
FONT1 VERSION : PJ-Font-F V9.02
FONT2 VERSION : PJ-Font-P V9.02
EDROM VERSION : V9.00
AUTO POWER ON : Disabled
PAGE LENGTH : 66
1" FEED REEP : Disabled
BOTTOM MARGIN LINES : 2
PAGE SIZE : Letter
LINE FEED PITCH : 1/6
FONT : Serif
PITCH SELECT : Top
CONDENSED MODE PRINT : Disabled
FONT MICROSTEP : Disabled
CHARACTER TABLE : Extended Graphics
INTERNATIONAL CHAR SET : ROM
AUTO LINE FEED : Disabled
DENSITY LEVEL : 6
PAPER EJECT MODE : Flowed Page Mode
SERIAL No. : 80030001
DASH LINE BETWEEN PAGES : Disabled
PRE-FEED ON POWER UP : Disabled
AUTO POWER OFF(ACT/DC) : 15 Minutes
AUTO POWER OFF(L1-DRM) : 15 Minutes
PRINT SPEED : 1
JOB SETTINGS :
ROLL PRINTER CASE MODE : Error Diffusion
SD ADDRESS : 001100000000
BLUETOOTH LOCAL NAME : PJ-762001
PAGE COUNTER : 0
ROM SIZE : 801456 byte
    
```

7 Clean Unit

Cleans the platen roller of the printer by feeding the dedicated cleaning sheet. See *Cleaning the Platen Roller* on page 94.

8 Factory Reset

Resets all of the printer settings to the factory settings.

9 Current Settings

Retrieves the settings from the currently connected printer and displays them in the dialog box.

10 Exit

Exits the Printer Setting Tool.

Paper Settings Tab

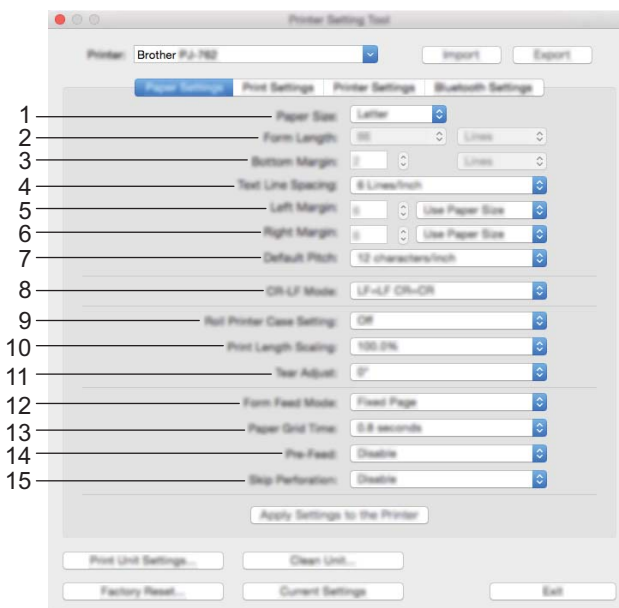

1 Paper Size

Specifies the default paper size.

Available settings: [Letter], [Legal], [A4], [Custom]

2 Form Length

This parameter can be set only when [Paper Size] is set to [Custom].

Form length is determined by specifying the number of lines per page, or the length in inches of each page.

The available settings differ depending on the selected [Text Line Spacing] settings.

Text Line Spacing	Lines	Inches
[6 Lines/Inch]	6-127	1.00-21.16
[8 Lines/Inch (0.125")] or [8 Lines/Inch (0.12")]	8-127	1.00-15.87

3 Bottom Margin

The setting specified for this parameter takes effect only when [Paper Size] is set to [Custom].

The height of the bottom margin is expressed in lines of text.

The available settings differ depending on the selected [Text Line Spacing] setting.

Text Line Spacing	Lines
[6 Lines/Inch]	3-126
[8 Lines/Inch (0.125")] or [8 Lines/Inch (0.12")]	4-126

4 Text Line Spacing

Specifies the height of each line of text.

Available settings: [6 Lines/Inch], [8 Lines/Inch (0.125")], [8 Lines/Inch (0.12")]

5 Left Margin

Specifies the left margin.

Available settings: **[Use Paper Size]**, **[Columns]**

6 Right Margin

Specifies the right margin.

Available settings: **[Use Paper Size]**, **[Columns]**

7 Default Pitch

Specifies character width.

Available settings: **[10 characters/inch]**, **[12 characters/inch]**, **[15 characters/inch]**, **[Proportional]**

8 CR-LF Mode

Specifies how the printer responds when LF (line feed) and CR (carriage return) commands (ASCII characters 10 and 13) are received.

Available settings: **[LF=LF CR=CR]**, **[LF=CR+LF CR=CR+LF]**

9 Roll Printer Case Setting

Specifies the setting for using the optional roll printer case. If **[On]** is selected, you can adjust the feed value or amount of paper retraction for the roll printer case.

Available settings: **[On]**, **[On (Without Anti Curl)]**, **[On (Short Feed)]**, **[Off]**

10 Print Length Scaling

Specifies the reduction or enlargement ratio for printing.

Available settings: 95% - 105% (in increments of 0.5%)

11 Tear Adjust

Adjust the tear bar tear off position for paper media.

Available settings: **[+0.08"]**, **[+0.06"]**, **[+0.04"]**, **[+0.02"]**, **[0"]**, **[-0.02"]**, **[-0.04"]**, **[-0.06"]**, **[-0.08"]**
([+2.0 mm], **[+1.5 mm]**, **[+1.0 mm]**, **[+0.5 mm]**, **[0 mm]**, **[-0.5 mm]**, **[-1.0 mm]**, **[-1.5 mm]**, **[-2.0 mm]**)

12 Form Feed Mode

Specifies how the printer responds to form feed commands received from any source.

Available settings: **[No Feed]**, **[Fixed Page]**, **[End of Page]**, **[End of Page Retract]**

13 Paper Grip Time

Specifies the delay before the printer grabs the paper.

Available settings: **[0.5 seconds]**, **[0.8 seconds]**, **[1.2 seconds]**

14 Pre-Feed

If **[Enable]** is selected, the printer ejects a short length of paper when the printer turns on. When using perforated roll paper or roll paper that is pre-printed, we recommend setting this parameter to **[Disable]**.

Available settings: **[Enable]**, **[Disable]**

15 Skip Perforation

Leaves a one-inch (25.4 mm) margin at the top and bottom of the paper. Use it when printing on perforated roll paper so that the printer does not print on the perforation.

Available settings: **[Enable]**, **[Disable]**

Print Settings Tab

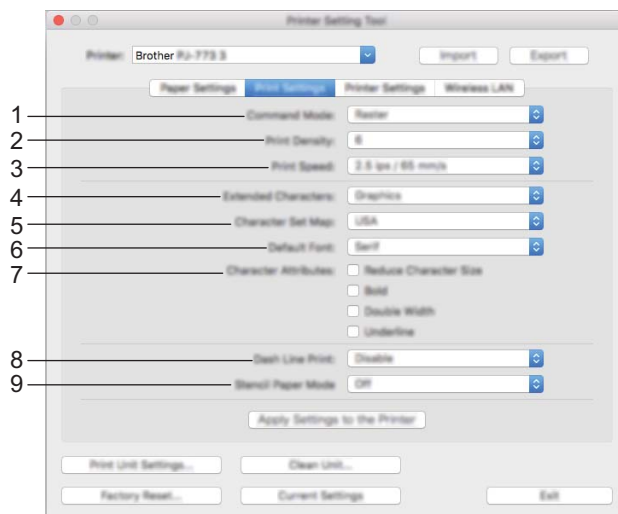

1 Command Mode

Specifies the printer's command format.

Available settings: **[Raster]**, **[ESC/P Legacy]**, **[ESC/P Brother]**, **[P-touch Template]**

2 Print Density

Specifies the printing density.

Available settings: 0-10

3 Print Speed

Specifies the printing speed in inches or millimeters per second.

Available settings: **[1.1 ips / 27 mm/s]**, **[1.6 ips / 41 mm/s]**, **[1.9 ips / 48 mm/s]**, **[2.5 ips / 65 mm/s]**

4 Extended Characters

Specifies which characters are used when printing ASCII characters 128 to 255.

Available settings: **[Italic]**, **[Graphics]**

5 Character Set Map

Specifies which character set is used, allowing you to print special characters appropriate for the language selected.

Available settings: **[USA]**, **[France]**, **[Germany]**, **[United Kingdom]**, **[Denmark I]**, **[Sweden]**, **[Italy]**, **[Spain I]**, **[Japan]**, **[Norway]**, **[Denmark II]**, **[Spain II]**, **[Latin America]**, **[Korea]**, **[Legal]**

6 Default Font

Specifies which built-in font is used.

Available settings: **[Serif]**, **[Sans Serif]**

7 Character Attributes

Specifies the attributes used for printed text.

Available settings: **[Reduce Character Size]**, **[Bold]**, **[Double Width]**, **[Underline]**

8 Dash Line Print

Prints dash lines between pages, useful when printing on roll paper. Set **[Form Feed Mode]** to **[Fixed Page]**, and then select **[Enable]**. Note that dash lines are printed on the paper; they are not punched into the paper.

Available settings: **[Enable]**, **[Disable]**

9 Stencil Paper Mode

Available settings: **[ON]**, **[OFF]**

Printer Settings Tab

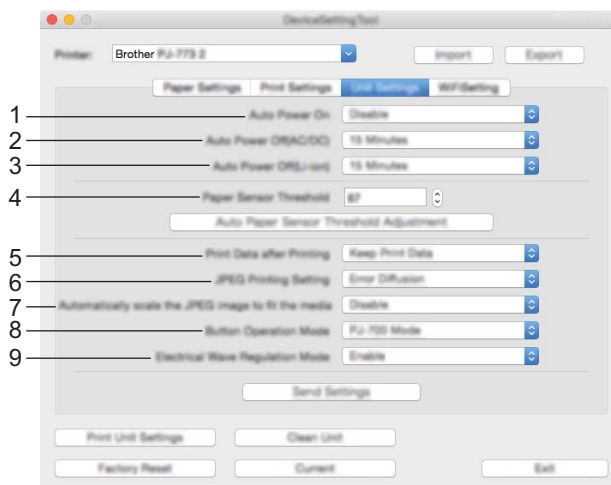

1 Auto Power On

Specifies how the printer responds when connected to an AC or DC power outlet or when the battery is installed.

Available settings: **[Disable]**, **[Enable]**, **[Enable (No Main Button)]**

2 Auto Power Off (AC/DC)

Specifies the amount of time that passes before the printer turns off automatically when connected to an AC or DC power outlet.

Available settings: **[None]**, 1/2/3/4/5/6/7/8/9/10/15/20/25/30/40/50/60/90/120 minutes

3 Auto Power Off (Li-ion)

Specifies the amount of time that passes before the printer turns off automatically when powered by the battery.

Available settings: **[None]**, 1/2/3/4/5/6/7/8/9/10/15/20/25/30/40/50/60/90/120 minutes

4 Paper Sensor Threshold

Specifies the threshold of the paper detection sensor.

Available settings: 0-255

5 Print Data after Printing

Allows to erase print data after it is printed.

Available settings: **[Erase All Print Data]**, **[Keep Print Data]**

6 JPEG Printing Setting

Specifies the JPEG print settings.

Available settings: [**Simple Binary**], [**Error Diffusion**]

7 Scale JPEG images to fit media

Allows enlarging or reducing a JPEG image to fit the paper size.



Available settings: [**Enable**], [**Disable**]

8 Power Off Mode

Choose how you want to turn off the printer.

Available settings: [**Single press to turn off**], [**Double press to turn off**]

9 Airplane Mode

Allows disabling the  (Bluetooth) or  (Wi-Fi) button. This function is useful when you use the printer in a place where signal transmissions are not allowed.

Available settings: [**On**], [**Off**]

Bluetooth Settings Tab (PJ-762/PJ-763/PJ-763MFi Only)

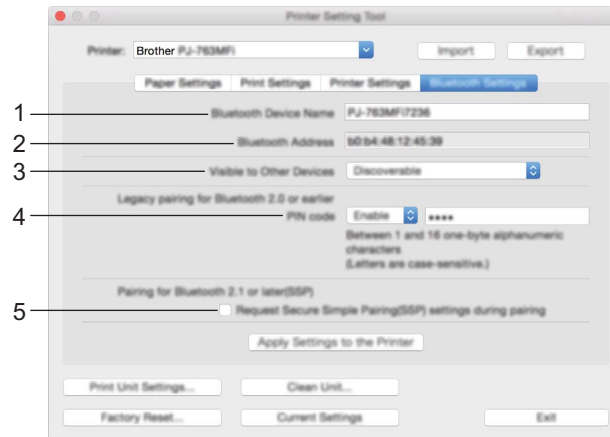

1 Bluetooth Device Name

Allows to enter the Bluetooth device name.

2 Bluetooth Address

Displays the acquired Bluetooth address.

3 Visible to Other Devices

Allows the printer to be "discovered" by other Bluetooth devices.

Available settings: [**Discoverable**], [**Not Discoverable**]

4 PIN code

Enables or disables the PIN code used when pairing with computers or mobile devices.

5 Request Secure Simple Pairing (SSP) settings during pairing

If this check box is selected, pairing can be performed using the printer buttons for devices that are compliant with Bluetooth 2.1 or later.

Wireless LAN Tab (PJ-773 Only)

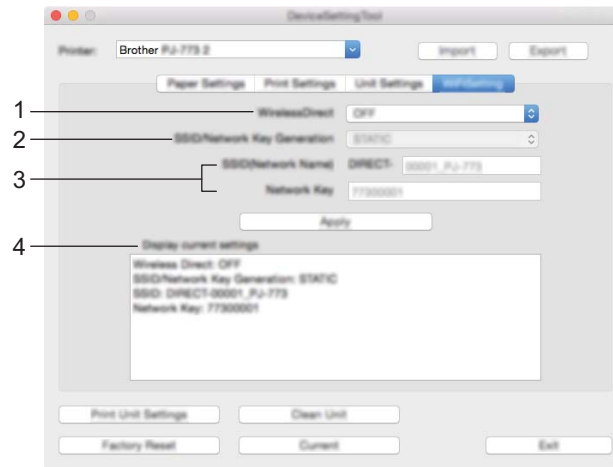

1 Wireless Direct

Turns the Wireless Direct function on or off.

2 SSID/Network Key Generation

Select [AUTO] or [STATIC].

3 SSID (Network Name)/Network Key

Specifies the SSID (3 to 25 ASCII characters) and the network key you want to use in the Wireless Direct mode.

You can only specify a setting when [STATIC] is selected as [SSID/Network Key Generation].

4 Display current settings

Displays the current settings for Wireless Direct. Click the [Current Settings] button to update the displayed settings with the most recent information.

Applying Setting Changes to Multiple Printers

- 1 After applying settings to the first printer, disconnect the printer from the computer, and then connect the second printer to the computer.
- 2 Select the newly connected printer from the **[Printer]** drop-down list.
- 3 Click the **[Apply Settings to the Printer]** button.
The same settings that were applied to the first printer are applied to the second printer.
- 4 Repeat steps 1 – 3 for all the printers whose settings you wish to change.



Note

To save the current settings in a file, click **[Export]**.

The same settings can be applied to another printer by clicking **[Import]**, then selecting the exported settings file. (See *Settings Dialog Box* on page 80.)

Changing Settings When Printing from a Mobile Device

When printing from a mobile device, change the settings as necessary using the application before printing. The settings that can be changed vary according to the application.



Note

Before connecting a mobile device, you can specify detailed settings by connecting the printer to a computer and using the Printer Setting Tool (see *Changing the Printer Settings* on page 45).

Confirm the Printer Settings

This feature is used to print a Letter-size report without connecting the printer to a computer or mobile device. (The report will fit on A4-size paper.)



Note

The printer report contains the following information: The program version, device setting information, serial number, Bluetooth setting information (for PJ-762, PJ-763 or PJ-763MFi) and Wi-Fi setting information (PJ-773 only).

To print the printer settings report:

Printing method 1

- 1 Turn the printer off.
- 2 Press and hold the  (Power) button for five seconds to print the report.

Printing method 2

- 1 Turn the printer on and make sure no paper is loaded.
- 2 Press and hold the  (Feed) button until the DATA indicator lights in red.
- 3 Insert a piece of genuine Brother thermal paper into the printer's paper input slot. The report will print automatically, and then the printer will return to idle mode.



Note

This operation can also be performed using the Printer Setting Tool (see *Changing the Printer Settings* on page 45).

Mass Storage Mode



Description

The mass storage mode allows you to execute commands and perform JPEG printing by sending data from a computer or other device to the printer via USB.

This feature is useful for:

- Applying settings stored in a command file (".bin" format), or templates in .blf format files that were distributed by the administrator without using a customized tool
- Executing or performing JPEG printing without installing the printer driver
- Using a device with an OS (including non-Windows operating systems) that has a USB host feature to print and transmit data

Using the Mass Storage Mode

- 1 Confirm that the printer is turned off.
- 2 Press the  (Feed) button and the  (Power) button at the same time.
The printer starts up in mass storage mode and the POWER and DATA indicators light in green (if the battery is used to power the printer, the POWER indicator lights in orange).
- 3 Connect the computer or device to the printer via USB.
The printer's mass storage area is displayed on the computer or device's screen.



Note

If the mass storage area is not displayed automatically, refer to the operating instructions for the computer or device's operating system for information about displaying the mass storage area.

- 4 Drag and drop the file you want to copy to the mass storage area.
- 5 Load paper and press the  (Power) button.
The commands in the command file are executed, and the DATA indicator flashes in green.
- 6 After the commands have been executed, the DATA indicator turns off.
- 7 To turn mass storage mode off, turn the printer off.
The printer will start up in its normal operating mode.



Important

- When the printer is turned off, mass storage mode is deactivated and any files in the mass storage area are deleted.
- This feature supports .bin, .blf, and .jpg files. Other file formats are not supported.
- Do not create folders in the mass storage area. If a folder is created, files in the folder will not be executed.

- The capacity of the mass storage area is 2.5 MB. Use of files larger than 2 MB cannot be guaranteed.
 - If multiple files are copied, the order that the files will be executed in cannot be guaranteed.
 - Wi-Fi and Bluetooth features are not available while the printer is running in mass storage mode.
 - Do not access other files in the mass storage area when executing a copied file.
-

JPEG Printing

You can print .jpg format images without using the printer driver.



Note

- JPEG images can be printed using the mass storage mode.
 - The Object Push Profile (OPP) or Basic Imaging Profile (BIP) is used for printing via a Bluetooth connection.
 - This printer will convert a color JPEG image to a 'Black & White' image using a dithering process.
 - When sending a JPEG image that is already 'Black & White', this dithering process may make your printed image fuzzy.
 - To improve the image quality, try to turn off any preprocessing of the JPEG image.
-

■ Only JPEG images can be printed. (Limited to files with the .jpg extension.)

■ The maximum file size is 5 MB.

■ The maximum resolutions are as follows.

Height × Width = 3300 × 2400 dots

If these limits are exceeded, the data received by the printer will be discarded and not printed.

■ 1 printed pixel = 1 dot.

■ This printer performs binary processing (simple binary) to print the image. To use **[Error Diffusion]**, open the Device Settings dialog box, and then change the **[JPEG Printing Setting]**.

■ The image is printed with the height-to-width proportion of the received data.

5

Printer Maintenance

Maintenance of the printer may be carried out as required. However, some environments (for example, dusty environments) may require more frequent maintenance.

Cleaning the Platen Roller

Dirt and debris on the platen roller can cause the paper to be fed incorrectly (skewing the print image) and degrade the print quality (distorting the print image).

Follow the procedure below to clean the platen roller:

- 1 Turn the printer on and make sure no paper is loaded.
- 2 Insert the cleaning sheet into the paper input slot. The text "CLEANING SHEET" should be upright and face the front of the printer, as shown. The roller will pull the cleaning sheet into the starting position.

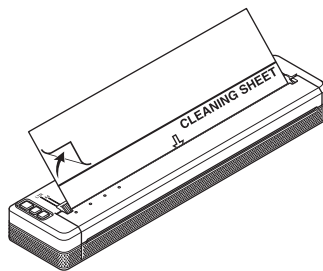

- 3 Remove the backing paper on the upper half of the cleaning sheet, as shown.

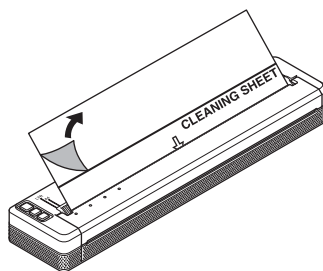

Note

Do not remove the backing paper from the lower half of the cleaning sheet.

- 4 Press the  (Feed) button for more than two seconds. The printer will feed and eject the cleaning sheet.



Note

- Do not attempt to clean the platen roller with any material other than the cleaning sheet.
- The cleaning sheet is for cleaning the platen roller only. Do not use it to clean any other part of the printer.
- Contact Brother or your Brother dealer for a replacement cleaning sheet.

Cleaning the Printer's Surface

To clean the printer's surface, wipe it with a dry cloth.

Do not use a wet cloth or allow water to enter the printer.

Do not use benzene, alcohol, paint thinner, or cleaners that are abrasive, alkaline, or acidic. Such cleaners may damage the printer's surface.

5

Clearing a Paper Jam

- 1 Carefully lift the release cover up to open it.

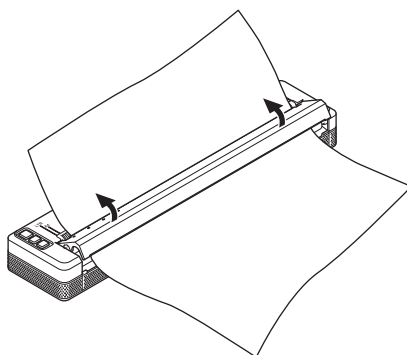

- 2 Carefully pull the paper out of the printer in either direction.

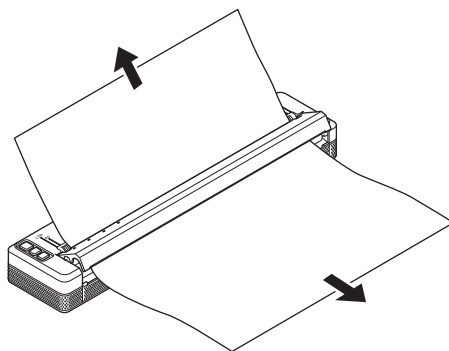

- 3 Close the release cover.
- 4 Insert paper and print again.



Application

How to Use P-touch Editor (Windows Only)	97
How to Use P-touch Transfer Manager & P-touch Library (Windows Only)	101
Transferring Templates with P-touch Transfer Express (Windows Only)	116
How to Update Printer Software Using Windows and Mac Computers	124

Using P-touch Editor

You will need to install P-touch Editor and the printer driver to use your printer with your computer.

To download the latest driver and software, please visit the Brother support website at: support.brother.com.

Using P-touch Editor

Starting P-touch Editor

1 For Windows Vista / Windows 7 / Windows Server 2008 / Windows Server 2008 R2

From the Start button, click **[All Programs] - [Brother P-touch] - [P-touch Editor]**.

When P-touch Editor starts, select whether you want to create a new layout or open an existing layout.

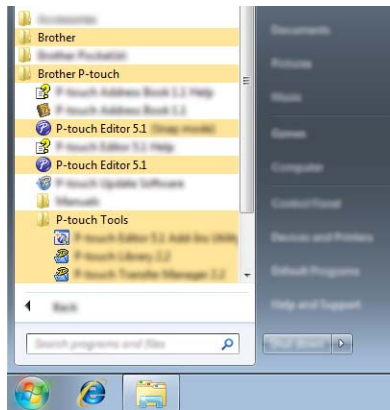

For Windows 8/ Windows 8.1 / Windows Server 2012 / Windows Server 2012 R2

Click **[P-touch Editor]** on the **[Apps]** screen or double-click **[P-touch Editor]** on the desktop.

When P-touch Editor starts, select whether you want to create a new layout or open an existing layout.

For Windows 10

From the Start button, select all applications and click **[P-touch Editor]** under **[Brother P-touch]**, or double-click **[P-touch Editor]** on the desktop.

When P-touch Editor starts, select whether you want to create a new layout or open an existing layout.



Note

- You can also start P-touch Editor using shortcuts, if you chose to create shortcuts during installation.
 - Shortcut icon on the desktop: double-click to start P-touch Editor
 - Shortcut icon in the Quick Launch bar: click to start P-touch Editor
- To change how P-touch Editor functions when it starts, click **[Tools] - [Options]** in the P-touch Editor menu bar to display the **[Options]** dialog box. On the left side, select the **[General]** heading and then the desired setting in the **[Operations]** list box under **[Startup Settings]**. The default setting is **[Display New View]**.

2 Select one of the displayed options:

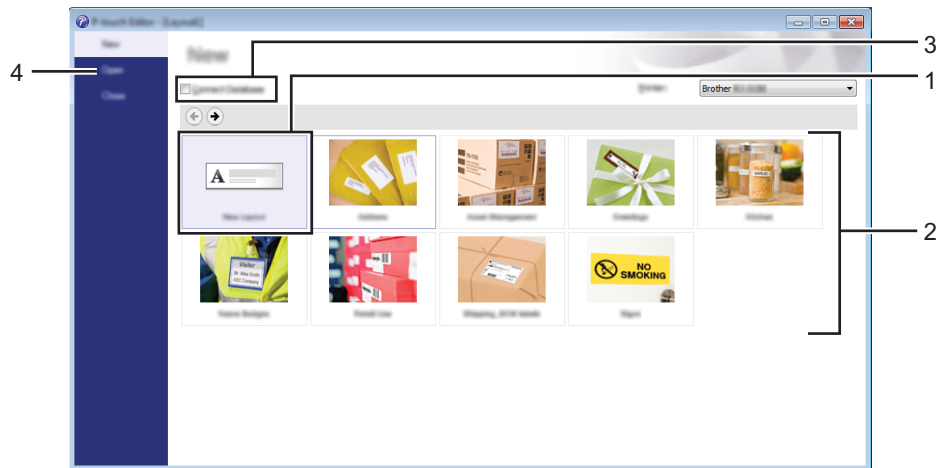

- 1 To create a new layout, double-click **[New Layout]**, or click **[New Layout]** and then click **[→]**.
- 2 To create a new layout using a preset layout, double-click a category button, or select a category button and then click **[→]**.
- 3 To connect a preset layout to a database, select the check box next to **[Connect Database]**.
- 4 To open an existing layout, click **[Open]**.

Printing with P-touch Editor

Express mode

This mode allows you to quickly and easily create layouts that include text and images.

The **[Express]** mode screen is explained below:

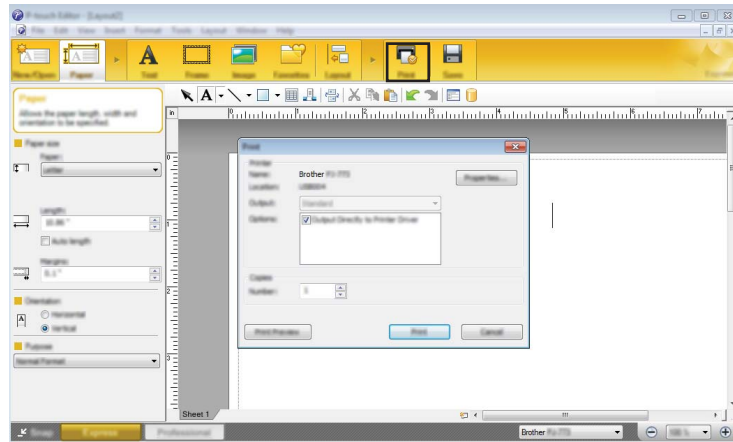

You can print by selecting **[Print]** from **[File]** in the menu bar or by clicking the **[Print]** icon. (Configure the printing settings in the **[Print]** screen before printing.)

Professional mode

This mode allows you to create layouts using a wide-range of advanced tools and options.

The **[Professional]** mode screen is explained below:

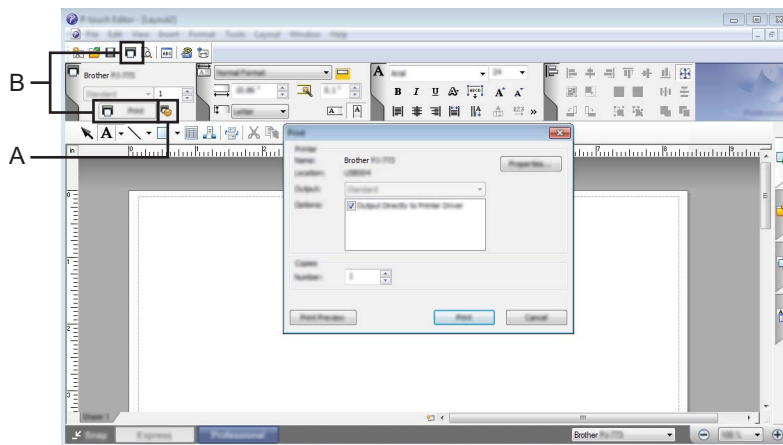

You can print by selecting **[Print]** from **[File]** in the menu bar or by clicking the **[Print]** icon (A). Configure the printing settings in the **[Print]** screen before printing.

In addition, you can click "B" to start printing without changing the printing settings.

Snap mode

This mode allows you to capture all or a portion of your computer screen display, print it as an image, and save it for future use.

- 1 Click the **[Snap]** mode selection button.
The **[Description of Snap mode]** dialog box is displayed.

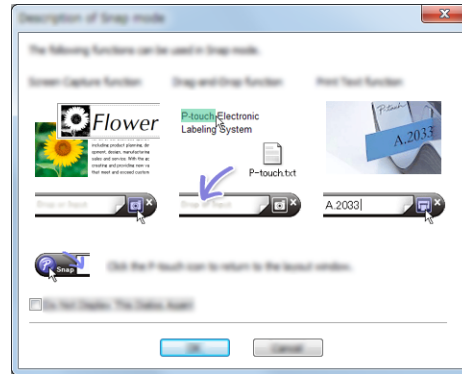

- 2 Click **[OK]**.
The **[Snap]** mode palette is displayed.



How to Use P-touch Transfer Manager & P-touch Library (Windows Only)

P-touch Transfer Manager

This program allows you to transfer templates and other data to the printer and save backups of your data on the computer.

After P-touch Transfer Manager is used to transfer data to the printer, P-touch Template is used to send text data to the printer that will be inserted into the template and printed. For more information on P-touch Template, download the *P-touch Template Manual/Raster Command Reference* (English only) from the Brother support website: support.brother.com.

[[Product Search](#)] - [[Manuals](#)]

The transfer function is needed to use P-touch Template.

The template can also be transferred via the network.

To transfer the templates via network, P-touch Transfer Manager or BRAdmin Professional can be used. BRAdmin Professional can be downloaded from our website.

P-touch Library

This program allows you to use your computer to manage P-touch Template and other data. You can use P-touch Library to print templates.

To transfer the templates via network, P-touch Transfer Manager or BRAdmin Professional can be used. BRAdmin Professional can be downloaded from our website.

Using P-touch Transfer Manager

In order to use P-touch Transfer Manager, templates created in P-touch Editor must first be transferred to P-touch Transfer Manager.

Transferring the Template to P-touch Transfer Manager

- 1 In P-touch Editor, open the template to be transferred.
- 2 Click **[File]** - **[Transfer Template]** - **[Transfer]**.

When P-touch Transfer Manager starts, the main window is displayed.



Note

The following method can also be used to start the P-touch Transfer Manager.

For Windows Vista / Windows 7 / Windows Server 2008 / Windows Server 2008 R2:

From the Start button, click **[All Programs]** - **[Brother P-touch]** - **[P-touch Tools]** - **[P-touch Transfer Manager 2.2]**.

For Windows 8 / Windows 8.1 / Windows Server 2012 / Windows Server 2012 R2:

Click **[P-touch Transfer Manager 2.2]** on the **[Apps]** screen.

For Windows 10:

From the Start button, select all applications, and then click **[P-touch Transfer Manager 2.2]** under **[Brother P-touch]**.

Main window

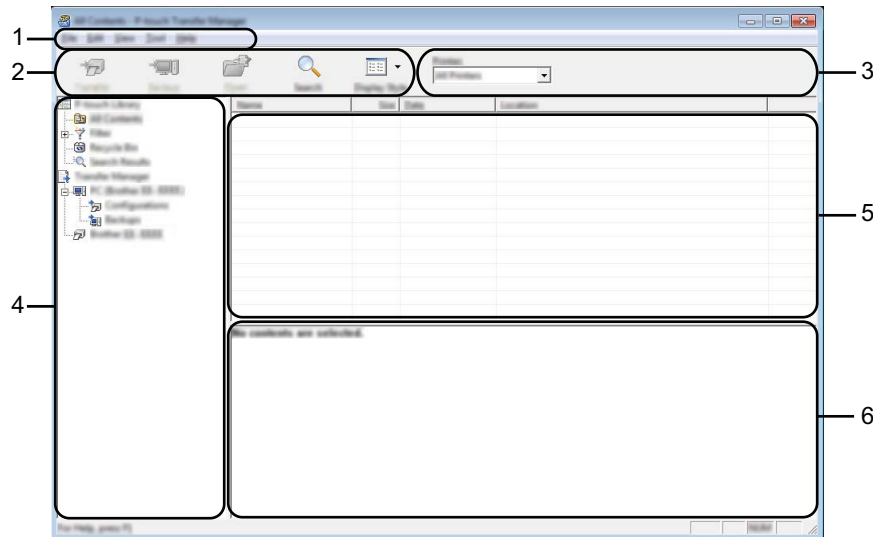

1 Menu bar

Provides access to various commands, which are grouped under each menu title ([File], [Edit], [View], [Tool], and [Help]) according to their functions.

2 Toolbar

Provides access to frequently used commands.

3 Printer selector

Allows you to select which printer the data will be transferred to. When you select a printer, only the data that can be sent to the selected printer is displayed in the data list.

4 Folder list

Displays a list of folders and printers. When you select a folder, the templates in the selected folder are displayed in the template list.

If you select a printer, the current templates and other data stored in the printer are displayed.





5 Template list

Displays a list of templates in the selected folder.

6 Preview

Displays a preview of the templates in the templates list.

Explanations of the Toolbar Icons

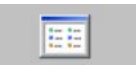
Icon	Button name	Function
	Transfer (Only for P-touch Transfer Manager)	Transfers templates and other data from the computer to the printer.
	Backup (Only for P-touch Transfer Manager)	Retrieves the templates and other data saved in the printer and saves it on the computer.
	Open	Opens the selected template.
	Print (Only for P-touch Library)	Prints the selected template with the printer.
	Search	Allows you to search for templates or other data that are registered to P-touch Library.
	Display Style	Changes the file display style.

Transferring Templates or Other Data from the Computer to the Printer via USB

Use the following procedure to transfer templates, databases and images from the computer to the printer.

! Important

Follow these instructions when the printer is connected to the computer via USB.

- 1 Connect the computer and the printer via USB and turn the printer on.
The printer model name is displayed in the folder view.
If you select a printer in the folder view, the current templates and other data stored in the printer are displayed.
- 2 Select the printer that you want to transfer the template or other data to.

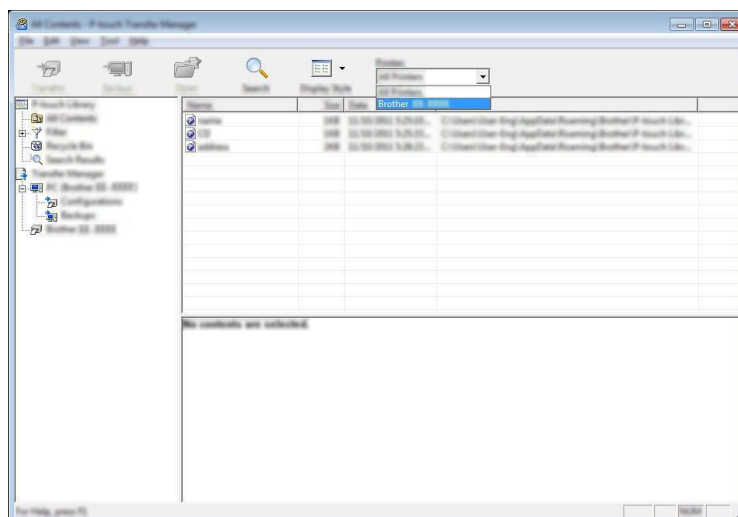

Note

Before transferring data, check that the computer and the printer are correctly connected with a USB cable and that the printer power is on.

- Right-click the **[Configurations]** folder, select **[New]**, and then create a new folder.

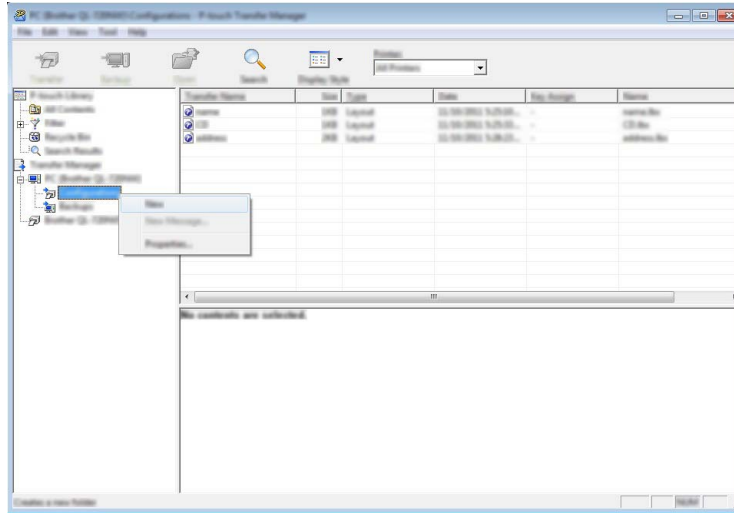

In the example above, the folder **[Transfer]** is created.

- Drag the template or other data that you want to transfer and place it in the new folder.

Transfer Function Specification

Data type	Maximum number of transferable items	Restriction details
Template	99	<ul style="list-style-type: none"> ■ Each template can contain a maximum of 255 objects.
Image (User-defined character)	99	<ul style="list-style-type: none"> ■ Only *.bmp files can be transferred. ■ Monochrome *.bmp files are recommended. ■ PJ-722/PJ-762: The size limit is 1632 × 1632 pixels. PJ-723/PJ-763/PJ-763MFi/PJ-773: The size limit is 2464 × 2464 pixels. ■ Wide images may be cropped.



Note

You can confirm the available space in the transfer file memory by printing the printer settings report (see *Confirm the Printer Settings* on page 91).
See **[ROM FREE]** in the report for the available space*.

* The available space that is displayed in "ROM FREE: ***** byte" may be different from the actual available space.

You can view the templates and other data by selecting the folder in the **[Configurations]** folder, selecting **[All Contents]** or by selecting one of the categories under **[Filter]**, such as **[Layouts]**.

When transferring multiple templates or other data, drag all the files that you want to transfer and place them in the new folder.

Each file is assigned a key number (memory location in the printer) when it is placed in the new folder.

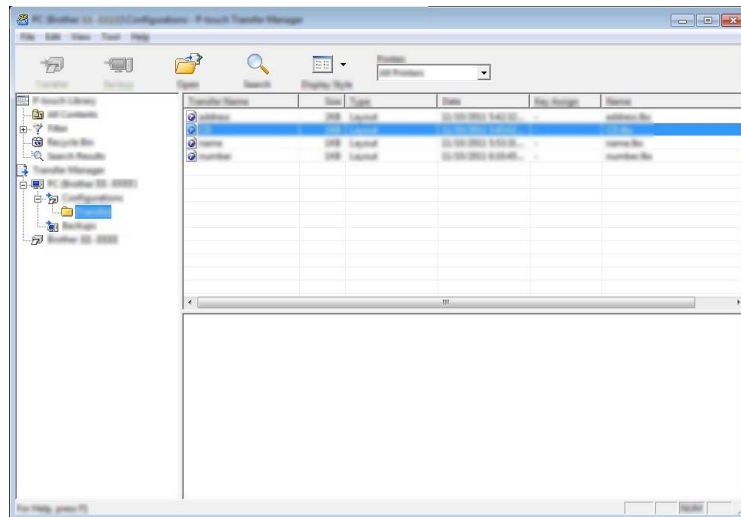

- 5 To change the key number assigned to an item, right-click the item, select **[Key Assign]**, and then select the desired key number.

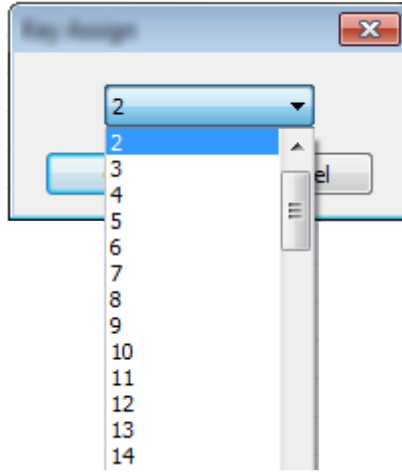

 **Note**

- Except for the data in databases, all data transferred to the printer is assigned a key number.
- If the template or other data transferred to the printer has the same key number as another template already saved in the printer, the new template will overwrite the old one. You can confirm the templates key number assignments saved in the printer by backing up the templates or other data (see *Backing up Templates or Other Data Saved in the Printer* on page 110).
- If the printer memory is full, remove one or more templates from the printer's memory (see *Backing up Templates or Other Data Saved in the Printer* on page 110).

- 6 To change the names of templates or other data that will be transferred, click on the desired item and enter the new name. The number of characters used for the template names may be limited depending on the printer model.

- 7 Select the folder containing the templates or other data that you want to transfer, and then click **[Transfer]**. A confirmation message will be displayed.

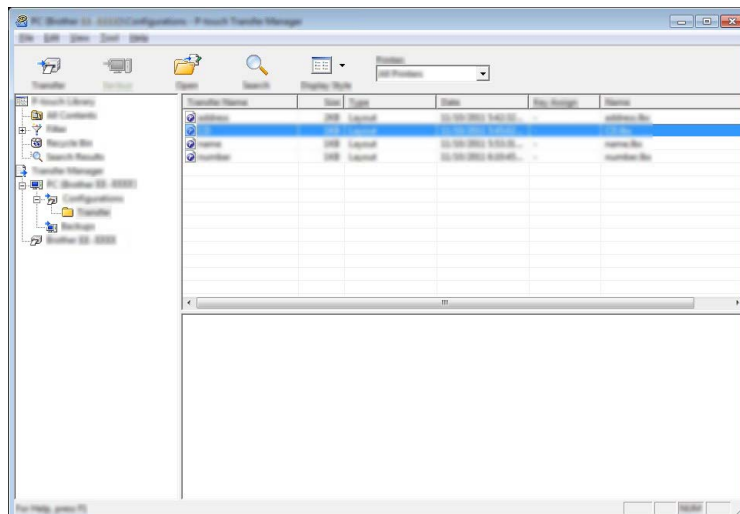

 **Note**

- You can also transfer individual items to the printer without adding them to a folder. Select the template or other data that you want to transfer, and then click **[Transfer]**.
- Multiple items and folders can be selected and transferred in one operation.

- 8 Click **[OK]**.



The selected templates, folders or other data are transferred to the printer.

Backing up Templates or Other Data Saved in the Printer

Use the following procedure to retrieve templates or other data saved in the printer and save it on the computer.

❗ Important

- Backed up templates or other data cannot be edited on the computer.
- Depending on the printer model, templates or other data backed up from one printer model may not be able to be transferred to another printer model.

- 1 Connect the computer and the printer and turn the printer on.
The printer model name is displayed in the folder view.
If you select a printer in the folder view, the current templates and other data stored in the printer are displayed.
- 2 Select the printer to back up from, and then click **[Backup]**.
A confirmation message is displayed.

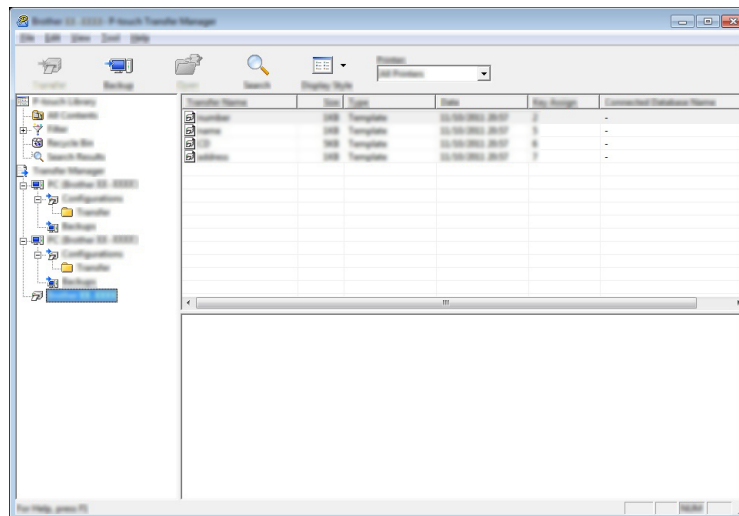

- 3 Click **[OK]**.
A new folder is created under the printer in the folder view. The folder name is based on the date and time of the backup. All of the printer's templates and other data are transferred to the new folder and saved on the computer.



Deleting All the Printer Data

Use the following procedure to delete all templates or other data that are saved in the printer.

❗ Important

This feature is only available when the computer and printer are connected via USB.

- 1 Connect the computer and the printer and turn the printer's power on.
The printer model name is displayed in the folder view.
- 2 Right-click the printer, and then select [**Delete All**].

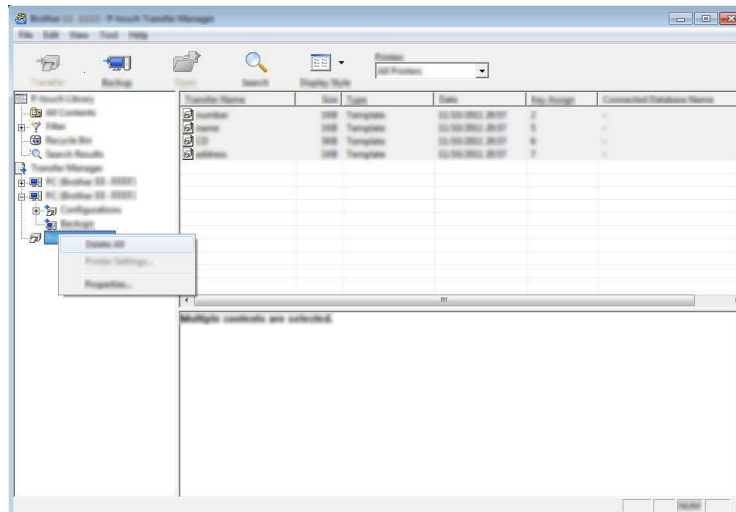

A confirmation message is displayed.

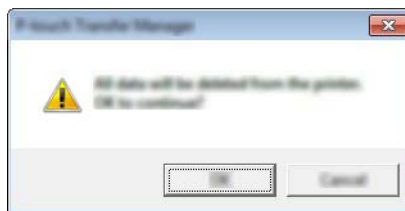

- 3 Click [**OK**].
All templates and other data saved in the printer is deleted.

Using P-touch Library

Starting P-touch Library

For Windows Vista / Windows 7 / Windows Server 2008 / Windows Server 2008 R2:

From the Start button, click [All Programs] - [Brother P-touch] - [P-touch Tools] - [P-touch Library 2.2].

For Windows 8 / Windows 8.1 / Windows Server 2012 / Windows Server 2012 R2:

Click [P-touch Library 2.2] on the [Apps] screen.

For Windows 10:

From the Start button, select all applications, and then click [P-touch Library 2.2] under [Brother P-touch].

When P-touch Library starts, the main window is displayed.

Main window

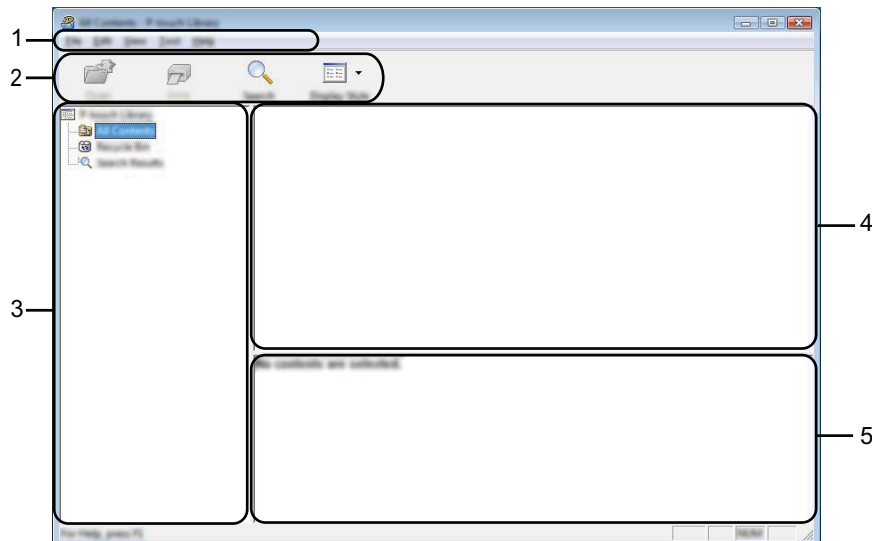

1 Menu bar

Provides access to all available commands, which are grouped under each menu title ([File], [Edit], [View], [Tool], and [Help]) according to their functions.

2 Toolbar

Provides access to frequently used commands.

3 Folder list

Displays a list of folders. When you select a folder, the templates or other data in the selected folder is displayed in the templates list.



4 Templates list

Displays a list of the templates or other data in the selected folder.

5 Preview

Displays a preview of the templates or other data selected in the templates list.

Explanations of the Toolbar Icons

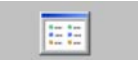
Icon	Button name	Function
	Open	Opens the selected template.
	Print (Only for P-touch Library)	Prints the selected template with the printer.
	Search	Allows you to search for templates or other data that are registered to P-touch Library.
	Display Style	Changes the file display style.

Opening and Editing Templates

Select the template you want to open or edit, and then click **[Open]**.

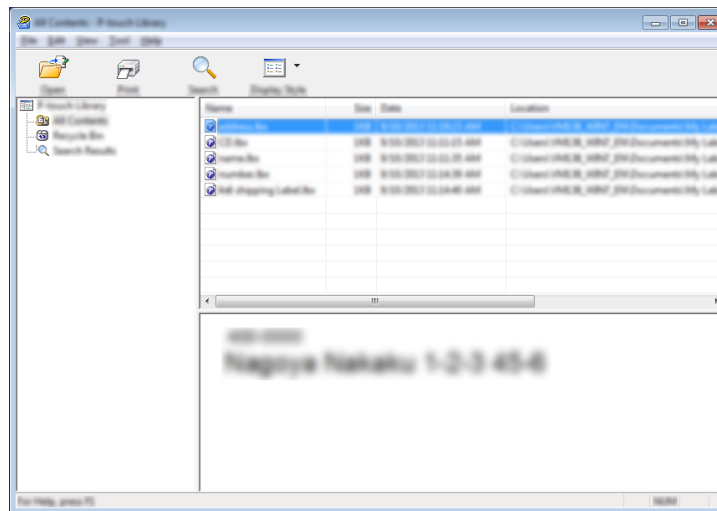

The program associated with the template will be started and you can edit the template.



Note

The program that starts depends on the type of file you selected. For example, if you select a P-touch Template, P-touch Editor starts.

Printing Templates

Select the template that you want to print and then click **[Print]**.

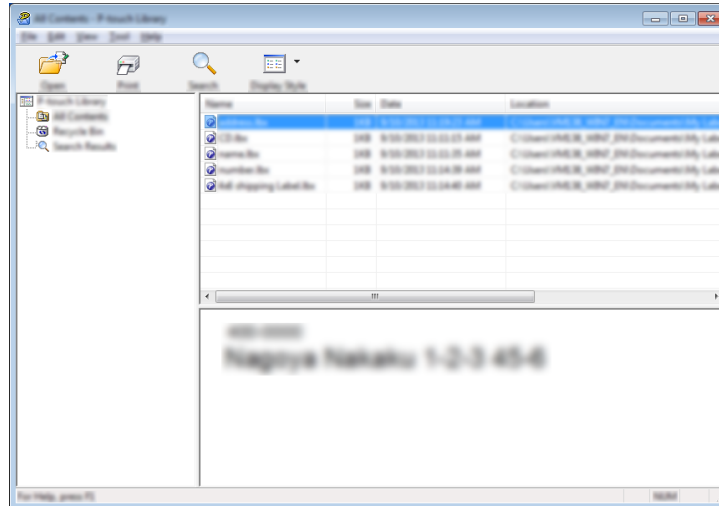

The template is printed using the connected printer.

Searching for Templates or Other Data

You can search for templates or other data registered to P-touch Library.

- 1 Click **[Search]**.
The **[Search]** dialog box is displayed.

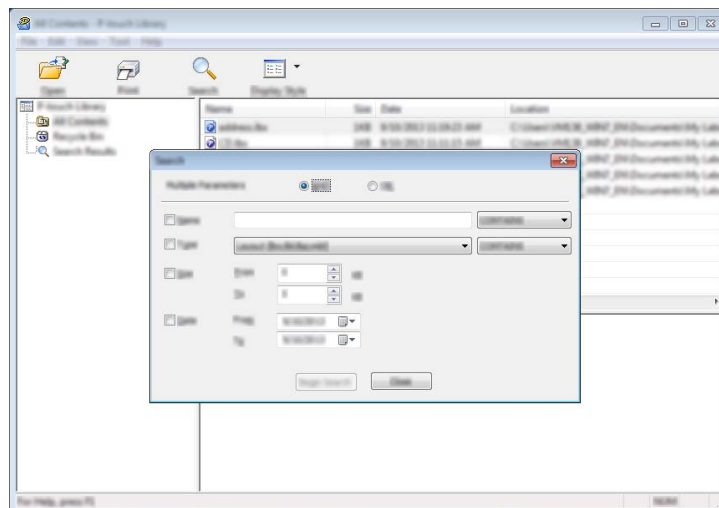

- Specify the search criteria.
The following search criteria are available:

Settings	Details
Multiple Parameters	Determines how the program searches when multiple criteria are specified. If you select [AND] , the program searches for files that satisfy all of the criteria. If you select [OR] , the program searches for files that satisfy any of the criteria.
Name	Allows you to search for a template or other data by specifying the file name.
Type	Allows you to search for a template or other data by specifying the file type.
Size	Allows you to search for a template or other data by specifying the file size.
Date	Allows you to search for a template or other data by specifying the file date.

- Click **[Begin Search]**.
The search begins.

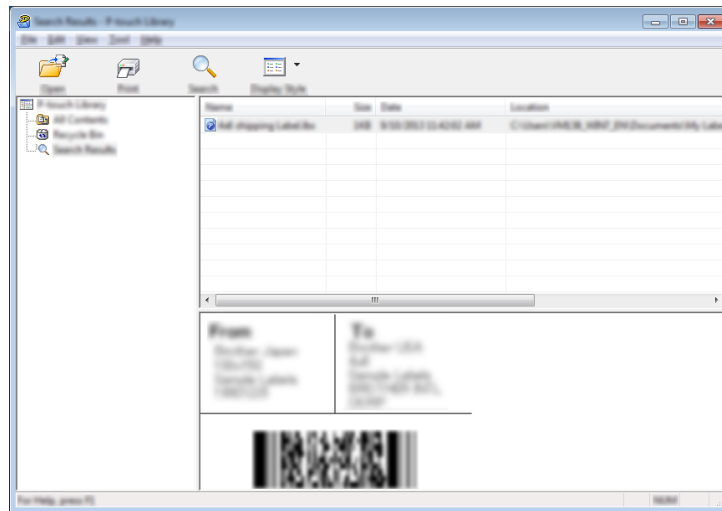

- Close the **[Search]** dialog box.
The search results can be confirmed by clicking **[Search Results]** in the folder view.

 **Note**

You can register templates or other data to P-touch Library by dragging and dropping it into the **[All Contents]** folder or to the folder list. You can also configure P-touch Editor to register templates to P-touch Library automatically, using the following procedure:

- From the P-touch Editor menu, select **[Tools]** - **[Options]**.
- In the **[Options]** dialog box, click **[Registration Settings]** in the **[General]** tab.
- Select the timing for registering templates created with P-touch Editor, and then click **[OK]**.

8

Transferring Templates with P-touch Transfer Express (Windows Only)

By using P-touch Transfer Express, one or more templates and a database can be easily transferred into a Brother printer via a local USB. After a template has been created by an administrator, it can be distributed together with P-touch Transfer Express to many users and easily transfer a template into each Brother printer locally.

Important

- If the template is to be transferred as a new one, make sure you specify a **[Key Assign]** number (in P-touch Transfer Manager) that is not currently used. If the specified **[Key Assign]** number is already being used, the existing template will be overwritten with the new one.
- This function requires a USB connection.

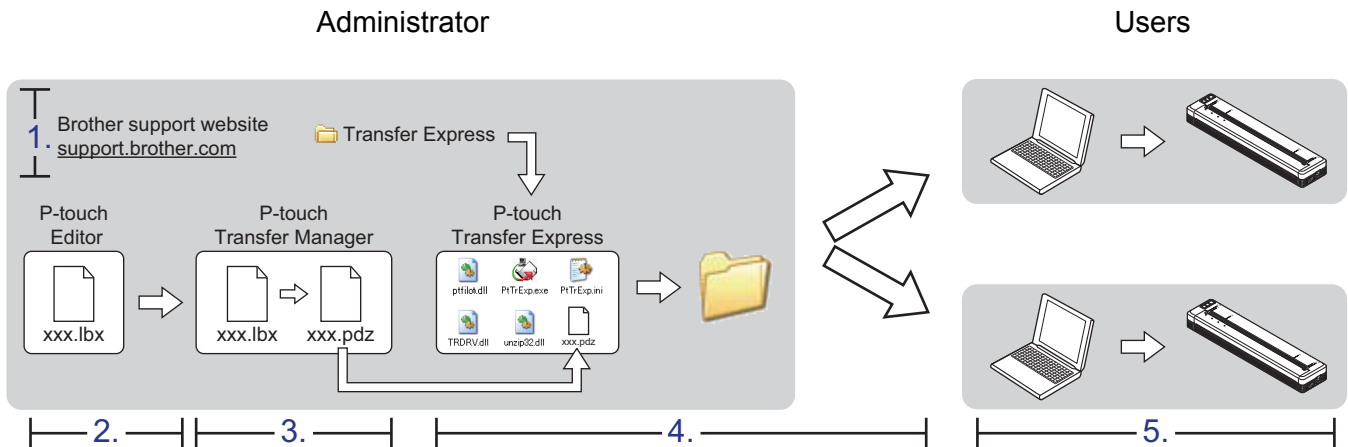

Preparing P-touch Transfer Express

The user must prepare P-touch Transfer Express for transferring templates to a printer.

Important

P-touch Transfer Express is only available in English.

- 1 You can download the latest P-touch Transfer Express from the following website.
support.brother.com
[Product Search] - **[Downloads]**
- 2 Download Transfer Express to any location on the computer.

Transferring the Template to P-touch Transfer Manager

- 1 In P-touch Editor, open the template to be transferred.
- 2 Click [File] - [Transfer Template] - [Transfer].

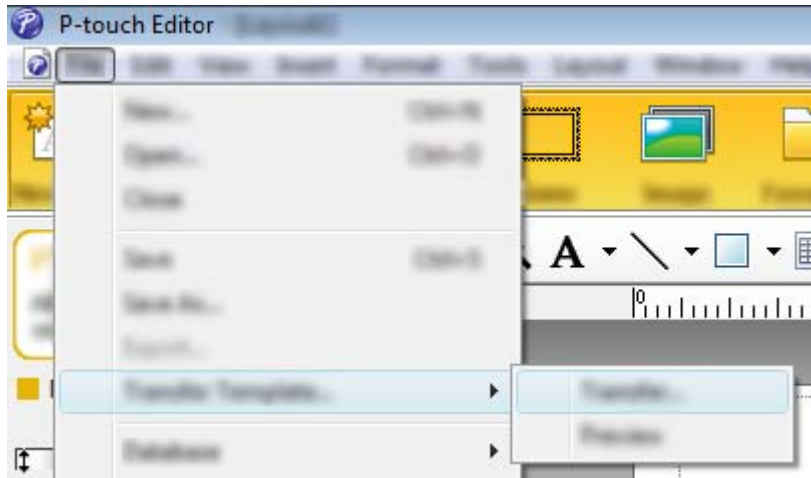

The template is transferred to P-touch Transfer Manager.
P-touch Transfer Manager automatically starts up.



Note

- **For Windows Vista / Windows 7 / Windows Server 2008 / Windows Server 2008 R2:**
The template can also be transferred to P-touch Transfer Manager by clicking the Start button - [All Programs] - [Brother P-touch] - [P-touch Tools] - [P-touch Transfer Manager 2.2] to start P-touch Transfer Manager, then dragging the .lbx file to the P-touch Transfer Manager window.
- **For Windows 8 / Windows 8.1 / Windows Server 2012 / Windows Server 2012 R2:**
The template can also be transferred to P-touch Transfer Manager by clicking [P-touch Transfer Manager 2.2] on the [Apps] screen to start P-touch Transfer Manager, then dragging the .lbx file to the P-touch Transfer Manager window.
- **For Windows 10:**
The template can also be transferred to P-touch Transfer Manager by clicking the Start button, then selecting all applications and clicking [Brother P-touch] - [P-touch Transfer Manager 2.2] to start P-touch Transfer Manager, and then dragging the .lbx file to the P-touch Transfer Manager window.

Saving the Template as a Transfer Package File (.pdz)

In order to create a file in a format that can be used by P-touch Transfer Express, save the template as a Transfer Package file (.pdz).

- 1 In the folder view, select [**Configurations**].

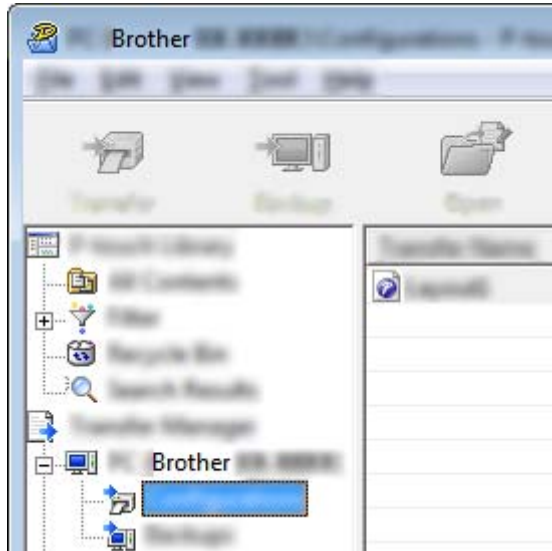

- 2 Select the template you want to distribute.



Multiple templates can be selected.

- 3 Click **[File]** - **[Save Transfer File]**.



 **Note**

- If **[Save Transfer File]** was clicked while either **[Configurations]** or a created folder is selected, all templates in the folder are saved as the Transfer Package file (.pdz).
- Multiple templates can be combined into a single Transfer Package file (.pdz).

- 4 Type in the name, and then click **[Save]**.

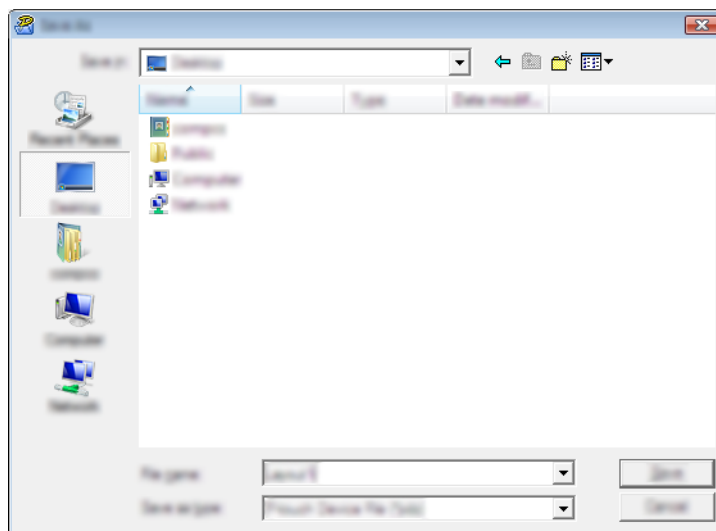

The template is saved as a Transfer Package file (.pdz).

Distributing the Transfer Package File (.pdz) and P-touch Transfer Express to the User



Note

If the user already has P-touch Transfer Express downloaded, it is not necessary for the administrator to send the Transfer Express folder to the user. In this case, the user can simply move the distributed Transfer Package file to the downloaded folder and then double-click **[PtTrExp.exe]**.

- 1 Move the Transfer Package file (.pdz) to the downloaded folder.

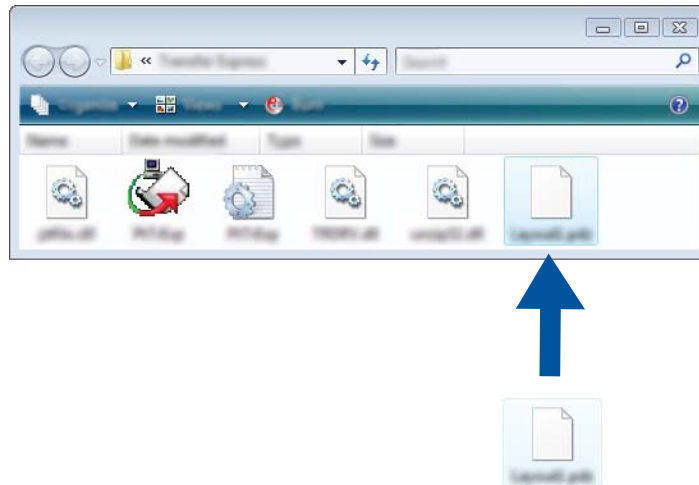

- 2 Distribute all files in the downloaded folder to the user.

Transferring the Transfer Package File (.pdz) to Your Printer

Using the P-touch Transfer Express application received from the administrator, the user can transfer the Transfer Package file (.pdz) to the printer.

! Important

Do not turn off the power when transferring templates.

- 1 Turn on the printer.
- 2 Using a USB cable, connect the printer to the computer.
- 3 Double-click [**PtTrExp.exe**], which was received from the administrator.
- 4 When there is a single Transfer Package file (.pdz) within the folder containing [**PtTrExp.exe**], click [**Transfer**].

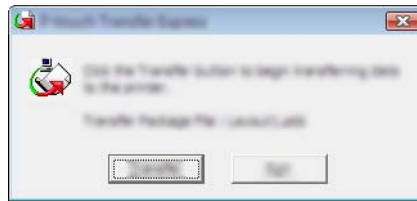

The transfer of the Transfer Package file begins.

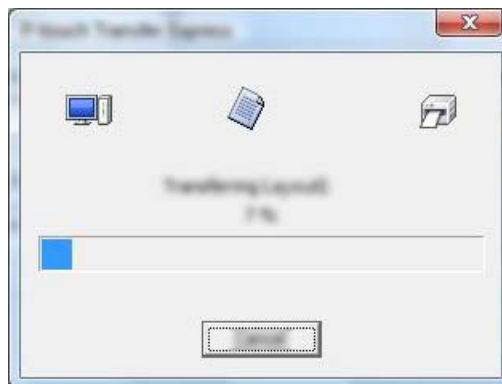

When there are either multiple or no Transfer Package files (.pdz) within the folder containing [PtTrExp.exe], click [Browse].

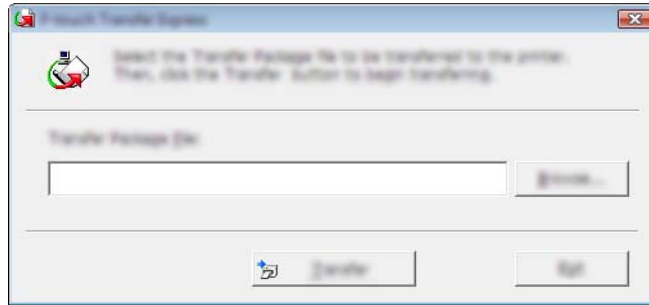

Select the Transfer Package file you want to transfer, and then click [Open].

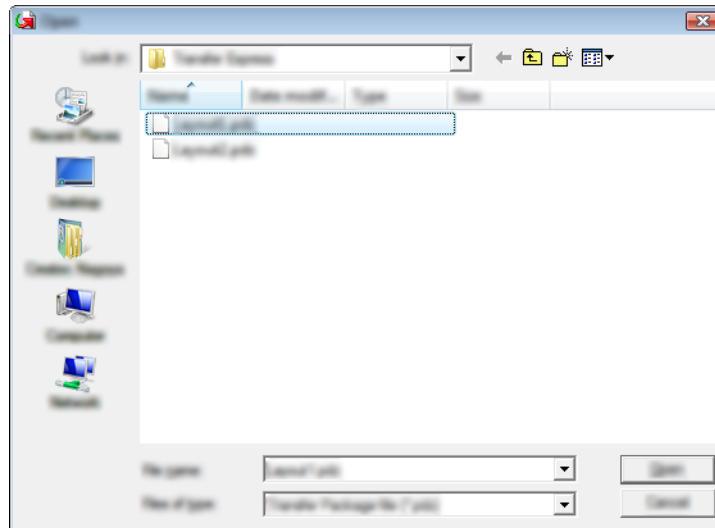

Click [Transfer].

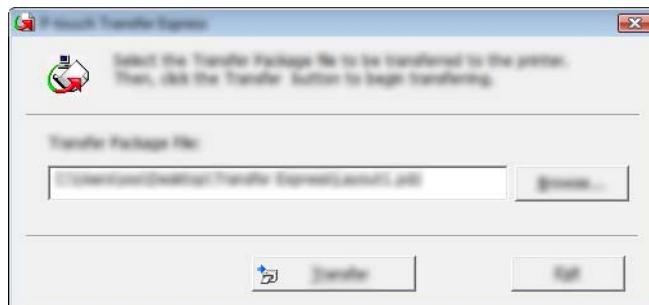

Click **[Yes]**.

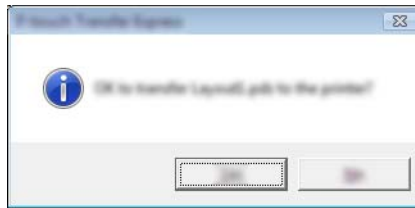

The transfer of the Transfer Package file begins.

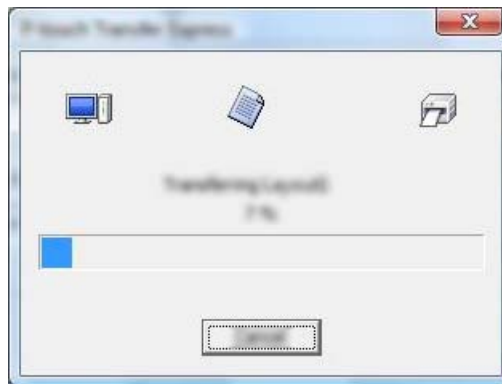

5 Click **[OK]**.

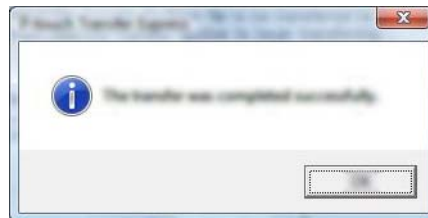

The transfer of the Transfer Package file is completed.

How to Update Printer Software Using Windows and Mac Computers

The software can be upgraded to the latest available version using this tool.

Windows is used in the following example.



Note

- To use the P-touch Update Software, download it from our website at support.brother.com and install it. The installation instructions are available on the download page.
- You must be connected to the internet in order to launch the P-touch Update Software.
- You may find that the software and the contents in this manual are different.
- Upon installation of the P-touch Update Software, an icon will be installed on your desktop for your convenience.
- Do not turn off the power when transferring data or updating firmware.

Updating P-touch Editor



1 For Windows Vista / Windows 7 / Windows Server 2008 / Windows Server 2008 R2

Double-click the [P-touch Update Software] icon.



Note

The following method can also be used to start P-touch Update Software.

Click the Start button, and then select [All Programs] - [Brother P-touch] - [P-touch Update Software].

For Windows 8 / Windows 8.1 / Windows Server 2012 / Windows Server 2012 R2

Click [P-touch Update Software] on the [Apps] screen or double-click [P-touch Update Software] on the desktop.

For Windows 10

From the Start button, select all applications and click [Brother P-touch] - [P-touch Update Software], or double-click [P-touch Update Software] on the desktop.



- 2 Click the **[Computer software update]** icon.

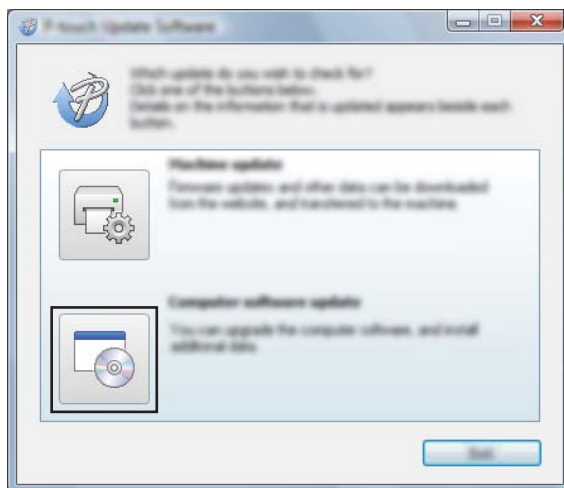

- 3 Select the **[Printer]** and **[Language]**, select the check box next to P-touch Editor and then click **[Install]**.

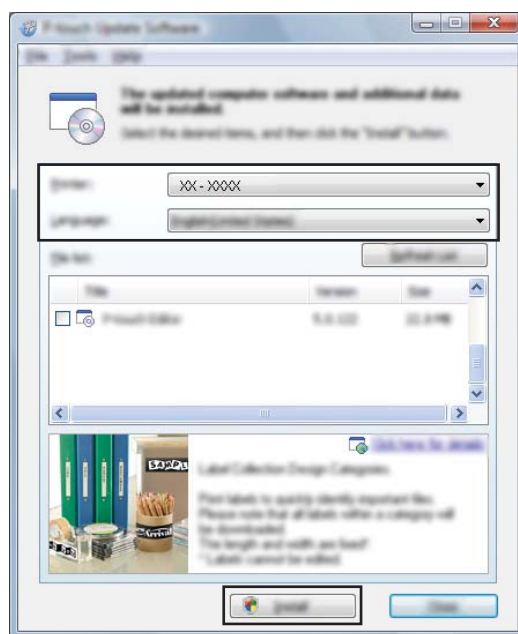

- 4 A message is displayed to indicate the installation has finished.

Updating the Firmware

❗ Important

- Do not turn off the power when transferring data or updating firmware.
- If another application is running, please exit the application.

- 1 Turn the printer on and connect the USB cable.
- 2 **For Windows Vista / Windows 7 / Windows Server 2008 / Windows Server 2008 R2**
Double-click the [P-touch Update Software] icon.

📝 Note

The following method can also be used to start P-touch Update Software.
Click the Start button, and then select [All Programs] - [Brother P-touch] - [P-touch Update Software].

For Windows 8 / Windows 8.1 / Windows Server 2012 / Windows Server 2012 R2

Click [P-touch Update Software] on the [Apps] screen or double-click [P-touch Update Software] on the desktop.

For Windows 10

From the Start button, select all applications and click [Brother P-touch] - [P-touch Update Software], or double-click [P-touch Update Software] on the desktop.



- 3 Click the [Machine update] icon.

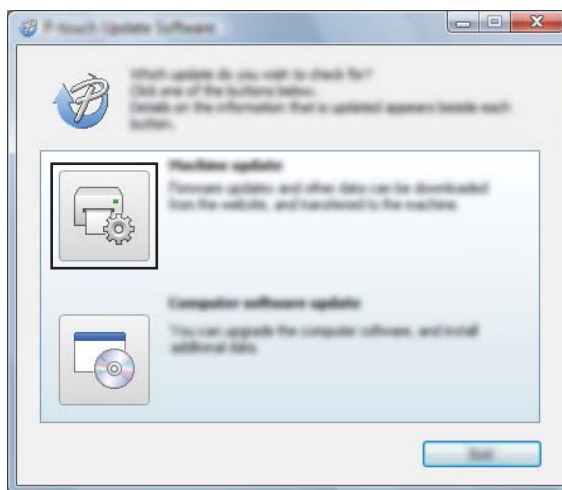

- 4 Select the **[Printer]**, ensure that **[The machine is connected correctly.]** is displayed, and then click **[OK]**.

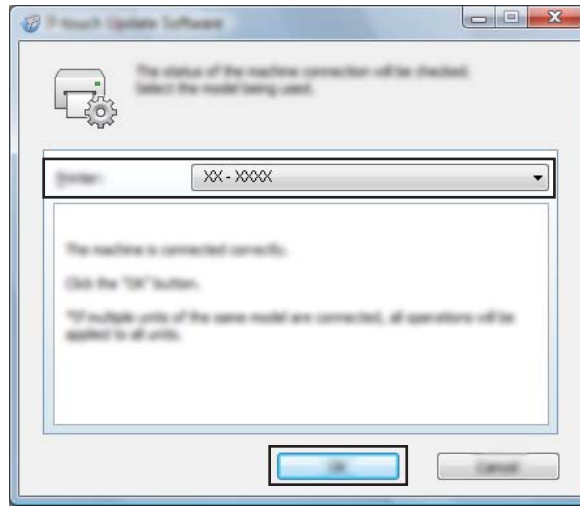

- 5 Select the **[Language]**, select the check box next to the firmware you want to update to, and then click **[Transfer]**.

! Important

Do not turn the printer off or disconnect the cable while the data is being transferred.

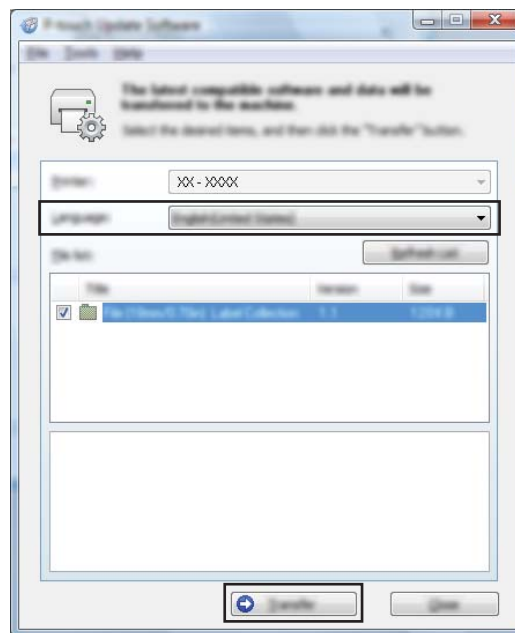

- 6 Check the content to be updated, and then click **[Start]** to begin the update. The firmware update begins.

Note

Do not turn the printer off during the update process.



Wireless Network (PJ-773 Only)

Introduction	129
Changing Your Printer's Network Settings	130
Web Based Management	133

10 Introduction

Network Features

Your printer can be shared on an IEEE 802.11b/g/n wireless network using the internal network print server. The print server supports various functions and methods of connection on a network supporting TCP/IP, depending on the operating system you are running.

Changing Your Printer's Network Settings (IP Address, Subnet Mask and Gateway) Using Windows

Using the BRAdmin Light Utility

The BRAdmin Light utility is designed for the initial setup of Brother network connectable devices. It can also search for Brother products in a TCP/IP environment, show the status and configure basic network settings, such as the IP address.

Installing BRAdmin Light

- 1 Visit our website (support.brother.com) and download the installer for the software and documents.
- 2 Double-click the downloaded .exe file and follow the on-screen instructions to proceed with the installation. In the dialog box for selecting which items to install, select BRAdmin Light.



Note

- If you require more advanced printer management, use the latest Brother BRAdmin Professional utility available as a download from the Brother support website at support.brother.com.
- If you are using firewall, anti-spyware, or antivirus software, temporarily disable them. Once you are sure that you can print, re-enable them.
- The node name appears in the current BRAdmin Light window. The default node name of the print server in the printer is "BRWxxxxxxxxxxxx". ("xxxxxxxxxxxx" is based on your printer's MAC Address / Ethernet Address.)

Setting the IP address, Subnet Mask and Gateway using BRAdmin Light

- 1 Start the BRAdmin Light utility.
 - Windows Vista / Windows 7 / Windows Server 2008 / Windows Server 2008 R2:
Click [Start] - [All Programs] - [Brother] - [BRAdmin Light] - [BRAdmin Light].
 - Windows 8 / Windows 8.1 / Windows Server 2012 / Windows Server 2012 R2:
Click the [BRAdmin Light] icon on the [Apps] screen.
 - Windows 10:
From the Start button, select all applications, and then click [BRAdmin Light] under [Brother].
- 2 BRAdmin Light will search for new devices automatically.

- 3 Double-click the unconfigured device.

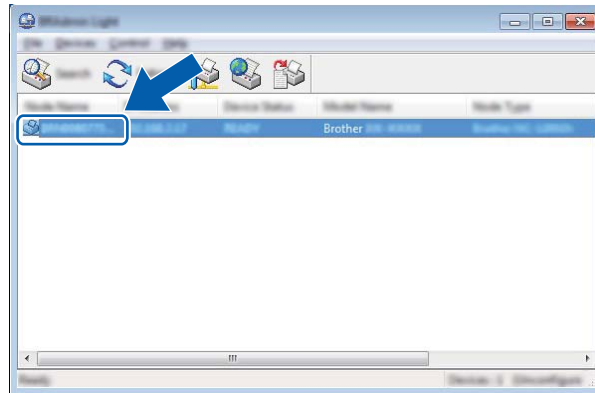

Note

If you do not use a DHCP/BOOTP/RARP server, the device will appear as [**Unconfigured**] in the BRAdmin Light utility screen.

- 4 Choose [**STATIC**] for the [**Boot Method**]. Enter the [**IP Address**], [**Subnet Mask**] and [**Gateway**] (if needed) of your print server.

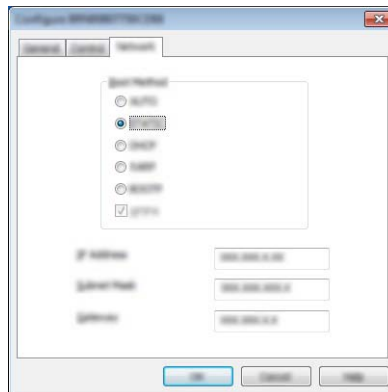

- 5 Click [**OK**].
- 6 With a correctly programmed IP address, you will see the Brother print server in the device list.

Other Management Utilities

Your printer can be used with the following management utilities in addition to the BRAdmin Light utility. You can change your network settings using these utilities.

Using the Web Based Management (Web Browser)

A standard web browser can be used to change your print server settings using the HTTP (Hyper Text Transfer Protocol). (See *Configuring the Printer Settings Using Web Based Management (Web Browser)* on page 134.)

Using the BRAdmin Professional Utility (Windows Only)

BRAdmin Professional is a utility for more advanced management of network connected Brother devices. This utility can search for Brother products on your network, and show the device status from an easy to read Explorer style window that changes color to represent the status of each device. You can configure network and device settings along with the ability to update device firmware from a Windows PC on your Local Area Network (LAN). BRAdmin Professional can also log activity of Brother devices on your network and export the log data in an HTML, CSV, TXT or SQL format.

For more information and downloads, visit us at support.brother.com.



Note

- Please use the latest version of the BRAdmin Professional utility available as a download from support.brother.com.
 - If you are using firewall, anti-spyware, or antivirus software, temporarily disable them. Once you are sure that you can print, re-enable them.
 - The node name appears in the current BRAdmin Professional window. The default node name is "BRWxxxxxxxxxxxx". ("xxxxxxxxxxxx" is based on your printer's MAC Address / Ethernet Address.)
-

Overview

You can use a standard web browser to manage a printer on your network using HTTP. When using Web Based Management, the following commands are possible:

- Display your printer status information
- Change network settings such as TCP/IP information
- Display software version information of the printer and print server
- Change network and printer configuration details



Note

We recommend Microsoft® Internet Explorer® 7.0 or later or Firefox® 25.0.1 or later.

Please make sure JavaScript and cookies are always enabled in whichever browser you use.

In order to use Web Based Management, your network must use TCP/IP, and the printer and computer must have a valid IP address.

Configuring the Printer Settings Using Web Based Management (Web Browser)

A standard web browser can be used to change your print server settings using the HTTP (Hyper Text Transfer Protocol).

- 1 In your browser's address bar, type the IP address of your printer (or print server name).
For example: `http://192.168.1.2`



Note

If you have edited the hosts file on your computer or are using a Domain Name System, you can also enter the DNS name of the print server. As the print server supports TCP/IP and NetBIOS, you can also enter the NetBIOS name of the print server. The NetBIOS name can be seen on the printer settings page. The NetBIOS name assigned is the first 15 characters of the node name and by default it will appear as "BRWxxxxxxxxxxx" where "xxxxxxxxxxx" is the Ethernet address.



- 2 You can now change the print server settings.



Note

Setting a password

We recommend setting a login password to prevent unauthorized access to the Web Based Management.

- 1 Click [**Administrator**].
 - 2 Enter the password you want to use (up to 32 characters).
 - 3 Re-enter the password in [**Confirm new password**] box.
 - 4 Click [**Submit**].
The next time you access Web Based Management, enter a password in the [**Login**] box, and then click .
- After configuring the settings, logout by clicking .

You can also set a password by clicking [**Please configure the password.**] on the printer's web page if you are not setting a login password.



Appendix

Product Specifications	136
Troubleshooting	138
Supported Protocols and Security Features	145
Network Terms and Information	146
Product Dimensions	155

13

Product Specifications

Model Name	PJ-722	PJ-723	PJ-762	PJ-763	PJ-763MFi	PJ-773
Size						
Dimensions	Approximately 10.04 (W) x 2.17 (D) x 1.18 (H) in. / 255 (W) x 55 (D) x 30 (H) mm					
Weight	Approximately 1.06 lb. / 480 g (excluding battery, paper) Approximately 1.34 lb. / 610 g (including battery, excluding paper)					
Printing						
Method	Direct thermal printing					
Print speed*	Maximum: 8 PPM					
Resolution	200 dpi	300 dpi	200 dpi	300 dpi		
Printable area (Cut Sheet)	Configure with printer driver (min. 3.73" x 1.67"/94.7 mm x 42.2 mm - max. 8.16" x 99.67"/207.2 mm x 2531.4 mm)	Configure with printer driver (min. 3.73" x 1.67"/94.8 mm x 42.3 mm - max. 8.21" x 99.67"/208.6 mm x 2531.5 mm)	Configure with printer driver (min. 3.73" x 1.67"/94.7 mm x 42.2 mm - max. 8.16" x 99.67"/207.2 mm x 2531.4 mm)	Configure with printer driver (min. 3.73" x 1.67"/94.8 mm x 42.3 mm - max. 8.21" x 99.67"/208.6 mm x 2531.5 mm)		
Paper size	A5 (5.83" x 8.27" / 148 x 210 mm), A4 (8.27" x 11.69" / 210 x 297 mm), Letter (8.5" x 11" / 216 x 279 mm), Legal (8.5" x 14" / 216 x 356 mm), infinite					
Power supply (optional)						
Battery	10.8 V					
Adapter	AC adapter (15 V)					
Car adapter	Cigarette/wired car adapter (12 V (DC))					
Battery yield*	Approximately 600 sheets					

- * These figures vary by environment. "Our standard environment" is as follows:
 JEITA J1 pattern printed continuously on A4 size paper when connected by the USB interface and the fully-charged battery is installed
 Print density=6, Environment temperature=77 °F / 25°C

Model Name	PJ-722	PJ-723	PJ-762	PJ-763	PJ-763MFi	PJ-773
Interface						
USB	USB Ver. 2.0 (Full Speed) (mini-B, Peripheral) Printer class: Mass storage (2.5 MB of memory)					
Bluetooth	—	—	Ver 2.1 + EDR Class 1 Supported profiles: SPP, OPP, BIP, HCRP		Ver 2.1 + EDR Class 1 Supported profiles: SPP, OPP, BIP, HCRP, iAP	—
Wi-Fi	—	—	—	—	—	<ul style="list-style-type: none"> ■ Wireless Direct: IEEE 802.11g/n ■ Ad-hoc Mode: IEEE 802.11b/g/n ■ Infrastructure Mode: IEEE 802.11b/g/n ■ WPS 2.0
Compatible operating systems						
See support.brother.com for a complete and updated list of software.						

Software	
Printer font size	10 cpi, 12 cpi, 15 cpi and proportional sizes
Printer font face	Serif and Sans Serif
Environment	
Operating temperature	14°F - 122°F/-10°C - 50°C
Operating humidity	20 - 80% (No condensation)
Storage temperature	-4°F - 140°F/-20°C - 60°C
Storage humidity	20 - 80% (No condensation)

PJ-763MFi Compatible List

Made for:

iPod touch (6th generation), iPod touch (5th generation), iPhone 6s Plus, iPhone 6s, iPhone 6 Plus, iPhone 6, iPhone 5s, iPhone 5c, iPhone 5, iPhone 4s, iPhone 4, iPad Pro, iPad Air 2, iPad mini 3, iPad Air, iPad mini 4, iPad mini 2, iPad mini, iPad (4th generation), iPad (3rd generation), iPad 2

Not all computers, mobile devices, and operating systems, may support Ad-hoc mode.

Overview

This chapter explains how to resolve typical problems you may encounter when using the printer. If you have any problems with the printer, first make sure you have performed the following tasks correctly:

- Install the battery or connect the printer to an AC or DC power outlet (see *Use the Rechargeable Li-ion Battery (Optional)* on page 10).
- Remove all protective packaging from the printer.
- Install and select the correct printer driver (see *Installing the Printer Driver and Software (When Using a Windows PC or Mac)* on page 24).
- Connect the printer to a computer or mobile device (see *Connect the Printer to a Computer or Mobile Device* on page 25).
- Close the release cover completely.
- Load the paper correctly (see *Loading Paper in the Printer* on page 17).









If you still have problems, read the troubleshooting tips in this chapter for help. If, after reading this chapter, you are unable to resolve your problem, visit the Brother support website at support.brother.com.

Paper Problems







Problem	Solution
The paper is jammed in the printer	See <i>Clearing a Paper Jam</i> on page 95.
The paper feeds through the printer, but nothing appears on the paper	<ul style="list-style-type: none"> ■ Make sure you are using thermal paper. ■ The print surface must face the back, when looking from the front of the printer. ■ Check the print density setting using the Printer Setting Tool (see <i>Changing the Printer Settings</i> on page 45).
The paper does not feed even though the motor is running	<p>The release cover must be completely closed.</p> <p>You must use genuine Brother thermal paper. Other paper may not feed through the printer correctly.</p> <p>If you still have problems, the printer may be damaged. Contact your Brother dealer or Brother Customer Service for assistance.</p>

Printed Image Problems

Problem	Solution
The printed image is out of alignment	<p>Make sure you are using genuine Brother thermal paper and the paper is loaded correctly (see <i>Loading Paper in the Printer</i> on page 17).</p> <p>Check whether the platen roller is dirty. If it is dirty, clean it (see <i>Cleaning the Platen Roller</i> on page 94).</p>
Print quality is poor, and the printed image is too light or too dark	<p>Adjust the print density setting in the printer driver's dialog box, or in the Printer Setting Tool (see <i>Changing the Printer Settings</i> on page 45).</p> <p>You must use genuine Brother thermal paper.</p>
The image is compressed and stretched in many places	<p>Make sure the release cover was not left open during printing. If it is open, close it completely.</p> <p>Check if the paper is slipping in the printer. If it is slipping, make sure the platen roller is clean (see <i>Cleaning the Platen Roller</i> on page 94).</p> <p>You must use genuine Brother thermal paper. Before loading paper, make sure it is not wrinkled.</p>
The top margin is incorrect	<p>Make sure the correct margins have been set in the Printer Setting Tool or your application. Adjust the top and bottom margins as needed.</p> <p>Make sure you are not forcefully inserting the paper into the paper input slot. Always insert paper carefully.</p>
The side margins are incorrect	<p>Make sure the correct margins have been set in the Printer Setting Tool or your application. Adjust the left margin as needed.</p> <p>Make sure the application, the printer, and the printer driver have been set to match the paper size of the paper that is loaded in the printer. If the application or printer driver has been set to a different paper width, the image will not be printed in the proper horizontal position. Adjust the settings as needed.</p>

Problem	Solution
The printed page contains incorrect characters	<p>Make sure you have defined the correct character set (font) in the application.</p> <p>Try changing the font used in the document.</p>
This printer is not detected when establishing a Bluetooth connection (PJ-762/PJ-763/PJ-763MFi only)	<ol style="list-style-type: none"> 1 Check that the  (Bluetooth) indicator is lit in blue. If the  (Bluetooth) indicator is flashing or turned off, the Bluetooth connection is not established. To establish a Bluetooth connection, refer to <i>Connecting Using Bluetooth (PJ-762/PJ-763/PJ-763MFi Only)</i> on page 26. 2 Check the Bluetooth settings. To print the printer settings, see <i>Confirm the Printer Settings</i> on page 91. Specify the correct Bluetooth settings in the Printer Setting Tool (see <i>Changing the Printer Settings</i> on page 45).
This printer is not detected when establishing a Wi-Fi connection (PJ-773 only)	<ol style="list-style-type: none"> 1 Check that the  (Wi-Fi) indicator is lit in blue. If the  (Wi-Fi) indicator is flashing or turned off, the Wi-Fi connection is not established. To establish a Wi-Fi connection, refer to <i>Connecting Using Wi-Fi (PJ-773 Only)</i> on page 27. 2 Check the Wi-Fi settings. To print the printer settings, see <i>Confirm the Printer Settings</i> on page 91. Consult with the network administrator and specify the correct Wi-Fi settings in the Printer Setting Tool (see <i>Changing the Printer Settings</i> on page 45).
The Wi-Fi connection is taking too long to connect (PJ-773 only)	<p>From initialization to completing the connection takes time, so it may take a minute or more to establish the Wi-Fi connection. Since this differs depending on the device and environment, check with the device manufacturer.</p>
I want to reset the printer/delete the data transferred from a computer or mobile device.	<p>To reset the printer, perform the following procedure:</p> <ol style="list-style-type: none"> 1 Confirm that the printer is turned off. 2 While holding down the  (Feed) button, press the  (Power) button three times, and then release the  (Feed) button. The POWER indicator starts flashing in orange. 3 Do one of the following: <ul style="list-style-type: none"> - Press the  (Feed) button three times to reset the printer's device settings to their factory settings and delete all the data transferred to the printer. - Press the  (Feed) button four times to reset the printer's communication and device settings to their factory settings and delete all the data transferred to the printer.

Pages Do Not Print







Problem	Solution
<p>The DATA indicator remains lit in green but the printer does not print</p>	<ul style="list-style-type: none"> ■ Printing of all received data is not completed. Wait until it is finished. ■ If paper is not loaded, load the paper. ■ If the printer does not print even though paper is loaded, remove the paper, and then load it again. ■ Try printing again after turning the printer off, and then on again. <p> Note</p> <p>If the printer is connected via Wi-Fi (PJ-773 only), the connection is lost when the printer is turned off. When the printer is turned on again, it will take up to 15 seconds for Wi-Fi to become functional.</p> <hr/> <ul style="list-style-type: none"> ■ There may be problems with sending simple ASCII text data to the printer. If the CR/LF command is not at the end of lines or the form feed command is not at the end of the last line, the printer may be waiting for this data to be sent. Print another page, or press the  (Feed) button to feed the paper. ■ The printer may have been started up in mass storage mode (see <i>Mass Storage Mode</i> on page 92). Turn the printer off, and then turn it on again.
<p>The application should be sending data to the printer, but the DATA indicator does not light in green</p>	<ul style="list-style-type: none"> ■ With a USB connection: <ol style="list-style-type: none"> 1 Connect the USB cable firmly and correctly. 2 Try using another USB cable. ■ With a Bluetooth connection (PJ-762/PJ-763/PJ-763MFi only): <ol style="list-style-type: none"> 1 Check that the  (Bluetooth) indicator is lit in blue. <p>If the  (Bluetooth) indicator is flashing or turned off, the Bluetooth connection is not established. To establish a Bluetooth connection, refer to <i>Connecting Using Bluetooth (PJ-762/PJ-763/PJ-763MFi Only)</i> on page 26.</p> 2 Specify the correct Bluetooth settings in the Printer Setting Tool (see <i>Changing the Printer Settings</i> on page 45). ■ With a Wi-Fi connection (PJ-773 only): <ol style="list-style-type: none"> 1 Check that the  (Wi-Fi) indicator is lit in blue. <p>If the  (Wi-Fi) indicator is flashing or turned off, the Wi-Fi connection is not established. To establish a Wi-Fi connection, refer to <i>Connecting Using Wi-Fi (PJ-773 Only)</i> on page 27.</p> 2 Specify the correct Wi-Fi settings in the Printer Setting Tool (see <i>Changing the Printer Settings</i> on page 45).

Pages Are Partially Printed

Problem	Solution
The DATA indicator turns off while a page remains in the printer	<ul style="list-style-type: none"> ■ The computer or mobile device may not have sent a full page of data. Try printing the document again. ■ The computer or mobile device may have sent the wrong page size information, or the size of the loaded paper is wrong. Check the paper size settings in the application, the Printer Setting Tool, and printer driver to make sure the specified paper size matches the paper that is loaded. ■ Make sure the [Form Feed Mode] setting in the Printer Setting Tool or printer driver is not set to [No Feed]. ■ Try pressing the  (Feed) button to feed the paper manually.
The printer ejects a partially printed page, and the DATA indicator remains lit or flashing in green	Use the correct paper size setting.



Network Setup Problems

Problem	Solution
You are using security software	<ul style="list-style-type: none"> ■ Confirm your settings in the installation dialog box. ■ Allow access when the security software alert message appears during the printer installation.
Your security settings (SSID/Network Key) are incorrect	<p>Recheck and choose the correct security settings.</p> <ul style="list-style-type: none"> ■ The manufacturer's name or model number of the Wi-Fi access point/router may be used as the default security settings. ■ See the instructions supplied with your Wi-Fi access point/router for information on how to find the security settings. ■ Ask the manufacturer of your Wi-Fi access point/router or ask your Internet provider or network administrator.
Your printer is placed too far from your mobile device	Move your printer within about 3.3 feet (1 meter) of the mobile device when you configure the Wi-Fi network settings.
There are obstructions (walls or furniture, for example) between your printer and the mobile device	Move your printer to an obstruction-free area.
A wireless computer, Bluetooth supported device, microwave oven or digital cordless phone is near the printer or the Wi-Fi access point/router	Move other devices away from the printer.
You are using MAC Address filtering	You can confirm the MAC address by printing the printer settings report. See <i>Confirm the Printer Settings</i> on page 91 for more information.

Problem	Solution
Your Wi-Fi access point/router is in stealth mode (not broadcasting the SSID)	<ul style="list-style-type: none"> ■ You should enter the correct SSID name during the installation or when using the Printer Setting Tool. ■ Check the SSID name in the instructions supplied with your Wi-Fi access point/router and reconfigure the Wi-Fi settings.
Your printer is not connected correctly to the network	<p>For PJ-773, check the Wi-Fi indicator on the printer.</p> <p> : The network is correctly connected.</p> <p> (flashes once every three seconds): The network is not connected correctly, and the Wi-Fi settings must be reconfigured.</p>
I have checked and tried all of the above, but still cannot complete the Wi-Fi settings	Turn the printer off, and then turn it on again. Then try and configure the Wi-Fi settings again.
If the Bluetooth connection to my Apple device (iPad, iPhone, or iPod touch) is interrupted, I cannot reconnect to the printer. (PJ-763MFi only)	<p>Enable or disable the Bluetooth Auto re-pairing function.</p> <p>Confirm that the Bluetooth function is turned on.</p> <p>Press and hold the  (Bluetooth) button for 5 seconds.</p> <p>If the function is turned off, the  (Bluetooth) indicator turns off, and then the printer turns off.</p> <p>If the function is turned on, the  (Bluetooth) indicator flashes once, and then the printer turns off.</p> <p> Note _____ You can also set it from the Printer Setting Tool.</p>

Printer Cannot Print over the Network Printer Is Not Found on the Network Even after Successful Installation



Problem	Solution
You are using security software	See <i>Security Software Problems</i> on page 144.
Your printer is not assigned with an available IP address	<ul style="list-style-type: none"> ■ Confirm the IP address and the Subnet Mask. Verify that both the IP addresses and Subnet Masks of your computer and your printer are correct and located on the same network. For more information on how to verify the IP address and the Subnet Mask, ask the network administrator. ■ Confirm your IP address, Subnet Mask and other network settings using the Printer Setting Tool. See <i>Changing the Printer Settings</i> on page 45.

Problem	Solution
Your previous printing job failed	<ul style="list-style-type: none"> ■ If the failed printing job is still in your computer's print queue, delete it. <p>When using Windows 7:</p>  , [Devices and Printers] and select your printer from [Printers and Faxes]. Double-click your printer's icon, and then choose [Cancel All Documents] in the [Printer] menu.
Your printer is not connected correctly to the network	<p>For PJ-773, check the Wi-Fi indicator on the printer.</p> <p> : The network is correctly connected.</p> <p> (flashes once every three seconds): The network is not connected correctly, and the Wi-Fi settings must be reconfigured.</p>
I have checked and tried all of the above, but my printer does not print	Uninstall the printer driver and the software, and then reinstall them.

Security Software Problems

Problem	Solution
You did not choose to allow access when the security alert dialog box appeared during either the standard installation, BRAdmin Light installation, or when printing	If you did not choose to allow access when the security alert dialog box appeared, the firewall function of your security software may be blocking access. Some security software might block access without showing a security alert dialog box. To allow access, see the instructions of your security software or ask the manufacturer.
Incorrect port numbers are being used for the Brother network features	<p>The following port numbers are used for Brother network features:</p> <ul style="list-style-type: none"> ■ BRAdmin Light → Port number 161 / Protocol UDP <p>For more information on how to open the port, see the instructions for the security software or ask the manufacturer.</p>

Checking the Operation of Network Devices

Problem	Solution
Your printer and Wi-Fi access point/router are not turned on	Make sure you have performed all of the tasks on page 138.
I do not know my printer's network settings, such as the IP address	Check the Printer Setting Tool (see <i>Changing the Printer Settings</i> on page 45).
Your printer is not connected correctly to the network	<p>For PJ-773, check the Wi-Fi indicator on the printer.</p> <p> : The network is correctly connected.</p> <p> (flashes once every three seconds): The network is not connected correctly, and the Wi-Fi settings must be reconfigured.</p>

Interface	Wireless	IEEE 802.11b/g/n (Infrastructure Mode/Ad-hoc Mode) IEEE 802.11g/n (Wireless Direct Mode)
Network (common)	Protocol (IPv4)	ARP, RARP, BOOTP, DHCP, APIPA (Auto IP), mDNS, WINS, NetBIOS name resolution, DNS Resolver, LPR/LPD, Custom Raw Port/Port9100, FTP Server, TFTP client and server, SNTP client, ICMP, LLMNR responder, SNMPv1/v2c
	Protocol (IPv6)	NDP, RA, DNS Resolver, LPR/LPD, mDNS, Custom Raw Port/Port9100, FTP Server, SNMPv1, TFTP client and server, ICMP, LLMNR responder, SNMPv1/v2c
Network (Security)	Wireless	WEP 64/128 bit, WPA/WPA2-PSK, LEAP, EAP-FAST, PEAP, EAP-TTLS, EAP-TLS

Types of Network Connections and Protocols

You will find basic information about the advanced network features of the Brother printer, along with general networking and common terms.

The supported protocols and network features differ depending on the model you are using.

Types of Network Connections

Peer-to-Peer printing using TCP/IP

In a Peer-to-Peer environment, each computer directly sends and receives data to each device. There is no central server controlling file access or printer sharing.

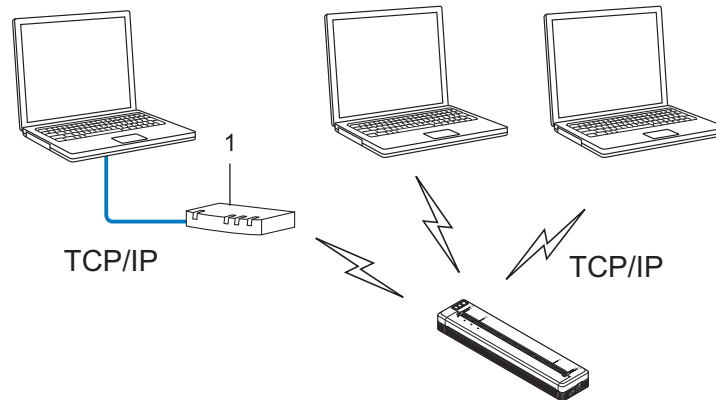

1 Router

- In a smaller network of two or three computers, we recommend the Peer-to-Peer printing method as it is easier to configure than the Network Shared printing method. See *Network Shared printing* on page 147.
- Each computer must use the TCP/IP Protocol.
- Your printer needs an appropriate IP address configuration.
- If you are using a router, the Gateway address must be configured on the computers and your printer.

Network Shared printing

In a Network Shared environment, each computer sends data via a centrally controlled computer. This type of computer is often called a “Server” or a “Print Server”. Its job is to control the printing of all print jobs.

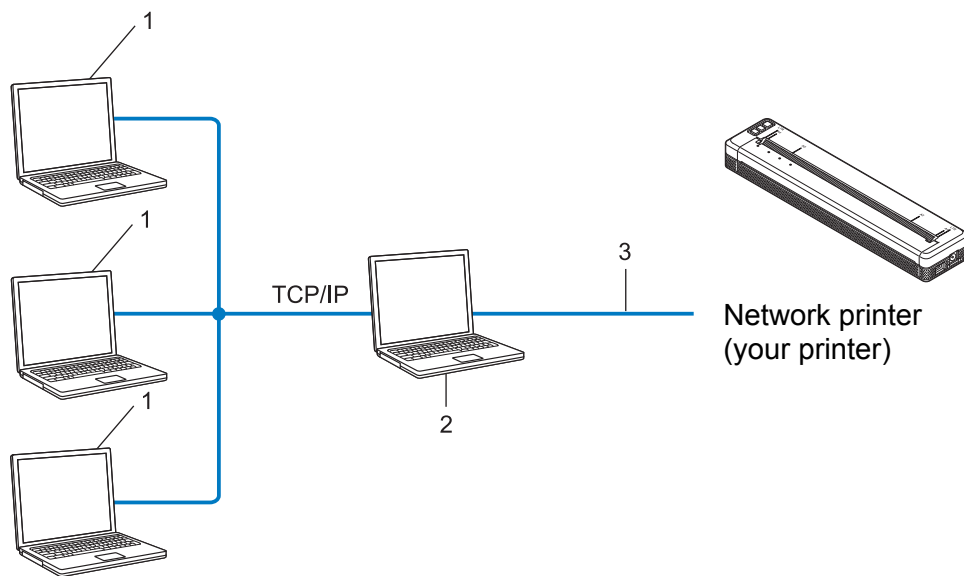

1 Client computers

2 Also known as “Server” or “Print server”

3 TCP/IP or USB

- In a larger network, we recommend using a Network Shared printing environment.
- The “server” or the “print server” must use the TCP/IP print protocol.
- Your printer needs to have an appropriate IP address configuration, except when the printer is connected via the USB interface to the server.

Configuring Your Printer for a Network

IP Addresses, Subnet Masks and Gateways

To use the printer in a networked TCP/IP environment, you need to configure its IP address and subnet mask. The IP address you assign to the print server must be on the same logical network as your host computers. If it is not, you must correctly configure the subnet mask and the gateway address.

IP address

An IP address is a series of numbers that identifies each device connected to a network. An IP address consists of four numbers separated by dots. Each number is between 0 and 254.

■ For example in a small network, you would normally change the final number:

- 192.168.1.1
- 192.168.1.2
- 192.168.1.3

How the IP address is assigned to your print server:

If you have a DHCP/BOOTP/RARP server on your network, the print server will automatically obtain its IP address from that server.



Note

On smaller networks, the DHCP server may also be the router.

If you do not have a DHCP/BOOTP/RARP server, the Automatic Private IP Addressing (APIPA) protocol will automatically assign an IP address from the range 169.254.0.1 to 169.254.254.254. The subnet mask is automatically set to 255.255.0.0 and the gateway address is set to 0.0.0.0.

By default, the APIPA protocol is enabled. If you want to disable the APIPA protocol, you can disable it using BRAdmin Light or Web Based Management (web browser).

Subnet mask

Subnet masks restrict network communication.

■ For example, Computer 1 can talk to Computer 2

- Computer 1

IP Address: 192.168.1.2

Subnet Mask: 255.255.255.0

- Computer 2

IP Address: 192.168.1.3

Subnet Mask: 255.255.255.0

The 0 in the Subnet mask signifies that there is no limit to communication at this part of the address. In the above example, this means, we can communicate with any device with an IP address that begins with 192.168.1.x. (where x is a number between 0 and 254).

Gateway (and router)

A gateway is a network point that acts as an entrance to another network and sends data transmitted via the network to an exact destination. The router knows where to direct data that arrives at the gateway. If a destination is located on an external network, the router transmits data to the external network. If your network communicates with other networks, you may need to configure the Gateway IP address. If you do not know the Gateway IP address contact your Network Administrator.

Wireless Network Terms and Concepts

Security Terms

Authentication and encryption

Most wireless networks use some kind of security settings. These security settings define the authentication (how the device identifies itself to the network) and encryption (how the data is encrypted as it is sent on the network). **If you do not correctly specify these options when you are configuring your Brother wireless printer, it will not be able to connect to the wireless network.** Therefore, care must be taken when configuring these options.

Authentication and Encryption methods for a personal wireless network

A personal wireless network is a small network, for example using your printer in a wireless network at home, without IEEE 802.1x support.

If you want to use your printer in an IEEE 802.1x supported wireless network, see *Authentication and Encryption methods for an enterprise wireless network* on page 152.

Authentication methods

■ Open system

Wireless devices are allowed to access the network without any authentication.

■ Shared key

A secret pre-determined key is shared by all devices that will access the wireless network.

The Brother wireless printer uses a WEP key as the pre-determined key.

■ WPA-PSK

Enables a Wi-Fi Protected Access Pre-shared key (WPA-PSK), which enables the Brother wireless printer to associate with access points using TKIP for WPA-PSK.

■ WPA2-PSK

Enables a Wi-Fi Protected Access Pre-shared key (WPA2-PSK), which enables the Brother wireless printer to associate with access points using AES for WPA2-PSK (WPA-Personal).

■ WPA/WPA2-PSK

Enables a Wireless Protected Access Pre-shared key (WPA-PSK/WPA2-PSK), which enables the Brother wireless printer to associate with access points using TKIP for WPA-PSK or AES for WPA-PSK and WPA2-PSK (WPA-Personal).

Encryption methods

■ None

No encryption method is used.

■ WEP

When using WEP (Wired Equivalent Privacy), the data is transmitted and received with a secure key.

■ TKIP

TKIP (Temporal Key Integrity Protocol) provides per-packet key mixing, a message integrity check and rekeying mechanism.

■ AES

Advanced Encryption Standard (AES) provides stronger data protection using a symmetric-key encryption.

When [Communication Mode] is set to [Ad-hoc]

Authentication Method	Encryption Mode
Open System	None
	WEP

When [Communication Mode] is set to [Infrastructure]

Authentication Method	Encryption Mode
Open System	None
	WEP
Public Key Authentication	WEP
WPA-PSK	TKIP
WPA2-PSK	AES
WPA/WPA2-PSK	TKIP
	AES

Network key

■ Open system/Shared key with WEP

This key is a 64-bit or 128-bit value that must be entered in an ASCII or hexadecimal format.

- 64 (40) bit ASCII:
Uses five text characters. e.g. "WLAN" (this is case sensitive)
- 64 (40) bit hexadecimal:
Uses 10 digits of hexadecimal data. e.g. "71f2234aba"
- 128 (104) bit ASCII:
Uses 13 text characters. e.g. "Wirelesscomms" (this is case sensitive)
- 128 (104) bit hexadecimal:
Uses 26 digits of hexadecimal data. e.g. "71f2234ab56cd709e5412aa2ba"

■ WPA-PSK/WPA2-PSK and TKIP or AES, WPA2 with AES

Uses a Pre-Shared Key (PSK) that is eight or more characters in length, up to a maximum of 63 characters.

Authentication and Encryption methods for an enterprise wireless network

An enterprise wireless network is a large network with IEEE 802.1x support. If you configure your printer in an IEEE 802.1x supported wireless network, you can use the following authentication and encryption methods:

Authentication methods

■ LEAP (For wireless network)

Cisco LEAP (Light Extensible Authentication Protocol) has been developed by Cisco Systems, Inc. which uses a user ID and password for authentication.

■ EAP-FAST

EAP-FAST (Extensible Authentication Protocol-Flexible Authentication via Secured Tunnel) has been developed by Cisco Systems, Inc. which uses a user ID and password for authentication, and symmetric key algorithms to achieve a tunnelled authentication process.

The printer supports the following inner authentication methods:

- EAP-FAST/NONE
- EAP-FAST/MS-CHAPv2
- EAP-FAST/GTC

■ PEAP

PEAP (Protected Extensible Authentication Protocol) has been developed by Microsoft Corporation, Cisco Systems and RSA Security. PEAP creates an encrypted SSL (Secure Sockets Layer)/TLS (Transport Layer Security) tunnel between a client and an authentication server, for sending a user ID and password. PEAP provides mutual authentication between the server and the client.

The printer supports the following inner authentication methods:

- PEAP/MS-CHAPv2
- PEAP/GTC

■ EAP-TTLS

EAP-TTLS (Extensible Authentication Protocol Tunnelled Transport Layer Security) has been developed by Funk Software and Certicom. EAP-TTLS creates a similar encrypt SSL tunnel to PEAP, between a client and an authentication server, for sending a user ID and password. EAP-TTLS provides mutual authentication between the server and the client.

The printer supports the following inner authentication methods:

- EAP-TTLS/CHAP
- EAP-TTLS/MS-CHAP
- EAP-TTLS/MS-CHAPv2
- EAP-TTLS/PAP

■ EAP-TLS

EAP-TLS (Extensible Authentication Protocol Transport Layer Security) requires digital certificate authentication both at a client and an authentication server.

Encryption methods

■ TKIP

TKIP (Temporal Key Integrity Protocol) provides a per-packet key mixing a message integrity check and rekeying mechanism.

■ AES

Advanced Encryption Standard (AES) provides stronger data protection using a symmetric-key encryption.

■ CKIP

The original Key Integrity Protocol for LEAP by Cisco Systems, Inc.

When [Communication Mode] is set to [Infrastructure]

Authentication Method	Encryption Mode
LEAP	CKIP
EAP-FAST/NONE	TKIP
	AES
EAP-FAST/MS-CHAPv2	TKIP
	AES
EAP-FAST/GTC	TKIP
	AES
PEAP/MS-CHAPv2	TKIP
	AES
PEAP/GTC	TKIP
	AES
EAP-TTLS/CHAP	TKIP
	AES
EAP-TTLS/MS-CHAP	TKIP
	AES
EAP-TTLS/MS-CHAPv2	TKIP
	AES
EAP-TTLS/PAP	TKIP
	AES
EAP-TLS	TKIP
	AES

User ID and password

The following security methods support a user ID less than 64 characters and a password less than 32 characters in length.

- LEAP
- EAP-FAST
- PEAP
- EAP-TTLS
- EAP-TLS (For user ID)

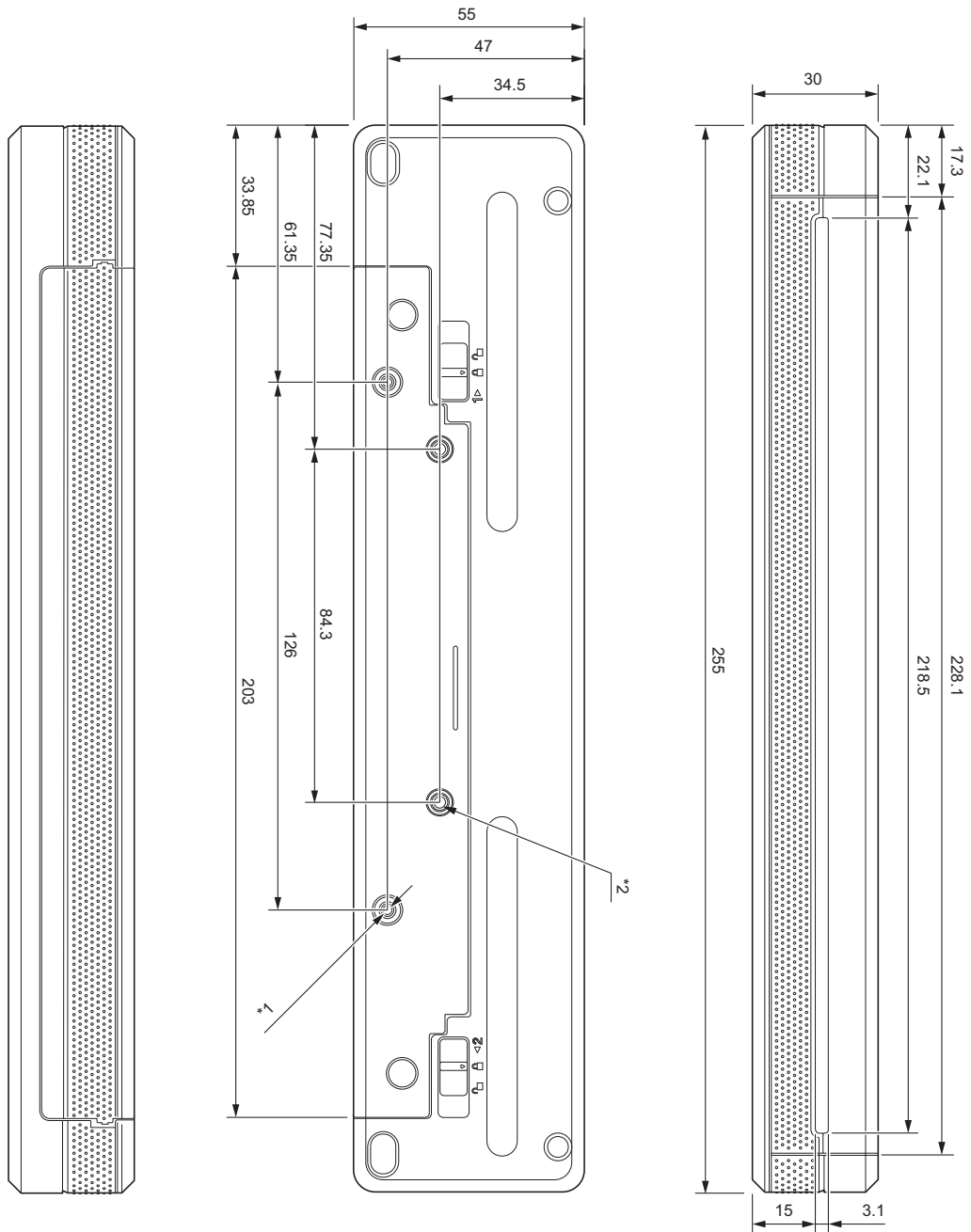

Mounting Notes

- *1 Secure the battery cavity mounting block to the printer first.
- *2 Secure the battery cavity mounting block to the desired surface.

Brother Testing Conditions

These values are not guaranteed. When mounting the printer for use, make sure the printer is mounted securely.

*1 Size: Use M2.6 tapping screws; Screw hole depth: 6 mm; Tightening torque: 2.2 kgf·cm; Material: Steel

*2 Size: Use M2.6 screws; Screw hole depth: 6 mm; Tightening torque: 3.5 kgf·cm; Material: Steel

Using binding head screws coated with a thread-locking agent is effective at preventing the screws from becoming loose.

■ Mounting plate

Thickness: 2 mm; Material: Steel

brother

Free Manuals Download Website

<http://myh66.com>

<http://usermanuals.us>

<http://www.somanuals.com>

<http://www.4manuals.cc>

<http://www.manual-lib.com>

<http://www.404manual.com>

<http://www.luxmanual.com>

<http://aubethermostatmanual.com>

Golf course search by state

<http://golfingnear.com>

Email search by domain

<http://emailbydomain.com>

Auto manuals search

<http://auto.somanuals.com>

TV manuals search

<http://tv.somanuals.com>