

CELVIANO

EN

AP-470

USER'S GUIDE (Full)

Before using this Digital Piano for the first time, be sure to read the separate USER'S GUIDE to familiarize yourself with basic operations.

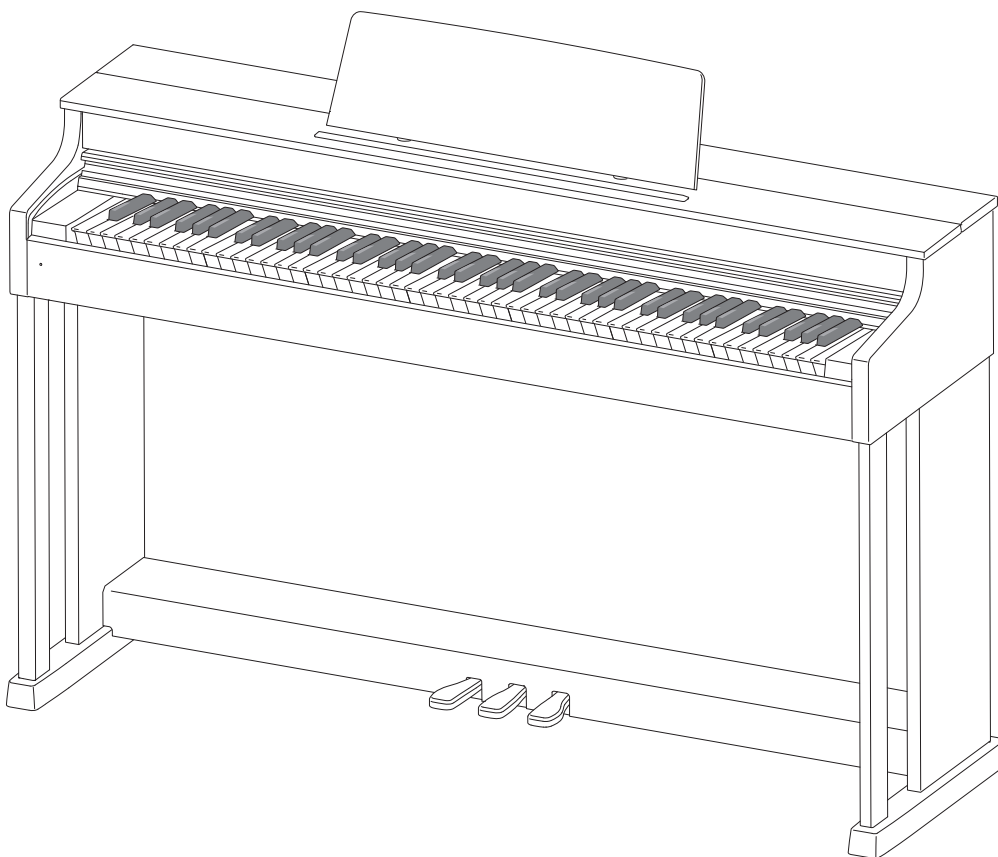

Contents

Getting Ready..... EN-49

| | |
|---|-------|
| Assembling the Stand..... | EN-49 |
| To connect the cable..... | EN-52 |
| To install the music stand..... | EN-53 |
| Install the Headphones Hook..... | EN-53 |
| Removing the Protective Tape from the Keyboard..... | EN-53 |

| | |
|---|-------|
| Opening and Closing the Piano Lid..... | EN-54 |
| Connecting Headphones..... | EN-54 |
| Connecting Audio Equipment or an Amplifier..... | EN-55 |
| Bundled and Optional Accessories..... | EN-55 |

General Guide..... EN-3

| | |
|-------------------------------------|------|
| FUNCTION Button..... | EN-4 |
| Auto Resume and Operation Lock..... | EN-4 |
| About Music Score data..... | EN-4 |

Power Outlet..... EN-5

| | |
|--|------|
| Turning Power On or Off..... | EN-5 |
| Returning the Digital Piano to Its Factory Default Settings..... | EN-5 |

Playing with Different Tones..... EN-6

| | |
|---|-------|
| Selecting and Playing a Tone..... | EN-6 |
| Adjusting Acoustic Piano Sound Characteristics..... | EN-7 |
| Layering Two Tones..... | EN-8 |
| Using Effects..... | EN-9 |
| Using the Digital Piano's Pedals..... | EN-10 |
| Using the Metronome..... | EN-11 |
| Splitting the Keyboard for Duet Play..... | EN-12 |

Using Built-in Songs (Concert Play, Music Library, Demo Tunes)..... EN-14

| | |
|--|-------|
| Performing Demo Play..... | EN-14 |
| Concert Play..... | EN-14 |
| Practicing with a Concert Play Song..... | EN-14 |
| Music Library..... | EN-16 |
| Playing Back a Specific Music Library Song..... | EN-16 |
| Practicing with a Music Library Song..... | EN-17 |
| Playing Back Audio Data Stored on a USB Flash Drive..... | EN-17 |

Recording and Playback..... EN-18

| | |
|--|-------|
| Recording to Built-in MIDI Recorder..... | EN-18 |
| Using the MIDI REC Button..... | EN-18 |
| Recording to a USB Flash Drive (Audio Recorder)..... | EN-21 |

Configuring Settings with the Keyboard..... EN-25

| | |
|---|-------|
| To configure settings with the keyboard..... | EN-25 |
| Keyboard Keys Used for Configuring Settings..... | EN-26 |
| Parameter List..... | EN-28 |
| Hall simulator..... | EN-28 |
| Tone selection..... | EN-28 |
| Chorus..... | EN-28 |
| Brilliance..... | EN-28 |
| Layer balance..... | EN-28 |
| Lower Pedal..... | EN-28 |
| Damper noise..... | EN-28 |
| Hammer response..... | EN-28 |
| String resonance..... | EN-28 |
| Lid simulator..... | EN-28 |
| Key-on action noise..... | EN-28 |
| Key-off action noise..... | EN-28 |
| Select layer tone..... | EN-29 |
| Duet mode..... | EN-29 |
| Music Library song select (MUSIC LIBRARY SELECT)..... | EN-30 |
| Tempo (TEMPO)..... | EN-30 |
| Beat (BEAT)..... | EN-30 |
| METRONOME TEMPO..... | EN-30 |
| METRONOME BEAT..... | EN-30 |
| CONCERT PLAY ▶/■..... | EN-30 |
| LISTEN..... | EN-30 |
| LESSON..... | EN-30 |
| PLAY..... | EN-30 |
| CONCERT PLAY SELECT (Song) (SELECT +/-)..... | EN-30 |
| CONCERT PLAY VOLUME (VOLUME +/-)..... | EN-30 |
| Music Library Song Volume..... | EN-30 |
| Metronome volume..... | EN-30 |
| Temperament..... | EN-31 |
| Temperament Base note..... | EN-31 |
| Temperament select..... | EN-31 |
| Touch response..... | EN-31 |
| Transpose..... | EN-31 |
| A-tuning..... | EN-31 |
| Octave shift..... | EN-31 |
| Keyboard volume..... | EN-31 |
| USB flash drive mode..... | EN-32 |
| Local control..... | EN-32 |
| Send channel..... | EN-32 |
| Audio Recorder Volume..... | EN-32 |
| Operation tone..... | EN-32 |
| Panel lock..... | EN-32 |
| USB flash drive mode..... | EN-33 |
| Format..... | EN-33 |
| Save..... | EN-33 |
| Load..... | EN-33 |
| Delete..... | EN-33 |

Speaker out..... EN-33
 Head phone mode EN-33
 Volume Sync Equalizer..... EN-33
 Auto Resume EN-33
 Linking with an Application (APP Function)..... EN-34

USB Flash Drive..... EN-35

Storing Standard Audio Data (WAV Files) to
 a USB Flash Drive EN-36
 Connecting a USB Flash Drive to and
 Detaching It from the Digital Piano EN-37
 Formatting a USB Flash Drive..... EN-37
 Saving a Recorded Song to a USB Flash Drive EN-38
 Loading Song Data from a USB Flash Drive into
 Digital Piano Memory EN-40
 Deleting Data from a USB Flash Drive EN-41
 Simple Play Back of a Song on a USB Flash Drive..... EN-42
 Error Indicators EN-43

Connecting to a Computer..... EN-45

Minimum Computer System Requirements..... EN-45
 Connecting the Digital Piano to Your Computer..... EN-45
 Using MIDI..... EN-46
 Transferring Song Data with a Computer EN-46

Reference EN-56

Troubleshooting..... EN-56
 Product Specifications EN-57

Appendix A-1

Tone List..... A-1
 Concert Play List A-1
 Music Library List..... A-1

MIDI Implementation Chart

Company and product names used in this manual may be registered trademarks of others.

General Guide

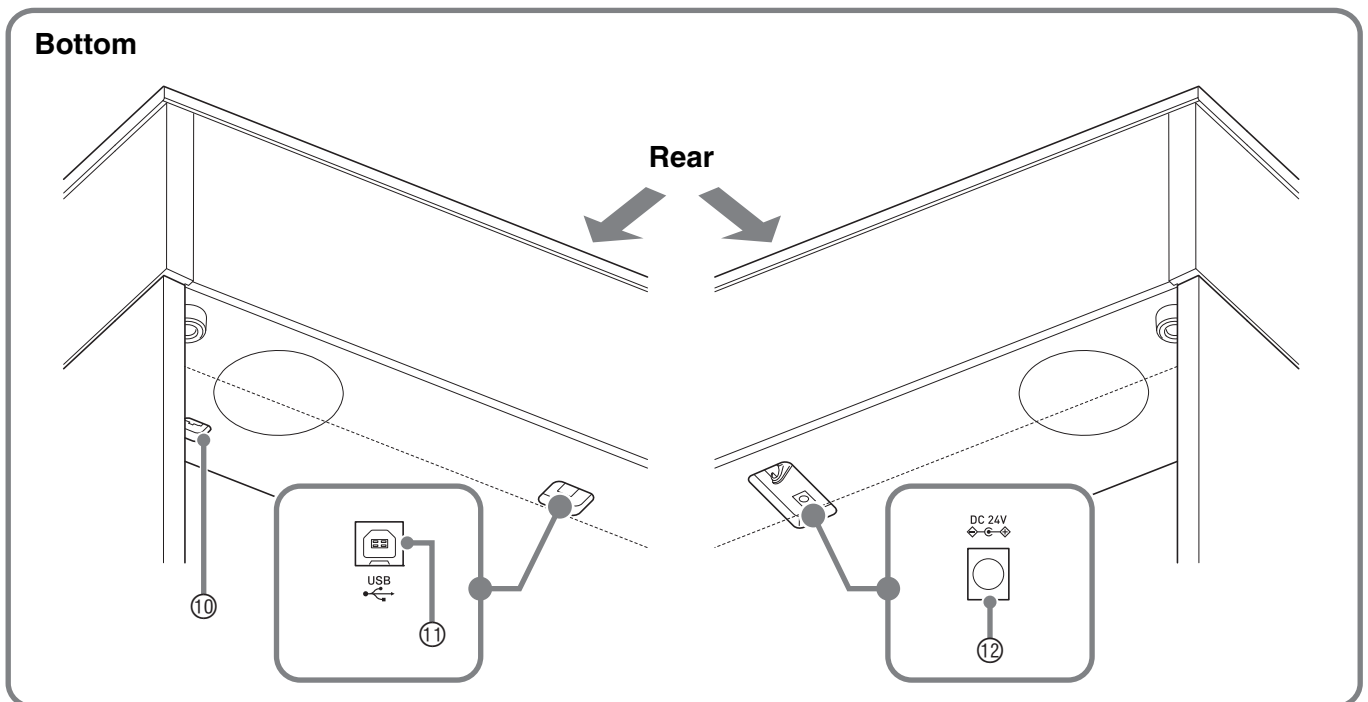
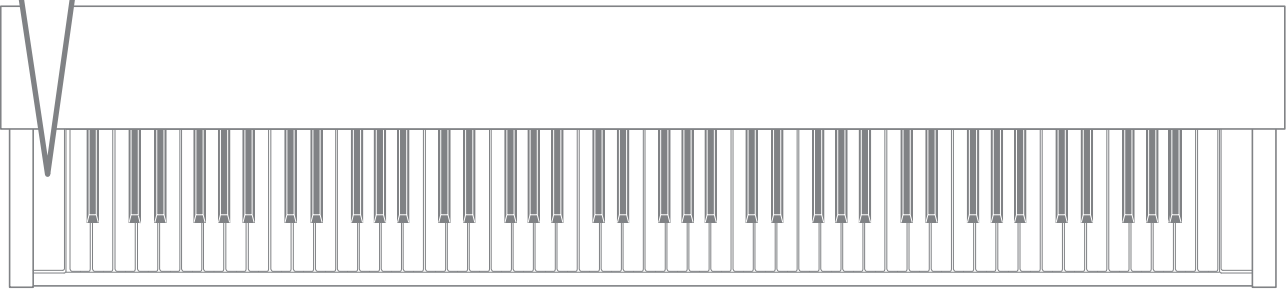
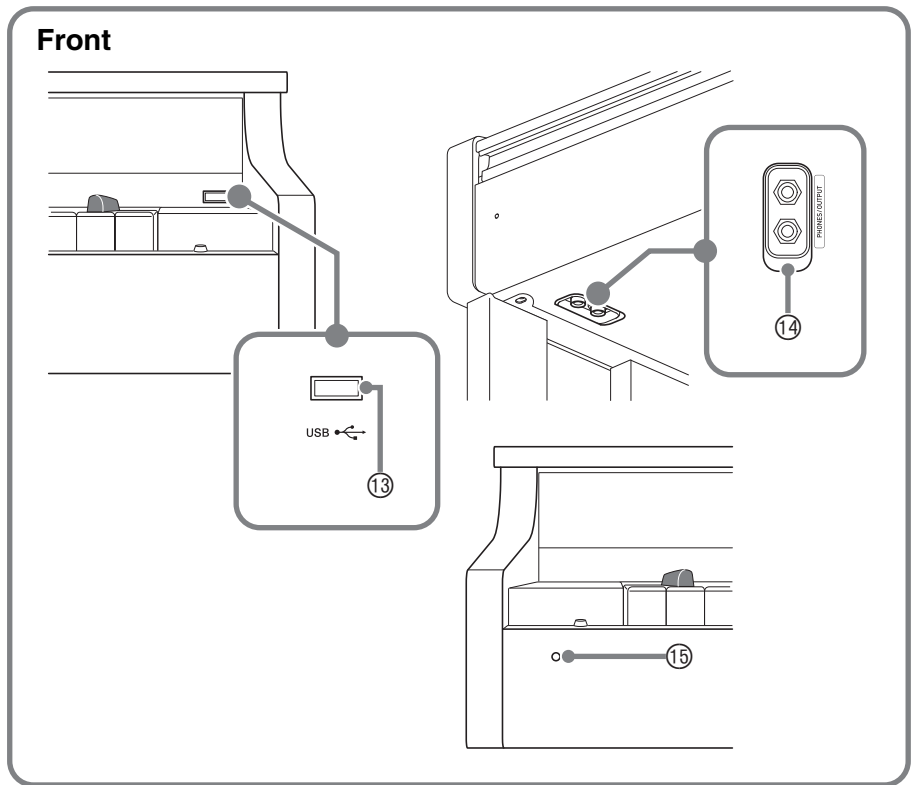
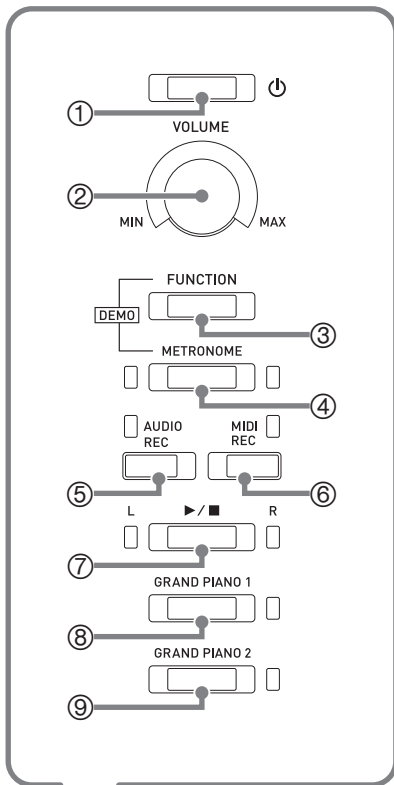

⚠ CAUTION

- Make sure that the cover is fully open whenever you are playing on the keyboard. A partially open cover can suddenly close unexpectedly and pinch your fingers.

📌 NOTE

- The names shown here are always indicated in bold when they appear within the text of this manual.

- | | |
|-------------------------------|------------------------------------|
| ① ⏻ (POWER) button | ⑩ Pedal connector |
| ② VOLUME controller | ⑪ USB port |
| ③ FUNCTION button | ⑫ Power terminal (DC 24V) |
| ④ METRONOME button | ⑬ USB flash drive port |
| ⑤ AUDIO REC button | ⑭ PHONES/OUTPUT jacks |
| ⑥ MIDI REC button | ⑮ Power lamp |
| ⑦ ▶/■ button | |
| ⑧ GRAND PIANO 1 button | |
| ⑨ GRAND PIANO 2 button | |

FUNCTION Button

The **FUNCTION** button is used in combination with other buttons and keys.

To change a setting, hold down the **FUNCTION** button as you press the button or key that is assigned the setting you want to configure.

- When you press a key, the Digital Piano beeps to indicate the current setting.
- A long beep indicates that a setting is turned off.

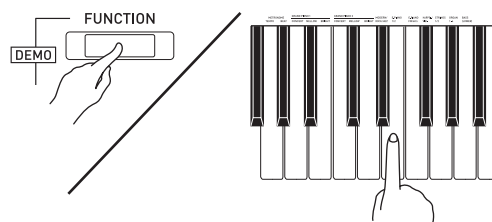
**📌 NOTE**

- For details about operations and settings, see “Configuring Settings with the Keyboard” on page EN-25.

Auto Resume and Operation Lock

Your Digital Piano can be configured to save its current settings when power is turned off and restore them when turned back on again (Auto Resume). You can also lock its buttons to protect against operation errors (Operation Lock). For details, see “Parameter List” on pages EN-28 - EN-33.

About Music Score data

You can use a computer to download music score data from the CASIO Website. For more information, visit the URL below.

<http://world.casio.com/>

Power Outlet

After you finish assembling the stand, turn on the Digital Piano. For details, see “Getting Ready” on page EN-49.

Turning Power On or Off

1. Press the  (POWER) button to turn on Digital Piano power.

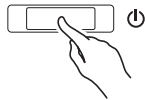

- The power lamp lights and the Digital Piano powers up. The power up operation takes about 5 seconds.

2. To turn off the Digital Piano, hold down the  (POWER) button until the power lamp goes out.

NOTE



- Pressing the  (POWER) button to turn off power actually puts the Digital Piano into a standby state. Minute amounts of current continue to flow within the Digital Piano in the standby state. If you do not plan to use the Digital Piano for a long time or if there is a lightning storm in your area, be sure to unplug the AC adaptor from the power outlet.

Auto Power Off

This Digital Piano is designed to turn off automatically to avoid wasting power after no operation is performed for a preset amount of time. The Auto Power Off trigger time is about four hours.

- You also can use the procedure below to temporarily suspend Auto Power Off.

■ To disable Auto Power Off

1. While the Digital Piano is turned on, press the  (POWER) button to turn it off.
2. While holding down the **FUNCTION** button, press the  (POWER) button to turn on the Digital Piano.



- Auto Power Off will be disabled at this time.

NOTE

- Turning off the Digital Piano after performing the above steps will re-enable Auto Power Off.

Returning the Digital Piano to Its Factory Default Settings

Perform the following procedure when you want to return the Digital Piano's stored data and settings to their initial factory defaults.

1. Turn off the Digital Piano.
2. Holding down the **FUNCTION**, **MIDI REC** and **GRAND PIANO 2** buttons, press the  (POWER) button.
3. Hold down the **FUNCTION**, **MIDI REC** and **GRAND PIANO 2** buttons until the GRAND PIANO 2 lamp, and then the GRAND PIANO 1 lamp, and then the R lamp start to flash.
 - After some time, the flashing will stop.
4. Release the **FUNCTION**, **MIDI REC** and **GRAND PIANO 2** buttons.
 - The Digital Piano will initialize its internal system. You will be able to use the Digital Piano in a short while.

NOTE

- See “Turning Power On or Off” (page EN-5) for information about turning power on and off.

Playing with Different Tones

Selecting and Playing a Tone

The Digital Piano comes with 22 built-in tones. *1

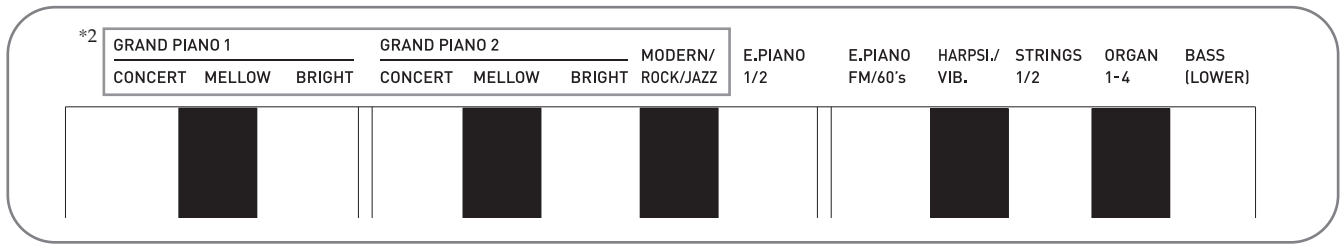

*1: The names of the tones are marked above the keyboard keys to which they are assigned.

*2: In this manual, these nine tones are collectively referred to as “piano tones”. The CONCERT, MELLOW, and BRIGHT tones are collectively referred to as “GRAND PIANO tones”.

To select a tone

1. Select the tone you want.

- To select GRAND PIANO 1 CONCERT or GRAND PIANO 2 CONCERT
 - Press the **GRAND PIANO 1** button or **GRAND PIANO 2** button.

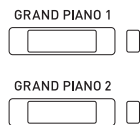

- The button lamp of the selected tone will light.
- To select one of the other tones
 - While holding down the **FUNCTION** button, press the keyboard key that corresponds to the tone you want to select.

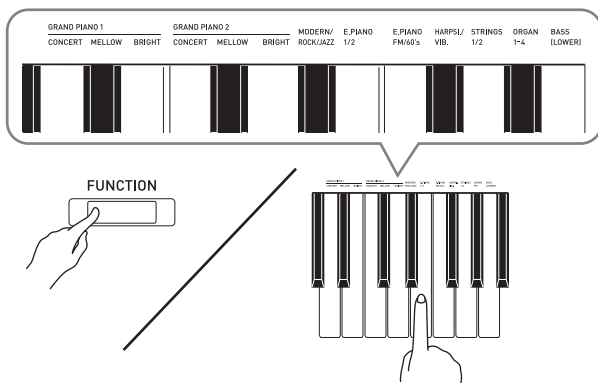

NOTE

- Some keys may have more than one tone assigned. In this case, each press of the key cycles to the next assigned tone. Which tone is selected by the key press is indicated by beeps.

Example: Cycling through **MODERN**, **ROCK**, and **JAZZ** settings

MODERN: (1 beep)

ROCK: (2 beeps)

JAZZ: (3 beeps)

- Of the Digital Piano’s 22 built-in tones, the first six are grand piano tone. Each tone has its own distinctive merits, so you should select the tone that suits the song you are playing along with or your own personal preferences.

| Tone Name | Characteristics |
|-----------|--|
| CONCERT | This is a full concert grand piano tone for dynamic and natural tone changes. This tone is designed to reproduce damper, resonance, and other piano nuances, which makes it ideal for virtually any type of piano performance. |
| MELLOW | A warm, subdued grand piano tone. |
| BRIGHT | A bright and clear grand piano tone. |

2. Use the **VOLUME** controller to adjust the volume.

Bass Tone (BASS)

Selecting the BASS (LOWER) tone in step 1 of the above procedure will assign the bass tone to the low range (left side) of the keyboard. The high range (right side) will be assigned the tone that was selected when you pressed the BASS key.

- BASS tone lets you effectively split the keyboard between two different tones.

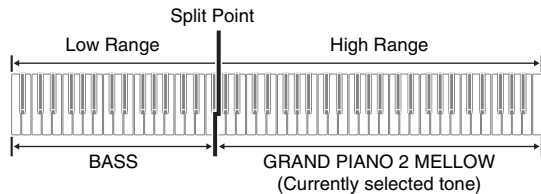

NOTE

- To return the keyboard to a single tone, select any tone other than BASS.
- You cannot select BASS when recording to Track 2.
- You can configure settings to sustain reverberation of the BASS (LOWER) tone while the damper pedal or sostenuto pedal is pressed. For more information, see "Lower Pedal" (page EN-28).

Adjusting Acoustic Piano Sound Characteristics

The tones of your Digital Piano have built-in elements that give them the characteristic reverberation of an acoustic piano (ACOUSTIC SIMULATOR). Each of these elements can be individually adjusted to one of four levels.

● HAMMER RESPONSE

Controls the time deviation between when a key is pressed and when the note actually sounds.

Settings

1: Fast 2: Grand piano feel 3: Slightly slower 4: Slow

● STRING RESONANCE

Adjusts the characteristic reverberation (string resonance) of an acoustic piano.

You can select a reverberation setting that matches the song being played or your own personal preference.

Settings

1: Suppressed 2: Slightly suppressed
3: Reverberation 4: Strong reverberation

● LID SIMULATOR

Adjusts how sound resonates in accordance with the opening state of a grand piano lid.

Settings

1: Lid closed 2: Lid opened slightly 3: Lid fully open
4: Lid removed

NOTE

- Opening or closing the Digital Piano's lid does not affect the Lid Simulator setting.

1. Hold down the **FUNCTION** button and press the desired tone key.

- Each press of the keyboard key cycles to the next option for that setting. The Digital Piano emits a beep pattern that indicates the currently selected option:
One beep: Option 1 → Two beeps: Option 2 →
Three beeps: Option 3 → Four beeps: Option 4 →
One beep: Option 1, etc.

In addition to piano tones, the elements below are also available.

- **KEY OFF SIMULATOR**

Causes notes to decay when keyboard keys are released.

- **KEY-ON ACTION NOISE***

Reproduces the mechanical operation sound (noise) that can be heard when keys of an acoustic piano are tapped with extremely light pressure.

- **KEY-OFF ACTION NOISE***

Reproduces the mechanical operation sound (noise) that can be heard when keys of an acoustic piano are released.

* Can be applied for any piano tone other than ROCK PIANO and JAZZ PIANO. For details, see "Parameter List" on pages EN-28 - EN-33.

 **NOTE**

- If you change the ACOUSTIC SIMULATOR setting, the newly applied setting is saved. To return the piano tones to their initial default settings, disable Auto Resume and then turn power off and then back on again.

Layering Two Tones

Use the following procedure to layer two tones, so they sound at the same time.

When specifying two tones for layering, first tone you select will be the main tone, while the second tone will be the layered tone.

1. Hold down the **FUNCTION** button and press the Select Layer Tone key.

- For details about using the keyboard keys for settings, see "Keyboard Keys Used for Configuring Settings" (page EN-26).
- Each press of the keyboard key toggles between on and off.

2. Hold down the **FUNCTION** button and press key of the tone to be layered.

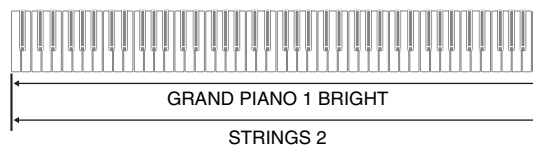

3. To return to the original tone, hold down the **FUNCTION** button and press the Select Layer Tone key (which exits the Layer Mode).

 **NOTE**

- You cannot layer the BASS tone with another tone.
- You cannot perform the layer operation when recording to Track 2.

To adjust the volume balance between two layered tones

1. While holding down the **FUNCTION** button, use the keyboard keys shown below to adjust the volume of the layered tones.

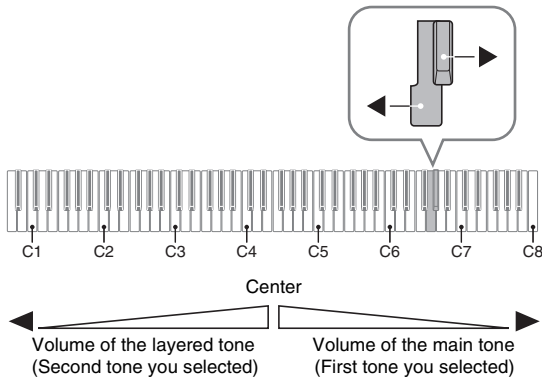

- To return the volume setting to its initial default, hold down the **FUNCTION** button and press both of the keys at the same time.

Using Effects

Hall simulator: Makes your notes resonate.

Chorus : Adds more breadth to your notes.

- For details about using the keyboard keys for settings, see “Keyboard Keys Used for Configuring Settings” (page EN-26).

To apply a hall simulator

1. While holding down the **FUNCTION** button, press the keyboard key that corresponds to the hall simulator name you want to select.

| Hall simulator Name | Description |
|---------------------|---|
| DUTCH CHURCH | Amsterdam church with acoustics that are suitable for music |
| STANDARD HALL | Standard concert hall |
| BERLIN HALL | Berlin arena type classic concert hall |
| FRENCH CATHEDRAL | Large gothic cathedral in Paris |

To apply chorus to a tone

1. While holding down the **FUNCTION** button, use the Chorus keyboard key to cycle through the available settings.

- Each press of the Chorus keyboard key causes the Digital Piano to beep according to which setting is selected, as shown in the table below.
- Chorus

| Number of Beeps | Setting |
|-----------------|----------------------------|
| 1 (long) | Off (OFF) |
| 1 (short) | Light Chorus |
| 2 | Medium Chorus |
| 3 | Deep Chorus |
| 4 | Flanger (whooshing effect) |

About DSP

DSP makes it possible to digitally produce complex acoustic effects. The DSP is assigned to each tone whenever you turn on Digital Piano power.

Using the Digital Piano's Pedals

Your Digital Piano comes equipped with three pedals: damper, soft, and sostenuto

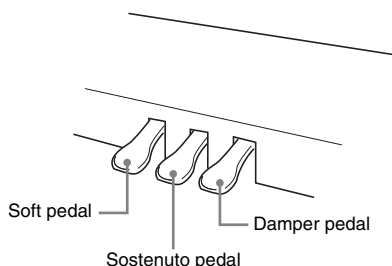

Pedal Functions

● Damper Pedal

Pressing the damper pedal while playing will cause the notes you play to reverberate.

- When one of the piano tone is selected, using the damper pedal adds damper resonance that is similar to that produced on an acoustic grand piano.

● Sostenuto Pedal

Only the notes of the keys that are depressed when this pedal is pressed are sustained, even if the keyboard keys are released, until the pedal is released.

● Soft Pedal

Pressing this pedal while playing suppresses notes played on the keyboard after the pedal was pressed, and makes them sound softer.

NOTE

- If pressing the pedal does not produce the desired effect, it could mean that the pedal cord is not connected properly. Refer to step 1 under "To connect the cable" (page EN-52).

Disabling Damper Noise Output

Damper noise is a slight metallic ringing sound that is generated as the damper of an acoustic piano separates from the wires pedal when the damper pedal is pressed. The damper resonance of your Digital Piano normally includes damper noise, but you can perform the procedure below to disable its output. Damper noise can be applied to the six GRAND PIANO tones and MODERN.

1. While holding down the **FUNCTION** button, press the Damper Noise keyboard key.
 - For details about using the keyboard keys for settings, see "Keyboard Keys Used for Configuring Settings" (page EN-26).
 - Each press of the key toggles the setting and causes the Digital Piano to beep as described below.
 - Long beep: Damper noise output disabled
 - Short beep: Damper noise output enabled

Using the Metronome

1. Press the **METRONOME** button.
 - This starts the metronome.
 - The lamp flashes with each beat.
2. While holding down the **FUNCTION** button, press the **METRONOME BEAT** keyboard key.
 - Keep the **FUNCTION** button depressed as you advance to step 3.
3. Hold down the **FUNCTION** button and press the **BEAT** keyboard key (0 to 9) that corresponds to the beat you want to specify.

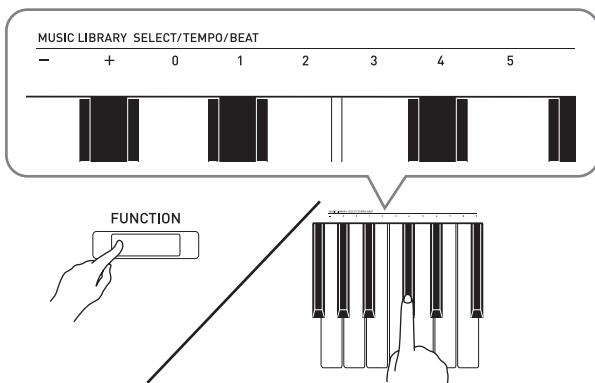

- You can specify a beat value in the range of 0 to 9 (beats per measure). A chime will sound on the first beat of each measure, and clicks will sound for the remaining beats. Specifying 0 plays a straight click, without any chime. This setting lets you practice with a steady beat.

4. Release the **FUNCTION** button and then hold it down again as you press the **METRONOME TEMPO** keyboard key.
 - Keep the **FUNCTION** button depressed as you advance to step 5.

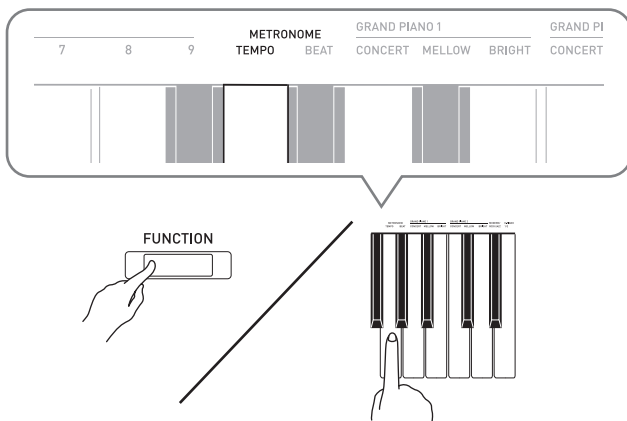

5. While holding down the **FUNCTION** button, use the **TEMPO** keys to specify a tempo value in the range of 20 to 255 beats per minute.

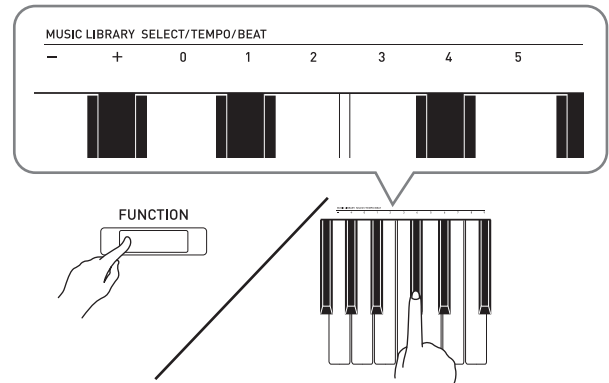

- Each press of the + or – key raises or lowers the tempo value by 1.
- You can also use the tempo value input keys (0 to 9) to enter a specific tempo value.
- Input three digits as the tempo value.
Example: To set a tempo of 20, press keys 0, 2, and then 0.

6. Press the **METRONOME** button to turn off the metronome.

NOTE

- If you used the numeric input (0 to 9) keyboard keys to input beat and/or tempo values and the values are within the allowable setting ranges, the Digital Piano will emit a high pitch beep when you release the **FUNCTION** button. If a value is outside the allowable range, a low-pitch sound will be emitted.
- You could also use the procedure below in place of steps 4 and 5 of the above procedure to specify a tempo value.
 - While holding down the **FUNCTION** button, use the **TEMPO** keyboard keys to specify a tempo value in the range of 20 to 255 (beats per minute).
- In step 5 of the above procedure, pressing the + and – keys at the same time will set the tempo of the Concert Play lesson song or Music Library song (in the case of a recorded song, the tempo when the song was recorded) that was last selected on the Digital Piano.

To adjust the metronome volume

You can perform the following procedure at any time, regardless of whether or not the metronome is sounding.

1. While holding down the **FUNCTION** button, use the Metronome Volume keys to specify a volume value in the range of 0 to 42.
 - For details about using the keyboard keys for settings, see “Keyboard Keys Used for Configuring Settings” on page EN-26.
 - Each press of the + and – key raises or lowers the metronome volume value by 1.

NOTE

- To return to the initial default setting, press + and – at the same time.

Splitting the Keyboard for Duet Play

You can split the keyboard in the center so the left and right sides have the same range. The left outer pedal is the left side damper pedal, while the right outer pedal is the right side damper pedal.

Keyboard

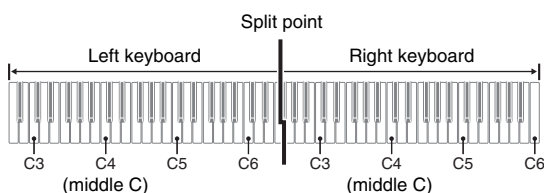

Pedals

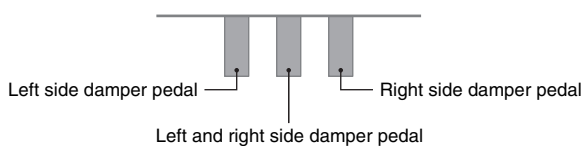

NOTE

- Only the damper pedal for the right side keyboard supports half-pedal operations.

1. Select the piano tone you want to use for the duet.

Example: GRAND PIANO 1 (BRIGHT)

2. To cycle between the Duet Mode settings below, hold down the **FUNCTION** button and press the Duet Mode key.

Off

On

Pan: Outputs left side keyboard tone from the left speaker and right side keyboard tone from the right speaker.

IMPORTANT!

- The Octave Shift and Transpose settings cannot be changed while On or Pan is selected for the Duet Mode setting.
- While “Pan” is selected for the Duet Mode settings, the Hall Simulator, and Chorus settings cannot be changed.

Changing the Octaves of the duet keyboards

You can change the ranges of the left and right keyboards in octave units from their initial default settings. This comes in handy, for example, if the initial default range is not enough when one person is playing the left hand part and another person is playing the right hand part.

1. While holding down the **FUNCTION** and **GRAND PIANO 1** buttons, press the keyboard C key that you want located at C4 (middle C) of the left keyboard. Keep **FUNCTION** and **GRAND PIANO 1** buttons depressed as you advance to step 2, below.
 - This will sound the note assigned to C4 and change the octave of the left keyboard.

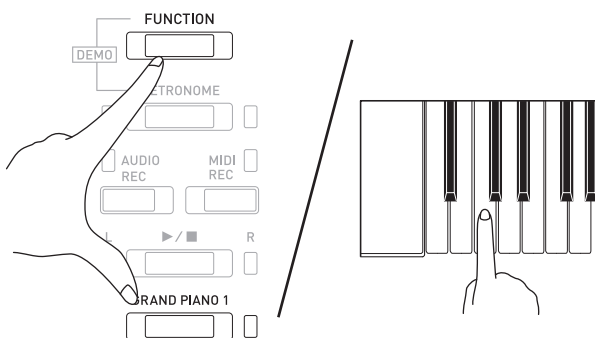

Example: Press the keyboard key of the leftmost C (C4) will assign the range shown below.

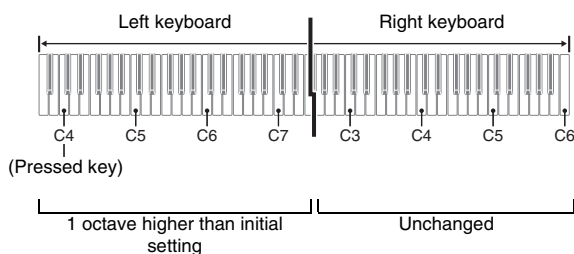

2. While still holding down the **FUNCTION** and **GRAND PIANO 1** buttons, press the keyboard C key that you want located at C4 (middle C) of the right keyboard.
 - This will sound the note assigned to C4 and change the octave of the right keyboard.

NOTE

- Exiting the Duet Mode and then selecting On or Pan for the Duet Mode setting again will return the keyboards to their initial default ranges.

Using Built-in Songs (Concert Play, Music Library, Demo Tunes)

Your Digital Piano comes with 10 built-in piano and orchestra tunes (Concert Play 1 through 10), and 60 piano solos (Music Library 1 to 60).

Concert Play lets you enjoy playing along with orchestral accompaniment. You can use Music Library to practice famous piano pieces.

IMPORTANT!

- Whenever you change to another song, this Digital Piano loads the song data. Note that button operations are disabled while song loading is in progress. If you are playing something on the keyboard, changing the song may cause note output to stop.

Performing Demo Play

1. While holding down the **FUNCTION** button, press the **METRONOME** button.
 - This starts sequentially looped playback of all Concert Play (Listen) songs and Music Library songs.
 - You can play along with a song on the keyboard as it is playing. The tone assigned to the keyboard is the one that is preset for the song that is playing.
2. To change the demo song, hold down the **FUNCTION** button and press the **MIDI REC** button or **AUDIO REC** button.
 - To advance to the next demo song, hold down the **FUNCTION** button and press the **MIDI REC** button.
 - To return to the previous demo song, hold down the **FUNCTION** button and press the **AUDIO REC** button.
 - For a list of songs, see page A-1.
3. Press the **▶/■** button again to stop built-in song play.

NOTE

- Pressing the **METRONOME** button while holding down the **FUNCTION** button during Concert Play jumps to the first Music Library song. Performing the same operation during Music Library play jumps to the first Concert Play song.
- The tune selection and playback stop operations described above are the only operations that are possible during demo tune play.

Concert Play

Concert Play has recordings of a live orchestra, which you can use to play along with authentic accompaniment.

You can also use Concert Play for 3-step practice.

Step 1: LISTEN

Listen to playback of the piano and orchestra to familiarize yourself with the music.

Step 2: LESSON

Practice the Concert Play piano part.

- You can turn off the left hand part or right hand part of a built-in song and play along on the piano.

Step 3: PLAY

Play along with the orchestra accompaniment.

- The Concert Play contains actual recordings of an orchestra. Because of this, the instrument sounds are different from the tones that can be selected with this piano (page EN-6). This also means that Concert Play playback includes breath sounds and performance noises.

Practicing with a Concert Play Song

To listen to a Concert Play song (LISTEN)

1. While holding down the **FUNCTION** button, use the **CONCERT PLAY SELECT +** and **-** keyboard keys to scroll song numbers in sequences (from 1 to 10).
 - For information about Concert Play songs, see the "Concert Play List" on page A-1.

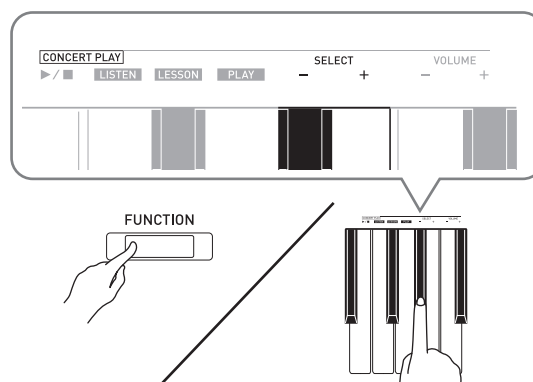

2. While holding down the **FUNCTION** button, press the **LISTEN** keyboard key.
- This enters the Listen Mode for listening to the piano and orchestra performance.
 - Playback tempo is fixed and cannot be changed during Listen Mode playback.

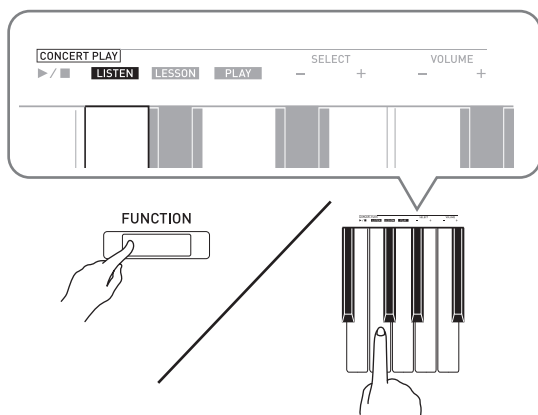

3. While holding down the **FUNCTION** button, press the **CONCERT PLAY** ►/■ keyboard key to start playback.
- Playback will stop automatically when the end of the song is reached.
4. To stop playback, hold down the **FUNCTION** button as you press the **CONCERT PLAY** ►/■ keyboard key again.

NOTE

- You can use adjust the volume level of the playback, if you want. See “Configuring Settings with the Keyboard” (page EN-25) for more information.

To practice the piano part (LESSON)

PREPARATION

- You can change tempo of the playback, if you want. See “Configuring Settings with the Keyboard” (page EN-25) for more information.

NOTE

- Some Concert Play tunes incorporate tempo changes in their arrangements. Because of this, the playback tempo may at times be faster or slower than the tempo setting.

1. While holding down the **FUNCTION** button, press the **LESSON** keyboard key.
- This enters the Lesson Mode, which allows simple play along with the piano part.

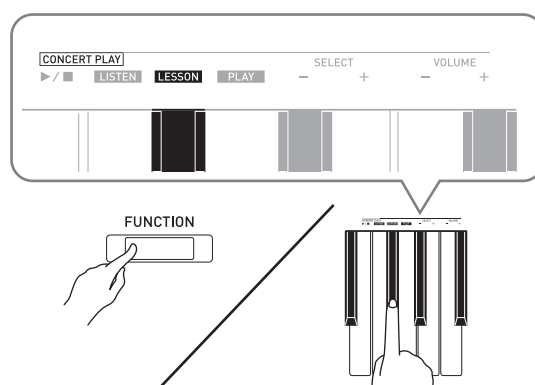

2. While holding down the **FUNCTION** button, press the ►/■ button to select the part you want to turn off.
- Pressing a button toggles its part on (button lamp on) and off (button lamp off).

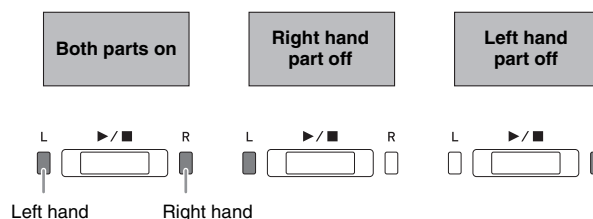

3. While holding down the **FUNCTION** button, press the **CONCERT PLAY** ►/■ keyboard key.
- This starts playback, without the part you turned off in step 2.
4. Play the missing part on the keyboard.
5. To stop playback, hold down the **FUNCTION** button as you press the **CONCERT PLAY** ►/■ keyboard key again.

To play along with the orchestra accompaniment (PLAY)

1. While holding down the **FUNCTION** button, press the **PLAY** keyboard key.

- This will enter the Play Mode, which plays the orchestra part without the piano part.

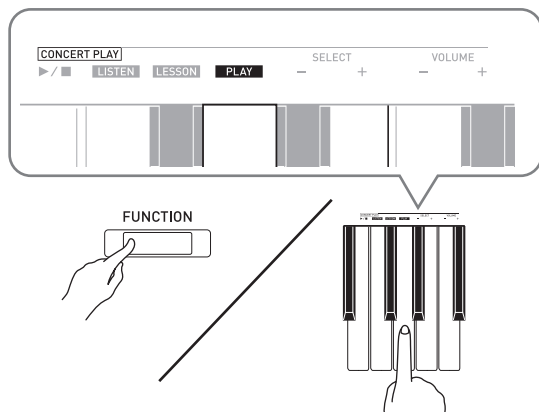

2. While holding down the **FUNCTION** button, press the **CONCERT PLAY** ►/■ keyboard key to start playback.

- Playback tempo is fixed and cannot be changed during Play Mode playback.

3. Play the piano part on the keyboard.

4. To stop playback, hold down the **FUNCTION** button as you press the **CONCERT PLAY** ►/■ keyboard key again.

Music Library

You can use the Music Library for your listening enjoyment or to practice piano songs.

- The Music Library includes 60 songs, numbered 1 through 60.
- You can also import up to 10 songs* from a computer to Digital Piano memory, and assign them Music Library song numbers 61 through 70.

* You can download music data from the Internet and then transfer it from your computer to Digital Piano memory. See “Transferring Song Data with a Computer” on page EN-46 for more information.

Playing Back a Specific Music Library Song

1. Find the song number of the song you want to play in the “Music Library List” on page A-1.

2. To change to another song, hold down the **FUNCTION** button as you use the **MUSIC LIBRARY SELECT** (+, –, 0 to 9) keys to specify a song number.

- Each press of the + or – key raises or lowers the song number by 1.
- You can also input a value from 0 to 9 to specify a Music Library song number.
- Input two digits as the song number.

Example: To specify song number 5, press keys 0 and then 5.

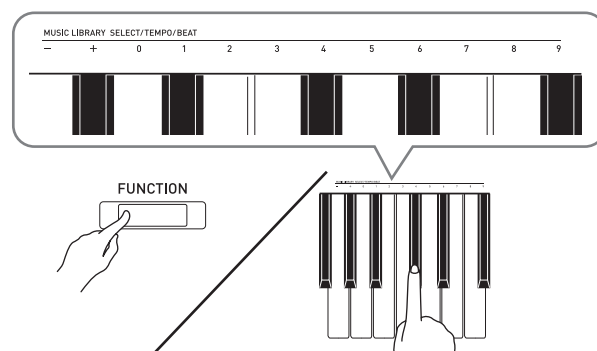

3. Press the ►/■ button.

- This starts the playback of the song.

4. To stop playback, press the ►/■ button again.

- Playback will stop automatically when the end of the song is reached.

NOTE

- Pressing the + and – keys at the same time in step 2 of the above procedure will select song number 1.
- You also can adjust the playback tempo and volume of the song. See “Configuring Settings with the Keyboard” on page EN-25 for more information.

Practicing with a Music Library Song

You can turn off the left hand part or right hand part of a song and play along on the Digital Piano.

NOTE

- The Music Library includes a number of duets. While a duet is selected, you can turn off the first piano (Primo) or second piano (Secondo) tone and play along with the song.
- Some music library tunes incorporate tempo changes in their arrangements. Because of this, the playback tempo may at times be faster or slower than the tempo setting.

PREPARATION

- Select the song you want to practice and adjust the tempo. See step 3 under “Using the Metronome” (page EN-11).

1. While holding down the **FUNCTION** button, press the **▶/■** button to select the part you want to turn off.

- Pressing a button toggles its part on (button lamp on) and off (button lamp off).

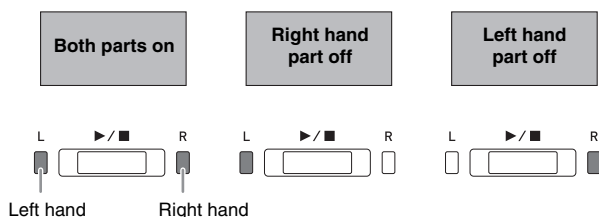

2. Press the **▶/■** button.
 - This starts playback, without the part you turned off in step 1.
3. Play the missing part on the keyboard.
4. To stop playback, press the **▶/■** button again.

Playing Back Audio Data Stored on a USB Flash Drive

You can use your Digital Piano to play back audio data (WAV files*) stored on a commercially available USB flash drive.

See “USB Flash Drive” on page EN-35 for more information.

* Linear PCM, 16bit, 44.1 kHz, Stereo

PREPARATION

- Prepare a USB flash drive that contains data recorded to it using the Digital Piano’s Audio Recorder. See “Recording to a USB Flash Drive (Audio Recorder)” on page EN-21 for more information.
- You can also use a computer to save audio data (WAV file) to the USB Flash Drive for playback. See “Storing Standard Audio Data (WAV Files) to a USB Flash Drive” on page EN-36 for more information.
- Insert the USB flash drive that contains the data you want to play back into your Digital Piano’s USB flash drive port.

1. Press the **AUDIO REC** button once or twice so the **AUDIO REC** lamp is lit.
 - This enters playback standby.
2. Hold down the **FUNCTION** button and press a **MUSIC LIBRARY SELECT** keyboard key.
 - Pressing the plus (+) key scrolls forward through song file names (TAKE01.WAV, TAKE02.WAV, etc.) Pressing the minus (-) key scrolls backward.
 - You also can use the number (0 through 9) keyboard keys to specify a file number (1 to 99) directly. The Digital Piano will beep if there is no file that corresponds to the number you input.
3. Press the **▶/■** button.
 - This will start playback of the selected song.
4. To stop playback of the song, press the **▶/■** button.

Recording and Playback

You can record notes you play with the Digital Piano's MIDI recorder for later playback. When a commercially available USB flash drive is inserted in the Digital Piano's USB flash drive port, audio data is recorded to and played back from the USB flash drive (Audio Recorder).

Recording to Built-in MIDI Recorder

Tracks

A track is a container of recorded data, and a song consists of two tracks: Track 1 and Track 2. You can record each track separately and then combine them so they play back together as a single song.

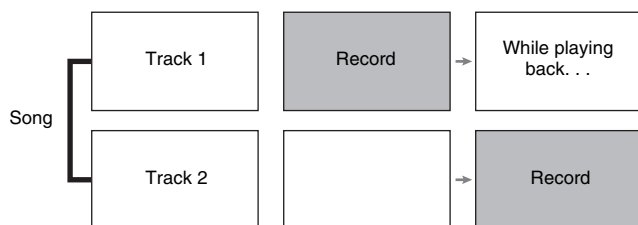

Memory Capacity

- You can record approximately 5,000 notes in Digital Piano memory.
- The **MIDI REC** button lamp will flash at high speed when memory runs low.
- Recording stops automatically if the number of notes in memory exceeds the maximum.

Recorded Data

- Keyboard play
- Tone used for keyboard play
- Beat (Track 1 only)
- Tempo setting (Track 1 only)
- Layer setting (Track 1 only)
- Duet (Track 1 only)
- Temperament (Track 1 only)
- Keyboard volume (Track 1 only)
- Chorus (Track 1 only)
- Brilliance (Track 1 only)
- Hall Simulator setting (Track 1 only)
- Acoustic Simulator (Track 1 only)

Recording Data Storage

- Starting a new recording deletes any data that was previously recorded in memory.
- Should power fail during recording, all of the data in the track you are recording will be deleted.

IMPORTANT!

- CASIO COMPUTER CO., LTD. takes no responsibility for any damages, lost profits, or claims by third parties arising from the deletion of recorded data due to malfunction, repair, or for any other reason.

Using the MIDI REC Button

Each press of the **MIDI REC** button cycles through the recording options in the sequence shown below.

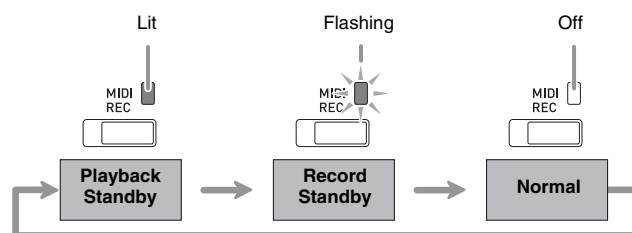

Recording to a Specific Song Track

After recording to either of the tracks of a song, you can record to the other track while listening to playback what you recorded in the first track.

1. Press the **MIDI REC** button once or twice so the MIDI REC lamp is flashing.

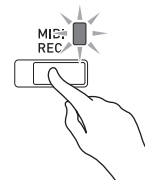

- At this time the **L** lamp will flash to indicate that the Digital Piano is standing by for recording to Track 1.

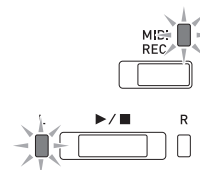

2. While holding down the **FUNCTION** button, press the ►/■ button to select the track you want to record.

- Make sure that the indicator lamp for the record track is flashing.
Track 1: **L** lamp
Track 2: **R** lamp

Example: Track 1 selected

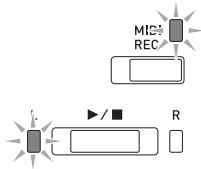

3. Select the tone and effects (Track 1 only) you want to use in your recording.

- Tone (page EN-6)
- Effects (page EN-9)

NOTE

- If you want the metronome to sound while you are recording, configure the beat and tempo settings, and then press the **METRONOME** button. See “Using the Metronome” on page EN-11 for more information.

4. Press the ►/■ button or start playing.

- Recording will start automatically.

5. To stop recording, press the ►/■ button.

- This will cause the **MIDI REC** button lamp and the lamp of the track you recorded to change from flashing to lit.
- To play back the track you just recorded, press the ►/■ button.

6. After you are finished recording or playing back, press the **MIDI REC** button so its lamp goes out.

Recording to One Track while Listening to Playback of the Other Track

1. Press the **MIDI REC** button so its lamp is lit.

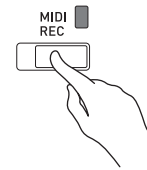

2. While holding down the **FUNCTION** button, press the ►/■ button to select the track you want to play back while recording.

3. Press the **MIDI REC** button so its lamp is flashing.

- This will cause the **L** lamp to flash.

4. While holding down the **FUNCTION** button, press the ►/■ button to select the track you want to record.

- Make sure that the indicator lamp for the record track is flashing.

Example: To listen to playback of Track 1 as you record to Track 2

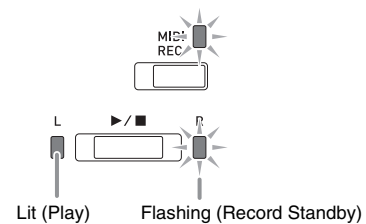

5. Select the tone and effects (Track 1 only) you want to use for your recording.

6. Press the ►/■ button or start playing.

- This will start both playback of the recorded track and recording to the other track.
- If, while recording is in progress, you want to re-record from the beginning, hold down the **MIDI REC** button until the Digital Piano beeps. This discards the current recording data and enters recording standby.

7. To stop recording, press the ►/■ button.

Playing Back from Digital Piano Memory

1. Press the **MIDI REC** button so its lamp is lit.

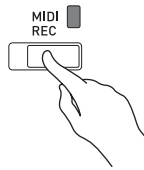

NOTE

- When a song has something recorded in both tracks, you can turn off one track and play back just the other track, if you want.

2. Press the **▶/■** button.

- This starts playback of the song and/or track you selected.

NOTE

- You can change the tempo setting as a track is playing.
- Press the **▶/■** button again to stop playback.

Deleting Recorded Data

The following procedure deletes a specific track of a song.

IMPORTANT!

- The procedure below deletes all of the data of the selected track. Note that the delete operation cannot be undone. Check to make sure you really do not need the data in Digital Piano memory before you perform the following steps.

1. Press the **MIDI REC** button once or twice so the MIDI REC lamp is flashing.

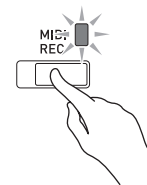

2. While holding down the **FUNCTION** button, press the **▶/■** button to select the track you want to delete.

3. Press the **MIDI REC** button until its lamp is lit.

- This will cause the lamp of the track you selected in step 2 of this procedure to flash.

Example: If you selected Track 2 for deletion

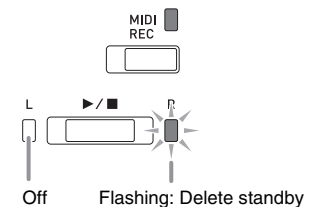

4. Once again, hold down the **FUNCTION** button as you press the **▶/■** button.

- This deletes the selected track and enters record standby.
- To cancel the delete operation at any time, press the **MIDI REC** button so its lamp becomes unlit.

NOTE

- Only the Digital Piano's **▶/■** button are operational from step 3 until you actually perform the delete operation in step 4. No other button operation can be performed.

Recording to a USB Flash Drive (Audio Recorder)

Anything played on the Digital Piano is recorded to the USB flash drive as audio data (WAV files*). If you play along on the Digital Piano as you play back data stored in song memory, the memory playback and your keyboard play are both recorded to USB flash drive.

* Linear PCM, 16bit, 44.1 kHz, Stereo

Recording Capacity

- 99 files (TAKE01.WAV to TAKE99.WAV)
- Approximately 25 minutes maximum recording per file.

Recorded Data

- Everything played on the Digital Piano and operation sounds are recorded.*
 - Individual part recording is not supported.
- * If you do not want operation sounds to be recorded, turn them off. Refer to “Ⓞ Operation tone” in the “Parameter List” on pages EN-28 through EN-33.

Recording Data Storage

Each new recording of audio data to a USB flash drive is automatically assigned a new file name, so existing data is not overwritten.

Recording Digital Piano Play (Audio Recorder)

PREPARATION

- Be sure to format the USB flash drive on the Digital Piano before using it. See “USB Flash Drive” on page EN-35 for more information.

1. Insert the USB flash drive into the Digital Piano’s USB flash drive port.

- When you plug in a USB flash drive, the Digital Piano initially needs to “mount” the USB flash drive and prepare for data exchange. Note that Digital Piano operations are momentarily disabled while a USB flash drive mounting sequence is being performed. The Digital Piano’s L/R lamps flash while the mounting process is in progress. It may take up to 10 or 20 seconds or even longer for a USB flash drive to be mounted. Do not attempt to perform any operation on the Digital Piano while a mounting sequence is in progress (while L/R lamps are flashing). A USB flash drive needs to be mounted each time it is connected to the Digital Piano.

2. Press the **AUDIO REC** button once or twice so the AUDIO REC lamp is flashing.

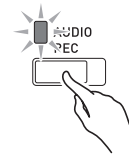

3. To start recording, press the ►/■ button or start playing.

This starts recording to the USB flash drive.

- Recording can also be started by pressing a pedal or performing another operation.
- If, while recording is in progress, you want to re-record from the beginning, hold down the **AUDIO REC** button until the Digital Piano beeps. This discards the current recording data and enters recording standby.

NOTE

- Do not remove the USB flash drive from the USB flash drive port while the **AUDIO REC** lamp is flashing. Doing so interrupts recording and may corrupt data.

4. To stop recording, press the ►/■ button or **AUDIO REC** button.

- If you want to continue recording, perform the operations from step 2 of this procedure. If you want to play back what you recorded, perform the operations from step 3 under “Playing Back Data Recorded on a USB Flash Drive” (page EN-22). To exit the audio record/playback operation, press the **AUDIO REC** button so its lamp becomes unlit.

Recording Digital Piano Play as Data Recorded in MIDI Recorder Plays Back (Audio Recorder)

1. Press the **MIDI REC** button once or twice until the MIDI REC lamp is lit.

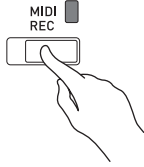

2. Hold down the **FUNCTION** button and press the **▶/■** button to select the playback track.

3. Press the **AUDIO REC** button once or twice so the AUDIO REC lamp is flashing.

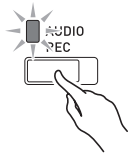

4. To start recording, press the **▶/■** button or start playing.
 - This simultaneously starts playback of the content recorded on the MIDI recorder and recording to the USB flash drive.
5. To stop playback and recording, press the **▶/■** button.
 - If you want to continue recording, perform the operations from step 2 under "Recording Digital Piano Play (Audio Recorder)" (page EN-21). If you want to play back what you recorded, perform the operations from step 3 under "Playing Back Data Recorded on a USB Flash Drive" (page EN-22). To exit the audio record/playback operation, press the **AUDIO REC** button so its lamp becomes unlit.

Playing Back Data Recorded on a USB Flash Drive

1. Press the **AUDIO REC** button once or twice so the AUDIO REC lamp is lit.



2. Select the song you want to play back.

If you want to play back the last file you recorded, jump directly to step 3.

- To select the previous song

Hold down the **FUNCTION** button and press the Select Music Library Song minus (-) key.

Each press scrolls back one song.

- To scroll in file number sequence

Hold down the **FUNCTION** button and press the Select Music Library Song plus (+) key.

Each press scrolls forward one song.

- To specify a file number

Use the Select Music Library Song number keys (0 through 9) to specify the file number (1 to 99) you want. (TAKE01.WAV, TAKE02.WAV, etc.)

The Digital Piano beeps if a file with the specified number does not exist.

3. To start playback, press the **▶/■** button.
4. To stop playback of the song, press the **▶/■** button.

Adjusting the Audio Recorder Volume Level

You can use the procedure below to adjust the volume level of audio data recorded to a USB flash drive.

1. While holding down the **FUNCTION** button, use the Audio Recorder Volume keyboard keys to adjust the volume level.
 - For details about using the keyboard keys for settings, see “Keyboard Keys Used for Configuring Settings” (page EN-26).
 - Each press of the + (increase) or – (decrease) keyboard key changes the volume value by 1.

NOTE

- To return to the initial default setting, press the + and – keyboard keys at the same time.

Deleting an Audio File from a USB Flash Drive

Files can be deleted one at a time.

IMPORTANT!

- The procedure below deletes all of the data of the selected file. Note that the delete operation cannot be undone. Check to make sure you really do not need the data in Digital Piano memory before you perform the following steps.

1. Press the **AUDIO REC** button once or twice so the AUDIO REC lamp is lit.



2. Select the song you want to delete.

If you want to delete the last file you recorded, jump directly to step 3.

- To select the previous song

Hold down the **FUNCTION** button and press the Select Music Library Song minus (–) key.

Each press scrolls back one song.

- To scroll in file number sequence

Hold down the **FUNCTION** button and press the Select Music Library Song plus (+) key.

Each press scrolls forward one song.

- To specify a file number

Use the Select Music Library Song number keys (0 through 9) to specify the file number (1 to 99) you want. (TAKE01.WAV, TAKE02.WAV, etc.)

The Digital Piano beeps if a file with the specified number does not exist.

3. Press the **AUDIO REC** button so the AUDIO REC lamp is flashing.

4. Hold down the **AUDIO REC** button until both the L and R lamps flash.

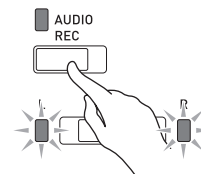

5. Once again, hold down the **FUNCTION** button as you press the **▶/■** button.

- To cancel the delete operation at any time, press the **AUDIO REC** button so its lamp is unlit.

 **NOTE**

- When you record a new file, it is always automatically assigned the next new file number in the sequence of files currently on the USB flash drive, even if a previous number is unused (because a file was deleted).

Configuring Settings with the Keyboard

In addition to selecting tones and songs (Concert Play or Music Library), you also can use the **FUNCTION** button in combination with the keyboard keys to configure effect, keyboard touch, and other settings.

To configure settings with the keyboard

1. Use the “Parameter List” on pages EN-28 - EN-33 to find the setting you want to configure, and note its details.
2. Use “Keyboard Keys Used for Configuring Settings” on page EN-26 to find the location on the keyboard for configuring the setting you want.
3. While holding down the **FUNCTION** button, press the keyboard key for the setting you want to configure.
 - The Digital Piano will sound an operation tone after it configures the setting.

Example: To lower the Concert Play volume, press the CONCERT PLAY VOLUME minus (–) key.

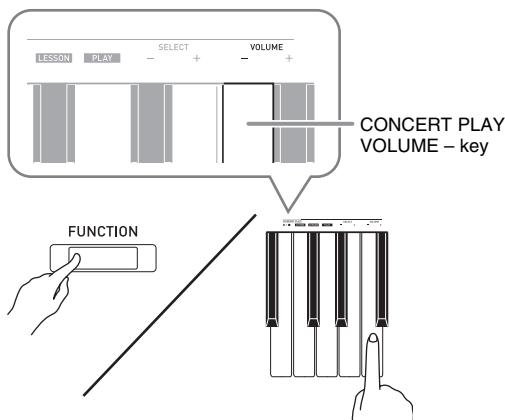

4. Release the **FUNCTION** button to complete the setting procedure.

NOTE

- You can configure the Digital Piano so no operation tone sounds in step 3. For details, see “**Operation tone**” under “Parameter List” on pages EN-28 - EN-33.

Keyboard Setting Operation Types

There are four types of operations that you can perform while configuring settings with the keyboard keys: Type A, Type B, Type C, and Type D.

Type A: Direct input

Example: Pressing the GRAND PIANO 1 BRIGHT keyboard key to select the GRAND PIANO 1 BRIGHT tone

Type B: Raising or lowering a setting using the + and – keyboard keys

- Holding down a key raises or lowers the setting at high speed.
- To return to the initial default setting, press both keys at the same time.

Type C: Inputting a value using the number (0 through 9) keyboard keys.

- To input a two-digit value, press 0 and then 2. To input a three-digit value, press 0, 2, and then 0.

Type D: Toggling or cycling through settings by pressing a keyboard key

- When you press a key, the Digital Piano will beep to let you know which setting is selected.
- A long beep indicates that the applicable setting is turned off.

Example: While chorus is turned off, pressing the Chorus keyboard key twice will cause the Digital Piano to beep twice, which indicates that the Medium Chorus setting is selected.

NOTE

- You can find out what operation type applies to each setting by checking the “Operation Type” in the “Parameter List” on pages EN-28 - EN-33.

Keyboard Keys Used for Configuring Settings

- The numbers ① through ⑰ correspond to the same numbers in the “Parameter List” on pages EN-28 - EN-33.

[Left keyboard]

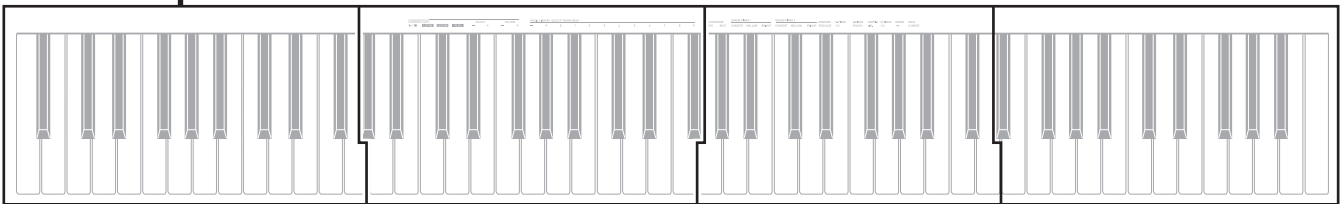
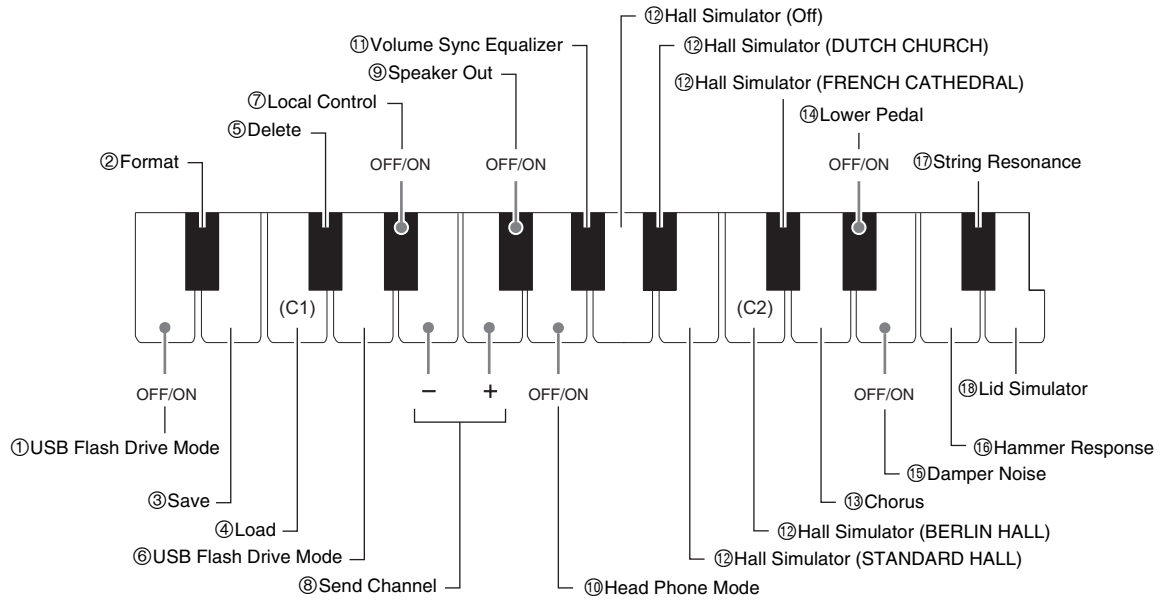

[Overall]

[Middle Left Keyboard]

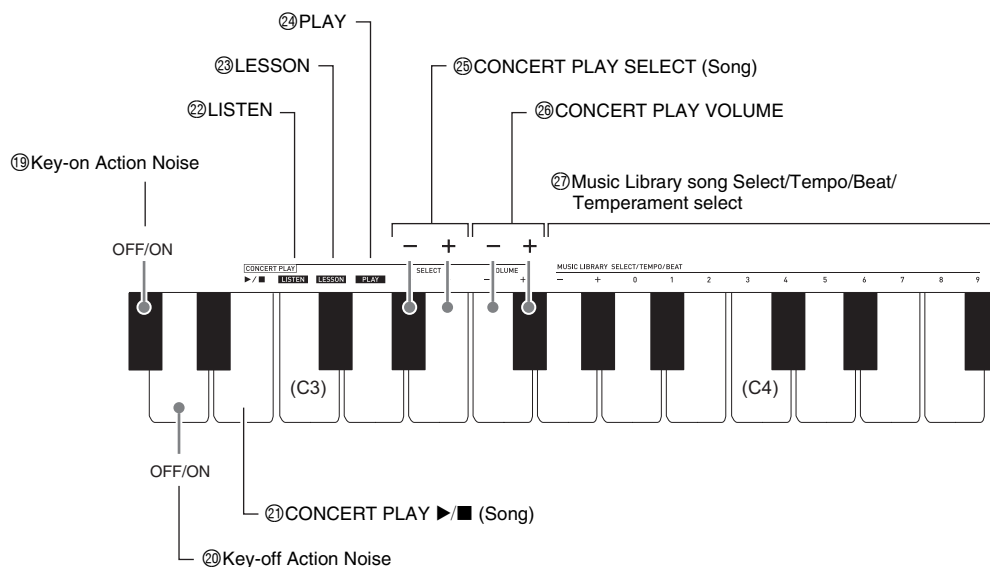

[Middle Right Keyboard]

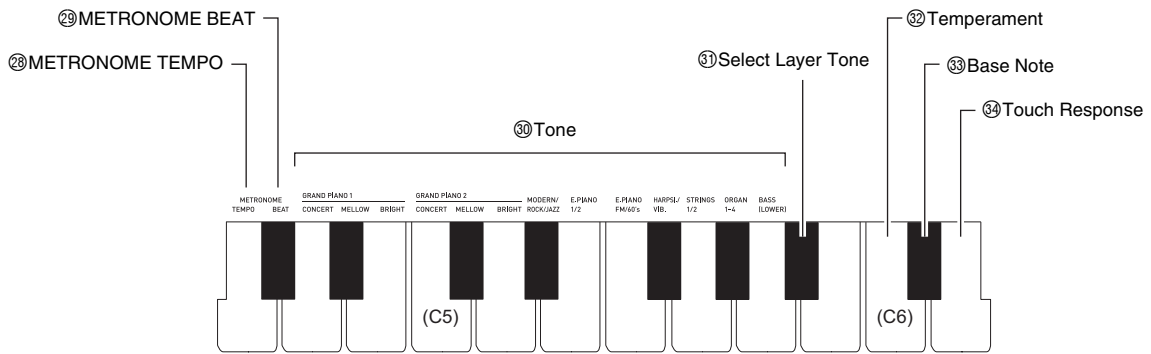

[Overall]

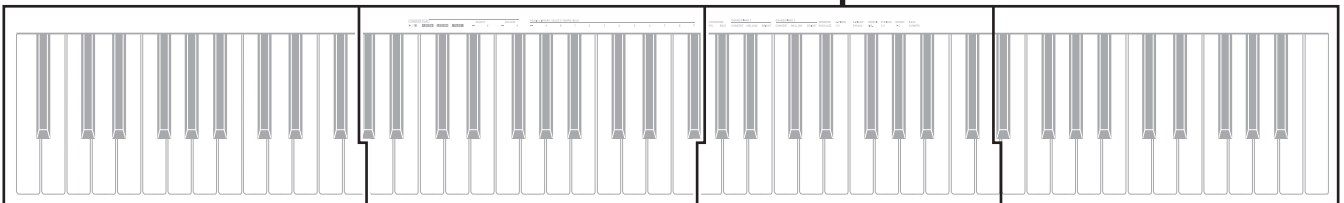

[Right keyboard]

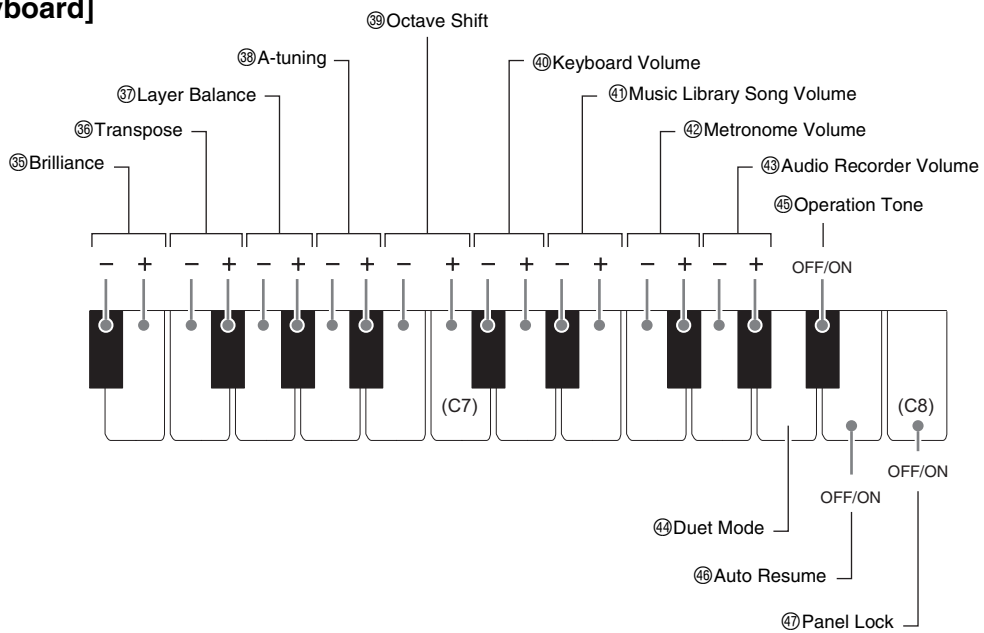

Parameter List

■ Tones

| Parameter | Settings | Operation Type (page EN-25) | Description | Remarks |
|------------------------|---|-----------------------------|---|---|
| ⑫ Hall simulator | Off, DUTCH CHURCH to FRENCH CATHEDRAL Default: STANDARD HALL | A | Specifies the hall simulator of notes. (page EN-9) | |
| ⑩ Tone selection | See page EN-6. Default: GRAND PIANO (CONCERT) | A | Assigns a tone to the keyboard. (page EN-6) | |
| ⑬ Chorus | Off, 1 to 4 Default: Off | D | Controls the breadth of notes. (page EN-9) | |
| ⑮ Brilliance | -3 to 0 to 3 Default: 0 | B | Specifies the brilliance of notes. Pressing [+] makes notes brighter and harder. Pressing [-] makes notes mellower and softer. | <ul style="list-style-type: none"> To return the setting to its initial default (0), press [+] and [-] at the same time. |
| ⑰ Layer balance | -24 to 0 to 24 Default: -10 | B | Specifies the volume balance between the main tone and the layered tone. (page EN-8) | <ul style="list-style-type: none"> To return the setting to its initial default (-10), press [+] and [-] at the same time. |
| ⑭ Lower Pedal | Off, On Default: Off | D | When turned on and the BASS (LOWER) tone is selected, pressing the damper pedal or sostenuto pedal will apply sustained reverberation to the BASS (LOWER) tone. (page EN-7) | |
| ⑮ Damper noise | Off, On Default: On | D | Enables/disables damper noise output. (page EN-10) | |
| ⑯ Hammer response | Off, 1 to 4 Default: Depends on tone | D | Specifies the time lag between when a key is pressed and the note actually sounds. A greater value specifies a longer time lag. (page EN-7) | |
| ⑰ String resonance | Off, 1 to 4 Default: Depends on tone | D | Specifies the string resonance that is characteristic of an acoustic piano. A larger value increases the resonance level. (page EN-7) | |
| ⑱ Lid simulator | 1 to 4 Default: Depends on tone | D | Specifies the lid its open position effect. (page EN-7) | |
| ⑲ Key-on action noise | Off, On Default: On | D | Enables or disables reproduction of the mechanical operation sound (noise) that can be heard when keys of an acoustic piano are tapped with extremely light pressure. | |
| ⑳ Key-off action noise | Off, On Default: On | D | Enables or disables reproduction of the mechanical operation sound (noise) that can be heard when keys of an acoustic piano are released. | |

| Parameter | Settings | Operation Type (page EN-25) | Description | Remarks |
|---------------------|------------------------------|-----------------------------|---|--|
| ③ Select layer tone | Off, On Default: Off | D | Enables or disables layering. (page EN-8) | <ul style="list-style-type: none"> • BASS (LOWER) cannot be layered with another tone. • Configuring of layering settings is not supported for recording function Track 2 recording. |
| ④ Duet mode | Off, On, Pan Default: Off | D | Enables or disables the Duet Mode. (page EN-12) | <ul style="list-style-type: none"> • When Pan is specified, Hall Simulator and Chorus effects cannot be applied. |

■ Song/Metronome

| Parameter | Settings | Operation Type (page EN-25) | Description | Remarks |
|--|---------------------------|-----------------------------|---|---|
| ⑳ Music Library song select (MUSIC LIBRARY SELECT) | 1 to 70 Default: 1 | B C | Selects a Music Library tune. (page EN-16) | <ul style="list-style-type: none"> This setting cannot be changed while recording. |
| ㉑ Tempo (TEMPO) | 20 to 255 Default: 120 | B C | Specifies the tempo of Concert Play Lesson Mode songs, Music Library songs, the metronome, recording and playback, etc. (page EN-11) | <ul style="list-style-type: none"> During recording, pressing + and – at the same time sets a value of 120. |
| ㉒ Beat (BEAT) | 0 to 9 Default: 4 | C | Specifies the metronome beat. (page EN-11) | <ul style="list-style-type: none"> The tempo cannot be changed while in the Concert Play LISTEN Mode or PLAY Mode. |
| ㉓ METRONOME TEMPO | – | – | Enters a setting mode for specifying the metronome tempo with keyboard keys. Use the ㉑ TEMPO keyboard keys to input a tempo value. (page EN-11) | <ul style="list-style-type: none"> The tempo cannot be changed while in the Concert Play LISTEN Mode or PLAY Mode. |
| ㉔ METRONOME BEAT | – | – | Enters a setting mode for specifying the metronome beat with keyboard keys. Use the ㉒ BEAT keyboard keys to input a beat value. (page EN-11) | |
| ㉕ CONCERT PLAY ►/■ | Play, Stop | D | Toggles a Concert Play song between play and stop. (page EN-14) | <ul style="list-style-type: none"> This setting cannot be changed while recording. |
| ㉖ LISTEN | – | A | Enters the Concert Play Listen Mode. (page EN-14) | <ul style="list-style-type: none"> This setting cannot be changed while recording. |
| ㉗ LESSON | – | A | Enters the Concert Play Lesson Mode. (page EN-15) | <ul style="list-style-type: none"> This setting cannot be changed while recording. |
| ㉘ PLAY | – | A | Enters the Concert Play Play Mode. (page EN-16) | <ul style="list-style-type: none"> This setting cannot be changed while recording. |
| ㉙ CONCERT PLAY SELECT (Song) (SELECT +/-) | 1 to 10 Default: 1 | B | Specifies a Concert Play song number. (page EN-14) | <ul style="list-style-type: none"> This setting cannot be changed while recording. |
| ㉚ CONCERT PLAY VOLUME (VOLUME +/-) | 0 to 42 Default: 32 | B | Sets the volume level of Concert Play playback. | <ul style="list-style-type: none"> This setting cannot be changed while recording. |
| ㉛ Music Library Song Volume | 0 to 42 Default: 42 | B | Sets the volume level of Music Library playback. | <ul style="list-style-type: none"> This setting cannot be changed while recording. |
| ㉜ Metronome volume | 0 to 42 Default: 36 | B | Specifies the metronome volume. (page EN-12) | |

Keyboard

| Parameter | Settings | Operation Type (page EN-25) | Description | Remarks |
|--|---|---|--|---|
| ㉔ Temperament ㉕ Temperament Base note ㉗ Temperament select | Temperament: 0 to 16 Base note: C to B Defaults: Temperament: 0 (Equal Temperament) Base note: C | <Selecting a Temperament> While holding down the FUNCTION button, press the applicable keyboard keys as described below. 1. Press the ㉔ Temperament keyboard key. 2. Use the ㉗ Temperament Select keyboard keys to select the desired temperament. <ul style="list-style-type: none"> If you want to advance directly base note selection from here, release the FUNCTION button and continue with the procedure below. <Selecting a Base Note> While holding down the FUNCTION button, press the applicable keyboard keys as described below. 1. Press the ㉕ Base Note keyboard key. 2. Press the keyboard key of the note you want to specify as the base note. You can specify any note in any register. | You can change the scale (tuning system) of the keyboard from standard equal temperament to another tuning that is more suitable for playing Indian music, Arabic music, classical pieces, etc. <ul style="list-style-type: none"> When you select any temperament other than "Equal", you must also configure a base note (base note of the temperament of the song being performed) setting. For details about temperament, refer to a book that covers music theory. | <Temperaments> 0: Equal / 1: Pure Major / 2: Pure Minor / 3: Pythagorean / 4: Kirnberger 3 / 5: Werckmeister / 6: Mean-Tone / 7: Rast / 8: Bayati / 9: Hijaz / 10: Saba / 11: Dashti / 12: Chahargah / 13: Segah / 14: Gurjari Todi / 15: Chandrakauns / 16: Charukeshi |
| ㉘ Touch response | Off, 1 to 3 Default: 2 | D | Specifies the relative touch of the keyboard keys. Setting a smaller value causes lighter touch to produce more powerful sound. | <ul style="list-style-type: none"> Each press of the keyboard key causes it to beep the number of times shown below to indicate the current setting. Once (long): Off Once (short): 1 Twice: 2 Three times: 3 |
| ㉙ Transpose | -12 to 0 to 12 Default: 0 | B | Raises or lowers the tuning of the Digital Piano in semitone steps. | <ul style="list-style-type: none"> The transpose setting cannot be changed while in the Duet Mode. Raising the key of the Digital Piano can cause notes the highest part of the range to become distorted. |
| ㉚ A-tuning | 415.5Hz to 440.0Hz to 465.9Hz Default: 440.0Hz | B | Raises or lowers the overall pitch of the Digital Piano in 0.1Hz steps from the standard pitch of A4 = 440.0Hz. | <ul style="list-style-type: none"> To toggle between the two settings below, hold down the FUNCTION button and press the A-tuning keyboard keys (+ and -) at the same time. 440.0 Hz (1 beep) 442.0 Hz (2 beeps) |
| ㉛ Octave shift | -2 to 0 to 2 Default: 0 | B | Change the range of the keyboard in octave units. | |
| ㉜ Keyboard volume | 0 to 42 Default: 42 | B | Adjusts the volume levels of all parts that are controlled by the keyboard. | |

■ MIDI and Other Settings

| Parameter | Settings | Operation Type (page EN-25) | Description | Remarks |
|--------------------------|--------------------------------|-----------------------------|---|---|
| ⑥ USB flash drive mode | MIDI, Storage Default: MIDI | D | The Digital Piano enters MIDI mode automatically when it is connected to a computer by a USB cable. Select storage when saving Recorder memory song data to a computer or when loading computer song data to Digital Piano memory. (page EN-46) | <ul style="list-style-type: none"> After this setting is changed to Storage, the GRAND PIANO 1, GRAND PIANO 2, and R lamps will flash, and all other lamps will be unlit. All Digital Piano operations are disabled at this time. Each press of the USB device mode keyboard key toggles between the MIDI and storage modes. |
| ⑦ Local control | Off, On Default: On | D | Selecting "Off" for Local control cuts off the Digital Piano's sound source, so no sound is produced by the Digital Piano when keys are pressed. | |
| ⑧ Send channel | 1 to 16 Default: 1 | B | Specifies one of the MIDI channels (1 through 16) as the Send channel, which is used for sending MIDI messages to an external device. | |
| ④③ Audio Recorder Volume | 00 to 42 Default: 42 | B | You can adjust the volume level of audio data recorded to a USB flash drive. | <ul style="list-style-type: none"> The volume level cannot be adjusted while recording. |
| ④⑤ Operation tone | Off, On Default: On | D | Selecting "Off" disables sounding of the operation tone whenever a keyboard key is pressed while the FUNCTION is depressed. | <ul style="list-style-type: none"> This setting is retained even when the Digital Piano is turned off. |
| ④⑦ Panel lock | Off, On Default: Off | D | Selecting "On" for this setting locks the Digital Piano's buttons (except for the  (Power) button and the buttons required for unlock), so no operation can be performed. Turn on operation lock when you want to protect against unintentional button operations. | |

| Parameter | Settings | Operation Type (page EN-25) | Description | Remarks |
|-------------------------|--|-----------------------------|---|---|
| ① USB flash drive mode | Off, On Default: Off | – | USB flash drive mode. | |
| ② Format | Off, On Default: Off | – | Formats a USB flash drive. | |
| ③ Save | Off, On Default: Off | – | Stores data to a USB flash drive. | |
| ④ Load | Off, On Default: Off | – | Loads data from a USB flash drive to Digital Piano song memory. | |
| ⑤ Delete | Off, On Default: Off | – | Deletes USB flash drive data. | |
| ⑨ Speaker out | Off, On Default: Off | D | When On is selected for this setting, sound is output to the speakers even while headphones are connected. | |
| ⑩ Head phone mode | Off, On Default: On | D | When On is selected for this setting, natural sounding acoustic piano tones are reproduced when using headphones. | |
| ⑪ Volume Sync Equalizer | Off, Weak, Normal, Strong Default: Normal | D | Automatically performs timbre compensation in accordance with the volume level. This feature ensures that low range and/or high range sounds are easier to hear, even at low volume levels. | <ul style="list-style-type: none"> • Off: No equalization • Weak: Weak equalization • Normal: Normal equalization • Strong: Strong equalization |
| ④⑥ Auto Resume | Off, On Default: Off | D | When On is selected for this setting, the Digital Piano will remember its settings whenever it is turned off, and restore them when power is turned on again. When Off is selected, settings are reset to their initial defaults whenever the Digital Piano is turned on. | <ul style="list-style-type: none"> • The settings below are not remembered, even if Auto Resume is enabled. Duet Mode Layered Tune LR (part) setting Local Control |

Linking with an Application (APP Function)

Your Digital Piano can connect with a smartphone, tablet, or other smart device. A special app is available to display music scores and a piano roll display to support your practice.

Downloading the Special App

Go to the website below to download the app and install it on your smart device.

<http://web.casio.com/app/en/>



USB Flash Drive

Your Digital Piano supports the following USB flash drive operations.

- Direct recording of keyboard play to the USB flash drive as audio (.WAV) data
 - ☞ See “Recording to a USB Flash Drive (Audio Recorder)” (page EN-21).
- Direct playback of audio (.WAV) data stored on a USB flash drive
 - ☞ See “Storing Standard Audio Data (WAV Files) to a USB Flash Drive” (page EN-36) and “Playing Back Audio Data Stored on a USB Flash Drive” (page EN-17).
- Using the Song Recorder to save recorded song (.MID) data to a USB flash drive
 - ☞ See “Saving a Recorded Song to a USB Flash Drive” (page EN-38)
- Loading of song (.MID, .CM2) data stored on a USB flash drive to a Digital Piano user song number
 - ☞ See “Loading Song Data from a USB Flash Drive into Digital Piano Memory” (page EN-40)
- Direct playback of song (.MID, .CM2) data from a USB flash drive
 - ☞ See “Simple Play Back of a Song on a USB Flash Drive” (page EN-42).
- See “Formatting a USB Flash Drive” (page EN-37).
- See “Deleting Data from a USB Flash Drive” (page EN-41)

■ Supported USB Flash Drives

Capacity: 32GB or less recommended

IMPORTANT!

- Operation of the above type of USB flash drive has been confirmed, but this does not guarantee operation.
- Use a FAT (FAT32) format USB flash drive.
- You may not be able to use a USB flash drive that is recognized as multiple drives on your computer.
- A USB flash drive that is recognized as a CD-ROM on your computer is not supported.
- A USB flash drive with an anti-virus function and/or security functions is not supported.

■ Data Types Supported by the Digital Piano

- .MID : Can be stored in Digital Piano memory, on a USB flash drive, or on a computer (connected via USB).
- .CM2 : Can be stored in Digital Piano memory, on a USB flash drive, or on a computer (connected via USB).
- .CSR : Can be stored in Digital Piano memory or on a computer (connected via USB).
- .WAV: Can be saved on a USB flash drive.

■ Save and Load Data Formats and Capacities

| Data Type | Description (File Name Extension) | Supported Operations | |
|--|--|-------------------------|---------------------------|
| | | Save to USB flash drive | Load from USB flash drive |
| User songs (page EN-46) | One of the following two types of music data 1. CASIO format data (CM2) 2. Standard MIDI files (MID) SMF Format 0 or Format 1 | - | ○ |
| Songs recorded with song recorder (page EN-18) | Song data recorded on this Digital Piano (MID) | ○* | - |

* Can be converted to a standard MIDI file (SMF format 0, file name extension .MID) and saved.

NOTE

- Since audio data can be directly recorded to and played back from a USB flash drive, there is no need to store or load it into Digital Piano memory.

Storing Standard Audio Data (WAV Files) to a USB Flash Drive

Performing a record operation with the Digital Piano's audio recorder creates a folder named AUDIO on the USB flash drive. WAV files are stored in the AUDIO folder, automatically assigning them names from TAKE01.WAV to TAKE99.WAV. You also can connect a USB flash drive to a computer and change the names of audio data (WAV) files to the format "TAKEXX.WAV"*, and move them to the AUDIO folder. Then you will be able to play them back on the Digital Piano.

* XX = 01 to 99

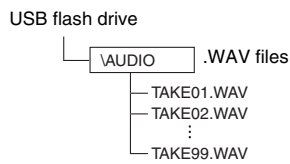

For information about playback see "Playing Back Audio Data Stored on a USB Flash Drive" (page EN-17).

USB Flash Drive and USB Flash Drive Port Handling Precautions

IMPORTANT!

- Be sure to observe the precautions provided in the documentation that comes with the USB flash drive.
- Avoid using a USB flash drive under the following conditions. Such conditions can corrupt data stored on the USB flash drive.
 - Areas subjected to high temperature, high humidity, or corrosive gas
 - Areas subjected to strong electrostatic charge and digital noise
- Never remove the USB flash drive while data is being written to or loaded from it. Doing so can corrupt the data on the USB flash drive and damage the USB flash drive port.
- Never insert anything besides a USB flash drive into the USB flash drive port. Doing so creates the risk of malfunction.
- A USB flash drive can become warm after very long use. This is normal and does not indicate malfunction.
- Static electricity conducted to the USB flash drive port from your hand or from a USB flash drive can cause malfunction of the Digital Piano. If this happens, turn the Digital Piano off and then back on again.

Copyrights

You are allowed to use recordings for your own personal use. Any reproduction of an audio or music format file, without the permission of its copyright holder, is strictly prohibited under copyright laws and international treaties. Also, making such files available on the Internet or distributing them to third parties, regardless of whether such activities are conducted with or without compensation, is strictly prohibited under copyright laws and international treaties. CASIO COMPUTER CO., LTD. shall not be held in any way liable for any use of this Digital Piano that is illegal under copyright laws.

Connecting a USB Flash Drive to and Detaching It from the Digital Piano

IMPORTANT!

- Never plug any other device besides a USB flash drive into the USB flash drive port.
- When you plug in a USB flash drive, the Digital Piano initially needs to “mount” the USB flash drive and prepare for data exchange. Note that Digital Piano operations are momentarily disabled while a USB flash drive mounting sequence is being performed. The Digital Piano’s L/R lamps flash while the mounting process is in progress. It may take up to 10 or 20 seconds or even longer for a USB flash drive to be mounted. Do not attempt to perform any operation on the Digital Piano while a mounting sequence is in progress (while L/R lamps are flashing). A USB flash drive needs to be mounted each time it is connected to the Digital Piano.

■ To insert a USB flash drive

1. As shown in the illustration below, insert the USB flash drive into the Digital Piano’s USB flash drive port.
 - Carefully push the USB flash drive in as far as it will go. Do not use undue force when inserting the USB flash drive.

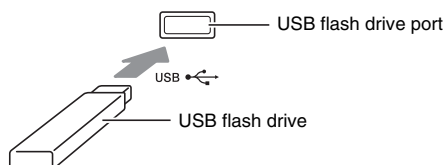

■ To remove a USB flash drive

1. Check to confirm that there is no data exchange operation being performed, and then pull the USB flash drive straight out.

Formatting a USB Flash Drive

IMPORTANT!

- Be sure to format a USB flash drive on the Digital Piano before using it for the first time.
- Before formatting a USB flash drive, make sure it does not have any valuable data stored on it.
- The format operation performed by this Digital Piano is a “quick format”. If you want to completely delete all of the data in USB flash drive, format it on your computer or some other device.

<Supported USB Flash Drives>

This Digital Piano supports USB flash drives formatted to FAT32. If your USB flash drive is formatted to a different file system, use the Windows format function to reformat it to FAT32. Do not use quick format.

■ USB Flash Driver Folder Structure Diagram

Formatting a USB flash drive on the Digital Piano will automatically create the folders shown in the diagram below.

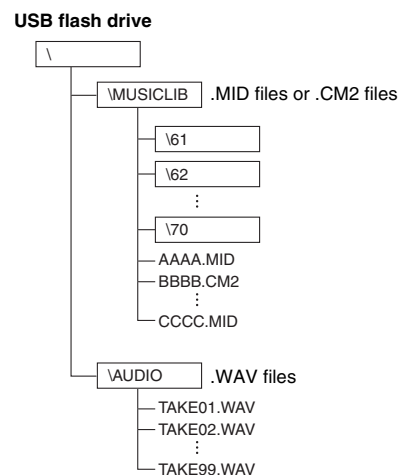

1. Insert the USB flash drive you want to format into the Digital Piano’s USB flash drive port.

2. While holding down the **FUNCTION** button, press the keyboard key that corresponds to the USB flash drive mode.

- This will cause the L/R lamps to flash.

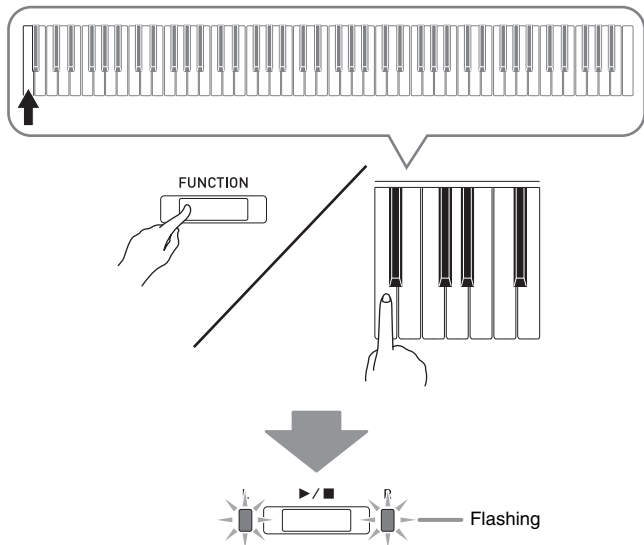

3. While holding down the **FUNCTION** button, press the format USB flash drive keyboard key.

- This will cause the **AUDIO REC** lamp to light.

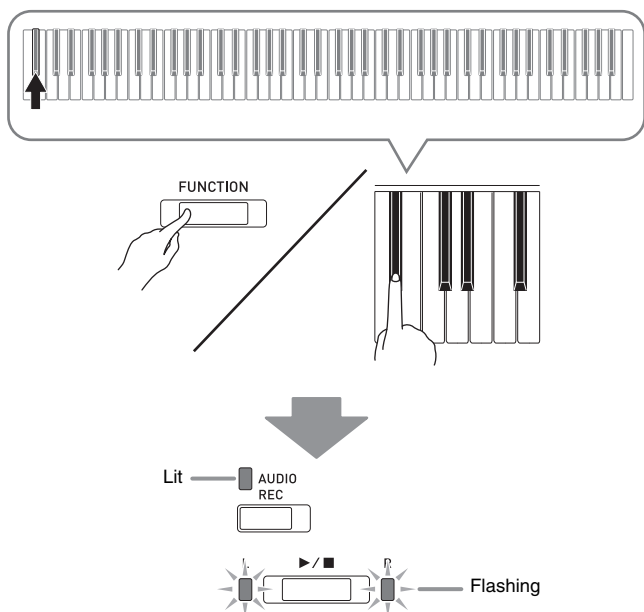

- To cancel the format operation, hold down the **FUNCTION** button as you press the USB flash drive mode key.

4. Press the **▶/■** button.

- This starts formatting.
- After formatting is complete, the L/R lamps will go out and the Digital Piano will exit the formatting operation.

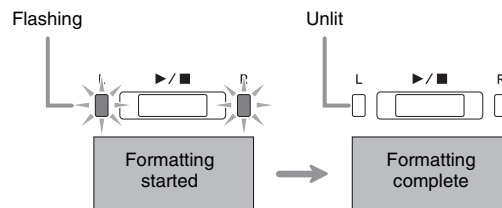

NOTE

- Formatting a large-capacity USB flash drive can take several minutes.

Saving a Recorded Song to a USB Flash Drive

Use the procedure below to save data you recorded on the Digital Piano to a USB flash drive as a MIDI file (SMF format 0).

- 1.** Insert the USB flash drive into the Digital Piano's USB flash drive port.
- 2.** While holding down the **FUNCTION** button, press the keyboard key that corresponds to the USB flash drive mode.
 - This will cause the L/R lamps to flash.

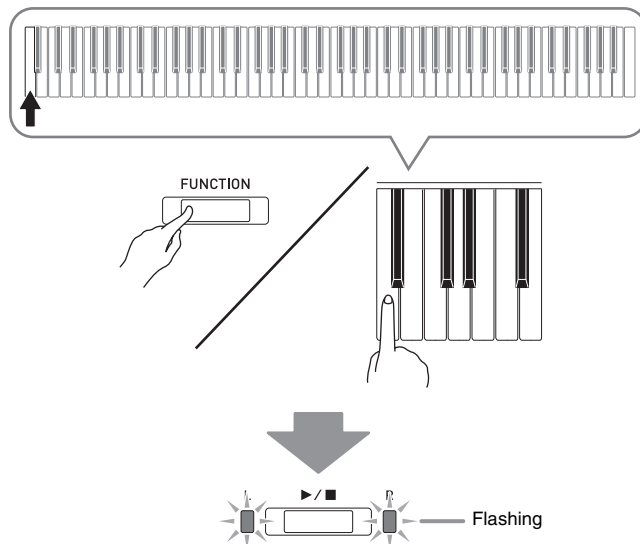

- 3.** While holding down the **FUNCTION** button, press the save USB flash drive keyboard key.
- This will cause the **MIDI REC** lamp to light.

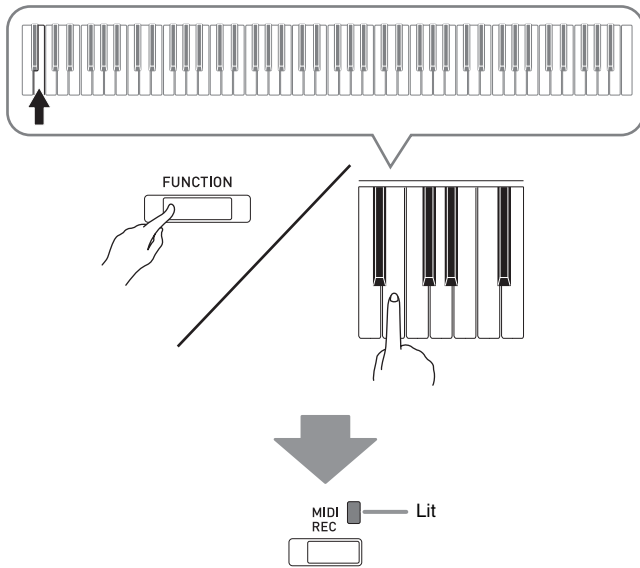

- To exit the data save operation, hold down the **FUNCTION** button as you press the USB flash drive mode key.

- 4.** Hold down the **FUNCTION** button as you use the **MUSIC LIBRARY SELECT** keyboard keys to select a song number (61 to 70).

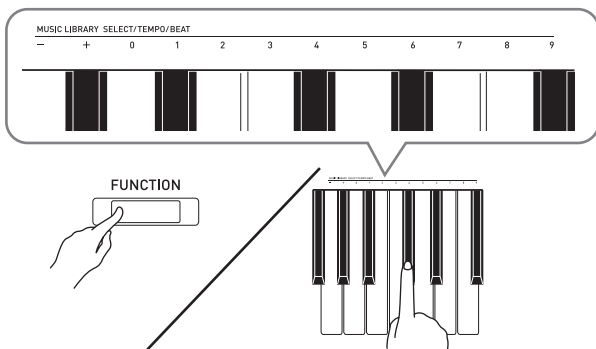

- The Digital Piano will emit a short beep if you specify a correct song number, and a long beep if the song number is not correct.

- 5.** Press the **▶/■** button.

- This starts the data save operation.
- When saving is complete, the L/R lamps will go out to indicate that the USB flash drive mode has been exited.

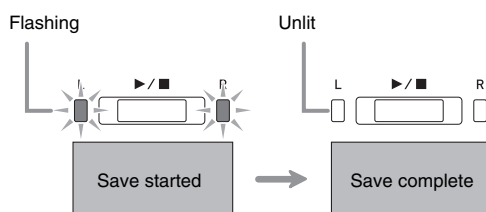

■ USB Flash Drive Data (File) Storage Locations

The above procedure stores piano data in a folder named **MUSICLIB** on the USB flash drive.

- The **MUSICLIB** folder is created automatically when you format the USB flash drive on the Digital Piano (page EN-37).
- Note that files not in the **MUSICLIB** folder cannot be loaded or deleted by this Digital Piano.
- The “**MUSICLIB**” folder contains sub-folders named “61” through “70”. Data is saved in the sub-folder whose name corresponds to the song number you specify in step 4 of the procedure above.

Loading Song Data from a USB Flash Drive into Digital Piano Memory

You can use the procedure below to load user song data (page EN-46) from a USB flash drive to the Digital Piano's Music Library (song numbers 61 to 70). After that, you can play back the user song or use it for lesson play.

NOTE

- Loading song data from a USB flash drive assigns it to the corresponding user song number. Loading song data 61 from a USB flash drive, for example, will assign it to user song number 61 in Digital Piano memory. Then you will be able to select the song by selecting user (Music Library) song 61.

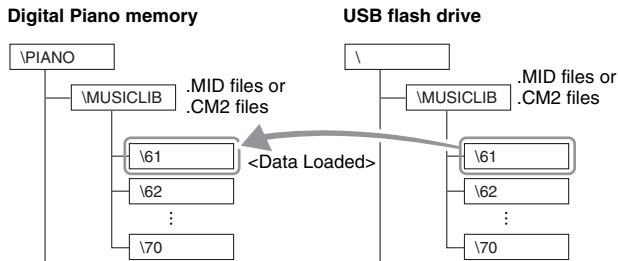

1. On your computer, copy the file you want to load to one of the numbered sub-folders (61 through 70) inside the "MUSICLIB" folder on the USB flash drive.
 - The number names of the sub-folders correspond to the Digital Piano's user song numbers (61 to 70).
2. Insert the USB flash drive into the Digital Piano's USB flash drive port.

3. While holding down the **FUNCTION** button, press the keyboard key that corresponds to the USB flash drive mode.
 - This will cause the L/R lamps to flash.

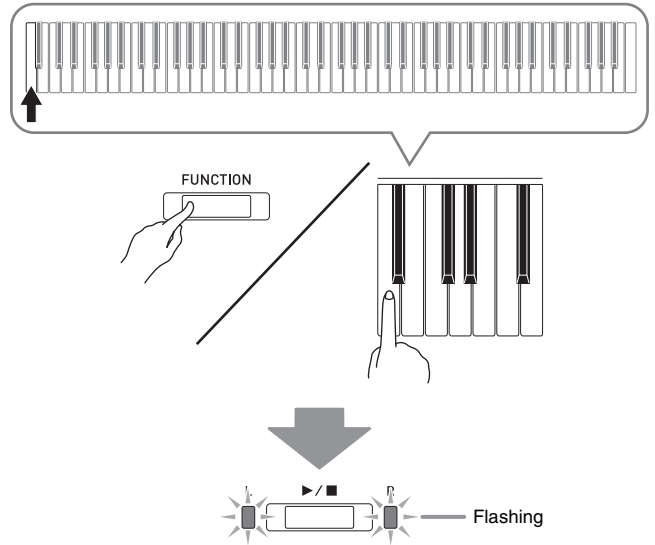

4. While holding down the **FUNCTION** button, press the load USB flash drive keyboard key.
 - This will cause the GRAND PIANO 1 lamp to light.

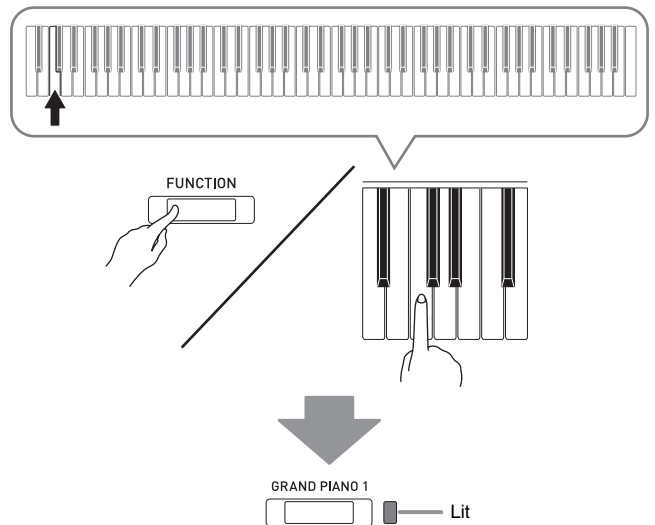

- To cancel the load operation, hold down the **FUNCTION** button as you press the USB flash drive mode key.

5. Hold down the **FUNCTION** button as you use the MUSIC LIBRARY SELECT keyboard keys to select a song number (61 to 70).

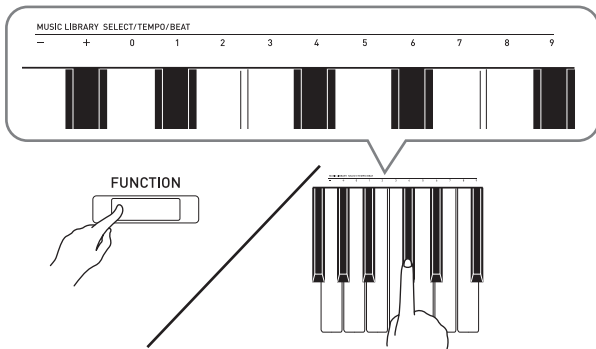

- The Digital Piano will emit a short beep if you specify a correct song number, and a long beep if the song number is not correct.
- Selecting song number 00 will batch load the 10 files from 61 through 70 to the Digital Piano's song memory.

6. Press the ►/■ button.

- This starts loading of the data to the Music Library user song area.
- After data loading is complete, the L/R lamps will go out and the Digital Piano will exit the loading operation.

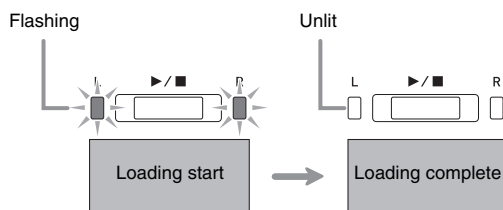

- To play back loaded song data, exit (turn off) the USB flash drive mode and then press the ►/■ button.

Deleting Data from a USB Flash Drive

You can use the procedure below to delete song data stored in the "MUSICLIB" folder on a USB flash drive.

1. Insert the USB flash drive into the Digital Piano's USB flash drive port.
2. While holding down the **FUNCTION** button, press the keyboard key that corresponds to the USB flash drive mode.

- This will cause the L/R lamps to flash.

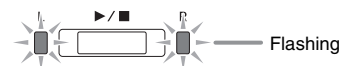

3. While holding down the **FUNCTION** button, press the delete USB flash drive keyboard key.

- This will cause the **GRAND PIANO 2** lamp to light.

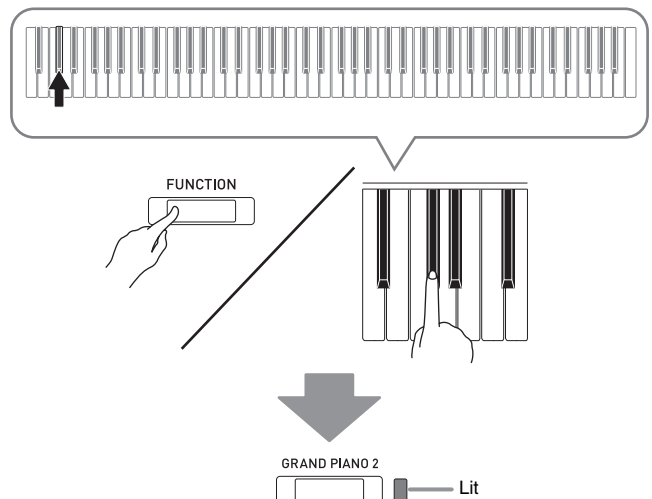

- To exit the data delete operation, hold down the **FUNCTION** button as you press the USB flash drive mode key.

4. Hold down the **FUNCTION** button as you use the **MUSIC LIBRARY SELECT** keyboard keys to select a song number (61 to 70).

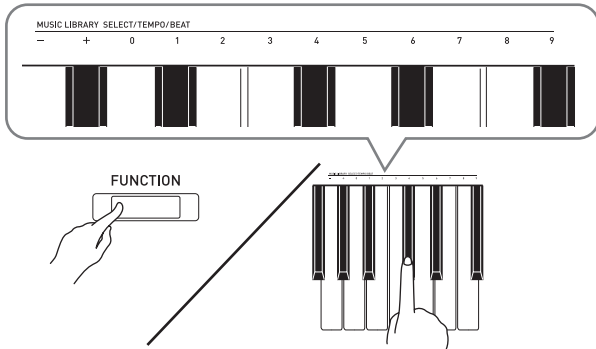

- The Digital Piano will emit a short beep if you specify a correct song number, and a long beep if the song number is not correct.

5. Press the **▶/■** button.

- This starts deletion of the selected data.
- When deleting is complete, the L/R lamps will go out to indicate that the USB flash drive mode has been exited.

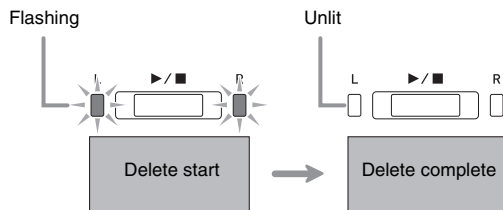

Simple Play Back of a Song on a USB Flash Drive





You can use the procedure below to play back a user song (page EN-46) stored on a USB flash drive without loading the song into Digital Piano Music Library memory (song numbers 61 to 70).

1. On your computer, copy the data you want to play back on the Digital Piano into the **MUSICLIB** folder on the USB flash drive.
 - Of the song data in the **MUSICLIB** folder, you can select any of the first 00 to 99 songs, sorted in file name sequence, for playback.
2. Insert the USB flash drive into the Digital Piano's USB flash drive port.
3. While holding down the **FUNCTION** button, press the keyboard key that corresponds to the USB flash drive mode.
 - This will cause the L/R lamps to flash.
4. Press the **▶/■** button.
 - This will start playback of the song data.
 - Press the **▶/■** button again to stop playback.
5. To change to another song, hold down the **FUNCTION** button as you use the **MUSIC LIBRARY SELECT** plus (+) and minus (-) keyboard keys to select the song you want to hear.
 - Pressing the plus (+) or minus (-) key scrolls through song file names.
 - You can also input a value from 0 to 9 to specify a Music Library song number.
 - Input two digits as the song number.

Example: To specify song number 5, press keys 0 and then 5
6. To exit the USB flash drive song playback function, hold down the **FUNCTION** button as you press the USB flash drive mode key.

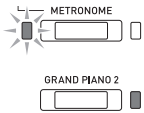
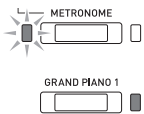
Error Indicators

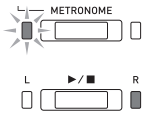
The following shows how the lamps indicate the error type when an error occurs due to data transfer failure or some other reason.

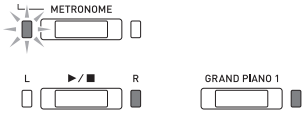
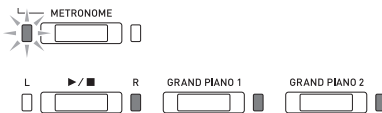
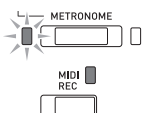
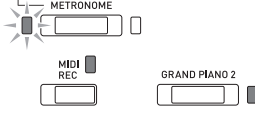
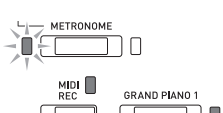
| Lamps | Error Type | Cause | Action |
|---|------------|---|---|
|  | No Media | <ol style="list-style-type: none"> The USB flash drive is not connected to the Digital Piano's USB flash drive port. The USB flash drive was removed while some operation was in progress. The USB flash drive is write-protected. The USB flash drive has anti-virus software. | <ol style="list-style-type: none"> Correctly plug the USB flash drive into the USB flash drive port. Do not remove the USB flash drive while any operation is in progress. Unprotect the USB flash drive. Use a USB flash drive that does not have anti-virus software. |
|  | No File | There is no loadable file in the "MUSICLIB" folder or no playable file in the "AUDIO" folder. | Move the file you want to load into the "MUSICLIB" folder or the file you want to play into the "AUDIO" folder (pages EN-36 and EN-38). |
|  | No Data | You are attempting to save data to a USB flash drive when there is no data to save. | Record something before performing a save operation. |
|  | Read Only | A read-only file with the same name you are trying to use is already stored on USB flash drive. | <ul style="list-style-type: none"> Change the name and then save the new data. Remove the read-only attribute from the existing USB flash drive file and overwrite it with the new data. Use a different USB flash drive. |
|  | Media Full | There is not enough space available on the USB flash drive. | Delete some of the files on the USB flash drive to make room for new data (page EN-41) or use a different USB flash drive. |
|  | File Full | <ol style="list-style-type: none"> There are too many files on the USB flash drive. There is a file named TAKE99.WAV in the "AUDIO" folder. | <ol style="list-style-type: none"> Delete some of the files on the USB flash drive to make room for new data. Delete the WAV file in the "AUDIO" folder. |
|  | Not SMF01 | You are attempting to play back SMF Format 2 song data. | This Digital Piano supports playback of SMF Format 0 or Format 1 only. |
|  | Size Over | The data on the USB flash drive is too big to play. | This Digital Piano supports playback of song data files with a maximum size of 90 kbytes. |
|  | Wrong Data | <ol style="list-style-type: none"> The USB flash drive data is corrupted. USB flash drive contains data that is not supported by this Digital Piano. | — |
|  | Convert | There is not enough Digital Piano memory available to convert a MIDI Recorder song to SMF data and store it on the USB flash drive. | Reduce the size of the song data. Example: Delete any tracks that are not required. |

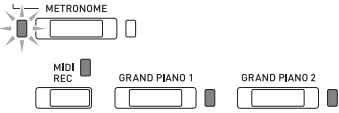
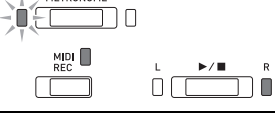
| Lamps | Error Type | Cause | Action |
|---|-------------------------|--|--|
|  | <p>Format</p> | <ol style="list-style-type: none"> 1. The USB flash drive format is not compatible with this Digital Piano. 2. The USB flash drive is corrupted. | <ol style="list-style-type: none"> 1. Format the USB flash drive on the Digital Piano. 2. Use a different USB flash drive. |
|  | <p>Media R/W</p> | <p>The USB flash drive is corrupted.</p> | <p>Use a different USB flash drive.</p> |

Connecting to a Computer

You can connect the Digital Piano to a computer and exchange MIDI data between them. You can send play data from the Digital Piano to commercially available music software running on your computer, or you can send MIDI data from your computer to the Digital Piano for playback.

Minimum Computer System Requirements

The following shows the minimum computer system requirements for sending and receiving MIDI data. Check to make sure that your computer complies with these requirements before connecting the Digital Piano to it.

● Operating System

Windows Vista *1

Windows 7 *2

Windows 8.1 *3

Windows 10 *4

macOS (OS X/Mac OS X) 10.7, 10.8, 10.9, 10.10, 10.11, 10.12

*1: Windows Vista (32-bit)

*2: Windows 7 (32-bit, 64-bit)

*3: Windows 8.1 (32-bit, 64-bit)

*4: Windows 10 (32-bit, 64-bit)

● USB port



IMPORTANT!

- Never connect to a computer that does not conform to the above requirements. Doing so can cause problems with your computer.

Connecting the Digital Piano to Your Computer



IMPORTANT!

- Make sure you follow the steps of the procedure below exactly. Connecting incorrectly can make data send and receive impossible.

1. Turn off the Digital Piano and then start up your computer.

- Do not start up the music software on your computer yet!

2. After starting up your computer, use a commercially available USB cable to connect it to the Digital Piano.

- Use a USB 2.0 or 1.1 A-B connector type USB cable.

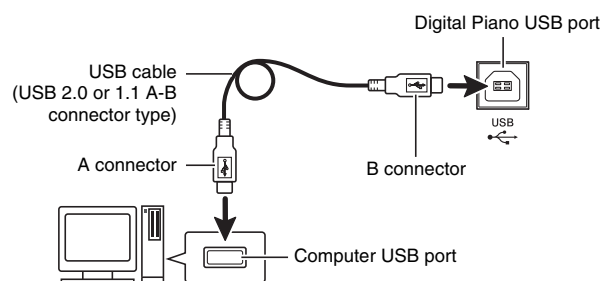

3. Turn on the Digital Piano.

- If this is the first time you are connecting the Digital Piano to your computer, the driver software required to send and receive data will be installed on your computer automatically.

4. Start up commercially available music software on your computer.

5. Configure the music software settings to select “CASIO USB-MIDI” as the MIDI device.

- For information about how to select the MIDI device, see the user documentation that comes with the music software you are using.



IMPORTANT!

- Be sure to turn on the Digital Piano first before starting up your computer's music software.



NOTE

- Once you are able to connect successfully, there is no problem with leaving the USB cable connected when you turn off your computer and/or Digital Piano.
- For detailed specifications and connections that apply to MIDI data send and receive by this Digital Piano, see the latest support information provided by the website at the following URL.

<http://world.casio.com/>

Using MIDI

What is MIDI?

The letters MIDI stand for Musical Instrument Digital Interface, which is the name of a worldwide standard for digital signals and connectors that makes it possible to exchange musical data between musical instruments and computers (machines) produced by different manufacturers.

NOTE

- For detailed information about MIDI Implementation, visit the CASIO website at: <http://world.casio.com/>.

See “Send channel” and “Local control” on page EN-32.

Transferring Song Data with a Computer

Use the procedures in this section to transfer Recorder memory data to a computer for storage, and to load songs to user song memory (Music Library 61 to 70).

IMPORTANT!

- Turning off the Digital Piano while data is being saved or loaded can cause all data currently stored in Digital Piano memory (recorded songs, etc.) to be deleted. Take care so power is not turned off accidentally during data save and load operations. If data is deleted, it will take longer than normal for the Digital Piano to power up the next time you turn it on (page EN-5).

1. Perform steps 1 through 3 of the procedure under “Connecting the Digital Piano to Your Computer” on page EN-45.

2. Change the Digital Piano’s USB device mode to storage.

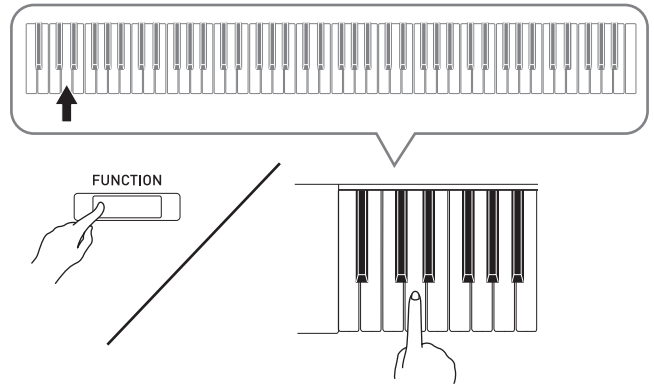

- While holding down the **FUNCTION** button, press the keyboard key that corresponds to the USB device mode.
- After this setting is changed, the GRAND PIANO 1, GRAND PIANO 2, R lamps flash, and all other lamps are unlit.
- See “USB flash drive mode” on page EN-32 for more information.

3. On your computer, perform the required operation to display your computer’s storage devices.

| If your computer is running this operating system: | Do this: |
|--|---|
| Windows Vista, Windows 7 | Double-click “Computer”. |
| Windows 8.1, Windows 10 | Open any folder. On the navigation window, click “PC”. |
| Mac OS | Skip step 3 and double-click “PIANO” on your Mac desktop. |

- The memory of this Digital Piano will appear as “PIANO” under “Devices with Removable Storage”.

4. Double-click “PIANO”.

- “PIANO” contains folders named “MUSICLIB” and “RECORDER”.

Digital Piano memory

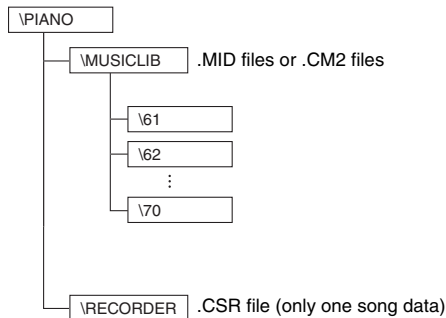

- To transfer a user song to the Digital Piano from your computer, open the “MUSICLIB” folder and put the song into one of the numbered subfolders (61 through 70). Each subfolder corresponds to a Music Library number: Subfolder 61 to Music Library 61, and so on.
- For example, storing song data in sub-folder 61 will cause it to be treated as Music Library song 61 data by the Digital Piano.
- To store Recorder song (.CSR) data on a computer, copy the .CSR file in the RECORDER folder to the computer. To return saved song (.CSR) data to Digital Piano memory, copy it to the RECORDER folder.

| Data Type | Folder Name | File Name and Extension* |
|----------------------|-------------|--|
| User songs | MUSICLIB | .MID: SMF format data (format 0/1) .CM2: CASIO original format data |
| Recorder memory data | RECORDER | BIDREC01.CSR: CASIO original format data |

* Before starting a store or load operation, first check the file name extension to ensure it matches the ones shown in this column.

In the case of a song recorded with the Digital Piano’s recorder function, change its file name to one of the names and extensions shown in this column.

IMPORTANT!

- The initial default configuration for Windows Vista, Windows 7, Windows 8.1, and Windows 10 is to hide file name extensions. Perform one of the following operations on your computer to show file name extensions.
 1. To show file name extensions under Windows Vista or Windows 7
 1. Open Folder Options by clicking the [Start] button, clicking [Control Panel], clicking [Appearance and Personalization], and then clicking [Folder Options].
 2. Click the [View] tab. Under [Advanced settings] clear the [Hide extensions for known file types] check box.
 3. Click [OK].
 - To show file name extensions under Windows 8.1 or Windows 10
 1. Open any folder.
 2. Click the [View] menu and then select the [File name extensions] check box in the [Show/hide] group.

■ To load a song into user song memory (Music Library 61 to 70)

1. Open the MUSICLIB folder.
2. Copy the song file (.MID or .CM2) to the numbered subfolder (61 to 70) whose name matches the number of the Music Library location to which you want to load the song.
 - If there are two files with the filename extensions .MID and .CM2 in the MUSICLIB folder, only the .MID data will be loaded into user song memory.

■ To transfer Recorder memory data between the Digital Piano and your computer

To transfer the Digital Piano's current Recorder memory data to your computer, copy the contents of the RECORDER folder to your computer.

To return Recorder data you previously saved to your computer back to Recorder memory, copy it back to the RECORDER folder (and replace the current RECORDER folder contents).

5. After the file copy operation is complete, return the USB device mode to MIDI.

- If you are using a Macintosh, perform the eject operation (drag them to the trash can).
- While holding down the **FUNCTION** button, press the applicable keyboard key. See "USB flash drive mode" on page EN-32 for more information.
- Returning the USB device mode to MIDI will load the contents of MUSICLIB into user song memory and the contents of RECORDER into Recorder memory.



IMPORTANT!

- A data conversion error is indicated when the **GRAND PIANO 1**, **GRAND PIANO 2**, L/R lamps are all lit, and all other lamps are unlit.

Copyrights

The rights of creators and copyright holders of music, images, computer programs, databases, and other data are protected by copyright laws. You are allowed to reproduce such works for personal or non-commercial use only. For any other purpose, all reproduction (including data format conversion), modification, transfer of reproductions, distribution over a network, or any other use without permission of the copyright holder exposes you to claims for damages and criminal prosecution for copyright infringement and violation of the author's personal rights. Be sure to reproduce and otherwise use copyrighted works only in accordance with applicable copyright laws.

Getting Ready

Assembling the Stand

PREPARATION

- Before starting assembly, check to make sure that you have all the parts shown below.
- This stand does not include any of the tools required for assembly. It is up to you to prepare a large Philips head (+) screwdriver for assembly.

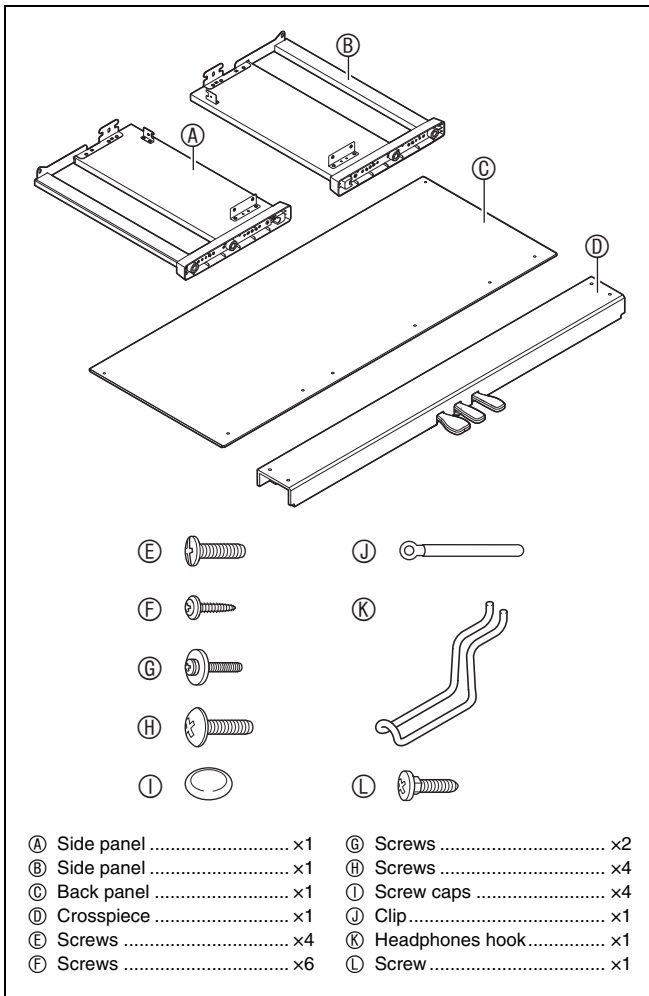

IMPORTANT!

- Do not remove the tape securing the keyboard cover in place until assembly is complete. Removing the tape can cause the keyboard cover to open and close during assembly, creating the risk of personal injury to your hands and fingers.
- Do not use any screws other than those that come with the stand. Doing so risks damage to the stand and/or Digital Piano.
- You can find the screws in a plastic bag inside of the packing material.
- If anything is missing or damaged, contact your local CASIO service provider.

CAUTION

- To assemble the stand, at least two persons should work together on a flat surface.
- Take care that you do not pinch your fingers between parts when assembling them.
- Spread felt or some other type of cloth under the bench to avoid direct contact between the rubber at the tips of the legs and the floor surface. Direct contact between the rubber and flooring can cause discoloration, marring, or other damage to the flooring.
- When placing the Digital Piano on the floor, be sure to place it on something soft (a blanket, cushion, etc.) Do not place the Digital Piano directly onto the floor.

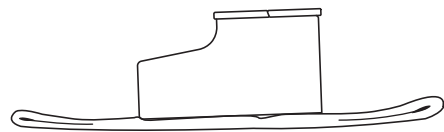

NOTE

- Be sure to follow the proper procedure when assembling the stand.

PREPARATION

- Pull the pedal unit cable out from the crosspiece (D).

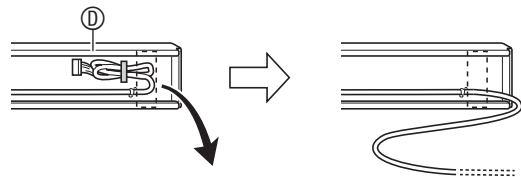

1. Attach side panels (A) and (B) to crosspiece (D). Secure the side panels using four (E) screws.

- When installing parts (1), slide the brackets (2) into the slots in either end of crosspiece (D). If the brackets (2) are not inserted into the ends of the crosspiece (D) as far as they will go, the screws (E) will not be able to enter into the screw holes of the brackets (2), which can strip the threads of the screws.
- Cover the screw heads with the caps (I).

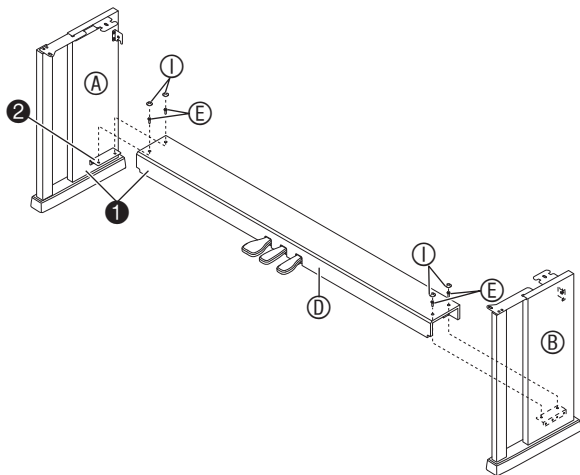

2. Use the two screws (G) to secure the top left and right edges of the back panel (C) to the brackets (3) of side panels (A) and (B).

IMPORTANT!

- Make sure that the back panel (C) is positioned correctly as described below when installing it.
 - Before sliding back panel (C) into place, make sure that the widely spaced screw holes along the bottom of the panel are on the left (when viewed from the front of the stand), and the narrowly spaced holes are on the right.

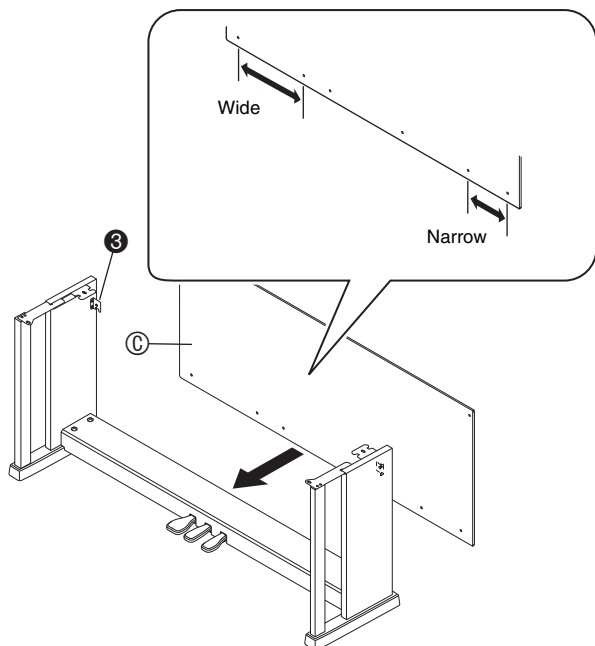

- At location (4), slip the clip (J) onto to the screw (G) before installing the screw.

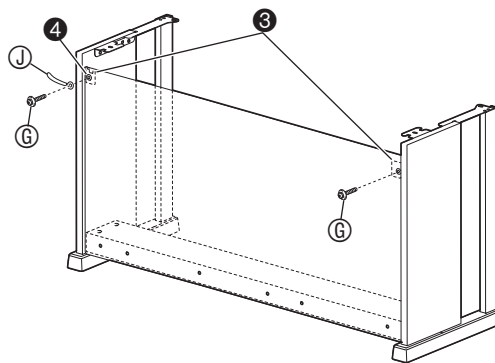

3. Next, secure the bottom of the back panel (C) with the six screws (F).

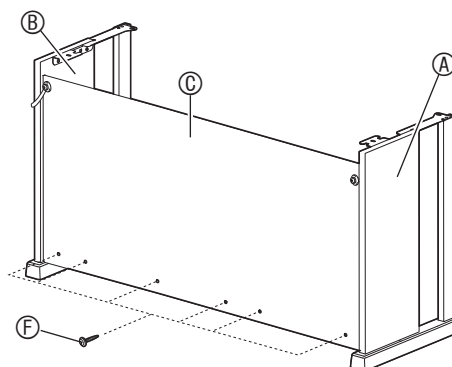

4. Adjust the height adjustment screw (5) to provide support so crosspiece (D) does not bow downwards when the pedals are pressed.

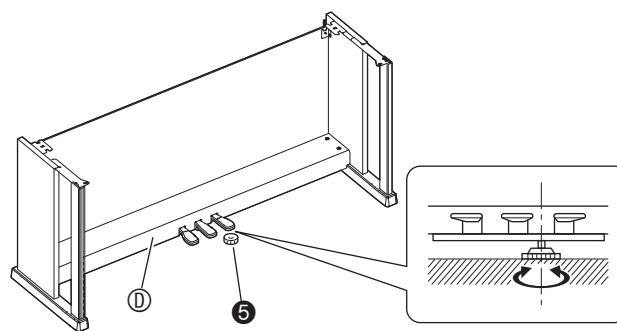

IMPORTANT!

- Pressing the pedals without adjusting height adjustment screw (5) can result in damage to crosspiece (D). Always make sure you adjust height adjustment screw (5) before operating the pedals.

5. Place the piano onto the stand.

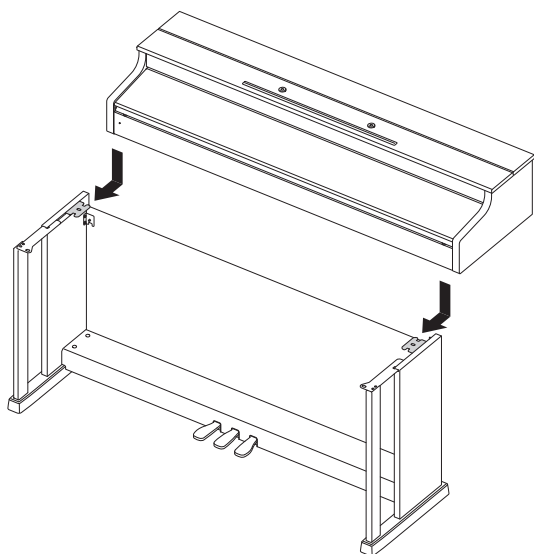

- Slide the piano onto the stand from behind so the bolts on the bottom of the piano engage with the slots of stand brackets.

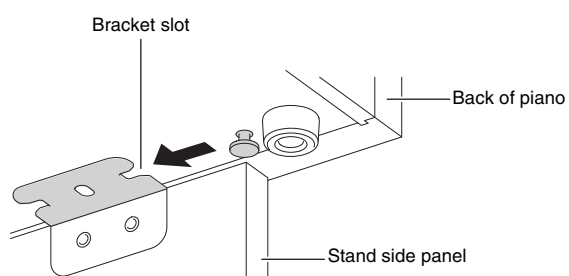

- The sides of the piano will overhang the left and right side panels slightly. Adjust the piano position so the left and right overhang is the same.

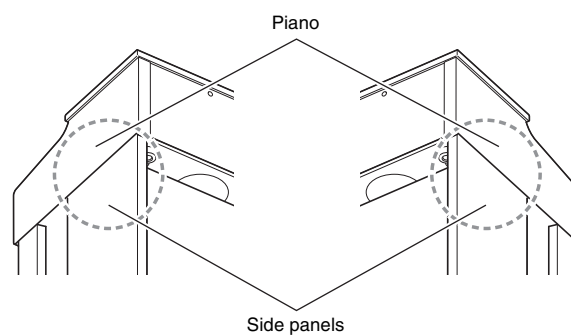

6. Use the four screws \textcircled{H} to secure the piano to the stand.

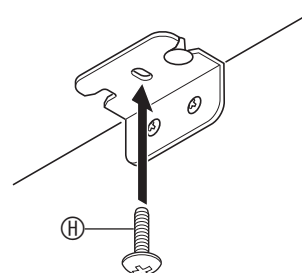

IMPORTANT!

- The screws keep the piano from slipping off the stand. Never use the piano without the screws installed.

To connect the cable

1. With the pedal unit cable plug oriented as shown in the illustration below, plug it into the pedal connector on the bottom of the piano.
 - a. Push the plug fully in as far as it goes.
 - b. Use the ① clip to secure the pedal cable to side panel ②.

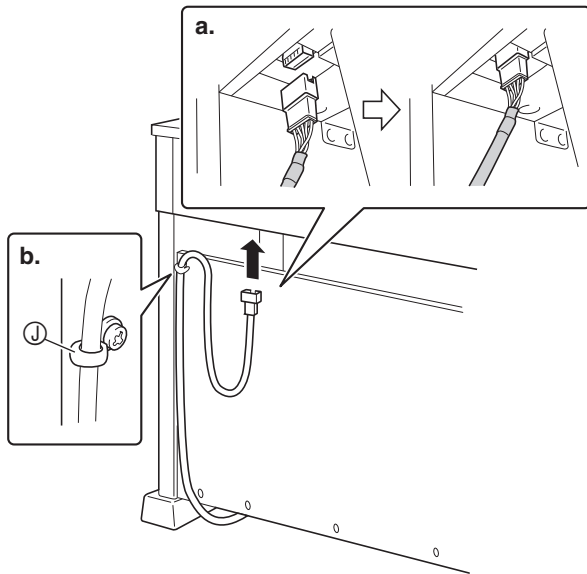

2. Plug the AC adaptor that comes with the digital piano (24 VDC) into the AC adaptor terminal. Plug the power cord of the AC adaptor that comes with the Digital Piano into a household power outlet as shown in the illustration below.

- Secure the AC adaptor cord by hooking it onto the hook next to the AC adaptor terminal.

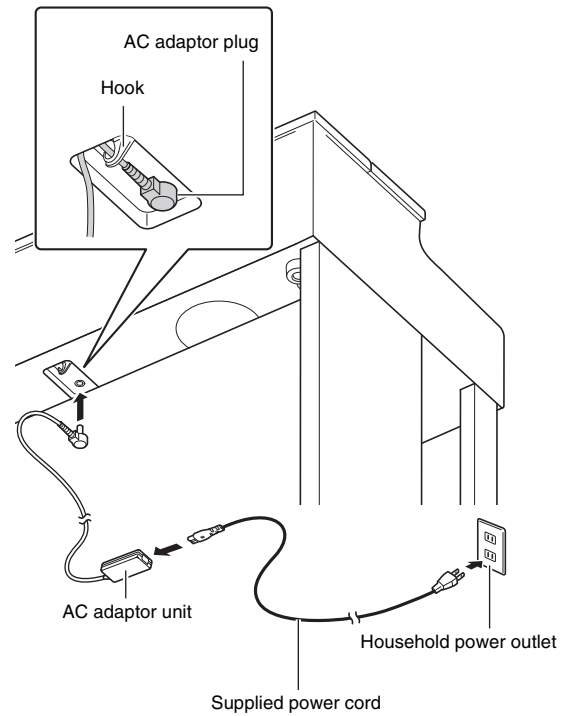

To install the music stand

1. Insert the tabs on the bottom of the music stand into the two holes on the top of the piano.

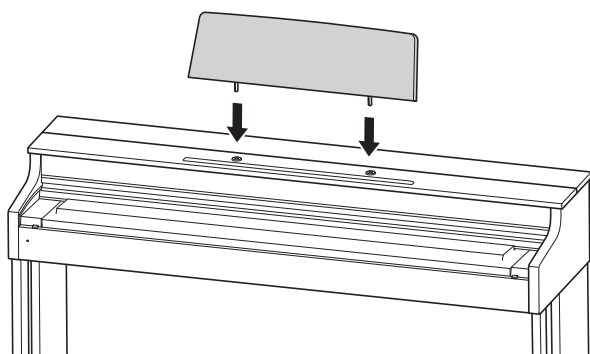

Install the Headphones Hook

1. Insert the headphones hook (K) into the two holes on the bottom of the piano.
2. Use screw (L) to secure the headphones hook in place.

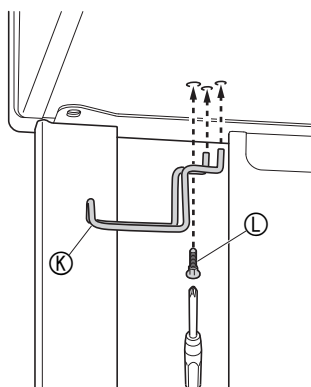

Removing the Protective Tape from the Keyboard

Protective tape is affixed to the front edges of the keyboard keys to protect them during shipment. Remove the protective tape before using the Digital Piano.

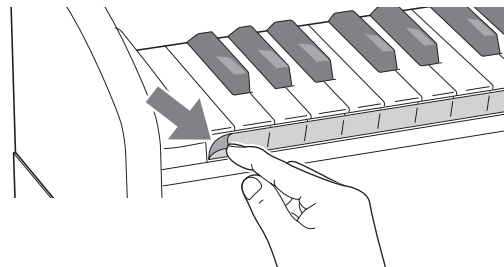

- Peel off the tape by pulling carefully towards you as shown in the illustration.

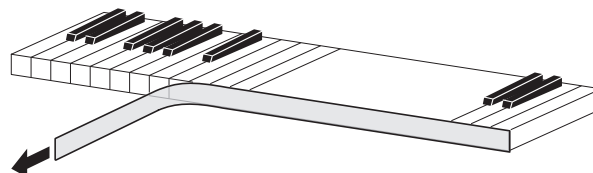

- If some keys seem to be raised up after you remove the tape, press down to return them to their normal positions.

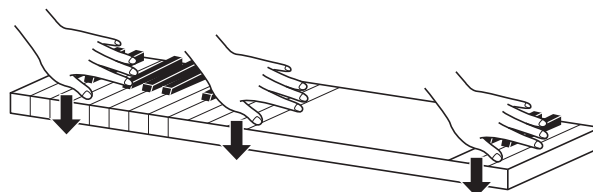

Opening and Closing the Piano Lid

IMPORTANT!

- Use both hands whenever opening or closing the lid, and take care that you do not close it on your fingers.
- Do not open the lid too wide. Doing so creates the risk of damage to the cover and digital piano.
- Stand in front of the digital piano on the right side when opening or closing the lid.

■ To open the lid

1. Lift up the lid as shown in the illustration.

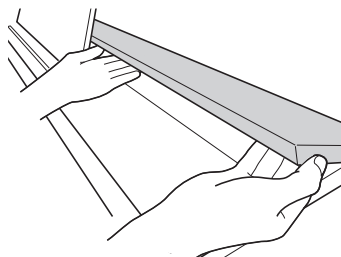

- The lid has a support bracket (indicated by the star ★ in the illustration) attached to its inside surface. Check to make sure that the support bracket is standing up fully.

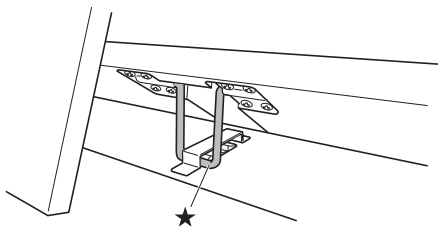

■ To close the lid

1. Carefully lift up slightly on the lid.
2. Use the fingers of your left hand to press back on the support bracket (★) as you slowly and carefully lower the lid.

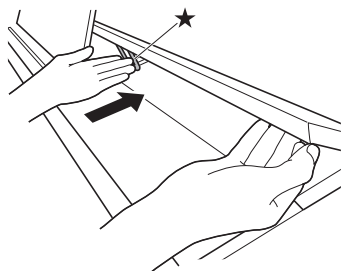

Connecting Headphones

Front

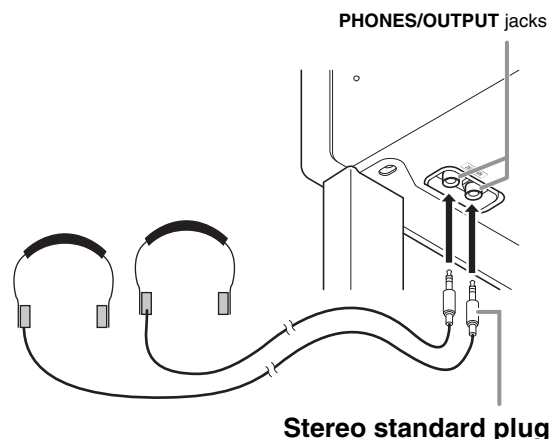

Connect commercially available headphones to the **PHONES/OUTPUT** jacks. Connecting headphones to either of the **PHONES/OUTPUT** jack cuts off output to the speakers, which means you can practice even late at night without bothering others. To protect your hearing, make sure that you do not set the volume level too high when using headphones.

NOTE

- Be sure to push the headphones plug into the **PHONES/OUTPUT** jacks as far as it will go. If you don't, you may hear sound from only one side of the headphones.
- If the plug of the headphones you are using does not match the **PHONES/OUTPUT** jacks, use the applicable commercially available adaptor plug.
- If you are using headphones that require an adaptor plug, make sure you do not leave the adaptor plugged in when you unplug the headphones. If you do, nothing will sound from the speakers when you play.

Connecting Audio Equipment or an Amplifier

You can connect audio equipment or a music amplifier to the Digital Piano and then play through external speakers for more powerful volume and better sound quality.

IMPORTANT!

- Whenever connecting a device to the Digital Piano, first use the **VOLUME** controller to set the volume to a low level. After connecting, you can adjust the volume to the level you want.
- Whenever you connect any device to the Digital Piano, be sure to read the user documentation that comes with the device.

To either of the Digital Piano's **PHONES/OUTPUT** jack

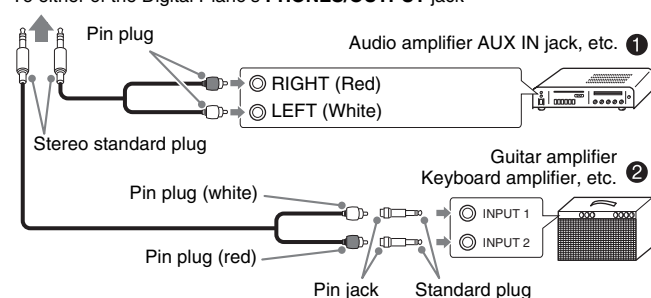

Connecting Audio Equipment (Figure 1)

Use commercially available connecting cords (Standard Plug × 1, Pin Plugs × 2) to connect as shown in Figure 1. Make sure that the end of the cord that you connect to the Digital Piano is a stereo standard plug. A monaural standard plug will result in output of only one of the two stereo channels. Normally, you should set the input selector of the audio equipment to the terminal where the Digital Piano is connected (AUX IN, etc.) Adjust volume using the Digital Piano's **VOLUME** controller.

Connecting a Music Amplifier (Figure 2)

Connect the connecting cord* to one of the types of amplifiers shown in Figure 2.

Adjust volume using the Digital Piano's **VOLUME** controller.

* Digital Piano: Stereo standard plug

Amplifier : Inputs signals for the left and right channels. Not connecting either plug will result in output of only one of the two stereo channels.

NOTE

- Change the Head Phone Mode setting to OFF whenever the Digital Piano is connected to an audio system or amplifier.

Bundled and Optional Accessories

Use only accessories that are specified for use with this Digital Piano.

Use of unauthorized accessories creates the risk of fire, electric shock, and personal injury.

NOTE

- You can get information about accessories that are sold separately for this product from the CASIO catalog available from your retailer, and from the CASIO website at the following URL.
<http://world.casio.com/>

Reference

Troubleshooting

| Problem | Action | See Page |
|---|---|---|
| No sound is produced when I press a keyboard key. | <ol style="list-style-type: none"> 1. Rotate the VOLUME controller more towards “MAX”. 2. Disconnect whatever is connected to the PHONES/OUTPUT jacks. 3. Turn on the Local control setting. | <p>☞ EN-6</p> <p>☞ EN-54</p> <p>☞ EN-32</p> |
| The pitch of the Digital Piano is off. | <ol style="list-style-type: none"> 1. Change the transpose setting to “0”. Or turn power off and then back on. 2. Change the tuning setting to 440.0 Hz. Or turn power off and then back on. 3. Change the octave shift setting to 0. 4. Change the temperament setting to “0: Equal”, which is the standard modern tuning. | <p>☞ EN-31</p> <p>☞ EN-31</p> <p>☞ EN-31</p> <p>☞ EN-31</p> |
| Nothing happens when I press a pedal. | Check the orientation of the pedal unit plug and makes sure it is inserted as far as it goes. | ☞ EN-52 |
| <p>Tones and/or effects sound strange. Turning power off and then back on again does not eliminate the problem.</p> <p><i>Example: Note intensity does not change even though I alter key pressure.</i></p> | Turn off Auto Resume, and then turn power off and then back on again. | ☞ EN-33 |
| I cannot transfer data after connecting the Digital Piano to a computer. | <ol style="list-style-type: none"> 1. Check to make sure that the USB cable is connected to the Digital Piano and computer, and that the correct device is selected with your computer’s music software. 2. Turn off the Digital Piano and then exit the music software on your computer. Next, turn the Digital Piano back on and then restart the music software on your computer. | ☞ EN-45 |
| I cannot store data to a USB flash drive or load data from a USB flash drive. | See “Error Indicators”. | ☞ EN-43 |
| It takes a long time before I can use the Digital Piano after I turn it on. | It takes about 20 seconds after you turn on power to perform the memory format operation. Wait until the format operation is complete. Note that you should take care to avoid turning off the Digital Piano while a data transfer operation with a computer is in progress. | ☞ EN-46 |
| A tone’s quality and volume sounds slightly different depending where it is played on the keyboard. | <p>This is an unavoidable result of the digital sampling process,* and does not indicate malfunction.</p> <p>* Multiple digital samples are taken for the low range, middle range, and high range of the original musical instrument. Because of this, there may be very slight differences in tonal quality and volume between sample ranges.</p> | |
| When I press a button, the note that is sounding cuts out momentarily or there is a slight change in how effects are applied. | This happens when the sounds of multiple parts are sounding at the same time while using layer, using the Duet Mode, playing back a built-in tune, recording, etc. Pressing a button when one of these conditions exists will cause the effect setting that is built into the tone to change automatically, which causes notes to cut out momentarily or causes a slight change in how effects are being applied. | |
| I need to reset all Digital Piano data and settings to their initial defaults. | Hold down the FUNCTION , MIDI REC and GRAND PIANO 2 buttons, and press the power button to turn on power. | |
| I need to reset a specific setting to its initial default. | Hold down the FUNCTION button and press the + and – keyboard keys of the setting at the same time. | |

Product Specifications

| | |
|------------------------|---|
| Model | AP-470BK/AP-470BN/AP-470WE |
| Keyboard | 88-key piano keyboard, with Touch Response |
| Maximum Polyphony | 256 notes |
| Tone | 22 types <ul style="list-style-type: none"> • Layer (excluding bass tones) |
| Acoustic Simulator | Damper Resonance (Damper Noise on/off), Hammer Response, String Resonance, Lid Simulator, Key Off Simulator, Key On Action Noise, Key Off Action Noise |
| Effects | Brilliance (-3 to 0 to 3), Hall Simulator (4 types), Chorus (4 types), DSP, Head Phone Mode, Volume Sync Equalizer |
| Metronome | <ul style="list-style-type: none"> • Beats: 0 to 9 • Tempo range: 20 to 255 |
| Duet Mode | Adjustable tone range (-2 to 2 octaves) |
| Concert Play | <ul style="list-style-type: none"> • Songs: 10 • Song volume: Adjustable • Part On/Off: L, R (Lesson Mode only) • 3 Modes: LISTEN, LESSON, PLAY |
| Music Library | <ul style="list-style-type: none"> • Songs: 60; 10 download songs (Up to approximately 90 KB per song, up to approximately 900 KB/10 songs total)* • * Based on 1 KB = 1024 bytes • Song volume: Adjustable • Part On/Off: L, R |
| Recorder | <p>MIDI Recorder</p> <ul style="list-style-type: none"> • Modes: Real-time recording, playback • Songs: 1 • Tracks: 2 • Capacity: Approximately 5,000 notes total • Recording storage: Built-in flash memory <p>Audio Recorder</p> <ul style="list-style-type: none"> • USB flash drive real-time recording and playback; Linear PCM, 16bit, 44.1 kHz, stereo .WAV format • Songs: 99 files • Approximately 25 minutes maximum recording per file. • Audio file volume: Adjustable |
| Pedals | Damper (seamless half-pedal support), sostenuto, soft |
| Other Functions | <ul style="list-style-type: none"> • Touch Response: 3 levels, Off • Transpose: 2 octaves (-12 to 0 to +12) • Tuning: 415.5 Hz to 440.0 Hz to 465.9 Hz (0.1 Hz steps) • Temperament: Equal + 16 other types • Octave Shift: 4 octaves (-2 to 0 to +2) • Panel Lock |
| MIDI | 16-channel multi-timbre receive |
| USB Memory | <ul style="list-style-type: none"> • Supported capacity: 32 GB or less recommended • Functions: SMF playback, recorded song storage, song data import, formatting, audio data playback and storage |
| Input/Output Terminals | <ul style="list-style-type: none"> • PHONES/OUTPUT jacks: Stereo standard jacks × 2 • AC Adaptor Terminal: 24 VDC • USB port: Type B • USB flash drive port: Type A • Pedal connector |
| Speakers | ∅ 12cm × 2 + ∅ 4cm × 2 (Output: 20W + 20W) |
| Power Requirements | <p>AC adaptor: AD-E24250LW</p> <ul style="list-style-type: none"> • Auto Power Off: Approximately 4 hours; Can be disabled. |
| Power Consumption | 24V --- 20W |
| Dimensions | Piano and Stand: 141.7(W) × 42.7(D) × 86.1(H) cm (55 13/16 × 16 13/16 × 33 15/16 inches) |
| Weight | Piano and Stand: Approximately 43.4kg (95.7 lbs) |

- Specifications and designs are subject to change without notice.

Appendix

Tone List

| Tone Name | | Program Change | Bank Select MSB |
|------------------------|---------|----------------|-----------------|
| GRAND PIANO 1 | CONCERT | 0 | 0 |
| | MELLOW | 1 | 0 |
| | BRIGHT | 2 | 0 |
| GRAND PIANO 2 | CONCERT | 3 | 0 |
| | MELLOW | 4 | 0 |
| | BRIGHT | 5 | 0 |
| MODERN PIANO | | 6 | 0 |
| ROCK PIANO | | 7 | 0 |
| JAZZ PIANO | | 8 | 0 |
| ELEC.PIANO 1 | | 9 | 0 |
| ELEC.PIANO 2 | | 10 | 0 |
| FM E.PIANO | | 11 | 0 |
| 60'S E.PIANO | | 12 | 0 |
| HARPSICHORD | | 13 | 0 |
| VIBRAPHONE | | 14 | 0 |
| STRINGS 1 | | 15 | 0 |
| STRINGS 2 | | 16 | 0 |
| ORGAN 1 (PIPE ORGAN) | | 17 | 0 |
| ORGAN 2 (JAZZ ORGAN) | | 18 | 0 |
| ORGAN 3 (ELEC.ORGAN 1) | | 19 | 0 |
| ORGAN 4 (ELEC.ORGAN 2) | | 20 | 0 |
| BASS(LOWER) | | 21 | 0 |

Concert Play List

| Song No. | Song Name |
|----------|---------------------------------------|
| 1 | Je Te Veux |
| 2 | Vltava (Má vlast) |
| 3 | Canon |
| 4 | Tableaux d'Une Exposition "Promenade" |
| 5 | Piano Concerto No.20 K.466 2nd Mov. |
| 6 | Polovetizian Dance (Prince Igor) |
| 7 | Sonate K.331 1st Mov. |
| 8 | Violin Concerto 1st Mov. |
| 9 | Jesus, Bleibet Meine Freude |
| 10 | Melody In F |

Music Library List

| Song No. | Song Name |
|----------|---|
| 01 | Nocturne Op.9-2 |
| 02 | Fantaisie-Impromptu Op.66 |
| 03 | Étude Op.10-3 "Chanson de l'adieu" |
| 04 | Étude Op.10-5 "Black Keys" |
| 05 | Étude Op.10-12 "Revolutionary" |
| 06 | Étude Op.25-9 "Butterflies" |
| 07 | Prélude Op.28-7 |
| 08 | Valse Op.64-1 "Petit Chien" |
| 09 | Valse Op.64-2 |
| 10 | Moments Musicaux 3 |
| 11 | Impromptu Op.90-2 |
| 12 | Marche Militaire 1 (Duet) |
| 13 | Frühlingslied [Lieder Ohne Worte Heft 5] |
| 14 | Fröhlicher Landmann [Album für die Jugend] |
| 15 | Von fremden Ländern und Menschen [Kinderszenen] |
| 16 | Träumerei [Kinderszenen] |
| 17 | Tambourin |

| Song No. | Song Name |
|----------|---|
| 18 | Menuet BWV Anh.114 [Clavierbüchlein der Anna Magdalena Bach] |
| 19 | Inventio 1 BWV 772 |
| 20 | Inventio 8 BWV 779 |
| 21 | Inventio 13 BWV 784 |
| 22 | Praeludium 1 BWV 846 [Das Wohltemperierte Klavier 1] |
| 23 | Le Coucou |
| 24 | Gavotte |
| 25 | Sonatina Op.36-1 1st Mov. |
| 26 | Sonatine Op.20-1 1st Mov. |
| 27 | Sonate K.545 1st Mov. |
| 28 | Sonate K.331 3rd Mov. "Turkish March" |
| 29 | Rondo K.485 |
| 30 | Für Elise |
| 31 | Marcia alla Turca |
| 32 | Sonate Op.13 "Pathétique" 1st Mov. |
| 33 | Sonate Op.13 "Pathétique" 2nd Mov. |
| 34 | Sonate Op.13 "Pathétique" 3rd Mov. |
| 35 | Sonate Op.27-2 "Moonlight" 1st Mov. |
| 36 | Rhapsodie 2 |
| 37 | Waltz Op.39-15 (Duet) |
| 38 | Liebesträume 3 |
| 39 | Blumenlied |
| 40 | La Prière d'une Vierge |
| 41 | Csikos Post |
| 42 | Humoresque Op.101-7 |
| 43 | Melodie [Lyrische Stücke Heft 2] |
| 44 | Sicilienne Op.78 |
| 45 | Berceuse [Dolly] (Duet) |
| 46 | Arabesque 1 |
| 47 | La Fille aux Cheveux de Lin [Préludes] |
| 48 | Passepied [Suite bergamasque] |
| 49 | Gymnopédie 1 |
| 50 | Je Te Veux |
| 51 | Salut d'Amour |
| 52 | The Entertainer |
| 53 | Maple Leaf Rag |
| 54 | L'arabesque [25 Étüden Op.100] |
| 55 | La Styrienne [25 Étüden Op.100] |
| 56 | Ave Maria [25 Étüden Op.100] |
| 57 | Le retour [25 Étüden Op.100] |
| 58 | La chevaleresque [25 Étüden Op.100] |
| 59 | No.13 [Études de Mécanisme Op.849] |
| 60 | No.26 [Études de Mécanisme Op.849] |

MIDI Implementation Chart

| Function | Transmitted | Recognized | Remarks |
|---|---|---|--|
| Basic Channel Default Changed | 1 - 16 1 - 16 | 1 - 16 1 - 16 | |
| Mode Default Messages Altered | Mode 3 X * * * * * * * * * * | Mode 3 X * * * * * * * * * * | |
| Note Number True voice | 0 - 127 * * * * * * * * * * | 0 - 127 0 - 127*1 | *1 : Depends on tone |
| Velocity Note ON Note OFF | 0 9nH v = 1 - 127 0 8nH v = 0 - 127 | 0 9nH v = 1 - 127 X 9nH v = 0, O 8nH v = 0 - 127 | |
| After Touch Key's Ch's | X X | X O | |
| Pitch Bender | X | O | |
| Control Change 0, 32 1 5 6, 39 10 11 16 17 18 19 64 65 66 67 | O X X X O X X X X X X X X X X X O X O | O O O O O O O O O O O O O O O O O O O | Bank select Modulation Portamento Time Portamento Data entry LSB, MSB*2 Volume Pan Expression DSP Parameter0*2 DSP Parameter1*2 DSP Parameter2*2 DSP Parameter3*2 Damper Portamento Switch Sostenuto Soft pedal |

CASIO®

Free Manuals Download Website

<http://myh66.com>

<http://usermanuals.us>

<http://www.somanuals.com>

<http://www.4manuals.cc>

<http://www.manual-lib.com>

<http://www.404manual.com>

<http://www.luxmanual.com>

<http://aubethermostatmanual.com>

Golf course search by state

<http://golfingnear.com>

Email search by domain

<http://emailbydomain.com>

Auto manuals search

<http://auto.somanuals.com>

TV manuals search

<http://tv.somanuals.com>