

# CW-75

## User's Guide

- We recommend that you print on a disc\* before you record anything on it. Printing on a disc that already has data recorded on it can cause the data to become corrupted.
- Note that CASIO COMPUTER CO., LTD. shall not be held liable for any loss or corruption of data on discs arising through the use of this printer.

\* CD-R, CD-RW, DVD-R, etc.

Be sure to read the Safety Precautions contained in this manual before trying to use the printer for the first time, and always keep this manual on hand for future reference.

**CASIO**®

## **GUIDELINES LAID DOWN BY FCC RULES FOR USE OF THE UNIT IN THE U.S.A. (not applicable to other areas).**

### **NOTICE**

This equipment has been tested and found to comply with the limits for a Class B digital device, pursuant to Part 15 of the FCC Rules. These limits are designed to provide reasonable protection against harmful interference in a residential installation. This equipment generates, uses and can radiate radio frequency energy and, if not installed and used in accordance with the instructions, may cause harmful interference to radio communications. However, there is no guarantee that interference will not occur in a particular installation. If this equipment does cause harmful interference to radio or television reception, which can be determined by turning the equipment off and on, the user is encouraged to try to correct the interference by one or more of the following measures:

- Reorient or relocate the receiving antenna.
- Increase the separation between the equipment and receiver.
- Connect the equipment into an outlet on a circuit different from that to which the receiver is connected.
- Consult the dealer or an experienced radio/TV technician for help.

Caution: Changes or modification to the product not expressly approved by CASIO could void the user's authority to operate the product.

### **FCC WARNING**

Changes or modifications not expressly approved by the party responsible for compliance could void the user's authority to operate the equipment.

Proper connectors must be used for connection to host computer and/or peripherals in order to meet FCC emission limits.

Cable specified for PC Windows® compatible PC to CW-75

### **Declaration of Conformity**

Model Number: CW-75

Trade Name: CASIO COMPUTER CO., LTD.

Responsible party: CASIO, INC.

Address: 570 MT.PLEASANT AVENUE, DOVER, NEW JERSEY 07801

Telephone number: 201-361-5400

This device complies with Part 15 of the FCC Rules. Operation is subject to the following two conditions: (1) This device may not cause harmful interference, and (2) this device must accept any interference received, including interference that may cause undesired operation.

## Read This First!

- CASIO COMPUTER CO., LTD. shall not be held liable for any loss or claims by you or any other person or entity that may arise through the use of this printer.
  - Reproduction of this manual in any form, either in part or its entirety, is forbidden without the express permission of CASIO COMPUTER CO., LTD.
  - The contents of the manual are subject to change without notice.
  - This manual covers the CW-75 Disc Title Printer only. For details about the about using the label layout software that comes bundled with the printer, see the User's Guide on the DISC TITLE PRINTER Application CD-ROM.
  - Windows is a registered trademark of Microsoft Corporation in the United States and other countries.
  - Other company and product names used herein may also be company and product names of others.
- © Copyright 2003 CASIO COMPUTER CO., LTD. All rights reserved.
- Be sure to read this manual carefully before attempting to use the product for the first time.

## Safety Precautions

Thank you for purchasing this quality CASIO product. Before using it, be sure to read the following Safety Precautions. Keep the manual in a convenient location for future reference when necessary.



### Danger

This symbol indicates information that, if ignored or applied incorrectly, creates the danger of death or serious personal injury.



### Warning

This symbol indicates information that, if ignored or applied incorrectly, creates the possibility of death or serious personal injury.



### Caution

This symbol indicates information that, if ignored or applied incorrectly, creates the possibility of personal injury or material damage.

## Examples of graphic markings



 indicates something you should not do. The symbol shown here indicates you should not try to take the unit apart.



 indicates something you should do. The symbol shown here indicates you should unplug the unit from the wall outlet.

## Danger

### Alkaline Batteries



Perform the following steps immediately if fluid leaking from alkaline batteries ever gets into your eyes.

1. Do not rub your eyes! Rinse them with water.
2. Contact your physician immediately.

Leaving alkaline battery fluid in your eyes can lead to loss of sight.

## Warning

### Smoke, abnormal odor, overheating, and other abnormalities



Continued use of the product while it is emitting smoke or strange odor, or overheating creates the risk of fire and electric shock. Immediately perform the following steps whenever any of the above symptoms are present.

1. Turn off power.
2. Unplug the power cord from the wall outlet.
3. Contact your original retailer.

### Power cord, AC adaptor, USB cable



Misuse of the power cord, AC adaptor, or USB cable creates the risk of fire and electric shock.

Make sure you follow the precautions listed below.

- Use only items that are specified for the product.
- Use only a power source whose output matches the rating marked on the plate on the back of the product.
- Never plug the power cord into a wall outlet that is shared by other devices, or into a shared extension cord.

## Warning

### Power cord, AC adaptor, USB cable



Misuse of the power cord, AC adaptor, or USB cable can damage it and create the risk of fire and electric shock. Make sure you follow the precautions listed below.

- Never place heavy objects on these items or subject them to direct heat.
- Never modify these items or subject them to bending.
- Do not subject these items to twisting or pulling.
- Should the power cord, AC adaptor, or USB cable or its plug ever become damaged, contact your original retailer.



### Power cord, AC adaptor, USB cable



Never touch the power cord, AC adaptor, or USB cable or its plugs while your hands are wet.

Doing so creates the risk of electric shock.

### Batteries



Misuse of batteries can cause them to leak, resulting in damage to nearby objects, or to explode, creating the risk of fire and personal injury. Always make sure you observe the following precautions.

- Never try to take batteries apart or allow them to become shorted.
- Never expose batteries to heat or dispose of them by incineration.
- Never mix old batteries with new ones.
- Never mix batteries of different types.
- Do not charge the batteries.
- Make sure the positive (+) and negative (–) ends of the batteries are facing correctly.



## Warning

### Dropping and rough treatment



Continued use of the product after it has been damaged due to dropping or other rough treatment creates the risk of fire and electric shock. Immediately perform the following steps if the product should ever become damaged.

1. Turn off power.
2. Unplug the power cord from the wall outlet.
3. Contact your original retailer.

### Do not disassemble or modify the product.



Never try to take the product apart or modify it in any way. Doing so creates the risk of electric shock, burn injury, or other personal injury.

Leave all internal inspection, maintenance, and repair up to your original retailer.

### Water and foreign objects



Water, liquids, or foreign objects (especially metal) getting inside the product creates the risk of fire and electric shock. Immediately perform the following steps if liquid or a foreign object should ever get inside the product.

1. Turn off power.
2. Unplug the power cord from the wall outlet.
3. Contact your original retailer.

### Do not incinerate.



Never dispose of the product by incineration. Doing so creates the risk of fire and personal injury due to explosion.

### Plastic bag precaution



Never place the plastic bags in which the product comes packed over your head. Doing so creates the risk of suffocation. Particular care is required in households where young children are present.

## Caution

### Power cord, AC adaptor, USB cable



Misuse of the power cord, AC adaptor, or USB cable can damage it and create the risk of fire and electric shock. Make sure you follow the precautions listed below.

- Never locate these items near a stove or other source of intense heat.
- When unplugging the power cord and USB cable, be sure to grasp the plug. Never pull on the cord or cable.
- Plug in the power cord into the wall outlet as far as it will go.
- Plug in the USB cable into the computer and the printer as far as it will go.
- Before leaving the product unattended for long periods (such as when you go on a trip), unplug the power cord and USB cable.
- At least once a year, clean away any dust built up in the area around the prongs of the power cord's plug.



### Batteries

Misuse of batteries can cause them to leak resulting in damage to nearby objects, or to explode, creating the risk of fire and personal injury. Always make sure you observe the following precautions.



- Use only batteries that are specified for use with this product.
- Remove batteries from the product if you do not plan to use it for a long time.

### Connection precaution



Connect only items that are specified for the product to its connectors. Connecting a non-specified item creates the risk of fire and electric shock.

## Caution

### Keep backup copies of all important data



Be sure that you keep separate copies of important data in a notebook or some other location. Malfunction of the product, repairs, and dead batteries can cause data stored memory to be lost.

### Keep heavy objects off.



Never place a heavy object on top of the product. Doing so can cause the object to lose balance and fall, creating the risk of personal injury.

### Location



Avoid the locations listed below for the product. Such locations create the risk of fire and electric shock.

- Areas subject to high humidity and large amounts of dust
- Food preparation areas or other location subjected to oil steam
- Near heaters, on a heated carpet, in direct sunlight, in a closed vehicle parked in the sun, and other areas subjected to high heat.

### Avoid unstable surfaces.



Never place the product on an unstable table, desk, etc. Doing so can cause the product to fall, creating the risk of personal injury.

### Loading and replacing batteries



The springs inside of the battery compartment have sharp edges. Take care that you do not touch the springs with your fingers when loading or replacing batteries. Doing so creates the risk of personal injury.

## Caution

### Display Screen



- Never push on the display screen's LCD panel or subject it to strong impact. Doing so can cause the LCD panel's glass to crack, creating the risk of personal injury.

- Should the LCD panel ever crack or break, never touch the liquid inside of the panel. LCD panel liquid can cause skin irritation.



- Should LCD panel liquid ever get inside your mouth, immediately wash out your mouth with water and contact your physician.

- Should LCD panel liquid ever get into your eyes or onto your skin, rinse with clear water for at least 15 minutes, and then contact a physician.

### High temperature precaution



Never touch the print head or other metal objects near the head. These items become very hot, and touching them creates the risk of burn injury.

---

## Operating Precautions

---

Observe the following precautions to ensure that the printer provides you with the years of trouble-free operation for which it is designed.

- Avoid use in areas subjected to direct sunlight, high humidity, and temperature extremes.  
Operating Temperature Range: 10°C to 35°C (50°F to 95°F)
- Never allow paper clips, pins, or other similar objects to get inside the printer mechanism.
- Never place objects on top of the printer.
- Never try to take the printer apart. Doing so can lead to malfunction.
- Never drop the product, tip it over, or subject it to strong impact.
- Never touch the print head.
- Never use excessive force when pulling the disc tray. The disc tray will not open unless the printer is turned on.

---

## Contents

---

<b>Safety Precautions</b> .....	<b>1</b>
<b>Operating Precautions</b> .....	<b>5</b>
<b>Unpacking</b> .....	<b>7</b>
<b>Part 1 - Getting Acquainted</b> .....	<b>8</b>
<b>About the Bundled CD-ROM and CD-R</b> .....	<b>8</b>
Handling Precautions .....	8
Storage Precautions .....	8
<b>About This Manual</b> .....	<b>8</b>
Key Operations .....	8
<b>How to use this Manual</b> .....	<b>9</b>
<b>CW-75 Printer Features</b> .....	<b>10</b>
<b>General Guide</b> .....	<b>14</b>
<b>Part 2 - Getting Ready</b> .....	<b>15</b>
<b>Power Requirements</b> .....	<b>15</b>
Using Batteries .....	15
Using the AC Adaptor .....	19
<b>Turning Power On and Off</b> .....	<b>19</b>
Power On Recall .....	19
<b>Initializing Printer Memory</b> .....	<b>20</b>
To initialize printer memory .....	20
Data Error .....	20
<b>Ink Ribbon Cassettes</b> .....	<b>21</b>
To load an ink ribbon cassette into the printer .....	21
To replace the ink ribbon cassette .....	23
<b>Selecting the Display Language</b> .....	<b>24</b>
To change the message language .....	24

<b>Adjusting Display Contrast .....</b>	<b>25</b>
To change the display contrast .....	25
<b>Turning Sound On and Off .....</b>	<b>25</b>
To turn sound on or off .....	25
<b>Part 3 - Label Making Overview .....</b>	<b>26</b>
<b>Label Creation Basics .....</b>	<b>26</b>
Start the label creation session .....	26
<b>Part 4 - Advanced Label Making .....</b>	<b>30</b>
<b>Label Making Overview .....</b>	<b>30</b>
Label Making General Flow .....	30
<b>Creating a New Label .....</b>	<b>31</b>
To create a new label .....	31
<b>Part 5 - Inputting Label Data .....</b>	<b>33</b>
<b>Display Symbols and Indicators .....</b>	<b>33</b>
<b>Basic Alpha-Numeric Input .....</b>	<b>35</b>
To input alpha-numeric characters .....	35
<b>Inputting Symbols and Special Characters .....</b>	<b>36</b>
To use the SYMBOL menu .....	36
<b>Inputting Illustrations .....</b>	<b>36</b>
To input illustrations .....	36
<b>User Characters .....</b>	<b>37</b>
User Character Drawing Techniques .....	37
<b>Inserting a Logo Into a Label .....</b>	<b>39</b>
Built In Logos .....	39
Output Samples .....	39
To insert a logo into a label .....	40
<b>Inputting Text into an AUTO Format .....</b>	<b>40</b>
To input text into an AUTO format label .....	40

<b>Using Phrase Memory .....</b>	<b>41</b>
To recall a phrase .....	41
To create new phrase memory text .....	41
To save input text in phrase memory .....	41
To edit a phrase memory record .....	42
To delete a phrase memory record .....	42
<b>Part 6 - Controlling the Appearance of your Text .....</b>	<b>43</b>
<b>Selecting a Font .....</b>	<b>43</b>
About SMALL FONT .....	43
To change the default font setting .....	44
To change the font of text you have just input .....	44
<b>Selecting Bold or Normal Text .....</b>	<b>45</b>
To bold text .....	45
<b>Specifying Character Spacing .....</b>	<b>45</b>
To turn proportional spacing on and off .....	45
<b>Specifying Text Alignment .....</b>	<b>46</b>
To specify text alignment .....	46
<b>Checking the Appearance of Your Label .....</b>	<b>47</b>
To view a preview of the printed label .....	47
<b>Part 7 - Editing Text .....</b>	<b>48</b>
<b>Moving the Cursor .....</b>	<b>48</b>
To move the cursor .....	48
<b>Deleting an Individual Character .....</b>	<b>48</b>
To delete a character using the BS key .....	48
To delete a character using the DEL key .....	48
<b>Clearing the All Text .....</b>	<b>49</b>
To clear all text .....	49
<b>Text Editing .....</b>	<b>49</b>
To switch between overwrite and insert .....	49



<b>Part 8 - Saving Labels in Memory .....</b>	<b>50</b>
<b>Saving, Recalling and Deleting Labels .....</b>	<b>50</b>
To save a label .....	50
To recall a label .....	50
To delete a label .....	50
<b>Part 9 - Printing a Label .....</b>	<b>51</b>
<b>Getting Ready to Print .....</b>	<b>51</b>
To print a label with text in only one area (Label 1 or Label 2) .....	51
To print a label with text in both areas (Label 1 and Label 2) .....	52
<b>Adjusting Print Density .....</b>	<b>55</b>
To adjust print density .....	55
<b>Changing the Tray Auto Open Setting .....</b>	<b>55</b>
To select the tray auto open setting .....	55
<b>Performing a Demo Print .....</b>	<b>56</b>
To perform a demo print .....	56
<b>Part 10 - Connecting to a Computer .....</b>	<b>57</b>
To connect the printer to your computer .....	57
<b>Reference .....</b>	<b>59</b>
<b>User Maintenance .....</b>	<b>59</b>
To clean the print head .....	59
<b>Troubleshooting Guide .....</b>	<b>60</b>
<b>Error Messages .....</b>	<b>62</b>
<b>Illustrations .....</b>	<b>63</b>
<b>Symbols, Dingbats, and Special Characters .....</b>	<b>63</b>
<b>Label Formats .....</b>	<b>64</b>
<b>Specifications .....</b>	<b>66</b>

## Unpacking

Make sure that all of the items shown below are present as you unpack the printer. If anything is missing, contact your original retailer.

### CW-75 DISC TITLE PRINTER



### DISC TITLE PRINTER Application CD-ROM



### USB cable (1.8 meters/5.9 feet)



### Ink ribbon cassette (black) TR-18BK

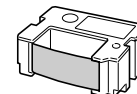

### Positioning guide

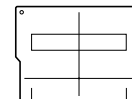

### Eight AA-size alkaline batteries

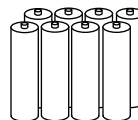

### One blank CD-R disc



# Part 1 - Getting Acquainted

This part of the manual provides you with important general information about your printer.

## About the Bundled CD-ROM and CD-R

Note the following precautions whenever handling or storing the bundled CD-ROM and CD-R.

### Handling Precautions

- When handling the disc, avoid getting finger smudges, dirt, scratches, etc. on either of its surfaces.
- Should the disc become dirty, use an eyeglass cleaning cloth or some other soft cloth to wipe it lightly from the center of the disc outwards towards its edge. Never use phonograph record cleaner or any other cleaning agent.
- Never write on either of the disc's surfaces with a pen or pencil, or affix a sticker to the disc surfaces.
- Use of a disc that is cracked or deformed, or a disc that has adhesive on it is dangerous. Never use such a disc.

### Storage Precautions

- Avoid storing discs in areas subjected to high temperature, high humidity, or direct sunlight.
- When you are not using a disc, store it in its original case or in a commercially available CD case.
- Avoid storing a disc so its label comes in direct contact with the surface of a vinyl case, bag, etc.

#### Warning!

Never play a CD-ROM disc on any device that is not specifically designed to play back CD-ROM discs. Audio output at a high volume setting creates the risk of damaged hearing and damage to audio speakers.

## About This Manual

This manual covers operation of the CW-75 DISC TITLE PRINTER only. For details about using the label layout software that comes bundled with the printer, see the User's Guide on the DISC TITLE PRINTER Application CD-ROM.

#### Important!

- In this manual, the term "printer" refers to the CASIO CW-75 DISC TITLE PRINTER.
- In this manual, the term "label layout software" refers to the DISC TITLE PRINTER application.

## Key Operations

- Required key operations are indicated in text by bold characters or the graphic image of the applicable key.

Example: Press **1** and then **SET**.

- The symbols , , , and  indicate cursor key operations.

#### Important!

Note that the key markings and display images shown in this manual may differ somewhat from those on the actual product.

# How to use this Manual

The sections of this manual are arranged as shown below. Refer to the indicated pages for details.

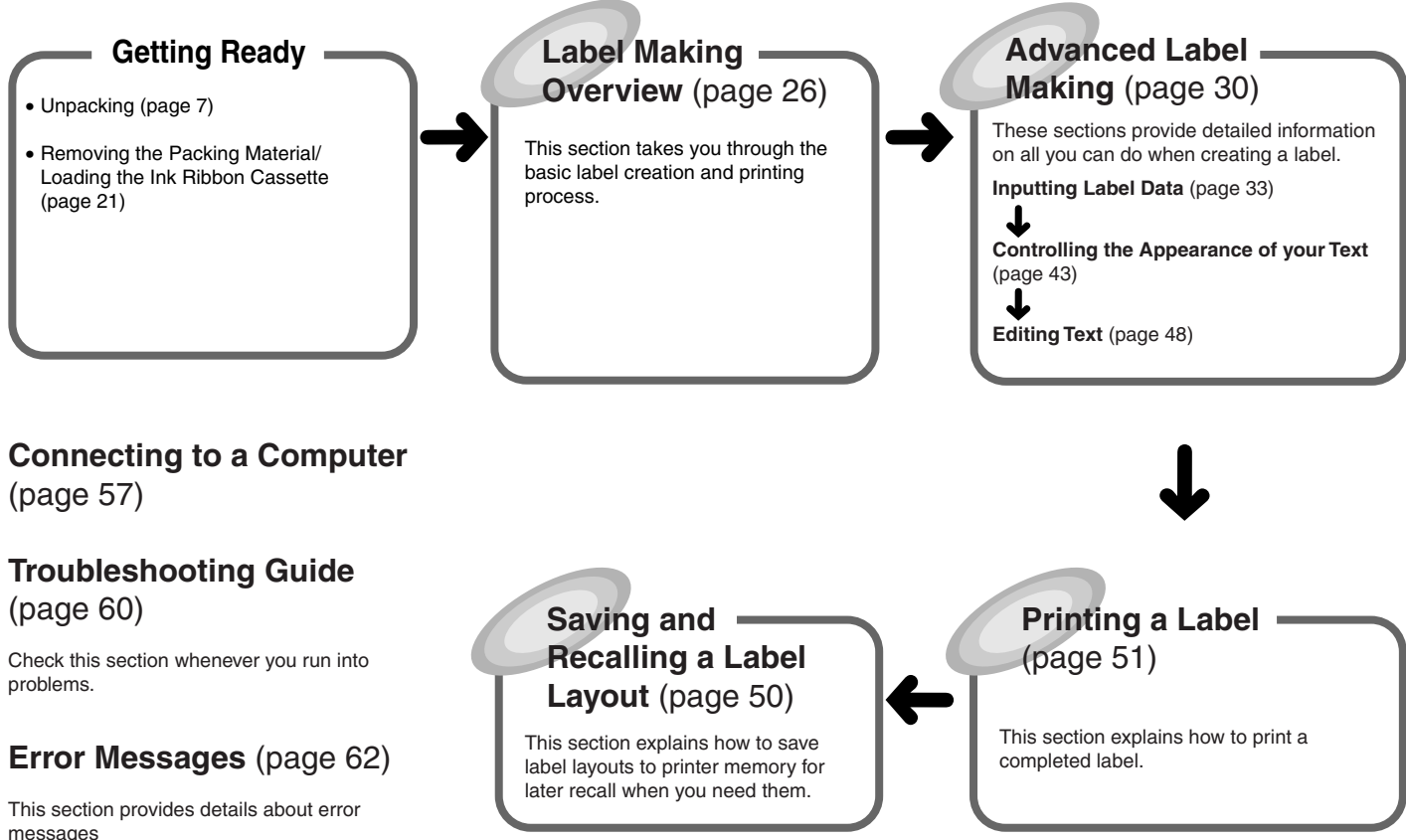

# CW-75 Printer Features

The CW-75 printer lets you quickly and easily print disc labels that include text and logos.

■ **A collection of label layout templates helps to make creation of original labels quick and easy.**

Three built-in print patterns (page 31) and 24 built-in label formats (page 32) provide you with tools to create labels for a wide variety of applications.

You can also select from a collection of logos for your labels (page 39).

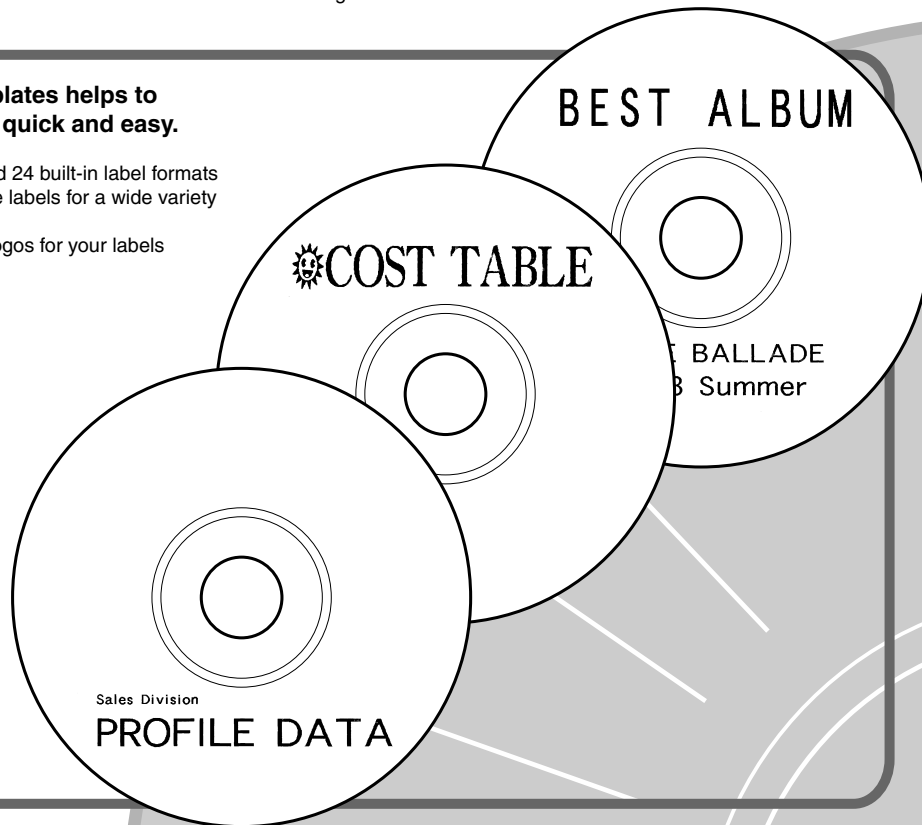

■ **Auto text formatting for beautiful labels every time!**

Auto text formatting (page 40) automatically lays out text in accordance with the number of characters and the amount of available space. Proportional spacing (page 45) adjusts spacing between characters so it always looks natural.

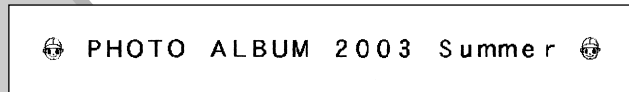
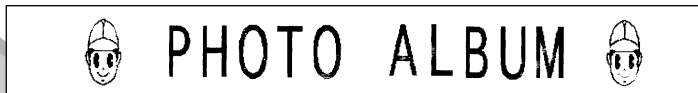

# CW-75 Printer Features

## ■ Incorporate logos into labels.

A total of 10 built-in often-used terms and logos are easily accessible for input into a label (page 39).



■ **A host of other layout tools for perfect labels every time!**

- Fonts (page 43)
- Styles (page 45)
- Symbols (page 36)
- Illustrations (page 36)
- User Characters (page 37)

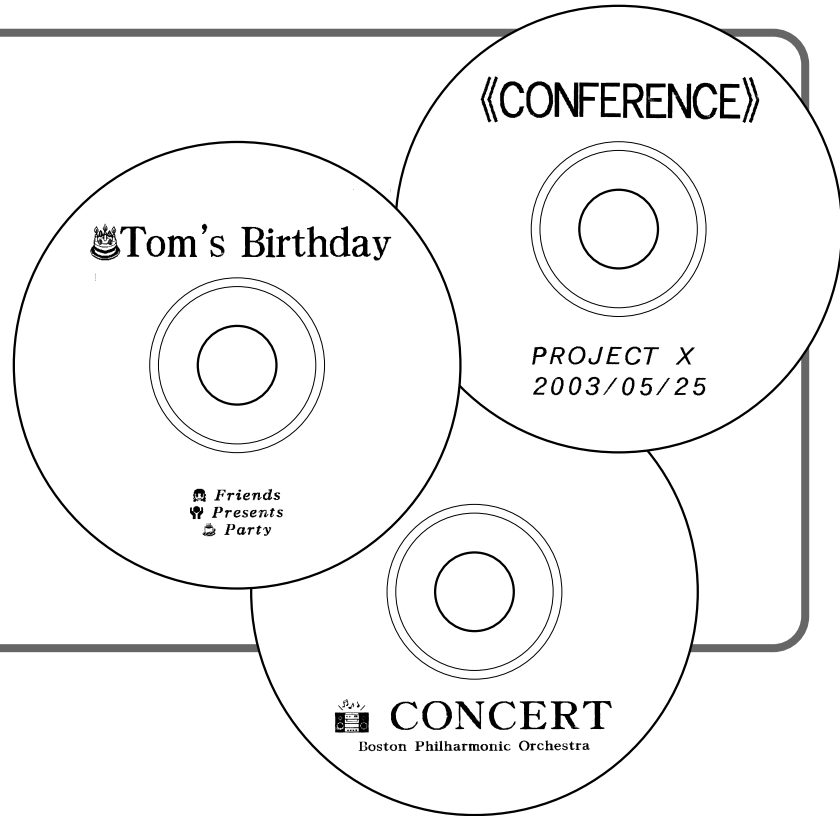

**Important!**

This printer and its software do not include functions for recording data to a disc.

# General Guide

## Front



Press to open the disc tray.

### Front cover

Open when loading or removing the ink ribbon cassette.

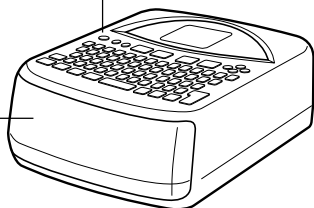

### Carriage

### Printer head

### Disc tray

### Positioning guide pegs

Use these pegs to set the positioning guide correctly when you place the disc onto the disc tray.

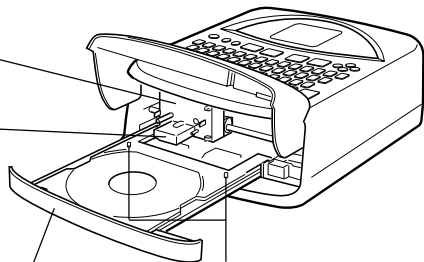

## Back

### Battery compartment

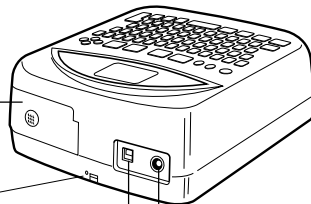

If the disc tray will not open due to printer malfunction, you can open it manually by inserting a thin, pointed object (at least 20 mm ( $1\frac{3}{16}$ " ) long, and less than 1.5 mm ( $\frac{1}{16}$ " ) thick) into this hole.

Use this hole to manually open the disc tray only when absolutely necessary. Do not use it to normally open the tray.

- Do not use a toothpick or other object with an easily breakable tip. Doing so creates the risk of malfunction.

### AC adapter terminal

Connect the optionally available AC adaptor here.

### USB port

Connect the USB cable that comes with the printer here when connecting to your PC.



## Part 2 - Getting Ready

This part of the manual tells you how to load and replace batteries, how to load the ink ribbon cassette, and how to perform other basic setups before using the printer.

---

### Power Requirements

You can power your printer using the optionally available AC adaptor (AD-A12280L) or eight AA-size alkaline batteries.

---

### Using Batteries

This section explains how to set up the printer for operation under battery power.

#### Low battery at power up

If the printer detects low battery power when you turn it on, it displays the message "LOW BATTERY" for about one second.

#### Low battery at the start of a print operation

The message shown below appears when low battery power is detected at the start of a print operation.



LOW BATTERY!  
CONTINUE  
TO PRINT?  
SET/ESC

When the above message appears, replace the batteries or use the optional AC adaptor for power.

- If the print operation is the first one after turning on the printer, you need to press **SET** in order to proceed with the print operation.
- If the print operation is not the first one after turning on the printer, the above message will appear for one second, and then the print operation will start automatically.

#### Important!

Replace batteries at least once a year, even if the low battery message does not appear during that time.

### To load batteries into the printer

1. Slide the battery compartment cover in the direction indicated by the arrow in the illustration, and open the cover.

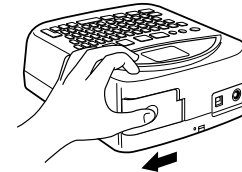

2. Pull the battery case from the compartment.

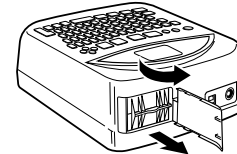

#### Important!

Do not apply excessive force when opening the battery compartment cover, and never try to open it further than it goes naturally. Doing so can damage the cover.

3. Load four of the batteries into the upper part of the case. Next, turn the case over and then load the remaining four batteries.

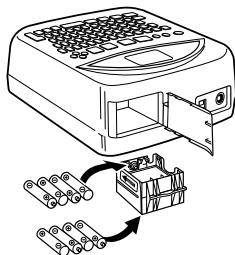

- Double-check to make sure that the positive (+) and negative (-) ends of the batteries are facing correctly when you load them.

4. Slide the battery case back into the battery compartment.

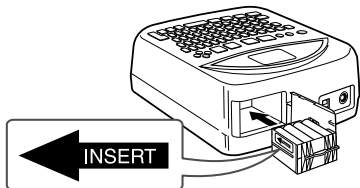

- Orient the battery case so the “INSERT” arrow is facing towards the battery compartment when you slide it in.

**Important!**

Check the battery case for dirt, dust, and other foreign matter before sliding it back into the battery compartment.

5. Close the battery compartment cover and slide it in the direction of the arrow in the illustration to lock it.

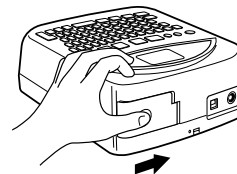

**Battery Life**

- A set of fresh batteries should supply enough power to print about 200 disc labels (at 20°C (68°F), one print operation per disc).
- Printing text or graphics that have a lot of black areas, or printing under low temperatures shortens battery life.

## Replacing the Battery Cover onto Its Hinges

The battery compartment cover may come off its hinges when you open it. If it does, perform the following steps to replace it.

Aligning the cover to the right, insert the upper hinge as shown in the illustration.

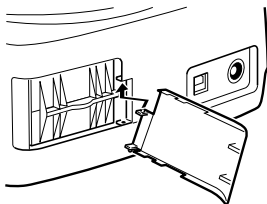

Slide the bottom hinge into place as shown in the illustration.

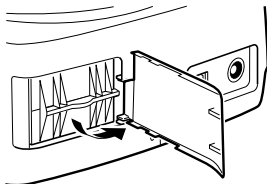

## Using the AC Adaptor

You can use the optionally available AC adaptor (AD-A12280L) to power the printer from a standard household wall outlet.

Note the following important precautions whenever you use the AC adaptor to power your printer.

### To connect the AC adaptor

#### Important!

Use only the AC adaptor model specified for this printer.

1. Connect the power cord to the AC adaptor.

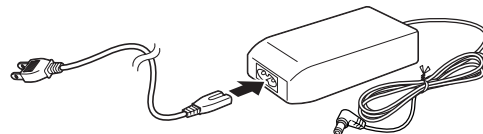

2. Connect the AC adaptor plug to the AC adaptor terminal of the printer ①, and then plug the power cord into a household power outlet ②.

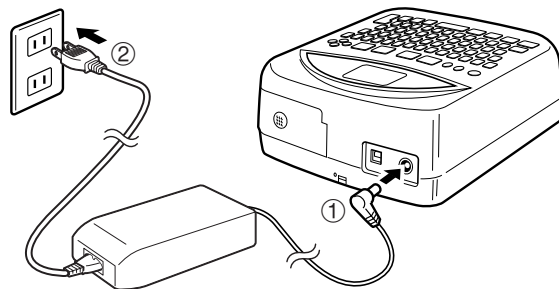

## To disconnect the AC adaptor

### Important!

Never disconnect the AC adaptor while a printing operation is in progress. Doing so can damage the printer.

1. Disconnect the power cord from the household power outlet ①, and then disconnect the AC adaptor plug from the AC adaptor terminal of the printer ②.

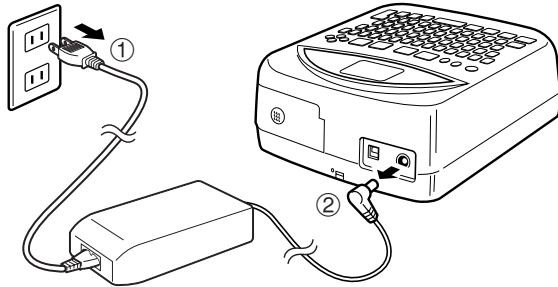

---

## Turning Power On and Off

---

- Press the **ON** button to turn the printer on.  
This turns on power and displays an initial screen like the one shown below.



If you are turning the printer back on after using it previously, the initial screen may also include a **LAST DATA** item. See "Power On Recall" below for more information about this item.

- To turn the printer off, press the **OFF** button.

### Power On Recall

Whenever you turn power off, any label input that is on the display is automatically stored in memory. Then the next time you turn on power, a **LAST DATA** item is added to the initial screen.



Since **LAST DATA** is selected, simply press **SET** to recall the data you were last working on.

If you do not want to recall the data, use the **▲** and **▼** cursor keys to select **NEW** or **STORED DATA**, and then press **SET**.

### Auto Power Off

If you do not perform any key operation for about six minutes, the printer automatically turns power off. To restore power, press **ON**.

#### Note

Auto Power Off is disabled while the printer is being powered by the optionally available AC adaptor and while the printer is connected to a computer.

---

## Initializing Printer Memory

You should initialize the memory of the printer before using it for the first time, after you have not used it for a long time, or if nothing happens when you turn power on.

---

### Important!

Initializing printer memory clears its memory of all input data.

### To initialize printer memory

1. Make sure that the printer is turned off.
2. While holding down the **PRINT** and **ESC** keys, press **(ON)** to turn on power.
3. In response to the confirmation message that appears, press **SET** to initialize the printer memory or **ESC** to abort.

### Data Error

Whenever you turn on the printer, it performs an internal check of its memory and functions. If it finds a serious data problem, it will display the following message:

**DATA ERROR! INITIALIZE THE PRINTER!**

When this message appears, press any key. Next, in response to the “**INITIALIZE? SET/ESC**” message that appears, press **SET** to initialize printer memory (which deletes everything in memory) or **ESC** to clear the message without initializing.

## Ink Ribbon Cassettes

Note that in order to be able to print, you must first load an ink ribbon cassette into the printer.

### Important!

When you purchase your printer, the carriage is held stationary by packing material. Note that you will have to remove the packing material (page 22) before you can load an ink ribbon cassette.

## To load an ink ribbon cassette into the printer

1. Unpack an ink ribbon cassette and remove its stopper.

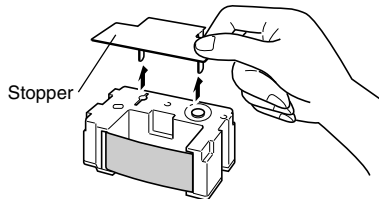

2. Insert a pen or other similar object into the hole of the ink ribbon cassette and rotate it to remove any slack.

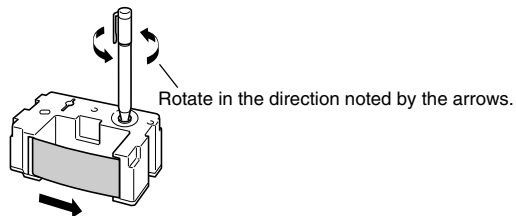

### Important!

- Never apply excessive force when winding the ink ribbon.
- A slack ink ribbon can lead to malfunction of the printer.

3. Press the  button to turn on the printer.

4. Press the  button on the top of the printer.

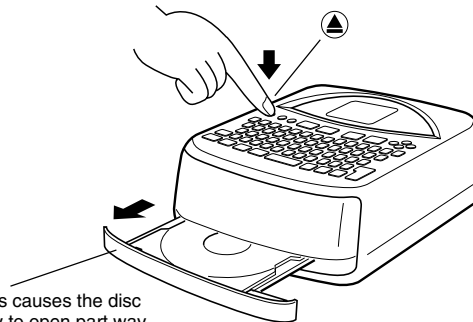

This causes the disc tray to open part way.

### Important!

Make sure there is nothing in front of the printer to interfere with the movement of the disc tray.

5. Pull out the disc tray until it appears as shown in the illustration.

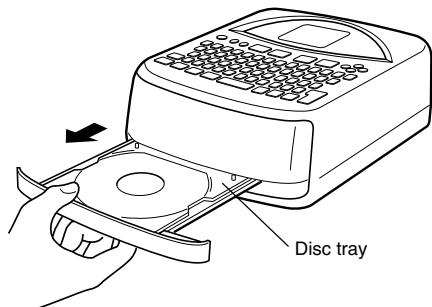

**Important!**

- Never pull on the disc tray with excessive force.
- Never press down on the tray with excessive force. Doing so can damage it.
- If you accidentally pull the tray all the way out of the printer, carefully replace the tray onto the rails.

6. Open the front cover.

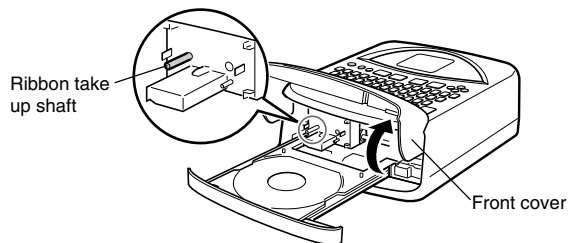

**Important!**

- Take care to avoid applying excessive force to the ribbon take up shaft. Excessive force can cause the shaft to bend.
- Never try to force the front cover to open more than it does naturally. Doing so can damage the printer.

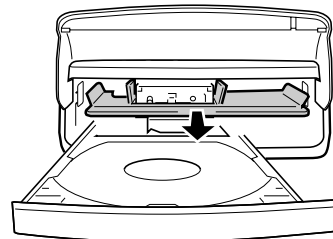

**If you are loading an ink ribbon cassette for the first time**

When you purchase your printer, the carriage is secured in place by packing material. If you are loading an ink ribbon cassette for the first time, be sure to remove the packing material before proceeding with the next step.



Grasp the tab and pull the packing material out in the direction indicated by the arrow.

**Important!**

- Never try to perform any of the following operations while the packing material that secures the carriage is in place. Doing so can damage the printer.
  - Do not repeatedly press the  button.
  - Do not repeatedly click the  button of the label layout application.
  - Do not try to print.
- Never try to force the front cover to open more than it does naturally. Doing so can damage the printer.



7. Position the ink ribbon cassette on the carriage, making sure that the ribbon runs under the printer head.

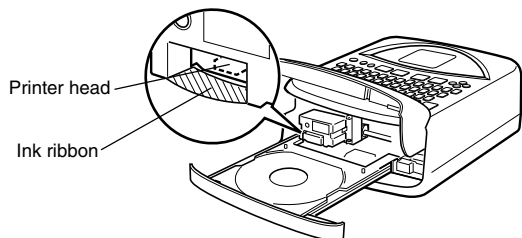

- Take care to avoid excessive slack in the ink ribbon.
- If slack forms, use the procedure in step 2 to wind it up.

8. Carefully press the ink ribbon cassette against the carriage until it snaps securely into place.

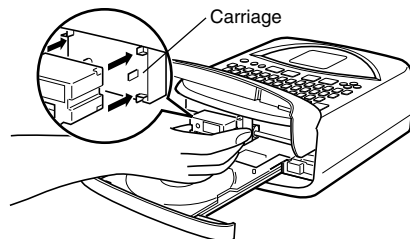

9. Close the front cover.

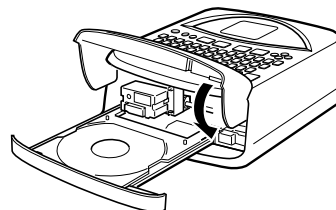



10. Close the disc tray.



- Press the disc tray until it closes securely with a click.
- The printer will make noise when you press the  button while the disc tray is open. This is normal and does not indicate malfunction.

### To replace the ink ribbon cassette

1. Press the  button to turn on the printer.
2. Press the  button on the top of the printer. This causes the disc tray to open part way.

#### Important!

Make sure there is nothing in front of the printer to interfere with the movement of the disc tray.

3. Carefully pull out the disc tray.
4. Open the front cover.

5. Taking care not to move the carriage, grasp both sides of the ink ribbon cassette and pull it straight out of the printer.

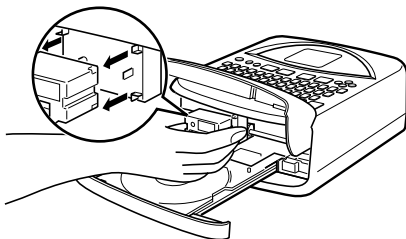

6. Load a new ink ribbon cassette.

### Storing a Partially Used Ink Ribbon Cassette

If you need to store a partially used ink ribbon cassette, attach its stopper, and then insert it into its original plastic bag and box. Keep it in a place that is free of dirt and dust.

### Number of Prints Per Cassette

- Upper label or lower label only: Approximately 40 prints
- Upper label and lower label: Approximately 20 prints

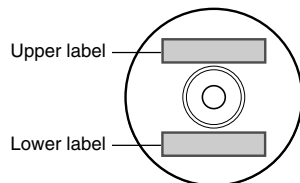

---

## Selecting the Display Language

You can use the following procedure to select any one of five different languages (English, German, French, Italian, Spanish) for display of message text.

- All of the display examples in this manual use English as the display language.

---

### To change the message language

1. Press **SET UP** to display the SET UP menu.
2. Use  $\Delta$  and  $\nabla$  to select **LANGUAGE** and then press **SET**.
3. Use  $\Delta$  and  $\nabla$  to select the language you want to use and then press **SET**.

---

## Adjusting Display Contrast

Use the following procedure to make the characters on the display darker or lighter.

---

### To change the display contrast

1. Press **SET UP** to display the SET UP menu.
2. Use  $\Delta$  and  $\nabla$  to select **CONTRAST**, and then press **SET**.
3. Use  $\leftarrow$  and  $\rightarrow$  to adjust display contrast.
4. After contrast is the way you want, press **SET** to exit the adjustment screen.

---

## Turning Sound On and Off

The label printer is equipped with sound capabilities that signal when power is turned on and when an illegal operation is attempted. Normally, sound is turned on whenever you turn power on, but you can use the following procedure to turn the sound on and off.

---

### To turn sound on or off

1. Press **SET UP** to display the SET UP menu.
2. Use  $\Delta$  and  $\nabla$  to select **SOUND**, and then press **SET**.
3. Use  $\Delta$  and  $\nabla$  to select the setting you want (**ON** or **OFF**), and then press **SET**.

# Part 3 - Label Making Overview

Now that everything is set up, let's try creating a label. This section takes you through the basics of label making, from layout, to printing, and saving the label in a file.

## Label Creation Basics

### Example



### Start the label creation session.

1. Press **ON** to turn on the printer.
  - If you are turning the printer back on after using it previously, the initial screen may also include a **LAST DATA** item. See "Power On Recall" on page 19 for more information about this item.
2. Use **▲** and **▼** to select **NEW**, and then press **SET**.
  - This displays a menu of print patterns.
  - The print pattern controls whether printing is performed in both the upper and lower labels, or in the upper or lower label only.
- **Select the print pattern.**
3. For this example, use **◀** and **▶** to select  and then press **SET**.
  - See page 31 for details about print patterns.
- **Select the format.**
4. For this example, use **◀** and **▶** to select **AUTO2**.
  - See page 32 for details about formats.
  - If you select **AUTO1** or **AUTO2**, the printer will automatically select the proper font size in accordance with the number of characters you input. See "Inputting Text into an AUTO Format" on page 40 for more information.
5. Press **SET**.

## ■ Input the label text.

- Use the following procedure to input text for TITLE 1 and TITLE 2.
6. Input "PHOTO ALBUM" for TITLE 1.
- See page 35 for details about inputting text.

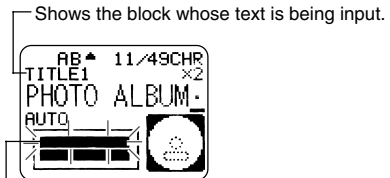

The flashing area in the indicator shows where text is currently being input.

7. Press **SET**.

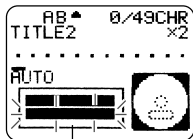

This moves the flashing to the next block.

8. Input "2003 SUMMER" for TITLE 2.

9. Press **SET**.

- This causes the display to appear as shown here.



## When inputting text, you can also specify the following.

- Font (page 43)
- Style (page 45)
- Alignment (page 46)

## ■ Print the label.

### Important!

- See the separate "Printing Precautions" sheet for important information about printing conditions.
- Do not try to use this printer to print on a mini CD-R or a CD-R business card. Doing so can damage the printer. Use the printer to print on 12cm discs only.
- We recommend that you print on a disc or other media before you record anything on it. Printing on a disc that already has data recorded on it can cause the data to become corrupted.

### Check your label before you print it!

Pressing the **PREVIEW** button at any time during text input or before you actually start printing will display a preview of your label. For details, see page 47.

### Important!

Make sure there is nothing in front of the printer to interfere with the movement of the disc tray.

- 10.** After making sure that **PRINT** is selected on the display, press **SET**.
- What appears on the display depends on the print pattern you selected (page 31).
  - See "Printing a Label" on page 51 for details about printing.

Pressing **SET** above will cause the disc tray to open part way. Carefully pull out the disc tray until it appears as shown in the illustration.

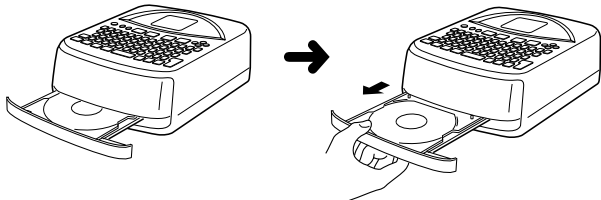

- If the disc tray does not open automatically, press the printer's  button.
- See page 55 for information about configuring disc tray settings.

- 11.** Place the disc onto the disc tray.

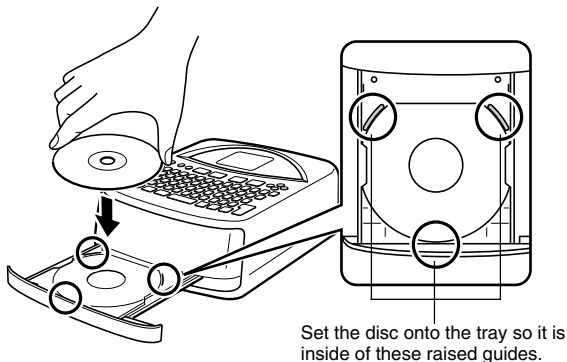

- Make sure that the recording surface is facing downwards, and the printing surface is facing upwards.

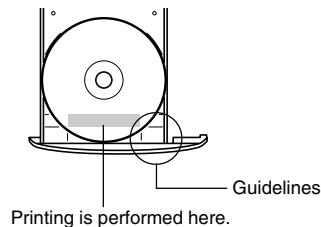

**Important!**

- Check to make sure that the disc tray and the disc are free of dirt, dust, and foreign matter, which can damage the disc surface and make recording to it impossible.
- Make sure that the disc is facing properly. If the recording side of the disc is facing upwards, the printer will print on the recording side, which will make it impossible to record data onto the disc.

- 12.** Close the disc tray.

- Press the disc tray until it closes securely with a click.



- 13.** Press **SET**.

- This starts the print operation.
- After printing is complete, the disc tray opens part way. Carefully pull out the disc tray, and then remove the disc from the tray.
- This completes the printing operation.

### ■ Save the label layout.

Perform the following steps to store the label layout in memory for later recall when you need it.

14. Use the cursor keys to select **STORE**, and then press **SET**.
15. Input the name you want to assign to the layout, and then press **SET**.
  - You can input up to five characters for the layout name.
16. Press **SET** to exit the label store screen.
  - This stores the layout and completes the store operation.

### ■ Quit the label creation session.

17. Use the cursor keys to select **EXIT**, and then press **SET** twice.

# Part 4 - Advanced Label Making

Now that we've covered the basics in the previous section, let's look at some more detailed information about how to layout labels.

This section assumes that you have already gone through the information "Part 3 - Label Making Overview" on page 26. If you have not, please do so now.

## Label Making Overview

You can create a label using any one of the following three techniques.

- Creating a new label from scratch
- Editing a label you previously saved in memory
- Editing the label you were working on the last time you turned off the printer

The following shows the general operational flow for each of these options.

## Label Making General Flow

### Getting Ready

- Load batteries or connect the optionally available AC adaptor (page 15 to 17).
- Load an ink ribbon cassette (page 21).
- Turn on the printer (page 19).

1. To create a new label from scratch, select **NEW** on the initial screen (page 19).

2. Select the print pattern you want to use (page 31).

3. Select the format you want to use (page 32).

4. Input the text you want (pages 33, 48).

5. Select the text attributes you want.

- Specify the font (page 43), select bold (page 45), and specify the text alignment (page 46).

Print the label (page 51) and store it in memory (page 50), if you want.

- Note that the LAST DATA option appears only if you were working on a label the last time you used the printer.

To edit an existing label, select **STORED DATA** on the initial screen (pages 19, 48).

To edit the label data you were working on the last time you were using the printer, select **LAST DATA** (pages 19, 48).



---

## Creating a New Label

---

Use the following procedure when you want to create a new label from scratch, or when you want to continue with the label data you were working on the last time you had the printer turned on.

---

### Example



## To create a new label

1. Press **(ON)** to turn on the printer.
  - If you are turning the printer back on after using it previously, the initial screen may also include a **LAST DATA** item. See "Power On Recall" on page 19 for more information about this item.
2. Use the cursor keys to select **NEW**, and then press **SET**.
  - If you want to continue working with the data from your previous session, select **LAST DATA** instead of **NEW**.
  - Pressing **SET** displays a print pattern selection screen.

### ■ Print Patterns

A print pattern controls the location(s) where printing will be performed.

Print Pattern			

3. Use the cursor keys to select the print pattern you want.

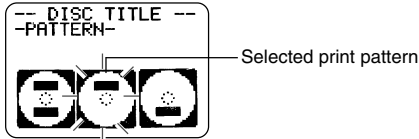

4. Press **SET**.

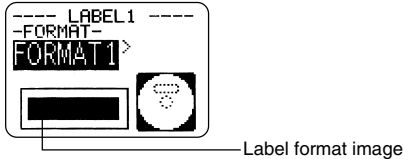

### Label Formats

The label format determines the types and positions of text and logo data for each block. There are a total of 24 different formats, which are divided among three groups: standard formats (FORMAT 1 through FORMAT 18), logo formats (LOGO 1 through LOGO 4), and auto formats (AUTO 1 and AUTO 2).

If you want to do this:	Select this type of format:
Input text only	FORMAT 1 through FORMAT 18
Input text and a logo • See "Inserting a Logo Into a Label" on page 39 for information about inputting logos.	LOGO 1 through LOGO 4
Have the printer automatically select text size in accordance with the number of text lines and the number of characters • See page 40 for more information.	AUTO 1 or AUTO 2

• See "Label Formats" on page 64 for details about all the label formats that are available.

5. Use the ◀ and ▶ cursor keys to scroll through the available label formats until the one you want is displayed.

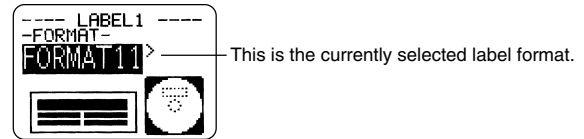

6. Press **SET**.

- Note that if you selected  as the print pattern in step 3, pressing **SET** will display a screen for specifying the label format for the Label 2 area. Repeat steps 5 and 6.
- Pressing **SET** causes the text input screen to appear.

7. Input the text you want.

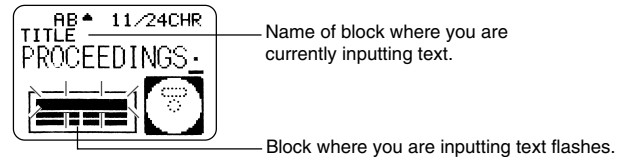

- See "Inputting Label Data" on page 33 for information about inputting text.

8. Press **SET**.

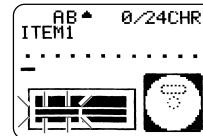

9. Repeat steps 7 and 8 for other blocks.

10. After all input is complete, press **SET**.

- This displays a screen, which you can use to print the label (page 51) or save the label (page 50).
- You can also exit your label making session by using the cursor keys to select **EXIT**, and then pressing **SET** twice.

# Part 5 - Inputting Label Data

This part of the manual tells you how to input text (letters, numbers, or symbols), logos, and illustrations and user characters into a label. For information on using other fonts, styles, and characters sizes, see "Controlling the Appearance of your Text" on page 43.

## Display Symbols and Indicators

Before getting into actual input, you should first become acquainted with the symbols and indicators used on the label data input screen.

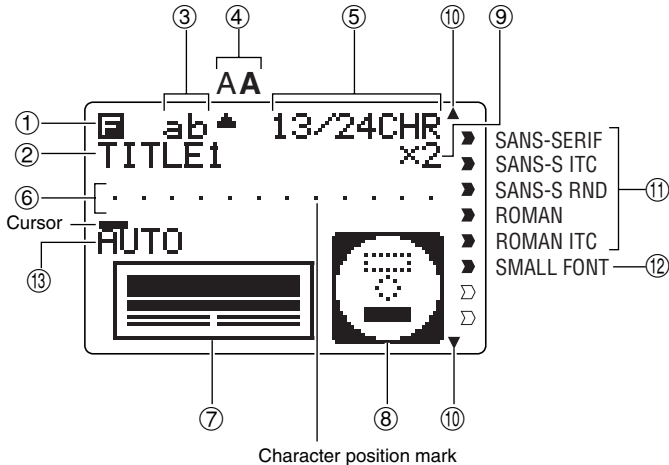

### ① Function/Shift/Code indicator

**F** appears when you press the **FUNCTION** key. Pressing a key while this indicator is on the display causes the function marked above that key to be executed.

**S** appears when you press the **SHIFT** key. While this indicator is on the display, the keyboard is shifted, so the letter keys input the opposite of their current upper-case/lowercase setting. The number keys input the punctuation symbols marked in the upper right corners of the keys. The keyboard automatically unshifts (and the shift indicator disappears) as soon as you input a character.

**C** appears when you press the **CODE** key. While this indicator is on the display, number keys input the accents marked above them and the **U, O, P, A, S, J, K, L, Z, C,** and **N** keys input the special characters marked in their lower right corners. The keyboard automatically returns to normal (and the code indicator disappears) as soon as you input an accent.

**SC** appears when both the **SHIFT** and **CODE** keys are pressed.

### ② Input block name

This indicator shows the name of the block you are currently inputting.

### ③ CAPS on/off indicator/ Insert/Overwrite indicator

"AB" indicates upper-case insert, while "ab" indicates lowercase insert. "AB" indicates upper-case overwrite, while "ab" indicates lowercase overwrite.

### ④ Character style indicator

The pointer is aligned with **A** when bold is selected, and **A** when normal (not bold) is selected.

### ⑤ Character count

These values indicate the character count as shown below

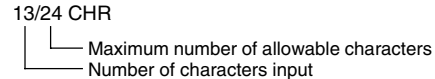

⑥ **Text area**

This is where text appears during input and editing.

⑦ **Label format**

Shows the format of the label being created.

⑧ **Upper/lower label indicator**

This indicator shows the label (upper or lower) that is currently selected for text input.

⑨ **Size indicator**

This indicator appears when you are using auto format.

<b>This indicator:</b>	<b>Means this:</b>
x 1	3 mm ( $\frac{1}{8}$ " )
x 2	6 mm ( $\frac{1}{4}$ " )
x 3	9 mm ( $\frac{3}{8}$ " )
x 4	12 mm ( $\frac{1}{2}$ " )
x 5	15 mm ( $\frac{5}{8}$ " )

⑩ **Scroll indicators**

These indicators appear when there is data above or below the currently displayed screen.

⑪ **Font indicators**

A pointer appears next to the currently selected font.

⑫ **Small font indicator**

A pointer appears here when the SMALL FONT is selected automatically by the printer.

⑬ **Auto format indicator**

This indicator appears when Auto Format is enabled.

---

## Basic Alpha-Numeric Input

The following operation shows you the basic procedures for inputting letters and numbers. Note that it assumes that a text input screen is already on the display.

### Note

If you hold down any key, it will repeat its operation or input at high speed until you release it.

---

## To input alpha-numeric characters

Example: ABXYZ 1234567890

1. Input the characters by typing them on the printer's keyboard.

- To input the upper-case letters, you can use either **SHIFT** or **CAPS**. With **SHIFT** you must shift the keyboard for each character. With **CAPS** the keyboard keeps its upper-case/ lower-case setting until you press **CAPS** again.
- Press **SPACE** to input spaces.
- If you input a wrong character, press **BS** or **DEL** to delete it and input again. See page 48 for other details on editing text.

2. When you reach the end of a line of text, press **SET**.

## About the CODE key...

The **CODE** key makes it possible to input punctuation needed for a number of different languages. The following shows the key operations you should use for each of the characters formed using the **CODE** key.

### ■ CAPS on

Key Operation	Input	Key Operation	Input	Key Operation	Input
CODE U	Ü	CODE Z	Ž	CODE 5	^
CODE O	Œ	CODE C	Ç	CODE 6	˘
CODE P	À	CODE N	Ñ	CODE 7	°
CODE A	Æ	CODE 1	´	CODE 8	/
CODE J	Ö	CODE 2	`	CODE 9	¨
CODE K	Ä	CODE 3	¨	CODE 0	˙
CODE L	Ø	CODE 4	~		

### ■ CAPS off

Key Operation	Input	Key Operation	Input	Key Operation	Input
CODE U	ü	CODE L	ø	CODE 4	~
CODE O	œ	CODE Z	ž	CODE 5	^
CODE P	à	CODE C	ç	CODE 6	˘
CODE A	æ	CODE N	ñ	CODE 7	°
CODE S	ß	CODE 1	´	CODE 8	/
CODE J	ö	CODE 2	`	CODE 9	¨
CODE K	ä	CODE 3	¨	CODE 0	˙

Example: To input á      **CODE 1 (´) A**

---

## Inputting Symbols and Special Characters

---

The SYMBOL menu provides you with a choice of symbols, dingbats, and special number formats, in addition to Greek and Russian letters.

---

### To use the SYMBOL menu

1. With the cursor at the location where you want to input a symbol, dingbat, number, Greek letter, or Russian letter, press the **SYMBOL** key to display the SYMBOL menu.
2. Use the cursor keys to select the type of character you want, and then press **SET**.
  - Pressing **SET** causes a menu of symbols, dingbats, number formats, Greek letters, or Russian letters to appear.
  - To exit the SYMBOL menu without selecting anything, press **ESC**.
3. Use the cursor keys to select the character you want to input, and then press **SET**.
  - Pressing **SET** returns to the input screen, with the symbol, dingbat, number, Greek letter, or Russian letter you selected input at the location where the cursor was located when you displayed the SYMBOL menu.
  - See page 63 for a complete list of symbols, dingbats, Greek letters, and Russian letters that are available from each menu.

---

## Inputting Illustrations

---

Your printer gives you a choice of 124 illustrations that you can use in your labels.

---

### To input illustrations

1. With the cursor at the location where you want to input an illustration, press the **ILLUST** key to display the ILLUST menu.
2. Use the cursor keys to select the illustration you want to input, and then press **SET**.
  - Pressing **SET** returns to the input screen with the illustration you selected input at the location where the cursor was located when you displayed the ILLUST menu.
  - See page 63 for a complete list of illustrations that are available.

---

## User Characters

---

You can create up to four user characters and store them in memory. You can create a character from scratch, or you can use an existing character or symbol as a basis for your new character.

---

### User Character Drawing Techniques

The following are the basic techniques for drawing on the user character screen.

#### To draw characters

Use the cursor keys to move the cursor around the character creations screen.

- **FUNCTION** ⬅ and **FUNCTION** ➡ makes the cursor jump to the far left or far right of the screen (when "CONTINUE" is not highlighted).
- **FUNCTION** ⬆ and **FUNCTION** ⬇ makes the cursor jump to the top or bottom of the screen (when "CONTINUE" is not highlighted).

#### To draw a dot

Press **1** to draw a black dot at the cursor position or **2** to draw a white dot.

#### To draw a series of black dots

Press **1** to select "**BLACK**", and then press **3** to select "**CONTINUE**". In this condition, a continuous series of black dots will be drawn when you move the cursor.

#### To draw a series of white dots

Press **2** to select "**WHITE**", and then press **3** to select "**CONTINUE**". In this condition, a continuous series of white dots will be drawn when you move the cursor.

### To create a user character using an existing character

1. Input the character or symbol you want to use as a basis for your new character and locate the cursor under the character.
2. Press **USER CHR**.
3. Use the cursor keys to select "MAKE" and then press **SET**.
4. Use the cursor keys to select "USE INPUT CHAR" and then press **SET**.
  - The input screen will show an image of the character you input in step 1.
  - If you selected "**NEW**", a screen appears for creating a character from scratch.
5. Use the user character drawing techniques in the left column of this page to change the image on the screen.
6. After you are finished changing the character, press **SET**.
7. Use the cursor keys to select the user character area where you want to store the character and then press **SET**.
  - If the user character area you select already has a character in it, the old character will be replaced with the new one.
8. In response to the confirmation message that appears, press **SET** to store the character.
  - If there was no input character at the cursor location when you pressed **USER CHR** in step 2, the screen for creating a new character from scratch appears when you press **SET** in step 3.

### **To create a user character from a user character you created**

- 1.** Press **USER CHR**.
- 2.** Use the cursor keys to select “**EDIT**” and then press **SET**.
- 3.** Use the cursor keys to select the user character you want to edit, and then press **SET**.
- 4.** Use the user character drawing techniques on page 37 to edit the character, and then press **SET**.
- 5.** Continue from step 7 under “To create a user character using an existing character” to store the edited character.

### **To recall a user character**

- 1.** With the cursor located in the input screen where you want to input the user character, press **USER CHR**.
- 2.** Use the cursor keys to select “**RECALL**” and then press **SET**.
- 3.** Use the cursor keys to select the user character you want and then press **SET**.

### **To delete a user character**

- 1.** Press **USER CHR**.
- 2.** Use the cursor keys to select “**DELETE**” and then press **SET**.
- 3.** Use the cursor keys to select the user character you want and then press **SET**.
- 4.** In response to the confirmation message that appears, press **SET** to delete the selected character or **ESC** to abort.



---

## Inserting a Logo Into a Label

---

When creating a label using a LOGO format (LOGO 1 through LOGO 4), you can insert one of the printer's 10 built-in logos into the graphic block of the format.

---

### Built In Logos



## Output Samples

The following shows examples of labels that use logos.

### LOGO 1



### LOGO 2



### LOGO 3



### LOGO 4



## To insert a logo into a label

1. Perform steps 1 through 4 of the procedure under "To create a new label" on page 31.
2. On the label format selection screen, use  $\odot$  and  $\ominus$  to scroll through the label formats until one of the LOGO formats (LOGO 1 through LOGO 4) is displayed.
3. Press **SET**.
4. Use  $\odot$  and  $\ominus$  to scroll through the logo data names, until the one you want is on the display.
5. Press **SET**.
  - This inserts the logo into the label. Now you can perform the other steps under "To create a new label" on page 31 to input text.

## Inputting Text into an AUTO Format

The two AUTO formats automatically adjust the size of characters in accordance with the number of characters you input.

The table below shows how character size is adjusted for each auto format.

Number of Input Characters	AUTO 1 (1 line)		AUTO 2 (2 lines)	
	Displayed Size	Printed Size	Displayed Size	Printed Size
0 to 9	×5	15mm ( $\frac{5}{8}$ " )	×2	6mm ( $\frac{1}{4}$ " )
10 to 12	×4	12mm ( $\frac{1}{2}$ " )	×2	6mm ( $\frac{1}{4}$ " )
13 to 16	×3	9mm ( $\frac{3}{8}$ " )	×2	6mm ( $\frac{1}{4}$ " )
17 to 24	×2	6mm ( $\frac{1}{4}$ " )	×2	6mm ( $\frac{1}{4}$ " )
25 to 49	×1	3mm ( $\frac{1}{8}$ " )	×1	3mm ( $\frac{1}{8}$ " )

## To input text into an AUTO format label

1. Perform steps 1 through 4 of the procedure under "To create a new label" on page 31.
2. On the label format selection screen, use  $\odot$  and  $\ominus$  to scroll through the label formats until AUTO 1 or AUTO 2 is displayed.
3. Press **SET**.
4. Input the text you want.
5. Press **SET**.
  - Now you can perform the other steps under "To create a new label" on page 31 to complete the label.

---

## Using Phrase Memory

---

Phrase memory provides storage of nine phrases you can recall and input into your labels. Initially, phrase memory records 1 through 8 are preset with often-used disc label phrases. You can use these as they are or replace them with your own text.

The following are the initial contents of the phrase memory records.

- 1 Digital Image
- 2 Date Recorded:
- 3 Backup Data
- 4 Confidential
- 5 Hit Album
- 6 Omnibus
- 7 My Favorites
- 8 Recorded At:
- 9 <Empty>

### To recall a phrase

1. While inputting text, press **PHRASE MEMORY**.
  - This displays a list of available phrases.
2. Use the **▲** and **▼** cursor keys to select the phrase you want to recall, and then press **SET**.
  - This recalls the phrase you selected and inputs it into the input screen.
  - You could also select a phrase by inputting its record number, from 1 through 9.
  - If the phrase you selected causes the number of input characters to exceed the allowable limit, the error message **"ENTIRE PHRASE COULD NOT BE RECALLED!"** appears for about one second. The phrase is partially input, up to the allowable limit.

### To create new phrase memory text

1. Press **PHRASE MEMORY**.
2. Use the cursor keys to select **[DATA EDIT]**, and then press **SET**.
3. Use the cursor keys to select **MAKE**, and then press **SET**.
4. Use the cursor keys to select **NEW**, and then press **SET**.
  - The **NEW / STRING→PHRASE** screen does not appear if there is not text currently input on the text input screen.
5. On input screen that appears, input the text that you want, and then press **SET**.
6. Use the cursor keys to select the phrase memory where you want to store the text, and then press **SET**.
7. In response to the confirmation message that appears, press **SET** to save the phrase or **ESC** to abort.

### To save input text in phrase memory

1. While inputting the text you want to save on the input screen, press **PHRASE MEMORY**.
2. Use the cursor keys to select **[DATA EDIT]**, and then press **SET**.
3. Use the cursor keys to select **MAKE**, and then press **SET**.
4. Use the cursor keys to select **STRING→PHRASE**, and then press **SET**.
5. On the input screen that appears, check the text and make any changes that you want and then press **SET**.
6. Use the cursor keys to select the phrase memory where you want to store the text, and then press **SET**.
7. In response to the confirmation message that appears, press **SET** to save the phrase or **ESC** to abort.

## To edit a phrase memory record

1. Press **PHRASE MEMORY**.
2. Use the cursor keys to select [**DATA EDIT**], and then press **SET**.
3. Use the cursor keys to select **EDIT**, and then press **SET**.
4. Use the cursor keys to select the phrase memory record whose contents you want to edit, and then press **SET**.
5. On the text screen that appears, check the text and make any changes that you want, and then press **SET**.
6. Use the cursor keys to select the phrase memory where you want to store the text, and then press **SET**.
7. In response to the confirmation message that appears, press **SET** to save the phrase or **ESC** to abort.

## To delete a phrase memory record

1. Press **PHRASE MEMORY**.
2. Use the cursor keys to select [**DATA EDIT**], and then press **SET**.
3. Use the cursor keys to select **DELETE**, and then press **SET**.
4. Use the cursor keys to select the phrase memory record whose contents you want to delete, and then press **SET**.
5. In response to the confirmation message that appears, press **SET** to delete the phrase or **ESC** to abort.

## Part 6 - Controlling the Appearance of your Text

The operations in this section explain how to select fonts, how to bold text, and how to align text.

- In this manual, the font, bolding, and text alignment are all referred to as text attributes.

### Important!

- Text attributes affect printed text only. The characters on the display do not change.
- Whenever you replace a character with another one, the new character also picks up the attributes of the original character.

---

### Selecting a Font

---

Your printer gives you a choice of the following five fonts.

- New Sans-serif (SANS-SERIF)

ABC

- New Sans-serif Italic (SANS-SERIF ITC)

*ABC*

- New Sans-serif Rounded (SANS-SERIF RND)

ABC

- New Roman (ROMAN)

ABC

- New Roman Italic (ROMAN ITC)

*ABC*

You can specify a font for all the text or for a specific line of text. You can even specify a default font that is used automatically whenever you create a new label.

The current font setting is indicated by the pointer along the right side of the display.

### About SMALL FONT

In addition to the five user-selectable fonts, the printer also has a "SMALL FONT," which is used automatically whenever the character size is 2mm, regardless of the current font setting.

Note that you cannot select the font size. The printer selects font sizes and the SMALL FONT setting automatically.

### Note

The proportional setting (page 45) is ignored while the SMALL FONT is being used.

## To change the default font setting

1. Press **SET UP** to display the SET UP menu.
2. Use the cursor keys to select “**DEFAULT FONT**” and then press **SET**.
3. Use the cursor keys to select the font you want to use as the default, and then press **SET**.
  - The default font you specified will be used first for all new labels. When inputting text, you can use the procedure below to change the font to another style, if you want.

## To change the font of text you have just input

1. After inputting the text you want, press **FONT**.
2. Use the cursor keys to select the font you want to change to and then press **SET**.
3. On the next screen that appears, select the range of text to which you want to apply your font setting.

To apply the font setting to this text:	Select this option:
All of the text in the label	ALL
All of the text in the current line only	LINE

4. After selecting the range, press **SET** to apply your setting and return to the text input screen.

---

## Selecting Bold or Normal Text

---

Use the following procedure to specify either bold or normal for text.

---

The current bold/normal setting is indicated on the display as shown below.

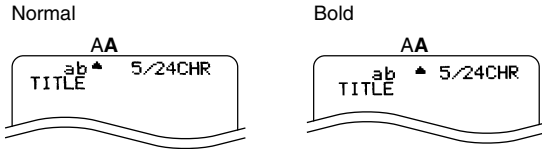

### To bold text

1. While inputting text, press **STYLE**.
2. Use the cursor keys to select **BOLD**, and then press **SET**.
  - If you are changing bold text to normal text, select **NORMAL**.
3. On the next screen that appears, select the range of text to which you want to apply your font setting.

To apply the bold/normal setting to this text:	Select this option:
All of the text in the label	ALL
All of the text in the current line only	LINE

4. After selecting the range, press **SET** to apply your setting and return to the text input screen.

---

## Specifying Character Spacing

---

There are two ways that characters can be spaced: proportional spacing and uniform spacing.

With proportional spacing, the amount of space between two characters depends on what those two characters are.

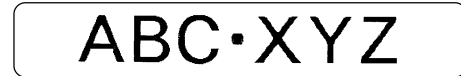

With uniform spacing, all characters are separated by the same amount of space.



### To turn proportional spacing on and off

1. While inputting text, press **FORM**.
2. Use the cursor keys to select **PROPORTIONAL**, and then press **SET**.
3. Use the ⏪ and ⏩ cursor keys to turn proportional spacing on or off.
  - Note that the setting you select is applied to all the text of the label.
4. Press **SET** to apply your setting and return to the text input screen.

---

## Specifying Text Alignment

---

You can select any one of the following four text alignments for your label text.

### Centering

ABC·XYZ

### Left Alignment

ABC·XYZ

### Right Alignment

ABC·XYZ

### Equal Spacing

A B C · X Y Z

## To specify text alignment

1. While inputting text, press **FORM**.
2. Use the cursor keys to select **ALIGN**, and then press **SET**.
3. Use the ◀ and ▶ cursor keys to select the alignment setting you want.
4. When the setting you want is selected, press **SET**.
5. On the next screen that appears, select the range of text to which you want to apply your alignment setting.

To apply the alignment setting to this text:	Select this option:
All of the text in the label	ALL
All of the text in the current line only	LINE

6. After selecting the range, press **SET** to apply your setting and return to the text input screen.



---

## Checking the Appearance of Your Label

After laying out your label, you can use the following procedure to view a preview of what it will look like when print it.

---

### To view a preview of the printed label

1. After laying out the label, press **PREVIEW**.

The label scrolls  
on the printer  
display.



2. If your layout includes upper label (Label 1) and the lower label (Label 2), use the ⏪ and ⏩ cursor keys to switch between them, and then press **SET**.
3. To stop the scrolling at any point, press **SET**.
  - While the scrolling is stopped, you can use the ⏪ and ⏩ cursor keys to scroll step-by-step.
  - To restart scrolling, press **SET** again.
  - To stop viewing the preview, press **ESC**.

#### Note

- Characters or illustrations with very fine lines may not appear correctly on the preview screen.
- If the label contains a large volume of text or many lines, it may take some time for the preview image to appear.

# Part 7 - Editing Text

This section describes everything you need to know about deleting and editing text you have already input.

## Moving the Cursor

Use the cursor keys to move the cursor around the display and position it for deleting and editing characters.

### To move the cursor

To perform this operation:	Do this:
Move the cursor left	Press ⬅.
Move the cursor right	Press ➡.
Move the cursor to the beginning of the current line of text	Press <b>FUNCTION</b> ⬅.
Move the cursor to the end of the current line of text	Press <b>FUNCTION</b> ➡.

## Deleting an Individual Character

You can delete an individual character with either the **BS** key or the **DEL** key. The only difference between the operations of these two keys is the location of the cursor.

### To delete a character using the BS key

Example: To change the word “commmputer” to “computer”.

1. Use ⬅ and ➡ to move the cursor under “p”.
2. Press **BS** twice to delete the two m’s to the left of the cursor, shifting “puter” to the left as you do.

### To delete a character using the DEL key

Example: To change the word “commmputer” to “computer”.

1. Use ⬅ and ➡ to move the cursor under the first (far left) “m”.
2. Press **DEL** twice to delete the two m’s at the cursor’s position, shifting “mputer” to the left as you do.

---

## Clearing the All Text

---

Use the following steps to clear all input text that is currently on the input screen.

---

### To clear all text

1. Press **FUNCTION** and then **BS** (CLS).
2. In response to the confirmation message that appears, press **SET**.
  - This clears all the text from the input screen.
  - If you want to abort the clear operation without deleting anything, press **ESC** in place of **SET**.

---

## Text Editing

---

You can set up the label printer so it either overwrites existing characters with new input, or inserts new input between existing characters. Note the following example.

---

### Example

Existing text: ABCDEFGHI  
Cursor location: E  
New input: XXX

### Overwrite

Result: ABCDXXXHI

### Insert

Result: ABCDXXXEFGHI

### To switch between overwrite and insert

1. Press **SET UP** to display the SET UP menu.
2. Use the cursor keys to select **"INPUT"** and then press **SET**.
3. On the next screen that appears, use the cursor keys to select **"INSERT"**, or **"OVERWRITE"** and then press **SET**.
  - The CAPS indicator on the display is highlighted when overwrite is turned on. The CAPS indicator appears normally (unhighlighted) when insert is turned on.

# Part 8 - Saving Labels in Memory

You can use the procedures in this section to store the labels you create in memory for later recall when you need them. After you recall a label you can print it or edit it into a new label.

## Saving, Recalling and Deleting Labels

### To save a label

1. Create the label you want to save.
2. After you finish inputting text, the following screen will appear on the printer display.



3. Use the cursor keys to select **STORE**.
4. Press **SET**.
5. Input up to five characters for the label name, and then press **SET**.



Total amount of memory used by currently stored labels.

6. In response to the confirmation message that appears, press **SET** to save the label or **ESC** to abort.

### To recall a label

1. Press **ON** to turn on the printer.
2. Use **▲** and **▼** to select **STORED DATA**, and then press **SET**.
3. Use **▲** and **▼** to select **RECALL**, and then press **SET**.
4. Use **▲** and **▼** to scroll through the label names until the one you want to recall is displayed.
5. Press **SET** to display the label.
  - Now you can print the label or make any changes you want in it.

### To delete a label

1. Press **ON** to turn on the printer.
2. Use **▲** and **▼** to select **STORED DATA**, and then press **SET**.
3. Use **▲** and **▼** to select **DELETE**, and then press **SET**.
4. Use **▲** and **▼** to scroll through the label names until the one you want to delete is displayed.
5. Press **SET**.
6. In response to the confirmation message that appears, press **SET** to delete the label or **ESC** to abort.

# Part 9 - Printing a Label

This section contains two procedures for printing labels. The procedure you should use depends on whether your label has text in both the upper (Label 1) and lower (Label 2) areas, or if it has text in only one of the areas (Label 1 or Label 2).

## Important!

- See the separate “Printing Precautions” sheet for important information about printing conditions.
- Do not try to use this printer to print on a mini CD-R or a CD-R business card. Doing so can damage the printer. Use the printer to print on 12cm discs only.
- We recommend that you print on a disc or other media before you record anything on it. Printing on a disc or other media that already has data recorded on it can cause the data to become corrupted.

---



## Getting Ready to Print

- Load batteries or connect the optionally available AC adaptor (pages 15 and 17).
- Load an ink ribbon cassette (page 21).
- Turn on the printer (page 19).

---

## To print a label with text in only one area (Label 1 or Label 2)

### Note

Use this procedure to print a label whose print pattern is  or .

This example shows the procedure when the print pattern is .

1. After you finish inputting text, the following screen will appear on the printer display.



2. Use the cursor keys to select **PRINT**, and then press **SET**.



- This causes the disc tray to open part way.
- If the disc tray does not open, press the  button on the top of the printer. See “Changing the Tray Auto Open Setting” on page 55 for configuring the disc tray auto open setting.
- If the print pattern of your label is , the above message will be “POSITION DISC WITH THE BOTTOM AREA FACING YOU [SET]”.

3. Carefully pull out the disc tray as far as it will go.

**4.** Place the disc onto the disc tray.

Make sure the recording surface is pointing downwards (printing surface upwards).

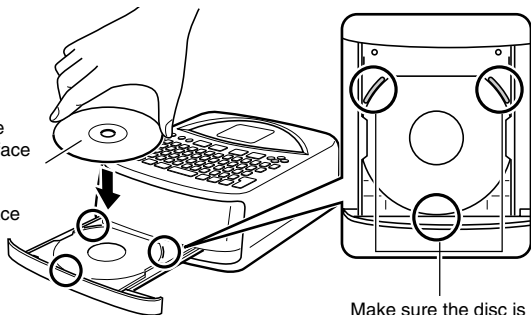

Make sure the disc is not on top of these raised areas.

Be sure to position the disc in accordance with the layout of the label.

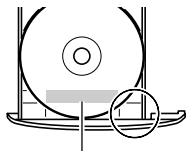

Printing will be performed in the area bounded by the guidelines.

**Important!**

- Check to make sure that the disc tray and the disc are free of dirt, dust, and foreign matter, which can damage the disc surface and make recording to it impossible.
- Make sure that the disc is facing properly. If the recording side of the disc is facing upwards, the printer will print on the recording side, which will make it impossible to record data onto the disc.

**5.** Close the disc tray.

- Press the disc tray until it closes securely with a click.

**6.** Press **SET**.

- This starts the print operation.

**7.** After printing is complete, the initial printer screen will appear and the disc tray will open part way. Carefully pull out the disc tray and remove the disc.

**To print a label with text in both areas  
(Label 1 and Label 2)**

**Note**

Use this procedure to print a label whose print pattern is .

**1.** After you finish inputting text, the following screen will appear on the printer display.



**2.** Use the cursor keys to select **PRINT**, and then press **SET**.

3. Use the ◀ and ▶ cursor keys to select either **LABEL1** (upper label area) or **LABEL2** (lower label area), and then press **SET**.
- For this example, we will select LABEL1.



- This causes the disc tray to open part way.
  - If the disc tray does not open, press the ▲ button on the top of the printer. See “Changing the Tray Auto Open Setting” on page 55 for configuring disc tray auto opening.
4. Carefully pull out the disc tray as far as it will go.
5. Place the disc onto the disc tray.
- See the disc positioning precautions under step 4 of the “To print a label with text in only one area (Label 1 or Label 2)” procedure on page 51.
6. What you should do next depends on whether your disc has distinctly defined areas for printing, or if printing can be performed anywhere on the disc surface.
- If the disc has distinctly defined print areas, perform steps 7 through 9.
  - If printing can be performed anywhere on the disc surface, go directly to step 10.

7. Place the positioning guide on the disc.

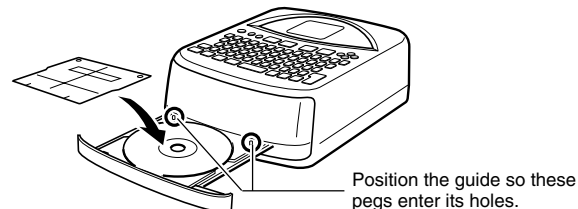

8. Rotate the disc so the area to be printed is within the frame of the positioning guide.

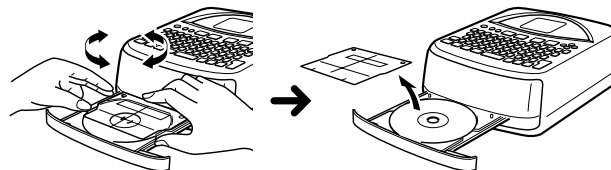

- See “Positioning the Disc on the Disc Tray” on page 54 for more information.
9. After the disc is positioned correctly, remove the positioning guide.

**Important!**

Never leave the positioning guide on the disc when printing.

10. Close the disc tray.
- Press the disc tray until it closes securely with a click.
11. Press **SET**.
- This starts printing of the Label 1 area.

12. After printing of the Label 1 area is complete, a screen like the one shown here will appear, and the disc tray will open part way. Carefully pull out the disc tray and remove the disc.



13. Press **SET**.

14. Rotate the disc 180 degrees and place it back onto the disc tray.

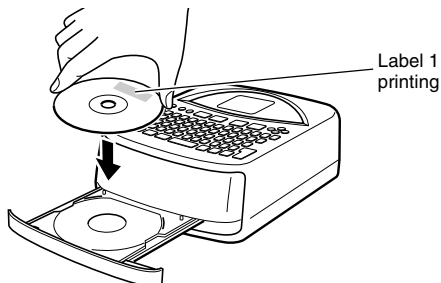

15. Repeat steps 7 through 9 to position the disc.
- See "Positioning the Disc on the Disc Tray" in the right column of this page.
16. Close the disc tray and press **SET**.
- This starts the Label 2 print operation.
17. After printing is complete, the initial printer screen will appear and the disc tray will open part way. Carefully pull out the disc tray and remove the disc.

### Positioning the Disc on the Disc Tray

Use the positioning guide to adjust the position of the disc on the tray in the following cases.

- When the label of the disc already has logos or other markings
- When performing separate upper block and lower block printings

#### When the label of the disc already has logos or other markings

Note that you cannot print over a logo. Position the disc so the logo or other markings on the disc label are not inside the shaded area.

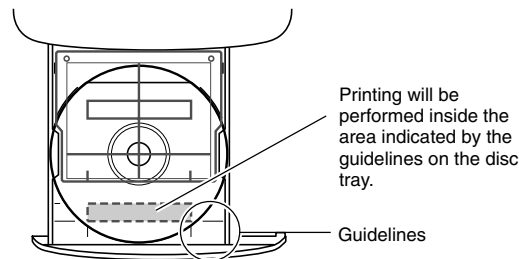

#### When performing separate upper block and lower block printings

Before performing the second printing, rotate the disc 180 degrees. Next, position the disc so the first printing is within the shaded area.

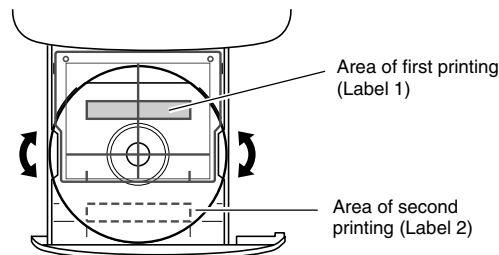



---

## Adjusting Print Density

You can use the following procedure to adjust the density of printed characters.

---

### To adjust print density

1. Press **SET UP** to display the SET UP menu.
2. Use the cursor keys to select "DENSITY" and then press **SET**.
3. Use the ⏪ and ⏩ cursor keys to adjust print density.
4. After the setting is the way you want, press **SET**.

---

## Changing the Tray Auto Open Setting

The tray auto open setting determines whether or not the disc tray opens automatically when you start a print operation.

---

### To select the tray auto open setting

1. Press **SET UP** to display the SET UP menu.
2. Use the cursor keys to select "TRAY" and then press **SET**.
3. Use the ⏶ and ⏷ cursor keys to select the setting you want.

To do this:	Select this setting:
Have the disc tray open automatically whenever a print operation is performed	OPEN AUTOMATIC
Open the disc tray manually when performing print operations	OPEN MANUALLY

4. After the setting is the way you want, press **SET**.

### Note

The disc tray always opens automatically after printing is complete, regardless of the setting you select here.

---

## Performing a Demo Print

The following describes how to perform a demo print, which uses built-in sample data to print a label.

### Important!

Performing a demo print causes any label data you are working with to be deleted. If you want to keep label data you are working on, use the procedure under “Saving Labels in Memory” on page 50 to save it before performing the following procedure.

---

### To perform a demo print

1. Check to make sure that the printer has an ink ribbon cassette loaded.
2. If the printer is turned on, press **OFF** to turn it off.
3. Press **ON** to turn on the printer.
4. Press **SET UP** to display the SET UP menu.
5. Use the cursor keys to select **DEMO PRINT** and then press **SET**.
6. Use the **▲** and **▼** cursor keys to select **DATA1** or **DATA2** as the data you want to print, and then press **SET**.
7. Use the **▲** and **▼** cursor keys to select **PRINT** and then press **SET**.
8. Use the **◀** and **▶** cursor keys to select either **LABEL1** (upper label area) or **LABEL2** (lower label area), and then press **SET**.
9. Place the disc onto the disc tray.
  - If the disc tray does not open, press the **▲** button on the top of the printer. See “Changing the Tray Auto Open Setting” on page 55 for configuring the disc tray auto open setting.

10. Press **SET**.
  - This starts the print operation.
  - **DATA1** and **DATA2** of the sample are printed at two locations on the disc. For more information, see “To print a label with text in both areas (Label 1 and Label 2)” on page 52.
11. After printing is complete, the disc tray will open part way. Carefully pull out the disc tray and remove the disc.
12. After you are finished printing, use the **▲** and **▼** cursor keys to select **EXIT**, and then press **SET**.
13. In response to the confirmation message that appears, press **SET**.

# Part 10 - Connecting to a Computer

Your printer comes bundled with a CD-ROM that contains the “DISC TITLE PRINTER” label layout software, which allows you to create original labels on your computer. Then you can use the bundled USB cable to connect the printer to your computer and print the labels.

## Important!

- In this manual, the term “label layout software” refers to the DISC TITLE PRINTER application.
- See the separate DISC TITLE PRINTER Application User’s Guide on the CD-ROM for information about using the label layout software.

## To connect the printer to your computer

1. Install the label layout software on your computer.
  - See the separate Installation Guide and the DISC TITLE PRINTER Application User’s Guide on the CD-ROM.
2. Load batteries into the printer or connect the optionally available AC adaptor for power.
  - See page 15 of this manual for more information.
3. Make sure that the printer is turned off.
  - If the printer is turned on, press **⏻** to turn it off.
4. Connect the USB cable that comes with the printer to your computer’s USB port.

## Important!

- Connect the cable directly to one of your computer’s USB ports. Hub connection or other indirect connection can cause misoperation of the printer.
- Before using the printer’s USB port for the first time, you will need to remove the sticker that covers it.

5. Connect the other end of the USB cable to the printer’s USB port.

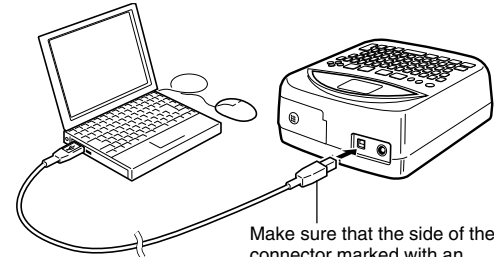

Make sure that the side of the connector marked with an arrow is facing downwards.

6. On the printer, press **⏻** to turn it on.
7. On your computer, create the label and execute the print command.
  - Before printing, press the printer’s **COMPUTER LINK** button so the message “**READY TO TRANSFER DATA**” is on the display.

Connecting the printer to your computer the first time after you install the application automatically starts up an installation wizard for installation of the USB driver. Follow the instructions that appear on your computer display to install the driver. Note that the wizard will appear only the first time you connect.

- If your computer is running Windows XP, the message shown below will appear part way through installation of the USB driver. When it does, click the **Continue Anyway** button and proceed with the installation.



- If your computer is running Windows 2000, the warning message "Digital Signature Not Found" may appear part way through USB driver installation. If it does, click the **Yes** button and proceed with the installation.
- The above messages will not appear if your computer is running Windows 98, 98SE, or Me.

8. After you are finished printing, press the printer's  button to turn it off.
9. Disconnect the USB cable from the printer's USB port.

### Important!

- Note that the USB cable provides data transfer capabilities only. Power is not delivered to the printer from the computer over the USB cable. Because of this, the printer needs to have batteries installed or the optionally available AC adaptor connected to power it.
- It is highly recommended that you use the optionally available AC adaptor to power the printer during data communication.
- While the optionally available AC adaptor is connected to the printer, its Auto Power Off feature (page 19) is disabled as long as the printer is connected to a computer.

# Reference

This section contains supplementary information about user maintenance, troubleshooting, and technical details.

## User Maintenance

A dirty print head can cause poor printing. Use the procedure below to keep the print head clean.

### Important!

- Use a cotton swab or some other soft object to clean the print head. We recommend use of a very fine cotton swab for cleaning.
- Note that you will need to turn on the printer in order to open the disc tray and front cover. Be sure to turn off the printer after opening the disc tray and front cover.
- If you are using the optionally available AC adaptor to power the printer, disconnect the AC adaptor from the printer after opening the front cover.

### To clean the print head

1. Press the printer's **ON** button to turn it on.
2. Press the printer's **▲** button.
  - This causes the disc tray to open part way.
3. Carefully pull out the disc tray the rest of the way.
  - If there is a disc on the tray, remove it.
4. Open the front cover.
  - If the printer has an ink ribbon cassette loaded in it, remove the cassette.
5. Press **OFF** to turn off the printer.

6. Carefully wipe the surface of the print head with a cotton swab moistened with alcohol.
  - Instead of alcohol, you can also use commercially available cassette deck head cleaning liquid.

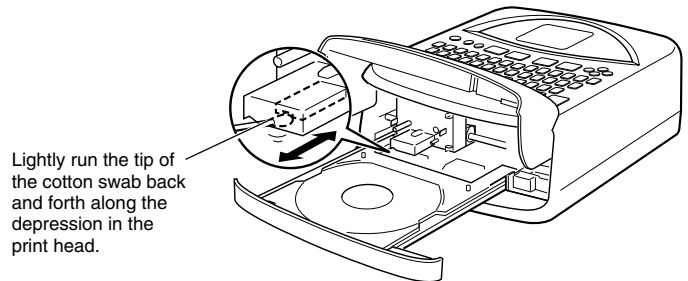



### Cleaning the Exterior of the Printer

Use a soft cloth dampened with plain water to wipe the exterior of the printer. Wring all excess moisture from the cloth before wiping. Never use benzene, alcohol, thinner, or other volatile agents to clean the exterior of the printer. Such agents can damage the plastic case.

## Troubleshooting Guide

Check the following whenever you experience problems with printing or other operations. If you cannot find the solution to your problem here, contact your original retailer or nearest CASIO service center.

Problem	Cause	Action
Nothing appears on the display.	Display contrast setting is not correct.	Adjust the display contrast (page 25).
	Optionally available AC adaptor is not connected correctly.	Correctly connect the optionally available AC adaptor (page 17).
	Battery power is low.	Replace the batteries or switch to optionally available AC adaptor power (pages 15 and 17).
	Batteries are not loaded correctly.	Correctly load the batteries (page 15).
Disc tray does not open when I press  .	The printer is not receiving any power.	Correctly connect the optionally available AC adaptor or load batteries (pages 15 and 17). • If the disc tray still does not open, use the procedure described on page 14 to open it manually.
	The printer is turned off.	Press  to turn on the printer.

Problem	Cause	Action
Nothing prints.	Your label contains only spaces.	Input the text you want to include in your label.
	The file you imported from your computer does not contain any data.	Import a file that contains the proper data.
Printing is unclear, characters are damaged, printing is too light, etc.	You are trying to print on one of the following types of labels. <ul style="list-style-type: none"> <li>• A label with a rough surface</li> <li>• A label marked with lines or other design elements</li> <li>• A label that is intended for ink jet printing</li> </ul>	See the separate "Printing Precautions" sheet for information on the type of discs that are recommended for this printer.
	The printer head is dirty.	Clean the printer head (page 59).
	Battery power is low.	Replace the batteries or switch to optionally available AC adaptor power (pages 15 and 17).
	Print density setting is not correct.	Adjust the print density (page 55).

<b>Problem</b>	<b>Cause</b>	<b>Action</b>
Color of printed text is different from that of the ink ribbon cassette.	The color of the disc you are printing on is combining with the color of the ink ribbon to produce a different color.	Print on light colored discs and use a dark color ink ribbon cassette.
Label contents are misaligned.	The disc is not positioned correctly on the tray.	Correctly position the disc using the positioning guide and guidelines (page 54).
Cannot print.	Battery power is low.	Replace the batteries or switch to optionally available AC adaptor power (pages 15 and 17).
	Ink ribbon cassette is used up.	Replace the ink ribbon cassette (page 21).
Cannot input text.	You pressed the <b>FUNCTION</b> key, and the printer is waiting for input of a function command.	Press <b>ESC</b> to abort the <b>FUNCTION</b> key operation.

## Error Messages

Message	Cause and Recommended Action
LOW BATTERY! CONTINUE TO PRINT? SET/ESC	Battery power is low. → Replace batteries as soon as possible.
LOW BATTERY!	Battery power is low. → Replace batteries as soon as possible.
DATA ERROR! INITIALIZE THE PRINTER!	You are attempting to use the printer without initializing its memory. → Initialize memory immediately.
PRINT ERROR! LOAD AN INK RIBBON CAS- SETTE!	You are attempting to print without an ink ribbon cassette loaded in the printer, or the cassette is not loaded correctly. → Correctly load the ink ribbon cassette.
PRINT ERROR! NO INK RIBBON!	The loaded ink ribbon cassette has reached its end. → Replace it with another ink ribbon cassette.
NOT ENOUGH INK RIBBON FOR NEXT PRINT	There is not enough ink ribbon to completely print the label you are trying to print. → Replace it with another ink ribbon cassette.
PRINT ERROR! LOAD A DISC INTO THE PRINTER!	You are attempting to print without a disc on the disc tray. → Correctly place a disc onto the tray.
NO DATA!	You are attempting to recall, edit, or delete a preset phrase memory that does not contain any data. → Select the correct preset phrase memory.  You are attempting to recall or delete stored label data when none exists. → Save label data before trying to recall it.

Message	Cause and Recommended Action
ENTIRE PHRASE COULD NOT BE RECALLED!	The number of characters in the preset phrase you recalled will cause the number of allowable characters to be exceeded. In this case, the phrase will be recalled only up to the allowable number of characters. → You can use the recalled characters, or reduce the number of characters in the label in order to allow recall of the entire preset phrase.
NO INPUT TEXT!	The label you are attempting to print or preview does not contain any input text. → Select a different label or input text.
SAME NAME ALREADY USED!	The name you are trying to use to save a label is already used for an existing label in memory. → Use a different name.
LINK ERROR! CHECK ALL CONNECTIONS!	Data could not be received from the connected computer. → Check all connections and make sure you are performing the required operations correctly.
MEMORY FULL!	There is not enough memory to store the data you are trying to save. → Delete some of the data from memory to make room from the new data.



# Illustrations

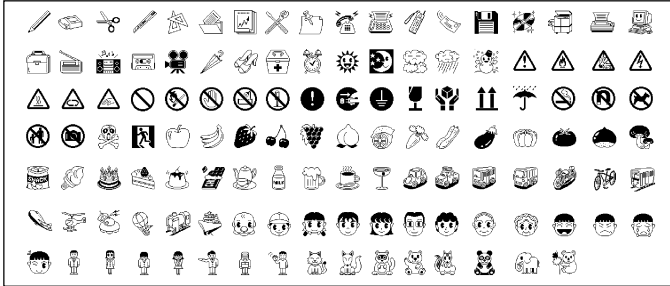

# Symbols, Dingbats, and Special Characters

● SYMBOL

, . : ; . ? ! ' ' " " „ « » ¿ ¡ ( ) [ ] { } < > 《 》

/ \ \$ € £ Fr ¥ # & \* @ \$ % ‰

+ - × = ≠ ÷ ± < > ≤ ≥ ° ~ † ‡

→ ← ↑ ↓ ↘ ↙ ↗ ↖ → ← ↑ ↓ ™ ® © ≡

⊙ ⊥ ∴ ./. oz lb. in. ft. °F °C ° f ℓ ° ° €

● DINGBAT

☆ ★ ○ ● ◎ ◇ ◆ ◻ ◼ ▲ ▴

▽ ▼ ♠ ♡ ♥ ♣ ♤ ◆ ◇

● NUMBER

① ② ③ ④ ⑤ ⑥ ⑦ ⑧ ⑨ ⑩ ⑪ ⑫ ⑬ ⑭ ⑮ ⑯ ⑰ ⑱

⑲ ⑳ I II III IV V VI VII VIII IX X i ii iii iv v vi

vii viii ix x ½ ¼ ¾ 00 01 02 03 04 05 06 07 08 09 10

11 12 13 14 15 16 17 18 19 20 21 22 23 24 25 26 27 28

29 30 31 32 33 34 35 36 37 38 39 40 41 42 43 44 45 46

47 48 49 50 51 52 53 54 55 56 57 58 59 60 61 62 63 64

65 66 67 68 69 70 71 72 73 74 75 76 77 78 79 80 81 82

83 84 85 86 87 88 89 90 91 92 93 94 95 96 97 98 99

90 91 92 93 94 95 96 97 98 99 00 01 02 03 04 05 06 07

08 09 10 11 12 13 14 15 16 17 18 19

● GREEK, RUSSIAN

Α Β Γ Δ Ε Ζ Η Θ Ι Κ Λ Μ Ν Ξ

Ο Π Ρ Σ Τ Υ Φ Χ Ψ Ω α β γ δ

ε ζ η θ ι κ λ μ ν ξ ο π ρ σ

τ υ φ χ ψ ω Α Β Γ Δ Ε Ε Ж

З И Й К Л М Н О П Р С Т У Ф









Х Ц Ч Ш Щ Ъ Ы Ь Э Ю Я а б в

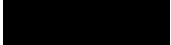





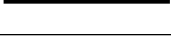





г д е ё ж з и й к л м н о п

р с т у ф х ц ч ш щ ъ ы ь э

Ю Я

## Label Formats

Type	Number	Format	Input Item	Vertical Size (mm/inch)	Maximum Number
FOR-MAT	1		TITLE	12/1/2"	12
	2		TITLE	9/3/8"	16
	3		TITLE1	6/1/4"	24
			TITLE2	6/1/4"	24
	4		TITLE	9/3/8"	16
			COMMENT	3/1/8"	49
	5		COMMENT	3/1/8"	49
			TITLE	9/3/8"	16
	6		TITLE	6/1/4"	24
			COMMENT	3/1/8"	49
7		COMMENT	3/1/8"	49	
		TITLE	6/1/4"	24	
8		TITLE1	3/1/8"	49	
		TITLE2	3/1/8"	49	
		TITLE3	3/1/8"	49	
9		TITLE	6/1/4"	24	
		COMMENT1	3/1/8"	49	
		COMMENT2	3/1/8"	49	
10		COMMENT1	3/1/8"	49	
		COMMENT2	3/1/8"	49	
		TITLE	6/1/4"	24	

Type	Number	Format	Input Item	Vertical Size (mm/inch)	Maximum Number
FOR-MAT	11		TITLE	6/1/4"	24
			ITEM1~4	3/1/8"	24 (x4)
	12		TITLE1~4	3/1/8"	49 (x4)
	13		ITEM1~8	3/1/8"	24 (x8)
	14		TITLE	6/1/4"	24
			COMMENT	3/1/8"	49
	15		ITEM1~4	2/1/16"	18 (x4)
			TITLE	6/1/4"	24
	16		ITEM1~4	2/1/16"	37 (x4)
			TITLE	6/1/4"	24
17		ITEM1~8	2/1/16"	18 (x8)	
		TITLE	6/1/4"	24	
18		ITEM1~8	2/1/16"	37 (x8)	
		ITEM1~16	2/1/16"	18 (x16)	
LOGO	1		LOGO	—	—
	2		LOGO	—	—
			TITLE	6/1/4"	12
	3		LOGO	—	—
TITLE1~2			3/1/8"	24 (x2)	
4		LOGO	—	—	
		TITLE1~3	3/1/8"	24 (x3)	

Type	Number	Format	Input Item	Vertical Size (mm/inch)	Maximum Number
AUTO	1	[REDACTED]	TITLE	15~3 <sup>5</sup> / <sub>16</sub> "~ <sup>1</sup> / <sub>8</sub> "	49
	2	[REDACTED]	TITLE1	6~3 <sup>1</sup> / <sub>4</sub> "~ <sup>1</sup> / <sub>8</sub> "	49
		[REDACTED]	TITLE2	6~3 <sup>1</sup> / <sub>4</sub> "~ <sup>1</sup> / <sub>8</sub> "	49

---

## Specifications

---

### Model: CW-75

#### Input

Keyboard Layout: Typewriter (QWERTY)

#### Character Types

Alpha: 52 (A to Z, a to z); 99 (Á, ß, Ç, etc.)

Numbers: 10

Greek: 48

Russian: 66

Symbols: 251

Illustrations: 124

User: Memory for storage of 4 characters

#### Display

Type: Liquid crystal display (1 line × 12 columns)

Character Matrix: 96 × 64 dots, plus symbol

#### Printing

Resolution: 200 dpi

Approximate Speed: 9.0 mm ( $\frac{3}{8}$ "/second (black ink ribbon)

5.1 mm ( $\frac{3}{16}$ "/second (silver, red, blue, green ink ribbon)

Actual speed depends on various factors.

Print System: Thermal transfer

Print Width: Approximately 16 mm ( $\frac{5}{8}$ "

Print Length: Approximately 74 mm ( $2\frac{15}{16}$ "

Fonts: New Sans-serif, New Sans-serif Italic, New Sans-serif Rounded, New Roman, New Roman Italic

Character Styles: Normal, bold

Number of Lines: 8 maximum

#### Memory

Text: Up to 4,000 characters

Pre-set Phrases: Up to 49 characters (9 phrases)

#### General

Power Requirements: Eight AA-size alkaline batteries; AD-A12280L AC adaptor (optionally available)

Memory Back-up: Built-in battery

Memory Back-up Battery Life: As noted on the sticker on the back of the printer (at 20°C (68°F)). Replacement requires charged maintenance by CASIO service center.

Power consumption: 18 W

Auto Power Off: Approximately six minutes after last key operation

- Auto Power Off disabled under AC adaptor power and when printer is connected to a computer.

Dimensions: 76 (H) × 184 (W) × 185 (D) mm

(3"H × 7¼"W × 7¼"D)

Approximate Weight: 900 g (2lbs) excluding batteries

Operating Temperature: 10°C to 35°C (50°F to 95°F)



CASIO ELECTRONICS CO., LTD.  
Unit 6, 1000 North Circular Road  
London NW2 7JD, U.K.

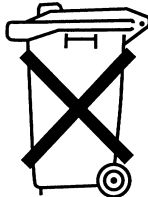

**Batterij niet weggoien,  
maar inleveren als  
KCA**

**CASIO®**

**CASIO COMPUTER CO., LTD.**

6-2, Hon-machi 1-chome  
Shibuya-ku, Tokyo 151-8543, Japan

## Free Manuals Download Website

<http://myh66.com>

<http://usermanuals.us>

<http://www.somanuals.com>

<http://www.4manuals.cc>

<http://www.manual-lib.com>

<http://www.404manual.com>

<http://www.luxmanual.com>

<http://aubethermostatmanual.com>

Golf course search by state

<http://golfingnear.com>

Email search by domain

<http://emailbydomain.com>

Auto manuals search

<http://auto.somanuals.com>

TV manuals search

<http://tv.somanuals.com>