

EW-B100C

User's Guide

Using a Dictionary

Using the Oxford Learner's
Wordfinder Dictionary

Using the Practical
English Usage

Multiple Dictionary Search

Useful Dictionary Functions

Using the Calculator

Important!

Be sure to keep all user documentation handy for future reference.



Manufacturer:
CASIO COMPUTER CO., LTD.
6-2, Hon-machi 1-chome, Shibuya-ku, Tokyo 151-8543, Japan
Responsible within the European Union:
CASIO EUROPE GmbH
Casio-Platz 1, 22848 Norderstedt, Germany



(This mark applies in EU countries only.)

- This product includes FontAvenue® font(s) licenced by NEC Corporation.
FontAvenue is a registered trademark of NEC Corporation.
- Other company and product names used in this manual and in the contents of this product may be trademarks or registered trademarks of others.

Unpacking

As you unpack your electronic dictionary, check to make sure that the following item is included with it.

- One AA-size alkaline battery
- Other accessories also may be included.

Battery

- Use only a battery included in the recommended battery list (page 77). Do not use a battery that is not included in the list. Battery characteristics and a battery that does not match the specifications of the electronic dictionary may result in abnormal operation or failure to achieve the specified operation between battery charges.
- Your electronic dictionary does not come with a rechargeable battery or a battery charger. If you want to use a rechargeable battery and a battery charger, it is up to you to purchase them from a retailer, wholesaler, or other source.
- The charge of the original battery that comes with this electronic dictionary is consumed somewhat as the product spends time in transit, storage, etc. Because of this, the original battery may not provide the full amount of operation noted in the specifications (page 79).

Loading the Battery for the First Time

Before using your electronic dictionary for the first time, be sure to perform the following steps to load the LR6 or AA-size alkaline battery that comes with it.

- 1** While pressing at the point on the battery cover indicated in the illustration, slide the cover in the direction indicated by the arrow and remove it.

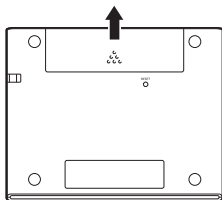

- 2** Load the battery, and then replace the battery cover.
 - While pressing the (-) end of the battery against the spring, lower the (+) end into the battery compartment making sure the ribbon is passing under the battery.

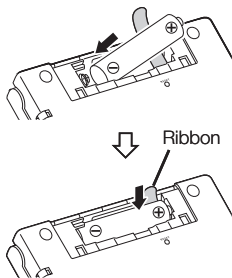

Correct Installation

- Spring is not protruding from the side.
- Ribbon is extended and is not folded under the battery.
- Battery poles (+ and - ends) are facing correctly.

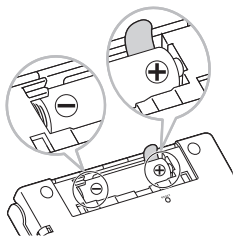

3 Use a ballpoint pen or some similar pointed object to press the RESET button on the back of your electronic dictionary.

- When pressing the RESET button, do not use a toothpick, lead pencil, or any other object whose tip can break off easily. Doing so can damage your electronic dictionary.

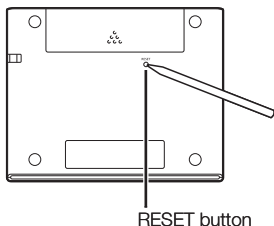

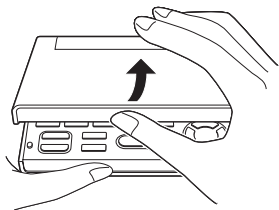

4 Open the cover of your electronic dictionary as shown in the illustration.

- This will cause the Battery Setting screen to appear.



5 Check to make sure that “● Alkaline” is selected as the battery type.

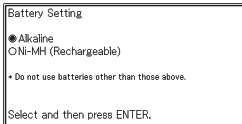

- If you are using a commercially available rechargeable battery in place of the original alkaline battery, use  and  to move the cursor (●) to “Ni-MH (Rechargeable)”.

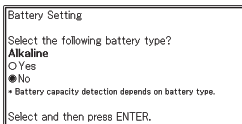

6 After the battery setting is the way you want, press .

- This will display a confirmation screen.



7 Use  to move the cursor (●) to “Yes” and then press .

- This will display the MENU screen.

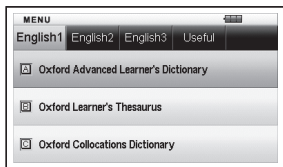

-
- You can also configure display brightness and other electronic dictionary settings (page 67).

Display Brightness and Battery Life

You can adjust the brightness of your electronic dictionary to one of five levels.

- The initial factory default setting is 3.

The brightness of the display will automatically dim to level 1 if you do not perform any operation for about 30 seconds (under initial default settings). Performing an operation will cause display brightness to return to its normal level.

- You can adjust screen brightness and the time it takes until screen illumination turns off. See “Illumination Duration Setting” and “Brightness Setting” (page 68).

An icon in the upper right corner of the MENU screen shows the current battery level.

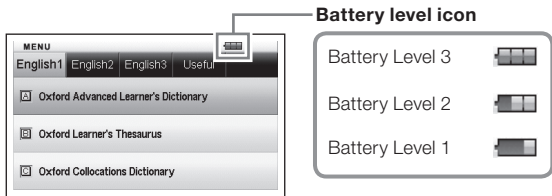

- Power will turn off and the screen will go blank when the battery level reaches 0.
- At battery level 1, the electronic dictionary may not operate normally, may suddenly turn off, or may exhibit other abnormal operation. Replace the battery as soon as possible when battery level 1 is indicated.

Battery Life

- Prolonged use of a bright display setting, and keeping the display illuminated for long periods, can shorten battery life.
- When battery power is low, your electronic dictionary may suddenly turn off or display the Battery Setting screen, without displaying the low battery message first.

Battery	Operating Conditions	Display Brightness	Approximate Battery Life*2
Alkaline battery	Repeated 5 minutes of input and search, 55 minutes of English-English dictionary screen display each hour	*1	50 hours
Rechargeable nickel-metal hydride battery	Repeated 5 minutes of input and search, 55 minutes of English-English dictionary screen display each hour	*1	40 hours*3

*1 Display brightness level 3, display dimmed after 30 seconds.

*2 New alkaline battery or new, fully charged rechargeable battery at an ambient temperature of 25°C.

Battery life values are approximate and are intended for reference only.

*3 Reference value based on a SANYO enloop rechargeable battery.

Contents

Before Getting Started	1
Unpacking	1
Battery	1
Loading the Battery for the First Time	2
Display Brightness and Battery Life.....	5
Introduction	11
Important Precautions	11
Names of Parts	14
Opening the Cover of the Electronic Dictionary	14
Screen Formats.....	15
Turning Power On and Off.....	16
Basic Operation	17
Basic Operation.....	17
Selecting a Mode	17
Selecting a Headword or Screen Item	19
Scrolling Between Screens.....	20
Back-stepping to a Previous Operation.....	20
Viewing a List Screen	20
Looking Up Another Term	20
Using the Dictionary Guide.....	21

Inputting Characters 23

Inputting Alphabetic Characters	23
Inputting Numbers	24
Correcting an Input Error.....	25

Using a Dictionary 26

Dictionaries and Functions.....	26
Looking Up a Headword.....	27
Looking Up Details About a Term (Phrases, Examples, Comments)	29
Looking Up Phrases	29
Looking Up Examples and Comments	30
Looking Up a Term when You are Unsure of Its Spelling ...	31
Spell Checking and Searching for an Original Form (Spell Check/Original Form Search)	33
Looking Up Phrases (Phrase Search)	34
Looking Up Examples (Example Search).....	35
Viewing Writing Tutor	36
Looking Up a Keyword (Keyword Search).....	37
Searching for Quasi-synonyms by Category	38
Searching for Common Word Pairs (Collocation Search)...	39

Using the Oxford Learner's Wordfinder Dictionary 40

Looking Up a Keyword (Keyword Search).....	40
Looking Up Related Terms (Related Term Search)	41
Looking Up Examples (Example Search).....	42
Performing a Topic Search	42

Using the Practical English Usage 43

- Looking Up a Keyword (Keyword Search)..... 43**
- Performing a Topic Search 44**
- Performing an Item Number Search 45**
- Performing a Search of “130 Common Mistakes” 45**

Multiple Dictionary Search 46

- Multiple Dictionary Search..... 46**
- Searching for the Same Term in Multiple Dictionaries (Headword Search)..... 47**
- Searching the Examples and Phrases of Multiple Dictionaries (Example and Phrase Search) 48**
 - Specifying the Dictionary Display Sequence for Lists of Hits..... 49**

Useful Dictionary Functions 50

- Performing Re-lookup of a Recently Searched for Term (History Search) 50**
 - Deleting History Memory Entries 51**
- Looking Up a Term Used within a Definition or Comment Screen (Jump Search) 53**
- Changing the Size of Screen Characters (Zoom)..... 55**
- Vocabulary List..... 56**
 - Saving a Headword to a Vocabulary List..... 56**
 - Unhighlighting Text..... 58**
 - Viewing, Selecting, and Deleting a Saved Headword..... 59**
 - Configuring Vocabulary List Display Settings..... 61**
 - Changing the Name of a Vocabulary List 62**

Using the Calculator	63
Using the Calculator	63
Basic Arithmetic Calculations	64
Constant Calculations	64
Memory Calculations	65
Correcting Key Operation Errors.....	65
Error ("E") Display.....	66
Configuring Electronic Dictionary Settings	67
Changing Settings	67
Copyrights	69
Copyright.....	69
Reference	72
Screen Messages.....	72
Troubleshooting	73
Resetting the Electronic Dictionary.....	74
Clearing Memory Data	75
Replacing the Battery.....	76
Specifications.....	79
.....	
■ General Guide	87

Important Precautions

Note the following important precautions whenever using your electronic dictionary.

- Never expose your electronic dictionary to fire. Doing so can cause the battery to explode, creating the risk of fire and personal injury.
- Avoid temperature extremes. Do not locate your electronic dictionary in direct sunlight, near a window, near a heater, etc.
- Under very low temperatures, display response may slow down or fail entirely. This condition is temporary and operation should resume under normal temperatures.
- Avoid areas subject to excessive moisture, dirt, and dust.
- Never subject your electronic dictionary to strong impact, bending, or twisting, do not carry it in the pocket of your trousers, and do not keep it together with hard objects inside of a bag or briefcase.
- Never place heavy objects on the electronic dictionary. Doing so can cause the object to fall off and create the chance of personal injury.
- Never try to take your electronic dictionary apart.
- Never use a pen, pencil, or other sharp object to press keys.
- To clean the exterior, wipe your electronic dictionary with a soft cloth dampened in a weak solution of a mild neutral detergent and water. Be sure to wring out any excess moisture from the cloth before wiping. Never use benzene, thinners, or any other volatile agent for cleaning. Doing so can remove the figures printed on the case or otherwise damage the finish of the case.
- Should the electronic dictionary ever start emitting smoke, strange odor, or heat, or start exhibiting other strange behavior, stop using it. Continued use creates the risk of fire and electric shock. Take the following steps immediately.
 - 1 Turn off power.
 - 2 Contact your original retailer or authorized CASIO service centre.
- Before assuming malfunction, be sure to check this manual for possible remedies, and check to make sure your problem is not due to low battery power or operational errors.

- Keep the electronic dictionary away from your chest (breast pocket, etc.) if you are wearing a pacemaker or other medical device. Magnetism from the electronic dictionary can affect a pacemaker or other device. If you feel any abnormality, immediately move away from the electronic dictionary and contact your physician.
- Never carry the electronic dictionary along with a magnetic card (credit card, cash card, prepaid card, etc.) The electronic dictionary uses components that generate a magnetic field, which can make a magnetic card unusable.

LCD

- Never apply strong pressure to the LCD screen or subject it to strong impact. Doing so can cause the glass to crack.
- Should the LCD glass ever break, avoid touching the liquid that may leak from the LCD. Contact with LCD liquid can cause skin irritation.
- Should you accidentally get liquid leaking from the LCD in your mouth, immediately rinse your mouth and contact your physician.
- Should liquid leaking from the LCD get into your eyes or onto your skin, immediately rinse for at least 15 minutes and then contact your physician.
- Due to limitations of the LCD used in this electronic dictionary, graphic images may not appear as they do on your computer display in terms of colour, etc.

Some display pixels may not light or may remain lit.

The liquid crystal panel used for the display is a product of very high accuracy technology. The effective pixel rate of the display is 99.99%, which means that no more than 0.01% of the pixels do not light or remain lit at all times. This is normal and does not indicate malfunction.

Location

- Never use your electronic dictionary in a hospital, in an aircraft, or in any other location where operation of mobile telephones is controlled or restricted.
- Avoid using your electronic dictionary in areas where electrostatic charge is generated.

- CASIO COMPUTER CO., LTD. assumes no responsibility for any loss or claims by third parties arising out of the use of this product.
- The contents of this manual are subject to change without notice.
- No part of this manual may be reproduced in any form without the express written consent of the manufacturer.
- The screen shots and product illustrations shown in this manual may be different from those of the actual product. For the sake of simplicity, some keys and icons are not shown in the examples of this manual.

Example:  → 

Names of Parts

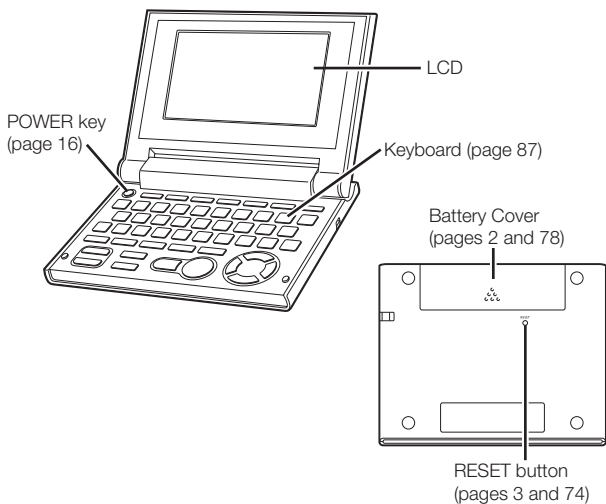

Opening the Cover of the Electronic Dictionary

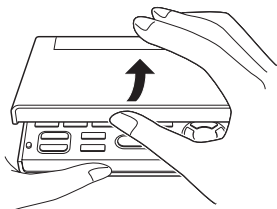

Open the cover of your electronic dictionary as shown in the illustration.

Screen Formats

■ Quick Search

With Quick Search, the list of hits continually updates as you input each character.

- You can turn off Quick Search, if you want. When Quick Search is off, the hit list does not appear until you press **ENTER** (page 67).

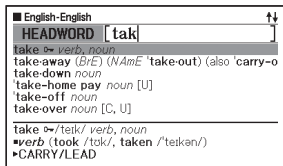

English-English

HEADWORD [take]

take ⇨ *verb, noun*

take-away (BrE) (NAmE 'take-out) (also 'carry-o

take-down *noun*

'take-home pay *noun* [U]

'take-off *noun*

take-over *noun* [C, U]

take ⇨ /teɪk/ *verb, noun*

•*verb* (took /tʊk/, taken /'teɪkən/)

•CARRY/LEAD

■ Preview Screen

On the list of hits produced by a search, you can display a preview screen that shows part of the definition of the highlighted headword.

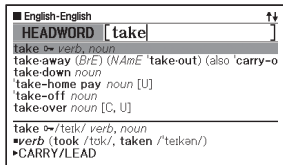

English-English

HEADWORD [take]

take ⇨ *verb, noun*

take-away (BrE) (NAmE 'take-out) (also 'carry-o

take-down *noun*

'take-home pay *noun* [U]

'take-off *noun*

take-over *noun* [C, U]

take ⇨ /teɪk/ *verb, noun*

•*verb* (took /tʊk/, taken /'teɪkən/)

•CARRY/LEAD

■ Example/Comment Preview Screen

When you look up examples or comments by pressing the **EX-COM** key, part of the highlighted example or comment will be shown in the lower pane on the display.

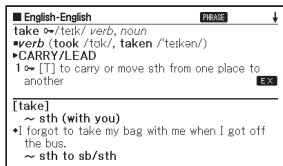

English-English

take ⇨ /teɪk/ *verb, noun*

•*verb* (took /tʊk/, taken /'teɪkən/)

•CARRY/LEAD

1 ⇨ [T] to carry or move sth from one place to another **EX**

[take]

~ sth (with you)

•I forgot to take my bag with me when I got off the bus.

~ sth to sb/sth

Turning Power On and Off

Power turns on automatically whenever you open the electronic dictionary's cover, and shuts off automatically when you close it.

- You also can turn power on and off by pressing the **POWER** key.
- Power also turns on when you press a Mode key. Turning on power displays the keyword input screen (initial screen) of the selected dictionary/mode. Pressing the **MENU/CALC** displays the MENU screen.

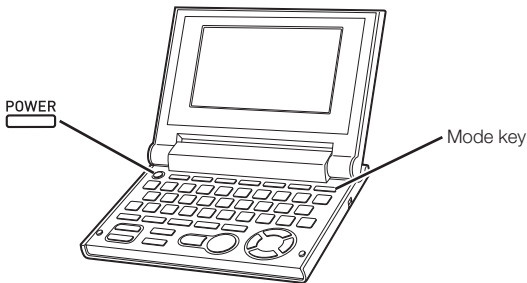

- You can turn off power regardless of what screen is currently on the display.
- Never turn off power while the electronic dictionary is changing from one screen to another.

-
- An Auto Power Off function guards against wasting battery power by turning off the electronic dictionary if you do not perform any operation for a preset amount of time. See page 67 for information about specifying the Auto Power Off time.
 - A Resume feature automatically saves screen information and data whenever power is turned off. Pressing the **POWER** key to turn power back on again restores the screen that was on the display when power was last turned off.

Basic Operation

Selecting a Mode

You can select a mode either by performing the applicable mode key operation or by using the MENU screen.

■ To select a mode using a mode key

Each press of a mode key displays the initial screen of the dictionary marked above it. If a key is marked with two dictionary names, each press of the key toggles between them.



- To display the initial screen of the second dictionary marked above a mode key, press **[SHIFT]** and then the mode key.

■ To select a mode using the MENU screen

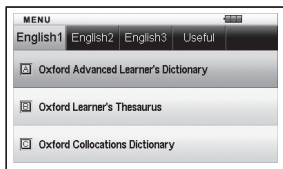

You can use this procedure to select any mode.

- 1 Press **MENU/CALC**.
 - This displays the MENU screen.
 - If the Calculator mode screen appears, press **MENU/CALC** again.

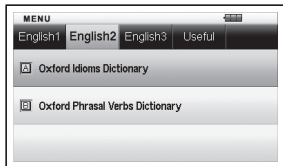

- 2 Use the **[◀]** and **[▶]** cursor keys to move the highlighting to the tab of the category for the dictionary/mode you want to select.



3 Use the  and  cursor keys to move the highlighting to the mode you want to select.

4 Press .

- This displays the initial screen of the dictionary/mode you selected.

The dictionaries/modes are divided into the categories listed below.

• **English1**

Oxford Advanced Learner's Dictionary (English-English dictionary)
Oxford Learner's Thesaurus
Oxford Collocations Dictionary

• **English2**

Oxford Idioms Dictionary
Oxford Phrasal Verbs Dictionary

• **English3**

Oxford Learner's Wordfinder Dictionary (English usage dictionary)
Practical English Usage
Oxford Guide to British and American Culture

• **Useful**

Multi-Dictionary Search
Calculator
Vocabulary List

Selecting a Headword or Screen Item

■ To select a headword or screen item by highlighting it or moving the cursor (●) to it

1 Use the arrow keys to move the highlighting to a headword, or to select the screen item you want.

- On some screens, you need to move a cursor (●) instead of highlighting to the item you want to select.

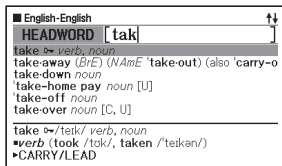

2 Press **ENTER**.

- All of the examples in this manual use this method for headword and screen item selection.



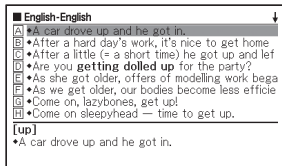

■ To select a headword or screen item by pressing a character key

Press the character key for the letter to the left of the headword or screen item you want to select.



Scrolling Between Screens

An up arrow (↑) or down arrow (↓) in the upper right corner of the display indicates that more screen content is available above or below.

- Press  or  to scroll from one screen to the next (page scroll).
- Press  or  to scroll line-by-line.

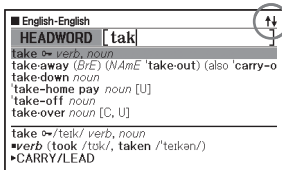

Back-stepping to a Previous Operation

If you make a mistake while operating your electronic dictionary, you can back-step to the previous operation by pressing **ESC/LIST**.

Viewing a List Screen

Pressing **ESC/LIST** while a definition screen is on the display will switch to the list view of terms, which includes the term whose definition you were viewing.



ESC/LIST

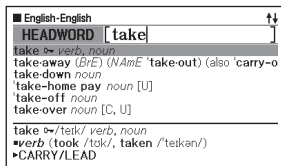

Looking Up Another Term

After viewing the definition of a term, you can look up another term by using the keyboard to input it.



- The first character you input returns you to the keyword input screen (initial dictionary screen), where you can input the term you want to find.

Using the Dictionary Guide

Dictionary guide information shows the dictionaries/modes that support specific types of searches and other functions.

It also provides explanations (conventions, how to use, etc.) for each dictionary/mode.

■ To view dictionaries/modes that support specific types of searches and other functions

- 1 Press  to display the MENU screen.
 - If the Calculator mode screen appears, press  again.

- 2 Press , and then press .

- 3 Use the  and  cursor keys to move the highlighting to the guide item you want to view, and then press .

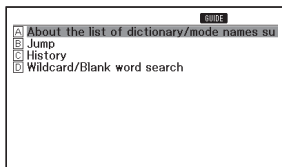

■ To view an explanation about a dictionary/mode

- 1 Select one of the dictionaries/modes.
 - This will display the initial screen of the selected dictionary/mode.

- 2 Press **[SHIFT]**, and then press **GUIDE**
JUMP.

- This function is not supported by certain modes, such as the calculator, etc.

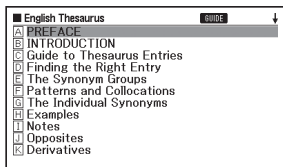

- 3 Use the **▲** and **▼** cursor keys to move the highlighting to the guide item you want to view, and then press **[ENTER]**.

-
- To close the guide information screen, press **[ESC/LIST]**.

Inputting Alphabetic Characters

Use the keyboard to input alphabetic characters.

Example: To input the word
“internet”

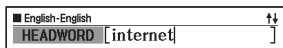

Press the keyboard keys to input the term.

- In this example, press: .

Alphabetic Character Input Rules

- Note that all alphabetic characters are input in lower case, regardless of their normal capitalization.
- Input hyphenated terms as single words, without a hyphen. To look up “heaven-sent”, for example, input “heavensent”.
- If an ampersand is part of the word or phrase you are inputting for an English Headword Search, replace the ampersand with the word “and”. To input “A & E”, for example, input “aande”.
- When inputting multiple words (Phrase Search, Example Search, etc.), separate them with a space (entered using)
- You can input up to 30 characters. With Phrase Search and Example Search, a blank space is counted as a character.

Inputting Numbers

You can input numbers when editing a Vocabulary List name and on the calculator screen. Entering the Calculator mode automatically changes the keyboard to a number input keyboard.

Example: To input 15

While the calculator screen is on the display, press the keyboard keys to input numbers.

- In this example: press .

Calculator screen

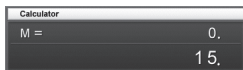

Keys Used for Number

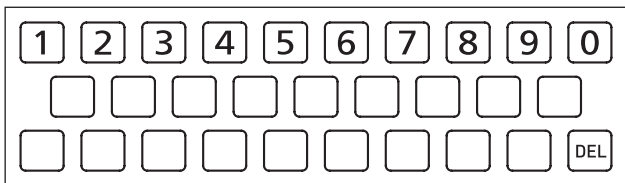

Correcting an Input Error

You can use any of the following methods to correct input errors and to modify input.

■ To delete a character

1 Use the ◀ and ▶ cursor keys to move the cursor to the left of character you want to delete.



Cursor

2 Press [DEL].

- This deletes the character to the right of the current cursor position.
- Pressing [DEL] while the cursor is located to the right of the last input character deletes the character to the left of the cursor.

■ To insert a character

1 Use the ◀ and ▶ cursor keys to move the cursor to the location where you want to insert the character.

2 Input the character.

- This inserts the character at the current cursor position.

Dictionaries and Functions

The following shows the dictionaries included in your electronic dictionary and where you need to go for more information when you want to perform a specific type of look-up.

- Basic operations are almost the same in all dictionaries. Any differences are noted in the explanations for each particular dictionary.

Dictionary/ Thesaurus	Type Of Look-up	Looking Up a Headword	Checking Spelling and Original Forms	Looking Up Phrases	Looking Up Examples
English- English*1	Definition of English term	Page 27	Page 33	Page 34	Page 35
English thesaurus*2	English synonyms	—	—	—	
English Collocations*3	Definition of English term	Page 27	—	Page 34	
English idioms	Definition of English term		Page 33		
English phrasal verbs	Definition of English term		—		
British and American Culture	Definition of English term	—	—	—	

*1 The English-English dictionary can be used to find out how to write text for reports, resumes, letters, e-mail and other types of documents (Writing Tutor). (page 36)

*2 The English thesaurus supports lookup by keyword and category. (pages 37 and 38)

*3 You can use the English Collocations Dictionary to look up common word combinations (collocations). (page 39)

Looking Up a Headword

- The following explanation and screen shots are based on the English-English dictionary.

- 1 Select the dictionary you want to use (page 17).



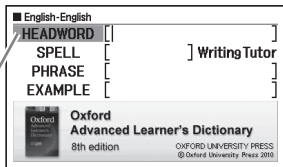

Check to make sure that "HEADWORD" is highlighted.



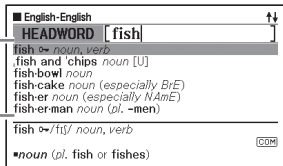

- 2 Input the term you want to look up.





This example looks up "fish". A list of hits continually updates as you input each letter of the term.









- 3** Use , , , and  to move the highlighting to the term (headword) you want to select, and then press .
- This displays the result of the look-up.



-
- You also can search for a term even if you are unsure of its correct spelling (page 31).
 - If you see a , , or  icon on the screen, it means that additional information is available. Refer to the sections noted below for more information.

Icon	Additional Information	Page
	Viewing phrase data for a headword	Page 29
	Viewing the comment for a word with the 	Page 30
	Viewing the example for a word with the 	

- Red text indicates that there is related information within the same dictionary. To view the related information, press , use , ,  and  to select the red text, and then press .

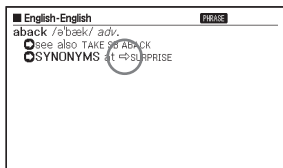

Looking Up Details About a Term (Phrases, Examples, Comments)

If you see the icon **PHRASE**, **EX** (example), or **COM** (comment or figure) on the screen, it means that there is additional information available.

- The following explanation and screen shots are based on the English-English dictionary.



Looking Up Phrases

When **PHRASE** is on the screen, you can lookup phrases that contain the term you looked up.

- 1 When **PHRASE** is on the screen, press **PHRASE**.
 - This displays a list of hits.

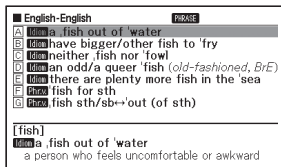

- 2 Use **▲**, **▼**, **▲**, and **▼** to move the highlighting to the phrase you want to select, and then press **ENTER**.
 - This displays the meaning of the phrases.

Looking Up Examples and Comments

Whenever you see **EX** or **COM** on the display, it means that there is example or comment information available for the term you are viewing.

- 1** When **EX** or **COM** is on the display, press **EX-COM**.

This causes **EX** or **COM** to become highlighted.

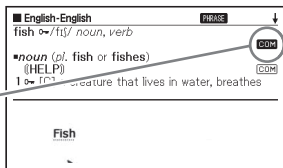

- 2** Use **▲**, **▼**, **◀**, and **▶** to move the highlighting to the icon you want to select, and then press **ENTER**.
- This displays the applicable example, comment, or figure.

Looking Up a Term when You are Unsure of Its Spelling

■ When you are unsure of specific characters

You can input the wildcard character (?) in place of characters when you know how many letters a term contains but are unsure of what specific characters are used.

Letters you are unsure about: ad_ _t → ad??t

■ When you are unsure about the number of characters

Use the blank word character (*) to find a term when you are unsure about how many characters there are in a certain part of it.

Part you are unsure about: ad_... _t → ad*t

- Use the wild card (?) or blank word character (*) to perform a Headword Search.
- The following explanation and screen shots are based on the English-English dictionary.
- You can use Dictionary Guide Information (page 21) to view the names of the dictionaries/modes that support this function.

1 Display the initial screen of the dictionary (page 17).

2 Input the keyword, substituting the wildcard character (?) or blank word character (*) for parts where you are unsure of the spelling.

• Inputting the wildcard character (?)

Press **[SHIFT]**, and then press **[k]**.

• Inputting the blank word character (*)

Press **[SHIFT]**, and then press **[L]**.

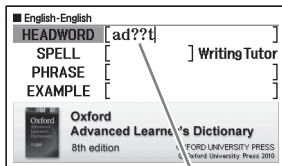

Input "?" here.

3 Press **ENTER**.

- This displays a list of hits that resemble the keyword you input.

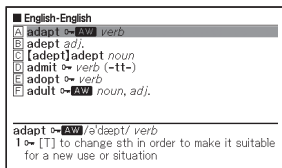

4 Use **▲**, **▼**, **⬆**, and **⬇** to move the highlighting to the term you want to select, and then press **ENTER**.

- This displays the definition of the term.

-
- You can input up to 29 wildcard characters (?) in a single keyword.
 - A search cannot be performed in the following cases.
 - When the keyword contains more than one blank word character (*).
 - When the keyword contains both a wildcard character (?) and a blank word character (*).
 - If you know only the first few characters of the term you want to find, just input the characters you know and search. This will produce a list of hits.
 - You also can input a wildcard character or blank word character by pressing **SHIFT** **M**. On the window that appears, use **◀** and **▶** to select the character you want, and then press **ENTER**. To close the window without inputting anything, press **ESC/LIST**.

Spell Checking and Searching for an Original Form (Spell Check/Original Form Search)

- The following explanation and screen shots are based on the English-English dictionary.
- In addition to finding terms whose spelling resembles the term you input, the electronic dictionary also will display candidates of what it thinks is the original (unmodified) form of the word you input. This does not necessarily mean that the candidates are the correct original (unmodified) form of the word. Original (unmodified) form candidates will not be displayed if you input a modified form of a term that is not a headword.

1 Select the dictionary you want to use (page 17).

2 Use ▲ and ▼ to highlight “SPELL”.

3 Input the term you want to spell check.

This example checks the spelling of “ailand” (for “island”).

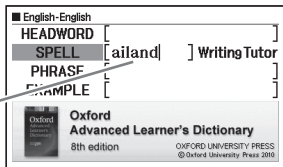

4 Press **ENTER**.

- This displays a list of possible spellings.

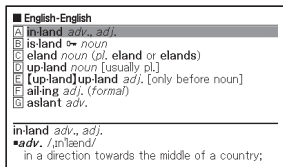

5 Use ▲, ▼, ⬆, and ⬇ to move the highlighting to the term you want to select, and then press **ENTER**.

- This displays the definition of the term.

Looking Up Phrases (Phrase Search)

- The following explanation and screen shots are based on the English-English dictionary.

1 Select the dictionary you want to use (page 17).

2 Use  and  to highlight “PHRASE”.

- In the English idioms dictionary, highlight “IDIOM”. In the English phrasal verbs dictionary, highlight “PHRASAL VERB”.



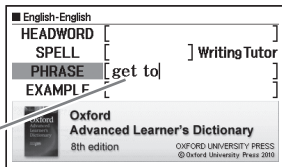

3 Input the words that should be included in the phrases.

When inputting multiple words, separate them with a space. To input “get” and “to” in this example, input “get to”.



4 Press .

- This displays a list of hits.

5 Use , , , and  to move the highlighting to the phrase you want to select, and then press .

- This displays the meaning of the phrase.
- The English idioms dictionary displays the meanings of idioms, and the English phrasal verbs dictionary shows the meanings of phrasal verbs.

Looking Up Examples (Example Search)

- The following explanation and screen shots are based on the English-English dictionary.

1 Select the dictionary you want to use (page 17).

2 Use ▲ and ▼ to highlight “EXAMPLE”.

3 Input the words that should be included in the examples.

When inputting multiple words, separate them with a space. To input “return” and “to” in this example, input “return to”.

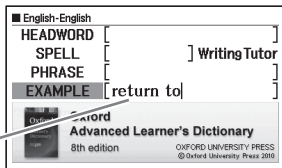

4 Press **ENTER**.

- This displays a list of hits.

5 Use ▲, ▼, ▲, and ▼ to move the highlighting to the example you want to select, and then press **ENTER**.

- This displays the meaning of the example.

Viewing Writing Tutor

- Writing Tutor can be used to find out how to write text for reports, resumes, letters, e-mail and other types of documents. Writing Tutor uses the English-English dictionary.

1 Press **QALD**.

2 Use **▲**, **▼**, **◀**, and **▶** to highlight “Writing Tutor”, and then press **ENTER**.

- This displays a list of topics.

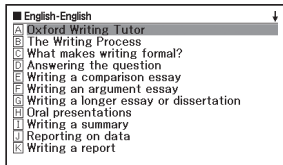

3 Use **▲**, **▼**, **▲**, and **▼** to move the highlighting to the topic you want to select, and then press **ENTER**.

- Repeat the above steps as many times as necessary to view the explanations you want to look up.

Looking Up a Keyword (Keyword Search)

- Keyword Search uses the English thesaurus.

1 Press **THESAURUS**.

Check to make sure that "KEYWORD" is highlighted.

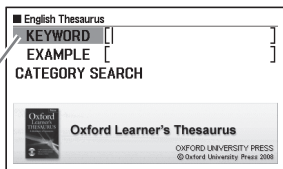

2 Input the English term you want to look up.

This example looks up "act". A list of hits continually updates as you input each letter of the term.

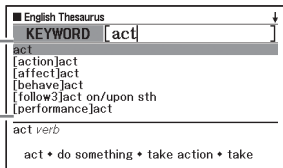

3 Use **▲**, **▼**, **▲**, and **▼** to move the highlighting to the English term (keyword) you want to select, and then press **ENTER**.

- This displays terms and expressions that are related to the keyword you specified.

Searching for Quasi-synonyms by Category

- Category Search uses the English thesaurus.

1 Press **THESAURUS**.

2 Use **▲** and **▼** to highlight “CATEGORY SEARCH”, and then press **ENTER**.

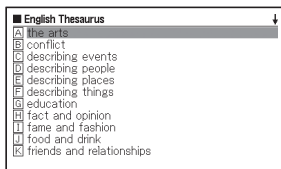

3 Use **▲** and **▼** to select a quasi-synonym category and then press **ENTER**.

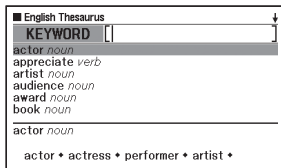

4 Input the English term you want to look up.

5 Use **▲**, **▼**, **⬆**, and **⬇** to move the highlighting to the English term (keyword) you want to select, and then press **ENTER**.

- This displays terms and expressions that are related to the keyword you specified.

Searching for Common Word Pairs (Collocation Search)

- Collocation Search is performed using the English Collocations Dictionary.

1 Press **COLLO/USAGE**.

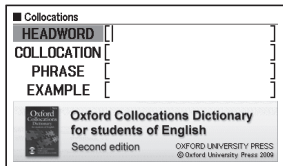

2 Use **▲** and **▼** to highlight "COLLOCATION".

3 Input the term you want to search.

When inputting multiple words, separate them with a space. To input "take" and "back" in this example, input "take back".

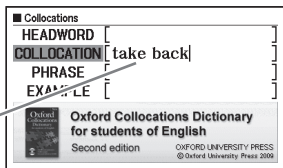

4 Press **ENTER**.

- This displays a list of hits.

5 Use **▲**, **▼**, **▲**, and **▼** to move the highlighting to the item you want to select, and then press **ENTER**.

- This displays a list of hits.

6 Use **▲**, **▼**, **▲**, and **▼** to move the highlighting to the collocation you want to select, and then press **ENTER**.

- This displays the collocations for the term.

Looking Up a Keyword (Keyword Search)

- 1 Press **W.FINDER/
CULTURE**.

Check to make sure that
"KEYWORD" is highlighted.

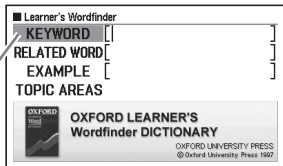

- 2 Input the English term you want to look up.

This example looks up "enjoy". A list of hits continually updates as you input each letter of the term.

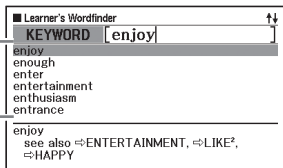

- 3 Use **▲**, **▼**, **▲**, and **▼** to move the highlighting to the English term (keyword) you want to select, and then press **ENTER**.

- This displays terms and expressions that are related to the keyword you specified.

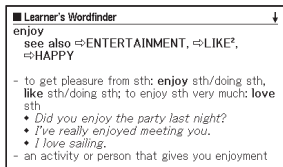

Looking Up Related Terms (Related Term Search)



- 1 Press .
- 2 Use and to highlight "RELATED WORD".
- 3 Input the English term you want to look up.
- 4 Press .

 - This displays a list of related terms.









- 5 Use , , , and to move the highlighting to the English related term you want to select, and then press .

 - This displays an explanation of the related term.

Looking Up Examples (Example Search)

- 1 Press .
- 2 Use  and  to highlight “EXAMPLE”.
- 3 Perform steps 3 through 5 under “Looking Up Examples (Example Search)” in “Using a Dictionary” (page 35) to search for examples.

Performing a Topic Search

- 1 Press .
- 2 Use  and  to highlight “TOPIC AREAS”, and then press .
 - This displays a list of topics.
- 3 Use , , , and  to move the highlighting to the topic you want to select, and then press .
 - This displays a list of terms related to the topic.

Looking Up a Keyword (Keyword Search)

- 1 Press **[SHIFT]**, and then press **COLLO/USAGE**.

Check to make sure that “KEYWORD” is highlighted.

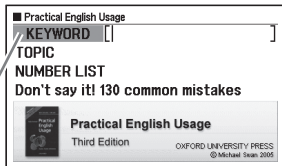

- 2 Input the English expression you want to look up.

This example looks up “too”. A list of hits continually updates as you input each letter of the term.

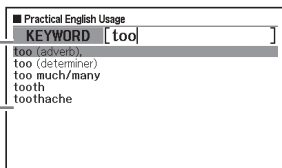

- 3 Use **[↑]**, **[↓]**, **[↕]**, and **[⇩]** to move the highlighting to the English expression (keyword) you want to select, and then press **[ENTER]**.
- Here we selected “too (adverb)”.

- 4 Use **[↑]**, **[↓]**, **[↕]**, and **[⇩]** to move the highlighting to the item you want to select, and then press **[ENTER]**.
- Repeat the above step as many times as required in order to display an explanation of the English expression.

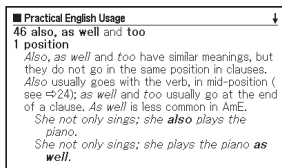

Performing a Topic Search

1 Press **[SHIFT]**, and then press **COLLO/
USAGE**.

2 Use **[▲]** and **[▼]** to highlight
“TOPIC”, and then press **[ENTER]**.

- This displays a list of topics.

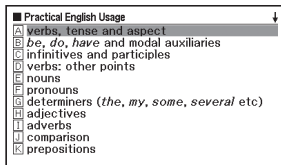

3 Use **[▲]**, **[▼]**, **[▲]**, and **[▼]** to move the highlighting to the topic list
you want to select, and then press **[ENTER]**.

4 Use **[▲]**, **[▼]**, **[▲]**, and **[▼]** to move the highlighting to the item you
want to select, and then press **[ENTER]**.

- Repeat the above step as many times as required in order to display an
explanation of the English expression.

Performing an Item Number Search

- 1 Press **[SHIFT]**, and then press **COLLO/
USAGE**.
- 2 Use **▲** and **▼** to highlight “NUMBER LIST”, and then press **[ENTER]**.
- 3 Use **▲**, **▼**, **▲**, and **▼** to move the highlighting to the item number list you want to select, and then press **[ENTER]**.
- 4 Use **▲**, **▼**, **▲**, and **▼** to move the highlighting to the item you want to select, and then press **[ENTER]**.
 - Repeat the above step as many times as required in order to display an explanation of the English expression.

Performing a Search of “130 Common Mistakes”

- 1 Press **[SHIFT]**, and then press **COLLO/
USAGE**.
- 2 Use **▲** and **▼** to highlight “Don’t say it! 130 common mistakes”, and then press **[ENTER]**.
- 3 Use **▲** and **▼** to move the highlighting to the mistake type list you want to select, and then press **[ENTER]**.
 - This displays example mistakes.

Multiple Dictionary Search

You can enter a term and search dictionaries/modes for the term itself, or examples or phrases that use the term.

- The maximum number of characters and other input restrictions are in accordance with same rules that apply for alphabetic character input (page 23).
- Perform the operation below to view the dictionaries/modes that are supported for Multiple Dictionary Search.
 - 1 Press **MULTI**.
 - 2 Press **SHIFT**, and then press **GUIDE JUMP**.
 - To close the screen that appears, press **ESC/LIST**.

Searching for the Same Term in Multiple Dictionaries (Headword Search)

1 Press **MULTI**.

Check to make sure that
"HEADWORD" is highlighted.

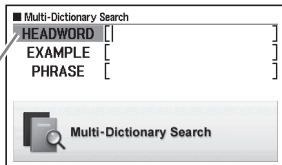

2 Input the term you want to search for.

- A list of hits continually updates as you input each letter of the term.

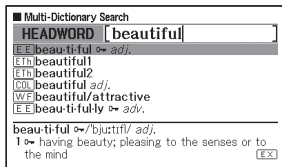

3 Use **▲**, **▼**, **⬆**, and **⬇** to move the highlighting to the term you want to select, and then press **ENTER**.

-
- Note that the input term for Headword Search cannot include the wildcard character (?), blank word character (*), or a space.

Searching the Examples and Phrases of Multiple Dictionaries (Example and Phrase Search)

- 1 Press **MULTI**.
- 2 Use **▲** and **▼** to highlight “EXAMPLE” for Example Search or “PHRASE” for Phrase Search.
- 3 Input the words that should be included in the examples or phrases, and then press **ENTER**.
 - Here we will use Example Search to search for the examples that contain “by the way”.
 - When inputting multiple words, separate them with a space.
 - This displays a list found by the search.
 - You can use the procedure on page 49 to specify the dictionary priority sequence for the list of hits.
- 4 Use **◀** and **▶** to select the dictionary you want.
- 5 Use **▲**, **▼**, **⬆**, and **⬇** to highlight the example or phrase you want, and then press **ENTER**.

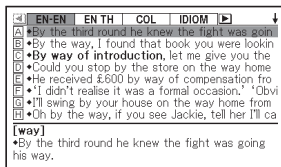

-
- Note that the input words for Example or Phrase Search cannot include the wildcard character (?) or blank word character (*).

Specifying the Dictionary Display Sequence for Lists of Hits

Use the procedure below to specify what order dictionaries should appear when displaying a list of hits for a Multiple Dictionary Search.

1 Press and then press .

2 Use and to move the cursor (●) to “Priority Settings” and then press .

3 Use and to move the cursor (●) to the item you want to change.

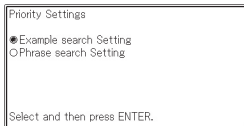

4 Press .

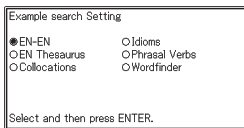

5 Use , , , and to move the cursor (●) to the dictionary that should be given priority, and then press .

Performing Re-lookup of a Recently Searched for Term (History Search)

Each time you look up a term, it is stored in history memory. You can view the current content of the history memory for a specific dictionary, or for all dictionaries.

When you want to perform re-lookup of a term that you recently searched for, simply display the history list and select the term (History Search).

- History memory can contain up to 1,000 terms at one time. When you perform a search operation that causes this maximum limit to be exceeded, the new entry causes the oldest entry in history memory to be deleted automatically.
- You can use Dictionary Guide Information (page 21) to view the names of dictionaries/modes that support this function.

■ To perform a History Search for a specific dictionary

- 1 While the dictionary whose history you want to search is on the display, press **HISTORY**.

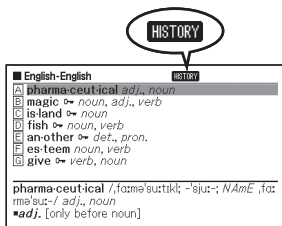

- 2 Use **▲**, **▼**, **▲**, and **▼** to move the highlighting to the term you want to re-lookup, and then press **ENTER**.

- This displays the definition of the term you selected.

■ To perform a History Search for all dictionaries

- 1 Press **[SHIFT]**, and then press **ALL HIST** and **HISTORY**.

The last term you searched for is highlighted on the list.

Indicates the dictionary type.

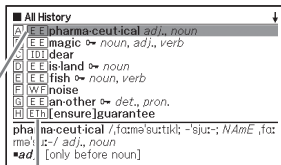

- 2 Use **[▲]**, **[▼]**, **[▲]**, and **[▼]** to move the highlighting to the term you want to re-look up, and then press **[ENTER]**.
- This displays the definition of the term you selected.

Deleting History Memory Entries

You can use any one of the following three procedures to delete history memory entries.

- Delete one entry only
- Delete all the entries for a specific dictionary
- Delete all history memory content

- 1 Press **[HISTORY]**.

- If you want to delete all history data, press **[SHIFT]** and then **ALL HIST** **[HISTORY]** in step 1.

- 2 Use **[▲]**, **[▼]**, **[▲]**, and **[▼]** to move the highlighting to the history entry you want to delete.

3 Press **[DEL]**.

One entry delete

Dictionary-specific delete

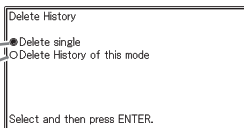

- Pressing **[SHIFT]** **[ALL HIST]** **[HISTORY]** in step 1 will display the history memory for all dictionaries. In this case, the screen that appears will show the message “Delete History of all modes”.

4 Use the **[▲]** and **[▼]** cursor keys to move the cursor (●) to the delete type you want to perform and then press **[ENTER]**.

- A confirmation message will appear if you select “Delete History of this mode” or “Delete History of all modes” in the above step. To delete, use **[▲]** and **[▼]** to select “Yes” and then press **[ENTER]**.

Looking Up a Term Used within a Definition or Comment Screen (Jump Search)

Use the following procedure when you want to use a term that appears within a definition or comment as the keyword for another search. You also can search for examples and phrases that use the term.

- You can use Dictionary Guide Information (page 21) to view the dictionaries/modes that can be searched using this function.

- 1** While a definition screen or comment screen is on the display, press **JUMP**.
- Jump Search is not supported while a table or figure is displayed.





This highlights the first term that can be selected for Jump Search.



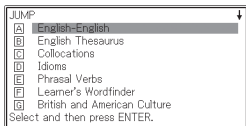





- 2** Use **▲**, **▼**, **◀**, and **▶** to move the highlighting to the term you want to look up, and then press **ENTER**.

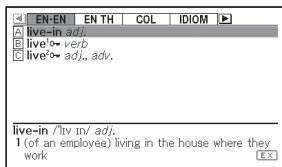



- Here we selected "live".





3 Use , , , and  to move the highlighting to the dictionary you want to use, and then press .



- This displays a list of terms that completely match or are similar to the one you selected.
- When the highlighted term is a plural form (like “dishes”), a comparative form (like “bigger”), or any other form that is produced by adding a suffix to the original term, the search will look for the original term (“dish”, “big”, etc.)
- To search for examples that use the highlighted term, use , , , and  to select “Example Search”, and then press . To search for phrases, select “Phrase Search” and then press . This will display a list of examples or phrases that use the selected term or a term that is close to the selected term.

4 Use , , , and  to move the highlighting to the term you want and then press .

-
- Even after pressing  to display a term list (in step 3), you can still use  and  to select the dictionary you want to use as the Jump Search destination.
 - You also can perform another Jump Search from a definition or comment screen that you arrived at from a previous Jump Search.
 - Performing the Jump Search operation on red text will display the term’s data screen. You do not need to specify a Jump Search destination in this case.

Changing the Size of Screen Characters (Zoom)

You can perform a zoom operation to change the character size of on-screen text while a list screen, definition screen, or comment screen is on the display.

■ To change the screen character size

While a list screen, definition screen or comment screen is on the display, press **ZOOM**.

- Each press of **ZOOM** cycles through the character sizes in the sequence 16 dots → 24 dots → 12 dots → 16 dots, etc.
- The following shows an example of how zoom affects the definition screen.

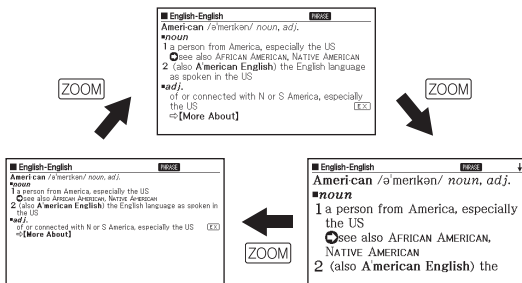

- The screen character size selected here is applied for the definition, comment, and list screens.
- Zoom is not supported while a table or figure is displayed.

Vocabulary List

Vocabulary List lets you save headwords you want to remember. A marker feature lets you highlight words with one of three colours. You can even hide highlighted words, if you like.

- You can create up to ten different Vocabulary Lists, and each list can contain up to 150 headwords.
- You can save terms, examples, or phrases as headwords.

Saving a Headword to a Vocabulary List

■ To register a headword without highlighting text

- 1 On the screen that contains the headword you want to save, press **SHIFT** and then **ENTER** SAVE/TICK.
 - This displays a Vocabulary List index.

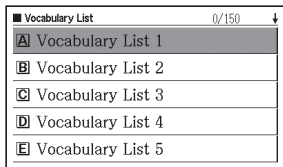

- 2 Use **▲** and **▼** to select the Vocabulary List you want to save and then press **ENTER**.

■ To highlight text and register a headword

- 1 On the screen that contains the headword you want to save, press **MARKER**.
 - A green cursor (■) will be displayed at the highlighting start point.
 - The **MARKER** will be displayed while you are using the marker feature.

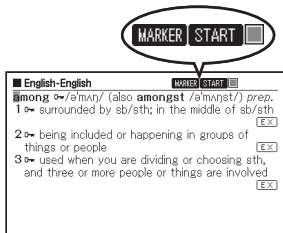

- 2 Use **▲**, **▼**, **◀**, and **▶** to move the cursor to the highlighting start point.

- To change the marker colour, press **MARKER**. Each press of **MARKER** cycles through the marker colours in the following sequence: Pink → Yellow → Blue → Pink, etc.

3 Press **ENTER**.

- This registers the start point and changes the cursor to the highlight colour.

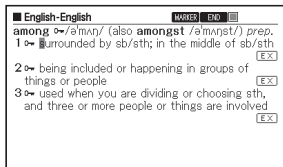

4 Use **▲**, **▼**, **◀**, and **▶** to move the cursor to the highlighting end point.

- Text is highlighted as the cursor passes over it.

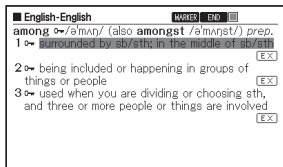

5 After highlighting all the text you want, press **ENTER**.

- This applies the highlighting and causes the cursor to change to green (indicating it is ready to select another start point). If you want to highlight more text, repeat steps 2 through 5.
- You can highlight up to 10 locations on a single headword screen.
- To remove highlighting, perform steps 2 through 5 of the procedure under “Unhighlighting Text” (page 58).

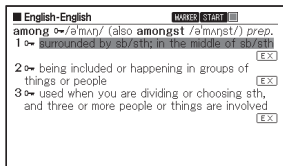

6 Press **SHIFT** and then **ENTER** SAVE/TICK.

- This displays a Vocabulary List index.

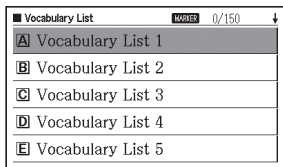

7 Use **▲** and **▼** to select the Vocabulary List you want to save and then press **ENTER**.

Unhighlighting Text

- 1 On the headword screen that contains the text you want to unhighlight, press **MARKER**.
 - For information about displaying the headword screen that contains the text you want to unhighlight, see the procedure under “Viewing, Selecting, and Deleting a Saved Headword” (page 59).
 - A green cursor (■) will appear on the display.

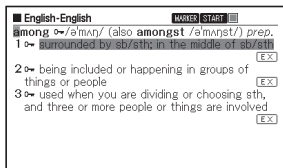

- 2 Press **DEL**.
- 3 Use the **▲** and **▼** to move the cursor (●) to the delete type you want to perform and then press **ENTER**.
 - If you selected “Delete all in this data”, the highlighting will be deleted. Next, advance to step 6.
 - If you selected “Specify the highlighting to delete”, go to step 4.

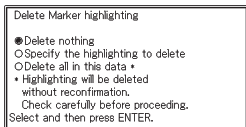

- 4 Use **▲**, **▼**, **◀**, and **▶** to move the green cursor to the highlighted text you want to unhighlight.
 - This will cause the highlighted text to change to green highlighting.

- 5 Press **ENTER**.
 - This will delete the highlighting and display the green cursor again. If you want to unhighlight more text, repeat steps 2 through 5.

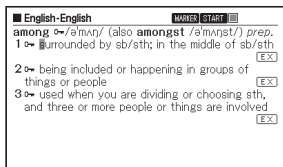

- 6 Press **SHIFT** and then **ENTER** (SAVE/TICK).
 - This displays a Vocabulary List index.

- 7 Use **▲** and **▼** to select the Vocabulary List you want to save and then press **ENTER**.

The following operations are supported from the saved headword index screen.

Function	Operation
Viewing a headword screen	<p>Select the headword you want to view and then press [ENTER].</p> <ul style="list-style-type: none"> • If you used the procedure under "Configuring Vocabulary List Display Settings" (page 61) to hide highlighted headwords, pressing [ENTER] will toggle between hide and show. • You also can change the highlighting colour and location, if you want. Perform the operation from the beginning of "Saving a Headword to a Vocabulary List" (page 56). Also note that if you selected a Vocabulary List that is different from the one you last selected when saving, the saved headword (including edited content) will be moved to the selected Vocabulary List.
Ticking or unticking a saved headword	<ol style="list-style-type: none"> 1. Select the headword you want to tick or untick. 2. Press [SHIFT] and then press [ENTER] <small>SAVE/TICK</small>.
Deleting a single headword	<ol style="list-style-type: none"> 1. Select the headword you want to delete and then press [DEL]. 2. On the delete method selection screen that appears, select "Delete the selected data (1)" and then press [ENTER].
Deleting only headwords with ticks from the displayed Vocabulary List	<ol style="list-style-type: none"> 1. Press [DEL]. 2. Select "Delete the entries with ticks" and then press [ENTER]. 3. Select "Yes" and then press [ENTER].
Deleting all headwords from the displayed Vocabulary List	<ol style="list-style-type: none"> 1. Press [DEL]. 2. Select "Delete the data of the displayed list" and then press [ENTER]. 3. Select "Yes" and then press [ENTER].
Deleting all headwords from all Vocabulary Lists	<ol style="list-style-type: none"> 1. Press [DEL]. 2. Select "Delete all data in Vocabulary List" and then press [ENTER]. 3. Select "Yes" and then press [ENTER].

Configuring Vocabulary List Display Settings

You can configure settings that control what appears on the screen when you view a Vocabulary List. You can use these settings to hide words that are highlighted with a specific colour, or to sort the list according to whether words are ticked or unticked. This helps to make your study and practice more efficient.

1 Press **VOCAB**.

2 Press **SHIFT**, and then press **SETUP**, and then press **ZOOM**.

- This will display the “Setup” screen.

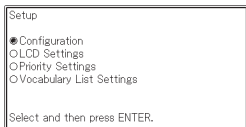

3 Use **▲** and **▼** to move the cursor (●) to “Vocabulary List Settings” and then press **ENTER**.

Displays only headwords that satisfy conditions.

Displays headwords sorted according to specified conditions.

Hides highlighted headwords according to specified conditions.

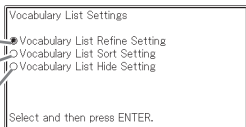

4 Use **▲** and **▼** to move the cursor (●) to the type of condition you want to configure and then press **ENTER**.

5 Use **▲** and **▼** to move the cursor (●) to the condition you want and then press **ENTER**.

Changing the Name of a Vocabulary List

1 Press **VOCAB**.

- You also can display the menu of Vocabulary Lists by selecting “Vocabulary List” on the MENU screen. (page 17)

2 Use **▲** and **▼** to select “Rename” and then press **ENTER**.

- This displays a Vocabulary List index.

3 Use **▲** and **▼** to select the Vocabulary List you want to rename and then press **ENTER**.

- This displays a screen showing the selected Vocabulary List’s current name.

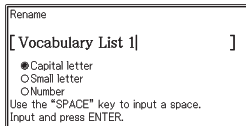

4 Delete the current name and then input a new name.

- You can input alphabetic characters (upper case, lower case), numbers, and spaces.
- To input upper case characters, lower case characters, and numbers, use **▲** and **▼** to move the cursor (●) to the type of character you want to input.
- To input a space, press **SPACE**.
- You can input up to 25 characters.

5 Press **ENTER**.

- You can change a Vocabulary List name back to its initial factory default (Vocabulary List 1 through 10), if you want. In step 3 of the above procedure, select the Vocabulary List whose name you want to initialize and then press **DEL**. This will display the “Rename” screen. Use **▲** and **▼** to select the initialization option you want and then press **ENTER**.

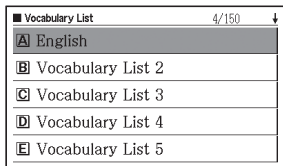

Using the Calculator

The calculator can perform addition, subtraction, multiplication and division, as well as constant and memory calculations.

1 Press **[SHIFT]**, and then press

**MENU/
CALC**

- This displays the calculator screen.

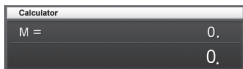

2 Perform the operations described on the next page.

- After the calculation is complete, exit the calculator screen by pressing **[ESC/LIST]**.

Calculator keyboard

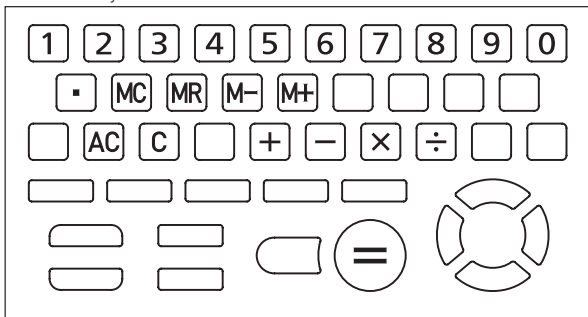

Basic Arithmetic Calculations

- Press $\boxed{\text{AC}}$ to clear the calculator before starting.
- In the following examples, press $\boxed{+}$, $\boxed{-}$, $\boxed{\times}$, or $\boxed{\div}$ to input the corresponding arithmetic operator.

Example	Key Operation	Display
$53 + 123 - 63 = 113$	$\boxed{\text{AC}}$	0.
	53 $\boxed{+}$	53.
	123 $\boxed{-}$	176.
	63 $\boxed{=}$	113.
$963 \times (23 - 56) = -31779$	23 $\boxed{-}$ 56 $\boxed{\times}$	-33.
	963 $\boxed{=}$	-31'779.

Constant Calculations

- After inputting the value you want to use as the constant, press the key of an arithmetic operator ($\boxed{+}$, $\boxed{-}$, $\boxed{\times}$, $\boxed{\div}$) twice.
 - This registers the constant and arithmetic operator, and displays the "K" indicator.
- Now input a value and press $\boxed{=}$ to perform the operation.

Example	Key Operation	Display
$12 + 23 = 35$	23 $\boxed{+}$ $\boxed{+}$ 12 $\boxed{=}$	K 35.+
$45 + 23 = 68$	45 $\boxed{=}$	K 68.+
$2.3 \times 12 = 27.6$	12 $\boxed{\times}$ $\boxed{\times}$ 2.3 $\boxed{=}$	K 27.6×
$4.5 \times 12 = 54$	4.5 $\boxed{=}$	K 54.x
$17 + 17 + 17 + 17 = 68$	17 $\boxed{+}$ $\boxed{+}$ $\boxed{=}$ $\boxed{=}$ $\boxed{=}$	K 68.+

Memory Calculations

You can use the following keys to perform memory calculations.

- **M+** : Adds a value to independent memory.
- **M-** : Subtracts a value from independent memory.
- **MR** : Displays the value currently in independent memory.
- **MC** : Clears independent memory content.

Example	Key Operation	Display
<ul style="list-style-type: none"> • To totalize calculation results $\begin{array}{r} 80 \times 9 = 720 \\ -) 50 \times 6 = 300 \\ \hline 20 \times 3 = 60 \\ \hline \text{(Total)} \quad 480 \end{array}$	$\begin{array}{l} \text{MC } 80 \times 9 \text{ M+} \\ 50 \times 6 \text{ M-} \\ 20 \times 3 \text{ M+} \\ \text{MR} \end{array}$	$\begin{array}{ll} \text{M} = 720. & 720. \\ \text{M} = 420. & 300. \\ \text{M} = 480. & 60. \\ \text{M} = 480. & 480. \end{array}$
<ul style="list-style-type: none"> • To perform calculations with a common value $\begin{array}{r} 193.2 \div 23 = 8.4 \\ 193.2 \div 28 = 6.9 \\ 123 - 193.2 = -70.2 \end{array}$	$\begin{array}{l} \text{MC } 193.2 \text{ M+ } \div 23 = \\ \text{MR } \div 28 = \\ 123 - \text{MR} = \end{array}$	$\begin{array}{ll} \text{M} = 193.2 & 8.4 \\ \text{M} = 193.2 & 6.9 \\ \text{M} = 193.2 & -70.2 \end{array}$

Correcting Key Operation Errors

■ To correct a value input error

- 1 Press **C**.
 - This clears the input value and displays "0."
- 2 Re-input the value.

■ To correct an arithmetic operator (\oplus , \ominus , \otimes , \oslash) input error

Simply input the correct operator.

To clear the calculator

Press $\overline{\text{AC}}$.

- This clears everything except for independent memory.

Error (“E”) Display

Any of the following causes an error to occur, which is indicated by “E” appearing on the display.

■ Causes

- **When the integer part of an intermediate or final result exceeds 12 digits**

When this type of error occurs, the value shown on the display is an approximation with the decimal point to the right of the trillion digit.

Example	Key Operation	Display
$1234567 \times 7418529 \approx$ 9158671091940	1234567 \otimes 7418529 $\overline{=}$	\swarrow Error indicator E 9.15867109194 \uparrow Trillion digit

- **When the integer part of the value stored in independent memory exceeds 12 digits**

This causes “0.” to appear on the display. Note, however that independent memory retains the value it contained before the operation that caused the overflow.

- **When division by zero (example: $6 \oslash 0 \overline{=}$) is attempted**

■ To clear an Error

After the error indicator (“E”) appears, press $\overline{\text{C}}$ if you want to continue with the previous calculation, or $\overline{\text{AC}}$ to start a new calculation.

Changing Settings

You can configure various settings to tailor operation of your electronic dictionary to your needs. The settings that can be configured are described below.

- Initial default settings are shown **underlined and in bold**.

■ Configuration

Item	Settings	Description
Key Tone	ON	Tone sounds when keys are pressed.
	<u>OFF</u>	No tone sounds.
Auto Power Off	3 Min/ <u>6 Min</u> /10 Min/ 15 Min/30 Min/ 45 Min/60 Min/90 Min	Trigger time until Auto Power Off
Quick Search	<u>ON</u>	Search with Quick Search (page 15)
	OFF	Hits do not appear as characters are entered. Press ENTER to display hit list.
Battery Setting	<u>Alkaline</u>	Using an AA-size alkaline battery.
	Ni-MH* (Rechargeable)	Using an AA-size rechargeable battery.

* Ni-MH: Nickel-metal hydride battery

■ LCD Settings

Item	Description
Brightness Setting	Display brightness adjustment (below)
Illumination Duration Setting	Illumination duration (30 Sec, 1 Min, 3 Min)

- “Priority Settings” (page 49), “Vocabulary List Settings” (page 61)

■ Changing Settings

To change settings, start from the initial screen of any one of the dictionaries. Starting from another type of screen may restrict the settings you can configure.

Example: To set display brightness

1 Display the initial screen of any one of the dictionaries.

2 Press **[SHIFT]** and then **[^{SETUP}ZOOM]**.
• This will display the “Setup” screen.

3 Use **[▲]** and **[▼]** to move the cursor (●) to “LCD Settings” and then press **[ENTER]**.

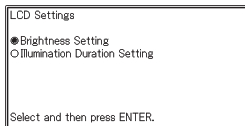

4 Use **[▲]** and **[▼]** to move the cursor (●) to “Brightness Setting” and then press **[ENTER]**.

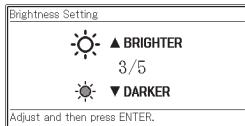

5 Use **[▲]** and **[▼]** to select the brightness setting you want and then press **[ENTER]**.

Copyright

■ Copyright Notice

The contents of this electronic dictionary were compiled with the cooperation and permission of the copyright holders of the dictionaries listed below.

You are not allowed to reproduce or copy the contents of this electronic dictionary either in part or in their entirety without permission.

Except for your own personal use, you are not allowed to use the contents of this electronic dictionary for any other purpose without the permission of CASIO and the original copyright holders.

■ Other Precautions

- The display data of this electronic dictionary was compiled under the supervision of the original dictionary publishers. However, displayed data may differ from the data as presented in the printed version of each source dictionary.

Certain information contained in this electronic dictionary may be outdated due to ongoing current events, etc.

- The dictionaries contained in your electronic dictionary are digital renditions based upon the print versions of dictionaries published by each applicable publishing company.
CASIO COMPUTER CO., LTD. assumes no liability for any losses suffered due to errors, omissions, or improper usage contained in the dictionary data.
- Except for some dictionaries, the following are not included: photographs, illustrations, tables, sub-articles, and appendices.

Oxford Advanced Learner's Dictionary, 8th edition

<Oxford University Press>

About 184,500 words, phrases and meanings

About 800 illustrations

© Oxford University Press 2010

Oxford Learner's Thesaurus

<Oxford University Press>

Over 17,000 synonyms and opposites from written and spoken English

© Oxford University Press 2008

Oxford Collocations Dictionary for students of English

<Oxford University Press>

Collocations for 9,000 nouns, verbs and adjectives, 250,000 word combinations

© Oxford University Press 2009

Oxford Idioms Dictionary for Learners of English

<Oxford University Press>

More than 10,000 idioms

50 illustrations

© Oxford University Press 2001 and 2006

Oxford Phrasal Verbs Dictionary for learners of English

<Oxford University Press>

Over 6,000 common British and American phrasal verbs

© Oxford University Press 2001 and 2007

Oxford Learner's Wordfinder Dictionary

<Oxford University Press>

About 630 keywords (about 31,000 related words)

470 illustrations

© Oxford University Press 1997

Practical English Usage

<Oxford University Press>

©Michael Swan 2005

Oxford Guide to British and American Culture

<Oxford University Press>

About 9000 entries

About 30 images

© Oxford University Press 2005

Screen Messages

The following explains why certain messages appear on the display, and the actions you need to take in response.

- Other messages remain on the display for a short while, and then disappear. Such messages are not included in this table.

Message	Cause and Remedy
Error code 01 Error code 02	The electronic dictionary was subjected to electrostatic charge or strong impact. Contact your nearest CASIO service centre.

Troubleshooting

When any of the following problems occurs, take the specified action.

	Symptom	Cause	Action	Page
Power Supply	Cannot turn on power.	Low battery power	Replace the battery.	77
	Power turns off when I do not perform any operation.	Auto Power Off	Turn power back on.	16
		Low battery power	Replace the battery.	77
	When using a rechargeable nickel-metal hydride battery, actual battery operation between charges is shorter than that noted in the specifications.	"Alkaline" is selected as the battery type.	Change the battery type setting to "Ni-MH (Rechargeable)".	67
Display	Auto Power Off does not work.	Auto Power Off trigger time is too long.	Check Auto Power Off settings.	67
	The display suddenly goes blank.	Low battery power	Replace the battery.	77
	Screen does not light up or flickers.			
The Battery Setting screen suddenly appears.				

Resetting the Electronic Dictionary

Strong electrostatic charge can cause abnormal electronic dictionary operation or lockup. If this happens, you need to reset your electronic dictionary.

Caution!

Note the following very important information about the reset operation.

- Be sure to turn off power before performing the reset operation. Resetting without turning off power can cause history data and settings to be deleted.
- When pressing the RESET button, do not use a toothpick, lead pencil, or any other object whose tip can break off easily. Doing so can damage your electronic dictionary.

1 Press the **POWER** key to turn off power.

2 Use a ballpoint pen or some similar pointed object to press the RESET button on the back of your electronic dictionary.

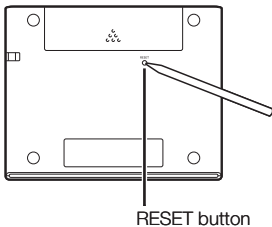

3 Open the cover of your electronic dictionary as shown in the illustration.

- This will cause the Battery Setting screen to appear.

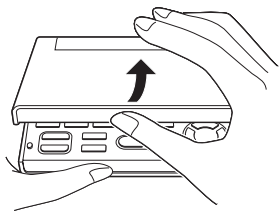

4 Follow the instructions that appear on the display to configure the battery setting.

- For details, see the steps starting from step 5 under “Loading the Battery for the First Time”. (page 4)

Clearing Memory Data

You can use the procedure below to delete all data from the Vocabulary List and HISTORY memory.

Note that a delete operation cannot be undone. Once deleted, data cannot be recovered.

1 Press **MENU/CALC**.

- This will display the MENU screen.

2 Press **SHIFT** and then **DEL**.

- This will display a confirmation screen.

Memory state	
All History	: 5
Vocabulary List	: 4
Delete the memory completely?	
<input type="radio"/> Yes(Delete History and Vocab. List)	
<input checked="" type="radio"/> No	
Select and then press ENTER.	

3 Use **▲** to move the cursor (●) to “Yes” and then press **ENTER**.

- This will delete the data and cause the numbers for all the stored data item values on the confirmation screen to revert to zero.

Memory state	
All History	: 0
Vocabulary List	: 0
The memory is empty.	
No data for History and Vocabulary List available.	
Press ENTER to clear this message.	

4 Press **ENTER**.

- This will return to the MENU screen.

Replacing the Battery

Replace the battery as soon as possible after the message “The battery is low.” appears on the display.

You should replace the battery at least once a year, even if this message does not appear.

A nickel-metal hydride battery (rechargeable battery) in particular can deteriorate when left in the electronic dictionary when you are not using it for long periods. Remove the rechargeable battery as soon as possible.

- Make sure you turn off power before replacing the battery. Changing the battery while power is on can cause history data, settings, and other information to be deleted.
- Always replace the battery with a new AA-size alkaline battery or a fully charged AA-size nickel-metal hydride battery (rechargeable battery). Using a battery other than those specified can greatly shorten battery life and cause abnormal operation.
- When changing to a rechargeable battery, be sure to change the battery type setting to “Ni-MH (Rechargeable)”.

Battery Precautions

Using a battery incorrectly can cause it to burst or leak, possibly damaging the interior of the unit. Note the following precautions:

- Be sure that the positive (+) and negative (-) ends of the battery are facing in the correct directions.
- Do not expose batteries to direct heat, let them become shorted, or try to take them apart.
- Never leave a dead battery in the battery compartment.
- Remove the battery if you do not plan to use your electronic dictionary for a long time.
- Never try to recharge the battery that comes with your electronic dictionary.



- Should a battery leak, clean out the battery compartment immediately, taking care to avoid letting battery fluid come into direct contact with your skin.
- Should battery fluid ever get into your eyes, take the following steps immediately. Failure to do so can result in loss of eyesight.
 1. Rinse your eyes with clean water, without rubbing them.
 2. Contact a physician immediately.

Battery

- Use only the specified battery charger for the battery you are using to charge it.
- There is no way to recharge a battery without removing it from the electronic dictionary.
- Before using a rechargeable battery or its special charger unit, be sure to read and follow the instructions and precautions that come with them.
- Recommended Battery
 - AA-size alkaline battery: LR6 (AM3)
 - AA-size nickel-metal hydride battery: SANYO eneloop

Keep batteries out of the reach of small children. If swallowed, consult a physician immediately.

Never dispose of used batteries with general household refuse. Be sure to take batteries to a appropriate collection site or specified waste disposal facility.

Replacing the Battery

- 1** Prepare a new AA-size alkaline battery or a fully charged AA-size rechargeable battery.
- 2** Press the  key to turn off power.

- 3** While pressing at the point on the battery cover as shown in the illustration, slide the cover in the direction indicated by the arrow and remove it.

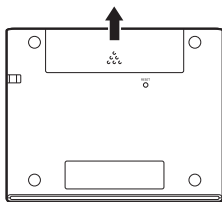

- 4** Remove the old battery and load a new one.
- Pull up on a ribbon to remove a battery.
 - Load the battery so the ribbon runs underneath it.

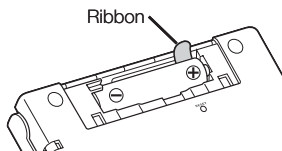

- 5** Replace the battery cover.

- 6** Use a ballpoint pen or some similar pointed object to press the RESET button on the back of your electronic dictionary.
- When pressing the RESET button, do not use a toothpick, lead pencil, or any other object whose tip can break off easily. Doing so can damage your electronic dictionary.

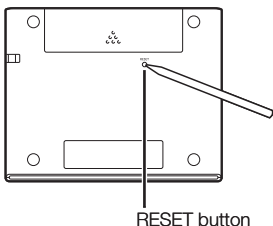

- 7** Open the cover of your electronic dictionary.
- This will cause the Battery Setting screen to appear.

- 8** Follow the instructions that appear on the display to configure the battery setting.
- For details, see the steps starting from step 5 under "Loading the Battery for the First Time". (page 4)

Specifications

- Content: See “Copyrights” (page 69) for information about dictionaries.
- Calculator: 12 digits; arithmetic calculations; arithmetic constant calculations; independent memory calculations; mixed calculations
 - Decimal point: Full floating
 - Constant display of memory content
- Display: 384 × 216-dot TFT colour LCD
- Power Consumption: 0.35 W
- Power Requirements: One AA-size alkaline battery (LR6) or one AA-size nickel-metal hydride battery (rechargeable battery)
- Approximate Battery Life
Based on a new alkaline battery or new, fully charged nickel-metal hydride battery (rechargeable battery), at an ambient operating temperature of 25°C.

Battery	Operating Conditions	Approximate Battery Life* ²
One AA-size alkaline battery (LR6)	Continuous display of English-English dictionary screen* ¹	100 hours
	Repeated 5 minutes of input and search, 55 minutes of English-English dictionary screen display each hour* ¹	50 hours
One AA-size rechargeable nickel-metal hydride battery	Continuous display of English-English dictionary screen* ¹	80 hours* ³
	Repeated 5 minutes of input and search, 55 minutes of English-English dictionary screen display each hour* ¹	40 hours* ³

*¹ Display brightness level 3, display dimmed after 30 seconds.

*² Battery life values are approximate and are intended for reference only. Battery life is affected by operating conditions, battery type, operating environment, types of operations performed (display illumination brightness setting, display illumination duration setting), etc.

*³ Reference value based on a SANYO enloop rechargeable battery.

- Auto Power Off: Selectable trigger time of approximately 3, 6, 10, 15, 30, 45, 60, or 90 minutes
- Resume Function: Current screen and data are saved when power is turned off.
- Operating Temperature: 0°C to 40°C
- Dimensions: 108.5 (W) x 87.0 (D) x 17.2 (H) mm (at thinnest point when cover is closed); H is 17.7 mm at thickest point.
- Approximate Weight: 175g (including battery)

MEMO

MEMO

MEMO



MEMO





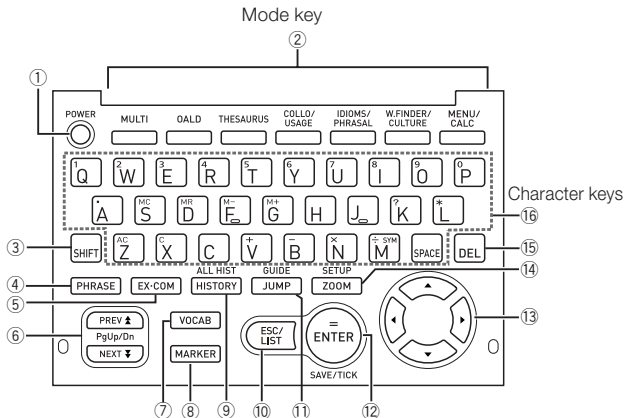









MEMO

MEMO

General Guide



Key	Role of the key
① POWER	Turns power on and off. (page 16)
② Example: COLLO/USAGE	Each press of a mode key displays the initial screen of the dictionary marked above it. If a key is marked with two dictionary names, each press of the key toggles between them. (page 17)
③ SHIFT	Press to input certain characters (? , *), to access guide information, etc. (pages 21 and 31) <ul style="list-style-type: none"> • Press SHIFT and release it, and then press the next key.
④ PHRASE	Press when the PHRASE icon is on a dictionary screen to look up phrases. (page 29)
⑤ EX-COM	Press when the EX or COM icon is on a dictionary screen to look up examples or comments. (page 30)
⑥ 	Use these keys to scroll the screen content up and down. (page 20) To jump to the definition of the term before the one you are viewing, press SHIFT and then  . To jump to the definition of the next term, press SHIFT and then  .
⑦ VOCAB	Press this key to use the Vocabulary List. (page 59)

	Key	Role of the key
⑧		Press this key to highlight text on a definition screen with a marker. (page 56)
⑨		Press this key to re-lookup a term that you recently searched for. (page 50) To search all dictionaries for a term you previously looked up, press  and then this key. (page 51)
⑩		Press this key to back-step to the previous operation. (page 20) Pressing this key while a definition screen is on the display switches to the list view of terms, which includes the term whose definition you were viewing. (page 20) Pressing this key while a dictionary's initial screen is on the display will return to the MENU screen. (page 17)
⑪		Press this key to look up a term on the currently displayed definition screen or comment screen. (page 53) To view guide information, press  and then this key. (page 21)
⑫		Press this key to register characters you input or selections you made on the display. (page 18) To add an entry to the Vocabulary List or to put a tick next to a Vocabulary List term, press  and then this key. (pages 57 and 60)
⑬		Use these keys to move the selection highlighting or to move the cursor up, down, left, or right. (page 19) If the definition is too large to fit on the screen, the screen will scroll line by line as required when you press this key.
⑭		Press this key while a list screen, definition screen or comment screen is on the display to change the text size. (page 55) To change the settings of your electronic dictionary, press  and then this key. (page 67)
⑮		Press this key to delete a character. (page 25)
⑯	 ~ 	Use these keys to input characters and values. (pages 23 and 24) • For details about the  key, see page 32.

CASIO®

CASIO COMPUTER CO., LTD.

6-2, Hon-machi 1-chome
Shibuya-ku, Tokyo 151-8543, Japan



RJA524902-001V01

MO1111-B Printed in China

Free Manuals Download Website

<http://myh66.com>

<http://usermanuals.us>

<http://www.somanuals.com>

<http://www.4manuals.cc>

<http://www.manual-lib.com>

<http://www.404manual.com>

<http://www.luxmanual.com>

<http://aubethermostatmanual.com>

Golf course search by state

<http://golfingnear.com>

Email search by domain

<http://emailbydomain.com>

Auto manuals search

<http://auto.somanuals.com>

TV manuals search

<http://tv.somanuals.com>