

DATA PROJECTOR

XJ-A Series

XJ-A142/XJ-A147*

XJ-A242/XJ-A247*

XJ-A252/XJ-A257*

XJ-M Series

XJ-M141/XJ-M146*

XJ-M151/XJ-M156*

XJ-M241/XJ-M246*

XJ-M251/XJ-M256*

*USB Models

User's Guide

- In this manual, "XJ-A Series" and "XJ-M Series" refer only to the specific models listed above.
- Be sure to read the "Safety Precautions" and "Operating Precautions" in the "Setup Guide" document that comes with the Data Projector, and make sure you use this product correctly.
- Keep this manual in a safe place for future reference.
- Visit the site below for the latest version of this manual.
<http://world.casio.com/manual/projector/>

- DLP is a registered trademark of Texas Instruments of the United States.
- Microsoft, Windows, and Windows Vista are registered trademarks or trademarks of Microsoft Corporation in the United States and other countries.
- HDMI, the HDMI Logo and High-Definition Multimedia Interface are trademarks or registered trademarks of HDMI Licensing, LLC.
- Mac OS is a trademark or registered trademark of Apple, Inc. in the United States and other countries.
- PJLink is a pending trademark or a registered trademark in Japan, the United States, and other countries and areas.
- Crestron is a registered trademark of Crestron Electronics, Inc. of the United States.
- AMX is a registered trademark of AMX LLC of the United States.
- XGA is a registered trademark of IBM Corporation of the United States.
- Other company and product names may be registered product names or trademarks of their respective owners.
- Portions of this product are based in part on the work of the Independent JPEG Group.

- The contents of this User's Guide are subject to change without notice.
- Copying of this manual, either in part or its entirety is forbidden. You are allowed to use this manual for your own personal use. Any other use is forbidden without the permission of CASIO COMPUTER CO., LTD.
- CASIO COMPUTER CO., LTD. shall not be held liable for any lost profits or claims from third parties arising out of the use of this product or this manual.
- CASIO COMPUTER CO., LTD. shall not be held liable for any loss or lost profits due to loss of data due to malfunction or maintenance of this product, or any other reason.
- The sample screens shown in this manual are for illustrative purposes only, and may not be exactly the same as the screens actually produced by the product.

Contents

| | |
|--|-----------|
| Projector Features and Main Functions | 7 |
| Features Common to All Models | 7 |
| USB Model Features..... | 7 |
| Other Model-specific Features | 8 |
| Getting Ready..... | 9 |
| Setting Up the Projector..... | 9 |
| Setup Precautions | 10 |
| Connecting Projector Cables | 11 |
| Remote Controller | 12 |
| <i>To load remote controller batteries</i> | <i>13</i> |
| <i>To replace remote controller batteries</i> | <i>13</i> |
| Projecting an Image..... | 14 |
| Selecting the Input Source | 14 |
| <i>To select the input source</i> | <i>15</i> |
| Resolution..... | 15 |
| 3D Input Mode (XJ-M Series Only)..... | 16 |
| <i>Entering the 3D Input Mode</i> | <i>16</i> |
| <i>Returning to the Normal Input Mode from the 3D Input Mode</i> | <i>17</i> |
| Horizontal Flipping in the 3D Input Mode | 17 |
| <i>To swap the left and right images</i> | <i>17</i> |
| Projecting with File Viewer (USB Model Only)..... | 18 |
| File Viewer Overview..... | 18 |
| Projecting Files Located in Projector Internal Memory..... | 18 |
| <i>To copy files from a computer to projector internal memory</i> | <i>19</i> |
| <i>Starting Projection of Files Located in Projector Internal Memory</i> | <i>21</i> |
| <i>To format projector internal memory.....</i> | <i>22</i> |
| Projecting Files from a Memory Device Connected by USB | 23 |
| <i>To connect a USB flash drive to the projector</i> | <i>23</i> |
| <i>To connect a memory card to the projector.....</i> | <i>24</i> |
| <i>To connect a digital camera to the projector.....</i> | <i>24</i> |
| <i>To start projection of files that are on a memory device connected via USB.....</i> | <i>25</i> |
| Projecting Files | 27 |
| <i>To project a presentation file.....</i> | <i>27</i> |
| <i>To project a PDF file.....</i> | <i>28</i> |
| <i>To project an image file</i> | <i>29</i> |

| | |
|---|----|
| <i>To project a movie file</i> | 29 |
| File Menu Operations..... | 31 |
| <i>To toggle the file menu between the list view and icon view</i> | 31 |
| <i>To scroll the file menu</i> | 31 |
| <i>To open a folder</i> | 31 |
| <i>To exit the current folder and move up to the next level</i> | 31 |
| <i>To return to the main screen from the file menu</i> | 31 |
| Configuring File Viewer Settings..... | 32 |
| <i>To configure File Viewer settings</i> | 32 |
| Autorun | 34 |
| <i>To auto project images files or a movie file from a USB flash drive</i> | 34 |
| <i>To auto project images files or a movie file from projector internal memory</i> | 35 |
| File Viewer Troubleshooting..... | 36 |
| File Viewer Error Messages | 37 |
| Using EZ-Converter FA to Convert PowerPoint Files to ECA or PtG Files..... | 38 |
| <i>To convert a PowerPoint file to an ECA file or PtG file</i> | 39 |
| <i>To specify the screen resolution of the ECA file or PtG file</i> | 41 |
| <i>To specify the maximum animation display time</i> | 41 |
| <i>To play back an ECA file or PtG file on your computer</i> | 41 |
| Projecting with the USB Display Function (USB Model Only)..... | 43 |
| USB Display Function Overview | 43 |
| Projecting Computer Screen Contents Over a USB Connection | 43 |
| <i>To project Windows computer screen contents over a USB connection for the first time</i> | 44 |
| <i>To project Mac OS computer screen contents over a USB connection for the first time</i> | 45 |
| <i>To project computer screen contents over a USB connection after the first time</i> | 47 |
| Projecting the Screen Image of a Graphing Calculator (USB Model Only)..... | 48 |
| <i>To project the screen image of a graphing calculator</i> | 48 |

Operating the Projector..... 49

| | |
|--|----|
| Output Image and Audio Operations | 49 |
| <i>To use manual keystone correction (KEYSTONE)</i> | 49 |
| <i>To zoom an image (D-ZOOM)</i> | 49 |
| <i>To adjust the volume level (VOLUME)</i> | 49 |
| <i>To mute the audio (VOLUME)</i> | 50 |
| <i>To momentarily blank the image and mute the audio (BLANK)</i> | 50 |
| <i>To freeze an image (FREEZE)</i> | 50 |
| <i>To auto adjust an image (AUTO)</i> | 50 |

| | |
|---|-----------|
| <i>To change the aspect ratio of the projected image (ASPECT)</i> | 51 |
| <i>To adjust image brightness (FUNC)</i> | 52 |
| <i>To change the color mode (FUNC)</i> | 52 |
| Eco Mode (ECO)..... | 53 |
| <i>To select the Eco Mode</i> | 53 |
| Using the Presentation Timer (TIMER) | 54 |
| <i>To display the timer</i> | 54 |
| <i>To display the timer function menu</i> | 54 |
| <i>To configure timer settings</i> | 55 |
| <i>To start a countdown timer operation</i> | 55 |
| <i>To pause the timer countdown</i> | 56 |
| <i>To resume a paused timer countdown</i> | 56 |
| <i>To reset the timer to its start time</i> | 56 |
| Using the Setup Menu (MENU) | 57 |
| Basic Setup Menu Operations..... | 57 |
| Setup Menu Settings | 57 |
| Password Protection | 62 |
| Using the Password Feature..... | 62 |
| <i>To change the password</i> | 63 |
| <i>To change the power on password setting</i> | 64 |
| <i>To change the projector internal storage function password</i> | 64 |
| Control Panel Lock..... | 65 |
| <i>To lock the control panel</i> | 65 |
| <i>To unlock the control panel</i> | 65 |
| Cleaning the Projector..... | 66 |
| Cleaning the Projector Exterior | 66 |
| Cleaning the Lens..... | 66 |
| Cleaning Vents | 66 |
| Troubleshooting | 67 |
| Indicators..... | 67 |
| Error Indicators and Warning Messages..... | 68 |
| Projector Troubleshooting..... | 70 |

| | |
|---|-----------|
| Appendix | 72 |
| Connecting to a Component Video Output..... | 72 |
| Connecting to a Composite Video Output or S-Video Output (XJ-M Series Only)..... | 73 |
| Updating Firmware and Transferring a User Logo | 74 |
| <i>To connect the projector's LOGO port with a computer's USB port.....</i> | <i>74</i> |
| Hanging the Projector from a Ceiling | 75 |
| Projection Distance and Screen Size | 76 |
| Aspect Ratio Setting and Projection Image | 78 |
| Supported Signals..... | 80 |
| Projector RS-232C Control | 83 |
| <i>To establish a serial connection between the projector and a computer.....</i> | <i>83</i> |

Projector Features and Main Functions

Features Common to All Models

- **Mercury-free Hybrid Light Source**

A CASIO-original laser and LED hybrid light source delivers high luminance from 2,500 to 3,000 lumens. This projector does not use a mercury lamp, making it environmentally friendly.

- **A wide selection of input sources**

Analog RGB, composite video, S-video (XJ-M Series only), component video (Y-Cb-Cr, Y-Pb-Pr), and HDMI input sources are supported.

- **Intelligent Brightness Control function (Eco Mode)**

The projector senses surrounding light levels and adjusts projection brightness automatically as required for efficient low-power operation. (Requires “Eco Mode” setting to be set to “On (Auto)”.)

- **Direct Power On**

The projector can be configured to turn on automatically and start projecting as soon as it is plugged into a power outlet.

- **Presentation Timer**

The presentation timer is a countdown timer that shows the amount of presentation timing remaining on the projection screen.

- **Firmware update and user logo image data transfer**

Firmware (software in the projector flash ROM) updates and user logo images can be transferred to the projector from a computer as required.

USB Model Features

USB Models: XJ-A147, XJ-A247, XJ-A257, XJ-M146, XJ-M156, XJ-M246, XJ-M256

- **Projection of image, movie, and other types of files (File Viewer)**

The projector’s File Viewer can be used to open and project the following types of files located in projector internal memory or on a USB flash drive connected to the projector: image files (JPG, PNG, GIF, BMP), movie files (AVI, MOV, MP4), presentation files (ECA, PtG), PDF files.

- **Projection of computer screen contents over a USB connection (USB Display)**

Connecting the projector to a computer with a USB cable enables projection of the computer’s screen contents. This supports projection of screen contents of even small computers that have only a USB port, but no RGB, HDMI, or other type of video output terminal.

- **Graphic Scientific Function Calculator Connection**

Certain CASIO graphic scientific calculator models can be connected directly to the projector’s USB-A port for projection of the calculator screen contents.

- **Projection of images from a computer or smart device over a wireless LAN connection***

The projector is configured as an access point, a computer or smart device can connect directly to it over a wireless LAN connection. Or a computer or smart device can connect over a wireless LAN connection via an existing wireless LAN access point. Both screen output and audio output are supported while a computer is connected.

- **Projector control using a computer or smart device over a wireless LAN connection***

The projector can be controlled from a computer or smart device connected to it over a wireless LAN connection.

* For details about wireless LAN connection, see the separate “Network Function Guide”.

Other Model-specific Features

XJ-A Series

- **Slim and compact**

A4 file size and approximately 43 mm slim. Compact enough to install or use just about anywhere.

XJ-M Series

- **3D image projection support**

Projection of a 3D image signal (60Hz/120Hz field sequential protocol) via one of three input sources (analog RGB, composite video, S-video) is supported.

- Separately available 3D glasses (YA-G30) are required in order to view a projected 3D image in 3D. Also, separately available special software (CASIO 3D Converter) is required to project a 3D image with the projector when a computer (analog RGB) is the input source.
- 3D image projection is not supported via an HDMI connection or component video connection.

WXGA models (XJ-A242, XJ-A247, XJ-A252, XJ-A257, XJ-M241, XJ-M246, XJ-M251, XJ-M256)

- **WXGA Resolution**

Supports WXGA (1280 × 800) wide-screen projection resolution. This resolution is ideal for projecting wide-screen notebook computer and HD TV images.

XJ-M Series USB Models (XJ-M146, XJ-M156, XJ-M246, XJ-M256)

- **Projection of screen contents of a computer connected via wired LAN***

A LAN cable can be used for a direct connection between the projector and a computer, or a LAN connection can be established via an existing network router. Once a connection is established, both screen output and audio output are supported.

- **Remote control of the projector from a computer connected via wired LAN***

Projector control operations can be performed remotely using the web browser of a computer connected via a wired LAN connection.

* For details about LAN connection, see the separate "Network Function Guide".

Getting Ready

This section explains how to select a location for the projector, how to connect its cables, and how to perform other operations required before using it.

Setting Up the Projector

Locate the projector on a desk, table, or stand that is firm and level. Make sure that you allow sufficient space around the sides and back of the projector for proper ventilation. The illustrations below show how the projector should be oriented relative to the screen for optimum projection.

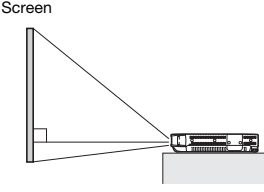
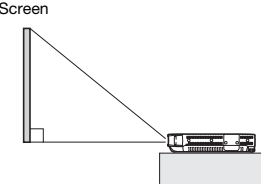
| XJ-A242/XJ-A247/XJ-A252/XJ-A257/ XJ-M241/XJ-M246/XJ-M251/XJ-M256 | Other models |
|---|---|
|  <p data-bbox="81 646 552 683">Position the projector so the lens side is at the edge of the table, etc.</p> |  <p data-bbox="567 646 968 667">Make sure the projector is at a right angle to the screen.</p> |



Important!

- With an XJ-A Series Projector, the allowable vertical angle range when setting up is ± 30 degrees (Figure 1). Make sure the projector is within this range. Setting up the projector outside this vertical angle range can shorten lamp life. There is no limit on the horizontal angle of the projector (Figure 2).

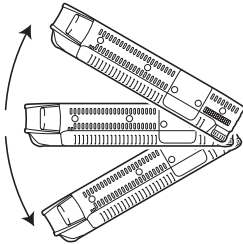

Figure 1

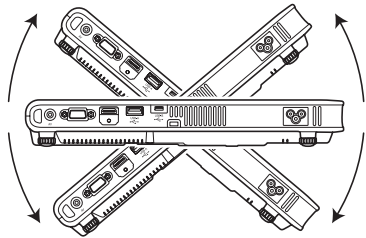

Figure 2

- With an XJ-M Series Projector, there is no limit on the vertical and horizontal setup angle.

Setup Precautions

- Use a conveniently located power outlet that you can reach easily when you need to unplug the projector.
- Do not located any objected within 30 cm (11.8 inches) around the projector. Particular care is required to keep objects away from projector air intake and exhaust openings.
- Airflow from air conditioning equipment can blow the heat being exhausted from the area around the projector's lens in a way that causes heat ripples to appear in the projected image. If this happens, adjust the airflow of the air conditioning equipment or move the projector.

Connecting Projector Cables

Connect the projector to a power outlet and to an input source device.

XJ-A Series

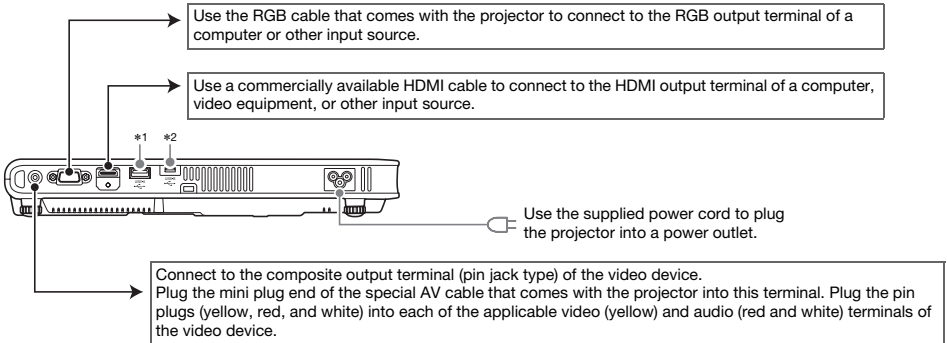

XJ-M Series

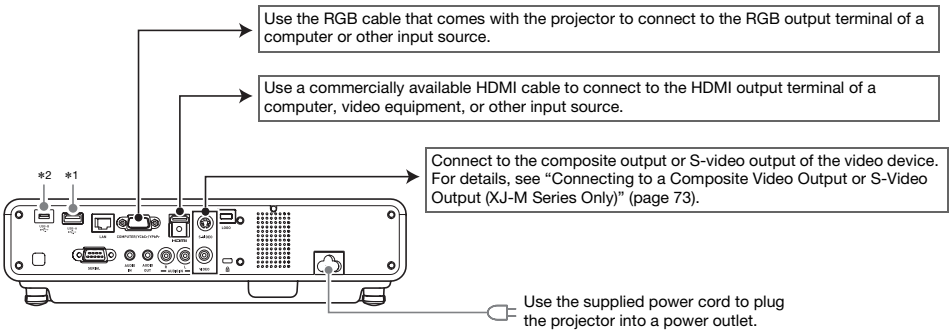

*1 Use this port to connect a USB flash drive (page 23), a CASIO graphic scientific calculator (page 48), or the wireless adapter that comes with the projector (see the separate "Network Function Guide").

*2 Terminal used when accessing projector internal memory from a computer and when projecting computer screen contents from the projector over a USB connection. For more information, see "To copy files from a computer to projector internal memory" (page 19) and "Projecting with the USB Display Function (USB Model Only)" (page 43).



Note

- For more information about component video connection, see "Connecting to a Component Video Output" on page 72.
- For information about how to connect for RS-232C control of the projector, see "Projector RS-232C Control" (page 83).
- For information about how to connect in order to update the projector firmware or to transfer user logo data, see "Updating Firmware and Transferring a User Logo" (page 74).

Remote Controller

Projector operations are performed using the remote controller that comes with it. Point the remote controller signal emitter at one of the signal receivers on the projector as you perform remote controller key operations. The maximum range of the remote controller signal is approximately 5 meters (16.4 feet) (between signal emitter and receiver).

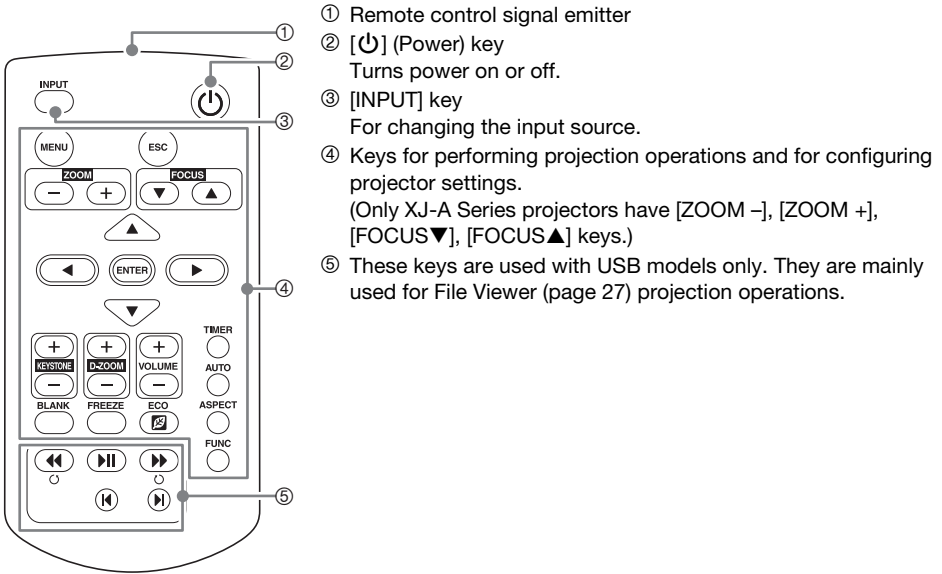

Important!

- To avoid running down the battery, store the remote control unit so its keys are not pressed inadvertently.

To load remote controller batteries



Important!

- Be sure to use alkaline batteries only.



Caution

RISK OF EXPLOSION IF BATTERY IS REPLACED BY AN INCORRECT TYPE.
DISPOSE OF USED BATTERIES ACCORDING TO THE INSTRUCTIONS.

1. Open the battery cover on the back of the remote controller.

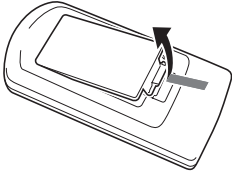

2. Load two new batteries into the case, making sure that their positive (+) and negative (-) ends are facing correctly.

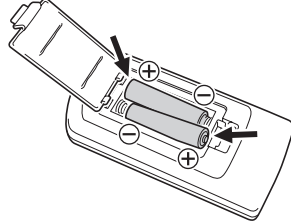

3. Close the battery cover on the back of the remote controller.

To replace remote controller batteries

Open the battery cover on the back of the remote controller, replace the old batteries with new ones, and then close the battery cover.

Projecting an Image

This section provides information about how to project images from various different input sources.

Selecting the Input Source

Input source selection provides the options described in the table below.

| Input Source Name | Output Projection Image (and Audio) |
|------------------------|---|
| Computer | Screen image of a computer connected to the projector's computer terminal. |
| Video | XJ-A Series: Images and audio from a video device connected to the projector's AV terminal. XJ-M Series: Images and audio from a video device connected to the projector's VIDEO terminal and AUDIO IN R/L terminals. |
| S-Video (XJ-M Series) | Images and audio from a video device connected to the projector's S-VIDEO terminal and AUDIO IN R/L terminals. |
| HDMI | Images and audio from a computer or video device connected to the projector's HDMI terminal. |
| File Viewer | Images (and audio in the case of a movie file) contained in the following types of files located in projector internal memory or on a memory device connected to the projector's USB-A port: image files, movie files, presentation files, PDF files. |
| CASIO USB Tool | Screen contents of a CASIO graphic scientific calculator or electronic dictionary connected to the projector's USB-A port. |
| Wireless (XJ-A Series) | Screen contents and audio of a computer connected to the projector via wireless LAN. |
| Network (XJ-M Series) | Screen contents and audio of a computer connected to the projector via wireless LAN or wired LAN |
| USB Display | Screen contents and audio of a computer connected to the projector's USB-B port. |

To select the input source

1. Press the [INPUT] key. This will display the “Input” dialog box.
2. Depending on the input source, perform one of the operations described in the table below.

| To select this input source: | Perform this operation: |
|--|--|
| Computer, Video, S-Video (XJ-M Series), HDMI, Wireless (XJ-A Series), Network (XJ-M Series), USB Display | Use the [▼] and [▲] keys to select the name of the input source you want to select and then press the [ENTER] key. |
| File Viewer | <ol style="list-style-type: none">1. Use the [▼] and [▲] keys to select “Viewer” and then press the [ENTER] key.2. On the dialog box that appears, confirm that “File Viewer” is selected and then press the [ENTER] key. |
| CASIO USB Tool | <ol style="list-style-type: none">1. Use the [▼] and [▲] keys to select “Viewer” and then press the [ENTER] key.2. Press the [▼] key to select “CASIO USB Tool” and then press the [ENTER] key. |

- The name of the input source you selected will appear in the upper right corner of the projection screen for a few seconds.
- The message “No signal input” will appear if no input signal can be detected.



Note

- For more information about the operation required to select Wireless, Network, USB Display, File Viewer, or CASIO USB Tool as the input source and perform projection, refer to the following.
 - Wireless or Network: Separate Network Function Guide
 - USB Display: “Projecting with the USB Display Function (USB Model Only)” (page 43)
 - File Viewer: “Projecting with File Viewer (USB Model Only)” (page 18)
 - CASIO USB Tool: “Projecting the Screen Image of a Graphing Calculator (USB Model Only)” (page 48)

Resolution

Depending on the projector model, its video resolution will be fixed at XGA (1024 × 768 pixels) or WXGA (1280 × 800 pixels). Images may appear coarse, text and other figures may be difficult to read or a moire pattern may appear when the input signal from a computer does not match the projector’s video resolution. If this happens, try doing the following.

- Change the computer’s output resolution setting so it matches the projector’s video resolution. For information about the video resolution of your projector, see “Specifications” in the Setup Guide. See the user documentation that comes with your computer for details about changing its settings.
- Change the “Aspect Ratio” setting to “True” (Applies only to models that support WXGA video resolution). With the “True” setting, the projector projects the input signal at its actual size (1 input source dot equal to one projector output pixel dot). For information about configuring the Aspect Ratio setting, see “To change the aspect ratio of the projected image (ASPECT)” (page 51).

3D Input Mode (XJ-M Series Only)

Your projector supports projection of 3D images. To project a 3D image, first enter the projector's 3D input mode, and then select the input source.



Important!

- Separately available 3D glasses (YA-G30) are required in order to view a projected 3D image in 3D.
- Separately available special software (CASIO 3D Converter) is required to project a 3D image with the projector when a computer (analog RGB) is the input source.
- 3D image projection is not supported via an HDMI connection or component video connection.

The input sources described below can be selected for projection in the 3D Input Mode.

| Input Source | Projection Conditions |
|--------------------------|--|
| Computer (Analog RGB) | <ul style="list-style-type: none">● Any of the following types of 3D image data played back using separately available special software (CASIO 3D Converter).<ul style="list-style-type: none">– 2D image file converted to a 3D image file using CASIO 3D Converter– Side-by-side 3D format files● Signal with 60Hz/120Hz vertical scan frequency |
| Composite Video, S-video | <ul style="list-style-type: none">● Field sequential 3D format files recorded with field sequential DVD software, etc.● Signal with 60Hz vertical scan frequency |



Note

See “3D Signals (3D Input Mode)” (page 82) for a list of 3D image signals supported by this projector.

Entering the 3D Input Mode

1. Press the [INPUT] key to display the input source selection screen.
2. Select **Computer (RGB)**, **S-video**, or **Video** as the input source.
3. Use the [▼] and [▲] keys to move the highlighting to “**To 3D input mode**” and then press the [ENTER] key.
 - This enters the 3D input mode and closes the input source selection screen.



Important!

- You cannot select HDMI, File Viewer, CASIO USB Tool, Network, or USB Display as the input source in the 3D input mode. To use either of these input sources, change the input source setting back to normal input mode.
- When Computer is selected as the input source in the 3D input mode, a component video signal input through the projector's COMPUTER IN terminal is treated as an RGB signal resulting in abnormal image projection.
- Except when using the projector for 3D image projection, you should normally leave it in the normal input mode.

Returning to the Normal Input Mode from the 3D Input Mode

- 1. Press the [INPUT] key to display the input source selection screen.**
- 2. Use the [▼] and [▲] keys to move the highlighting to “To normal input mode” and then press the [ENTER] key.**
 - This enters the normal input mode and closes the input source selection screen.

Horizontal Flipping in the 3D Input Mode

In side-by-side 3D, a full frame consists of two halves on the left and right for each eye. In rare cases, the left and right images may be reversed, which causes a loss of 3D depth. If this happens, try using the following procedure to swap the left and right images with each other.

To swap the left and right images

In the 3D input mode, press the [ENTER] key.

Projecting with File Viewer (USB Model Only)

File Viewer Overview

File Viewer is an application you can use for viewing or playing back different types of files located in projector internal memory or on a memory device connected to the projector's USB port.

Supported Playback Files

| File Type | Supported File Conditions |
|-------------------|---|
| Image File:*1 | JPEG: Up to approximately 15 M pixels (baseline JPEG) Up to approximately 8 M pixels (progressive JPEG) PNG: Less than 6 MB and up to approximately 8 M pixels*2 GIF: Less than 6 MB and up to approximately 8 M pixels*2 BMP: Less than 6 MB and up to approximately 8 M pixels (for 24-bit color) |
| Movie File:*3 | AVI: 20 Mbps maximum 720/30P (MJPEG video, ADPCM audio) MOV: 20 Mbps maximum 1080/30P (H.264 video, ADPCM audio or AAC audio) MP4: 20 Mbps maximum 1080/30P (H.264 video, AAC audio) |
| Presentation File | ECA or PtG file created with EZ-Converter FA*4 |
| PDF Files | PDF Ver 1.4 |

*1 Even if you are using a WXGA model projector (page 8), the maximum projection resolution for image data is 1024 × 768, except for baseline JPEG. In the case of baseline JPEG image data, maximum projection resolution is 1280 × 800.

*2 Transparent colors in PNG and GIF format image files that have transparent colors enabled will all be displayed as black. Animation GIFs are displayed as still images, without animation.

*3 Performing fast forward or fast reverse with a movie file with a large bit rate may cause the operation to be performed at a slower speed than normal or to stop part way through. Though a movie with one of the maximum bit rates shown above will play back normally, fast forward and fast reverse not supported.

*4 PowerPoint files can be converted using EZ-Converter FA (available from the CASIO website). See "Using EZ-Converter FA to Convert PowerPoint Files to ECA or PtG Files" (page 38).

Projecting Files Located in Projector Internal Memory

File Viewer can be used to project the following types of files when they are located in projector internal memory: image files, movie files, presentation files, PDF files. To use the procedure in this section, the file(s) to be projected must first be copied to projector internal memory. You can copy files using either of the following methods.

- Connect the projector to a computer with a USB cable and copy the files to projector internal memory.
- Use a LAN to copy (upload) files from a computer or smart device to projector internal memory.

The procedures in this manual are all based on copying files over a USB connection. For information about how to copy a file using a LAN, see the separate "Network Function Guide".

To copy files from a computer to projector internal memory



Note

- This procedure is supported on a computer running one of the operating systems below.
Windows: XP, Vista, 7, 8, 8.1 (Logged in with admin privileges)
Mac OS: 10.6, 10.7, 10.8, 10.9 (Logged in with a root account or user account)

- 1. Press the [MENU] key to display the setup menu.**
- 2. Use the [▼] key to select “Multimedia Settings”, and then press the [ENTER] key.**
- 3. Use the [▼] key to select “Internal Storage Function”, and then press the [ENTER] key.**
- 4. When the “Turns off the projector to use internal storage.” message appears, press the [ENTER] key.**
 - This will cause projector power to turn off. The POWER/STANDBY indicator will light amber and the TEMP indicator will light red.
- 5. Press the projector’s [⏻] (Power) key to turn on power.**
 - The POWER/STANDBY indicator will light green and the TEMP indicator will light red. This indicates that the projector’s internal storage function is operational. You will not be able to project images with the projector at this time.
- 6. If the computer has a USB flash drive or any other removable media connected, disconnect it.**
- 7. Use a commercially available USB cable to connect the projector’s USB-B port (Micro USB B type) to your computer’s USB port.**
 - The location of the USB-B port of this projector is indicated by “*2” in the illustration under “Connecting Projector Cables” (page 11).
 - When you do, projector internal memory will be recognized by your computer as removable disk drive named “InternalMem”.
- 8. On the computer, open the “InternalMem” drive.**

Windows:
When the “AutoPlay” dialog box appears on your computer screen, click “Open folder to view files”. If the “AutoPlay” dialog box does not appear, perform the following operation: [Start] → [Computer] → Double-click “InternalMem”.

Mac OS:
An “InternalMem” drive icon will appear on the Mac desktop. Double-click to open it.
- 9. Copy the file(s) you want to project to the “InternalMem” drive.**

10. After you copy all of the files you want, perform one of the operations below to unmount the “InternalMem” drive.

Windows:

Click the “Safely Remove Hardware” icon in the task tray (in the lower right corner of the screen). On the menu that appears, select “USB Flash Drive”. Check to make sure that a “Safe To Remove Hardware” message appears.

Mac OS:

Drag the “InternalMem” drive icon to the trash can icon. Check to make sure that the “InternalMem” drive icon is no longer on the Mac desktop.

11. Disconnect the USB cable from the projector and the computer.

12. Turn the projector back on.

- This stops internal storage function operation and returns to normal projection.
- For information about how to project a file copied to projector internal memory, see “Starting Projection of Files Located in Projector Internal Memory” (page 21).



Note

- The above is presented only as a typical example of the file copy operation on a computer. The actual steps you will need to perform may differ slightly in accordance with your computer’s operating system and setup.
- If “On” is selected for “Internal Storage Password” on the setting menu, a password input dialog box will appear when you press the [ENTER] key in step 3 of the procedure above. If this happens, enter the appropriate password and then press the [ENTER] key to advance to step 4 of the procedure. For details, see “Password Protection” (page 62).

Starting Projection of Files Located in Projector Internal Memory

1. If a USB flash drive or some other USB device is connected to the projector's USB-A port, disconnect it.
2. Press the [INPUT] key. This will display the "Input" dialog box.
3. Use the [▼] and [▲] keys to select "Viewer" and then press the [ENTER] key.
4. On the dialog box that appears, confirm that "File Viewer" is selected and then press the [ENTER] key.
 - This will start up File Viewer and display the File Viewer main screen like the one shown below.

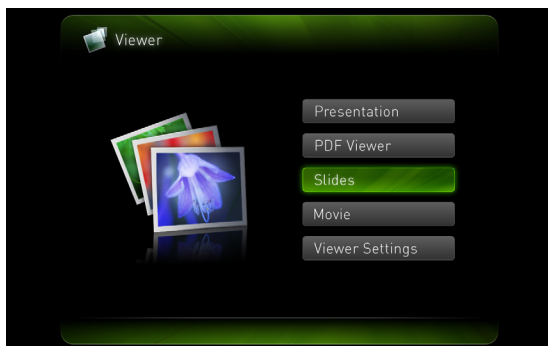

5. Depending on the type of file you want to project, perform one of the operations below.

| To project this type of file: | Perform this operation: |
|-------------------------------|--|
| Presentation Files | "To project a presentation file" (page 27) |
| PDF Files | "To project a PDF file" (page 28) |
| Image Files | "To project an image file" (page 29) |
| Movie Files | "To project a movie file" (page 29) |

To format projector internal memory



Important!

- Performing the procedure below will delete all of the folders and files currently in the projector internal memory.

- 1. Perform steps 1 through 7 under “To copy files from a computer to projector internal memory” (page 19).**
- 2. Perform one of the procedures below to format the “InternalMem” drive on your computer.**

Windows:

- (1) Right click the “InternalMem” drive icon. On the menu that appears, select “Format”.
- (2) On the “Format” dialog box that appears, check to make sure that “FAT32 (recommended)” is selected for “File system” and then click [Start].
- (3) On the warning dialog box that appears, click the [OK] button.
- (4) When a dialog box telling you that formatting is complete appears, click [OK] to close it.
- (5) Click [Close] to close the format dialog box.

Mac OS:

- (1) On the Mac desktop menu bar “Go” menu, select “Utilities” to display the “Utilities” folder.
- (2) Double-click “Disk Utility” to start it up.
- (3) In the left pane of the disk utility window, click the line above “InternalMem” and then click [Erase] at the top of the right pane.
- (4) In the “Format” box, select “MS-DOS (FAT)”.
- (5) At the bottom of the right pane, select [Erase].
- (6) On the warning dialog box that appears, click the [OK] button.
- (7) The screen will return to the disk utility window when formatting is complete. Close the window.

Projecting Files from a Memory Device Connected by USB

Use the procedures in this section when you want to use File Viewer to project image files, movie files, presentation files, or PDF files from a USB flash drive or other memory device.

Supported Memory Devices

The Data Projector's USB-A port supports connection of a FAT/FAT32 format memory device supported by the USB interface. The following are supported memory devices.

- USB flash drive
- Memory cards
A commercially available USB card reader is required to connect a memory card to the Data Projector.
- USB storage class (USB Mass Storage Class) compatible digital cameras

To connect a USB flash drive to the projector

Connect USB flash drive to the Data Projector's USB-A port as shown below.

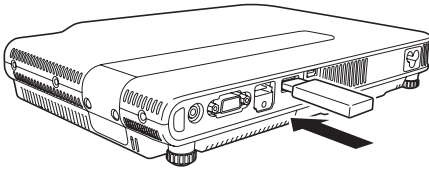

XJ-A Series

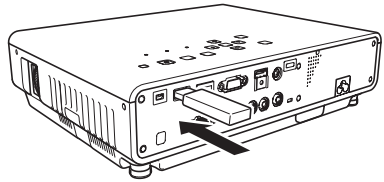

XJ-M Series

To connect a memory card to the projector

1. Load the memory card into a USB card reader's card slot.
 - For details about how to load a memory card into the USB card reader, see the user documentation that comes with the reader.
2. Connect the USB card reader to the Data Projector's USB-A port.

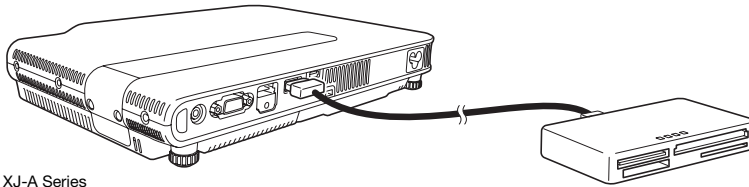

XJ-A Series

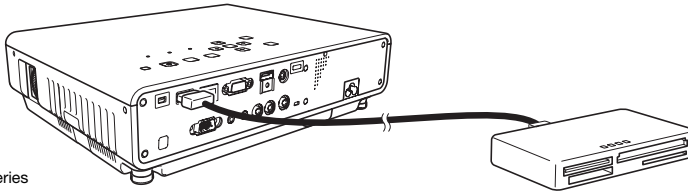

XJ-M Series

To connect a digital camera to the projector

1. If necessary, configure the digital camera's USB mass storage class setting.
2. Turn off the digital camera and connect a USB cable to it.
3. Connect the other end of the USB cable (Type A connector) to the Data Projector's USB-A port.
4. Turn on the digital camera.



Note

- For details about steps 1, 2, and 4, see the user documentation that comes with your digital camera.

To start projection of files that are on a memory device connected via USB

- 1. Connect the memory device where files you want to project are stored to the projector's USB-A port.**
 - If the File Viewer main screen appears automatically, advance to step 5 of this procedure. If it doesn't, go to step 2. Note that the File Viewer main screen will appear automatically if "On" is selected for the "Plug and Play" setting on the projector's Setup Menu.
- 2. Press the [INPUT] key. This will display the "Input" dialog box.**
- 3. Use the [▼] and [▲] keys to select "Viewer" and then press the [ENTER] key.**
- 4. On the dialog box that appears, confirm that "File Viewer" is selected and then press the [ENTER] key.**
 - This will start up File Viewer and display the File Viewer main screen.
- 5. Depending on the type of file you want to project, perform one of the operations below.**

| To project this type of file: | Perform this operation: |
|-------------------------------|---|
| Presentation File | Use the [▼] and [▲] keys to select "Presentation" and then press the [ENTER] key. |
| PDF File | Use the [▼] and [▲] keys to select "PDF Viewer" and then press the [ENTER] key. |
| Image File | Use the [▼] and [▲] keys to select "Slide" and then press the [ENTER] key. |
| Movie File | Use the [▼] and [▲] keys to select "Movie" and then press the [ENTER] key. |

- The screen that will appear depends on the function you selected.



- 6. Use the file list displayed on the screen to check the contents of the USB flash drive you connected in step 1 of this procedure or the contents of internal memory.**
 - If the file list shows the contents of a USB flash drive, go to step 8 of this procedure. If the file list shows the contents of internal memory, go to step 7.
- 7. Press the [FUNC] key. On the menu that appears, select "Drive Switching" and then press the [ENTER] key.**

8. Depending on the function you selected in step 5 of this procedure, perform one of the operations below.

| If you selected this function: | Perform this operation: |
|--------------------------------|---|
| Presentation | Perform the procedure from step 2 under “To project a presentation file” (page 27). |
| PDF Viewer | Perform the procedure from step 2 under “To project a PDF file” (page 28). |
| Slide | Perform the procedure from step 2 under “To project an image file” (page 29). |
| Movie | Perform the procedure from step 2 under “To project a movie file” (page 29). |

Drive Menu

Entering the Presentation Mode, PDF Viewer Mode, Slide Mode, or Movie Mode while there are multiple memory devices connected to the Data Projector’s USB-A port (multiple USB flash drive devices connected via a USB hub, multiple memory cards loaded in the memory card reader connected to the Data Projector, etc.) will cause a menu like the one shown below to appear on the projection screen.



When this happens, use the cursor keys to move the highlighting to the drive you want to use and then press the [ENTER] key. This will display a menu of files for the mode you are entering.



Note

- The Data Projector can recognize up to four drives.
- The message “NOUSB” will appear in the Drive Menu if there is no memory device connected to the projector’s USB-A port when you perform Drive Switching ([FUNC] → “Drive Switching” → [ENTER]). If this happens, perform Drive Switching again to restore the previous screen.

Projecting Files

This section explains procedures you can project each type of file using File Viewer.

To project a presentation file

- 1. On the File Viewer main screen, select “Presentation” and then press the [ENTER] key.**
 - This displays a menu of presentation (ECA or PtG) files.
- 2. Use the [▼] and [▲] keys to select the presentation file you want to play and then press the [ENTER] key (or [▶▶▶] key).**
 - This will start playback of the currently selected presentation file.
- 3. Perform page change and other operations as required.**
 - You can perform the operations described in the table below while presentation playback is in progress.

| To do this: | Perform this operation: |
|--|--|
| Go to the previous page | Press the [◀] or [◀◀] key. |
| Go to the next page | Press the [▶] or [▶▶] key. |
| Pause playback | Press the [▶▶▶] key. |
| Resume playback from where it was paused | Press the [▶▶▶] key. |
| Move back to the position of the previous animation delimiter | Press the [▲] or [◀◀◀] key |
| Move forward to the position of the next animation delimiter | Press the [▼] or [▶▶▶] key. |
| Select a particular page from a menu of thumbnails and play back that page | 1. Press the [FUNC] key. 2. On the menu that appears, select “Page Selection” and then press the [ENTER] key. 3. Use the cursor keys to select the thumbnail of the page you want to play back and then press the [ENTER] key. |

- 4. To return to the file menu, press the [ESC] key.**
- 5. To return to the main screen, press the [FUNC] key and then the [ENTER] key.**

To project a PDF file

1. On the File Viewer main screen, select “PDF Viewer” and then press the [ENTER] key.
 - This displays a list of PDF files.
2. Use the [▼] and [▲] keys to select the PDF file you want to open and then press the [ENTER] key (or [▶▶▶] key).
 - This will open the selected PDF file.
3. Perform page change, zoom, and other operations as required.
 - The following operations are supported during PDF file projection.

| To do this: | Perform this operation: |
|--|--|
| Go to the previous page | Press the [◀] or [◀◀] key. |
| Go to the next page | Press the [▶] or [▶▶] key. |
| Adjust the image to the screen width | Press the [FUNC] key. On the menu that appears, select “Adjust to Screen Width” and then press the [ENTER] key. |
| Return to a full page view | Press the [FUNC] key. On the menu that appears, select “Show Entire Page” and then press the [ENTER] key. |
| Select a page from a thumbnail list and display it | 1. Press the [FUNC] key. 2. On the menu that appears, select “Page Selection” and then press the [ENTER] key. 3. Use the cursor keys to select the thumbnail of the page you want to display and then press the [ENTER] key. |

4. To return to the file menu, press the [ESC] key.
5. To return to the main screen, press the [FUNC] key and then the [ENTER] key.

To project an image file

- 1. On the File Viewer main screen, select “Slide” and then press the [ENTER] key.**
 - This displays a list of image files.
- 2. Use the [▼] and [▲] keys to select image file you want to open and then press the [ENTER] key.**
 - This will project the selected image file.
 - Pressing the [▶▶▶] key instead of the [ENTER] key will start an image file slideshow starting from the currently selected file.
- 3. Perform the rotate image and image scrolling operations described below as required.**
 - The following operations are supported during image file projection.

| To do this: | Perform this operation: |
|---|----------------------------|
| Project the previous image file | Press the [◀] or [◀◀] key. |
| Project the next image | Press the [▶] or [▶▶] key. |
| Rotate the image leftwards 90 degrees* | Press the [◀◀◀] key. |
| Rotate the image rightwards 90 degrees* | Press the [▶▶▶] key. |
| Start a slideshow | Press the [▶▶▶] key. |
| Stop an ongoing slideshow | Press the [▶▶▶] key. |

* Supported for JPEG files only.

- 4. To return to the file menu, press the [ESC] key.**
- 5. To return to the main screen, press the [FUNC] key and then the [ENTER] key.**

To project a movie file

- 1. On the File Viewer main screen, select “Movie” and then press the [ENTER] key.**
 - This displays a list of movie files.
- 2. Use the [▼] and [▲] keys to select the movie file you want to open and then press the [ENTER] key or [▶▶▶] key.**
 - This will start playback of the selected movie file.

3. Perform fast forward, fast reverse, pause, and other operations as required.

- The operations described below are supported during movie file playback.

| To do this: | Perform this operation: |
|--|---|
| Pause and resume movie playback | <p>Press the [ENTER] or [▶] key.</p> <ul style="list-style-type: none"> A pause icon (▶) is displayed in the upper left corner of the projection screen while movie projection is paused. |
| Re-play the file from the beginning | <ol style="list-style-type: none"> Press the [FUNC] key. On the menu that appears, select "Play from Beginning" and then press the [ENTER] key. |
| Toggle display of the movie playback time between show and hide  | <p>Press the [FUNC] key. On the menu that appears, select "Time Indicator On/Off" and then press the [ENTER] key.</p> |
| Fast forward at 2X, 8X, or 32X normal speed | <p>Press the [▶] or [▶▶] key.</p> <ul style="list-style-type: none"> The first press starts 2X speed fast forward, the second press increases to 8X, and the third press increases to 32X. The [▶▶▶] indicator appears in the upper left corner during 2X fast forward, [▶▶▶▶] during 8X fast forward, and [▶▶▶▶▶] during 32X fast forward. |
| Fast reverse at 2X, 8X, or 32X normal speed | <p>Press the [◀] or [◀◀] key.</p> <ul style="list-style-type: none"> The first press starts 2X speed fast reverse, the second press increases to 8X, and the third press increases to 32X. The [◀◀◀] indicator appears in the upper left corner during 2X fast reverse, [◀◀◀◀] during 8X fast reverse, and [◀◀◀◀◀] during 32X fast reverse. |
| Return from fast forward or fast reverse to normal playback | <p>Press the [ENTER] key or [▶] key twice. Pressing either of these keys only once will pause playback. Press once more to start normal playback.</p> |
| Jump to the final movie frame | <p>Press the [FUNC] key. On the menu that appears, select "Go to End" and then press the [ENTER] key.</p> |
| Stop movie file playback and return to the file menu | <p>Press the [ESC] key.</p> |

4. To return to the file menu, press the [ESC] key.

5. To return to the main screen, press the [FUNC] key and then the [ENTER] key.

File Menu Operations

There are two different views for the File Viewer file menu: a list view and an icon view.

List View

This view shows a list of names of folders and files in the projector internal memory, or on memory device connected to the projector's USB port. Folders and files are displayed in this format immediately after you go from the File Viewer main screen to the Presentation Mode, PDF Viewer Mode, Slide Mode, or Movie Mode.

Icon View

This view shows both icons and names for the folders and files. Thumbnails are displayed for all of the files that can be played back by File Viewer.

To toggle the file menu between the list view and icon view

Press the [FUNC] key. On the menu that appears, select "Screen Format" and then press the [ENTER] key.



Note

- You can specify either the list view or icon view as the default view. For more information, see "Configuring File Viewer Settings" on page 32.

To scroll the file menu

Press the [▶] key to scroll forward, and the [◀] key to scroll back.

To open a folder

Use the cursor keys to move the highlighting to the folder you want to open and then press the [ENTER] key.

To exit the current folder and move up to the next level

Press the [ESC] key.

To return to the main screen from the file menu

Press the [FUNC] key. On the menu that appears, select "Back to top menu" and then press the [ENTER] key.

Configuring File Viewer Settings

This section explains how to configure File Viewer settings, including those that control what appears on the File Viewer file menu.

To configure File Viewer settings

- 1. On the File Viewer main screen, select “Viewer Settings” and then press the [ENTER] key.**
 - This displays the “Viewer Setup” screen.
- 2. Use [▼] and [▲] to select the item whose setting you want to change.**
- 3. Use [◀] and [▶] to change the currently selected setting.**
 - For information about the settings available for each item, see “File Viewer Setting Items”.
- 4. Repeat steps 2 through 3 as many times as necessary to configure all of the settings you want.**
- 5. After all the settings are the way you want, press the [ESC] key to return to the File Viewer main screen.**

File Viewer Setting Items

The initial default setting for each item is indicated by an asterisk (*).

| Setting Name | Description |
|----------------------------|--|
| Display Sequence Setup | <p>Specifies the sequence of images in the file menu.</p> <p>File Names (Ascending)*: Displays files in file name ascending order.</p> <p>File Names (Descending): Displays files in file name descending order.</p> <p>File Name Extension (Ascending): Displays file names in file name extension ascending alphabetical order. If multiple files have the same file name extension, they are displayed in file name ascending order.</p> <p>Time (New-to-Old): Displays files by the time they were last modified, from the newest to the oldest.</p> <p>Time (Old-to-New): Displays files by the time they were last modified, from the oldest to the newest.</p> |
| Startup Mode | <p>Specifies whether the default view when a mode is entered from the main File Viewer main screen is the list view or icon view.</p> <p>List View*: Specifies list view as the default view.</p> <p>Icon View: Specifies icon view as the default view.</p> |
| Thumbnail View | <p>Show*: Displays file thumbnails in the file menu.</p> <p>Hide: File thumbnails not displayed.</p> |
| Image Switching | <p>Manual*: Specifies manual image scrolling.</p> <p>Auto: Specifies auto image scrolling.</p> |
| Slideshow Display Interval | <p>Specifies how long each image will remain displayed during a slideshow.</p> <p>5 seconds*, 10 seconds, 30 seconds, 1 minute, 5 minutes</p> |
| Slideshow Repeat | <p>Repeat: Loops playback of a slideshow or movie.</p> <p>Repeat Off*: Automatically stops playback when the end of a slideshow or movie is reached.</p> |
| Movie Audio Output | <p>Output*: Outputs audio when a movie with an audio track is played back.</p> <p>Do not output: Audio not output during movie playback.</p> |
| Initialize Viewer Setup | Returns all File Viewer settings to their initial defaults. |

Autorun

Autorun lets you configure the projector for automatic projection of image files or a movie file located in a special folder named AUTORUNC. When auto projection is performed depends on where the AUTORUNC folder is located.

| When AUTORUNC is located here: | Autorun is performed at this time: |
|--------------------------------|--|
| Internal memory | When the projector is turned on. |
| USB flash drive | When the USB flash drive is plugged into the projector's USB-A port. |

The settings shown below need to be configured before using Autorun.

- “Multimedia Settings → Autorun” (page 61): Enabled
- “Option Settings 2 → Plug and Play” (page 60): On (Only when performing Autorun from a USB flash drive)



Note

- Autorun projection of the still images or a movie file is in accordance with the current settings configured on the “Viewer Setup” screen (page 32).

To auto project images files or a movie file from a USB flash drive

- 1. Create a folder named “AUTORUNC” (all single-byte upper-case characters) in the root directory of the USB flash drive.**
- 2. Insert all of the image files or movie file you want to auto project into the folder you created in step 1.**
 - If you want to auto project a movie file, place only one movie file into the “AUTORUNC” folder. Do not place any other files into the folder. If there is both a movie file and image file in the “AUTORUNC” folder, the image file will be given priority and the movie file will not be played.
 - Multiple image files can be placed in the “AUTORUNC” folder without any problem. If there are, plugging the USB flash drive into the projector in step 3 below will start a slideshow of the images.
- 3. While projector power is turned on, plug the USB flash drive that contains the “AUTORUNC” folder to which you copied the files in step 2 above into the projector’s USB-A port.**
 - This will automatically start up File Viewer and project the file(s) you put in the “AUTORUNC” folder in step 2 above.

To auto project images files or a movie file from projector internal memory

- 1. Perform steps 1 through 8 under “To copy files from a computer to projector internal memory” (page 19).**
- 2. Create a folder named “AUTORUNC” (all single-byte upper-case characters) in the root directory of the “InternalMem” drive (projector internal memory).**
- 3. Insert all of the image files or movie file you want to project with Autorun into the folder you created in step 2.**
 - If you want to auto project a movie file, place only one movie file into the “AUTORUNC” folder. Do not place any other files into the folder. If there is both a movie file and image file in the “AUTORUNC” folder, the image file will be given priority and the movie file will not be played.
 - Multiple image files can be placed in the “AUTORUNC” folder without any problem. If there are, turning on projector power in step 6 below will start a slideshow of the images.
- 4. Turn off the projector.**
- 5. If a USB flash drive or some other USB device is connected to the projector’s USB-A port, disconnect it.**
- 6. Turn on the projector.**
 - This will automatically project the file(s) you put in the AUTORUNC folder in step 3 above.

File Viewer Troubleshooting

| Problem | Cause and Required Action |
|---|--|
| <p>File Viewer does not appear when I connect USB flash drive to the Data Projector's USB-A port.</p> | <ul style="list-style-type: none"> ● The USB flash drive you are connecting may have a format that cannot be recognized by the Data Projector. Connect the USB flash drive to your computer to check if its file system is FAT or FAT32. If it isn't, reformat the USB flash drive to FAT or FAT32. Note that doing so will delete all of the data currently in USB flash drive. ● If "Off" is selected for the "Option Settings 2 → Plug and Play" setting (page 60), File Viewer will not startup automatically even if a USB flash drive is connected to the projector's USB-A port. If this happens, change the "Plug and Play" setting to "On". |
| <p>Some folders and/or files are not displayed in the file menu.</p> | <p>All the folders and/or files contained in a folder will not be displayed if there are more than 999 folder and/or files inside the folder. If this happens, reduce the number of folders and/or files in the folder.</p> |
| <p>There are multiple devices connected to the Data Projector via a USB hub or USB card reader, but some of the devices are not recognized.</p> | <p>The Data Projector can recognize up to four drives. If the number of connected drives is greater than four, the Data Projector will not recognize the fifth and subsequent drives. Connect memory devices while ensuring that no more than four drives are connected.</p> |
| <p>When I connect my digital camera to the Data Projector via USB, digital camera memory contents do not appear.</p> | <ul style="list-style-type: none"> ● The digital camera's USB mass storage class setting may not be configured correctly, or you may need to perform some operation on the camera. Consult the user documentation for your digital camera for information about the required settings and operations. ● The digital camera may not support USB mass storage class. If it does not, you will not be able to use Viewer to view digital camera memory contents. |
| <p>On the Slide Mode file menu, question marks (?) appear in place of thumbnails.</p> | <p>Question marks are displayed in place of thumbnails of images that cannot be projected by File Viewer.</p> |

File Viewer Error Messages

| Problem | Cause and Required Action |
|---|---|
| Folder does not contain any image files. | There is no displayable folder, or file in the folder you are trying to access with the File Viewer. Use your computer to check the contents of the folder. For details about file formats supported for Data Projector playback, see "Supported Playback Files" (page 18). |
| This ECA/PtG file cannot be played back. | There may be an error in the ECA file or PtG file itself. Play back the ECA file or PtG file using the EZ-Converter FA on your computer and check it. |
| Cannot display an image file. | <ul style="list-style-type: none"> ● You may be trying to play back an image whose format and/or size is not supported by File Viewer. Check the "Supported Playback Files" (page 18). ● There may be an error in the image file itself. Open the image file on your computer and check it. |
| This movie file cannot be played back. | <ul style="list-style-type: none"> ● You may be trying to play back a movie whose format and/or size is not supported by File Viewer. Check the "Supported Playback Files" (page 18). ● There may be an error in the movie file itself. Open the movie file on your computer and check it. |
| This PDF file cannot be displayed. | For information about the types of PDF files that can be displayed by File Viewer, see "Supported Playback Files" (page 18). |
| Internal Memory Access Error | <p>An error may have been generated by a particular folder or file in projector internal memory. Perform steps 1 through 8 under "To copy files from a computer to projector internal memory" (page 19) and then open the "InternalMem" drive (projector internal memory) on your computer. Check if all of the folders and files in "InternalMem" open normally. If you experience trouble with any file or folder, delete it.</p> <p>If you cannot open any of the files or folders in projector internal memory with your computer or if you cannot open the "InternalMem" drive itself, it could mean there is a problem with the projector internal memory file system. In this case, perform the procedure under "To format projector internal memory" (page 22).</p> |
| Failure due to insufficient internal memory capacity. | Remaining available projector internal memory capacity is insufficient. Perform steps 1 through 8 under "To copy files from a computer to projector internal memory" (page 19) and then open the "InternalMem" drive (projector internal memory) on your computer. Next, delete files you no longer need. |
| This file cannot be played back. | For information about the types of files that can be displayed by File Viewer, see "Supported Playback Files" (page 18). |
| Could not find an image file. | There is nothing in projector internal memory or on the connected USB flash drive, or there is some problem with the file system. Use your computer to check the contents of projector internal memory or the USB flash drive. |

Using EZ-Converter FA to Convert PowerPoint Files to ECA or PtG Files

EZ-Converter FA is computer software for converting PowerPoint files to ECA files or PtG files, which can be played back using the projector's File Viewer. EZ-Converter FA supports conversion of files created with Microsoft Office PowerPoint 2003, 2007 and 2010.



Important!

- Before trying to use EZ-Converter FA, be sure to go to the CASIO website (<http://www.casio-intl.com/support/>) and check the information there about minimum computer system requirements, and conditions governing download and use.
- The procedure below assumes that you already have EZ-Converter FA installed on your computer.



Note

- Save for certain exceptions (described below), playback and projection of an ECA file or PtG file normally should be able to reproduce transitions, animations, and other special effects of the original PowerPoint file.
 - Conversion of OLE objects (movies, audio, etc.) and VBA objects in a PowerPoint file is not supported.
 - Conversion of timer and repeat operations in a PowerPoint file animation is not supported.
 - An animation in a PowerPoint file is converted up to the time specified by "To specify the maximum animation display time" (page 41), and everything after that is cut. When the point up to which the animation was converted is reached during playback of the converted file, playback will pause, and you will have to press the [ENTER] key to advance to the next step.
 - The source PowerPoint file plays when you convert a file with EZ-Converter FA. If there is no change on the screen for about three consecutive seconds during this playback, say between Points A and B, for example, the effect at Point B in the original file is ignored and not converted. When Point B is reached during playback of the converted file, playback will pause, and you will have to press the [ENTER] key to advance to the next step.
- Starting a conversion operation with EZ-Converter FA will temporarily change the screen settings of your computer as shown below. Screen settings will revert back to what they were after the conversion operation is complete.

| Operating System: | Changes: |
|----------------------------|---|
| Windows XP | <ul style="list-style-type: none">● Screen resolution changes to 800 × 600, 1024 × 768, 1280 × 768 or 1280 × 800.● Display card hardware acceleration is disabled. |
| Windows Vista or Windows 7 | <ul style="list-style-type: none">● Screen resolution changes to 800 × 600, 1024 × 768, 1280 × 768 or 1280 × 800.● Windows changes to the Basic mode (Windows Aero™ disabled). |
| Windows 8 | <ul style="list-style-type: none">● Screen resolution changes to 800 × 600, 1024 × 768, 1280 × 768 or 1280 × 800. |

- The screen resolution of the ECA file or PtG file will be the resolution specified by the EZ-Converter FA setting (800 × 600, 1024 × 768, 1280 × 768 or 1280 × 800) when the file conversion operation starts. For information about configuring this setting, see "To specify the screen resolution of the ECA file or PtG file" (page 41).

To convert a PowerPoint file to an ECA file or PtG file



Important!

- Before performing any of the operations here, you will need to have a file created using Microsoft Office PowerPoint 2003, 2007 or 2010 on hand.
- Conversion of a PowerPoint file to an ECA file or PtG file requires playback of the original file from beginning to end. Note that the time required for conversion will roughly correspond to the time required for playback.

1. Turn on your computer and start up Windows.

2. Connect the USB flash drive (or memory card) where you want to store the converted ECA file or PtG file to your computer.

- You can skip this step if you want to save the ECA file or PtG file to your computer's local hard disk.

3. On your computer, start up EZ-Converter FA.

- If your computer is running Windows Vista or Windows 7, starting up EZ-Converter FA will cause the "User Account Control" message to appear. When it does, click [Allow] or [Yes].
- This will display the EZ-Converter FA window.

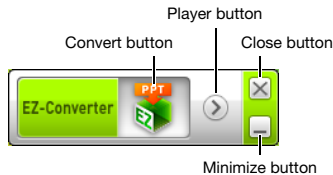

4. Configure the following settings as required.

- Specify the ECA file or PtG file screen display resolution. See "To specify the screen resolution of the ECA file or PtG file" (page 41).
- If the original file contains an animation, specify the maximum animation display time. See "To specify the maximum animation display time" (page 41).

5. Click the button at the top of the EZ-Converter FA window.

- This displays a dialog box for opening files.

6. Select the PowerPoint file you want to convert from and then click the [Open] button.

- This will display a dialog box like the one shown below for specifying the file settings.

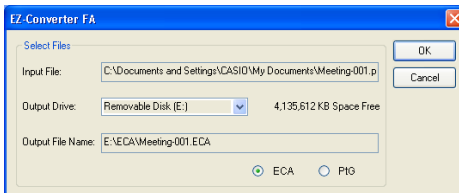

7. Configure the settings as required on the dialog box.

- The following describes the meanings and settings of each of the items that appear on the dialog box.

| Dialog Box Item | Description |
|------------------|--|
| Input File | Shows the name of the PowerPoint file selected in step 6. The setting of this item cannot be changed. |
| Output Drive | Shows the drive name of the removable disk (USB flash drive or memory card) connected to the computer in step 2. When you have multiple removable disks connected to your computer, you can click the [▼] button and select the name of the drive where you want to save the converted file. A converted file is stored in the folder named ECA (in the case of an ECA file) or PtG (in the case of a PtG file) on the drive you specify here. Under initial default settings, if there are no removable disks connected to the computer, the resulting file will be saved in the same location (drive and folder) as the original PowerPoint file. Click the [Browse] button and change the save destination, if you want. |
| Output File Name | Shows the file name of the converted file, along with the path from the drive name. Except for the extension, the file name is the same as the PowerPoint file name. The setting of this item cannot be changed. |
| ECA/PtG | Specifies the format of the converted file (Default: ECA). |

8. After configuring all the settings you want, click [OK].

- This will start playback of the PowerPoint file and start converting it to an ECA file or PtG file.
- The “Conversion complete.” message will appear when file conversion is complete.
- If you have other PowerPoint files you want to convert, repeat steps 4 through 7.
- To check the contents of an ECA file or PtG file, perform the procedure under “To play back an ECA file or PtG file on your computer” (page 41).

9. After you are finished converting all the files you want, click the close button in the upper right corner of the EZ-Converter FA window.

To specify the screen resolution of the ECA file or PtG file

1. Right-click the left side of the EZ-Converter FA window.
2. On the menu that appears, click “Output Resolution”.
3. On the sub-menu that appears, select the resolution you want.
 - Select 1280 × 800 or 1280 × 768. If you cannot select the 1280 × 800 or 1280 × 768 resolution, select 1024 × 768.
 - For a PtG file, select 1024 × 768 or 800 × 600.
 - The setting you select here remains in effect until you change it.

To specify the maximum animation display time

1. Right-click the left side of the EZ-Converter FA window.
2. On the menu that appears, click “Max Animation Display Time”.
3. On the sub-menu that appears, select a maximum animation display time value (in seconds).
 - Available sub-menu options are 10 seconds, 20 seconds, 30 seconds, and 60 seconds.
 - The option you select remains in effect until you change it.

To play back an ECA file or PtG file on your computer

1. On your computer, start up EZ-Converter FA.
 - This will display the EZ-Converter FA window.



2. Click the  button at the top of the EZ-Converter FA window.
 - This will display two more buttons as shown below.







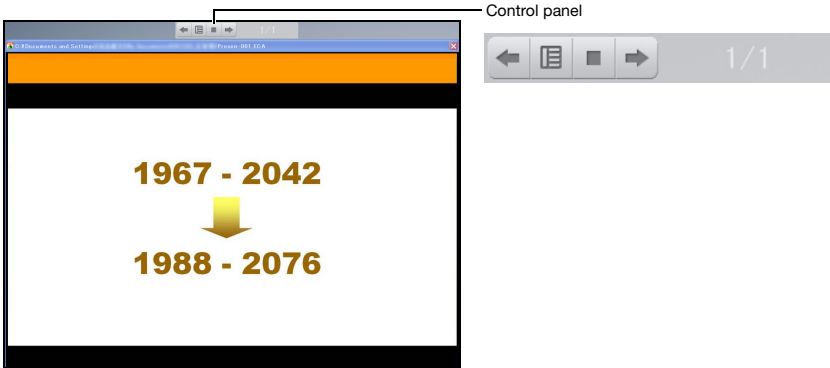

3. Click the  button.
 - This displays a dialog box for opening files.

4. Select the ECA file or PtG file you want to play back and then click the [Open] button.

- This will display a control panel at the top of the screen.



- During file playback, you can use the control panel buttons to perform the operations described below.

| To do this: | Perform this operation: |
|-------------------------|---|
| Go to the previous page | Click the  button. |
| Go to the next page | Click the  button. |
| Jump to a specific page | 1. Click the  button and then click "Slide Viewer" on the menu that appears. 2. On the page menu that appears, click the thumbnail of the destination page and then click [OK]. |
| Display help | Click the  button and then click "Help" on the menu that appears. |
| Exit file playback | Click the  button, or click the  button and then click "Exit" on the menu that appears. You could also press the [ESC] button on your computer keyboard to stop playback. |

Projecting with the USB Display Function (USB Model Only)

USB Display Function Overview

Connecting the projector to a computer with a USB cable* enables projection of the computer's screen contents. This supports projection of screen contents of even small computers that have only a USB port, but no RGB, HDMI, or other type of video output terminal.

* To use the USB Display function, connect the computer to the projector's USB-B port.

Minimum Computer System Requirements

- Supported Operating Systems
Windows XP SP3, Windows Vista SP1 (32bit), Windows 7 SP1 (32bit, 64bit), Windows 8/8.1 (64bit), or Mac OS (10.6, 10.7, 10.8, 10.9)
Note, however, that functions may be limited by the operating system being used.
- USB Type A port (USB 2.0) equipped.



Important!

- Log into Windows with admin privileges to use the USB display function. You will not be able to use USB display if you are logged into Windows with a non-admin account.

Projecting Computer Screen Contents Over a USB Connection

The operation you need to perform the first time you connect to a computer to project its display contents (described below) depends on whether the computer is running Windows or Mac OS. After that, use the procedure under "To project computer screen contents over a USB connection after the first time" (page 47), which is the same for any operating system.

Perform one of the procedures below, depending on your computer's operating system.

To project Windows computer screen contents over a USB connection for the first time

1. Press the [INPUT] key. This will display the “Input” dialog box.
2. Use the [▼] and [▲] keys to select “USB Display” and then press the [ENTER] key.
 - This will cause the USB Display standby screen to be projected.
3. While your computer is running, use a commercially available USB cable to connect the projector’s USB-B port (Micro USB B type) to your computer’s USB port.
 - The location of the USB-B port of this projector is indicated by “*2” in the illustration under “Connecting Projector Cables” (page 11).
 - This will mount the projector onto your computer as a virtual CD-ROM drive, which is represented by a “USB_DISPLAY” drive icon on your computer’s desktop.
 - CASIO USB Display will start up automatically and display a window like the one shown below on your computer. Projection of the computer screen contents will also start at the same time.



Note

- If CASIO USB Display does not start up automatically, use Explorer to navigate to the USB_DISPLAY drive. Right-click the drive and then click “Auto Play” on the menu that appears.
- For information about the types of operations that can be performed at this point, see “Supported Operations during Projection over a USB connection” (page 46).

Add-on Driver Software for Windows

With Windows, use of some functions of the CASIO USB Display requires installation of the driver software shown in the table below. For information about how to obtain this software, go to the CASIO website (<http://www.casio-intl.com/support/>).

| To use this function: | Install this driver software: |
|---------------------------------|---|
| Audio output function | VAC driver (for Windows XP version that does not support audio level mixer functions) |
| Extended screen output function | VDD driver (for Windows XP and Windows Vista) |

To project Mac OS computer screen contents over a USB connection for the first time

1. Press the [INPUT] key. This will display the “Input” dialog box.
2. Use the [▼] and [▲] keys to select “USB Display” and then press the [ENTER] key.
 - This will cause the USB Display standby screen to be projected.
3. While your computer is running, use a commercially available USB cable to connect the projector’s USB-B port to your computer’s USB port.
 - The location of the USB-B port of this projector is indicated by “*2” in the illustration under “Connecting Projector Cables” (page 11).
 - This will cause a drive icon named “USB_DISPLAY” to appear on your computer screen.
4. Double-click the “USB_DISPLAY” drive icon to open it.
5. Double-click “MAC_USB_Display_V2.pkg” and follow the instructions that appear on the display to install the application.
 - A message prompting you to restart your computer will appear after installation is complete. Restart your computer. After the restart is complete, you will see a CASIO USB Display icon in the Dock.
6. In the Dock, click the CASIO USB Display icon.
 - This will start up CASIO USB Display, which will display the window shown below on your computer. At the same time, projection of the computer’s screen contents will start.



- For information about the types of operations that can be performed at this point, see “Supported Operations during Projection over a USB connection” (page 46).











Add-on Driver Software for Mac OS

With Mac OS, use of some parts of the CASIO USB Display requires installation of the driver software shown in the table below. For information about how to obtain this software, go to the CASIO website (<http://www.casio-intl.com/support/>).

| To use this function: | Install this driver software: |
|----------------------------------|-------------------------------|
| Audio output function | Sound flower |
| Extended desktop output function | Syphon-virtual-screen |

Supported Operations during Projection over a USB connection

The operations described in the table below are supported on the CASIO USB Display window during projection.

| To do this: | Perform this operation: |
|--|---|
| Start (resume) computer screen projection | Click  . |
| Freeze computer screen projection | Click  . |
| Stop computer screen projection and project the USB display standby screen | Click  . |
| Start audio output from a computer*1*3 | Click  . On the menu that appears, select "Audio Out" so there is a check mark next to it. |
| Mute audio output from a computer*1*3 | Click  . On the menu that appears, select "Audio Out" to remove the check mark next to it. |
| Output the computer's main screen on the projection screen | Click  . On the menu that appears, select "Select the Projection Screen" → "Main Screen". |
| Output the computer's extended screen on the projection screen*2*3 | Click  . On the menu that appears, select "Select the Projection Screen" → "Extended Screen". |
| Minimize the CASIO USB Display window | Click  . |
| Exit the CASIO USB Display window | (1) Click  . Or you could click  and then click "Exit" on the menu that appears. (2) On the confirmation dialog box that appears, click the [OK] button. ● This stops computer screen projection and projects the USB Display standby screen. |
| Display CASIO USB Display version information | Click  . On the menu that appears, select "About". |

*1 In the case of Windows XP, which does not support audio level mixer functions, a driver must be installed to enable these functions. See "Add-on Driver Software for Windows" (page 44).

*2 This operation is disabled under Mac OS 10.6. With Windows XP and Windows Vista, installation of driver software is required to enable these functions. See "Add-on Driver Software for Windows" (page 44).

*3 With Mac, installation of driver software is required to enable these functions. See "Add-on Driver Software for Mac OS" (page 45).

To project computer screen contents over a USB connection after the first time

- 1. Turn on and start up the projector and computer.**
- 2. Press the [INPUT] key. This will display the “Input” dialog box.**
- 3. Use the [▼] and [▲] keys to select “USB Display” and then press the [ENTER] key.**
 - This will cause the USB Display standby screen to be projected.
- 4. Use a USB cable to connect the projector’s USB-B port to your computer’s USB port.**
 - The CASIO USB Display will startup automatically on the computer and start projection of the computer screen contents.



Note

- If the above operation does not cause CASIO USB Display to start up automatically, perform either of the operations below on your computer, depending on its operating system.

Windows:

Use Explorer to navigate to the USB_DISPLAY drive. Right-click the drive and then click “Auto Play” on the menu that appears.

Mac OS:

In the Dock, click the CASIO USB Display icon.

Projecting the Screen Image of a Graphing Calculator (USB Model Only)

You can connect a CASIO graphing calculator to the Data Projector using a USB cable and project the calculator's screen image with the Data Projector. USB connection of the following CASIO graphing calculators is supported.

- ClassPad II (fx-CP400)
- ClassPad 330 PLUS
- fx-CG series
- fx-9860G series
- fx-9860GII series
- fx-9750GII
- GRAPH 95/85/85 SD/75/75+/35+

To project the screen image of a graphing calculator

- 1. While the projector is turned on, connect the USB cable that comes with the graphing calculator to the projector's USB-A port and the graphing calculator's USB port.**
- 2. On the projector, press the [INPUT] key. This will display the "Input" dialog box.**
- 3. Use the [▼] and [▲] keys to select "Viewer" and then press the [ENTER] key.**
- 4. Use the [▼] key to select "CASIO USB Tool" and then press the [ENTER] key.**
- 5. On the graphing calculator, perform the operation required for projection.**
 - For details about this operation, refer to the use documentation that comes with your calculator.



Important!

- If the calculator does not operate properly after you connect it to the Data Projector, try disconnecting the USB cable from the calculator and then reconnecting it. If this does not correct the problem, disconnect the USB cable from both the Data Projector and the calculator. Turn the Data Projector off and then back on again, and then re-connect the calculator.

Operating the Projector

This section explains how to use the remote controller to perform projector operations.

Output Image and Audio Operations

To use manual keystone correction (KEYSTONE)

The projector has a keystone correction feature that prevents distortion of the projected image when projecting from an angle. The projector detects when it is at a vertical angle to the screen and performs keystone correction automatically. You can use the [KEYSTONE +] and [KEYSTONE -] keys to adjust keystone correction manually.

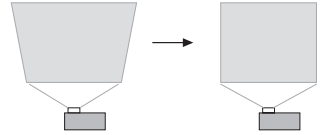

To zoom an image (D-ZOOM)

- 1. Press the [D-ZOOM] key.**
 - This will enlarge the center of the projected image one step.
- 2. To zoom in on the center of the projected image more, press the [D-ZOOM] key again.**
 - Each press of [D-ZOOM] zooms in (increases the zoom factor). Holding down [D-ZOOM] continuously scrolls the zoom factor.
- 3. While an image is zoomed, use the [▲], [▼], [◀], and [▶] keys to scroll the view to other parts of the image.**
- 4. To exit the zoom operation, press the [ESC] key.**

To adjust the volume level (VOLUME)

- 1. Press the [VOLUME +] or [VOLUME -] key.**
 - This causes the “Volume” screen to appear on the projected image.
- 2. Press the [VOLUME +] key to increase the volume, or the [VOLUME -] key to lower the volume.**
- 3. After the setting is the way you want, press the [ESC] key.**

To mute the audio (VOLUME)

- 1. Press the [VOLUME +] or [VOLUME -] key to display the “Volume” screen.**
- 2. Press the [ENTER] key.**
 - This stops output from the speaker.
- 3. To restore the audio, press the [VOLUME +] or [VOLUME -] key.**

To momentarily blank the image and mute the audio (BLANK)

- 1. Press the [BLANK] key.**
 - This blanks the screen by displaying the blank screen image specified by the Setup Menu “Blank Screen” setting (page 59) and mutes the audio.
- 2. To resume normal image and sound, press the [BLANK] key (or [ESC] key).**

To freeze an image (FREEZE)

Press the [FREEZE] key to freeze the current input source image. To return to the real-time input source image, press the [FREEZE] key again or press the [ESC] key.

To auto adjust an image (AUTO)

Press the [AUTO] key.

- Pressing the [AUTO] key automatically adjusts the frequency and phase in accordance with the input signal, which can reduce flickering and other projected image problems.
- This operation is supported while the input source is Computer (RGB).

To change the aspect ratio of the projected image (ASPECT)

Press the [ASPECT] key to cycle through the aspect ratio settings for the projected image. Available settings depend on your projector model as shown below.

XJ-A242/XJ-A247/XJ-A252/XJ-A257/XJ-M241/XJ-M246/XJ-M251/XJ-M256

Pressing the [ASPECT] key will cycle through settings in accordance with the current input source as shown below.

| Input Source | Pressing the [ASPECT] key will cycle through these settings: |
|------------------------------|--|
| Video, Component, HDMI (DTV) | Normal → 16:9 → 4:3 → Letter Box |
| RGB, HDMI (PC) | Normal → Full → 16:9 → 4:3 → True |

XJ-A142/XJ-A147/XJ-M141/XJ-M146/XJ-M151/XJ-M156

Pressing the [ASPECT] key will cycle through settings in accordance with the current input source as shown below.

| Input Source | Pressing the [ASPECT] key will toggle between these settings: |
|------------------------------|---|
| Video, Component, HDMI (DTV) | Normal → 16:9 → 4:3 |
| RGB, HDMI (PC) | Normal → Full → 16:9 |

Description of Each Setting

Normal: Projects at the projector's maximum possible size while maintaining the input signal aspect ratio.

Full: Projects at the projector's maximum possible size by enlarging or reducing the input signal.

16:9: This setting specifies a 16:9 aspect ratio, which is the same as a movie screen, high-definition TV, etc. Using this setting when the input signal is a 16:9 image that has been squeezed to a 4:3 image causes the image to be displayed with its normal 16:9 aspect ratio.

4:3: Regardless of the input signal aspect ratio, the image is always resized to an aspect ratio of 4:3 for projection.

True: Projects the input signal at its actual size (1 input source dot equal to one projector output pixel dot) in the center of the projector's projection screen. If the input signal resolution exceeds the projector's output resolution, the excess is cut off.

Letter Box: This will resize the image horizontally to 1280 dots and project 800 vertical dots of the center of the image, maintaining the aspect ratio of the input signal.



Note

- For details about how the aspect ratio setting affects the projected image, see "Aspect Ratio Setting and Projection Image" (page 78).
- When projecting while "True" is selected as the aspect ratio setting for an RGB signal with a resolution that is less than SVGA, the image is enlarged to SVGA and projected.
- You can also change the aspect ratio using the Setup Menu "Screen Settings → Aspect Ratio" setting (page 58).



Important!

- Note that enlarging or reducing the size of an image using the [ASPECT] key for commercial purposes or public presentation may infringe on the legally protected copyright of the copyright holder of the original material.

To adjust image brightness (FUNC)

1. Press the [FUNC] key. On the menu that appears, select “Brightness” and then press the [ENTER] key.
2. On the brightness adjustment screen that appears, use the [◀] and [▶] keys to adjust brightness.
3. To hide the window, press the [ESC] key.

To change the color mode (FUNC)

1. Press the [FUNC] key. On the menu that appears, select “Color Mode” and then press the [ENTER] key.
 - This displays the color mode selection window. The currently selected color mode is the one whose button is selected (filled in).
2. Use the [▼] and [▲] keys to move the highlighting to the color mode you want to select, and then press the [ENTER] key.
 - This will select the button next to the highlighted color mode name.
 - For details on what each color mode does, see “Image Adjustment 1 → Color Mode” (page 58).
3. To hide the window, press the [ESC] key.



Important!

- The color mode cannot be selected in the following cases.
 - When “Off” is selected for the Eco Mode setting (page 53)

Eco Mode (ECO)

The following three Eco Mode settings are available to specify whether priority should be given to low-power, low-noise operation or to projection brightness.

- On (Auto)** : A brightness sensor on the top of the projector senses surrounding light, and automatically adjusts projection brightness and color accordingly. Brightness is reduced for darker surroundings, which saves power and reduces operation noise.
- On (Manual)**: Enables manual adjustment to balance the needs of low-power, quiet operation and projection brightness.
- Off** : Give top priority to projection brightness.



Important!

- While “On (Auto)” is selected as the Eco Mode setting, make sure that the brightness sensor on the top of the projector is not blocked by anything.
- The local environment and setup conditions affect the brightness sensor, so operation when “On (Auto)” is selected for the Eco Mode depends on these factors.

To select the Eco Mode

1. Press the [ECO] key.

- This causes “Eco Mode” window to appear on the projection screen.

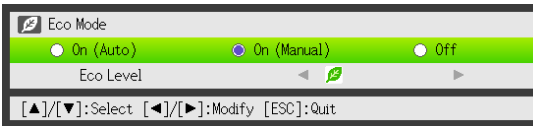

2. Use the [◀] and [▶] keys to select the setting you want.

- If you select “On (Manual)” here, go to step 3. If you select another setting, jump to step 4.

3. Perform the following steps to adjust the “Eco Level” (the balance between low-power, quiet operation and projection brightness).

- ① Press the [▼] key to move the highlighting to the Eco Level.
- ② Use the [◀] and [▶] keys to adjust the Eco Level to the setting you want.
Fewer  marks gives higher priority to projection brightness. A greater number gives high priority to low-power, quiet operation.

4. To hide the window, press the [ESC] key.



Note

- While “Off” is selected for the Eco Mode setting, you also can specify whether brightness or color should be given emphasis. For details, see “Image Adjustment 1 → Eco Off Mode” (page 58).



Important!

- The Eco Mode level is fixed whenever the projector is in the 3D input mode (“3D Input Mode (XJ-M Series Only)”, page 16). Because of this the Eco Mode setting cannot be changed.

Using the Presentation Timer (TIMER)

The presentation timer shows a countdown from a preset time value. You can use it to keep track of how much time has elapsed during your presentation, and to limit a presentation to a preset amount of time. You can configure the presentation timer so it is displayed in the projected image.



To display the timer

When the timer is not displayed on the projected image, press the [TIMER] key once.

The timer will appear for about five seconds and then disappear automatically if the “Off” is selected for the “Continuous Display” setting on the timer function menu.

To display the timer function menu

When the timer is not displayed on the projected image, press the [TIMER] key twice. If the timer is displayed, press the [TIMER] key once.

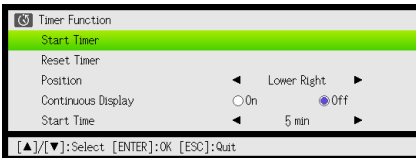

Use this menu to start, pause, resume, and reset the timer, and to configure various timer settings.

To configure timer settings

1. Use the [TIMER] key to display the timer function menu.
2. Use the [▼] and [▲] keys to select the “Position”, “Continuous Display”, or “Start Time” setting and then change the settings as described in the table below.

| To do this: | Perform this operation: |
|---|--|
| Reposition the timer on the projected image | Select “Position”, and then use the [◀] and [▶] keys to select one of the following settings: “Lower Right”, “Upper Right”, “Upper Left”, “Lower Left” (Initial default: Lower Right). |
| Enable or disable continuous display of the timer | Select “Continuous Display”, and then use the [◀] and [▶] keys to select either “On” or “Off” (Initial default: Off). On: Once the timer is displayed, it remains displayed until you display a different dialog box or you press the [ESC] key. Off: The timer automatically disappears about five seconds after it is displayed. |
| Specify the timer countdown start time | Select “Start Time”, and then use the [◀] and [▶] keys to specify the countdown start time you want. You can set a start time from five to 60 minutes, in five-minute steps (Initial default: 20 minutes). |

3. To save your settings and close the timer function menu, press [ESC].
 - To start the timer immediately after changing its settings, use [▼] and [▲] to select “Start Timer” on the timer function menu and then press the [ENTER] key before pressing [ESC] in the step above.

To start a countdown timer operation

1. Use the [TIMER] key to display the timer function menu.
2. Select “Start Timer” and then press the [ENTER] key.
 - This will close the timer function menu and start the timer countdown.
 - After the countdown reaches 00:00, it will start a 60-minute count up operation (from -00:01 to -60:00). The numerals of the timer display are red (indicating that the presentation is over time) during a count up operation.

To pause the timer countdown

- 1.** Use the [TIMER] key to display the timer function menu.
- 2.** Select “Pause Timer” and then press the [ENTER] key.

To resume a paused timer countdown

- 1.** Use the [TIMER] key to display the timer function menu.
- 2.** Select “Restart Timer” and then press the [ENTER] key.

To reset the timer to its start time

- 1.** Use the [TIMER] key to display the timer function menu.
- 2.** Select “Reset Timer” and then press the [ENTER] key.
 - This will reset the time to the “Start Time” setting.

Using the Setup Menu (MENU)

Pressing the [MENU] key displays the Setup Menu shown below on the projection screen. You can use this menu to adjust projected image brightness, contrast, and other settings, and to change projector settings.

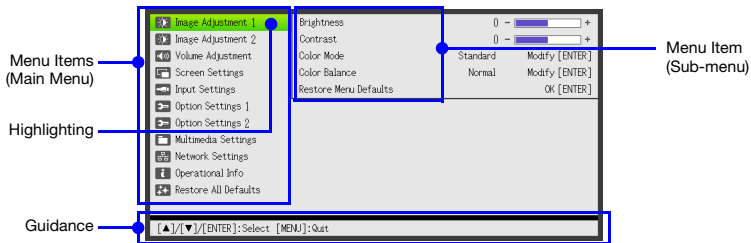

The guidance shows the key operations that can be performed for the currently selected (highlighted) menu item.

Basic Setup Menu Operations

| To do this: | Perform this operation: |
|---|---|
| Display the Setup Menu Exit the Setup Menu | Press the [MENU] key. Pressing the [MENU] key to exit the Setup Menu will save the settings you configured while it was displayed. |
| Select a menu item | Use the [▲] and [▼] keys to move the highlighting to the menu that contains the menu item you want to select and then press the [ENTER] key. Next, use the [▲] and [▼] keys to move the highlighting to the menu item you want to select. |
| Configure the setting of a menu item | <ul style="list-style-type: none"> ● If a menu item that has options or setting values to the right, use the [◀] and [▶] keys to change the setting. ● For a menu item that has "Modify [ENTER]" or "OK [ENTER]" to the right, press the [ENTER] key to display a dialog box for configuring the setting. |



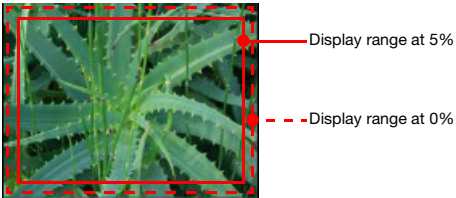

Setup Menu Settings

- One or more letters (such as RCV) after the menu item name indicates an item that is available only when one or more particular input source is selected. The letters indicate the input source(s) where the menu item is available.
R: RGB input, **C:** Component input, **V:** S-video input*1 or Video input, **H:** HDMI (PC) input, **D:** HDMI (DTV) input, **F:** File Viewer, **T:** CASIO USB Tool, **W:** Wireless*2 or Network*1, **U:** USB Display
 *1 XJ-M Series only *2 XJ-A Series only
- A menu item that does not have any letter after it will be available regardless of the input source.
- **USB** after a menu item indicates the item is available only for USB models.
- The initial default setting is indicated by an asterisk (*).

| Use this menu item: | To do this: |
|---------------------------------------|--|
| Image Adjustment 1 → Brightness | Adjust projected image brightness. |
| Image Adjustment 1 → Contrast | Adjust projected image contrast. |
| Image Adjustment 1 → Sharpness (V) | Use this sub-menu to adjust the sharpness of the outlines in the projected image. A larger value makes the image sharper, while a smaller value makes it softer. |

| Use this menu item: | To do this: |
|---|--|
| Image Adjustment 1 → Saturation (V) | Use this sub-menu to adjust the color saturation of the projected image. A larger value increases color saturation. |
| Image Adjustment 1 → Tint (V) | Use this sub-menu to adjust the tint of the projected image. A larger value makes the overall image more bluish, while a smaller value makes the overall image more reddish. This setting is supported only when the signal is NTSC or NTSC4.43. |
| Image Adjustment 1 → Color Mode | Select one of the following projected image color modes: "Standard*", "Graphics", "Theater", "Blackboard", "Game". |
| Image Adjustment 1 → Color Balance | Select one of the following color balance presets: "Warm", "Normal*", "Cold". Also can be used to separately adjust red, green, and blue. |
| Image Adjustment 1 → Eco Off Mode | When "Off" is selected for the "Option Settings 1 → Eco Mode" setting, specify either "Bright" (brightness priority) or "Normal*" (hue priority) as the image quality setting. |
| Image Adjustment 1 → Restore Menu Defaults | Return all of the items in the "Image Adjustment 1" main menu to their initial defaults for the currently projecting image source. |
| Image Adjustment 2 → Vertical Position (RCV) | Adjust the vertical and horizontal positions of the input source image in relation to the target screen. |
| Image Adjustment 2 → Horizontal Position (RCV) | |
| Image Adjustment 2 → Frequency (R) | When vertical bands appear in the projected image while RGB is selected as the input source, it means that the frequency setting is not correct. When this happens, use this setting to adjust the frequency manually. If, for some reason, your manual frequency settings cause the image input from the computer to disappear from the projection, you can press the [AUTO] key to perform an auto adjust operation, which should cause the image to appear. |
| Image Adjustment 2 → Phase (R) | Adjust the phase of the RGB input signal when the image flickers because the projector phase and RGB input signal phase do not match. |
| Image Adjustment 2 → Overscan (CVD) | Adjust the overscan amount for an input video signal within the range of 0% to 5%*. The size of the border area displayed on the projection screen depends on the setting value. A smaller value results in a wider border area as shown below.  |
| Image Adjustment 2 → Restore Menu Defaults (RCVD) | Return all of the items in the "Image Adjustment 2" main menu to their initial defaults for the currently projecting image source. |
| Volume Adjustment → Volume | See "To adjust the volume level (VOLUME)" (page 49) for more information. |
| Volume Adjustment → Restore Menu Defaults | Return the Volume setting to its initial default for the currently projecting image source. |
| Screen Settings → Keystone Correction | Use this sub-menu to perform vertical keystone correction of the projected image. |
| Screen Settings → Aspect Ratio (RCVHD) | Select an aspect ratio setting for the projected image. See "To change the aspect ratio of the projected image (ASPECT)" (page 51) for more information. |

| Use this menu item: | To do this: |
|--|--|
| Screen Settings → Projection Mode | Specify whether projection will be from the front of the screen or the back of the screen. Front*: Select this option to project from the front of the screen. Rear: Select this option to project from the back of the screen. This setting flips the front projected image horizontally. |
| Screen Settings → Ceiling Mount | Set up the projector to be hung from a ceiling. On: Select when the projector is hung from a ceiling. Since the bottom of the projector is upwards, the projected image is flipped both horizontally and vertically. Off*: Select when the projector is used on a desktop. This projects the image assuming that the top of the projector is upwards. |
| Screen Settings → Startup Screen | Specify whether or not a startup screen should be projected whenever projector power is turned on, and select the image to be used as the startup screen. Logo: Projects a logo built into the projector or a user logo (page 74) as the startup screen. None*: Disables startup screen projection. |
| Screen Settings → No Signal Screen | Select one of the following as the projection image whenever there is no input signal being input to the projector: "Blue"* (blue screen), "Black" (black screen), "Logo" (projector built-in logo, or user logo, page 74). |
| Screen Settings → Blank Screen | Select one of the following as the projection image whenever the [BLANK] key is pressed: "Blue"* (blue screen), "Black" (black screen), "Logo" (projector built-in logo, or user logo, page 74). |
| Screen Settings → Restore Menu Defaults | Return all of the items in the "Screen Settings" main menu to their initial defaults for the currently projecting image source. |
| Input Settings → COMPUTER Terminal (RC) | Specify the method to be used to identify the COMPUTER terminal input signal. Auto*: Projector automatically identifies the COMPUTER terminal input signal. RGB: Always assumes the COMPUTER terminal input signal is an RGB signal. Component: Always assumes the COMPUTER terminal input signal is a component video signal. |
| Input Settings → Video Signal (V) Input Settings → S-Video Signal (V) (XJ-M Series only) | Specify the method to be used to identify the video signal being input to the projector (XJ-A Series: AV terminal input signal, XJ-M Series: VIDEO terminal or S-VIDEO terminal input signal). Auto*: Projector automatically identifies the video input signal. NTSC, NTSC4.43, PAL, PAL-M, PAL-N, PAL60, SECAM: Always assumes the video input signal is the specified video signal type. |
| Input Settings → Signal Name Indicator | Specify whether the newly selected input signal type should be displayed (On*) or not displayed (Off) when the [INPUT] key is pressed to change the input signal. |
| Input Settings → Restore Menu Defaults | Return all of the items in the "Input Settings" main menu to their initial defaults for the currently projecting image source. |
| Option Settings 1 → Auto Keystone Correction | Turn auto keystone correction on (On*) or off (Off). |
| Option Settings 1 → Auto Adjust (R) | Specify whether the projector should detect the RGB input signal type (resolution, frequency) and adjust the projection image accordingly. On*: Auto Adjust enabled. Off: Auto Adjust disabled. |
| Option Settings 1 → Eco Mode | See "Eco Mode (ECO)" (page 53). |
| Option Settings 1 → Auto Power Off | Specify the amount of time of projector operation and input signal inactivity to be allowed before Auto Power Off is triggered to turn off projector power automatically. Auto Power Off can be disabled, if you want. 5 min, 10 min*, 15 min, 20 min, 30 min: Time until Auto Power off is triggered. Off: Disables Auto Power Off. |

| Use this menu item: | To do this: |
|--|--|
| Option Settings 1 → Password | See “Password Protection” (page 62). |
| Option Settings 1 → Direct Power On | Enable (On) and disable (Off*) projector auto power on as soon as the projector’s AC adapter is plugged into a power outlet. |
| Option Settings 1 → Language | <p>Specify the display language. English, French, German, Italian, Spanish, Swedish, Portuguese, Dutch, Norwegian, Polish, Finnish, Czech, Turkish, Russian, Chinese (Simplified), Chinese (Traditional), Korean, Japanese, Thai, Indonesian, Malay, Vietnamese, Lithuanian</p> <p> Important!</p> <ul style="list-style-type: none"> ● USB Model Users When using certain USB model functions, some menus and messages may be displayed in English, regardless of the language selected here. |
| Option Settings 1 → Restore Menu Defaults | Return all of the items in the “Option Settings 1” main menu to their initial defaults for the currently projecting image source. |
| Option Settings 2 → Zoom Memory (XJ-A Series only) | Specify whether the projector should remember the current zoom (projected image size) setting when you press the [⏻] (Power) key to turn off projector power. Select “On*” to have the projector remember the current zoom setting when the [⏻] (Power) is pressed to turn off power and restore it the next time power is turned on. |
| Option Settings 2 → Plug and Play  | <p>Specify whether the projector input source should switch automatically (Plug and Play: On*) when a supported external USB device is connected to the projector’s USB-A port.</p> <p> Note</p> <ul style="list-style-type: none"> ● Regardless of the setting of this item, plug-and-play is disabled while the projector is in the 3D input mode. See “3D Input Mode (XJ-M Series Only)” on page 16 for information. |
| Option Settings 2 → Audio Out | <p>Use this sub-menu to specify whether audio input from the input sources below should be output to the speaker (Speaker*) or output to an external destination (Line)*1.</p> <ul style="list-style-type: none"> ● File Viewer (Movie playback audio) ● Wireless or Network (Video stream projection movie audio) ● USB Display ● HDMI <p>*1 When Line is specified, an XJ-A Series projector will output audio from its AV terminal, while an XJ-M Series projector will output from its AUDIO OUT terminal.</p> |
| Option Settings 2 → High Altitude | <p>Turn the high-altitude fan speed setting on or off in accordance with the altitude of the area where you are using the projector.</p> <p>On: Select this setting when using the projector in a high altitude (1,500 to 3,000 meters / 5,000 to 10,000 feet above sea level) area where air is thin. This setting increases cooling efficiency.</p> <p>Off*: Select this setting at normal altitudes (up to 1,500 meters / 5,000 feet).</p> <p> Important!</p> <ul style="list-style-type: none"> ● Do not use this projector at altitudes greater than 3,000 meters (10,000 feet) above sea level. |
| Option Settings 2 → Control Panel Lock | <p>Disable projector unit key operations.</p> <p>See “Control Panel Lock” (page 65) for more information.</p> |

| Use this menu item: | To do this: |
|--|--|
| Option Settings 2 → Closed Caption (V) | <p>Use this sub-menu to specify whether to display closed captions when projecting a video signal that includes them.</p> <p>Off*: Closed captions not displayed.</p> <p>CC1, CC2, CC3, CC4: Indicates the current closed caption output setting (CC1, CC2, CC3, and CC4).</p> <p> Note</p> <ul style="list-style-type: none"> ● Keystone correction does not affect displayed closed caption text. |
| Option Settings 2 → Timer Function | Display the timer function menu. For details, see “Using the Presentation Timer (TIMER)” (page 54). |
| Option Settings 2 → Restore Menu Defaults | Return all of the items in the “Option Settings 2” main menu to their initial defaults for the currently projecting image source. |
| Multimedia Settings → Autorun USB | Specify whether to use (Enable*) or not use (Disable) the autorun function. For details, see “Autorun” (page 34). |
| Multimedia Settings → Functions USB (F) | Display the same menu (Function Menu) that appears when the remote controller’s [FUNC] key is pressed. |
| Multimedia Settings → Internal Storage Function USB (RCVHD) | Access projector internal memory from a computer. For details, see “To copy files from a computer to projector internal memory” (page 19). |
| Network Settings USB | Access projector wireless LAN connection setting and network setting items. For details, see the separate “Network Function Guide”. |
| Operational Info (RCVHDFI) | Display the projector information below. Input Signal, Signal Name, Resolution, Horizontal Frequency, Vertical Frequency, Scan System, Light Time, Version (projector ROM version) |
| Restore All Defaults → Unit Operating Time | Display the cumulative operating time of this unit. This time cannot be initialized. |
| Restore All Defaults → Restore All Defaults | Initialize all Setup Menu item settings, except for those below. Option Settings 1 → Language, Option Settings 1 → Power On Password, Operational Info → Light Time, Operational Info → Version, Restore All Defaults → Unit Operating Time |

Password Protection

The operations described below can be password protected on the projector. You can have only one password assigned to the projector at any time, and the same password is used for operations.

● Projector startup protection

The projector can be configured so a dialog box prompting input of the password is displayed whenever the projector is turned on. In this case, further operation of the projector is not possible unless the correct password is input. This protects against unauthorized use of the projector.

● Using projector internal storage

Attempting to access the projector internal storage function (page 19) from the Setup Menu causes a password input dialog box to appear. This protects against inadvertent and unauthorized deletion or replacement of files in projector internal memory.

Use the “Power On Password” and “Internal Storage Password” settings to turn password protection for the above operations on or off individually.

Using the Password Feature

Note the following precautions whenever you use the password feature.

- The password feature protects against unauthorized use of the projector. Note that it is not an anti-theft measure.
- You will need to enter the initial factory default password the first time you use the projector after turning on the password feature. Change the initial factory default password to a different one of your choice as soon as possible after turning on the password feature.
- Remember that password operations are always performed using the remote controller, so you should take care not to lose or misplace the remote controller.
- Also note that you will not be able to input the password if the remote controller batteries are dead. Replace the remote control batteries as soon as possible after it starts to go low.

If you forget your password...

If you forget the password, you will need to bring the following two items to your CASIO distributor to have the password cleared. Note that you will be charged to have the password cleared.

1. Personal identification (original or copy of your driver’s license, employee I.D., etc.)
2. Projector unit

Note that your CASIO distributor will not be able to clear the password of your projector unless you bring both of the items listed above.

Also, keep the projector’s warranty in a safe place.



Important!

- Having your password cleared using the procedure described above will return all of the settings of your projector, except for the Light Time, to their initial factory defaults.

Keep a written record of your password!

You will not be able to use the projector if you forget its password. We strongly suggest that you keep a written or other type of record of the password so you can look it up when necessary.

To change the password

1. Press the [MENU] key to display the setup menu.
2. Use the [▼] key to select “Option Settings 1”, and then press the [ENTER] key.
3. Use the [▼] key to select “Password”, and then press the [ENTER] key.
 - This will display a dialog box prompting you to enter the current password.

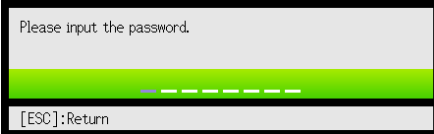

4. Enter the current password.
 - The password of your projector is not really a “word” made up of letters, but rather a sequence of remote controller key inputs.
 - If the projector is still protected by the factory default password, perform the key operation shown below to enter it.



5. After entering the current password, press the [ENTER] key.
 - This displays the Password screen.
6. Use the [▼] key to select “Change Password”, and then press the [ENTER] key.
 - This will display a dialog box prompting you to enter the new password.
7. Enter a key sequence up to eight key operations long.
 - You can use any of the following keys as part of your password key sequence.
[INPUT], [MENU], [BLANK], [FREEZE], [ECO], [VOLUME +], [VOLUME -], [D-ZOOM +], [D-ZOOM -], [KEystone +], [KEystone -], [▲], [▼], [◀], [▶], [TIMER], [AUTO], [ASPECT], [FUNC]
8. After entering the new password, press the [ENTER] key.
 - This will display a dialog box prompting you to enter the same password again.
9. Re-enter the same password key sequence you entered in step 7 and then press the [ENTER] key.
 - The message “Your new password has been registered.” indicates that the password has been changed. Press the [ESC] key.
 - If the password you entered in this step is different from the one you entered in step 7, the message “The password you input is wrong.” appears. Press the [ESC] key to return to step 7.

To change the power on password setting

- 1.** Perform steps 1 through 5 under “To change the password” (page 63) and display the Password screen.
- 2.** After confirming that “Power On Password” is selected, use the [◀] and [▶] keys to select either the “On” or “Off” setting.
 - Changing the setting from “Off” to “On” will cause the “Prompt for password when power is turned on?” dialog box to appear. Press the [ENTER] key to confirm that you want to turn on power on password protection, or [ESC] to exit the dialog box without changing the setting.
- 3.** After you are finished, press the [MENU] key to exit the setup menu.

To change the projector internal storage function password

- 1.** Perform steps 1 through 5 under “To change the password” (page 63) and display the Password screen.
- 2.** Press the [▼] key to select “Internal Storage Password”.
- 3.** Use the [◀] and [▶] keys to select “On” or “Off”.
 - Changing the setting from “Off” to “On” will cause the “Prompt for password when an internal storage operation is performed?” dialog box to appear. Press the [ENTER] key to confirm that you want to turn on internal storage password protection, or [ESC] to exit the dialog box without changing the setting.
- 4.** After you are finished, press the [MENU] key to exit the setup menu.

Control Panel Lock

Control panel lock disables (locks) all of the projectors keys, except for the [⏻] (Power) key. This limits projector operation to the remote controller, which protects against inadvertent mis-operation.

To lock the control panel

1. Press the [MENU] key to display the setup menu.
2. Use the [▼] key to select “Option Settings 2”, and then press the [ENTER] key.
3. Use the [▼] key to select “Control Panel Lock”.
4. Use the [◀] key to select “On”.
5. When the confirmation dialog box appears, press the [ENTER] key.
 - This disables (locks) all projector keys except for the [⏻] (Power) key.
6. After you are finished, press the [MENU] key to exit the setup menu.



Note

-
- Even if the control panel is locked, you can clear a warning message (page 68) that appears on the projection screen by pressing the projector’s [ESC] key.

To unlock the control panel

Perform either of the following operations.

- On the projector, hold down the [▼] key until the message “Control panel was unlocked.” appears.
- To use the remote controller to unlock the control panel, perform the procedure under “To lock the control panel” above. In step 4, press the [▶] key of the remote controller to select “Off” and then press the [MENU] key.

Cleaning the Projector

Make it a habit to clean the projector at regular intervals as described in this section. Before cleaning the projector, be sure to unplug it from the power outlet and make sure it is cooled down completely.

Cleaning the Projector Exterior

Wipe the exterior of the projector with a soft cloth that has been moistened in a weak solution of water and a mild neutral detergent. Be sure to wring all excess moisture from the cloth before wiping. Never use benzene, alcohol, thinner, or any other volatile agent for cleaning.

Cleaning the Lens

Carefully wipe the lens with a commercially available lens cloth or optical lens paper, like those for eyeglasses or camera lenses. When cleaning the lens, do not apply undue force and take care to avoid damaging the lens.

Cleaning Vents

Dust and dirt tend to collect around the intake vents. Because of this, you should use a vacuum cleaner to clean away accumulated dust and dirt periodically as shown below.

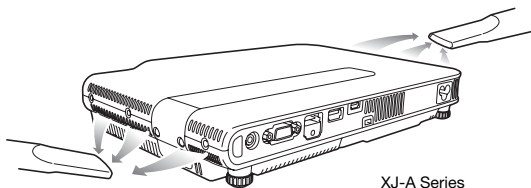

XJ-A Series

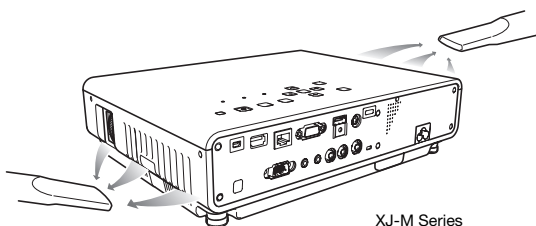

XJ-M Series



Important!

- Continued use of the projector after dust has accumulated around the intake vents can cause overheating of internal components and lead to malfunction.
- Certain operating conditions also can cause dirt and dust to accumulate around the projector's exhaust vents (XJ-A Series: exhaust vents, XJ-M Series: exhaust and airflow vents). If this happens, use the same procedure as that described above to clean the exhaust vents.

Troubleshooting

Indicators

Indicators keep you informed about the current operational status of the projector. The following shows what the indicators look like when operation is normal.

| When the indicators appear like this: | | | It means this: |
|---------------------------------------|---------------------|--------------------|--|
| POWER/ STANDBY ● Red | LIGHT ● Amber | TEMP ● Amber | You have just plugged the AC power cord into a power outlet. Wait until the projector enters the standby state (see below) before trying to turn on power. |
| ● Red | ○ | ○ | Standby state: The AC power cord is plugged in and the projector is in standby. |
| ◎ Green | ● Amber | ● Amber | Projector is warming up after being turned on. |
| ● Green | ○ | ○ | Projector is on and standing by for use. "Off" is selected for the projector's Eco Mode (page 53) setting. |
| ● Green | ● Green | ○ | Projector is on and standing by for use. "On (Auto)" or "On (Manual)" is selected for the projector's Eco Mode (page 53) setting. |
| ◎ Red | ○ | ○ | Projector is performing internal power down processes. |

● : Lit ◎ : Flashing ○ : Unlit

When a warning message appears on the projection screen, or when the POWER/STANDBY, LIGHT, and TEMP indicators are lit or flashing in a pattern other than those shown above, it means that a projector error has occurred. For details, see "Error Indicators and Warning Messages" (below).

Error Indicators and Warning Messages

Warning messages and indicators let you know what the problem is when a projector error occurs.

- When an error occurs, wait until the fan stops before unplugging the AC power cord. If you unplug the AC power cord while the fan is still operating, an error may occur when you plug the AC power cord back in.
- Press the [ESC] key to clear the warning message.

| Indicator/Error Message | Description and Required Action |
|--|---|
| <p>POWER : Green steady LIGHT : – TEMP : – Message : Internal temperature is too high. Check projector air vents for blockage.</p> | <p>The projector's internal temperature is very high. Perform the following steps.</p> <p>① Check for any blocking of the projector's intake vents and exhaust vents, and make sure that there is sufficient space around the projector. See "Setup Precautions" (page 10).</p> <p>② If there is dust accumulated around the intake vents and/or exhaust vents, turn off the projector and remove it. See "Cleaning the Projector" (page 66).</p> |
| <p>POWER : Green steady → Red steady LIGHT : – TEMP : – Message : Internal temperature is too high. The projector will turn off.</p> | <p>Power has turned off automatically due to internal overheating. Perform the following steps.</p> <p>① Check for any blocking of the projector's intake vents and exhaust vents, and make sure that there is sufficient space around the projector. See "Setup Precautions" (page 10).</p> <p>② If there is dust accumulated around the intake vents and/or exhaust vents, remove it. See "Cleaning the Projector" (page 66).</p> <p>If there is no problem with the projector's vents, confirm that the POWER/STANDBY indicator is lit red (without flashing), and then turn power back on again. If the error occurs again when you turn power back on, contact your retailer or nearest authorized CASIO Service Center.</p> |
| <p>POWER : Red steady LIGHT : Red steady TEMP : Red steady Message : There is a problem with the fan. The projector will turn off.</p> | <p>Power has turned off automatically due to a fan problem. Confirm that the POWER/STANDBY indicator is lit red (without flashing) and that the fan has stopped. After checking the POWER/STANDBY indicator, disconnect the power cord from the projector and wait for all of the projector's indicators to go out. Next, reconnect the power cord and turn projector power back on.</p> <p>If the error occurs again when you turn power back on, contact your retailer or nearest authorized CASIO Service Center.</p> |
| <p>POWER : Red steady LIGHT : – TEMP : Red steady Message : A system problem has occurred. The projector will turn off.</p> | <p>Power has turned off automatically due to a system problem. After confirming that the POWER/STANDBY indicator is lit red (without flashing), disconnect the power cord from the projector and wait for all of the projector's indicators to go out. Next, reconnect the power cord and turn the projector back on.</p> <p>If the error occurs again when you turn power back on, contact your retailer or nearest authorized CASIO Service Center.</p> |
| <p>POWER : Green steady LIGHT : – TEMP : – Message : There is some problem with the system. The audio function may not operate correctly.</p> | <p>A system problem has occurred, which may cause problems with some functions. Turn off the projector, disconnect the power cord from the projector and wait for all of the projector's indicators to go out. Next, reconnect the power cord and turn the projector back on.</p> <p>If the error occurs again when you turn power back on, contact your retailer or nearest authorized CASIO Service Center.</p> |

| Indicator/Error Message | Description and Required Action |
|---|---|
| POWER : Green steady LIGHT : – TEMP : – Message : Some problem occurred with the USB port or LAN terminal. | The USB connection or LAN connection was terminated because of a problem with the USB port or LAN terminal. Turn off the projector and then turn it back on again. If the error occurs again when you turn power back on, contact your retailer or nearest authorized CASIO Service Center. |
| POWER : Green steady LIGHT : – TEMP : – Message : Zoom and focus cannot be performed for some reason. Try turning the projector off and then back on again. If this message reappears, request servicing. | Zoom and focus cannot be performed due to some trouble in the optical drive circuit. Turn off the projector and then turn it back on again. If the error occurs again when you turn power back on, contact your retailer or nearest authorized CASIO Service Center. |
| POWER : Red steady LIGHT : – TEMP : Red steady Message : – | The projector was turned off automatically due to some problem that was probably caused by external digital noise or some other reason. Confirm that the POWER/STANDBY indicator is lit red (without flashing). After checking the POWER/STANDBY indicator, disconnect the power cord from the projector and wait for all of the projector's indicators to go out. Next, reconnect the power cord and turn projector power back on. If the error occurs again when you turn power back on, contact your retailer or nearest authorized CASIO Service Center. |
| POWER : Red steady LIGHT : Red flashing (0.5-second interval) TEMP : Red flashing (0.5-second interval) Message : – | The projector was turned off automatically because the light source unit turned off or did not turn on. After confirming that the POWER/STANDBY indicator is lit red (without flashing), unplug the power cord. Wait for a short while and then plug it back in and turn on the projector again. If the error occurs again when you turn power back on, contact your retailer or nearest authorized CASIO Service Center. |
| POWER : Red steady LIGHT : Not lit or red flashing TEMP : Red flashing (2-second interval) Message : – | Power has turned off automatically due to a projector memory error. Confirm that the POWER/STANDBY indicator is lit red (without flashing). After checking the POWER/STANDBY indicator, disconnect the power cord from the projector and wait for all of the projector's indicators to go out. Next, reconnect the power cord and turn projector power back on. If the error occurs again when you turn power back on, contact your retailer or nearest authorized CASIO Service Center. |
| POWER : Red steady LIGHT : – TEMP : Amber flashing (1-second interval) Message : – | Power has turned off automatically because the light source unit cover is open. Perform the following steps. ① After confirming that the POWER/STANDBY indicator is lit red (without flashing), disconnect the power cord from the projector. ② Check to make sure that the light source unit cover is closed. ③ Plug the power cord back in and turn the projector back on again. If the error occurs again when you turn power back on, contact your retailer or nearest authorized CASIO Service Center. |

Projector Troubleshooting

Check the following items whenever you experience any problem with the projector.

| Problem | Cause and Recommended Action |
|---|--|
| Power does not turn on. | <ul style="list-style-type: none"> ● If the POWER/STANDBY indicator is not lit, the AC power cord is not connected correctly. Connect the AC power cord correctly. ● If the TEMP or LIGHT indicator remains flashing or lit, it means some type of error has occurred. See “Error Indicators and Warning Messages” (page 68). |
| No image is projected or the projected image is abnormal. | <ul style="list-style-type: none"> ● The computer or video device connected to the projector is not turned on or it is not outputting a video signal. Make sure the connected computer or video device is turned on, and perform the required operation on it to output a video signal. ● The correct output source is not selected on the projector. On the projector, select the correct input source that corresponds to the connected device. ● Images may not project correctly when you have the component output terminal of a video device connected to the COMPUTER terminal of the projector. With an XJ-A Series projector, connect the video device to the AV terminal. For an XJ-M Series projector, connect to the VIDEO or S-VIDEO terminal. |
| Image color or display is very abnormal. | <p>The wrong option (“Component” or “RGB”) may be selected for the “Input Settings → COMPUTER Terminal” setting on the setup menu. The image will not be projected correctly if “Component” is selected while the projector’s COMPUTER terminal is connected to the RGB output terminal of a computer, or if “RGB” is selected while the projector’s COMPUTER terminal is connected to the component video output terminal of a video device. On the setup menu, select “Auto” for the “Input Settings → COMPUTER Terminal” setting. See page 59.</p> |
| I can’t understand messages or menus because they are the wrong language. | <p>Perform the following operation to select the language you want. See page 60.</p> <ol style="list-style-type: none"> 1. Press the [MENU] key to display the setup menu. 2. If the input signal is HDMI, press [▼] four times and then press the [ENTER] key. If the input signal is not HDMI, press [▼] five times and then press the [ENTER] key. 3. Press [▲] twice and then press the [ENTER] key to display the language selection menu. 4. Use the [▼] and [▲] keys to move the highlighting to the language you want to select and then press the [ENTER] key. 5. Press the [MENU] key to exit the setup menu. |
| No sound | <ul style="list-style-type: none"> ● The projector’s volume level setting may be too low or muted. Press the remote controller [VOLUME] key and then use [◀] and [▶] to adjust the volume level. See page 49. ● The volume level setting of the device connected to the projector is too low or the other device is not outputting audio. Adjust the volume level of the connected device. ● The audio output of the connected device may not be connected correctly to the projector’s AV terminal (XJ-A Series) or AUDIO IN terminal (XJ-M Series). Check the connection. See “Connecting Projector Cables” (page 11). ● When the input source is HDMI, File Viewer, Wireless, Network or USB Display, “Line” may be selected for the “Option Settings 2 → Audio Out” setting on the setup menu. Change the “Audio Out” setting to “Speaker”. See page 60. |
| Strange color | <p>The input signal may not match projector settings. Try doing the following.</p> <ul style="list-style-type: none"> – Use the [BRIGHT] key to adjust image brightness. – Use the [COLOR MODE] key to change the color mode. – On the setup menu, use “Image Adjustment 1 → Color Balance” to adjust the projection image color balance. |

| Problem | Cause and Recommended Action |
|---|--|
| Text is blurry. | <ul style="list-style-type: none"> ● The image may be out of focus. Adjust image focus. ● The current frequency and/or phase setting do not match the input signal. (Applies only when the input source is an RGB signal.) Press the [AUTO] key to execute an automatic adjustment operation. ● On the setup menu, perform the “Image Adjustment 2 → Frequency” and “Image Adjustment 2 → Phase” adjustments. (Applies only when the input source is an RGB signal.) See page 58. |
| The message “Please input the password.” appears and further operation is not possible. | The “Option Settings 1 → Power On Password” setting on the setup menu is turned on, so the projector is password protected. Input the correct password, and then press the [ENTER] key. See page 62. |
| The remote controller does not work. | <ul style="list-style-type: none"> ● The remote controller batteries may be dead. Replace the batteries. ● The remote controller may be too far from the projector. Make sure the remote controller is within about five meters from the projector when performing operations. |
| The TEMP or LIGHT indicator is flashing or lit. | An error occurred. See “Error Indicators and Warning Messages” (page 68). |
| The light source unit does not light. | The light source unit has reached the end of its service life or it is malfunctioning. Contact your original dealer or authorized CASIO service center for replacement. |
| Power suddenly turns off and the projector restarts. | The projector periodically performs a self-check operation. In rare cases, the result of a self-check may cause the projector to restart automatically. This normally does not indicate malfunction, so you can continue using the projector. However, malfunction may be indicated if successive restarts keep occurring. If this happens contact your original dealer or authorized CASIO service center. |



Important!

- Try performing the following steps, which may or may not return the projector to normal operation.
 1. Unplug the AC power cord and wait for at least 10 minutes.
 2. Plug the power cord back in and turn the projector back on again.
- If normal operation does not resume after you perform the above steps, take the projector to your retailer or authorized CASIO service center.

Appendix

Connecting to a Component Video Output

This section explains how to establish a component video connection between the projector and a video device.

- Component video output terminals come in 3-terminal sets: Y-Cb-Cr or Y-Pb-Pr. Be sure to match the colors of the plugs on a component video cable with the colors of the terminals (Green: Y; Blue: Cb/Pb; Red: Cr/Pr).
- Note that connection only to an analog component video output terminal is supported. Connection to a digital output terminal is not supported.

XJ-A Series

Projector

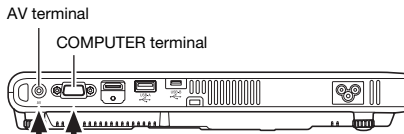

Video device

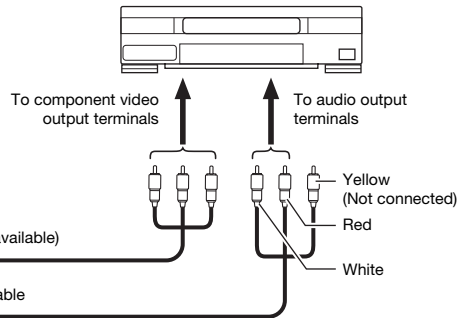

Component video cable (commercially available)

Bundled special AV cable

XJ-M Series

Projector

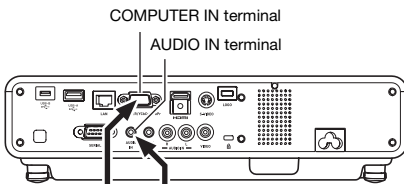

Video device

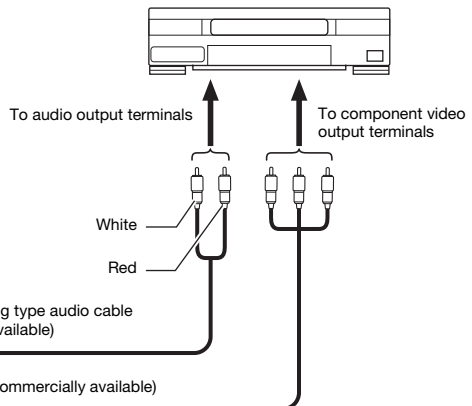

Stereo mini plug ↔ Pin plug type audio cable (commercially available)

Component video cable (commercially available)

Connecting to a Composite Video Output or S-Video Output (XJ-M Series Only)

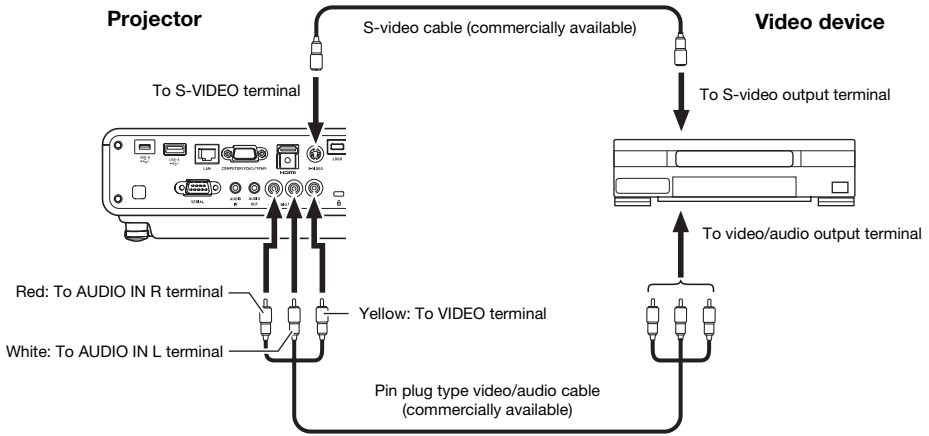

Note

- Note that regardless of whether the image being projected is being input via the projector's S-VIDEO terminal or VIDEO terminal, the projector outputs audio that is input via the projector's AUDIO IN L/R terminals.

Updating Firmware and Transferring a User Logo

The projector's firmware (software in the projector flash ROM) can be updated and user logo images can be transferred to the projector from a computer connected to the projector's LOGO port (USB port for ROM updating) with a USB cable.

To connect the projector's LOGO port with a computer's USB port

Use a commercially available USB cable to connect the projector's LOGO port to the computer's USB port.

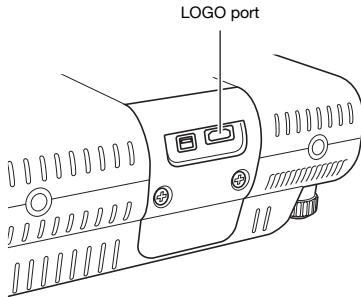

XJ-A Series

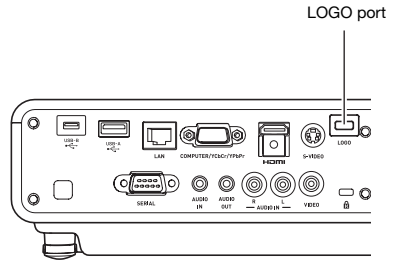

XJ-M Series

Use a USB cable with a micro USB plug on one end for connection to the projector's LOGO port, and a plug on the other end with a shape that is compatible with the computer USB port.



Note

- For details about how to update the firmware and how to transfer a user logo to the projector, see the "User Logo Transfer Guide" and the "Projector Firmware Update Guide", which are available at the CASIO website.

Hanging the Projector from a Ceiling

The projector can be hung from a ceiling. When doing so, the projector should be turned upside down, and secured to the ceiling.

For full details, contact the retailer where you purchased the projector.



Important!

- When hanging the projector from a ceiling, make sure that it is at least one meter away from fire detectors, fire alarms, and other fire protection devices. Locating the projector too close to a fire protection device creates the risk of mis-operation of the device due to warm air exhausted from the projector. Also, avoid locating the projector close to fluorescent lights or other strong light sources. Bright light can shorten the operating range of the remote controller or even make remote control impossible. When selecting a location for the projector, be sure to test for proper operation of the remote controller.
- The vertical and horizontal orientation of the projected image is reversed from the normal configuration when projecting from a projector hung from the ceiling. You need to change the setup of the projector in order to correct for this. For details, see “Screen Settings → Ceiling Mount” (page 59) under “Setup Menu Settings”.

Projection Distance and Screen Size

- The projection distance values below are for reference when setting up the projector.
- “h” in the illustration and table indicates the distance between the center of the projector lens and the bottom edge of the projection screen.

XJ-A Series

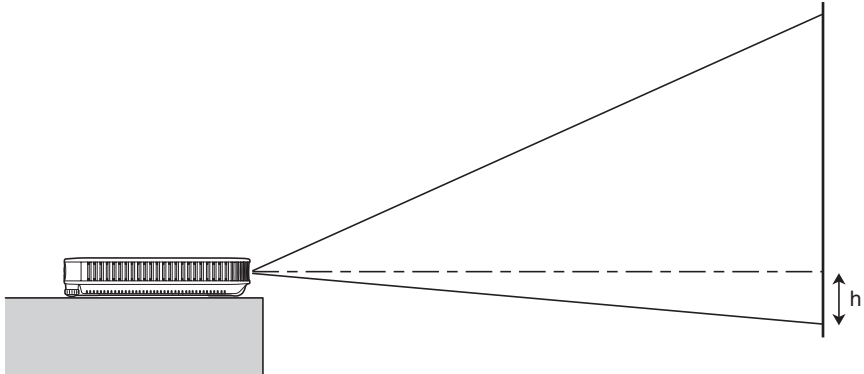

| Projection Size | | Approximate Projection Distance | | | | | |
|-----------------|---------------|---------------------------------|-----------------------------|---|---------------------------------|-----------------------------|---------------|
| | | XJ-A142/XJ-A147 | | | XJ-A242/XJ-A247/XJ-A252/XJ-A257 | | |
| Screen Size | Diagonal (cm) | Minimum Distance (m / feet) | Maximum Distance (m / feet) | h | Minimum Distance (m / feet) | Maximum Distance (m / feet) | h (cm / inch) |
| 40 | 102 | 1.1 / 3.61 | 2.2 / 7.22 | 0 | 1.0 / 3.28 | 1.9 / 6.23 | 9 / 3.54 |
| 60 | 152 | 1.7 / 5.58 | 3.4 / 11.15 | 0 | 1.4 / 4.59 | 2.8 / 9.19 | 14 / 5.51 |
| 80 | 203 | 2.3 / 7.55 | 4.5 / 14.76 | 0 | 1.9 / 6.23 | 3.8 / 12.47 | 18 / 7.09 |
| 100 | 254 | 2.8 / 9.19 | 5.6 / 18.37 | 0 | 2.4 / 7.87 | 4.8 / 15.75 | 23 / 9.06 |
| 150 | 381 | 4.3 / 14.11 | 8.5 / 27.89 | 0 | 3.6 / 11.81 | 7.2 / 23.62 | 34 / 13.39 |
| 200 | 508 | 5.7 / 18.70 | 11.3 / 37.07 | 0 | 4.8 / 15.75 | 9.6 / 31.50 | 45 / 17.72 |

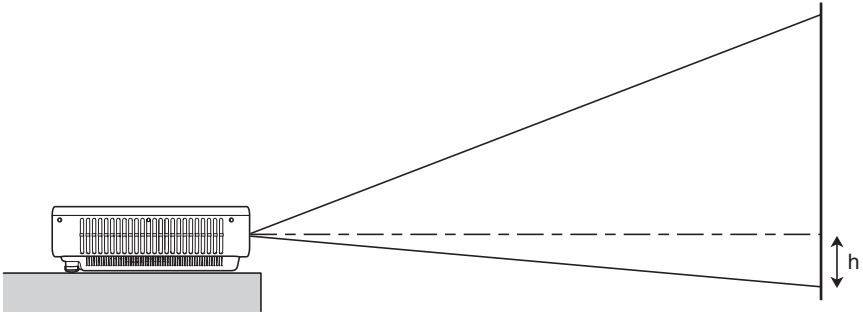

The following table shows the relationship between the distance and projected image size.



| Projection Size | | Approximate Projection Distance | | | | | |
|-----------------|---------------|-------------------------------------|-----------------------------|---|-------------------------------------|-----------------------------|---------------|
| | | XJ-M141/XJ-M146/ XJ-M151/XJ-M156 | | | XJ-M241/XJ-M246/ XJ-M251/XJ-M256 | | |
| Screen Size | Diagonal (cm) | Minimum Distance (m / feet) | Maximum Distance (m / feet) | h | Minimum Distance (m / feet) | Maximum Distance (m / feet) | h (cm / inch) |
| 30 | 76 | 1.0 / 3.28 | 1.5 / 4.92 | 0 | - | - | - |
| 35 | 89 | - | - | - | 1.0 / 3.28 | 1.5 / 4.92 | 8 / 3.15 |
| 40 | 102 | 1.3 / 4.27 | 2.0 / 6.56 | 0 | 1.1 / 3.61 | 1.7 / 5.58 | 9 / 3.54 |
| 60 | 152 | 2.0 / 6.56 | 3.0 / 9.84 | 0 | 1.7 / 5.58 | 2.5 / 8.2 | 13 / 5.12 |
| 80 | 203 | 2.7 / 8.86 | 4.0 / 13.12 | 0 | 2.3 / 7.55 | 3.4 / 11.15 | 18 / 7.09 |
| 100 | 254 | 3.4 / 11.15 | 5.0 / 16.4 | 0 | 2.9 / 9.51 | 4.2 / 13.78 | 23 / 9.06 |
| 150 | 381 | 5.0 / 16.4 | 7.4 / 24.28 | 0 | 4.3 / 14.11 | 6.3 / 20.67 | 34 / 13.39 |
| 200 | 508 | 6.8 / 22.31 | 9.9 / 32.48 | 0 | 5.8 / 19.03 | 8.4 / 27.56 | 45 / 17.72 |
| 300 | 762 | 10.2 / 33.46 | 14.9 / 48.88 | 0 | 8.7 / 28.54 | 12.6 / 41.34 | 67 / 26.38 |

Aspect Ratio Setting and Projection Image



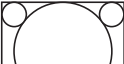

The following shows how images are projected in accordance with the type of the input signal and the aspect ratio setting of the projector.

XJ-A242/XJ-A247/XJ-A252/XJ-A257/XJ-M241/XJ-M246/XJ-M251/XJ-M256

Input source: RGB or HDMI (PC)





| Input Signal | Normal | Full | 16:9 | 4:3 | True |
|---|--------|------|------|-----|------|
|  <p>SVGA (800 × 600)</p> | | | | | |
|  <p>XGA (1024 × 768)</p> | | | | | |
|  <p>WXGA (1280 × 800)</p> | | | | | |
|  <p>SXGA (1280 × 1024)</p> | | | | | |

Input source: Video, component or HDMI (DTV)



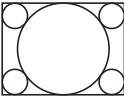
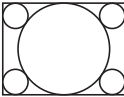
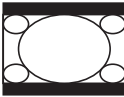
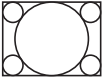
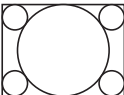
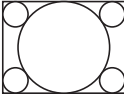
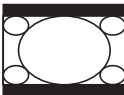
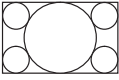

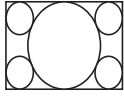

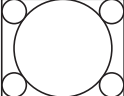
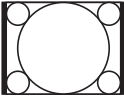
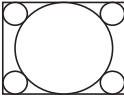
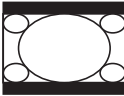
| Input Signal | Normal | 16:9 | 4:3 | Letter Box |
|--|--------|------|-----|------------|
|  <p>4:3 Aspect Image</p> | | | | |
|  <p>Squeezed Image</p> | | | | |
|  <p>Letter Box Image</p> | | | | |
|  <p>16:9 Aspect Image</p> | | | | |

XJ-A142/XJ-A147/XJ-M141/XJ-M146/XJ-M151/XJ-M156

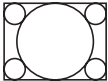
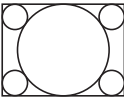
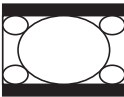
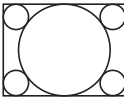
Input source: RGB or HDMI (PC)

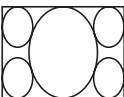
| Input Signal | Normal | Full | 16:9 |
|---|---|---|---|
|  SVGA (800 × 600) |  |  |  |
|  XGA (1024 × 768) |  |  |  |
|  WXGA (1280 × 800) |  |  |  |
|  SXGA (1280 × 1024) |  |  |  |

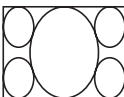
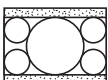
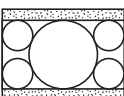
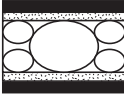
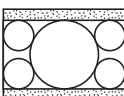
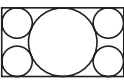
Input source: Video, component or HDMI (DTV)

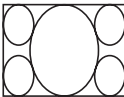
| Input Signal | Normal | 16:9 | 4:3 |
|--|---|---|---|
|  4:3 Aspect Image |  |  |  |
|  Squeezed Image |  |  |  |
|  Letter Box Image |  |  |  |
|  16:9 Aspect Image |  |  |  |

Supported Signals



Important!

- Even if a signal is listed in the table below, it does not guarantee that you will be able to display its images correctly.

RGB Signal

| | Signal Name | Resolution | Horizontal Frequency (kHz) | Vertical Frequency (Hz) |
|----------------|----------------|-------------|----------------------------|-------------------------|
| VESA | 640 × 480/60 | 640 × 480 | 31.5 | 60 |
| | 640 × 480/72 | 640 × 480 | 37.9 | 73 |
| | 640 × 480/75 | 640 × 480 | 37.5 | 75 |
| | 640 × 480/85 | 640 × 480 | 43.3 | 85 |
| | 800 × 600/56 | 800 × 600 | 35.2 | 56 |
| | 800 × 600/60 | 800 × 600 | 37.9 | 60 |
| | 800 × 600/72 | 800 × 600 | 48.1 | 72 |
| | 800 × 600/75 | 800 × 600 | 46.9 | 75 |
| | 800 × 600/85 | 800 × 600 | 53.7 | 85 |
| | 1024 × 768/60 | 1024 × 768 | 48.4 | 60 |
| | 1024 × 768/70 | 1024 × 768 | 56.5 | 70 |
| | 1024 × 768/75 | 1024 × 768 | 60.0 | 75 |
| | 1024 × 768/85 | 1024 × 768 | 68.7 | 85 |
| | 1152 × 864/75 | 1152 × 864 | 67.5 | 75 |
| | 1280 × 768/60 | 1280 × 768 | 47.8 | 60 |
| | 1280 × 800/60 | 1280 × 800 | 49.7 | 60 |
| | 1280 × 960/60 | 1280 × 960 | 60.0 | 60 |
| | 1280 × 1024/60 | 1280 × 1024 | 64.0 | 60 |
| | 1280 × 1024/75 | 1280 × 1024 | 80.0 | 75 |
| | 1280 × 1024/85 | 1280 × 1024 | 91.1 | 85 |
| | 1366 × 768/60 | 1366 × 768 | 47.7 | 60 |
| | 1400 × 1050/60 | 1400 × 1050 | 65.3 | 60 |
| 1440 × 900/60 | 1440 × 900 | 55.9 | 60 | |
| 1600 × 1200/60 | 1600 × 1200 | 75.0 | 60 | |
| 1680 × 1050/60 | 1680 × 1050 | 65.3 | 60 | |

Component Signal

| | Signal Name | Horizontal Frequency (kHz) | Vertical Frequency (Hz) |
|-------------|-------------|----------------------------|-------------------------|
| HDTV | 1080p/50 | 56.3 | 50 |
| | 1080p/60 | 67.5 | 60 |
| | 720p/50 | 37.5 | 50 |
| | 720p/60 | 45.0 | 60 |
| | 1080i/50 | 28.1 | 50 |
| | 1080i/60 | 33.7 | 60 |
| SDTV | 576p/50 | 31.3 | 50 |
| | 576i/50 | 16.6 | 50 |
| | 480p/60 | 31.5 | 60 |
| | 480i/60 | 15.7 | 60 |

Video Signal

| Signal Name | Horizontal Frequency (kHz) | Vertical Frequency (Hz) |
|-------------|----------------------------|-------------------------|
| NTSC | 15.7 | 60 |
| NTSC4.43 | 15.7 | 60 |
| PAL | 15.6 | 50 |
| PAL-M | 15.7 | 60 |
| PAL-N | 15.6 | 50 |
| PAL60 | 15.7 | 60 |
| SECAM | 15.6 | 50 |

HDMI Signal

| Signal Name | Horizontal Frequency (kHz) | Vertical Frequency (Hz) |
|-------------------|----------------------------|-------------------------|
| 640 × 480/60 | 31.5 | 60 |
| 800 × 600/60 | 37.9 | 60 |
| 1024 × 768/60 | 48.4 | 60 |
| 1280 × 768/60 | 47.8 | 60 |
| 1280 × 800/60 | 49.7 | 60 |
| 1280 × 960/60 | 60 | 60 |
| 1280 × 1024/60 | 64 | 60 |
| 1400 × 1050/60 | 65.3 | 60 |
| SDTV (480p) | 31.5 | 60 |
| SDTV (576p) | 31.25 | 50 |
| HDTV (720p) (50) | 37.5 | 50 |
| HDTV (720p) (60) | 45 | 60 |
| HDTV (1080i) (50) | 28.13 | 50 |
| HDTV (1080i) (60) | 33.75 | 60 |
| HDTV (1080p) (50) | 56.25 | 50 |
| HDTV (1080p) (60) | 67.5 | 60 |

3D Signals (3D Input Mode)

| | Signal Name | Horizontal Frequency (kHz) | Vertical Frequency (Hz) |
|------------------------------|----------------|----------------------------|-------------------------|
| RGB Signal | 640 × 480/60 | 31.5 | 60 |
| | 640 × 480/120 | 61.7 | 120 |
| | 800 × 600/60 | 37.9 | 60 |
| | 800 × 600/120 | 77.2 | 120 |
| | 1024 × 768/60 | 48.4 | 60 |
| | 1024 × 768/120 | 98.8 | 120 |
| | 1280 × 768/60 | 47.8 | 60 |
| | 1280 × 768/120 | 97.4 | 120 |
| | 1280 × 800/60 | 49.7 | 60 |
| | 1280 × 800/120 | 101.6 | 120 |
| Video Signal, S-video Signal | NTSC | 15.7 | 60 |

Projector RS-232C Control

When there is a serial connection between the projector and a computer, you can control the projector using RS-232C commands sent from the computer.

To establish a serial connection between the projector and a computer

Connect the projector and computer as shown in the illustration below.

XJ-A Series

Projector

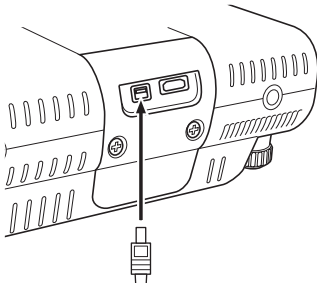

YK-60 special cable (available separately)

Computer

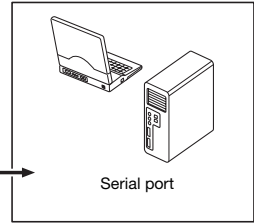

XJ-M Series

Projector

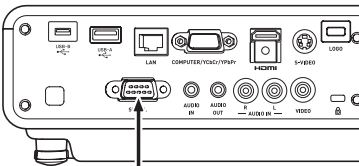

Serial port (RS-232C)

D-Sub 9-pin (female)

D-Sub 9-pin (female)

Commercially available serial cable (cross)

Computer

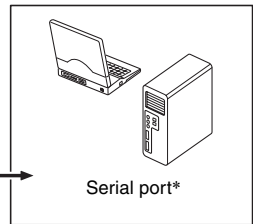

Using Control Commands

This section explains the commands that are used to control the projector from a computer.

Command Send Format

| | | |
|-------------------------------|---|--|
| Communication Protocol | Configure your computer's serial port with the following settings. | |
| | Data Rate | 19200 bps |
| | Data Bit | 8 bit |
| | Parity | None |
| | Stop Bit | 1 bit |
| | Flow Control | None |
| Read Command | Send this command when you want information about the current setup of the data projector. | |
| | Send Format | (<command name>?) |
| | Receive Format | (<applicable command setting range>,<current setting>) |
| | Command Send Example | <p>[[V]O[L]?] sent from the computer to the projector.</p> <p style="text-align: center;">↓</p> <p>[[0]-30,15]] returned from the projector to the computer.</p> |
| Write Command | Send this command to control the data projector (power on/off, etc.) and to write data to it. | |
| | Send Format | (<command name><setting value>) |
| | Command Send Example | <p>[[V]O[L]0] sent from the computer to the projector.</p> <p style="text-align: center;">↓</p> <p>Projector volume setting becomes 0 (mute).</p> |

- See the “Command List” for details about command names and settings.
- All commands use ASCII characters and decimal format integers.
- The projector will return a question mark (?) when it is sent a command it cannot recognize. Also, any command that attempts to set a value that is outside the applicable allowable range will be ignored.
- If the projector is performing a process initiated by a previously sent command, a projector key operation, or a remote controller key operation, send of the next command must wait until the projector completes the previous process.

Command List

- Only the following functions are supported while the projector is turned off. Do not try to send any other command to the projector.
 - Power on/off: Read
 - Power on: Write
 - Get light time: Read
- Input of a valid signal must be in progress in order to use a command to turn on blank screen or change the aspect ratio.

R: Read enabled W: Write enabled

| Function | Command Name | RW | Setting Range |
|---|--------------|----|--|
| Power On/Off: | PWR | RW | 0: Off, 1: On |
| Input Switching: 0: Switches the input source to the COMPUTER terminal and changes the COMPUTER terminal setting to RGB. 1: Switches the input source to COMPUTER terminal and changes the COMPUTER terminal setting to component. 2: Switches the input source to Video. 6: Switches the input source to COMPUTER terminal and changes the COMPUTER terminal setting to Auto. 7: Switches the input source to HDMI. 8: Switches the input source to Wireless (XJ-A Series) / Network (XJ-M Series). 9: Switches the input source to S-video (XJ-M Series only). 11: Switches the input source to File Viewer. 12: Switches the input source to USB Display. 13: Switches the input source to CASIO USB Tool. | SRC | RW | 0: RGB, 1: Component, 2: Video, 6: Auto (RGB/Component), 7: HDMI, 8: Network, 9: S-Video, 11: File Viewer, 12: USB Display, 13: CASIO USB Tool |
| Blank Screen: Switches the blank screen on or off. | BLK | RW | 0: Off, 1: On |
| Volume: Specifies a value to adjust the volume level. This setting is applied to the input source signal that is currently being projected by the projector. | VOL | RW | 0 to 30 |
| Color Mode: Selects the color mode. | PST | RW | 1: Graphics, 2: Theater, 3: Standard, 4: Blackboard, 5: Game |
| Aspect Ratio: Specifies the aspect ratio. | ARZ | RW | 0: Normal, 1: 16:9, 2: 4:3, 3: Letter Box, 4: Full, 5: True, 6: 4:3 (Forced) |
| Zoom Shift (XJ-A Series only): 0: None 1: One step shift towards Wide 2: One step shift towards Tele | OZM | W | 0 to 2 |
| Focus Shift (XJ-A Series only): 0: None 1: One step shift closer 2: One step shift further | OFC | W | 0 to 2 |
| Get Light Time: Gets the light time from the projector. | LMP | R | 0- Unit: Hours |

| Function | Command Name | RW | Setting Range |
|--|--------------------|----|---|
| Eco Mode: Enter Eco Mode. | PMD | RW | 0: Off (Bright), 1: Off (Normal), 2: On (Auto), 3: On (Manual 1), 4: On (Manual 2), 5: On (Manual 3), 6: On (Manual 4), 7: On (Manual 5) |
| Freeze: Switches freeze on or off. | FRZ | RW | 0: Off, 1: On |
| Keystone Correction: Specifies the keystone correction setting as a value that corresponds to the typical Setup Menu "Keystone Correction" settings below. 0: Keystone Correction -60 60: Keystone Correction 0 120: Keystone Correction +60 Example: 65 here, specifies a setting equivalent to Keystone Correction +5. | KST | RW | 0 to 120 |
| Keystone Correction +/-: Raises or lowers the current keystone correction setting by 1. | + : KSP - : KSM | W | 0 to 120 |
| Key: Operation executed when a key is pressed. Setting values 31 through 34 are supported by XJ-A Series projectors only. | KEY | W | 1: ▲, 2: ▼, 3: ◀, 4: ▶, 5: ENTER, 6: ESC, 10: FUNC, 11: MENU, 12: POWER, 13: AUTO, 14: INPUT, 15: TIMER, 16: ASPECT, 17: BLANK, 18: FREEZE, 19: ECO, 20: KEYSTONE +, 21: KEYSTONE -, 22: D-ZOOM +, 23: D-ZOOM -, 24: VOLUME +, 25: VOLUME -, 26: PLAY(▶▶▶), 27: REWIND(◀◀◀), 28: FORWARD(▶▶▶), 29: PREVIOUS(◀▶), 30: NEXT(▶▶), 31: ZOOM +, 32: ZOOM -, 33: FOCUS ▲, 34: FOCUS ▼ |
| Setup Type: Specifies how the projector is set up relative to screen for projection. 0: Projection to a screen in front of the projector*1 1: Ceiling mounted projection from behind the screen*2 2: Projection from behind the screen*1 3: Ceiling mounted projection to a screen in front of the projector*2 | POS | RW | 0 to 3 |
| APO: Used to change the Auto Power Off setting (trigger time setting or Auto Power Off disable). | APO | RW | 0: Off, 1: 5 minutes, 2: 10 minutes, 3: 15 minutes, 4: 20 minutes, 5: 30 minutes |
| Error: Reads the projector error status. | STS | R | 0: Normal, 1: Fan error, 2: Temperature error, 7: Light error, 16: Other error |

| Function | Command Name | RW | Setting Range |
|--|------------------|----|---------------|
| Volume +/-: Raises or lowers the current volume setting by 1. | +: VLP -: VLM | W | 0 to 30 |
| Mute: Switches mute on or off. | MUT | RW | 0: Off, 1: On |

*1 Top of projector upwards

*2 Top of projector downwards

GPL and LGPL

- (1) This product uses software (This Software) that comes under the GNU General Public License (GPL) and GNU Lesser General Public License (LGPL). In accordance with the GPL and LGPL, the source code of This Software is open source code. Anyone who wishes to view the open source code can do so by downloading it from the CASIO Projector download site. Whenever copying, modifying, or distributing This Software, be sure to do so in accordance with the terms and conditions of the GPL and LGPL.
- (2) This Software is provided “as is” without expressed or implied warranty of any kind. However, this disclaimer does not affect the terms and conditions of the warranty of the product itself (including malfunctions due to This Software).
- (3) The following are the GPL and LGPL that This Software comes under.

GNU GENERAL PUBLIC LICENSE

Version 2, June 1991

Copyright (C) 1989, 1991 Free Software Foundation, Inc.
51 Franklin Street, Fifth Floor, Boston, MA 02110-1301, USA

Everyone is permitted to copy and distribute verbatim copies
of this license document, but changing it is not allowed.

Preamble

The licenses for most software are designed to take away your freedom to share and change it. By contrast, the GNU General Public License is intended to guarantee your freedom to share and change free software--to make sure the software is free for all its users. This General Public License applies to most of the Free Software Foundation's software and to any other program whose authors commit to using it. (Some other Free Software Foundation software is covered by the GNU Lesser General Public License instead.) You can apply it to your programs, too.

When we speak of free software, we are referring to freedom, not price. Our General Public Licenses are designed to make sure that you have the freedom to distribute copies of free software (and charge for this service if you wish), that you receive source code or can get it if you want it, that you can change the software or use pieces of it in new free programs; and that you know you can do these things.

To protect your rights, we need to make restrictions that forbid anyone to deny you these rights or to ask you to surrender the rights. These restrictions translate to certain responsibilities for you if you distribute copies of the software, or if you modify it.

For example, if you distribute copies of such a program, whether gratis or for a fee, you must give the recipients all the rights that you have. You must make sure that they, too, receive or can get the source code. And you must show them these terms so they know their rights.

We protect your rights with two steps: (1) copyright the software, and (2) offer you this license which gives you legal permission to copy, distribute and/or modify the software.

Also, for each author's protection and ours, we want to make certain that everyone understands that there is no warranty for this free software. If the software is modified by someone else and passed on, we want its recipients to know that what they have is not the original, so that any problems introduced by others will not reflect on the original authors' reputations.

Finally, any free program is threatened constantly by software patents. We wish to avoid the danger that redistributors of a free program will individually obtain patent licenses, in effect making the program proprietary. To prevent this, we have made it clear that any patent must be licensed for everyone's free use or not licensed at all.

The precise terms and conditions for copying, distribution and modification follow.

TERMS AND CONDITIONS FOR COPYING, DISTRIBUTION AND MODIFICATION

0. This License applies to any program or other work which contains a notice placed by the copyright holder saying it may be distributed under the terms of this General Public License. The “Program”, below, refers to any such program or work, and a “work based on the Program” means either the Program or any derivative work under copyright law: that is to say, a work containing the Program or a portion of it, either verbatim or with modifications and/or translated into another language. (Hereinafter, translation is included without limitation in the term “modification”.) Each licensee is addressed as “you”.

Activities other than copying, distribution and modification are not covered by this License; they are outside its scope. The act of running the Program is not restricted, and the output from the Program is covered only if its contents constitute a work based on the Program (independent of having been made by running the Program). Whether that is true depends on what the Program does.

1. You may copy and distribute verbatim copies of the Program’s source code as you receive it, in any medium, provided that you conspicuously and appropriately publish on each copy an appropriate copyright notice and disclaimer of warranty; keep intact all the notices that refer to this License and to the absence of any warranty; and give any other recipients of the Program a copy of this License along with the Program.

You may charge a fee for the physical act of transferring a copy, and you may at your option offer warranty protection in exchange for a fee.

2. You may modify your copy or copies of the Program or any portion of it, thus forming a work based on the Program, and copy and distribute such modifications or work under the terms of Section 1 above, provided that you also meet all of these conditions:
- a) You must cause the modified files to carry prominent notices stating that you changed the files and the date of any change.
 - b) You must cause any work that you distribute or publish, that in whole or in part contains or is derived from the Program or any part thereof, to be licensed as a whole at no charge to all third parties under the terms of this License.
 - c) If the modified program normally reads commands interactively when run, you must cause it, when started running for such interactive use in the most ordinary way, to print or display an announcement including an appropriate copyright notice and a notice that there is no warranty (or else, saying that you provide a warranty) and that users may redistribute the program under these conditions, and telling the user how to view a copy of this License. (Exception: if the Program itself is interactive but does not normally print such an announcement, your work based on the Program is not required to print an announcement.)

These requirements apply to the modified work as a whole. If identifiable sections of that work are not derived from the Program, and can be reasonably considered independent and separate works in themselves, then this License, and its terms, do not apply to those sections when you distribute them as separate works. But when you distribute the same sections as part of a whole which is a work based on the Program, the distribution of the whole must be on the terms of this License, whose permissions for other licensees extend to the entire whole, and thus to each and every part regardless of who wrote it.

Thus, it is not the intent of this section to claim rights or contest your rights to work written entirely by you; rather, the intent is to exercise the right to control the distribution of derivative or collective works based on the Program.

In addition, mere aggregation of another work not based on the Program with the Program (or with a work based on the Program) on a volume of a storage or distribution medium does not bring the other work under the scope of this License.

3. You may copy and distribute the Program (or a work based on it, under Section 2) in object code or executable form under the terms of Sections 1 and 2 above provided that you also do one of the following:
 - a) Accompany it with the complete corresponding machine-readable source code, which must be distributed under the terms of Sections 1 and 2 above on a medium customarily used for software interchange; or,
 - b) Accompany it with a written offer, valid for at least three years, to give any third party, for a charge no more than your cost of physically performing source distribution, a complete machine-readable copy of the corresponding source code, to be distributed under the terms of Sections 1 and 2 above on a medium customarily used for software interchange; or,
 - c) Accompany it with the information you received as to the offer to distribute corresponding source code. (This alternative is allowed only for noncommercial distribution and only if you received the program in object code or executable form with such an offer, in accord with Subsection b above.)

The source code for a work means the preferred form of the work for making modifications to it. For an executable work, complete source code means all the source code for all modules it contains, plus any associated interface definition files, plus the scripts used to control compilation and installation of the executable. However, as a special exception, the source code distributed need not include anything that is normally distributed (in either source or binary form) with the major components (compiler, kernel, and so on) of the operating system on which the executable runs, unless that component itself accompanies the executable.

If distribution of executable or object code is made by offering access to copy from a designated place, then offering equivalent access to copy the source code from the same place counts as distribution of the source code, even though third parties are not compelled to copy the source along with the object code.

4. You may not copy, modify, sublicense, or distribute the Program except as expressly provided under this License. Any attempt otherwise to copy, modify, sublicense or distribute the Program is void, and will automatically terminate your rights under this License. However, parties who have received copies, or rights, from you under this License will not have their licenses terminated so long as such parties remain in full compliance.

5. You are not required to accept this License, since you have not signed it. However, nothing else grants you permission to modify or distribute the Program or its derivative works. These actions are prohibited by law if you do not accept this License. Therefore, by modifying or distributing the Program (or any work based on the Program), you indicate your acceptance of this License to do so, and all its terms and conditions for copying, distributing or modifying the Program or works based on it.
6. Each time you redistribute the Program (or any work based on the Program), the recipient automatically receives a license from the original licensor to copy, distribute or modify the Program subject to these terms and conditions. You may not impose any further restrictions on the recipients' exercise of the rights granted herein. You are not responsible for enforcing compliance by third parties to this License.
7. If, as a consequence of a court judgment or allegation of patent infringement or for any other reason (not limited to patent issues), conditions are imposed on you (whether by court order, agreement or otherwise) that contradict the conditions of this License, they do not excuse you from the conditions of this License. If you cannot distribute so as to satisfy simultaneously your obligations under this License and any other pertinent obligations, then as a consequence you may not distribute the Program at all. For example, if a patent license would not permit royalty-free redistribution of the Program by all those who receive copies directly or indirectly through you, then the only way you could satisfy both it and this License would be to refrain entirely from distribution of the Program.

If any portion of this section is held invalid or unenforceable under any particular circumstance, the balance of the section is intended to apply and the section as a whole is intended to apply in other circumstances.

It is not the purpose of this section to induce you to infringe any patents or other property right claims or to contest validity of any such claims; this section has the sole purpose of protecting the integrity of the free software distribution system, which is implemented by public license practices. Many people have made generous contributions to the wide range of software distributed through that system in reliance on consistent application of that system; it is up to the author/donor to decide if he or she is willing to distribute software through any other system and a licensee cannot impose that choice.

This section is intended to make thoroughly clear what is believed to be a consequence of the rest of this License.

8. If the distribution and/or use of the Program is restricted in certain countries either by patents or by copyrighted interfaces, the original copyright holder who places the Program under this License may add an explicit geographical distribution limitation excluding those countries, so that distribution is permitted only in or among countries not thus excluded. In such case, this License incorporates the limitation as if written in the body of this License.
9. The Free Software Foundation may publish revised and/or new versions of the General Public License from time to time. Such new versions will be similar in spirit to the present version, but may differ in detail to address new problems or concerns.

Each version is given a distinguishing version number. If the Program specifies a version number of this License which applies to it and "any later version", you have the option of following the terms and conditions either of that version or of any later version published by the Free Software Foundation. If the Program does not specify a version number of this License, you may choose any version ever published by the Free Software Foundation.

10.If you wish to incorporate parts of the Program into other free programs whose distribution conditions are different, write to the author to ask for permission. For software which is copyrighted by the Free Software Foundation, write to the Free Software Foundation; we sometimes make exceptions for this. Our decision will be guided by the two goals of preserving the free status of all derivatives of our free software and of promoting the sharing and reuse of software generally.

NO WARRANTY

11.BECAUSE THE PROGRAM IS LICENSED FREE OF CHARGE, THERE IS NO WARRANTY FOR THE PROGRAM, TO THE EXTENT PERMITTED BY APPLICABLE LAW. EXCEPT WHEN OTHERWISE STATED IN WRITING THE COPYRIGHT HOLDERS AND/OR OTHER PARTIES PROVIDE THE PROGRAM "AS IS" WITHOUT WARRANTY OF ANY KIND, EITHER EXPRESSED OR IMPLIED, INCLUDING, BUT NOT LIMITED TO, THE IMPLIED WARRANTIES OF MERCHANTABILITY AND FITNESS FOR A PARTICULAR PURPOSE. THE ENTIRE RISK AS TO THE QUALITY AND PERFORMANCE OF THE PROGRAM IS WITH YOU. SHOULD THE PROGRAM PROVE DEFECTIVE, YOU ASSUME THE COST OF ALL NECESSARY SERVICING, REPAIR OR CORRECTION.

12.IN NO EVENT UNLESS REQUIRED BY APPLICABLE LAW OR AGREED TO IN WRITING WILL ANY COPYRIGHT HOLDER, OR ANY OTHER PARTY WHO MAY MODIFY AND/OR REDISTRIBUTE THE PROGRAM AS PERMITTED ABOVE, BE LIABLE TO YOU FOR DAMAGES, INCLUDING ANY GENERAL, SPECIAL, INCIDENTAL OR CONSEQUENTIAL DAMAGES ARISING OUT OF THE USE OR INABILITY TO USE THE PROGRAM (INCLUDING BUT NOT LIMITED TO LOSS OF DATA OR DATA BEING RENDERED INACCURATE OR LOSSES SUSTAINED BY YOU OR THIRD PARTIES OR A FAILURE OF THE PROGRAM TO OPERATE WITH ANY OTHER PROGRAMS), EVEN IF SUCH HOLDER OR OTHER PARTY HAS BEEN ADVISED OF THE POSSIBILITY OF SUCH DAMAGES.

END OF TERMS AND CONDITIONS

How to Apply These Terms to Your New Programs

If you develop a new program, and you want it to be of the greatest possible use to the public, the best way to achieve this is to make it free software which everyone can redistribute and change under these terms.

To do so, attach the following notices to the program. It is safest to attach them to the start of each source file to most effectively convey the exclusion of warranty; and each file should have at least the "copyright" line and a pointer to where the full notice is found.

```
one line to give the program's name and an idea of what it does.  
Copyright (C) yyyy name of author
```

```
This program is free software; you can redistribute it and/or  
modify it under the terms of the GNU General Public License  
as published by the Free Software Foundation; either version 2  
of the License, or (at your option) any later version.
```

```
This program is distributed in the hope that it will be useful,  
but WITHOUT ANY WARRANTY; without even the implied warranty of  
MERCHANTABILITY or FITNESS FOR A PARTICULAR PURPOSE. See the  
GNU General Public License for more details.
```

```
You should have received a copy of the GNU General Public License  
along with this program; if not, write to the Free Software  
Foundation, Inc., 51 Franklin Street, Fifth Floor, Boston, MA 02110-1301, USA.
```

Also add information on how to contact you by electronic and paper mail.

If the program is interactive, make it output a short notice like this when it starts in an interactive mode:

```
Gnomovision version 69, Copyright (C) year name of author  
Gnomovision comes with ABSOLUTELY NO WARRANTY; for details  
type 'show w'. This is free software, and you are welcome  
to redistribute it under certain conditions; type 'show c'  
for details.
```

The hypothetical commands 'show w' and 'show c' should show the appropriate parts of the General Public License. Of course, the commands you use may be called something other than 'show w' and 'show c'; they could even be mouse-clicks or menu items--whatever suits your program.

You should also get your employer (if you work as a programmer) or your school, if any, to sign a "copyright disclaimer" for the program, if necessary. Here is a sample; alter the names:

```
Yoyodyne, Inc., hereby disclaims all copyright  
interest in the program 'Gnomovision'  
(which makes passes at compilers) written  
by James Hacker.
```

```
signature of Ty Coon, 1 April 1989  
Ty Coon, President of Vice
```

This General Public License does not permit incorporating your program into proprietary programs. If your program is a subroutine library, you may consider it more useful to permit linking proprietary applications with the library. If this is what you want to do, use the GNU Lesser General Public License instead of this License.

GNU LESSER GENERAL PUBLIC LICENSE

Version 2.1, February 1999

Copyright (C) 1991, 1999 Free Software Foundation, Inc.
51 Franklin Street, Fifth Floor, Boston, MA 02110-1301 USA
Everyone is permitted to copy and distribute verbatim copies
of this license document, but changing it is not allowed.

[This is the first released version of the Lesser GPL. It also counts
as the successor of the GNU Library Public License, version 2, hence
the version number 2.1.]

Preamble

The licenses for most software are designed to take away your freedom to share and change it. By contrast, the GNU General Public Licenses are intended to guarantee your freedom to share and change free software--to make sure the software is free for all its users.

This license, the Lesser General Public License, applies to some specially designated software packages--typically libraries--of the Free Software Foundation and other authors who decide to use it. You can use it too, but we suggest you first think carefully about whether this license or the ordinary General Public License is the better strategy to use in any particular case, based on the explanations below.

When we speak of free software, we are referring to freedom of use, not price. Our General Public Licenses are designed to make sure that you have the freedom to distribute copies of free software (and charge for this service if you wish); that you receive source code or can get it if you want it; that you can change the software and use pieces of it in new free programs; and that you are informed that you can do these things.

To protect your rights, we need to make restrictions that forbid distributors to deny you these rights or to ask you to surrender these rights. These restrictions translate to certain responsibilities for you if you distribute copies of the library or if you modify it.

For example, if you distribute copies of the library, whether gratis or for a fee, you must give the recipients all the rights that we gave you. You must make sure that they, too, receive or can get the source code. If you link other code with the library, you must provide complete object files to the recipients, so that they can relink them with the library after making changes to the library and recompiling it. And you must show them these terms so they know their rights.

We protect your rights with a two-step method: (1) we copyright the library, and (2) we offer you this license, which gives you legal permission to copy, distribute and/or modify the library.

To protect each distributor, we want to make it very clear that there is no warranty for the free library. Also, if the library is modified by someone else and passed on, the recipients should know that what they have is not the original version, so that the original author's reputation will not be affected by problems that might be introduced by others.

Finally, software patents pose a constant threat to the existence of any free program. We wish to make sure that a company cannot effectively restrict the users of a free program by obtaining a restrictive license from a patent holder. Therefore, we insist that any patent license obtained for a version of the library must be consistent with the full freedom of use specified in this license.

Most GNU software, including some libraries, is covered by the ordinary GNU General Public License. This license, the GNU Lesser General Public License, applies to certain designated libraries, and is quite different from the ordinary General Public License. We use this license for certain libraries in order to permit linking those libraries into non-free programs.

When a program is linked with a library, whether statically or using a shared library, the combination of the two is legally speaking a combined work, a derivative of the original library. The ordinary General Public License therefore permits such linking only if the entire combination fits its criteria of freedom. The Lesser General Public License permits more lax criteria for linking other code with the library.

We call this license the “Lesser” General Public License because it does Less to protect the user’s freedom than the ordinary General Public License. It also provides other free software developers Less of an advantage over competing non-free programs. These disadvantages are the reason we use the ordinary General Public License for many libraries. However, the Lesser license provides advantages in certain special circumstances.

For example, on rare occasions, there may be a special need to encourage the widest possible use of a certain library, so that it becomes a de-facto standard. To achieve this, non-free programs must be allowed to use the library. A more frequent case is that a free library does the same job as widely used non-free libraries. In this case, there is little to gain by limiting the free library to free software only, so we use the Lesser General Public License.

In other cases, permission to use a particular library in non-free programs enables a greater number of people to use a large body of free software. For example, permission to use the GNU C Library in non-free programs enables many more people to use the whole GNU operating system, as well as its variant, the GNU/Linux operating system.

Although the Lesser General Public License is Less protective of the users’ freedom, it does ensure that the user of a program that is linked with the Library has the freedom and the wherewithal to run that program using a modified version of the Library.

The precise terms and conditions for copying, distribution and modification follow. Pay close attention to the difference between a “work based on the library” and a “work that uses the library”. The former contains code derived from the library, whereas the latter must be combined with the library in order to run.

TERMS AND CONDITIONS FOR COPYING, DISTRIBUTION AND MODIFICATION

0. This License Agreement applies to any software library or other program which contains a notice placed by the copyright holder or other authorized party saying it may be distributed under the terms of this Lesser General Public License (also called “this License”). Each licensee is addressed as “you”.

A “library” means a collection of software functions and/or data prepared so as to be conveniently linked with application programs (which use some of those functions and data) to form executables.

The “Library”, below, refers to any such software library or work which has been distributed under these terms. A “work based on the Library” means either the Library or any derivative work under copyright law: that is to say, a work containing the Library or a portion of it, either verbatim or with modifications and/or translated straightforwardly into another language. (Hereinafter, translation is included without limitation in the term “modification”).

“Source code” for a work means the preferred form of the work for making modifications to it. For a library, complete source code means all the source code for all modules it contains, plus any associated interface definition files, plus the scripts used to control compilation and installation of the library.

Activities other than copying, distribution and modification are not covered by this License; they are outside its scope. The act of running a program using the Library is not restricted, and output from such a program is covered only if its contents constitute a work based on the Library (independent of the use of the Library in a tool for writing it). Whether that is true depends on what the Library does and what the program that uses the Library does.

1. You may copy and distribute verbatim copies of the Library’s complete source code as you receive it, in any medium, provided that you conspicuously and appropriately publish on each copy an appropriate copyright notice and disclaimer of warranty; keep intact all the notices that refer to this License and to the absence of any warranty; and distribute a copy of this License along with the Library.

You may charge a fee for the physical act of transferring a copy, and you may at your option offer warranty protection in exchange for a fee.

2. You may modify your copy or copies of the Library or any portion of it, thus forming a work based on the Library, and copy and distribute such modifications or work under the terms of Section 1 above, provided that you also meet all of these conditions:
- a) The modified work must itself be a software library.
 - b) You must cause the files modified to carry prominent notices stating that you changed the files and the date of any change.
 - c) You must cause the whole of the work to be licensed at no charge to all third parties under the terms of this License.

- d) If a facility in the modified Library refers to a function or a table of data to be supplied by an application program that uses the facility, other than as an argument passed when the facility is invoked, then you must make a good faith effort to ensure that, in the event an application does not supply such function or table, the facility still operates, and performs whatever part of its purpose remains meaningful.

(For example, a function in a library to compute square roots has a purpose that is entirely well-defined independent of the application. Therefore, Subsection 2d requires that any application-supplied function or table used by this function must be optional: if the application does not supply it, the square root function must still compute square roots.)

These requirements apply to the modified work as a whole. If identifiable sections of that work are not derived from the Library, and can be reasonably considered independent and separate works in themselves, then this License, and its terms, do not apply to those sections when you distribute them as separate works. But when you distribute the same sections as part of a whole which is a work based on the Library, the distribution of the whole must be on the terms of this License, whose permissions for other licensees extend to the entire whole, and thus to each and every part regardless of who wrote it.

Thus, it is not the intent of this section to claim rights or contest your rights to work written entirely by you; rather, the intent is to exercise the right to control the distribution of derivative or collective works based on the Library.

In addition, mere aggregation of another work not based on the Library with the Library (or with a work based on the Library) on a volume of a storage or distribution medium does not bring the other work under the scope of this License.

3. You may opt to apply the terms of the ordinary GNU General Public License instead of this License to a given copy of the Library. To do this, you must alter all the notices that refer to this License, so that they refer to the ordinary GNU General Public License, version 2, instead of to this License. (If a newer version than version 2 of the ordinary GNU General Public License has appeared, then you can specify that version instead if you wish.) Do not make any other change in these notices.

Once this change is made in a given copy, it is irreversible for that copy, so the ordinary GNU General Public License applies to all subsequent copies and derivative works made from that copy.

This option is useful when you wish to copy part of the code of the Library into a program that is not a library.

4. You may copy and distribute the Library (or a portion or derivative of it, under Section 2) in object code or executable form under the terms of Sections 1 and 2 above provided that you accompany it with the complete corresponding machine-readable source code, which must be distributed under the terms of Sections 1 and 2 above on a medium customarily used for software interchange.

If distribution of object code is made by offering access to copy from a designated place, then offering equivalent access to copy the source code from the same place satisfies the requirement to distribute the source code, even though third parties are not compelled to copy the source along with the object code.

5. A program that contains no derivative of any portion of the Library, but is designed to work with the Library by being compiled or linked with it, is called a “work that uses the Library”. Such a work, in isolation, is not a derivative work of the Library, and therefore falls outside the scope of this License.

However, linking a “work that uses the Library” with the Library creates an executable that is a derivative of the Library (because it contains portions of the Library), rather than a “work that uses the library”. The executable is therefore covered by this License. Section 6 states terms for distribution of such executables.

When a “work that uses the Library” uses material from a header file that is part of the Library, the object code for the work may be a derivative work of the Library even though the source code is not. Whether this is true is especially significant if the work can be linked without the Library, or if the work is itself a library. The threshold for this to be true is not precisely defined by law.

If such an object file uses only numerical parameters, data structure layouts and accessors, and small macros and small inline functions (ten lines or less in length), then the use of the object file is unrestricted, regardless of whether it is legally a derivative work. (Executables containing this object code plus portions of the Library will still fall under Section 6.)

Otherwise, if the work is a derivative of the Library, you may distribute the object code for the work under the terms of Section 6. Any executables containing that work also fall under Section 6, whether or not they are linked directly with the Library itself.

6. As an exception to the Sections above, you may also combine or link a “work that uses the Library” with the Library to produce a work containing portions of the Library, and distribute that work under terms of your choice, provided that the terms permit modification of the work for the customer’s own use and reverse engineering for debugging such modifications.

You must give prominent notice with each copy of the work that the Library is used in it and that the Library and its use are covered by this License. You must supply a copy of this License. If the work during execution displays copyright notices, you must include the copyright notice for the Library among them, as well as a reference directing the user to the copy of this License. Also, you must do one of these things:

- a) Accompany the work with the complete corresponding machine-readable source code for the Library including whatever changes were used in the work (which must be distributed under Sections 1 and 2 above); and, if the work is an executable linked with the Library, with the complete machine-readable “work that uses the Library”, as object code and/or source code, so that the user can modify the Library and then relink to produce a modified executable containing the modified Library. (It is understood that the user who changes the contents of definitions files in the Library will not necessarily be able to recompile the application to use the modified definitions.)
- b) Use a suitable shared library mechanism for linking with the Library. A suitable mechanism is one that (1) uses at run time a copy of the library already present on the user’s computer system, rather than copying library functions into the executable, and (2) will operate properly with a modified version of the library, if the user installs one, as long as the modified version is interface-compatible with the version that the work was made with.
- c) Accompany the work with a written offer, valid for at least three years, to give the same user the materials specified in Subsection 6a, above, for a charge no more than the cost of performing this distribution.
- d) If distribution of the work is made by offering access to copy from a designated place, offer equivalent access to copy the above specified materials from the same place.
- e) Verify that the user has already received a copy of these materials or that you have already sent this user a copy.

For an executable, the required form of the “work that uses the Library” must include any data and utility programs needed for reproducing the executable from it. However, as a special exception, the materials to be distributed need not include anything that is normally distributed (in either source or binary form) with the major components (compiler, kernel, and so on) of the operating system on which the executable runs, unless that component itself accompanies the executable.

It may happen that this requirement contradicts the license restrictions of other proprietary libraries that do not normally accompany the operating system. Such a contradiction means you cannot use both them and the Library together in an executable that you distribute.

7. You may place library facilities that are a work based on the Library side-by-side in a single library together with other library facilities not covered by this License, and distribute such a combined library, provided that the separate distribution of the work based on the Library and of the other library facilities is otherwise permitted, and provided that you do these two things:
 - a) Accompany the combined library with a copy of the same work based on the Library, uncombined with any other library facilities. This must be distributed under the terms of the Sections above.
 - b) Give prominent notice with the combined library of the fact that part of it is a work based on the Library, and explaining where to find the accompanying uncombined form of the same work.
8. You may not copy, modify, sublicense, link with, or distribute the Library except as expressly provided under this License. Any attempt otherwise to copy, modify, sublicense, link with, or distribute the Library is void, and will automatically terminate your rights under this License. However, parties who have received copies, or rights, from you under this License will not have their licenses terminated so long as such parties remain in full compliance.
9. You are not required to accept this License, since you have not signed it. However, nothing else grants you permission to modify or distribute the Library or its derivative works. These actions are prohibited by law if you do not accept this License. Therefore, by modifying or distributing the Library (or any work based on the Library), you indicate your acceptance of this License to do so, and all its terms and conditions for copying, distributing or modifying the Library or works based on it.
10. Each time you redistribute the Library (or any work based on the Library), the recipient automatically receives a license from the original licensor to copy, distribute, link with or modify the Library subject to these terms and conditions. You may not impose any further restrictions on the recipients' exercise of the rights granted herein. You are not responsible for enforcing compliance by third parties with this License.
11. If, as a consequence of a court judgment or allegation of patent infringement or for any other reason (not limited to patent issues), conditions are imposed on you (whether by court order, agreement or otherwise) that contradict the conditions of this License, they do not excuse you from the conditions of this License. If you cannot distribute so as to satisfy simultaneously your obligations under this License and any other pertinent obligations, then as a consequence you may not distribute the Library at all. For example, if a patent license would not permit royalty-free redistribution of the Library by all those who receive copies directly or indirectly through you, then the only way you could satisfy both it and this License would be to refrain entirely from distribution of the Library.

If any portion of this section is held invalid or unenforceable under any particular circumstance, the balance of the section is intended to apply, and the section as a whole is intended to apply in other circumstances.

It is not the purpose of this section to induce you to infringe any patents or other property right claims or to contest validity of any such claims; this section has the sole purpose of protecting the integrity of the free software distribution system which is implemented by public license practices. Many people have made generous contributions to the wide range of software distributed through that system in reliance on consistent application of that system; it is up to the author/donor to decide if he or she is willing to distribute software through any other system and a licensee cannot impose that choice.

This section is intended to make thoroughly clear what is believed to be a consequence of the rest of this License.

12.If the distribution and/or use of the Library is restricted in certain countries either by patents or by copyrighted interfaces, the original copyright holder who places the Library under this License may add an explicit geographical distribution limitation excluding those countries, so that distribution is permitted only in or among countries not thus excluded. In such case, this License incorporates the limitation as if written in the body of this License.

13.The Free Software Foundation may publish revised and/or new versions of the Lesser General Public License from time to time. Such new versions will be similar in spirit to the present version, but may differ in detail to address new problems or concerns.

Each version is given a distinguishing version number. If the Library specifies a version number of this License which applies to it and “any later version”, you have the option of following the terms and conditions either of that version or of any later version published by the Free Software Foundation. If the Library does not specify a license version number, you may choose any version ever published by the Free Software Foundation.

14.If you wish to incorporate parts of the Library into other free programs whose distribution conditions are incompatible with these, write to the author to ask for permission. For software which is copyrighted by the Free Software Foundation, write to the Free Software Foundation; we sometimes make exceptions for this. Our decision will be guided by the two goals of preserving the free status of all derivatives of our free software and of promoting the sharing and reuse of software generally.

NO WARRANTY

15.BECAUSE THE LIBRARY IS LICENSED FREE OF CHARGE, THERE IS NO WARRANTY FOR THE LIBRARY, TO THE EXTENT PERMITTED BY APPLICABLE LAW. EXCEPT WHEN OTHERWISE STATED IN WRITING THE COPYRIGHT HOLDERS AND/OR OTHER PARTIES PROVIDE THE LIBRARY “AS IS” WITHOUT WARRANTY OF ANY KIND, EITHER EXPRESSED OR IMPLIED, INCLUDING, BUT NOT LIMITED TO, THE IMPLIED WARRANTIES OF MERCHANTABILITY AND FITNESS FOR A PARTICULAR PURPOSE. THE ENTIRE RISK AS TO THE QUALITY AND PERFORMANCE OF THE LIBRARY IS WITH YOU. SHOULD THE LIBRARY PROVE DEFECTIVE, YOU ASSUME THE COST OF ALL NECESSARY SERVICING, REPAIR OR CORRECTION.

16.IN NO EVENT UNLESS REQUIRED BY APPLICABLE LAW OR AGREED TO IN WRITING WILL ANY COPYRIGHT HOLDER, OR ANY OTHER PARTY WHO MAY MODIFY AND/OR REDISTRIBUTE THE LIBRARY AS PERMITTED ABOVE, BE LIABLE TO YOU FOR DAMAGES, INCLUDING ANY GENERAL, SPECIAL, INCIDENTAL OR CONSEQUENTIAL DAMAGES ARISING OUT OF THE USE OR INABILITY TO USE THE LIBRARY (INCLUDING BUT NOT LIMITED TO LOSS OF DATA OR DATA BEING RENDERED INACCURATE OR LOSSES SUSTAINED BY YOU OR THIRD PARTIES OR A FAILURE OF THE LIBRARY TO OPERATE WITH ANY OTHER SOFTWARE), EVEN IF SUCH HOLDER OR OTHER PARTY HAS BEEN ADVISED OF THE POSSIBILITY OF SUCH DAMAGES.

END OF TERMS AND CONDITIONS

How to Apply These Terms to Your New Libraries

If you develop a new library, and you want it to be of the greatest possible use to the public, we recommend making it free software that everyone can redistribute and change. You can do so by permitting redistribution under these terms (or, alternatively, under the terms of the ordinary General Public License).

To apply these terms, attach the following notices to the library. It is safest to attach them to the start of each source file to most effectively convey the exclusion of warranty; and each file should have at least the “copyright” line and a pointer to where the full notice is found.

```
one line to give the library's name and an idea of what it does.  
Copyright (C) year name of author
```

```
This library is free software; you can redistribute it and/or  
modify it under the terms of the GNU Lesser General Public  
License as published by the Free Software Foundation; either  
version 2.1 of the License, or (at your option) any later version.
```

```
This library is distributed in the hope that it will be useful,  
but WITHOUT ANY WARRANTY; without even the implied warranty of  
MERCHANTABILITY or FITNESS FOR A PARTICULAR PURPOSE. See the GNU  
Lesser General Public License for more details.
```

```
You should have received a copy of the GNU Lesser General Public  
License along with this library; if not, write to the Free Software  
Foundation, Inc., 51 Franklin Street, Fifth Floor, Boston, MA 02110-1301 USA
```

Also add information on how to contact you by electronic and paper mail.

You should also get your employer (if you work as a programmer) or your school, if any, to sign a “copyright disclaimer” for the library, if necessary. Here is a sample; alter the names:

```
Yoyodyne, Inc., hereby disclaims all copyright interest in  
the library 'Frob' (a library for tweaking knobs) written  
by James Random Hacker.
```

```
signature of Ty Coon, 1 April 1990  
Ty Coon, President of Vice
```

That's all there is to it!

CASIO®

CASIO COMPUTER CO., LTD.
6-2, Hon-machi 1-chome
Shibuya-ku, Tokyo 151-8543, Japan

MA1405-A

© 2014 CASIO COMPUTER CO., LTD.

Free Manuals Download Website

<http://myh66.com>

<http://usermanuals.us>

<http://www.somanuals.com>

<http://www.4manuals.cc>

<http://www.manual-lib.com>

<http://www.404manual.com>

<http://www.luxmanual.com>

<http://aubethermostatmanual.com>

Golf course search by state

<http://golfingnear.com>

Email search by domain

<http://emailbydomain.com>

Auto manuals search

<http://auto.somanuals.com>

TV manuals search

<http://tv.somanuals.com>