

KODAK DIGITAL SCIENCE™ DC210 Plus Zoom Camera

USER'S GUIDE



www.kodak.com

KODAK DIGITAL SCIENCE™ DC210 Plus Zoom Camera

USER'S GUIDE

www.kodak.com

Information in this document is subject to change without notice.

© 1998 Dell Computer Corporation. All rights reserved.

© 1998 Eastman Kodak Company. All rights reserved.

Reproduction in any manner whatsoever without the written permission of Dell Computer Corporation is strictly forbidden.

Trademarks used in this text: *Dell* is a registered trademark and *DellWare* is a registered service mark of Dell Computer Corporation; *Kodak* is a registered trademark and *KODAK DIGITAL SCIENCE*, *FlashPix*, and *Photolife* are trademarks of Eastman Kodak Company; *Microsoft*, *Windows*, and *Windows NT* are registered trademarks of Microsoft Corporation.

Other trademarks and trade names may be used in this document to refer to either the entities claiming the marks and names or their products. Dell Computer Corporation disclaims any proprietary interest in trademarks and trade names other than its own.

The FlashPix format is defined in a specification and test suite developed and published by Kodak in collaboration with Microsoft, Hewlett-Packard, and Live Picture. Only products that meet the specification and pass the test suite may use the FlashPix name and logo.

October 1998 P/N 3066D

Safety Instructions

When using your digital camera, always follow these basic safety precautions.

WARNING: Use of controls, adjustments, or procedures other than those specified in the Kodak documentation may result in exposure to shock, electrical hazards, and/or mechanical hazards.

- Read and understand all instructions before using the camera.
- To reduce the risk of electric shock, do not immerse the digital camera in water or any other liquid.
- Never disassemble or touch the inside of the camera. This action could result in electrical shock.
- Service or repair work should be done by a qualified service person. Incorrect reassembly can cause electric shock.
- To keep from damaging your camera, avoid exposing it to moisture and extreme temperatures.
- Only use approved batteries in your digital camera.
- If you notice smoke or a strange smell coming from the camera, immediately turn off the camera, wait a few moments until the camera cools, and then remove the batteries.
- Do not attempt to disassemble, recharge, short circuit, or subject the batteries to high temperatures or fire.
- Only use the AC adapter supplied with the digital camera. Use of an accessory attachment not provided or recommended by Kodak may cause fire, electric shock, or injury.

Contents

Chapter 1	
Introduction	1-1
Features	1-1
Camera Kit Contents	1-1
Digital Camera Software	1-2
Camera Accessories	1-2
An Orientation to Your Camera	1-3
Front of Camera	1-3
Top of Camera	1-3
Back of Camera	1-4
Bottom of Camera	1-4
Side of Camera	1-4
Chapter 2	
Operating the Camera	2-1
Installing Batteries	2-1
Battery Usage Guidelines	2-2
Removing and Inserting Memory Cards	2-2
Turning the Camera On and Off	2-3
Using the AC Adapter	2-3
Caring for the Camera	2-4
Chapter 3	
Taking Pictures	3-1
Taking a Picture	3-1
Previewing a Picture	3-2
Deleting the Picture Just Taken	3-2
Adjusting the Exposure Value	3-3
Changing Exposure Compensation	3-3
Turning On Exposure Lock	3-4

Adjusting Camera Settings Using the Status Display	3-4
Pictures Remaining	3-5
Self-Timer	3-5
Memory Card Status	3-6
Close Up	3-6
Flash	3-7
Resolution	3-7
Quality	3-8
Battery Status	3-9
Activating the Zoom	3-10

Chapter 4
Reviewing Pictures 4-1

Viewing Pictures on the Camera	4-1
Deleting Pictures	4-2
Magnifying Pictures	4-3
Viewing Pictures or Running a Slide Show on a TV	4-3

Chapter 5
Adjusting Camera Settings 5-1

Quality	5-2
Resolution	5-3
Template	5-3
Date Stamp	5-4
File Type	5-5
Quickview	5-6
Date and Time	5-7
LCD Brightness	5-8
Format Memory Card	5-9
Video Out	5-10
Language	5-11
About	5-12

Chapter 6
Transferring Pictures From the Camera
to the Computer 6-1

Serial Cable Connection	6-1
Infrared Connection	6-3

Chapter 7
Troubleshooting7-1

Monitor Checks7-1
Memory Card Checks7-1
Camera Checks7-2
LCD Messages7-4
Printing Tips7-4
Monitor Adjustment7-5
Reinstalling the Camera Software7-5
Getting Help7-6

Index

CHAPTER 1

Introduction

Congratulations on your purchase of the new KODAK DIGITAL SCIENCE™ DC210 Plus Zoom camera that captures pictures digitally without the use of film. The camera connects to the serial port of your computer to transfer pictures.

NOTE: The camera includes an infrared transceiver to use with computers that include an infrared port.

Features

The DC210+ camera provides the following features:

- 2X zoom lens (29 to 58 millimeters) to zoom in on subjects and a close-up option to set the focus at 8 inches (20 centimeters)
- Built-in flash with red-eye reduction
- Status display of camera settings
- Removable memory card
- Video-out capabilities that allow you to connect and run a slide show on your TV
- Color liquid crystal display (LCD) to immediately see or preview your pictures
- Software to easily transfer pictures from the camera to your computer
- A mode dial to activate one of four different functions on the camera:
 - Capture — Takes, previews, or deletes last picture taken and adjusts the exposure.
 - Review — Reviews or deletes pictures.
 - Preference — Adjusts camera settings.
 - Connect — Camera communicates with your computer.

Camera Kit Contents

Your DC210+ camera kit includes the following items:

- DC210+ camera
- Carrying case

- Memory card (installed in camera)
- AC adapter
- Four Kodak[®] Photolife™ AA batteries
- *Quick Reference* card and this guide
- Serial cable
- Video output cable

For information on using the memory card and power sources with the camera, refer to Chapter 2, "Operating the Camera."

Digital Camera Software

Dell installed the following software on the hard-disk drive of your computer before shipping your computer system and camera:

- **Picture Easy** — Picture-processing software that allows you to transfer, organize, edit, share, and print pictures taken with your camera. For more information on this software, refer to the "Using the Picture Easy Software" section of the online *KODAK DIGITAL SCIENCE DC210 Plus Zoom Camera User's Guide*. The guide can be accessed by clicking the **Start** button on the Microsoft[®] Windows[®] desktop, pointing to **Programs**—> **Dell Documents**, and clicking **Kodak DC210+ Camera User's Guide**.
- **Mounter software** — Allows you to view, transfer, or delete pictures stored on the camera's memory card through your operating system.
- **TWAIN software** — An industry-standard interface that allows you to directly transfer pictures stored on the camera's memory card into a TWAIN-compliant application program, such as Adobe PhotoDeluxe.

Store the backup software CD that came with your system in a safe place in case you ever need to reinstall the software.

Camera Accessories

The following accessories are available for your camera:

- Additional memory cards
- Memory card reader
- Snapshot and photographic quality paper

To order any of these accessories, contact DellWare[®] at 1-800-753-7201 in the U.S. or a Kodak dealer in the U.K.

An Orientation to Your Camera

The following illustrations identify the features of the DC210+ camera.

Front of Camera

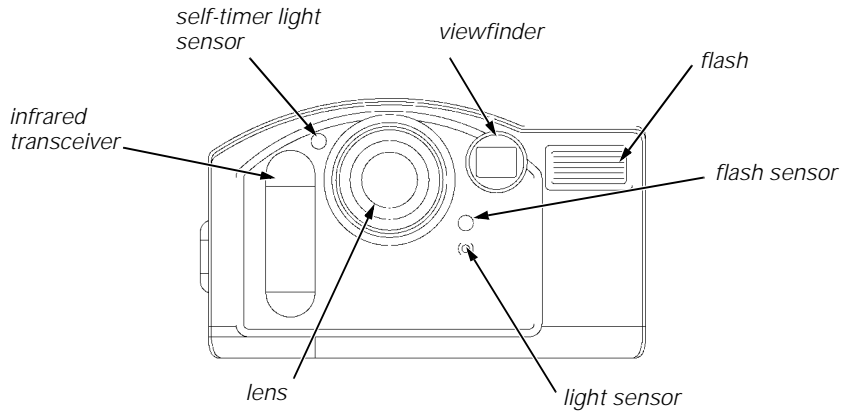

Top of Camera

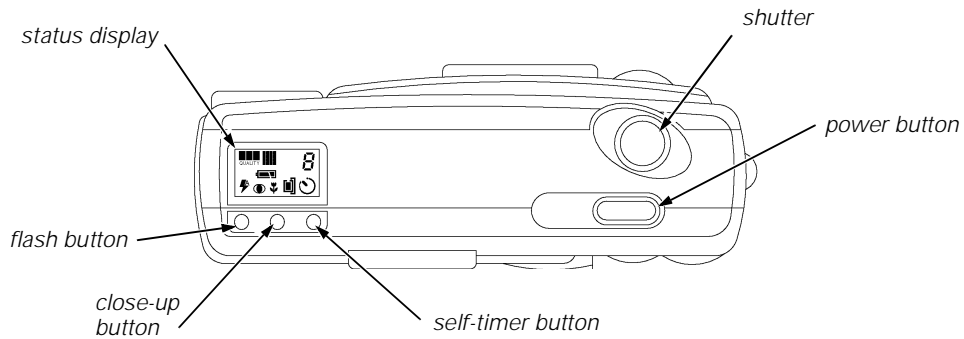

Back of Camera

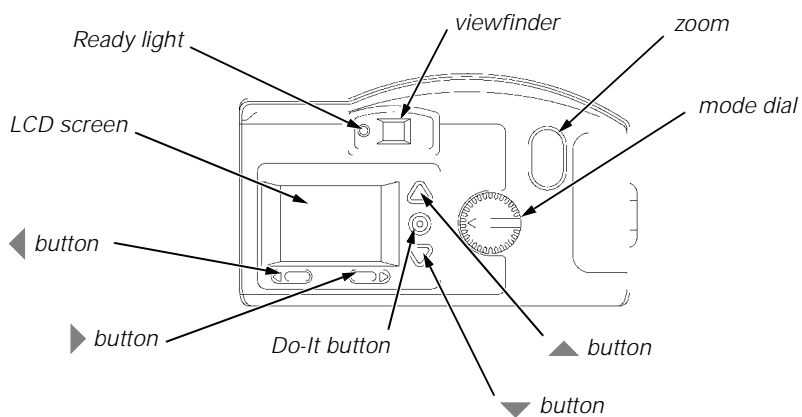

Bottom of Camera

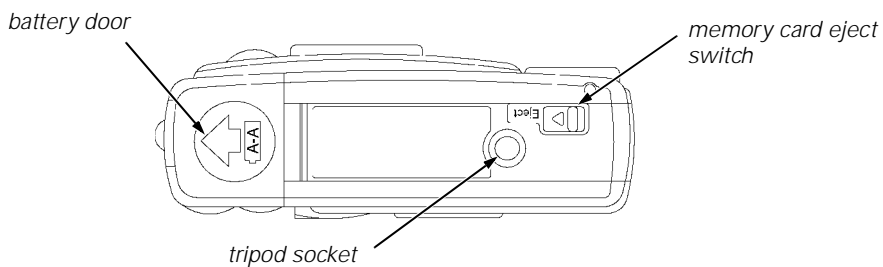

Side of Camera

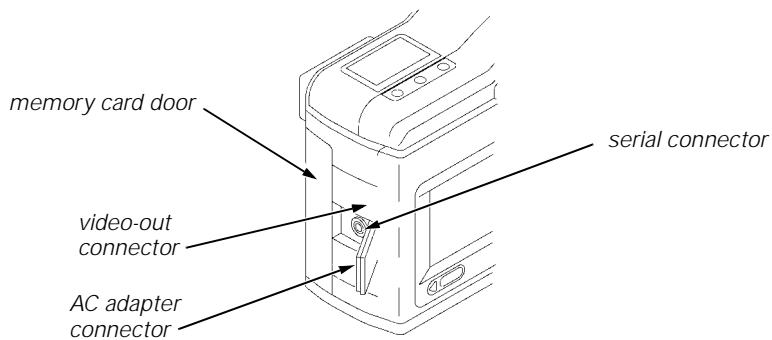

CHAPTER 2

Operating the Camera

This chapter describes basic camera operations, such as using batteries and the AC adapter, inserting and removing the memory card, and turning the camera on and off. This chapter also provides maintenance procedures for the camera.

Installing Batteries

The DC210+ camera comes with four Kodak Photolife AA batteries. Standard 1.5-volt (V) alkaline, 1.5-V lithium, or rechargeable 1.2-V nickel cadmium (Ni-Cd) or nickel metal hydride (Ni-MH) batteries may be used.

To install the batteries, perform the following steps:

1. Place your thumb on the battery door.
2. Slide the battery door away from the camera.
3. Insert the batteries as indicated on the battery door and close the door.

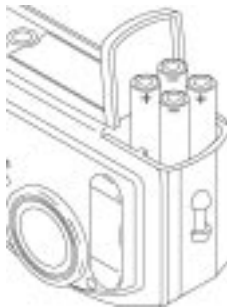

Remove the batteries if the camera will not be used for an extended period of time. Doing so extends battery life and prevents camera damage from battery leaks or corrosion. If the batteries are removed from the camera for more than a few minutes, the camera's date and time features are deleted and must be reset. For information on setting the date and time, refer to "Date and Time" in Chapter 5.

WARNING: Take care when removing the batteries as they may be hot. Allow them to cool before touching them.

Battery Usage Guidelines

Battery life depends significantly on age, usage conditions, type, and brand. In general, digital cameras are very demanding on batteries.

In Kodak lab tests, Ni-MH rechargeable batteries delivered the best results in a variety of conditions. Ni-MH batteries are designed for high-demand devices like digital cameras, and they do not exhibit the memory effects seen with other rechargeable technologies.

If you use alkaline batteries in your camera, obtain "photo-flash grade" alkaline batteries. These types of batteries last more than twice as long in digital cameras as ordinary alkaline batteries.

Ni-Cd batteries work well in digital cameras, but they typically provide the shortest duty cycle (usable power) between charges.

Lithium batteries typically provide the longest overall battery life, but they carry a higher cost-per-picture than other nonrechargeable battery types.

While using your batteries, observe the following guidelines:

- Always follow your battery manufacturer's directions fully.
- Replace the batteries when they are low. Otherwise, the camera may shut down with its lens extended.
- Limit continuous LCD preview or review operations to less than 20 minutes per session. If you anticipate using your camera for longer periods in these modes, Kodak recommends that you use the AC adapter with the camera.
- Dispose of batteries according to federal and local regulations.

Removing and Inserting Memory Cards

The DC210+ camera comes with a KODAK DIGITAL SCIENCE picture card (memory card). The reusable memory card stores the pictures taken with the camera. The memory card is required for camera operation.

NOTE: Use only certified memory cards in your camera that carry the CompactFlash logo.

CAUTION: Do not eject or insert a card when the ready light is blinking. Doing so may damage your pictures or camera.

To remove the memory card, perform the following steps:

1. Open the memory card door on the side of the camera.
2. Press the eject button on the bottom of the camera.

The card partially slides out of the slot.

3. Take hold of the card, carefully remove it from the slot, and close the card door.

To insert the memory card, perform the following steps:

1. Open the memory card door on the side of the camera.
2. Hold the memory card with the connecting end pointed at the camera.

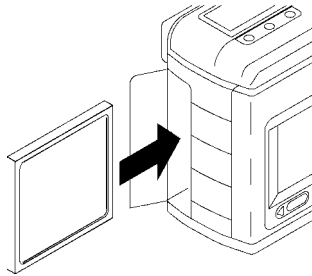

3. Push the card all the way into the card slot and close the card door.

To obtain additional memory cards for your camera, contact DellWare at 1-800-753-7201 in the U.S. or a Kodak dealer in the U.K.

Turning the Camera On and Off

To turn the camera on or off, press the power button on the top of the camera. The green ready light (on the back of the camera) and the status display screen turn on or off.

NOTE: If the camera is turned off while a picture is being processed, the camera finishes processing the picture before turning off.

If your camera is idle for approximately 5 minutes, it automatically turns off. To turn the camera on again, press the camera's power button.

Using the AC Adapter

An AC adapter allows you to connect your camera to a standard electrical outlet. AC power is especially useful when you are transferring pictures into your computer. The adapter powers the camera, but does not charge the batteries.

WARNING: Only use the AC adapter designed for the DC210+ camera. Use of any other adapter may void the warranty and can cause camera failure, fire, electric shock, or injury.

To connect the AC adapter to the camera, perform the following steps:

1. Insert the AC adapter into the AC adapter connection on the side of your camera.

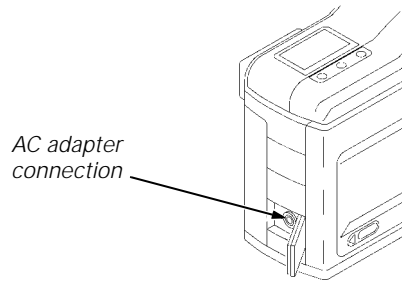

2. Connect the other end of the adapter to a wall outlet.
3. Turn on the camera.

NOTE: The battery icon does not appear on the status display when an AC adapter is used.

Caring for the Camera

Clean the outside of the camera by wiping it with a clean, dry cloth. Never use harsh or abrasive cleaners or organic solvents on the camera or any of its parts.

To clean the camera lens and liquid crystal display (LCD) screen, perform the following steps.

WARNING: Do not use cleaning solutions unless they are designed specifically for camera lenses. Do not wipe the camera lens or LCD screen with chemically treated eyeglass lens tissue as it may scratch the lens.

1. Blow gently on the lens or LCD screen to remove dust and dirt.
2. Moisten the lens or LCD screen by breathing lightly on it.
3. Wipe the lens or LCD screen gently with a soft, lint-free cloth or an untreated lens-cleaning tissue.

CHAPTER 3

Taking Pictures

When the mode dial is set to Capture, the camera can perform the following functions:

- Capture a picture
- Preview pictures on the liquid crystal display (LCD)
- Delete a picture just taken
- Adjust the exposure
- Adjust some camera settings using the status display

Each of these functions is explained in this chapter.

Taking a Picture

To take a picture, perform the following steps:

1. Set the mode dial to Capture.

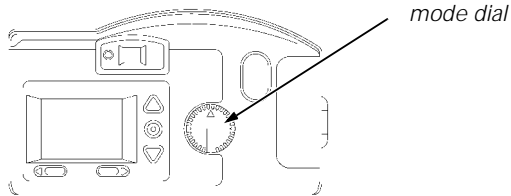

2. Turn on the camera.
3. Center subject in the viewfinder.
4. Press the shutter button.

The green Ready light, Memory Card icon, and Pictures Remaining number on the status display blink rapidly as the camera processes the picture.

NOTE: You do not need to hold the camera still while the green Ready light is blinking, but you will not be able to take another picture until it stops.

Previewing a Picture

You can use the LCD as a live viewfinder while in Capture mode. This function allows you to preview your picture before it is taken.

NOTE: Preview significantly shortens battery life.

To activate Preview, perform the following steps:

1. Set the mode dial to Capture.
2. Turn on the camera.
3. Press the Do-It button.

The LCD displays the subject that is viewed from the viewfinder with the icons of activated camera features.

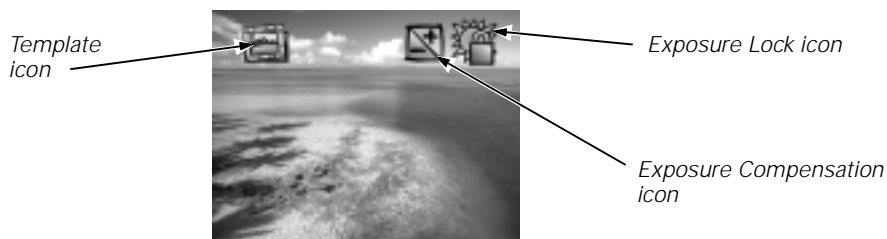

The Template icon appears if the template option is activated. Refer to "Template" in Chapter 5 for details.

The Exposure Lock icon appears if the exposure lock option is activated. Refer to "Turning On Exposure Lock" found later in this chapter for details.

The Exposure Compensation icon appears if the exposure value is adjusted. Refer to "Changing Exposure Compensation" found later in this chapter for details.

To exit Preview, press the Do-It button again. Preview automatically turns off when the camera is turned off.

Deleting the Picture Just Taken

NOTE: This delete feature is only available when the picture is shown on the LCD and the Quickview option is activated. Refer to "QuickView" in Chapter 5 for more details.

To delete the picture that was just taken without leaving Capture mode, perform the following steps:

1. Set the mode dial to Capture.
2. Turn on the camera.
3. Take a picture.

The picture is displayed on the LCD.

4. Press the ◀ button.

The delete screen appears in the LCD.

NOTE: The picture must be showing on the LCD screen to activate the delete screen.

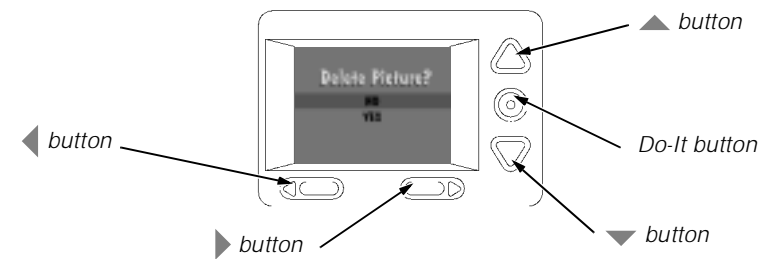

5. Press the ▲ or ▼ button until the correct delete option is highlighted.
6. Press the Do-It button.

The picture is deleted from the memory card.

To exit, press the ▲ or ▼ button until NO is highlighted, and then press the Do-It button.

Adjusting the Exposure Value

The camera's exposure value (EV) can be adjusted from -2.0 to +2.0 EV in 0.5 increments while in Capture mode. A +1.0 adjustment in EV doubles the amount of light allowed to reach the charge coupled device (CCD) in your camera. A -1.0 adjustment in EV halves the amount of light allowed to reach the CCD in your camera.

If your pictures are too dark, increase (+) the exposure compensation setting. If they are too light, decrease (-) the exposure compensation setting.

Changing Exposure Compensation

To change exposure compensation, perform the following steps:

1. Set the mode dial to Capture.
2. Turn the camera on.

3. Press the ► button.

The LCD displays the Exposure Compensation screen.

4. Press the ▲ and ▼ buttons to adjust the exposure.
5. Press Do-It to select the exposure setting.

The exposure setting automatically resets to 0.0 EV when the camera is turned off.

Turning On Exposure Lock

Use Exposure Lock to take a sequence of pictures that require the same exposure. When this setting is activated, the camera maintains a constant exposure setting. To turn on Exposure Lock, perform the following steps:

1. Set the mode dial to Capture.
2. Turn the camera on.
3. Press the ► button two times.

The Exposure Compensation screen appears, followed by the Exposure Lock screen.

NOTE: Press the ► button a third time to exit the Exposure menu.

4. Press the ▲ or ▼ button until ON is highlighted.
5. Press the Do-It button.

The Take a Picture screen appears.

6. In the viewfinder, center the area in which you want to lock the exposure.
7. Press the shutter button to lock in the exposure setting.

The Exposure Lock setting automatically resets when the camera is turned off.

Adjusting Camera Settings Using the Status Display

The status display, located at the top of your camera, allows you to view and change some camera settings. The following sections offer detailed descriptions of status display settings.

NOTE: The camera must be turned on to view the status display.

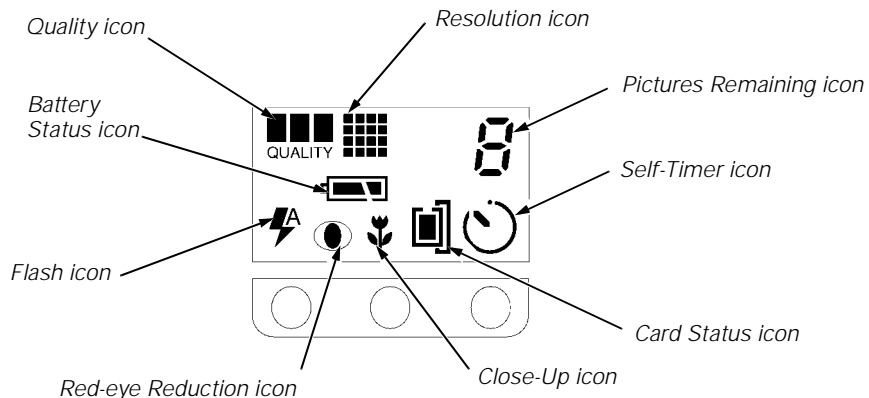

Pictures Remaining

The Pictures Remaining icon changes automatically to indicate the remaining number of pictures that can be stored at the current quality and resolution setting. You may not select or change the Pictures Remaining icon.

When the card's memory is full, the status display indicates **FULL**. You must delete existing pictures or change memory cards to capture additional pictures. To save pictures, transfer them to your computer before deleting them. For more information on how to move or delete pictures, see "Deleting the Picture Just Taken" found earlier in this chapter and "Deleting Pictures" in Chapter 4.

NOTE: The Pictures Remaining number does not always change by one when a picture is taken if the picture content is easily compressed.

Self-Timer

Activating the Self-Timer option creates a 10-second delay between the time you press the shutter button and when the picture is taken so you can include yourself in the picture. To activate this function, perform the following steps:

1. Set the mode dial to Capture.
2. Turn on the camera.
3. Press the self-timer button.

The Self-Timer icon appears on the status display.

4. Place the camera on a flat, steady surface or tripod.

5. Press the shutter button.

The red self-timer light, located on the front of the camera, turns on and stays lit for 8 seconds. The self-timer light flashes for 2 additional seconds just before the picture is taken. Self-Timer returns to the off setting once the picture is taken.

To stop this function, press the self-timer button again before the picture is taken.

Memory Card Status

The Card Status icon changes automatically to indicate if there is a memory card inserted in the camera. You may not select or change this icon.



No card inserted — Pictures cannot be taken.



Card inserted — Pictures are saved to the card's memory.

Close Up

The camera includes a close-up button that allows you to set the camera's focus distance at 8 inches (20 centimeters [cm]).

The red-eye reduction option for the flash setting is not available when Close Up is on.

NOTE: To accurately capture the picture in Close Up, the Preview option automatically starts when the close-up button is pressed. Refer to "Previewing a Picture" found earlier in this chapter for detailed information. To deactivate the Preview option, press the Do-It button.

To turn on the Close Up setting, perform the following steps:

1. Set the mode dial to Capture.
2. Turn on the camera.
3. Press the close-up button.

The Close Up icon appears on the status display.

4. View the subject on the LCD display to accurately capture the picture.

To cancel Close Up, press the close-up button again. The Close Up icon disappears from the status display. The Close Up setting is automatically turned off when the camera is turned off.

Flash

The camera is equipped with a built-in flash that offers an optional red-eye reduction feature. The flash has an effective range of approximately 1.6 to 9.8 feet (0.5 to 3 meters). There are five Flash settings:



Auto — Flash fires automatically when the shutter button is pressed and the camera determines that there is not enough light. This is the default setting.



Auto Red-eye — Works the same as Auto except the flash fires once before the picture is taken to reduce the chance of red-eye and then flashes a second time when the picture is taken.



Fill — Flash fires every time you press the shutter button. Use this setting when the lighting is poor or when your subject is lit from behind.



Fill Red-eye — Works the same as Fill flash setting except the flash fires once before the picture is taken to reduce the chance of red-eye and then flashes a second time when the picture is taken.



Off — Flash is turned off and does not fire.

To change the Flash setting, perform the following steps:

1. Set the mode dial to Capture.
2. Turn on the camera.
3. Press the flash button to scroll through and select the appropriate Flash settings.

Flash returns to its default setting when the camera is turned off.

Resolution

Resolution indicates the size of the picture in pixels. The camera can be set to capture pictures in a high or standard resolution. Your pictures include more detail with high resolution, but they will use more memory on the card than at the standard resolution setting.

You can switch freely between the two settings when taking pictures. The number of pictures the camera is able to store varies accordingly.

Resolution	Quality	Number of Pictures
High	Best	20
	Better	28
	Good	45
Standard	Best	41
	Better	57
	Good	87

The Resolution setting is indicated on the status display using the following icons:



High — Picture size is 1152 x 864 pixels. This is the default setting. Use this setting when your pictures are to be printed.



Standard — Picture size is 640 x 480 pixels. Use this setting when the pictures are for e-mail or online use.

The Resolution setting is changed using the Preferences mode. Refer to “Resolution” in Chapter 5 for more information.

Quality

You may set your camera to capture pictures in a Good, Better, or Best quality setting. The Quality setting indicates how much the picture is compressed to save space on the memory card. Your pictures include more detail with the Best or Better setting, but they will use more memory on the card than with the Good setting.

You may switch freely between the three settings when taking pictures. The number of pictures the camera can store varies accordingly (refer to the picture count table in the previous subsection).

The Quality setting is indicated on the status display using the following icons:



Good — Use this setting to maximize the number of pictures stored. Pictures taken with this setting are suitable for computer and TV viewing.



Better — Use this setting for general picture taking and to store a large number of pictures.



Best — Use this setting when image quality is very important for maximum picture quality, especially for larger sized or zoom prints.

The Quality setting is changed using the Preferences mode. See “Quality” in Chapter 5 for more information.

Battery Status

The camera comes with four Kodak Photolife AA batteries. Standard 1.5-V alkaline, 1.5-V lithium, or rechargeable 1.2-V nickel cadmium (Ni-Cd) or nickel metal hydride (Ni-MH) batteries may be used.

The battery power icon changes automatically. You may not select or change this icon.

NOTE: To retain the Date/Time setting, replace the batteries as soon as the battery power icon begins to blink.



Full — Batteries are fully charged.



Low — Batteries need to be replaced.



Blinking — Batteries are insufficient to run camera and need to be replaced.

NOTE: Pictures on memory cards are not lost if the batteries are depleted.

Activating the Zoom

The camera includes a 2X zoom lens that allows you to zoom in on your subject from wide angle (29 millimeters [mm]) to telephoto (58 mm).

wide angle



telephoto



To activate the zoom, perform the following steps:

1. Set the mode dial to Capture.
2. Turn on the camera.
3. Press the zoom button.

The subject appears closer or farther away when you look through the viewfinder and press the zoom button.

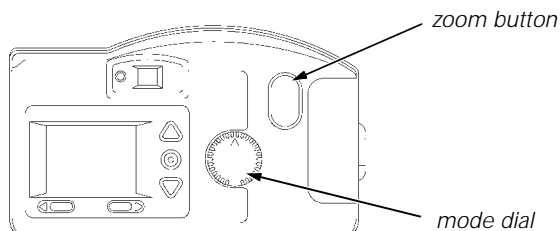

The camera's default lens position is wide angle. All other lens positions are considered telephoto settings.

CHAPTER 4

Reviewing Pictures

When the mode dial is set to Review, you may use the liquid crystal display (LCD) to view the pictures stored on the memory card. Using the Overlay screen, the camera can perform the following functions:

- View the amount of unused memory left on the memory card
- View thumbnails of the pictures
- Delete one or all pictures from the memory card
- View pictures and run a slide show from the camera on your TV

NOTE: To conserve battery life, Dell recommends that you use the AC adapter with the camera when it is in Review mode.

Viewing Pictures on the Camera

To view pictures on the camera, perform the following steps:

1. Set the mode dial to Review.
2. Turn on the camera.

The Overlay screen appears on the LCD screen with the last picture taken.

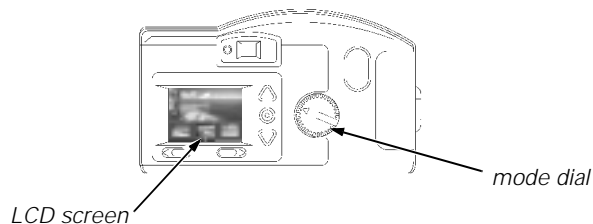

3. Press the ◀ and ▶ buttons to scroll through the pictures. To continuously scroll, hold down one of these buttons.

The memory bar displays the space left on the memory card and the current picture position.

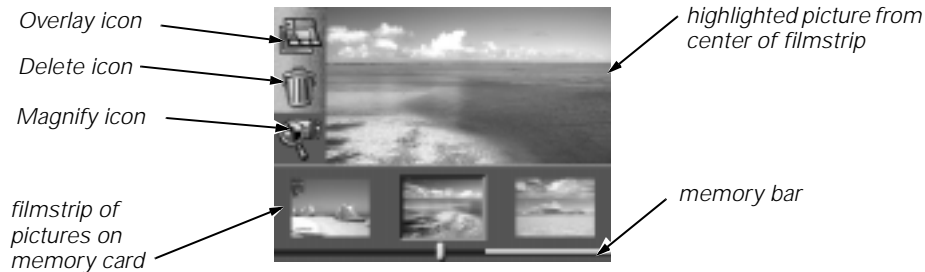

To exit the Overlay screen, press the ▲ or ▼ button to highlight the Overlay icon. Then press the Do-It button to turn off the Overlay screen. The main Review screen reappears.

Deleting Pictures

You can delete one or all of the pictures on the memory card when in the Review mode. To delete a picture in Review mode, perform the following steps:

1. Set the mode dial to Review.
2. Turn on the camera.

The last picture taken appears on the LCD screen. The Overlay screen is turned on.

3. Press a ▲ or ▼ button until the Delete icon is highlighted.
4. Press the Do-It button.

The delete screen appears on the LCD.

5. Press a ◀ or ▶ button until the appropriate picture is highlighted on the filmstrip.

NOTE: To delete all the pictures on the memory card, press a ▲ or ▼ button until ALL PICTURES is highlighted and then press the Do-It button.

6. Press the Do-It button.

That picture is deleted from the memory card.

To exit the Overlay screen, press the ▲ or ▼ button to highlight the Overlay icon. Then press the Do-It button to turn off the Overlay screen. The main Review screen reappears.

NOTE: Memory cards containing images captured from other digital cameras have less memory space available when used in the DC210+ camera. To free up memory space on

the memory card, you must delete the images in the camera model that captured those images.

Magnifying Pictures

The Magnify feature allows you to view the current picture at 2x size on the LCD screen when in Review mode. To magnify a picture in Review mode, perform the following steps:

1. Set the mode dial to Review.
2. Turn on the camera.

The last picture taken appears on the LCD screen. The Overlay screen is turned on.

3. Press a ◀ or ▶ button until the appropriate picture is highlighted on the filmstrip.
4. Press a ▲ or ▼ button until the Magnify icon is highlighted.
5. Press the Do-It button.

The LCD displays a magnified view of the selected picture.

6. Use the ◀, ▶, ▲, or ▼ buttons to scroll to different parts of the picture.

To cancel the Magnify feature, press the Do-It button. The Overlay screen reappears.

To exit the Overlay screen, press the ▲ or ▼ button to highlight the Overlay icon. Then press the Do-It button to turn off the Overlay screen. The main Review screen reappears.

Viewing Pictures or Running a Slide Show on a TV

The Video-out feature allows you to connect the camera to a TV and then view or run a slide show of the pictures from the memory card on your TV. This feature is especially useful when sharing pictures with family and friends.

NOTE: The camera's LCD screen is disabled when the video output cable is attached to the camera.

To view pictures on a TV, perform the following steps:

1. Turn off your TV and the camera.
2. Insert the video output cable into the video-out connection on the side of your camera.

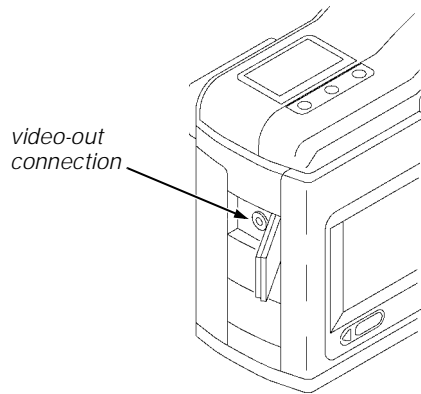

3. Connect the other end of the cable to the video-in connection on your TV.
4. Turn on the camera and TV.
5. Set the mode dial on the camera to Review.
6. Set the TV to the correct video setting.

The pictures that are stored on the memory card appear on the TV screen.

NOTE: You may need to adjust the Video Out preference on the camera. Refer to "Video Out" in Chapter 5 for details.

7. Press a ◀ or ▶ button on the camera to scroll through the pictures on the TV.

To run a slide show, press the Do-It button. The slide show starts, and the pictures change every five seconds for a period of five minutes. If you are using an AC adapter, the slide show runs indefinitely.

To cancel the slide show, press the Do-It button. The slide show stops and the main Review screen reappears.

CHAPTER 5

Adjusting Camera Settings

When the mode dial is set to Preferences, the main Preferences screen appears on the liquid crystal display (LCD). The Preferences screen, illustrated below, allows you to adjust or activate the following camera settings:

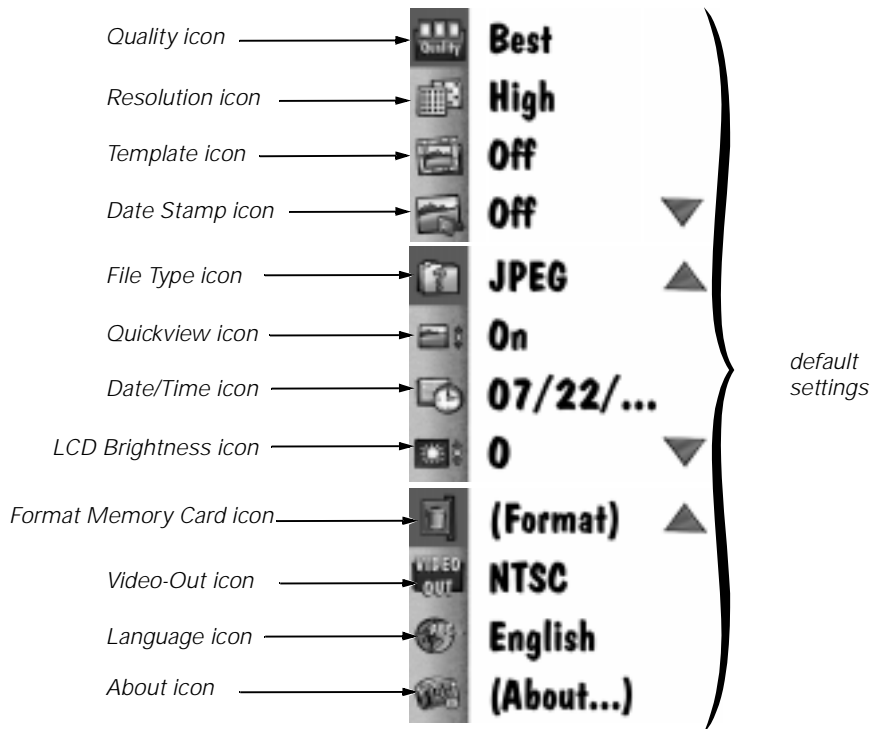

The following sections describe each of these settings.

Quality

The Quality screen sets the picture quality to Best, Better, or Good. Refer to “Quality” in Chapter 3 for more information on picture quality. To set quality, perform the following steps:

1. Set the mode dial to Preferences.

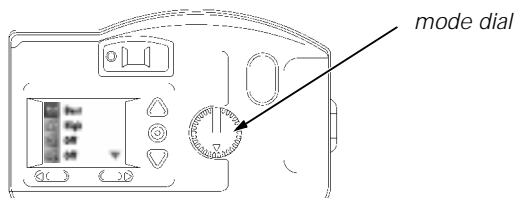

2. Turn on the camera.

The LCD displays the Preferences screen.

3. Press the ▼ button until the Quality icon (shown below) is highlighted.



4. Press the Do-It button.

The LCD displays the main Quality screen. The current setting is checked (✓).



5. Press a ▲ or ▼ button until the appropriate option is highlighted.
6. Press the Do-It button.

The main Preferences screen reappears.

The Quality setting is maintained until another setting is selected. This setting does *not* change when the camera is turned off.

Resolution

The Resolution screen sets the picture resolution to High (1152 x 864 pixels) or Standard (640 x 480 pixels). Refer to "Resolution" in Chapter 3 for more information on picture resolution.

To set resolution, perform the following steps:

1. Set the mode dial to Preferences.
2. Turn on the camera.

The LCD displays the Preferences screen.

3. Press the ▼ button until the Resolution icon (shown below) is highlighted.



4. Press the Do-It button.

The LCD displays the main Resolution screen. The current setting is checked (✓).

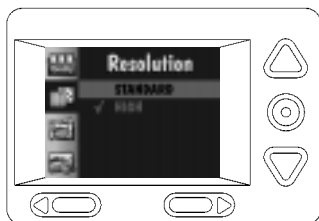

5. Press a ▲ or ▼ button until the appropriate option is highlighted.
6. Press the Do-It button.

The main Preferences screen reappears.

The Resolution setting is maintained until another setting is selected. This setting does *not* change when the camera is turned off.

Template

The Template screen selects a creative border and/or logo that is added to your picture when you take it. The memory card supplied with your camera includes seven templates.

NOTE: If you take a picture with the template feature activated, the template cannot be removed from that picture.

To select a template, perform the following steps:

1. Set the mode dial to Preferences.
2. Turn on the camera.

The LCD displays the Preferences screen.

3. Press the ▼ button until the Template icon (shown below) is highlighted.



4. Press the Do-It button.

The LCD displays the main Template screen. The current setting is checked (✓).

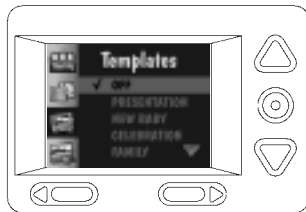

5. Press a ▲ or ▼ button until the appropriate option is highlighted.
6. Press the Do-It button.

The main Preferences screen reappears.

NOTE: The template is visible after the picture has been taken with the camera in either Review mode or in Capture mode with Quickview activated.

To turn off the template feature, press a ▲ or ▼ button until OFF is highlighted, and then press the Do-It button. The Template setting is maintained until another setting is selected. This setting does *not* change when the camera is turned off.

Date Stamp

The Date Stamp screen records the date on your pictures. To turn on Date Stamp, perform the following steps:

1. Set the mode dial to Preferences.
2. Turn on the camera.

The LCD displays the Preferences screen.

3. Press the ▼ button until the Date Stamp icon (shown below) is highlighted.



4. Press the Do-It button.

The LCD displays the main Date Stamp screen. The current setting is checked (✓).



5. Press a ▲ or ▼ button until the appropriate date stamp order is highlighted.
6. Press the Do-It button.

The main Preferences screen reappears.

The next time you take a picture the date stamp appears in the lower right-hand corner of the picture on the LCD screen.

NOTE: The date stamp is visible after the picture has been taken with the camera in either Review mode or in Capture mode with Quickview activated. The date stamp cannot be removed from that picture.

To turn off a date stamp, press a ▲ or ▼ button until OFF is highlighted, and then press the Do-It button. The Date Stamp setting is maintained until another setting is selected. This setting does *not* change when the camera is turned off.

File Type

The File Type screen selects how the picture file is saved, in a FlashPix™ or JPEG (default setting) format. Select a format that is compatible with the software you use on your computer.

NOTE: The Picture Easy software Dell installed on your system for use with the digital camera supports both formats.

To set the file type, perform the following steps:

1. Set the mode dial to Preferences.
2. Turn on the camera.

The LCD displays the Preferences screen.

3. Press the ▼ button until the File Type icon (shown below) is highlighted on the Preferences screen.



4. Press the Do-It button.

The LCD displays the main File Type screen. The current setting is checked (✓).

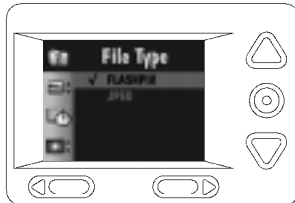

5. Press a ▲ or ▼ button until the appropriate option is highlighted.
6. Press the Do-It button.

The main Preferences screen reappears.

The File Type setting is maintained until another setting is selected. This setting does *not* change when the camera is turned off.

Quickview

The Quickview screen turns the camera's Quickview setting on or off. When you take a picture with Quickview on, the picture momentarily appears on the LCD screen seconds after the picture is taken.

NOTE: The Quickview option must be activated to use the delete feature available in Capture mode. Refer to "Deleting the Picture Just Taken" in Chapter 3 for more details.

To turn on Quickview, perform the following steps:

1. Set the mode dial to Preferences.
2. Turn on the camera.

The LCD displays the Preferences screen.

3. Press the ▼ button until the Quickview icon (shown below) is highlighted on the second Preferences screen.



4. Press the Do-It button.

The LCD displays the main Quickview screen. The current setting is checked (✓).

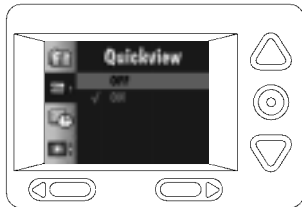

5. Press a ▲ or ▼ button until ON is highlighted.
6. Press the Do-It button.

The main Preferences screen reappears.

The next time you take a picture, it appears for a moment on the LCD screen.

To turn off Quickview, press a ▲ or ▼ button until OFF is highlighted, and then press the Do-It button. The Quickview setting is maintained until another setting is selected. This setting does *not* change when the camera is turned off.

Date and Time

The Date and Time screen sets the camera's date and time. To set the date and time, perform the following steps:

1. Set the mode dial to Preferences.
2. Turn on the camera.

The LCD displays the Preferences screen.

3. Press the ▼ button until the Date/Time icon (shown below) is highlighted on the Preferences screen.



4. Press the Do-It button.

The LCD displays the main Date/Time screen with the current date and time listed.

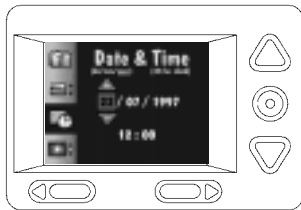

5. Press a ◀ or ▶ button to highlight the day, month, year, hour, or minute setting.
6. Press a ▲ or ▼ button to adjust the setting.
7. Repeat steps 5 and 6 until the information is correct.
8. Press the Do-It button.

The main Preferences screen reappears.

The date and time setting is maintained until another setting is selected. This setting does *not* change when the camera is turned off.

NOTE: If you remove the batteries from the camera for more than a few minutes or when the camera is on, the Date/Time setting is deleted and must be reset.

LCD Brightness

The LCD Brightness screen adjusts the brightness of the camera's LCD screen. To make an adjustment, perform the following steps:

1. Set the mode dial to Preferences.
2. Turn on the camera.

The LCD displays the Preferences screen.

3. Press the ▼ button until the LCD Brightness icon (shown below) is highlighted on the Preferences screen.



4. Press the Do-It button.

The LCD displays the main LCD Brightness screen.

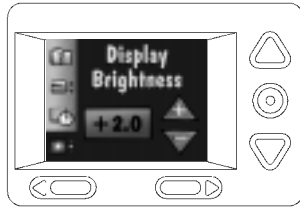

5. Press a ▲ or ▼ button to adjust the brightness of the LCD screen to the appropriate level.

The brightness of the LCD screen changes as the setting is adjusted.

6. Press the Do-It button.

The main Preferences screen reappears.

The LCD Brightness setting is maintained until another setting is selected. This setting does *not* change when the camera is turned off.

Format Memory Card

The Format Memory Card screen formats the memory card while it is in the camera and sets up new directories and pointers on the card.

CAUTION: When a memory card is formatted it erases everything on the card, including any pictures and templates. The templates cannot be restored without a memory card reader.

To format a memory card, perform the following steps:

1. Set the mode dial to Preferences.
2. Turn on the camera.

The LCD displays the Preferences screen.

3. Press the ▼ button until the Format Memory Card icon (shown below) is highlighted on the Preferences screen.



4. Press the Do-It button.

The LCD displays the main Format Memory Card screen.



5. To format the card, press the ▼ button until CONTINUE FORMAT is highlighted. Then press the Do-It button.

To stop the formatting operation, press a ▲ or ▼ button until CANCEL FORMAT is highlighted, and then press the Do-It button.

Video Out

The Video Out screen sets the camera's video output to National Television Standards Committee (NTSC) or Phase Alternating Line (PAL) format. The video-out format selected depends on your TV or video monitor. In most cases European countries use a PAL format, and other countries use an NTSC format.

To set the video-out format, perform the following steps:

1. Set the mode dial to Preferences.
2. Turn on the camera.

The LCD displays the Preferences screen.

3. Press the ▼ button until the Video Out icon (shown below) is highlighted on the Preferences screen.



4. Press the Do-It button.

The LCD displays the main Video Out screen. The current setting is checked (✓).

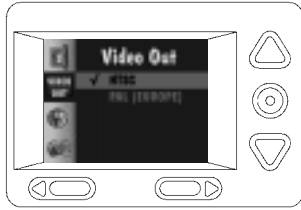

5. Press a ▲ or ▼ button until the appropriate option is highlighted.
6. Press the Do-It button.

The main Preferences screen reappears.

The Video Out setting is maintained until another setting is selected. This setting does *not* change when the camera is turned off.

Language

The Language screen selects a language interface for the camera. When you choose a specific language, the LCD screens on the back of the camera change to reflect the selected language.

To select a language, perform the following steps:

1. Set the mode dial to Preferences.
2. Turn on the camera.

The LCD displays the Preferences screen.

3. Press the ▼ button until the Language icon (shown below) is highlighted on the Preferences screen.



4. Press the Do-It button.

The LCD displays the main Language screen. The current setting is checked (✓).



5. Press a ▲ or ▼ button until the appropriate language is highlighted.
6. Press the Do-It button.

The main Preferences screen reappears.

The language setting is maintained until another setting is selected. This setting does *not* change when the camera is turned off.

About

The About screen is a view-only screen that keeps a record of the camera's use. It provides the following information:

- Firmware version
- Total number of pictures taken over the lifetime of the camera
- Total number of flashes fired over the lifetime of the camera

To view the About screen, perform the following steps:

1. Set the mode dial to Preferences.
2. Turn on the camera.

The LCD displays the Preferences screen.

3. Press the ▼ button until the About icon (shown below) is highlighted on the Preferences screen.



4. Press the Do-It button.

The LCD displays the About screen.

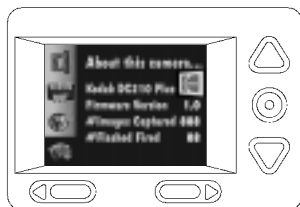

5. Press the Do-It button to return to the main Preferences screen.

CHAPTER 6

Transferring Pictures From the Camera to the Computer

This chapter explains how to connect the camera to your Dell® computer and start the Picture Easy software.

Serial Cable Connection

To connect the camera to your Dell computer with the serial cable provided with your camera, perform the following steps:

1. Set the mode dial to Connect.

NOTE: While in Connect mode the camera is controlled by the computer. Except for the mode dial and power button, all other camera buttons are ignored. The Ready light indicates when the camera is on.

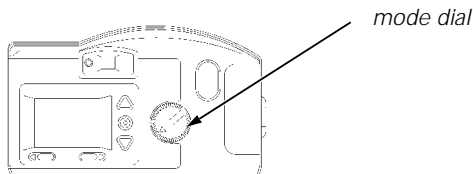

2. Plug one end of the serial cable into the 9-pin serial (COM) port on the back of your computer.

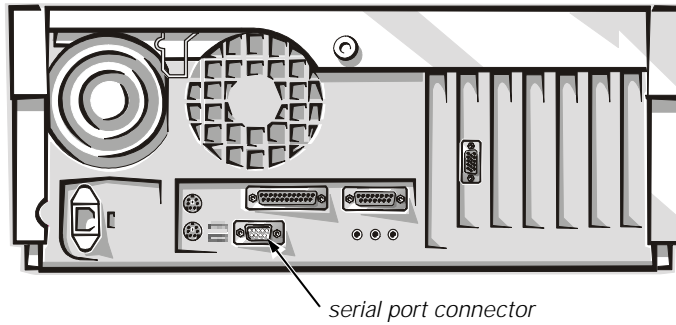

3. Open the serial port door on the side of your camera.

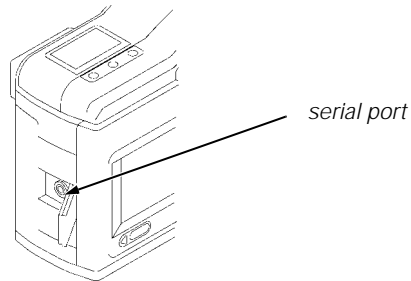

4. Plug the other end of the serial cable into the camera's serial port.
5. Insert the AC adapter into the AC adapter connection on the side of your camera.

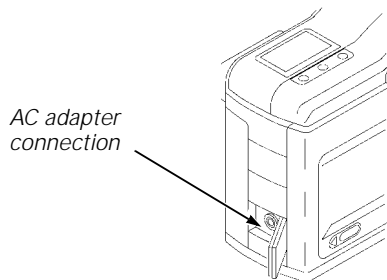

6. Connect the other end of the AC adapter to a wall outlet.

7. Turn on the camera.

When the camera is correctly connected to your computer, three squares rotate on the status display:

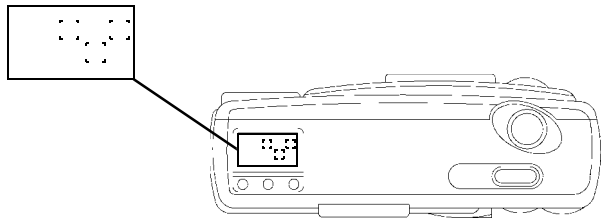

8. Turn on your computer system.
9. Start the Picture Easy software by double-clicking the **Picture Easy** icon on your Windows desktop.



You can also start the software by clicking the **Start** button, pointing to **Programs—> Kodak—> Picture Easy Software**, and clicking **Picture Easy**.

For more information on this software, refer to the "Using the Picture Easy Software" section of the online *KODAK DIGITAL SCIENCE DC210 Plus Zoom Camera User's Guide*. The guide can be accessed by clicking the **Start** button, pointing to **Programs—> Dell Documents**, and clicking **Kodak DC210+ Camera User's Guide**.

To cancel the connection, turn the mode dial to another setting or turn off the camera.

Infrared Connection

Your computer must be set up with an infrared connection before the camera's infrared transceiver can be used.

NOTE: If you are using the camera's infrared transceiver to connect to the computer and the camera automatically turns off because of inactivity, you need to press the camera's power button to turn the camera back on.

CHAPTER 7

Troubleshooting

This chapter provides tips and troubleshooting solutions for common problems you may experience while using your camera and software. If you are experiencing difficulties with your camera, check the sections for possible solutions.

Monitor Checks

Problem	Cause	Solution
The image on your monitor is jagged or inappropriately colored.	Monitor is not set correctly.	Adjust your monitor display settings as described in "Monitor Adjustments" found later in this chapter.

Memory Card Checks

Problem	Cause	Solution
The camera does not recognize your memory card.	The memory card may not be ATA-compatible.	Memory cards must be ATA-compatible to work with the camera.
	The memory card may contain compression or stacker software.	Reformat any memory cards that contain compression or stacker software. Refer to the memory card documentation or "Format Memory Card" in Chapter 5 for instructions on reformatting the card.

Camera Checks

Problem	Cause	Solution
Ready light does not turn on and the camera does not work.	Camera is not turned on.	Turn on the camera and verify that the green Ready light turns on.
	Batteries are low or empty.	Replace the batteries. Pictures remain in the camera's memory when the battery is removed.
Shutter button does not work.	Camera is not turned on.	Turn on the camera and verify that the green Ready light turns on.
	Mode dial is not set to Capture.	Set the mode dial to Capture.
	Ready light is blinking. Camera is processing picture.	Wait until Ready light stops blinking before attempting to take another picture.
	The status display reads Full. The memory card is full.	Transfer pictures to your computer or insert a memory card that has available memory.
	Camera is connected to the computer.	Disconnect camera from computer.
Camera does not turn on.	Batteries are not properly installed.	Remove the batteries and install them according to the directions on the outside of the battery door.
	Batteries are weak or dead.	Install new batteries.
Part of the picture is missing.	Something was blocking the lens when you took the picture.	Keep hands, fingers, or other objects away from the lens when taking pictures.
	Your eye or the picture was not centered correctly in the viewfinder.	Leave space around the subject when centering the picture in the viewfinder.

Problem	Cause	Solution
Picture is too dark.	Flash is not on or did not go off.	Turn on the flash. Refer to "Flash" in Chapter 3.
	The subject is too far away from the flash.	Move so there is no more than 10 ft (3 m) between the camera and the subject.
	The subject is in front of a bright light.	Change your position so the light is not behind the subject.
Picture is too light.	The flash is not needed.	Change to automatic flash. Refer to "Flash" in Chapter 3.
	The subject was too close when you used the flash.	Move so there is at least 1.6 ft (0.5 m) between the camera and the subject.
	The light sensor is covered.	Hold the camera so your hands or other objects do not cover the light sensor.
Stored pictures are damaged.	The memory card was removed when the Ready light was blinking.	Make sure the Ready light is not blinking before removing the memory card.
Pictures remaining number does not decrease.	The image resolution does not take up sufficient space to decrease the picture remaining number.	The camera is operating normally. Continue taking pictures.
Picture is not clear.	The lens is dirty.	Clean the lens. Refer to "Caring for the Camera" in Chapter 2.
	The subject was too close when you took the picture.	Move so that there is at least 1.6 ft (0.5 m) between the camera and the subject. Stand at least 8 in (20 cm) away for close-ups and at least 3.28 ft (1 m) for telephoto pictures.
	Subject or camera moved during picture taking.	Hold camera steady during picture taking until after the flash (or the second flash if the camera flash is set for red-eye reduction).
Templates do not work.	The memory card may not contain the templates.	Only the original memory card contains templates. Templates are lost when the memory card is formatted. Instructions for replacing the templates can be found on the Kodak Web site at www.kodak.com .

Problem	Cause	Solution
Date and time lost.	Date and time information is lost if the batteries totally discharge.	Change the batteries before they totally discharge. Do not open the battery door while the camera is on.

LCD Messages

Message	Cause	Solution
Memory Card is Full.	Memory card is full and cannot hold additional pictures.	Transfer pictures to your computer or insert a memory card that has available memory.
No Memory Card.	There is no memory card inserted in the camera.	Insert a memory card in the camera.
Cannot read memory card.	Memory card is corrupted.	Insert a new memory card or format the memory card.
Cannot establish connection.	The camera cannot communicate with the computer.	Make sure the camera is connected to the computer's serial port.
Camera needs service.	The camera is malfunctioning.	Contact Dell for camera service or repair. Refer to "Getting Help" found later in this chapter.

Printing Tips

You may notice that the colors on your computer screen do not always match those in your documents or prints. This happens because monitors and printers use different color systems.

You may be able to achieve more predictable results in your printed documents by taking the following actions:

- Improve the quality of your paper. Copier paper may not offer the same results as coated paper or paper made especially for inkjet printers.
- Adjust your printer software settings.
- Use fresh ink cartridges. Do not use ink cartridges beyond their life expectancy.

Keep these tips in mind when printing:

- Color printing takes more time. Complex documents require more printing and drying time.
- Color printing is more memory intensive than black and white. If your computer gives you an insufficient memory message, you may need to close some application programs, change some settings, or add additional memory.
- Color prints may not photocopy as clearly as black and white. If you plan to photocopy documents, consider printing the document in gray scale. This setting is usually changed from the **Print** menu.
- Resizing the picture to a smaller size or printing the picture on glossy paper may increase the quality of the print.

To improve the quality of your prints, you may want to print your pictures on KODAK DIGITAL SCIENCE snapshot paper. This paper works with most inkjet printers and gives you clearer, crisper, and more detailed images on your prints.

Monitor Adjustment

Your monitor display settings may need to be adjusted to view pictures from the camera. To do so, perform the following steps:

1. Double-click the **My Computer** icon.
2. Double-click the **Control Panel** icon.
3. Double-click the **Display** icon and click the **Settings** tab.
4. Select the highest available setting for **Color Palette** and click the **OK** button.

Reinstalling the Camera Software

To reinstall the camera software, perform the following steps:

1. Close all open application programs.
2. Place the camera software CD into your CD-ROM drive.
3. In the **Welcome** window, click the **Next** button.
4. Read the license agreement, and click the **Yes** button to accept the software license agreement.

If you do not accept the license you cannot install the software.

5. Select the software item you want to install and click the **Next** button.
6. Select the name of the program folder and click the **Next** button.

If necessary, type a new folder name or select from the **Existing Folders** list.

7. Verify the settings, and then click the **Next** button.

A progress screen appears while the software is installed.

8. Select the preferred restart option and click the **Finish** button.

NOTE: If you installed the mounter software you must restart your computer.

Getting Help

Additional tips and troubleshooting instructions are available on the Kodak Web site at **www.kodak.com**. If problems persist, contact Dell Computer Corporation for technical assistance (refer to the "Getting Help" chapter of your system *Reference and Troubleshooting Guide*).

Index

A

- AC adapter
 - connecting, 2-3
- accessories, 1-2
- adjusting the exposure value, 3-3

B

- batteries
 - installing, 2-1
 - removing, 2-1
 - status, 3-9
 - types, 2-1, 2-2, 3-9
 - usage guidelines, 2-2

C

- camera
 - accessories, 1-2
 - features, 1-1, 1-3
 - package contents, 1-1
 - software, 1-2
 - troubleshooting, 7-2
 - viewing information about, 5-12
- camera modes
 - about, 1-1
 - Capture, 3-1
 - Preferences, 5-1
 - Review, 4-1
- camera settings
 - About, 5-12
 - adjusting, 3-5
 - Date and Time, 5-7
 - Date Stamp, 5-4

- camera settings (*continued*)
 - File Type, 5-5
 - Format Memory Card, 5-9
 - Language, 5-11
 - LCD Screen Brightness, 5-8
 - Quality, 5-2
 - QuickView, 5-6
 - Resolution, 5-3
 - Template, 5-3
 - Video Out, 5-10

- camera settings, changing
 - activating Self-Timer, 3-5
 - selecting Flash settings, 3-7
 - selecting quality setting, 3-8
 - selecting the resolution, 3-7
 - zooming, 3-10

Capture mode, 3-1

Close Up icon, 3-6

connecting AC adapter, 2-3, 6-2

connecting the camera to a computer

- infrared connection, 6-3
- using serial cable, 6-1

connecting the camera to a TV, 4-3

D

- dark pictures, 3-3
- date stamp, 5-4
- date, setting, 5-7
- deleting last picture taken, 3-2
- deleting one or all pictures, 4-2

E

- error messages, 7-4
- exposure
 - compensating for dark or light pictures, 3-3
- Exposure Compensation icon, 3-2
- Exposure Lock icon, 3-2

F

- file types, 5-5
- Flash settings, 3-7
- FlashPix file format, 5-5
- formatting memory cards, 5-9

G

- getting help, 7-6

I

- infrared connection, 6-3
- inserting a memory card, 2-2
- installing batteries, 2-1

J

- JPEG file format, 5-5

L

- language, setting, 5-11
- LCD messages, 7-4
- LCD screen brightness, 5-8
- light pictures, 3-3

M

- magnifying a picture in Review mode, 4-3
- memory card
 - deleting pictures from, 4-2
 - formatting, 5-9
 - inserting and removing, 2-2
 - Memory Card icon, 3-6
 - troubleshooting, 7-1
 - viewing available memory, 4-1
 - viewing pictures on, 4-1
- Memory Card icon, 3-6
- messages, 7-4
- monitor
 - adjustments, 7-5
 - checks, 7-1
- mounter software, 1-2

N

- NTSC format, 5-10

O

- Overlay screen, 4-1

P

- PAL format, 5-10
- Picture Easy software, 1-2, 6-3
- picture quality, 3-8, 5-2
- Pictures Remaining icon, 3-5
- Preferences mode, 5-1
- Preferences screens
 - About, 5-12
 - about, 5-1
 - Date Stamp, 5-4
 - Date/Time, 5-7
 - File Type, 5-5

Preferences screens (*continued*)
Format Memory Card, 5-9
Language, 5-11
LCD Screen Brightness, 5-8
Quality, 5-2
Quickview, 5-6
Resolution, 5-3
Template, 5-3
Video Out, 5-10

Preview
 exiting, 3-2
 Exposure Compensation icon, 3-2
 Exposure Lock icon, 3-2
 Template icon, 3-2

previewing a picture, 3-2
previewing a picture just after taking it, 5-6
printing tips, 7-4

Q

Quality icon, 3-8
Quickview option, 5-6

R

reinstalling software, 7-5
removing a memory card, 2-2
resolution, 3-7, 5-3
Review mode, 4-1

S

safety instructions, v
screen brightness, 5-8
Self-Timer icon, 3-5
serial cable connection, 6-1
setting the date, 5-7

setting the language, 5-11
setting the resolution, 3-7
setting the Self-Timer option, 3-5
setting the time, 5-7
slide show, 4-4
software
 about, 1-2
 mounter, 1-2
 Picture Easy, 1-2, 6-3
 reinstalling, 7-5
 TWAIN, 1-2
status display
 icons, 3-5

T

taking pictures, 3-1
 adjusting the exposure value, 3-3
technical assistance, 7-6
Template icon, 3-2
templates, using, 5-3
time, setting, 5-7
troubleshooting
 camera checks, 7-2
 getting help, 7-6
 LCD messages, 7-4
 memory card checks, 7-1
 monitor adjustments, 7-5
 monitor checks, 7-1
 printing tips, 7-4
 reinstalling camera software, 7-5
TWAIN software, 1-2

V

video output format, 5-10
viewing a slide show on TV, 4-4
viewing available memory, 4-1

viewing camera information, 5-12
viewing pictures on memory card, 4-1
viewing pictures on TV, 4-3

Z

zooming, 3-10

Printed in the U.S.A.



P/N 3066D

Free Manuals Download Website

<http://myh66.com>

<http://usermanuals.us>

<http://www.somanuals.com>

<http://www.4manuals.cc>

<http://www.manual-lib.com>

<http://www.404manual.com>

<http://www.luxmanual.com>

<http://aubethermostatmanual.com>

Golf course search by state

<http://golfingnear.com>

Email search by domain

<http://emailbydomain.com>

Auto manuals search

<http://auto.somanuals.com>

TV manuals search

<http://tv.somanuals.com>