KODAK EASYSHARE Camera / Z5010



Extended user guide

www.kodak.com

For help with your camera:

www.kodak.com/go/Z5010support

Kodak

Eastman Kodak Company

Rochester, New York 14650

© Eastman Kodak Company, 2011

All screen images are simulated.

Kodak, EasyShare, and Pulse are trademarks of Eastman Kodak Company.

4H8713_en

Front view

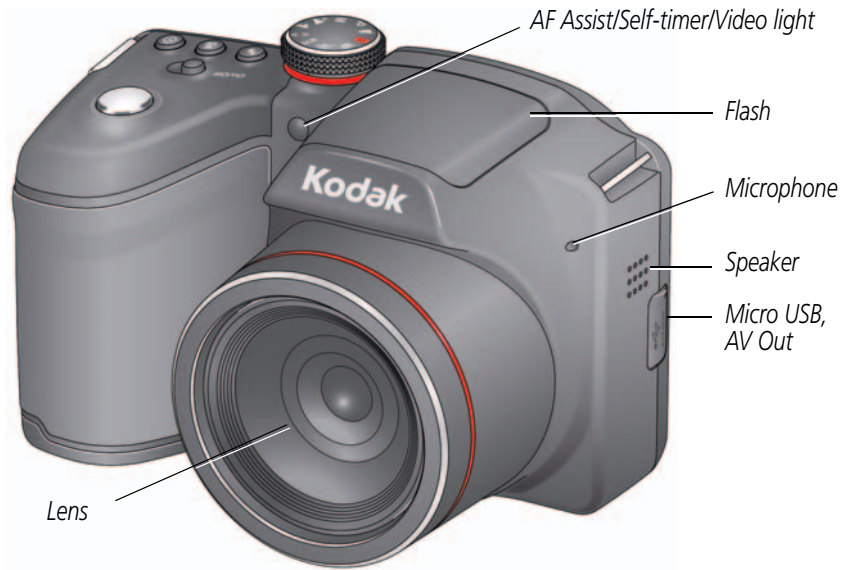

Back view

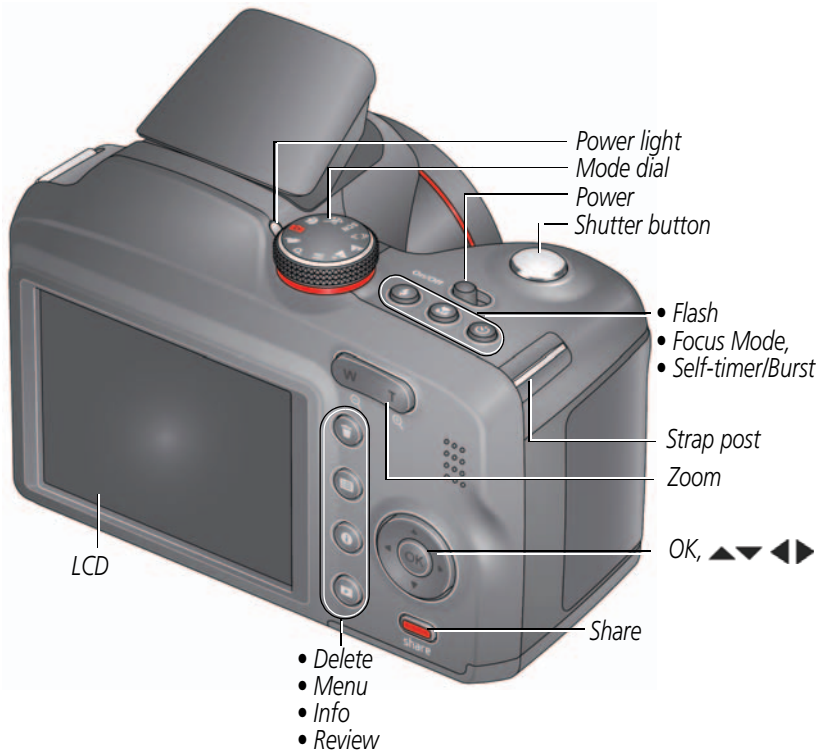

Bottom view



Table of contents

1	Setting up your camera	1
	Charging the rechargeable batteries	1
	Loading the batteries	2
	Turning on the camera	3
	Setting the language and date/time	3
	Storing pictures on an accessory SD/SDHC Card	4
	Attaching the strap	5
2	Taking pictures/videos	6
	Taking pictures in Smart Capture mode	6
	Understanding the picture-taking icons	8
	Watch the battery level	8
	Taking videos	9
	Using the zoom	10
	Using the flash	11
	Using the Focus feature	12
	Using the Self-timer feature	13
	Using the Burst feature	14
	Using different modes	15
	Using SCN (Scene) modes	16
	Program and Manual modes	17
	Using the histogram to view picture brightness	19
	Using exposure compensation to adjust brightness	19
	Taking panoramic pictures	20
	Turning on the Date Stamp feature	21

3	Reviewing and editing	22
	Reviewing pictures/videos	22
	Deleting pictures/videos	23
	Viewing pictures/videos in different ways	24
	A smarter way to find and enjoy your pictures	25
	Understanding the review icons	26
	Cropping pictures	27
	Trimming a video	27
	Making a picture from a video	28
	Making an action print from a video	28
	Selecting multiple pictures/videos	28
	Displaying pictures/videos on a television	29
4	Sharing pictures/videos	30
	Sharing pictures/videos through social networks	30
	Tagging pictures	32
	Marking pictures/videos for emailing	34
5	Doing more with your camera	35
	Using the Capture menu	35
	Using the Setup menu	37
6	Install software	40
	Install software, transfer pictures, and share	40
	Printing pictures	41
	Marking your pictures for print	42
7	Troubleshooting	43
	Getting help on the Web	47

8 Appendix	48
Specifications	48
Care and maintenance	50
Upgrading your software and firmware.....	50
Storage capacities	51
Important safety instructions	51
Battery replacement, battery life	52
Limited warranty	53
Regulatory compliance	54

1

Setting up your camera

IMPORTANT! If your package includes:

- Ni-MH batteries and a charger, continue to [Charging the rechargeable batteries](#).
- Alkaline batteries (and no charger), skip to [Loading the batteries, page 2](#). (You may purchase Ni-MH rechargeable AA batteries and a charger at www.kodak.com/go/accessories.)

Charging the rechargeable batteries

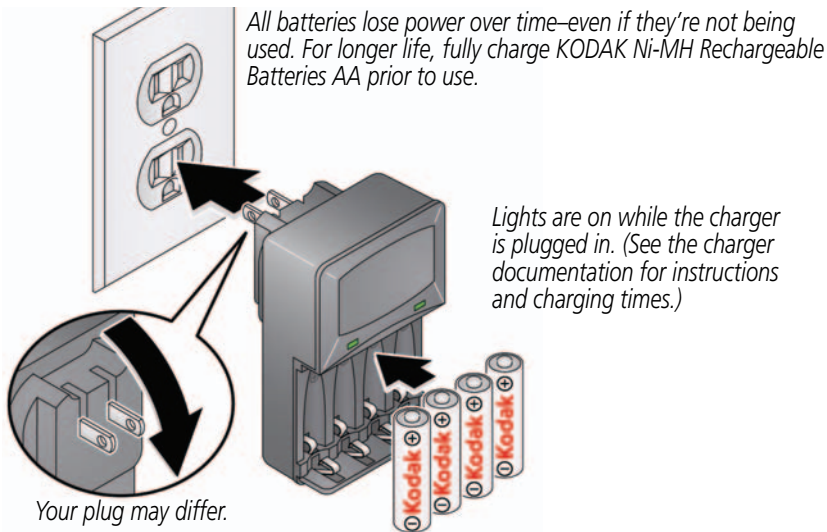

Watch the battery level

[See page 8](#)

Purchase extra batteries

www.kodak.com/go/accessories

Loading the batteries

1 Press the door lock while sliding the door open.



2

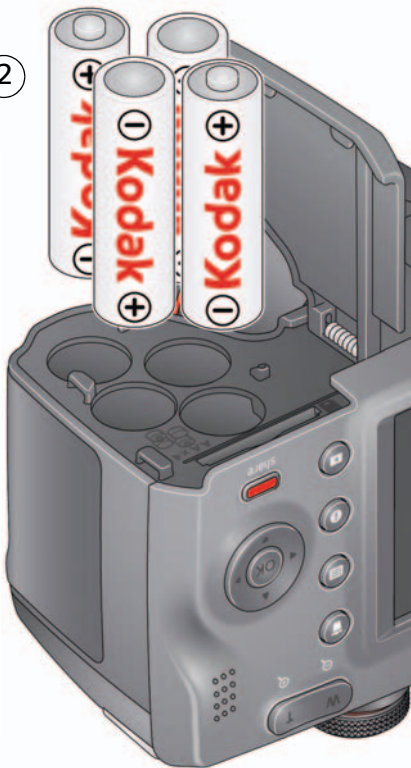

Watch the battery level [See page 8](#)

Extend battery life [See page 52](#)

Purchase extra batteries www.kodak.com/go/accessories

Turning on the camera

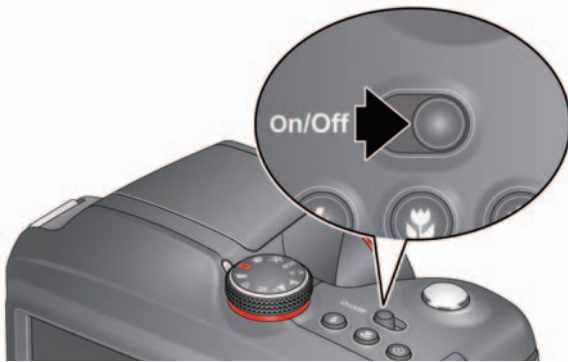

Setting the language and date/time



Language:

▲▼ to change.

OK to accept.

Date/Time:

At the prompt, press OK.

◀▶ to change current field.

▲▼ for previous/next field.

OK to accept.

Sharing Destinations:

You can tell the camera which sharing sites to offer when it's time to share pictures/videos.

▲▼ to highlight a site.

OK to check/uncheck the site.

NOTE: To change language in the future, use the Setup menu (see page 37).

Storing pictures on an accessory SD/SDHC Card

Your camera has internal memory. We recommend purchasing an SD or SDHC Card (Class 4 or higher) to store more pictures/videos. **You must use a Class 4 or higher card to record HD video.**



CAUTION:

A card can only be inserted one way; forcing it may cause damage. Inserting or removing a card while the camera is on may damage the pictures, the card, or the camera.

- 1 Press the door lock while sliding the door open.
- 2 Insert a card until it clicks. To remove a card, press and release it.

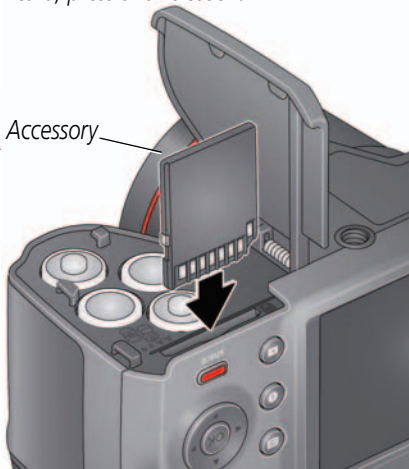

IMPORTANT: When you turn on the camera, it checks to see if a card is inserted. If so, new pictures/videos are stored on the card. If no card is inserted, new pictures/videos are stored in the camera's internal memory.

Purchase cards www.kodak.com/go/accessories

2

Taking pictures/videos

Taking pictures in Smart Capture mode

- 1 Turn the Mode dial to Smart Capture .
- 2 Use the LCD to compose the picture.



- 3 Press the Shutter button **halfway** to focus and set exposure. Green framing marks indicate successful focus. If the camera is not focusing on the desired subject, or if red brackets or "AF" appear, release the Shutter button and recompose the scene.
- 4 Press the Shutter button **completely down**. The new picture is briefly displayed. If you don't like it, press the Delete button, then follow the prompts. (To delete a picture later, [see page 23.](#))

Other picture-taking features

- To view available tools, press the Info button **i**. Press **◀▶** to choose a tool, then press OK.
- To review, tag, and edit pictures and videos, press the Review button **▶** (see page 22).
- To change camera settings, see page 35.
- If it's hard to see the LCD, you can adjust the brightness (see page 37).



Understanding the picture-taking icons

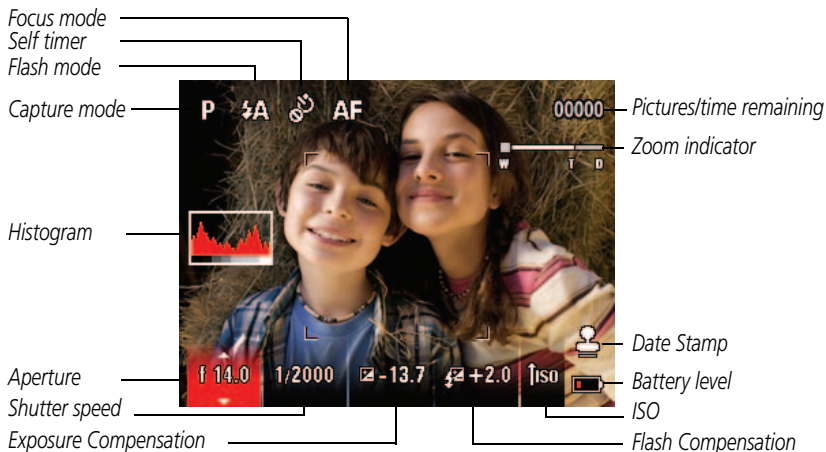

Watch the battery level

Don't miss out on great pictures and videos—keep your batteries fully charged.

Full	
Three quarters	
Half	
Critical	
AC Power	

Charge the batteries [See page 1](#)

Purchase extra batteries www.kodak.com/go/accessories

Taking videos

IMPORTANT: You must use a Class 4 or higher card to record HD video.



- 1 Turn the Mode dial to Video .
- 2 To start recording, press and release the Shutter button. To stop recording, press and release the button again.

The first frame of the new video and the play button are displayed for a few seconds.

- To play/pause the video, press the OK button.
- If you don't like the video, press the Delete button, then follow the prompts. (To delete a video later, see page 23.)

How long can I record video?

Video Size setting	Approximate file size/video length (depending on scene content)
HD720p	< 2 GB or approximately 10 minutes
VGA	< 2 GB or approximately 25 minutes

To switch from HD720p (higher quality, larger file size) to VGA, press the Menu button, highlight Video Size, and press OK.

Using the zoom

Use optical zoom to get up to 21X closer to your subject.



- 1 Use the LCD to frame your subject. (For focus distances, see [Specifications, page 48.](#))
- 2 Press Telephoto (T) to zoom in. Press Wide Angle (W) to zoom out.
- 3 Take the picture or video.

NOTE: To get a focused picture every time, see [page 6.](#)

Using digital zoom

Digital zoom is not available in Smart Capture mode.

NOTE: You may notice decreased image quality when using digital zoom.





Using the flash

Use the flash when you take pictures at night, indoors, or outdoors in heavy shadows. Flash settings are limited in some capture modes.



Press the Flash button repeatedly to scroll through flash modes.

The current flash mode appears on the LCD.

Flash modes		The flash fires
Auto		When the lighting conditions require it.
Fill		Every time you take a picture, regardless of the lighting conditions. Use when the subject is in shadow or is "backlit" (when the light is behind the subject). In low light, hold the camera steady or use a tripod. NOTE: Not available in Smart Capture mode.
Red-eye Reduction		A preflash fires, shrinking the eye pupil, before the picture is taken.
Off		Never.

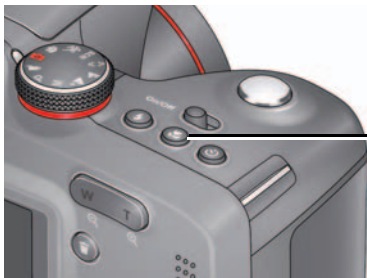

Using the Focus feature



Press the Focus button  repeatedly to scroll through focus modes. The current focus mode appears on the LCD.

IMPORTANT: Focus mode availability varies by picture-taking mode.

1 Press the Focus button until the desired focus icon is displayed on the LCD.

Mode	Icon	For
Normal AF	No icon	Normal picture taking.
Infinity AF		Distant scenery or for taking pictures through a window. (Turn off the flash when taking pictures through glass. See page 11.)
Macro AF		Subjects that are 0.1–1 m (0.3–3.3 ft) from the lens.

2 Press the Shutter button **halfway** to focus and set exposure, then **completely down** to take the picture.

IMPORTANT: If red focus brackets or "AF" appear, adjust the distance to your subject or the amount of zoom.

Using the Self-timer feature



Press the Self-timer button  repeatedly to scroll through Self-timer/Burst modes.

The current self-timer mode appears on the LCD.

Use the self-timer when you want to be included in a picture, or to ensure a steady Shutter button press. Place the camera on a tripod or flat surface.

1 Press the Self-timer button until the desired self-timer icon is displayed on the LCD.

10 seconds— A picture is taken after a 10-second delay (so you have time to get into the scene).

2 seconds— A picture is taken after a 2-second delay (for a steady, shutter release on a tripod).

2 shot— The first picture is taken after a 10-second delay. A second picture is taken 8 seconds later.

2 Press the Shutter button **halfway** to focus and set exposure, then **completely down** to take the pictures.

The camera takes the picture(s) after the delay.

Use the same procedure to take a 2- or 10-second self-timer video, but press the Shutter button **completely down**.

Using the Burst feature



Press the Self-timer/Burst button  repeatedly to scroll through Self-timer/Burst modes.

The burst mode appears on the LCD.

- 1 Press the Self-timer/Burst button until the burst icon  is displayed on the LCD.
- 2 Press the Shutter button **halfway** to focus and set exposure, then **press and hold it completely down** to take the pictures.

The camera stops taking pictures when you release the Shutter button, when the pictures are taken, or when there is no more storage space. The flash is disabled in Burst mode. During quickview, you can delete all pictures in the burst series.







Capture mode	Picture Size (MP)	Burst rate (fps)	Burst depth (pictures)
Smart Capture	14	0.8	8
	12	0.8	9
	10	0.9	10
	6	0.9	17
	3	1.0	31
P or M	14	0.9	8
	12	1.0	9
	10	1.0	10
	6	1.0	17
	3	1.0	31

Example: When the camera is in Smart Capture mode and the Picture Size is set to 10 MP, you can take approximately 10 pictures at 0.9 fps (frames per second).

Using different modes



Choose the mode that best suits your subjects and surroundings.

Capture mode	For
 Smart Capture	Excellent image quality and ease of use. <ul style="list-style-type: none"> ■ The scene is analyzed for other content and for lighting. ■ KODAK PERFECT TOUCH Technology is applied, for better pictures.
 Video	Videos with sound.
P Program M Manual	More control over your camera and pictures. (See page 17.)
 Night Landscape	Distant scenery at night. Flash does not fire.
 Landscape	Distant scenes.
 Panorama R-L, L-R	“Stitching” 2 or 3 pictures into 1 panoramic scene. (See page 20.)
SCN Scene	A suite of features that let you take pictures in unique environments, but with point-and-shoot simplicity. (See page 16.)
 Sport	Subjects that are in motion. Shutter speed is fast.
 Portrait	Full-frame portraits of people.





Using SCN (Scene) modes

- 1 Turn the Mode dial to SCN (Scene).
- 2 Press ◀▶ and ▲▼ to read Scene mode descriptions.
- 3 Press OK to choose the Scene mode that you've highlighted.

SCN mode	For
Flower	Close range. Use available light instead of flash, if possible.
Sunset	Subjects at dusk.
Backlight	Subjects that are in shadow or "backlit."
Candle Light	Subjects illuminated by candle light.
Children	Action pictures of children in bright light.
Bright	Bright beach or snow scenes.
Fireworks	Fireworks. For best results, place the camera on a steady surface or tripod.
Self-Portrait	Close-ups of yourself. Assures proper focus and minimizes red eye.
Night Portrait	Reduces red eye of people in night scenes or low-light conditions.
Stage	People on a lit stage. Fast shutter speed, high ISO. Flash and sounds are off. (Flash setting can be changed.)
High ISO	People indoors, in low-light scenes.

Program and Manual modes

Use these modes when you want more control over your camera and pictures.

Mode	When to use	Press     to control
P	Program mode offers the ease of auto shooting with full access to all menu options. The camera automatically sets the shutter speed and aperture (f-stop) based on the scene lighting.	Exposure compensation (how much light enters the camera), flash compensation, and ISO speed
M	Manual mode offers a high level of control. (To prevent blur, use a tripod for slow shutter speeds.)	Aperture, shutter speed, flash compensation, and ISO speed speeds.)

NOTE: Settings you change in P or M modes apply only to pictures taken in those modes. The settings, including Flash, are maintained for P and M modes—even when you change modes or turn off the camera. Use Reset Camera ([see page 38](#)) to reset P or M modes to their default settings.

Changing P or M mode settings

1 Turn the Mode dial to P or M.

NOTE: P and M give access to different settings. (See [page 17](#).)

2 Press the Info button **i**.

3 Press **◀▶** to choose a setting, then press OK to edit the setting.

Press **◀▶** to change a setting, then press OK to save it.

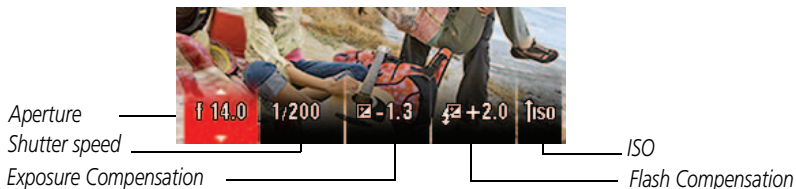

ISO—adjust the camera’s sensitivity to light. Higher ISO indicates greater sensitivity.

NOTE: A higher ISO may produce unwanted “noise” in a picture.

Flash Compensation—adjust flash brightness.

Exposure Compensation—adjust the exposure. If the scene is too light, decrease the setting; if it’s too dark, increase the setting.

Shutter speed—control how long the shutter stays open. (Use a tripod for slow shutter speeds.)

Aperture—(also known as f-stop) control the size of the lens opening, which determines the depth of field.

- Smaller aperture numbers indicate a larger lens opening; good for low-light.
- Larger aperture numbers indicate a smaller lens opening; keeps the main subject sharp; good for landscapes and well-lit conditions.

Using the histogram to view picture brightness

Use the histogram to evaluate the distribution of light before you take a picture. Optimal exposure is achieved when the peak is in the middle of the histogram. The flash may affect a picture's light and shadow (see page 37).

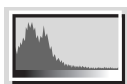

Dark picture

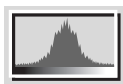

Balanced picture

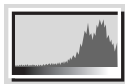

Bright picture

Using exposure compensation to adjust brightness

In P and Panorama modes, you can adjust exposure compensation before you take a picture to make your pictures darker or lighter. Only the first picture in Panorama mode can be adjusted—that adjustment is applied to the remaining pictures.

- 1 Press **◀▶** to choose Exposure Compensation, then press OK to edit the setting. Press **◀▶** to change the setting, then press OK to save it.

An exposure compensation level is shown on the LCD and the image gets darker or lighter.

- 2 Take the picture when you are satisfied with the exposure compensation level.

Using exposure compensation with exposure bracketing

You can use exposure compensation in conjunction with exposure bracketing to get the best exposure.

If the exposure compensation is set to:	And if the exposure bracketing interval is set to:	Then the exposures taken are:
0.0	0.3 steps	-0.3, 0.0, +0.3
+1.0		+0.7, +1.0, +1.3
-1.0		-1.3, -1.0, -0.7

Taking panoramic pictures

Use panorama to “stitch” up to 3 pictures into a panoramic scene.

NOTE: For best results, use a tripod. Only the panoramic picture is saved; individual pictures are not. (Exposure and white balance are set with the first picture. The flash is set to Off.)

- 1 Turn the Mode dial to SCN.
- 2 Press ◀▶▶▼ to choose Panorama Left-Right or Panorama Right-Left (depending on the direction you want to pan), then press OK.
- 3 Take the first picture.
After a quickview, the LCD displays the liveview and an “overlay” from the first picture.
- 4 Compose the second picture. Make the overlay from the first picture cover the same portion in the new picture.
- 5 If you are taking/stitching only 2 pictures, press OK to stitch them together.

After you take 3 pictures, the pictures are automatically stitched together.

Take
2 or 3
pictures.



Get 1
panoramic
picture.



NOTE: To use the self-timer 10-second or 2-second setting, see [page 13](#).

Turning on the Date Stamp feature

You can add a stamp—showing the date taken—to **pictures you take next**.

IMPORTANT: *You cannot add a date stamp to pictures already taken. Once a date stamp is applied, it cannot be removed on the camera.*

- 1 Press the Menu button.
- 2 Press ▲▼ to choose the Date Stamp, then press OK.
- 3 Follow the prompts to turn on the Date Stamp feature.

The date is added to pictures you take next. The feature stays on until you turn it off.

To return to picture-taking mode, press the Shutter button halfway down.

3

Reviewing and editing

Reviewing pictures/videos





Review

- 1 Press the Review  button.
- 2 Press  for previous/next picture/video.
 - To exit, press the Review button or press the Shutter button halfway down.
 - To view pictures/videos as thumbnails, press the Wide Angle (W) button. (For more information, see [page 24](#).)
 - For tips on finding your pictures/videos, see [page 25](#).

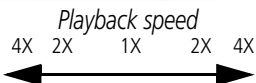

Playing a video



Press OK to play a video. Press OK to pause/resume. During playback:

- Press  to adjust the volume.
- Press  to play at 2X speed; press again for 4X.
- Press  to reverse at 2X speed; press again for 4X.

Deleting pictures/videos

- 1 Press the Review  button.
- 2 Press  for previous/next picture/video.
- 3 Press the Delete button.
- 4 Follow the screen prompts.

Using the undo delete picture feature

If you accidentally delete a picture, you may be able to use Undo Delete to retrieve it. This feature is only available immediately after you delete a picture.

Viewing pictures/videos in different ways

Magnifying a picture



- 1 Press Telephoto (T) to magnify 2X–8X.
- 2 Press ◀▶ ▲▼ to view other parts of a picture.
 - Press OK to return to 1X.

Viewing pictures/videos as thumbnails (multi-up)

- 1 Press the Review  button.

The camera shows the last picture/video that was taken.

- 2 Press the Wide Angle (W) button to view pictures/videos as thumbnails. (Press it again to see more, smaller thumbnails.)

To view all pictures/videos, choose the All tab.









To sort pictures/videos by date, people, favorites, or keywords, press ◀▶ ▲▼ and choose the appropriate tab.

- 3 To see a single picture/video, press ◀▶ ▲▼ to choose it. Then press the Telephoto (T) button.
 - To select multiple pictures/videos, see [page 28](#).
 - Press the Review button to exit Review.

A smarter way to find and enjoy your pictures

Tag pictures—by people or keywords—to make them easy to find, later. For example, the camera can find all pictures that contain “Mary” or “Dad’s 60th Birthday.” (See [Tagging people, page 32](#) or [Tagging with keywords, page 34](#).)

You can also find pictures by date taken or if it’s marked as a favorite.

- 1 Press the Review  button.
- 2 Press the Wide Angle (W) button to view pictures by thumbnail (or choose View Thumbnails shortcut).
- 3 Press     to choose a tab and sort pictures/videos by All, Date, People, Favorite, or Keyword.
- 4 Press     to choose a picture or picture stack.

Press Telephoto (T) see pictures in a stack or to see an individual picture. Press Wide Angle (W) to see thumbnails or picture stacks.

To return to picture-taking mode, press the Shutter button halfway down.



Tip: For best results, make sure the camera’s date/time is current (see [page 37](#)).

Understanding the review icons









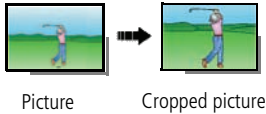



Watch the battery level [See page 8](#)

Cropping pictures







You can crop a picture so that only the desired portion of the picture remains.



- 1 Press the Review  button, then   to find a picture to crop.
 - 2 Press the Menu  button, then   to choose the Edit tab. Choose Crop, then press OK.
 - 3 Press Telephoto (T) to shrink the crop area or Wide (W) to stretch it. Press     to move the crop box. When satisfied with the crop box, press OK.
 - 4 Follow the screen prompts.
The picture is cropped. (The original is saved.) Cropped pictures cannot be cropped again on the camera.
- To return to picture-taking mode, press the Shutter button halfway down.







Trimming a video

You can remove the start or end from a video, saving only the desired portion.

- 1 Press the Review  button, then   to find a video.
 - 2 Press the Menu  button, then   to choose the Edit tab. Choose Trim, then press OK.
 - 3 Follow the screen prompts.
The video is trimmed. (You can save it as a new video or replace the original.)
- To return to picture-taking mode, press the Shutter button halfway down.

Making a picture from a video









You can choose a single frame from a video, then make a picture suitable for a 4 x 6-inch (10 x 15 cm) print.

- 1 Press the Review  button, then   to find a video.
- 2 Press the Menu  button, then   to choose the Edit tab. Choose Make Picture, then press OK.
- 3 Follow the screen prompts.

A picture is created. (The original video is saved.)

Making an action print from a video

From a video, you can make a 9-up picture, suitable for a 4 x 6-inch (10 x 15 cm) print.

- 1 Press the Review  button, then   to find a video.
- 2 Press the Menu  button, then   to highlight the Edit tab.
- 3 Press   to highlight Action Print, then press OK.

A 9-up image is created.

Selecting multiple pictures/videos

Use the multi-select feature when you have two or more pictures to print, share, delete, tag with keyword, etc. Multi-select is used most effectively in Multi-Up mode (see page 24).

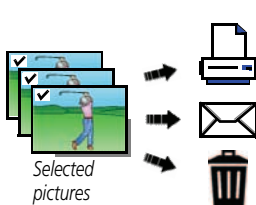

- 1 Press the Review  button, then   (and   if you're in multi-up mode) to find a picture/video.
- 2 Press OK to select pictures/videos.

A check mark appears on the picture. (Press OK again to remove a check mark.) You can now print, transfer, delete, etc. the selected pictures.

Displaying pictures/videos on a television

You can display pictures/videos on a television, computer monitor, or any device equipped with a composite video input. To connect the camera directly to a television, use a composite cable (may be sold separately). Use the camera controls to navigate through pictures/videos on the television.

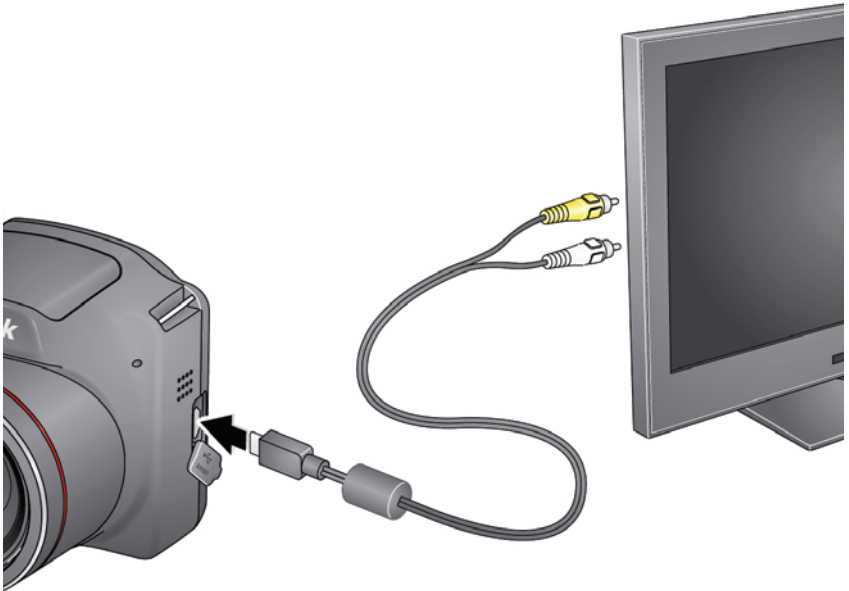

Purchase cables www.kodak.com/go/accessories

4

Sharing pictures/videos

Sharing pictures/videos through social networks

It's never been easier to share pictures on your favorite social networking sites.

IMPORTANT: *To use the sharing and social networking features, you must install KODAK Software. (See page 40.)*

- 1 Press the Share button, then ◀▶ to find a picture.

If it's your first time, a Help screen appears.

- 2 Press ▲▼ to choose a social networking site, then press OK.

A check mark appears. Repeat this step to choose more sites. (You can press OK again to remove a check mark.)

- 3 Press ▲▼ to choose Done, then press OK.

The picture is displayed with the Share icon. When you transfer the picture to your computer, it is uploaded to the networking site(s) that you chose.











Tip: Do you send pictures to the same sites each time?

Find a picture, then press and hold the Share button for about 1 second.

The camera applies the settings that you used previously and adds the Share icon to the picture.

Choose which social networking sites to display on your camera





You can show/hide social networking sites on your camera so that only your favorite sites appear.



- 1 Press the Menu  button.
- 2 Press   to choose the Setup tab, then   to choose Share Button Settings, then press OK.
- 3 Press   to choose a social networking site, then press   to choose Show or Hide. Repeat this step until you have chosen Show/Hide for each social network.
- 4 When finished, press   to choose Done, then press OK.





To return to picture-taking mode, press the Shutter button halfway down. When you are in Review and press the Share button, only chosen sites are shown.

Manage email addresses and KODAK PULSE Digital Frames

You can add, edit, or delete email addresses and KODAK PULSE Digital Frames on your camera.

- 1 Press the Share button. Press   to choose Manage Email Addresses (or Manage Frames), then press OK.
- 2 To add an email address or frame, press   to choose Add Email or Add Frame, then press OK. Use the on-screen keyboard to make the addition. (Example: JohnDoe@domain.com) Add a familiar, unique nickname.

To edit an email address or a KODAK PULSE Digital Frame, press   to choose the address's nickname or the frame, then press OK. Use the on-screen keyboard to make edits.

To delete an email address or frame, choose Delete Email or Delete Frame, then press OK. Press   to choose the address or frames, then press OK so that a check mark appears. Press   to choose Delete, then press OK.

- 3 When finished, press   to choose Done, then press OK.

To return to picture-taking mode, press the Shutter button halfway down.











Tagging pictures



Tag pictures to make them easy to find, later. You can tag pictures in 2 ways:

- **People**, and then find all pictures of “Mary.”
- **Keywords**, and then find all pictures from “Dad’s 60th Birthday.”

Tagging people

When you tag faces, your camera “learns” to recognize people by name. Then it matches names and faces in pictures you’ve taken *and* those you take in the future.



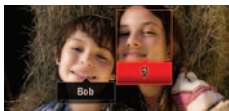

- 1 Press the Review  button, then   to find a picture that contains faces.
- 2 Press the Menu  button. Press   to choose Tag People, then press OK.
- 3 Press   to choose Apply Tags, then press OK.
- 4 Press   to choose an existing name, or New Name to add a new one (see [Using the keyboard, page 33](#)), then press OK.

If more than one face is detected, a name or question mark is assigned to each detected face. To resolve an incorrect name or a question mark, press   to select a face, then press OK.



- 5 If prompted to Update People Tags, press   to choose Yes, then press OK.

Other pictures are scanned and updated with the name(s) you applied here.

Press   to add names to other pictures. When finished, press   to choose Done, then press OK. To return to picture-taking mode, press the Shutter button halfway down.

Tip: Are faces not always detected?







If a face is turned sideways, is too distant, or if the contrast between face and background is insufficient, then the camera might not detect the face.

Need to update a name?

If you meet a new friend—James—but you already have pictures tagged with your old friend, James, you can:

- Tag the new James with “James Smith” and/or
- Update the old James to “James Monroe”

Here’s how:



- 1 Press the Review  button.
- 2 Press the Menu  button. Press  to choose Tag People, then press OK.
- 3 Press  to choose Modify Names List, then press OK.
- 4 Press  to choose the name you want to modify, then press OK.
- 5 Edit the name, press  to choose OK, then press OK.

To return to picture-taking mode, press the Shutter button halfway down.







Tip: You can have up to 20 active names.

Using the keyboard

The keyboard appears when you need to enter text.

- 1 Press   to choose a letter, then press OK.
- 2 When finished, press  to choose OK, then press OK.



Tagging with keywords

- 1 Press the Review  button, then  to find a picture to tag.
- 2 Press the Menu  button. Press  to choose Keyword Tag, then press OK.
- 3 Press  to choose an existing keyword, or New Keyword (see [Using the keyboard, page 33](#)) to add a new one, then press OK.
- 4 Press  to add keywords to other pictures. When finished, press  to choose Done, then press OK.

To return to picture-taking mode, press the Shutter button halfway down.

Marking pictures/videos for emailing

It's simple to mark pictures so that they're ready to email when you transfer them to your computer and use the KODAK Share Button App. First, create a new email address. (See [Using the keyboard.](#))

- 1 Press the Share button. Press  to find a picture.
- 2 Press  to find an email address, then press OK.

To mark other pictures/videos with the same address, press , then press OK.

To return to picture-taking mode, press the Shutter button halfway down.





When you transfer the marked pictures/videos to your computer, the software prompts you to send the pictures/videos.

5

Doing more with your camera

You can change settings to get the best results from your camera.

NOTE: Some modes offer limited settings. Some settings remain until you change them; others, until you change modes or turn off the camera.

- 1 Press the Menu  button.
- 2 Press   to choose a tab:
 - **Capture/Video** for the most common picture- and video-taking settings
 - **Setup** for other camera settings ([page 37](#))
- 3 Press   to choose a setting, then press OK.
- 4 Choose an option, then press OK.

Using the Capture menu

Setting	More information
Picture or Video Size Choose a picture or video resolution.	See Specifications, starting on page 48 .
White Balance Choose your lighting condition. (Available only in Program and Panorama modes.)	Auto —Automatically corrects white balance. Ideal for general picture taking. Daylight —For pictures in natural lighting. Tungsten —Corrects the orange cast of incandescent light bulbs. Ideal for indoor pictures under tungsten or halogen lighting without flash. Fluorescent —Corrects the green cast of fluorescent lighting. Ideal for indoor pictures under fluorescent lighting without flash. Open Shade —For pictures in shade in natural lighting.

Setting	More information
Color Mode Choose color tones. Unavailable in Video mode.	High Color Natural Color Low Color Black & White Sepia —For a reddish-brown, antique look.
Face Detect Capture Choose if faces get focus priority.	On —In P mode (and in SCN modes designed for pictures of people), the camera attempts to focus on faces. Off
Exposure Metering Evaluate light levels at specific areas of a scene.	Multi-Pattern —Evaluates 5 zones to give an even picture focus. Ideal for general picture taking. Center-Weighted —Evaluates the small area centered in the lens. Ideal for focusing on a precise area.
AF Zone Select a large or concentrated area of focus.	Multi-zone —Evaluates 5 zones to give an even picture focus. Ideal for general picture taking. Center-zone —Evaluates the small area centered in the LCD. Ideal when precise focus of a specific area in the picture is needed.
AF Control (Still) Choose an auto-focus setting.	Continuous AF —Because the camera is always focusing, there is no need to press the Shutter button halfway down to focus. Single AF —Focuses when the Shutter button is pressed halfway down. (This setting uses less battery power.)
Sharpness Control picture sharpness or softness.	High Normal Low
Contrast Control picture contrast.	High Normal Low

Setting	More information
Liveview Histogram Turn on to evaluate the distribution of light before you take a picture. Optimal exposure is achieved when the peak is in the middle of the histogram. (See page 19 .)	On Off

Using the Setup menu

Setting	More information
Date & Time	Set date and time.
LCD Brightness Choose LCD brightness during picture/video capture. (During Review, the LCD is set to High Power.)	High Power —Brighter LCD; uses more battery power. Power Save —Dimmer LCD; uses less power. Auto —LCD brightness is automatically adjusted according to environment.
Date Stamp Add the date to pictures you take next.	See page 21 .
Share Button Settings Choose what is displayed when the Share button is pressed.	Show or hide: <ul style="list-style-type: none"> ■ Individual social networking sites ■ E-mail addresses (all or none) ■ KODAK PULSE Digital Frames (all or none)
Capture Frame Grid In a P and M modes, show a framing grid.	On Off

Setting	More information
Orientation Sensor Orient pictures so that they are displayed with the correct side up.	On —The camera rotates pictures so that all appear in the same orientation on the camera. On Transfer —The camera rotates pictures when they are transferred to your computer. Off —Pictures are not rotated.
Camera Sounds Choose volume, and choose sound effects for each function.	Exit On Volume Power On Focus Lock Shutter Error Self-timer
Video Out Choose the regional setting that lets you connect the camera to a television or other external device.	NTSC —Used in North America and Japan; most common format. PAL —Used in Europe and China.
Image Storage Choose a storage location for pictures/videos.	Auto —The camera uses the card if one is in the camera. If not, the camera uses internal memory. Internal Memory —The camera always uses internal memory, even if a card is installed.
Language	Choose your language.
Reset Camera	Reset settings to their default.
Computer Connection Choose which application is downloaded or launched when you connect the camera to the computer.	KODAK Software Other Application (APPLE iPHOTO, etc.) IMPORTANT: <i>To use the social networking features, you must install the KODAK Share Button App (see page 40).</i>

Setting	More information
Format  CAUTION: Formatting deletes all pictures/videos. Removing a card during formatting may damage the card.	Memory Card —Deletes everything on the card; formats the card. Cancel —Exits without making a change. Internal Memory —Deletes everything in internal memory including email addresses; formats the internal memory.
About	View camera information.

6

Install software

Install software, transfer pictures, and share

IMPORTANT: To use the sharing and social networking features, you must install the KODAK Share Button App.

1 Make sure the computer is connected to the Internet.



2 Turn **off** the camera.

3 Using the KODAK Camera USB Cable, Micro B / 5-Pin, connect the camera to the computer. (Use only the cable included with this camera.)

4 Turn **on** the camera.

The camera works with your computer to download and install the Share Button App on your computer.

IMPORTANT: If the installer does not run, choose and install the right version for your computer:
www.kodak.com/go/camerasw.

5 After the software is installed, follow the prompts to transfer pictures and videos to your computer.

Pictures/videos that you tagged for sharing are emailed or uploaded to the desired social networking sites.

NOTE: You can also use a card reader to transfer pictures/videos to your computer.

Download KODAK Software later www.kodak.com/go/camerasw

Get Software help www.kodak.com/go/support

See How-To videos www.kodak.com/go/Z5010demos

Printing pictures

Direct printing with a KODAK All-in-One Printer

IMPORTANT: To print using PICTBRIDGE Technology, you must change the Computer Connection setting (in the Setup menu) to Other Application (see page 38).

You need a camera, a PICTBRIDGE enabled Printer, and a USB cable.

Connecting the camera to a KODAK All-in-One Printer

- 1 Turn off the camera and printer.
- 2 Use the KODAK Camera USB Cable, Micro B / 5-Pin (included with the camera) to connect the camera to the printer.

Printing from a KODAK All-in-One Printer

- 1 Turn on the printer. Turn on the camera.

The PictBridge logo is displayed, followed by the current picture and menu. (If no pictures are found, a message is displayed.) If the menu turns off, press any button to redisplay it.

- 2 Choose a printing option, then press OK.

Current Picture—Press ◀▶ to choose a picture.

Tagged Pictures—If your printer is capable, print pictures that you marked for printing.

Index Print—Print thumbnails of all pictures. (This option requires one or more sheets of paper.)

All Pictures—Print all pictures in internal memory or on a card.

NOTE: During direct printing, pictures are not permanently transferred or saved to the printer. To transfer pictures to your computer, see page 40.

Purchase cables, accessories www.kodak.com/go/accessories

Ordering prints online

KODAK Gallery (www.kodakgallery.com) makes it easy to:









- Upload your pictures.
- Edit, enhance, and add borders to your pictures.
- Store pictures, and share them with family and friends.
- Have prints, photo greeting cards, frames, and albums delivered to your door.

Printing from an optional SD or SDHC Card

- Automatically print tagged pictures when you insert your card into a printer. See your printer user's guide for details.
- Make prints at a KODAK Picture Kiosk. Go to www.kodak.com/go/picturemaker.
- Take the card to your local photo retailer for professional printing.

Marking your pictures for print

You can mark your pictures so they are easy to print:

- 1 Press the Review  button. Press   to find a picture.
- 2 Press the Menu  button.
- 3 Press   to choose Print, then press OK.
- 4 Press   to choose the number of copies.
- 5 Press OK.
 - To return to picture-taking mode, press the Shutter button halfway down.

7

Troubleshooting

Camera problems

Status	Solution
Camera does not turn on, off; buttons do not function	<ul style="list-style-type: none">■ Remove then reinsert batteries.■ Replace non-rechargeable alkaline batteries. Charge rechargeable batteries (see page 1).
Camera freezes up when a card is inserted or removed.	<ul style="list-style-type: none">■ Turn the camera off, then back on. Make sure the camera is turned off before inserting or removing a card. For compatible card types, see page 4.
LCD is too dark.	<ul style="list-style-type: none">■ Adjust the LCD Brightness setting (see page 37).
In Review, a blue or black screen is displayed instead of a picture	<ul style="list-style-type: none">■ Transfer the picture to the computer (see page 40), then format the card or internal memory. Caution: Formatting a card deletes all pictures and videos.■ Take another picture.
In Review, you do not see a picture (or the expected picture) on the LCD	<ul style="list-style-type: none">■ Format the card in the camera (see page 39) Caution: Formatting a card deletes all pictures and videos.
Pictures remaining number does not decrease after taking a picture	<ul style="list-style-type: none">■ Continue taking pictures. The camera is operating normally. (The camera estimates the number of pictures remaining after each picture is taken, based on picture size and content.)
Camera displays a High Temperature error	<ul style="list-style-type: none">■ If camera temperature rises to a certain level, a high temperature error (Video recording will stop in 5 seconds) appears. Turn the camera off as soon as possible and let it cool down. The camera cannot capture more videos until it has cooled down. (Captured videos are not lost.)

Status	Solution
Flash does not fire	<ul style="list-style-type: none">■ Check the flash setting, and change as needed (see page 11). NOTE: The flash does not fire in all modes.
Memory card is almost or entirely full	<ul style="list-style-type: none">■ Transfer the pictures to the computer (see page 40).■ Delete pictures from the card (see page 23) or insert a new card.
The Reset Camera feature did not take effect.	<ul style="list-style-type: none">■ After using the Reset Camera feature (see page 38), turn the camera off and then on again.
Battery life is short	<ul style="list-style-type: none">■ Make sure the correct battery type is installed (see page 52).■ Charge the batteries (see page 1). Watch the battery level (see page 8).■ Use a power-saving LCD Brightness setting (see page 37).■ Limit on-camera reviewing, which consumes power.
Shutter button does not work.	<ul style="list-style-type: none">■ Turn on the camera (see page 3).■ Transfer pictures to the computer (see page 40), delete pictures from the camera (see page 23), or insert a card with available memory (see page 4).
Memory card not recognized or camera freezes with card	<ul style="list-style-type: none">■ Card may be corrupted. Format the card in the camera (see page 39). Caution: Formatting a card deletes all pictures and videos.■ Use another memory card. Only SD or SDHC Cards are supported.
Pictures on card (or in internal memory) are corrupted	<ul style="list-style-type: none">■ Retake pictures.■ Do not remove card while the camera is on.■ Keep rechargeable batteries charged.■ Transfer pictures to the computer (see page 40), then format the card or internal memory (see page 39). Caution: Formatting a card deletes all pictures and videos.

Computer/connectivity problems

Status	Solution
Slide Show does not run on an external video device	<ul style="list-style-type: none"> ■ Adjust the camera Video Out setting to NTSC or PAL (see page 38). ■ Make sure the external device settings are correct. (See the device's user guide.)
Computer does not communicate with the camera	<ul style="list-style-type: none"> ■ Turn off the camera, then turn it back on. ■ Make sure the batteries are charged and installed correctly (see page 1). ■ Make sure the KODAK Camera USB Cable, U-8 is connected to the camera and the computer (see page 40). Then turn on the camera. ■ See KODAK Software Help at www.kodak.com/go/camerasw.

Picture quality problems

Status	Solution
Picture is not clear	<ul style="list-style-type: none"> ■ To automatically set exposure and focus, press the Shutter button halfway. When the framing marks turn green, press the Shutter button completely down to take the picture. ■ Clean the lens (see page 50). ■ Make sure the camera is not in Macro mode (see page 12). ■ Place the camera on a flat, steady surface or use a tripod (especially in high-zoom settings or in low light). ■ Use a larger picture size (see page 35). ■ If you're manually adjusting the ISO speed, realize that high ISO setting may cause grainy pictures.

Status	Solution
Picture is too dark	<ul style="list-style-type: none">■ Reposition the camera for more available light.■ Use Fill flash (see page 11) or change your position so light is not behind the subject.■ Move so that the distance between you and the subject is within the effective flash range. (See Camera Specifications, starting on page 48.)■ To automatically set exposure and focus, press the Shutter button halfway. When the framing marks turn green, press the Shutter button completely down to take the picture.■ In Program mode, adjust the Exposure Compensation (see page 17).
Picture is too light	<ul style="list-style-type: none">■ Reposition the camera to reduce the amount of available light.■ Turn the flash off (see page 11).■ Move so that the distance between you and the subject is within the effective flash range. (See Camera Specifications, starting on page 48.)■ To automatically set exposure and focus, press the Shutter button halfway. When the framing marks turn green, press the Shutter button completely down to take the picture.■ In Program mode, adjust the Exposure Compensation (see page 17).
Pictures that have KODAK PERFECT TOUCH Technology applied (twice) are of lower image quality.	<ul style="list-style-type: none">■ If PERFECT TOUCH Technology has been applied to a picture on the camera, do not apply it again when the picture is on the computer (or on a KODAK Picture Kiosk). NOTE: PERFECT TOUCH Technology is automatically applied to pictures taken in Smart Capture mode.

Direct printing (PICTBRIDGE enabled printer) problems

Status	Solution
The Direct printing menu interface turns off	<ul style="list-style-type: none"> ■ Press any camera button to redisplay the menu.
Cannot print pictures	<ul style="list-style-type: none"> ■ Make sure there is a connection between the camera and the printer (see page 41). ■ Make sure the printer and the camera have power.
Camera or printer displays an error message	<ul style="list-style-type: none"> ■ Follow the prompts to resolve the issue.

Getting help on the Web

Get support for your product (FAQs, troubleshooting information, etc.)	www.kodak.com/go/Z5010support
Purchase camera accessories	www.kodak.com/go/accessories
Download the latest camera firmware	www.kodak.com/go/Z5010downloads
Register your camera	www.kodak.com/go/register
Chat, email, write, or phone Kodak (Chat not available in all languages)	www.kodak.com/go/contact

Specifications

CCD—1/2.3-type

Effective pixels—14 MP (4368 x 3256)

LCD—3.0 in. (7.6 cm) LCD; 230K dots; 30 fps; 4:3 aspect ratio

Image storage—Optional SD/SDHC Card  (The SD logo is a trademark of the SD Card Association.) Maximum supported card size: 32 GB

Internal storage capacity—128 MB internal memory (84.8 MB available for image storage. 1 MB equals one million bytes.)

Taking lens—21X optical zoom; f/3.1–f/5.8; 35 mm equivalent: 25–525 mm

Digital zoom—5X continuous

Focus system—TTL-AF (through-the-lens auto focus); Multi-Zone, Center-Zone, Face Priority. Working range:

0.6 m (2.0 ft)—infinity @ wide, normal

2.0 m (6.6 ft)—infinity @ telephoto, normal

0.1–1 m (0.3–3.3 ft) @ wide, Macro mode

1.6–3.0 m (5.2–9.8 ft) @ tele, Macro mode

Image stabilization—Optical (CCD shift)

Auto focus control—Continuous and Single AF

Face detection—Yes

Face recognition—Yes

Shutter speed—1/2–1/1500 seconds

ISO speed—Auto: 64–400; Manual: 64, 100, 200, 400, 800, 1600

Focus/Exposure Zone—TTL-AE; Multi-Zone, Center-Zone

Exposure compensation—+/-2.0 EV with 1/3 EV step

White Balance—Auto, Daylight, Tungsten, Fluorescent, Open Shade

Electronic Flash—Auto flash; Auto, Fill, Red Eye, Off; Guide No. 9.0 (m) @ ISO 400; working range in Smart Capture mode:

0.5–11.6 m (1.6–38.1 ft) @ wide;

1.0–6.2 m (3.3–20.3 ft) @ telephoto

Self-timer mode—2 seconds, 10 seconds, 2 picture timer

Burst mode—See [page 14](#).

Capture modes—See [page 15](#).

Image file format—

Still: EXIF 2.3 (JPEG compression); file organization DCF

Video: AVI, CODEC H.264

Picture size—14 MP (4:3): 4288 x 3216 pixels

12 MP (3:2): 4288 x 2848 pixels

10 MP (16:9): 4288 x 2416 pixels

6 MP (4:3): 2832 x 2128 pixels

3 MP (4:3): 2048 x 1536 pixels

Video size—

HD720p: 1280 x 720 @ 30 fps

VGA (iPad compatible): 640 x 480 @ 30 fps

Recording limit —

HD720p: < 2 GB or approximately 10 minutes

VGA: < 2 GB or approximately 25 minutes

Color modes—Vivid Color, Full Color, Basic Color, Black & White, Sepia

Sharpness modes—Sharp, Normal, Soft

Communication with computer—USB 2.0 high speed (PIMA 15740 protocol); via KODAK Camera USB Cable, Micro B / 5-Pin

Microphone—Mono

www.kodak.com/go/support

Speaker—Mono

PICTBRIDGE support—Yes

Power—(4) AA alkaline or Ni-MH rechargeable batteries; 5V 1.5A DC required if an AC adapter is used

Tripod mount—1/4 inch

Size—117.7 x 80.8 x 78.7 mm (4.6 x 3.2 x 3.1 in.) @ power off

Weight—Camera, alkaline batteries, and SD card: 473g (16.7 oz)

Camera, Ni-MH batteries, and SD card: 493g (17.4 oz)

Operating temperature—0–40° C (32–104° F)

Care and maintenance

- If you suspect water has gotten inside the camera, remove the batteries and card. Allow all components to air-dry for at least 24 hours before using the camera.
- Blow gently on the lens or LCD to remove dust and dirt. Wipe gently with a soft, lint-free cloth or an untreated lens-cleaning tissue. Do not use cleaning solutions unless designed specifically for camera lenses. Do not allow chemicals, such as suntan lotion, to contact painted surfaces.
- Service agreements may be available in your country. Contact a dealer of KODAK Products for more information.
- For digital camera disposal or recycling information, contact your local authorities. In the US, go to the Electronics Industry Alliance site at www.eiae.org or go to www.kodak.com/go/support.

Upgrading your software and firmware

We occasionally update KODAK Software and firmware (the software that runs on the camera). For instructions on installing the latest version, go to www.kodak.com/go/Z5010downloads.

Storage capacities

The LCD displays the approximate number of pictures (or minutes/seconds of video) remaining. Actual storage capacity varies depending on subject composition, card size, and other factors. You may be able to store more or fewer pictures and videos.

Important safety instructions



CAUTION:

Do not disassemble this product; there are no user-serviceable parts inside. Refer servicing to qualified service personnel. KODAK AC Adapters and Battery Chargers are intended for indoor use only. The use of controls, adjustments, or procedures other than those specified herein may result in exposure to shock and/or electrical or mechanical hazards. If the LCD breaks, do not touch the glass or liquid. Contact Kodak customer support.

- The use of an accessory that is not recommended by Kodak may cause fire, electric shock, or injury. For approved accessories, go to www.kodak/go/accessories.
- Use only a USB-certified computer equipped with a current-limiting motherboard. Contact your computer manufacturer if you have questions.
- If using this product in an airplane, observe all instructions of the airline.
- When removing the batteries, allow them to cool; they may be hot.
- Follow all warnings and instructions supplied by the battery manufacturer.
- Use only batteries approved for this product to avoid risk of explosion.
- Keep batteries out of the reach of children.
- Do not allow batteries to touch metal objects, including coins. Otherwise, a battery may short circuit, discharge energy, become hot, or leak.
- Do not disassemble, install backward, or expose batteries to liquid, moisture, fire, or extreme temperature.

- Remove the batteries when the product is stored for an extended period of time. In the unlikely event that battery fluid leaks inside the product, contact Kodak customer support.
- In the unlikely event that battery fluid leaks onto your skin, wash immediately with water and contact your local health provider. For additional health-related information, contact your local Kodak customer support.
- Go to www.kodak.com/go/reach for information about the presence of substances included on the candidate list according to article 59(1) of Regulation (EC) No. 1907/2006 (REACH).
- Dispose of batteries according to local and national regulations. Go to www.kodak.com/go/kes.
- Do not charge non-rechargeable batteries.

Battery replacement, battery life

KODAK Rechargeable Digital Camera AA Batteries: 300 pictures per charge. Battery life per CIPA testing method. (Approximate number of pictures in Smart Capture mode, using an SD Card.) Actual life may vary based on usage.

Extending battery life

- Limit on-camera reviewing, which consumes battery power.
- Use a power-saving LCD Brightness setting (see page 37).
- Dirt on the battery contacts can affect battery life. Wipe the contacts with a pencil eraser before loading batteries in the camera.
- Battery performance is reduced at temperatures below 41° F (5° C). When using your camera in cold weather, carry spare batteries and keep them warm. Do not discard cold batteries that do not work; when they return to room temperature, they may be usable.

Limited warranty

Kodak warrants its digital cameras and accessories (excluding batteries) to be free from malfunctions and defects in both materials and workmanship for the warranty period specified on your KODAK Product packaging. Retain the original dated sales receipt. Proof of purchase date is required with any request for warranty repair.

Limited warranty coverage

Warranty service is only available from within the country where the Products were originally purchased. You may be required to ship Products, at your expense, to the authorized service facility for the country where the Products were purchased. Kodak will repair or replace Products if they fail to function properly during the warranty period, subject to any conditions and/or limitations stated herein. Warranty service will include all labor as well as any necessary adjustments and/or replacement parts. If Kodak is unable to repair or replace a Product, Kodak will, at its option, refund the purchase price paid for the Product provided the Product has been returned to Kodak along with proof of the purchase price paid. Repair, replacement, or refund of the purchase price are the sole remedies under the warranty. If replacement parts are used in making repairs, those parts may be remanufactured, or may contain remanufactured materials. If it is necessary to replace the entire Product, it may be replaced with a remanufactured Product. Remanufactured Products, parts and materials are warranted for the remaining warranty term of the original Product, or 90 days after the date of repair or replacement, whichever is longer.

Limitations

This warranty does not cover circumstances beyond Kodak's control. This warranty does not apply when failure is due to shipping damage, accident, alteration, modification, unauthorized service, misuse, abuse, use with incompatible accessories or attachments (such as third party ink or ink tanks), failure to follow Kodak's operation, maintenance or repacking instructions, failure to use items supplied by Kodak (such as adapters and cables), or claims made after the duration of this warranty. Kodak makes no other express or implied warranty for this product. In the event that the exclusion of any implied warranty is ineffective under the law, the duration of the implied warranty will be the length of the express warranty period

www.kodak.com/go/support

specified on your Kodak product packaging. The option of repair, replacement, or refund is Kodak's only obligation. Kodak will not be responsible for any special, consequential or incidental damages resulting from the sale, purchase, or use of this product regardless of the cause. Liability for any special, consequential or incidental damages (including but not limited to loss of revenue or profit, downtime costs, loss of the use of the equipment, cost of substitute equipment, facilities or services, or claims of your customers for such damages resulting from the purchase, use, or failure of the Product), regardless of cause or for breach of any written or implied warranty is expressly disclaimed. The limitations and exclusions of liability set forth herein apply to both Kodak and its suppliers.

Your rights

Some states or jurisdictions do not allow exclusion or limitation of incidental or consequential damages, so the above limitation or exclusion may not apply to you. Some states or jurisdictions do not allow limitations on how long an implied warranty lasts, so the above limitation may not apply to you. This warranty gives you specific rights, and you may have other rights which vary from state to state or by jurisdiction.

Outside the United States and Canada

In countries other than the United States and Canada, the terms and conditions of this warranty may be different. Unless a specific Kodak warranty is communicated to the purchaser in writing by a Kodak company, no warranty or liability exists beyond any minimum requirements imposed by law, even though defect, damage, or loss may be by negligence or other act.

Regulatory compliance

FCC compliance and advisory

This equipment has been tested and found to comply with the limits for a Class B digital device, pursuant to Part 15 of the FCC Rules. These limits are designed to provide reasonable protection against harmful interference in a residential installation. This equipment generates, uses, and can radiate radio frequency energy and, if not installed or used in accordance with the instructions, may cause harmful

interference to radio communications. However, there is no guarantee that interference will not occur in a particular installation. If this equipment does cause harmful interference to radio or television reception, which can be determined by turning the equipment off and on, the user is encouraged to try to correct the interference by one or more of the following measures: 1) reorient or relocate the receiving antenna; 2) increase the separation between the equipment and the receiver; 3) connect the equipment to an outlet on a circuit different from that to which the receiver is connected; 4) consult the dealer or an experienced radio/TV technician for additional suggestions. Any changes or modifications not expressly approved by the party responsible for compliance could void the user's authority to operate the equipment. Where shielded interface cables have been provided with the product or specified additional components or accessories elsewhere defined to be used with the installation of the product, they must be used in order to ensure compliance with FCC regulation. The KODAK High Performance USB AC Adapter K20-AM complies with part 15 of the FCC Rules. Operation is subject to the following two conditions: (1) This device may not cause harmful interference, and (2) this device must accept any interference received, including interference that may cause undesired operation.

Waste Electrical and Electronic Equipment/Battery disposal



In Europe: For human/environmental protection, it is your responsibility to dispose of this equipment and batteries at a collection facility established for this purpose (separate from municipal waste.) For more information, contact your retailer, collection facility, or appropriate local authorities; or go to www.kodak.com/go/recycle. Product weight:

Camera, alkaline batteries, and SD card: 473 g (16.7 oz)

Camera, Ni-MH batteries, and SD card: 493 g (17.4 oz)



Canadian DOC statement

DOC Class B Compliance—This Class B digital apparatus complies with Canadian ICES-003.

Observation des normes-Classe B—Cet appareil numérique de la classe B est

www.kodak.com/go/support

EN 55

conforme à la norme NMB-003 du Canada.

CE

Hereby, Eastman Kodak Company declares that this KODAK Product is in compliance with the essential requirements and other relevant provisions of Directive 1999/5/EC.

Australian C-Tick



VCCI Class B ITE

この装置は、クラスB情報技術装置です。この装置は、家庭環境で使用することを目的としていますが、この装置がラジオやテレビジョン受信機に近接して使用されると、受信障害を引き起こすことがあります。

取扱説明書に従って正しい取り扱いをして下さい。

VCCI-B

Korean Class B ITE

B급 기기
(가정용 방송통신기기)

이 기기는 가정용(B급)으로 전자파적합등록을
한 기기로서 주로 가정에서 사용하는 것을 목적
으로 하며, 모든 지역에서 사용할 수 있습니다.

Russian GOST-R



Eastman Kodak Company
Rochester, NY 14650

Фотокамера изготовлена в Китае, остальные элементы -
АЮ-40 в соответствии с маркировкой.

China RoHS

环保使用期限 (EPUP)

在中国大陆, 该值表示产品中存在的任何危险物质不得释放, 以免危及人身健康、财产或环境的时间期限 (以年计)。该值根据操作说明中所规定的产品正常使用而定。

有毒有害物质或元素名称及含量标识表						
部件名称	有毒有害物质或元素					
	铅	汞	镉	六价铬	多溴联苯	多溴二苯醚
数码相机电路板元件	×	○	○	○	○	○

○: 表示该有毒有害物质在该部件所有均质材料中的含量均在SJ/T 11363-2006规定的限量要求以下。
 ×: 表示该有毒有害物质至少在该部件的某一均质材料中的含量超出SJ/T 11363-2006规定的限量要求。



USB 数据线

Index

A

- A/V out, 29
- about this camera, 39
- accessories
 - batteries, 52
 - buying, 47
 - SD/SDHC Card, 4
- action print, 28
- add keywords, names, 33
- AF control, 36
- AF zone, 36
- auto
 - flash, 11
 - focus control, 36
 - focus framing marks, 6
- auto focus (AF)
 - zone, 36

B

- backlight, 16
- battery
 - expected life, 52
 - icons, 8
 - load, 1, 2
 - types, 52
- bright, 16
- burst, use, 14
- button
 - Burst, 14
 - Display, 7
 - Flash, 11
 - focus, 12

- Review, 35
- Share, 30
- Zoom, 10

C

- cable
 - audio/video, 29
 - USB, 40
- Camera Setup App, 40
- camera sounds, 37, 38
- Canadian compliance, 55
- care and maintenance, 50
- charging
 - battery icon, 8
- children, 16
- clock, setting, 3
- color mode, 36
- computer
 - connect camera, 40
 - transfer to, 40
- computer connection, 38
- connector, USB / A/V, 29
- copy pictures to computer, 40
- cropping pictures, 27

D

- date setting, 3
- date/time stamp, 21
- deleting
 - from internal memory, 23
 - from SD/SDHC Card, 23
- Display button, 7

disposal, recycling, 50
download
 KODAK Software, 40
download pictures, 40

E

edit videos, 27
emailing pictures, videos, 34
erase, 39
expected battery life, 52
exposure
 compensation, 17, 19
 long time, 37
external video device
 viewing pictures, videos, 29

F

face detect capture, 36
faces, tagging, recognition, 32
FCC compliance, 54
find pictures, 25
fireworks, 16
firmware, upgrading, 50
flash settings, 11
flower, 16
focus
 zone, 36
focus button, 12
focus framing marks, 6
format, 39
framing marks, 6

G

guidelines, battery, 52

H

help
 Web links, 43
High ISO, 16
histogram, 19

I

icons
 battery, 8
 mode dial, 15
image storage, 38
infinity focus, 12
install
 batteries, 1, 2
 SD/SDHC Card, 4

K

keyboard, 33
keywords, 34
KODAK Camera Setup App, 40
KODAK EASYSHARE Software
 upgrading, 50
KODAK Software, download, 40
Kodak Web sites, 43

L

language, 38
LCD
 brightness, 37
 reviewing pictures, 22
 reviewing videos, 22
lens, clean, 50
load
 batteries, 1, 2
 SD/SDHC Card, 4

locate pictures, 25
long time exposure, 37

M

macro focus, 12
magnify a picture, 24
maintenance, camera, 50
make picture from video, 28
manual mode, 17
marking
 for email, 34
memory
 insert card, 4
menu settings, 35
mode dial, 15
modes
 backlight, 16
 bright, 16
 children, 16
 fireworks, 16
 flower, 16
 High ISO, 16
 manual, 17
 Night Landscape, 15
 night portrait, 16
 self-portrait, 16
modes, picture-taking, 15
multiple selections, 28
multi-up, 24

N

names, tagging, 32
Night Landscape, 15
night portrait, 16

O

online prints, ordering, 42
optical zoom, 10
orientation sensor, 38

P

P and M modes, 15
panoramic pictures, 20
people, tagging, 32
PICTBRIDGE enabled printer, 41
picture size, 35, 37
picture taking, 6
pictures
 adding date/time stamp, 21
 cropping, 27
 emailing marked, 34
 marking, 42
 review icons, 26
 reviewing, 22
 taking, modes, 15
 transfer to computer, 40
pictures/video
 deleting, 23
playing a video, 22
Portrait mode, 15
power icon, 8
power, camera, 3
print from a video, 28
printing
 from a card, 42
 optimizing printer, 43
 order online, 42
 PICTBRIDGE, 41
 tagged pictures, 42

R

- recognizing faces, 32
- record button, 9
- recycling, disposal, 50
- red-eye, flash, 11
- regulatory information, 54
- reset camera, 38
- Review button, 35
- reviewing pictures/video
 - deleting, 23
 - LCD, 22

S

- safety, 51
- Scene (SCN) mode, 15
- Scene (SCN) modes, 16
- scene modes
 - Stage, 16
- SD/SDHC Card
 - insert, 4
 - printing from, 42
- search pictures, 25
- select multiple pictures/videos, 28
- self-portrait, 16
- setting
 - about this camera, 39
 - AF zone, 36
 - auto focus, 36
 - auto-focus, 36
 - camera sounds, 37, 38
 - color mode, 36
 - computer connection, 38
 - date and time, 3
 - flash, 11
 - focus zone, 36
 - format, 39
 - image storage, 38
 - language, 38
 - LCD brightness, 37
 - long time exposure, 37
 - orientation sensor, 38
 - picture size, 35, 37
 - picture taking modes, 15
 - reset all settings, 38
 - sharpness, 36
 - video out, 38
 - white balance, 35
- setting up the camera, 1
- settings
 - picture, video size, 35, 37
- setup menu, 35
- Share button, 30, 37
- sharpness, 36
- shutter
 - problems, 44
 - speed, 17
- shutter button, 6
- single frame, 28
- Smart Capture mode, 15
- smart find, 25
- software
 - upgrading, 50
- software downloader, 40
- sounds, 37, 38
- specifications, camera, 48
- Sport mode, 15
- Stage, 16
- strap, 5

T

tagging

- keywords, 34
- people, faces, 32

taking a picture, 6

taking a video, 9

television, slide show, 29

time, setting, 3

tips

- battery guidelines, 52
- care & maintenance, 50

transfer pictures, 40

trimming a video, 27

troubleshooting, 43

turning camera on/off, 3

typing, 33

U

undelete, undo, 23

upgrading software, firmware, 50

URLs, Kodak Web sites, 43

USB

- transfer pictures, 40

V

VCCI compliance, 56

video

- edit, 27
- emailing marked, 34
- out, 38
- playback, 22
- recording, 9
- review icons, 26
- transfer to computer, 40

viewing, 22

video action print, 28

video out, 38

video record button, 9

video size, 35, 37

viewing

- by multi-up, 24
- picture, after taking, 22

W

warranty, 53

white balance, 35

Z

zoom

- optical, 10

Free Manuals Download Website

<http://myh66.com>

<http://usermanuals.us>

<http://www.somanuals.com>

<http://www.4manuals.cc>

<http://www.manual-lib.com>

<http://www.404manual.com>

<http://www.luxmanual.com>

<http://aubethermostatmanual.com>

Golf course search by state

<http://golfingnear.com>

Email search by domain

<http://emailbydomain.com>

Auto manuals search

<http://auto.somanuals.com>

TV manuals search

<http://tv.somanuals.com>