

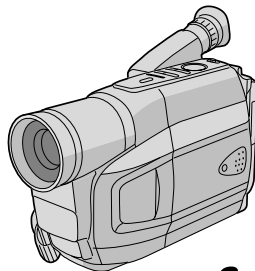

## COMPACT VHS CAMCORDER

**JVC**

## GR-AX780

**Compact VHS****VHS**

 Printed in Malaysia  
0103-DY-YL-PJ

COPYRIGHT© 2003 VICTOR COMPANY OF JAPAN, LTD

**Dear Customer,**

Thank you for purchasing the JVC Compact VHS camcorder. Before use, please read "PRECAUTIONS" (Z pg. 3, 4) to ensure safe use of this product.

**AUTOMATIC DEMONSTRATION**

Automatic Demonstration takes place when "DEMO MODE" is set to "ON" (factory-preset).

- Available when the Power Switch **1** is set to "A" or "M" while pressing down the Lock Button **10** located on the switch.
- Performing any operation during the demonstration stops the demonstration temporarily. If no operation is performed for more than 1 minute after that, the demonstration will resume.
- "DEMO MODE" remains "ON" even if the camcorder power is turned off.
- To cancel Automatic Demonstration, set the Power Switch **1** to "M" and press the MENU Wheel **1** in while the demo is in progress. This takes you directly to the demo mode's Setting Menu (so you will not have to go through the main Menu Screen). Rotate the MENU Wheel **1** to select "OFF" and press it.

**NOTES:**

- When a tape whose Erase Protection tab is in the position that allows recording is loaded in the camcorder, demonstration is not available.
- If you do not detach the Lens Cap, you cannot see the actual changes of the Automatic Demonstration activated on the viewfinder.

## PROVIDED ACCESSORIES

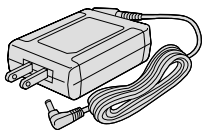

• AC Adapter

AP-V13U or AP-V10U

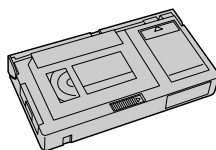
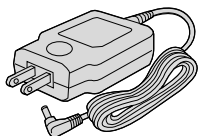

• Cassette Adapter  
C-P7U

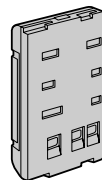

• Battery Pack  
BN-V11U



• AA (R6) Battery  
(for Cassette Adapter)



• Lens Cap

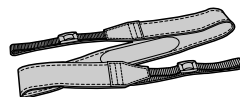



• Shoulder Strap

### NOTE:

In order to maintain optimum performance of the camcorder, provided cables may be equipped with one or more core filter. If a cable has only one core filter, the end that is closest to the filter should be connected to the camcorder.

# PRECAUTIONS

## SAFETY PRECAUTIONS

	<b>CAUTION</b> RISK OF ELECTRIC SHOCK DO NOT OPEN	
<b>CAUTION:</b> TO REDUCE THE RISK OF ELECTRIC SHOCK, DO NOT REMOVE COVER (OR BACK). NO USER-SERVICEABLE PARTS INSIDE. REFER SERVICING TO QUALIFIED SERVICE PERSONNEL.		



The lightning flash with arrowhead symbol, within an equilateral triangle, is intended to alert the user to the presence of uninsulated "dangerous voltage" within the product's enclosure that may be of sufficient magnitude to constitute a risk of electric shock to persons.



The exclamation point within an equilateral triangle is intended to alert the user to the presence of important operating and maintenance (servicing) instructions in the literature accompanying the appliance.

### WARNING:

**TO REDUCE THE RISK OF FIRE OR ELECTRIC SHOCK, DO NOT EXPOSE THIS APPARATUS TO RAIN OR MOISTURE.**

This product has a fluorescent lamp that contains a small amount of mercury. Disposal of these materials may be regulated in your community due to environmental considerations. For disposal or recycling information please contact your local authorities, or the Electronics Industries Alliance:

<<http://www.eiae.org>>

### CAUTIONS

- This camcorder is designed to be used with NTSC-type color television signals. It cannot be used for playback with a television of a different standard. However, live recording and viewfinder playback are possible anywhere.
- Use the JVC BN-V11U/V12U/V20U/V400U battery packs and, to recharge them or to supply power to the camcorder from an AC outlet, use the provided multi-voltage AC Adapter. (An appropriate conversion adapter may be necessary to accommodate different designs of AC outlets in different countries.)

### NOTES:

- The rating plate (serial number plate) and safety caution are on the bottom and/or the back of the main unit.
- The rating information and safety caution of the AC Adapter are on its upper and lower sides.

### ATTENTION:

The product that you have purchased is powered by a rechargeable battery. The battery is recyclable. At the end of its useful life, under various state and local laws, it may be illegal to dispose of this battery into the municipal waste stream. Check with your local solid waste officials for details in your area for recycling options or proper disposal.



Cassettes marked **VHS** can be used with this camcorder.

When the equipment is installed in a cabinet or on a shelf, make sure that it has sufficient space on all sides to allow for ventilation (10 cm (3-15/16") or more on both sides, on top and at the rear).

Do not block the ventilation holes.

(If the ventilation holes are blocked by a newspaper, or cloth etc. the heat may not be able to get out.)

No naked flame sources, such as lighted candles, should be placed on the apparatus.

When discarding batteries, environmental problems must be considered and the local rules or laws governing the disposal of these batteries must be followed strictly.

The apparatus shall not be exposed to dripping or splashing.

Do not use this equipment in a bathroom or places with water.

Also do not place any containers filled with water or liquids (such as cosmetics or medicines, flower vases, potted plants, cups etc.) on top of this unit.

(If water or liquid is allowed to enter this equipment, fire or electric shock may be caused.)

## IMPORTANT SAFETY INSTRUCTIONS

- (1) Read these instructions.
- (2) Keep these instructions.
- (3) Heed all warnings.
- (4) Follow all instructions.
- (5) Do not use this apparatus near water.
- (6) Clean only with dry cloth.
- (7) Do not block any ventilation openings. Install in accordance with the manufacturer's instructions.
- (8) Do not install near any heat sources such as radiators, heat registers, stoves, or other apparatus (including amplifiers) that produce heat.
- (9) Only use attachments/accessories specified by the manufacturer.
- (10) Use only with the cart, stand, tripod, bracket, or table specified by the manufacturer, or sold with the apparatus. When a cart is used, use caution when moving the cart/apparatus combination to avoid injury from tip-over.
- (11) Unplug this apparatus during lightning storms or when unused for long periods of time.
- (12) Refer all servicing to qualified service personnel. Servicing is required when the apparatus has been damaged in any way, such as power-supply cord or plug is damaged, liquid has been spilled or objects have fallen into the apparatus, the apparatus has been exposed to rain or moisture, does not operate normally, or has been dropped.



# INDEX

## A

AC Adapter .....	pg. 6
Animation Recording .....	pg. 21
Auto Date Record .....	pg. 20
Auto Focus .....	pg. 12
Auto Shut Off .....	pg. 11

## B

Backlight Compensation .....	pg. 12
Battery Pack .....	pg. 6, 26
Blue Filter Effect .....	pg. 24

## C

Cassette Adapter .....	pg. 16
Charge Marker .....	pg. 6
Charging The Battery Pack .....	pg. 6
Clean The Camcorder .....	pg. 27
Connection To a VCR/TV .....	pg. 15
Counter Memory .....	pg. 14

## D

Date/Time Display .....	pg. 20
Date/Time Settings .....	pg. 7
Demonstration Mode .....	pg. 1, 22
Digital Effects .....	pg. 24
Digital Zoom .....	pg. 20
Diopter Adjustment .....	pg. 8

## E

Electronic Fog Filter Mode .....	pg. 24
Erase Protection .....	pg. 8
Exposure Control .....	pg. 18

## F

Fade-In/Out .....	pg. 23
Fast-Forward Tape .....	pg. 11
5-Second Recording Mode .....	pg. 12

## G

Grip Adjustment .....	pg. 8
-----------------------	-------

## H

High Speed Shutter Mode .....	pg. 24
-------------------------------	--------

## I

Instant Titles .....	pg. 19
----------------------	--------

## L

Load A Tape .....	pg. 8
-------------------	-------

## M

Manual Focus .....	pg. 12
Menu Screen .....	pg. 18 – 22
Monotone Effect .....	pg. 24
Mosaic Effect .....	pg. 24

## N

ND Effect Mode .....	pg. 24
Nega/Posi Mode .....	pg. 24

## P

Picture Stabilizer .....	pg. 18
Playback .....	pg. 11
Program AE with Special Effects .....	pg. 24
Provided Accessories .....	pg. 2

## Q

Quick Review .....	pg. 13
--------------------	--------

## R

Recording, Advanced Features .....	pg. 23, 24
Recording, Start/Stop .....	pg. 11
Recording Mode .....	pg. 20
Record-Standby .....	pg. 11
Red Filter Effect .....	pg. 24
Retake .....	pg. 13
Rewind The Tape .....	pg. 11

## S

Sepia Mode .....	pg. 24
Shoulder Strap Attachment .....	pg. 8
Solarization Effect .....	pg. 24
Specifications .....	pg. 28
Sports Mode .....	pg. 24
Still Playback .....	pg. 11
Stretch Effect .....	pg. 24
Super LoLux (S.LX) .....	pg. 20

## T

Tape Counter .....	pg. 14
Tape Dubbing .....	pg. 15
Tape Length Setting .....	pg. 20
Tele Macro .....	pg. 21
Time Base Corrector .....	pg. 14
Time-Lapse Shooting .....	pg. 21
Tracking .....	pg. 14
Tripod Mounting .....	pg. 8
Twilight Mode .....	pg. 24

## U

Unload A Tape .....	pg. 8
---------------------	-------

## V

Viewfinder Adjustment .....	pg. 8
Viewfinder, Indications .....	pg. 9, 10, 17

## W

White Balance Adjustment .....	pg. 19
Wide Mode .....	pg. 20
Wipe-In/Out .....	pg. 23

## Z

Zooming .....	pg. 13
---------------	--------

## GETTING STARTED

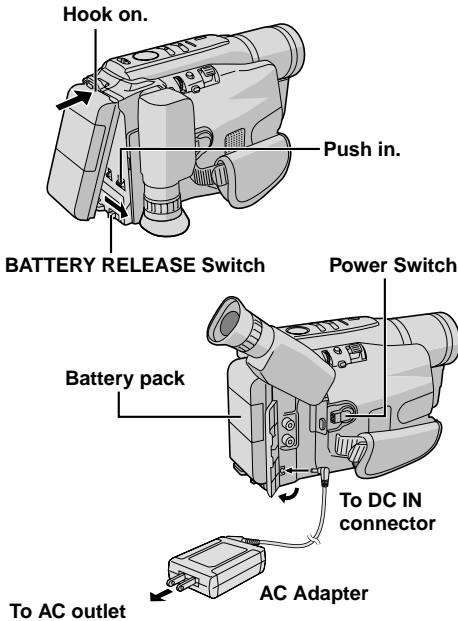

## CHARGING THE BATTERY PACK

- Hook the end of the battery pack to the camcorder and push the battery in until it locks in place.
  - If the battery pack is attached in the wrong position, a malfunction may occur.
- Set the Power Switch **11** to "OFF" while pressing down the Lock Button **10** located on the switch. Connect the AC Adapter to the DC IN connector **8**.
- Plug the AC Adapter into an AC outlet. The CHARGE lamp **18** blinks to indicate charging has started.
- When the CHARGE lamp **18** stops blinking but stays lit, charging is finished. Unplug the AC Adapter from the AC outlet. Disconnect the AC Adapter from the camcorder.

### To Detach The Battery Pack . . .

... slide BATTERY RELEASE **7** and pull out the battery pack.

Battery pack	Charging time
BN-V11U	approx. 1 hr. 40 min.
BN-V12U (optional)	approx. 1 hr. 40 min.
BN-V20U (optional)	approx. 2 hrs. 40 min.
BN-V400U (optional)	approx. 5 hrs. 10 min.

Charging times are for a fully discharged battery pack.

## USING THE BATTERY PACK

Perform step **1**) of "CHARGING THE BATTERY PACK".

### Approximate recording time (unit: min.)

Battery pack	Viewfinder on
BN-V11U	90
BN-V12U (optional)	90
BN-V20U (optional)	145
BN-V400U (optional)	350

## USING AC POWER

Connect the AC Adapter to the camcorder (**Z** step **2**) and **3**) of "CHARGING THE BATTERY PACK").

- The provided AC Adapter features automatic voltage selection in the AC range from 110 V to 240 V.

### ATTENTION

Before detaching the power source, make sure that the camcorder's power is turned off. Failure to do so can result in a camcorder malfunction.

## REFRESH:

Be sure to fully discharge a battery pack before recharging, otherwise the battery performance will be reduced.

- Perform steps **1**) through **3**) of "CHARGING THE BATTERY PACK".
- Press REFRESH **19** for over 2 seconds. The POWER lamp **12** blinks to indicate discharging has started.
- When discharging is finished, charging automatically starts and the CHARGE lamp **18** blinks.

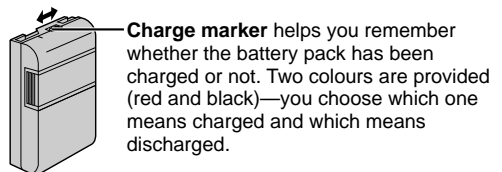

## STORE BATTERY:

Be sure to fully discharge a battery pack by performing the following steps storing it for a long period of time, otherwise the battery performance will be reduced.

- 1) Attach the battery to the camcorder with no cassette inserted.
- 2) Set the Power Switch **11** to "A" or "M" while pressing down the Lock Button **10** located on the switch.

- During charging or discharging, the camcorder cannot be operated.
- Charging and discharging is not possible if the wrong type of battery is used.
- When charging the battery pack for the first time or after a long storage period, the CHARGE lamp **18** may not light. Remove the battery pack from the camcorder, then try charging again.
- If a fully-charged battery's operation time remains extremely short, the battery is worn out. Please purchase a new one.
- Perform charging where the temperature is between 10°C and 35°C (50°F and 95°F). 20°C to 25°C (68°F to 77°F) is the ideal temperature range for charging. If the environment is too cold, charging may be incomplete.
- Charging time varies according to the ambient temperature and the status of the battery pack.
- Since the AC Adapter processes electricity internally, it becomes warm during use. Be sure to use it only in well-ventilated areas.
- The following operation stops charging or discharging:
  - Set the Power Switch **11** to "PLAY", "A" or "M".
  - Disconnect the AC Adapter from the camcorder.
  - Unplug the AC Adapter's power cord from the AC outlet.
  - Detach the battery from the camcorder.
- Using the optional AA-V15 AC Power Adapter/Charger, you can charge the BN-V11U/V12U/V20U/V400U battery pack without the camcorder. However, it cannot be used as an AC adapter.
- To avoid interference with reception, do not use the AC Adapter near a radio.
- Recording time is reduced significantly when Zoom or Record-Standby mode is engaged repeatedly.
- Before extended use, it is recommended that you prepare enough battery packs to cover 3 times the planned shooting time.

## Date/Time Settings

- 1) Set the Power Switch **11** to "M" while pressing down the Lock Button **10** located on the switch.
- 2) Press the MENU Wheel **1** in. The Menu Screen appears.
- 3) Rotate the MENU Wheel **1** to select "►TO SYSTEM MENU" and press it to display SYSTEM MENU. Rotate the MENU Wheel **1** to select "►NEXT" and press it to display the next page.
- 4) Rotate the MENU Wheel **1** to select "DATE/TIME" and press it. The DATE/TIME Menu appears.
- 5) To set "YEAR", "MONTH", "DAY" or "TIME" (hour/minute), rotate the MENU Wheel **1** to select the desired item, and press it. When the setting begins blinking, rotate the MENU Wheel **1** until the correct setting appears and then press it. The setting stops blinking.
- 6) When none of these settings ("YEAR", "MONTH", "DAY", "TIME") blinks, rotate the MENU Wheel **1** to select "►EXIT", and press it. The Menu Screen reappears with the highlight bar on "►RETURN".
- 7) Press the MENU Wheel **1** in to close the Menu Screen.
  - To display the date and time in the camcorder's display and on a connected TV, see DATE/TIME DISP. (Z pg. 20) in SYSTEM MENU.
  - The date/time cannot be stored in memory if the built-in clock battery runs out. Consult an authorised JVC dealer for replacement, or set the date/time as necessary before you start shooting.

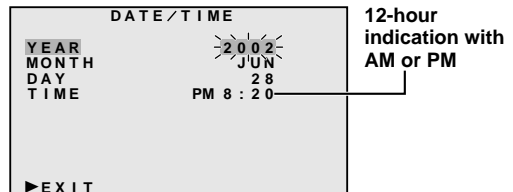
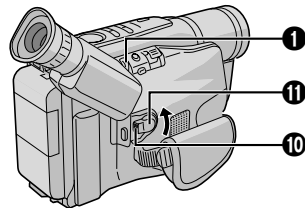

## Grip Adjustment

- 1) Separate the Velcro strip.
- 2) Pass your right hand through the loop and grasp the grip.
- 3) Adjust so that your thumb and fingers can easily operate the Recording Start/Stop Button **9** and Power Zoom Lever **4**. Refasten the Velcro strip.

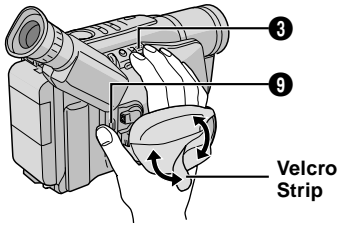

## Viewfinder Adjustment

- 1) Set the Power Switch **11** to "A" or "M" while pressing down the Lock Button **10** located on the switch.
- 2) Turn the Dioptre Adjustment Control **26** until the indications in the viewfinder are clearly focused.

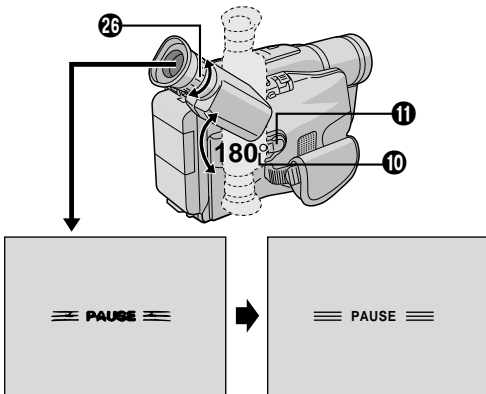

## Shoulder Strap Attachment

Thread the strap through the eyelet **23**, then fold it back and thread it through the buckle. Repeat the procedure to attach the other end of the strap to the other eyelet **23**, making sure the strap is not twisted. Adjust the length.

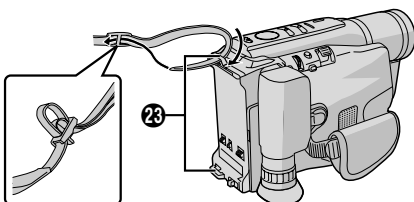

## Tripod Mounting

Align the screw and camera direction stud on the tripod with the tripod mounting socket **29**. Then tighten the screw.

### CAUTION

When using a tripod, be sure to open and extend its legs fully to stabilise the camcorder. To prevent damage to the unit caused by falling over, do not use a small-sized tripod.

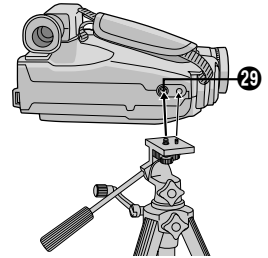

## Loading/Unloading A Cassette

- 1) Slide EJECT **17** until the cassette holder opens. Do not use force to open.
  - 2) Insert or remove a cassette. When inserting, make sure the label is facing outward.  appears when a cassette is loaded.
  - 3) Press the Close button **25** to close the cassette holder until it locks into place.
- Make sure the erase protection tab is in the position that allows recording. If not, slide the tab. Some cassettes have removable tabs. If the tab has been removed, cover the hole with adhesive tape.
  - The cassette holder cannot be opened while the camcorder is in the record mode or detached from the power source.

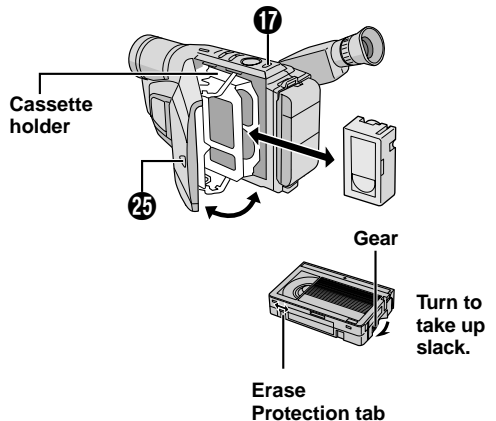



# CONTROLS, CONNECTORS AND INDICATORS

Refer to this diagram while reading the instructions.

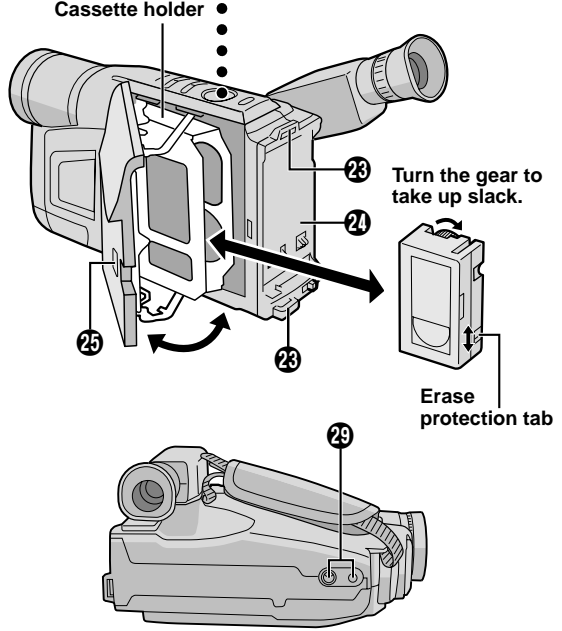
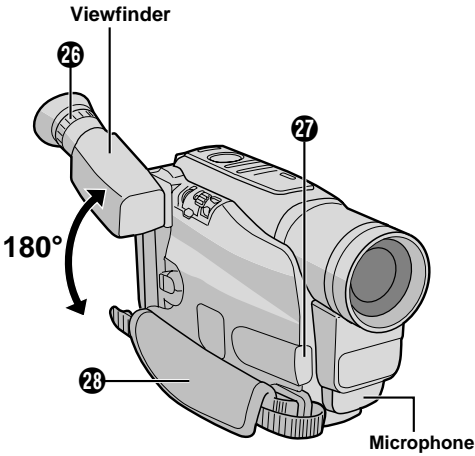
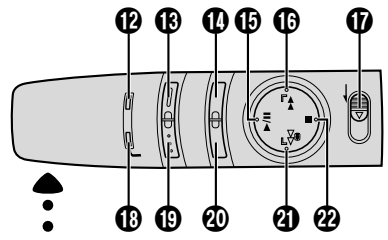
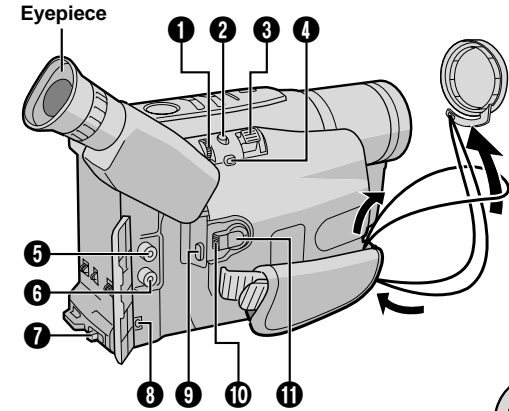

## Viewfinder Indications

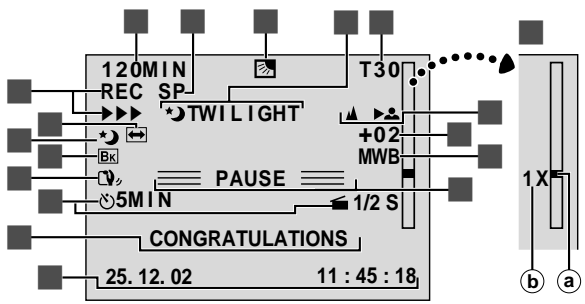

During Recording

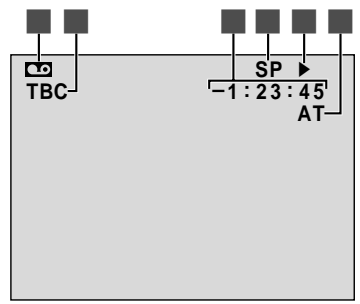

During Playback



Z pg. 25 for **Warning Indications**.

① • MENU Wheel [-, +] .....	Z	pg. 18	■ Tape Remaining Time .....	Z	pg. 21
• TRACKING Wheel [-, +] .....	Z	pg. 14	■ Recording Mode Indicator .....	Z	pg. 20
② 5-Second Recording Button [5 SEC. REC] .....	Z	pg. 12	■ Backlight Compensation Indicator .....	Z	pg. 12
③ Power Zoom Lever [T/W] .....	Z	pg. 13	■ • Digital Effect Indicator .....	Z	pg. 24
④ • Manual Focus Button [M FOCUS] .....	Z	pg. 12	• Programme AE Indicator .....	Z	pg. 24
• Time Base Corrector Button [TBC] .....	Z	pg. 14	• Fade/Wipe-Standby Indicator .....	Z	pg. 23
⑤ Audio Output Connector [A] .....	Z	pg. 15	■ Tape Length Indicator .....	Z	pg. 20
⑥ Video Output Connector [V] .....	Z	pg. 15	■ Zoom Indicator Bar .....	Z	pg. 13
⑦ Battery Release Switch [BATTERY RELEASE] .....	Z	pg. 6	a) Zoom Level Indicator		
⑧ DC IN Connector .....	Z	pg. 6	b) Approximate Zoom Ratio		
⑨ Recording Start/Stop Button .....	Z	pg. 11	■ Recording Indicator .....	Z	pg. 11
⑩ Lock Button .....	Z	pg. 11	■ Digital Effect Indicator .....	Z	pg. 24
⑪ Power Switch [PLAY, OFF, A, M] .....	Z	pg. 11	■ Programme AE Indicator .....	Z	pg. 24
⑫ POWER Lamp .....	Z	pg. 6	■ Fade/Wipe-Standby Indicator .....	Z	pg. 23
⑬ Digital Effect Button [DIGIFECT] .....	Z	pg. 24	■ Picture Stabilizer Indicator .....	Z	pg. 18
⑭ Programme AE Button [P.AE] .....	Z	pg. 24	■ • Interval Time/Recording Time Indicator ...	Z	pg. 21
⑮ Play/Pause Button .....	Z	pg. 11	• 5 Sec. Rec Mode Indicator .....	Z	pg. 12
⑯ • Retake Forward Button [RETAKE F] .....	Z	pg. 13	■ Instant Title Display .....	Z	pg. 19
• Fast-Forward Button [F] .....	Z	pg. 11	■ Date/Time Display .....	Z	pg. 20
⑰ EJECT Switch .....	Z	pg. 8	■ Focus Indicator .....	Z	pg. 12
⑱ CHARGE Lamp .....	Z	pg. 6	■ Exposure Control Level Counter .....	Z	pg. 18
⑲ REFRESH Button .....	Z	pg. 6	■ White Balance Mode Indicator .....	Z	pg. 19
⑳ • Fade/Wipe Button [FADE/WIPE] .....	Z	pg. 23	■ Record-Standby Mode Indicator .....	Z	pg. 11
• Counter Reset/Memory Button [COUNTER R/M] .....	Z	pg. 14	■  : Cassette Indicator .....	Z	pg. 8
㉑ • Retake Rewind Button [RETAKE R] .....	Z	pg. 13	■ TBC Indicator .....	Z	pg. 14
• Quick Review Button [  R] .....	Z	pg. 13	■ Tape Counter .....	Z	pg. 14
• Rewind Button [R] .....	Z	pg. 11	■ Recording Mode Indicator (SP/EP) .....	Z	pg. 20
㉒ • Stop Button [STOP] .....	Z	pg. 11	■ Tape Running Indicator		
• Backlight Compensation Button [BACK LIGHT] .....	Z	pg. 12	▶ : Playback		
㉓ Shoulder Strap Eyelets .....	Z	pg. 8	▶▶ : Fast-Forward/Shuttle Search		
㉔ Battery Pack Mount .....	Z	pg. 6	◀◀ : Rewind/Shuttle Search		
㉕ Close Button .....	Z	pg. 8	: Pause		
㉖ Dioptre Adjustment Control .....	Z	pg. 8	■ Tracking Indicator .....	Z	pg. 14
㉗ Camera Sensor Be careful not to cover this area; a sensor necessary for shooting is built-in here.					
㉘ Grip Strap .....	Z	pg. 8			
㉙ Tripod Mounting Socket .....	Z	pg. 8			

## RECORDING

Set REC MODE, TAPE LENGTH and DATE/TIME in SYSTEM MENU.

(Z pg. 18 – 22, “MENU SETTINGS”)

1 Remove the lens cap. Set the Power Switch **11** to “A” or “M” while pressing down the Lock Button **10** located on the switch.

The camcorder enters the Record-Standby mode and “PAUSE” **15** is displayed.

2 Press the Recording Start/Stop Button **9**. **REC** **15** appears while recording is in progress.

• To stop recording, press the Recording Start/Stop Button **9**. The camcorder re-enters the Record-Standby mode.

## PLAYBACK

1 Load a tape (Z pg. 8, “Loading/Unloading A Cassette”).

2 Set the Power Switch **11** to “PLAY” while pressing down the Lock Button **10** located on the switch. To start playback, press **▶/|| 15**.

To stop playback temporarily (Still Playback), press **▶/|| 15**. To stop playback, press **■ 22**. Press **◀◀ 21** to rewind, or **▶▶ 16** to fast-forward the tape.

High-speed picture search (Shuttle Search) is possible by pressing **◀◀ 21** or **▶▶ 16** during playback (holding **◀◀ 21** or **▶▶ 16** down during playback continues search until released). To resume normal playback, press **▶/|| 15**.









### For VIDEO RECORDING/VIDEO PLAYBACK

- The camcorder shuts off automatically after about 5 minutes in the Record-Standby or Stop mode. To turn on again, set the Power Switch **11** to “OFF”, then to “A”, “M” or “PLAY”.
- The playback picture can be viewed in the viewfinder or on a connected TV (Z pg. 15, “Connections To A TV/VCR”).
- To remove the indications, Z pg. 20, 21, DISPLAY or OSD OUTPUT in SYSTEM MENU.

## BASIC FEATURES









### 5Sec. Rec (5-sec. Recording)

To record a scene for 5 seconds, providing quick scene transitions like those seen in TV programmes.

- 1) Make sure the recording mode is set to "SP".
  - 2) During Record–Standby, press 5SEC. REC .  5S  appears and 5Sec. Rec is reserved.
  - 3) Press the Recording Start/Stop Button . Recording starts, and after 5-second recording is finished, the camcorder re-enters the Record–Standby mode automatically.
  - 4) To cancel the 5Sec. Rec. function, press 5SEC. REC  again so that  5S  disappears.
- Fade/Wipe ( pg. 23) cannot be activated by pressing 5SEC. REC .















### Backlight Compensation

To quickly increase the brightness of the subject relative to the background.

- 1) Press BACK LIGHT  during recording. "" is displayed and the subject is brightened.
  - 2) To cancel Backlight Compensation, press BACK LIGHT  again. "" disappears and the brightness returns to the previous level.
- Backlight Compensation functions in both recording modes ("" or "").
  - Using BACK LIGHT  may make the subject too bright, resulting in a washed out or white image.
  - BACK LIGHT  cannot be used when the manual Exposure Control mode ( pg. 18) is engaged.

### Auto/Manual Focus

If correct focus cannot be obtained with Auto Focus, use Manual Focus.

- 1) Set the Power Switch  to "" while pressing down the Lock Button  located on the switch.
  - 2) Press  FOCUS . "" appears.
  - 3) To focus on a distant subject, rotate the MENU Wheel  upward. "" appears and blinks. To focus on a close subject, rotate the MENU Wheel  downward. "" appears and blinks.
  - 4) To cancel the Manual Focus, press  FOCUS . "" disappears and the Auto Focus is applied.
- When the focus level cannot be adjusted any farther or closer, "" or "" will blink.

## Zooming

To produce the zoom in/out effect. Digital circuitry extends the maximum magnification offered by optical zoom. This system is called Digital Zoom.

- Slide the Power Zoom Lever **3** towards "T" to zoom in, or "W" to zoom out.
- The further you slide the Power Zoom Lever **3**, the quicker the zoom action.
- Focusing may become unstable during Zooming. In this case, set the zoom while in Record–Standby, lock the focus by using the manual focus (Z pg. 12, "Auto/Manual Focus"), then zoom in or out in Record mode.
- The zoom level indicator ■-ⓐ moves during zoom. Once the zoom level indicator ■-ⓐ reaches the top, all magnification from that point is through digital processing.
- When using Digital Zoom, the quality of image may suffer. To deactivate Digital Zoom, set "D.ZOOM" (Z pg. 20) to "OFF" in SYSTEM MENU.

## Quick Review

To check the end of the last recording.

- 1) Make sure the camcorder is in the Record–Standby mode.
  - 2) Press ◀◀ **2** and release quickly.  
Tape is rewound for approx. 1 second and played back automatically, then pauses in Record–Standby mode for the next shot.
- Distortion may occur at the start of playback. This is normal.

## Retake

To re-record certain segments.

- 1) Make sure the camcorder is in the Record–Standby mode.
  - 2) Press and hold either RETAKE **16** or **21** to reach the start point for new recording. Pressing ▶▶ **16** forwards the tape and pressing ◀◀ **21** reverses it.
  - 3) Press the Recording Start/Stop Button **9** to start recording.
- Noise bars appear and pictures may become monochrome or darken during Retake. This is normal.

## Tracking

Eliminates noise bars that appear on-screen during playback. To activate Manual Tracking:

- 1) Press the TRACKING Wheel **1** for approx. 2 seconds. "MT" **■** appears.
  - 2) Rotate the TRACKING Wheel **1** so that the noise bars disappear.
- To return to Auto Tracking, press the TRACKING Wheel **1** for approx. 2 seconds or set the Power Switch **1** to "OFF" and then "PLAY" again. "AT" **■** blinks. When Auto Tracking finishes, the indication disappears.
  - When noise bars appear during playback, the camcorder enters the Auto Tracking mode and "AT" **■** appears.
  - Manual Tracking may not work with tapes recorded on other VCRs or camcorders.

## TBC (Time Base Corrector)

Removes jitter from fluctuating video signals to deliver a stable picture even with old tapes.

To activate/release the TBC mode, press TBC **4** during playback for more than 1 second. When the TBC mode is activated, "TBC" **■** is displayed.

- The "TBC" indicator **■** turns green (grey with a camcorder equipped with a black/white viewfinder) while TBC is working, and white while TBC is not operative.
- TBC does not work during Still Playback and Shuttle Search (**Z** pg. 11).
- It may take a few seconds before TBC actually starts working.
- The picture may be distorted if the TBC mode is activated or deactivated at the edit-in/-out points or when normal playback resumes after Still Playback or Shuttle Search (**Z** pg. 11).
- If the playback picture is distorted when TBC is set to on, turn off TBC.

## Counter Memory

Makes it easier to locate a specific tape segment.

- 1) Press COUNTER R/M **20** and hold for more than 1 second. The counter **■** resets to "0:00:00".
  - 2) Press COUNTER R/M **20** for less than 1 second. "M" appears.
  - 3) After recording or playback, press **■** **22**, then **◀◀** **21**. The tape automatically stops at or close to 0:00:00.
  - 4) Press **▶/II** **15** to start playback.
- The counter memory functions in the Fast-Forward and Rewind modes.
  - To disable the counter memory function, press COUNTER R/M **20** for less than 1 second so that "M" disappears.

## Connections To A TV/VCR

- 1) Make sure all units are turned off.
- 2) Connect the camcorder to a TV or VCR using the optional video and audio cables. If using both TV and VCR, connect the VCR output to the TV input.
- 3) Turn on all units. Set the VCR to its AUX input mode, and set the TV to its VIDEO mode.
  - Use the AC Adapter as the power supply.
  - Be sure to adjust the TV sound volume to its minimum level to avoid a sudden burst of sound when the camcorder is turned on.
  - If you have a TV or speakers that are not specially shielded, do not place the speakers adjacent to the TV as interference will occur in the camcorder playback picture.

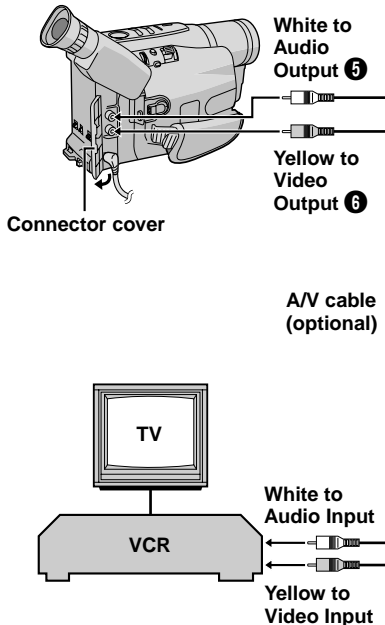

## Tape Dubbing

- 1) Connect the camcorder and the VCR (Z "Connections To A TV/VCR"). Set the Power Switch 11 to "PLAY" while pressing down the Lock Button 10 located on the switch, turn on the VCR's power, and insert the appropriate cassettes in the camcorder and the VCR. Engage the VCR's AUX and Record-Pause modes.
- 2) Press ►/|| 15 to find a spot just before the edit-in point. Once it is reached, press ►/|| 15 again.
- 3) Press ►/|| 15 and engage the VCR's Record mode.
- 4) Engage the VCR's Record-Pause mode and press ►/|| 15.
  - Repeat steps 2) through 4) for additional editing, then stop the VCR and camcorder when finished.

## Using The Cassette Adapter

Use this to play back an VHS-C video cassette recorded with this camcorder on a VHS VCR.

- 1) Slide the battery cover up to remove it, install one "AA (R6)" size battery, then reattach the cover.
  - 2) Slide the latch to open the compartment door, then insert the cassette and close the compartment door.
  - 3) Load the cassette adapter into the VCR and play the tape back.
  - 4) Slide the latch and the compartment door opens automatically. This may take around 10 seconds. Do not attempt to force the adapter open. Then, insert your finger in the hole, and push up and remove the cassette.
- During tape loading and unloading, do not touch the reels for safety and tape protection.
  - During special-effect playback (slow motion, still frame, etc.), the picture may vibrate or noise bars may appear on the screen.
  - To record on a VCR using a compact cassette and the adapter, cover the adapter's recording safety hole with adhesive tape.

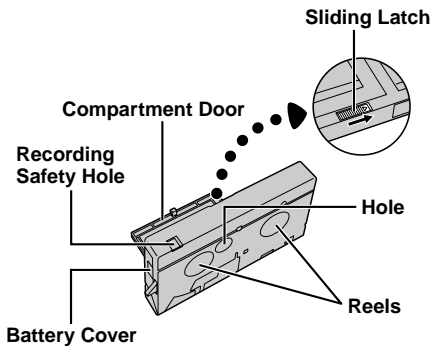



# INSTRUCTIONS

Refer to this diagram while reading the instructions.

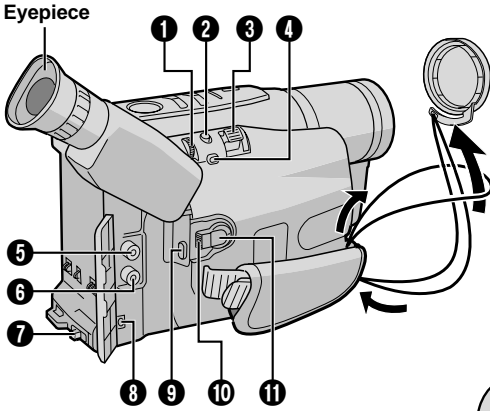

During shooting

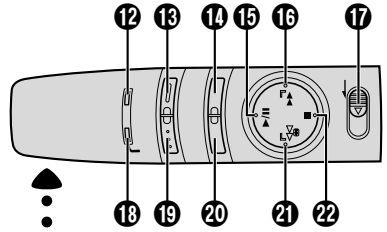
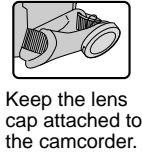

Cassette holder

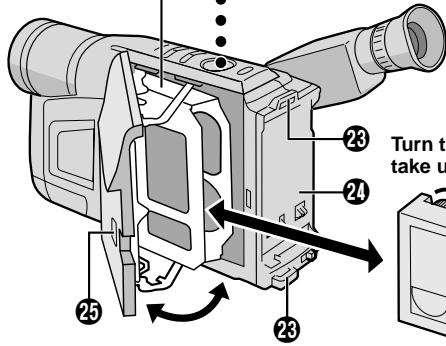

Turn the gear to take up slack.

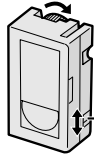

Erase protection tab

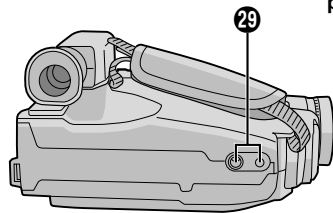
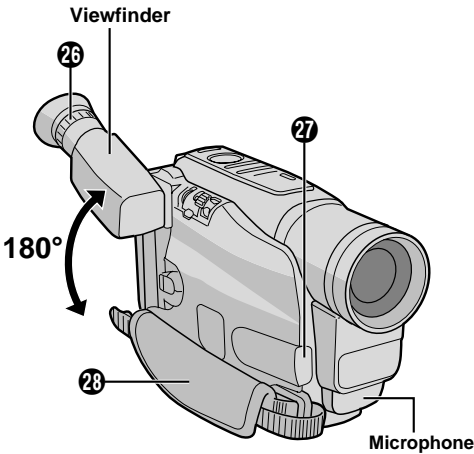

## Viewfinder Indications

During Recording

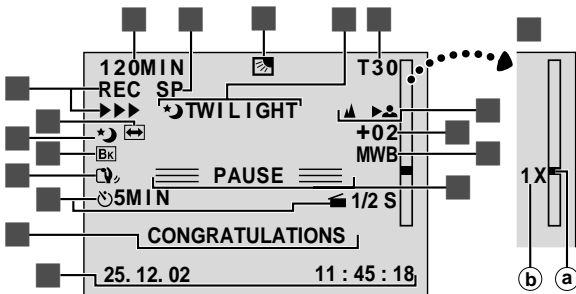

During Playback

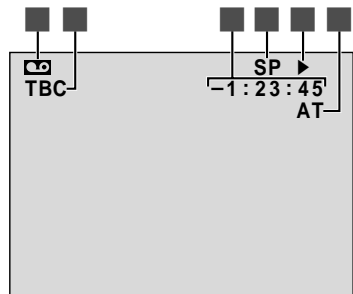

Z pg. 25 for **Warning Indications**.

## MENU SETTINGS

1 Set the Power Switch **11** to "M" while pressing down the Lock Button **10** located on the switch.

2 Press the MENU Wheel **1** in. The Menu Screen appears. Rotate the MENU Wheel **1** to select the desired function.

- To go from CAMERA MENU to SYSTEM MENU, rotate the MENU Wheel **1** to select "►TO SYSTEM MENU" and press it. SYSTEM MENU is composed of 2 pages. To go to the next page, rotate the MENU Wheel **1** to select "►NEXT" and press it.
- To return to CAMERA MENU from page 2 of SYSTEM MENU, rotate the MENU Wheel **1** to select "►TO CAMERA MENU" and press it.

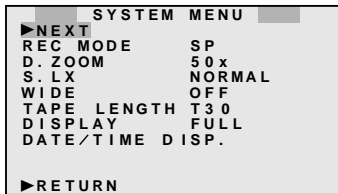
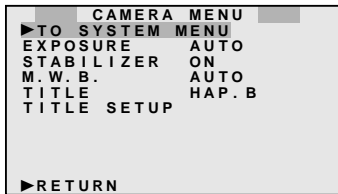

3 Press the MENU Wheel **1** in to display the Setting Menu and rotate it to select the desired setting.

4 Press the MENU Wheel **1** in. The Menu Screen reappears with the highlight bar on "►RETURN". Press the MENU Wheel **1** in. The normal screen reappears.

## CAMERA MENU

### EXPOSURE

Manual exposure adjustment is recommended in the following situations:

- When shooting using reverse lighting or when the background is too bright.
- When shooting on a reflective natural background such as at the beach or when skiing.
- When the background is overly dark or the subject light.

1) Rotate the MENU Wheel **1** to select "MANUAL", then press it,

2) To brighten the image, rotate the MENU Wheel **1** downward.

To darken the image, rotate the MENU Wheel **1** upward.

The exposure control level increases / decreases (maximum  $\pm 06$ ).

### STABILIZER

The Picture Stabilizer compensates for unstable images caused by camera-shake, particularly at high magnification.



**ON** : The Picture Stabilizer is activated.

  appears.

**OFF** : The Picture Stabilizer is deactivated.

  disappears.

• Accurate stabilization may not be possible in certain conditions including excessive hand shake.

•   appears blinking if the Stabilizer cannot be used.

## **M.W.B.**

If the white balance is correct, all other colours will be accurately reproduced.

**AUTO** : White balance is adjusted automatically.

 **FINE** : Outdoors on a sunny day.

 **CLOUD** : Outdoors on a cloudy day.

 **HALOGEN** : A video light or similar type of lighting is used.

**MWB:** White balance is set manually. Hold a sheet of plain white paper in front of the subject. Adjust zoom or position yourself so that the white paper fills the screen. If it is difficult to focus on the white paper, adjust focus manually (Z pg. 12, "Auto/Manual Focus"). Press the MENU Wheel  in until "MWB" begins blinking. When the setting is completed, "MWB" stops blinking.

• Once you adjust white balance manually, the setting is retained even if the power is turned off or the battery removed.

• White balance cannot be used when the "SEPIA" or "MONOTONE" mode (Z pg. 24, "Digital Effects") is activated.

## **TITLE**

Allows you to superimpose one of eight preset titles.

-  shows the selected title which remains until OFF is selected.

## **TITLE SETUP**



Adjust the settings for TITLE.

**SIZE** : When "LARGE" is selected, the title is twice enlarged vertically more than selected "NORMAL".

Even if "LARGE" is selected, "NORMAL" is automatically changed when you select "WIDE" mode (Z pg. 20, "SYSTEM MENU").

**SCROLL** : When "ON" is selected, the title is scrolled from right to left.

**LANGUAGE** : Select the language (ENGLISH, FRENCH, SPANISH, PORTUGUESE) for TITLE.

To set "SIZE", "SCROLL" or "LANGUAGE", rotate the MENU Wheel  to select the desired item, and press it. When the setting begins blinking, rotate the MENU Wheel  until the correct setting appears and then press it. The setting stops blinking.

## SYSTEM MENU

This Menu Screen cannot be accessed while recording.

### REC MODE

Allows you to set the recording mode. "EP" (Extended Play) is more economical, providing three times the recording time.

- If the recording mode is switched during recording, the playback picture will be blurred at the switching point.

### D. ZOOM

Zooming is possible from 16X (the optical zoom limit), to a maximum of 50X or 600X digital magnification.

When set to "OFF" only optical zoom (maximum 16x magnification) can function.

### S.LX

**MAX:** To record a subject in a darkly lit environment, when it is more convenient to shoot the subject with a brighter image even if the picture becomes slightly coarse.

**NORMAL:** To record a subject in a dimly lit environment, when it is more convenient to shoot with a less coarse picture although the subject becomes slightly dark.

**OFF:** Allows you to shoot dark scenes with no picture brightness adjustment.

### WIDE

When set to "ON" black bars will be recorded at the top and bottom of the screen to produce a cinematic "wide-screen" effect.

While the "WIDE" mode is engaged, "LARGE" in the "TITLE SETUP (SIZE)" (Z pg. 19, "CAMERA MENU") cannot be selected.



### TAPE LENGTH

Allows you to set the tape length depending on the tape used: T20=20 minutes, T30=30 minutes, T35=35 minutes, T40=40 minutes.

- Tape remaining time  is correct only if the correct tape length has been selected.

### DISPLAY

**FULL:** Makes all of the indications appear on the viewfinder during playback or recording.

**SIMPLE:** Makes the following indications disappear from the viewfinder during recording or playback: , tape remaining time, , tape length (Z pg. 9, 17).

### DATE/TIME DISP.

Makes the date/time appear in the camcorder or on a connected monitor (set DATE/TIME in SYSTEM MENU first Z pg. 7).

- The selected display will be recorded. If you do not want to record the display, select OFF before shooting.
- In the AUTO DATE mode, the camcorder records the date for about 5 seconds when recording is initiated after the date is changed, a cassette is loaded, or AUTO DATE is selected. The date is replaced after 5 seconds with "AUTO DATE" but this is not recorded.

### **OSD OUTPUT**

**ON:** On-screen indications are displayed.

**OFF:** On-screen indications are turned off except Date/Time, Instant Title and Warning Indication.

### **REC TIME**

You can shoot a series of pictures, each slightly different, of the same object for a brief selected period of time (Animation). REC MODE should be set to "SP".

Select the desired recording time and press the Recording Start/Stop Button **9** after focusing on the subject.

- Fade- or wipe-in/out cannot be performed.
- This function is cancelled when the power is shut off or when the cassette is ejected.
- To use this function, it is recommended that SCROLL in TITLE SETUP (Z pg. 18, 19) be set to "OFF".

### **INT. TIME**

You can record sequentially at preset time spans. Leaving the camcorder aimed at a specific subject, you can record subtle changes over an extended period of time (Time-Lapse). REC MODE should be set to "SP".

(Please note that it is necessary to set the REC TIME (Animation) in the SYSTEM MENU before performing the INT. TIME (Time-Lapse) function.)

Select the desired interval time and press the Recording Start/Stop Button **9**.

- Fade- or wipe-in/out cannot be performed.
- This function is cancelled when the power is shut off or when the cassette is ejected.
- To use this function, it is recommended that SCROLL in TITLE SETUP (Z pg. 18, 19) be set to "OFF".

### **TELE MACRO**

When set to "ON", you can shoot a subject as large as possible at a distance of approx. 60 cm (23-5/8"). Depending on the zoom position, the lens may go out of focus.

## **DEMO MODE**

Demonstrates certain functions automatically. Available when the Power Switch **1** is set to “**A**” or “**M**” and “DEMO MODE” is set to “ON” (factory-preset). Performing any operation during the demonstration stops the demonstration temporarily. Set to OFF to stop completely.

- When a tape whose erase protection tab is in the position that allows recording is loaded in the camcorder, demonstration is not available.
- If you do not detach the Lens Cap, you cannot see the actual changes of the Automatic Demonstration activated on the viewfinder.

## **DATE/TIME**

Allows you to set the current date and time.

(Z pg. 7)

## ADVANCED FEATURES

### Fade/Wipe Effects

Fade- or wipe-in works at recording start, and fade- or wipe-out works at recording end.

- 1) Set the Power Switch **11** to “**M**” while pressing down the Lock Button **10** located on the switch.
- 2) Press FADE/WIPE **20** repeatedly until the desired mode appears.
- 3) Press the Recording Start/Stop Button **9** to activate fade-in/out or wipe-in/out.
  - Pressing and holding the Recording Start/Stop Button **9** allows you to vary the length for the image during fade in/out or wipe in/out.
  - To cancel a fade or wipe, press FADE/WIPE **20** repeatedly until “OFF” appears.

**FX** **FADER**: Fades in/out to a black screen.

**FX** **MOSAIC (Fader)**: Gradually turns/returns the picture into/from a mosaic pattern.

**FX** **SHUTTER (Wipe)**: A black screen moves in from the top and bottom, closing over the image like a shutter, or a new image pushes open the black screen vertically from the centre.

**FX** **SLIDE (Wipe)**: A black screen moves in from the left to gradually cover the image, or a new image moves in from right to left.

**FX** **DOOR (Wipe)**: Wipes in as the two halves of a black screen open to the left and right, revealing the scene, or wipes out and the black screen reappears from left and right to cover the scene.

**FX** **CORNER (Wipe)**: Wipes in on a black screen from the upper right to the lower left corner, revealing the scene, or wipes out from lower left to upper right, leaving a black screen.

**FX** **WINDOW (Wipe)**: Wipes in on a black screen from the centre of the screen towards the corners, revealing the scene, or wipe out from the corners to the centre, leaving a black screen.

## Programme AE With Special Effects

- 1) Set the Power Switch **(1)** to “**(M)**” while pressing down the Lock Button **(10)** located on the switch.
- 2) Press P.AE **(14)** repeatedly until the desired mode appears.

- To cancel the effect, press P.AE **(14)** repeatedly until “OFF” appears.

- Only one mode can be engaged at a time.

- In the “High Speed Shutter” or “Sports” modes, picture colour may be adversely affected if the subject is lit by alternating discharge-type light sources such as fluorescent or mercury-vapour lights.

**SPORTS:** High shutter speed clearly captures fast-moving action.

**ND : ND EFFECT:** A black mist darkens the picture, as when an ND filter is used. Helps to counter the effects of glare on the subject.

**FG : FOG:** Makes the picture look misty white, as when an external fog filter is attached to the lens. Softens the image and gives it a “fantasy” look.

**TWILIGHT:** Dusk, twilight scenery, fireworks, etc., look more natural and dramatic. In this mode, the Auto Focus (**Z** pg. 12) and S.LX (**Z** pg. 20) may not work.

**S1/2000 (1/2000 sec. High Speed Shutter):** Captures faster action than Sports mode. The screen becomes slightly dark. Use in well-lit situations.

## Digital Effects

- 1) Set the Power Switch **(1)** to “**(M)**” while pressing down the Lock Button **(10)** located on the switch.
- 2) Press DIGIFECT **(18)** repeatedly until the desired mode appears.

- To cancel the effect, press DIGIFECT **(18)** repeatedly until “OFF” appears.

**SEPIA:** Recorded scenes have a brownish tint like old photos. Combine this with WIDE in SYSTEM MENU for a classic look.

**B/W MONOTONE:** Like black and white films, your footage is shot in B/W. Combine this with WIDE in SYSTEM MENU for a classic look.

**B. FILTER:** Recorded scenes have a bluish tint.

**R. FILTER:** Recorded scenes have a reddish tint.

**SOLARI:** The picture is recorded with an effect similar to a painting.

**NEGA POSI:** The colours of a picture are reversed.

**MOSAIC:** Turns recorded scenes into a mosaic pattern.

**STRETCH:** Doubles the width of the picture horizontally.



# TROUBLESHOOTING

Before consulting your JVC dealer, please check the following to see if you can correct the problem yourself.

## **Vertical white lines appear when shooting a very bright object.**

- This sometimes occurs when the contrast between the back-ground and the object is great. It is not a defect of the camcorder.

## **Bright, crystal-shaped spots appear in the viewfinder.**

- Sunlight is directly entering the lens. This is not a defect of the camcorder.

## **Coloured bright spots appear all over the viewfinder.**

- The viewfinder are made with high-precision technology. However, black spots or bright spots of light (red, green or blue) may appear constantly in the viewfinder. These spots are not recorded on the tape. This is not due to any defect of the unit. (Effective dots: more than 99.99 %.)

## **Animation or Time-Lapse is not available.**

- Before recording in the Animation mode at the very beginning of a tape, set the camcorder to the Recording mode for about 5 seconds, so that the tape runs smoothly. Using the Fade-in function at this point is a good way to begin an animated programme (Z pg. 21, REC TIME/INT. TIME in SYSTEM MENU).

## **The tape is running, but there is no playback picture.**

- The TV has not been set to its VIDEO mode or channel.
- If A/V connection is used, the TV's VIDEO/TV Switch has not been set to VIDEO.

## **Playback picture is blurred or interrupted.**

- The video heads are dirty or worn out. Consult your nearest JVC dealer for head cleaning or replacement.

## **The tape stops during fast-forward or rewind.**

- The Counter Memory Function has been activated (Z pg. 14, "Counter Memory").

## **The date and time displays disappear.**







- If you remove the power source from the camcorder while the power is on, all settings and selections are erased. Make sure to turn the camcorder's power off before disconnecting the power source.

## **The tape will not eject.**

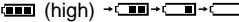
- The battery pack is running low.

The camcorder is a microcomputer-controlled device. External noise and interference (from a TV, a radio, etc.) might prevent it from functioning properly. In such cases, first disconnect its power supply unit (battery pack, AC Adapter, etc.); and then re-connect it and proceed as usual from the beginning.

## Warning Indications

 (high) →  →  →  →  (exhausted) : Displays the battery remaining power level. As the battery power comes close to nil, the battery indicator  blinks (battery power warning). When the battery power is exhausted, power turns off automatically.

 : Blinks when no cassette is loaded, or when the erase protection tab is not in the position that allows recording.

**TAPE END:** Appears when the tape ends during recording, playback or fast-forward.

**LENS CAP:** Appears for 5 seconds after power is turned on if the lens cap is attached.

 **CONDENSATION OPERATION PAUSED PLEASE WAIT:** These 2 warnings appear alternately every 3 seconds if condensation occurs. In this case, all functions except tape eject and power on/off are disabled. Remove the tape, turn the unit off (without removing the power supply), wait a few minutes for the warnings to clear, and turn it on again.

 **HEAD CLEANING REQUIRED USE CLEANING CASSETTE:** These 2 warnings appear alternately every 3 seconds if dirt is detected on the heads during recording. In this case, use an optional cleaning cassette. If the warning remains after cleaning, consult your nearest JVC dealer.

**E01—E06 UNIT IN SAFEGUARD MODE REMOVE AND REATTACH BATTERY:** The error indications (E01 — E06) show what type of malfunction has occurred. If an error indication and warning appear, turn the unit off, remove the power supply (battery, etc.) and wait a few minutes for them to clear. When it does, you can resume using the camcorder. If the indication remains, consult your nearest JVC dealer.

# CAUTIONS

## When using the AC Adapter in areas other than the USA

- The provided AC Adapter features automatic voltage selection in the AC range from 110 V to 240 V.

## USING HOUSEHOLD AC PLUG ADAPTER

In case of connecting the unit's AC Adapter to an AC wall outlet other than American National Standard C73 series type use an AC plug adapter, called a "Siemens Plug", as shown. For this AC plug adapter, consult your nearest JVC dealer.

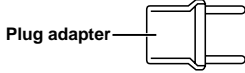

- If there is dust or dirt on the AC Adapter, wipe it clean before using.

## General Battery Precautions

If the cassette adapter is not functioning even if it is being operated correctly, the batteries are exhausted. Replace them with fresh ones.

Please make note of the following rules for battery use. When misused, the batteries can leak or explode.

1. When replacing batteries, read the cassette adapter (C-P6U/C-P7U) instructions.
2. **Do not** use any different size of batteries from those specified.
3. Be sure to install batteries in the correct direction.
4. **Do not** use rechargeable batteries.
5. **Do not** expose the batteries to excessive heat as they can leak or explode.
6. **Do not** dispose of the batteries in a fire.
7. Remove the batteries from the unit if it is to be stored for an extended period to avoid battery leakage which can cause malfunctions.

## Battery Packs

The battery packs are nickel-cadmium or nickel metal-hydride batteries. Before using the supplied battery pack or an optional battery pack, be sure to read the following cautions:

### 1. To avoid hazard . . .

- .... **do not** burn.
- .... **do not** short-circuit the terminals.
- .... **do not** modify or disassemble.
- .... use only specified chargers.

### 2. To prevent damage and prolong service life . . .

- .... **do not** subject to unnecessary shock.
- .... avoid repeated charging without fully discharging.
- .... charge in an environment where temperatures are within the tolerances shown in the chart below. This is a chemical reaction type battery—cooler temperatures impede chemical reaction, while warmer temperatures can prevent complete charging.
- .... store in a cool, dry place. Extended exposure to high temperatures will increase natural discharge and shorten service life.

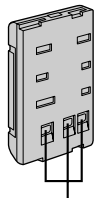

Terminals

- .... fully charge and then fully discharge the battery every 6 months when storing the battery pack over a long period time.
- .... remove from charger or powered unit when not in use, as some machines use current even when switched off.
- It is normal for the battery pack to be warm after charging, or after use.  
Temperature Range Specifications  
Charging ..... 10°C to 35°C (50°F to 95°F)  
Operation ..... 0°C to 40°C (32°F to 104°F)  
Storage ..... -10°C to 30°C (14°F to 86°F)
- Recharging time is based on room temperature of 20°C (68°F).
- The lower the temperature, the longer recharging takes.

## Cassettes

To properly use and store your cassettes, be sure to read the following cautions:

### 1. During use . . .

- .... make sure the cassette bears the VHS-C mark.
- .... be aware that recording onto prerecorded tapes automatically erases the previously recorded video and audio signals.
- .... make sure the cassette is positioned properly when inserting.
- .... do not load and unload the cassette repeatedly without allowing the tape to run at all. This slackens the tape and can result in damage.
- .... do not open the front tape cover. This exposes the tape to fingerprints and dust.

### 2. Store cassettes . . .

- .... away from heaters or other heat sources.
- .... out of direct sunlight.
- .... where they won't be subject to unnecessary shock or vibration.
- .... where they won't be exposed to strong magnetic fields (such as those generated by motors, transformers or magnets).
- .... vertically, in their original cases.

## Main Unit

### 1. For safety, DO NOT . . .

- .... open the camcorder's chassis.
- .... disassemble or modify the unit.
- .... short-circuit the terminals of the battery pack. Keep it away from metallic objects when not in use.
- .... allow inflammables, water or metallic objects to enter the unit.
- .... remove the battery pack or disconnect the power supply while the power is on.
- .... leave the battery pack attached when the camcorder is not in use.

## 2. Avoid using the unit . . .

- .... in places subject to excessive humidity or dust.
- .... in places subject to soot or steam such as near a cooking stove.
- .... in places subject to excessive shock or vibration.
- .... near a television set.
- .... near appliances generating strong magnetic or electric fields (speakers, broadcasting antennas, etc.).
- .... in places subject to extremely high (over 40°C or 104°F) or extremely low (under 0°C or 32°F) temperatures.

## 3. DO NOT leave the unit . . .

- .... in places of over 50°C (122°F).
- .... in places where humidity is extremely low (below 35%) or extremely high (above 80%).
- .... in direct sunlight.
- .... in a closed car in summer.
- .... near a heater.
- .... in dusty places such as a beach.

## 4. To protect the unit, DO NOT . . .

- .... allow it to become wet.
- .... drop the unit or strike it against hard objects.
- .... subject it to shock or excessive vibration during transportation.
- .... keep the lens directed at extremely bright objects for long periods.
- .... direct the eyepiece of the viewfinder at the sun.
- .... carry it by holding the viewfinder. Be sure to hold the main unit with both hands or use the grip.
- .... swing it excessively when using the shoulder strap.

## 2. Cleaning The Camcorder

- ① Wipe gently the exterior with a soft cloth. Put cloth in diluted mild soap and wring it well to wipe off heavy dirt, then wipe again with a dry cloth.
- ② Blow the lens with a blower brush, then wipe it gently with lens cleaning paper.
- ③ Turn the eyepiece counterclockwise and pull it out.
- ④ Remove dust from the viewfinder using a blower brush.
- ⑤ Re-attach the eyepiece and turn it clockwise.

- Avoid using strong cleaning agents such as benzine or alcohol.
- Cleaning should be done only after the battery pack has been removed or other power units have been disconnected.
- Mould may form if the lens is left dirty.
- When using a cleaner or chemically treated cloth, refer to the cautions that came with it.
- When removing the eyepiece, be sure to hold the viewfinder securely.

This Class B digital apparatus complies with Canadian ICES-003.

Cet appareil numérique de la classe B est conforme à la norme NMB-003 du Canada.

### About moisture condensation . . .

- You may have observed that pouring a cold liquid into a glass will cause drops of water to form on the glass' outer surface. This same phenomenon occurs on the head drum of a camcorder when it is moved from a cool place to a warm place, after heating a cold room, under extremely humid conditions or in a place directly subjected to the cool air from an air conditioner.
- Moisture on the head drum can cause severe damage to the video tape, and can lead to internal damage to the camcorder itself.

## Serious malfunctioning

If malfunctioning occurs, stop using the unit immediately and consult your local JVC dealer.

## For Your Maintenance

### 1. After Use

- ① Set the **Power Switch** to "OFF" to turn off the camcorder.
- ② Slide **EJECT** to open the cassette holder, then remove the cassette.
- ③ Close and lock the cassette holder by pressing the **Close** button.
- ④ Slide **BATTERY RELEASE** to remove the battery pack.
- ⑤ Attach the provided lens cap to the camcorder's lens.

# SPECIFICATIONS

## Camcorder

### General

**Format** : VHS NTSC standard  
**Power source** : DC 11 V  $\text{---}$  (Using AC Adapter)  
DC 6 V  $\text{---}$  (Using battery pack)

### Power consumption

**Viewfinder on** : 4.1 W

**Signal system** : NTSC-type

### Video recording system

**Luminance** : FM recording  
**Color** : Converted sub-carrier direct recording  
Conforms to VHS standard

**Cassette** : **VHS** cassette

### Tape speed

**SP** : 33.35 mm/sec. (1-5/16 ips)

**EP** : 11.12 mm/sec. (7/16 ips)

### Recording time (max.)

**SP** : 40 minutes

**EP** : 120 minutes  
(with TC-40 cassette)

### Operating

**temperature** : 0°C to 40°C (32°F to 104°F)

**Operating humidity** : 35% to 80%

**Storage temperature** : -20°C to 50°C (-4°F to 122°F)

**Weight** : Approx. 750 g (1.7 lbs)

**Dimensions (W x H x D)** : 108 mm x 117 mm x 199 mm  
(4-5/16" x 4-5/8" x 7-7/8")

**Pickup** : 1/6" format CCD

**Lens** : F1.6, f = 2.7 mm to 43.2 mm,  
16:1 power zoom lens with auto  
iris and macro control, filter  
diameter 40.5 mm

**Viewfinder** : Electronic viewfinder with 0.5"  
black/white CRT

### White balance

**adjustment** : Auto/Manual adjustment

## Connectors

**Video** : 1 V (p-p), 75  $\Omega$  unbalanced,  
analog output (via Video output  
connector)

**Audio** : 300 mV (rms), 1 k $\Omega$  analog output  
(via Audio output connector)

## AC Adapter

### Power requirement

**U.S.A. and Canada** : AC 120 V $\sim$ , 60 Hz

**Other countries** : AC 110 V to 240 V $\sim$ , 50 Hz/60 Hz

**Output** : DC 11 V  $\text{---}$ , 1 A

## Optional Accessories

- **Battery Packs BN-V12U, BN-V20U, BN-V400U**
- **A/V (Audio/Video) Cable**
- **Compact VHS (**VHS**) Cassettes TC-40/30/20**
- **Active Carrying Bag CB-V7U**

Some accessories are not available in some areas.  
Please consult your nearest JVC dealer for details on  
accessories and their availability.

Specifications shown are for SP mode unless otherwise indicated. E & O.E. Design and specifications subject to change without notice.

## Free Manuals Download Website

<http://myh66.com>

<http://usermanuals.us>

<http://www.somanuals.com>

<http://www.4manuals.cc>

<http://www.manual-lib.com>

<http://www.404manual.com>

<http://www.luxmanual.com>

<http://aubethermostatmanual.com>

Golf course search by state

<http://golfingnear.com>

Email search by domain

<http://emailbydomain.com>

Auto manuals search

<http://auto.somanuals.com>

TV manuals search

<http://tv.somanuals.com>