

marantz®

Model DV4400 User Guide

DVD Player



**WARNING TO REDUCE THE RISK OF FIRE OR ELECTRIC SHOCK,
DO NOT EXPOSE THIS PRODUCT TO RAIN OR MOISTURE.**



CAUTION

**RISK OF ELECTRIC SHOCK
DO NOT OPEN**



CAUTION:
TO REDUCE THE RISK OF ELECTRIC SHOCK, DO NOT REMOVE COVER (OR BACK). NO USER-SERVICEABLE PARTS INSIDE. REFER SERVICING TO QUALIFIED SERVICE PERSONNEL.



The lightning flash with arrowhead symbol within an equilateral triangle is intended to alert the user to the presence of uninsulated "dangerous voltage" within the product's enclosure that may be of sufficient magnitude to constitute a risk of electric shock to persons.



The exclamation point within an equilateral triangle is intended to alert the user to the presence of important operating and maintenance (servicing) instructions in the literature accompanying the product.

CAUTION: TO PREVENT ELECTRIC SHOCK, MATCH WIDE BLADE OF PLUG TO WIDE SLOT, FULLY INSERT.

ATTENTION: POUR ÉVITER LES CHOC ÉLECTRIQUES, INTRODUIRE LA LAME LA PLUS LARGE DE LA FICHE DANS LA BORNE CORRESPONDANTE DE LA PRISE ET POUSSER JUSQU'AU FOND.

NOTE:

This equipment has been tested and found to comply with the limits for a Class B digital device, pursuant to Part 15 of the FCC Rules. These limits are designed to provide reasonable protection against harmful interference in a residential installation. This equipment generates, uses and can radiate radio frequency energy and, if not installed and used in accordance with the instructions, may cause harmful interference to radio communications. However, there is no guarantee that interference will not occur in a particular installation. If this equipment does cause harmful interference to radio or television reception, which can be determined by tuning the equipment off and on, the user is encouraged to try to correct the interference by one or more of the following measures:

- Reorient or relocate the receiving antenna.
- Increase the separation between the equipment and receiver.
- Connect the equipment into an outlet on a circuit different from that to which the receiver is connected.
- Consult the dealer or an experienced radio/TV technician for help.

NOTE:

Changes or modifications not expressly approved by the party responsible for compliance could void the user's authority to operate the equipment.

Operating Environment

Operating environment temperature and humidity:
+5 C to +35 C (+41 F to +95 F); less than 85%RH (cooling vents not blocked) Do not install in the following locations

- Location exposed to direct sunlight or strong artificial light
- Location exposed to high humidity, or poorly ventilated location

CAUTION:

This product satisfies FCC regulations when shielded cables and connectors are used to connect the unit to other equipment. To prevent electromagnetic interference with electric appliances such as radios and televisions, use shielded cables and connectors for connections.

LASER SAFETY

This unit employs a laser. Only a qualified service person should remove the cover or attempt to service this device, due to possible eye injury.

USE OF CONTROLS OR ADJUSTMENTS OR PERFORMANCE OF PROCEDURES OTHER THAN THOSE SPECIFIED HEREIN MAY RESULT IN HAZARDOUS RADIATION EXPOSURE.

CAUTION VISIBLE AND INVISIBLE LASER RADIATION WHEN OPEN AVOID EXPOSURE TO BEAM (WARNING LOCATION: INSIDE ON LASER COVERSIELD)

This product is for general household purposes. Any failure due to use for other than household purposes (such as long - term use for business purposes in a restaurant or use in a car or ship) and which requires repair will be changed for even during the warranty period.

Do not remove the cover from the equipment.
Do not insert anything into the equipment through the ventilation holes.
Do not handle the mains lead with wet hands.
Make a space of about 0.1 meter around the unit.

Information to User

Alteration or modifications carried out without appropriate authorization may invalidate the user's right to operate the equipment.

**IMPORANT NOTICE
[For U.S. model]**

The serial number for this equipment is located on the rear panel. Please write this serial number on your enclosed warranty card and keep it in a secure area. This is for your security.

IMPORTANT SAFETY INSTRUCTIONS

READ BEFORE OPERATING EQUIPMENT

This product was designed and manufactured to meet strict quality and safety standards. There are, however, some installation and operation precautions which you should be particularly aware of.

1. Read Instructions – All the safety and operating instructions should be read before the product is operated.
2. Retain Instructions – The safety and operating instructions should be retained for future reference.
3. Heed Warnings – All warnings on the product and in the operating instructions should be adhered to.
4. Follow Instructions – All operating and use instructions should be followed.
5. Cleaning – Unplug this product from the wall outlet before cleaning. Do not use liquid cleaners or aerosol cleaners. Use a damp cloth for cleaning.
6. Attachments – Do not use attachments not recommended by the product manufacturer as they may cause hazards.
7. Water and Moisture – Do not use this product near water—for example, near a bath tub, wash bowl, kitchen sink, or laundry tub, in a wet basement, or near a swimming pool, and the like.
8. Accessories – Do not place this product on an unstable cart, stand, tripod, bracket, or table. The product may fall, causing serious injury to a child or adult, and these openings must not be blocked or covered. The openings should never be blocked by placing the product on a bed, sofa, rug, or other similar surface. This product should not be placed in a built-in installation such as a bookcase or rack unless proper ventilation is provided or the manufacturer's instructions have been adhered to.
9. CART – A product and cart combination should be moved with care. Quick stops, excessive force, and uneven surfaces may cause the product and cart combination to overturn.
10. Ventilation – Slots and openings in the cabinet are provided for ventilation and to ensure reliable operation of the product and to protect it from overheating, and these openings must not be blocked or covered. The openings should never be blocked by placing the product on a bed, sofa, rug, or other similar surface. This product should not be placed in a built-in installation such as a bookcase or rack unless proper ventilation is provided or the manufacturer's instructions have been adhered to.
11. Power Sources – This product should be operated only from the type of power source indicated on the marking label. If you are not sure of the type of power supply to your home, consult your product dealer or local power company. For products intended to operate from battery power, or other sources, refer to the operating instructions.



12. Grounding or Polarization – This product may be equipped with a polarized alternating-current line plug (a plug having one blade wider than the other). This plug will fit into the power outlet only one way. This is a safety feature. If you are unable to insert the plug fully into the outlet, try reversing the plug. If the plug should still fail to fit, contact your electrician to replace your obsolete outlet. Do not defeat the safety purpose of the polarized plug.
13. Power-Cord Protection – Power-supply cords should be routed so that they are not likely to be walked on or pinched by items placed upon or against them, paying particular attention to cords at plugs, convenience receptacles, and the point where they exit from the product.
14. Protective Attachment Plug – The product is equipped with an attachment plug having overload protection. This is a safety feature. See Instruction Manual for replacement or resetting of protective device. If replacement of the plug is required, be sure the service technician has used a replacement plug specified by the manufacturer that has the same overload protection as the original plug.
15. Outdoor Antenna Grounding – If an outside antenna or cable system is connected to the product, be sure the antenna or cable system is grounded so as to provide some protection against voltage surges and built-up static charges. Article 810 of the National Electrical Code, ANSI/NFPA 70, provides information with regard to proper grounding of the mast and supporting structure, grounding of the lead-in wire to an antenna discharge unit, size of grounding conductors, location of antenna-discharge unit, connection to grounding electrodes, and requirements for the grounding electrode. See Figure 1.
16. Power-Cord Protection – Power-supply cords should be routed so that they are not likely to be walked on or pinched by items placed upon or against them, paying particular attention to cords at plugs, convenience receptacles, and the point where they exit from the product.

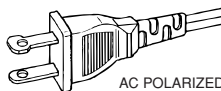

AC POLARIZED PLUG

17. Power Lines – An outside antenna system should not be located in the vicinity of overhead power lines or other electric light or power circuits, or where it can fall into such power lines or circuits. When installing an outside antenna system, extreme care should be taken to keep from touching such power lines or circuits as contact with them might be fatal.
18. Overloading – Do not overload wall outlets, extension cords, or integral convenience receptacles as this can result in a risk of fire or electric shock.
19. Object and Liquid Entry – Never push objects of any kind into this product through openings as they may touch dangerous voltage points or short-out parts that could result in a fire or electric shock. Never spill liquid of any kind on the product.
20. Servicing – Do not attempt to service this product yourself as opening or removing covers may expose you to dangerous voltage or other hazards. Refer all servicing to qualified service personnel.
21. Damage Requiring Service – Unplug this product from the wall outlet and refer servicing to qualified service personnel under the following conditions:
 - a. When the power-supply cord or plug is damaged.
 - b. If liquid has been spilled, or objects have fallen into the product.
 - c. If the product has been exposed to rain or water.
 - d. If the product does not operate normally by following the operating instructions. Adjust only those controls that are covered by the operating instructions as an improper adjustment of other controls may result in damage and will often require extensive work by a qualified technician to restore the product to its normal operation.
 - e. If the product has been dropped or damaged in any way, and
 - f. When the product exhibits a distinct change in performance – this indicates a need for service.
22. Replacement Parts – When replacement parts are required, be sure the service technician has used replacement parts specified by the manufacturer or have the same characteristics as the original part. Unauthorized substitutions may result in fire, electric shock, or other hazards.
23. Safety Check – Upon completion of any service or repairs to this product, ask the service technician to perform safety checks to determine that the product is in proper operating condition.
24. Wall or Ceiling Mounting – The product should be mounted to a wall or ceiling only as recommended by the manufacturer.
25. Heat – The product should be situated away from heat sources such as radiators, heat registers, stoves, or other products (including amplifiers) that produce heat.

FIGURE 1
EXAMPLE OF ANTENNA GROUNDING AS PER
NATIONAL ELECTRICAL CODE, ANSI/NFPA 70

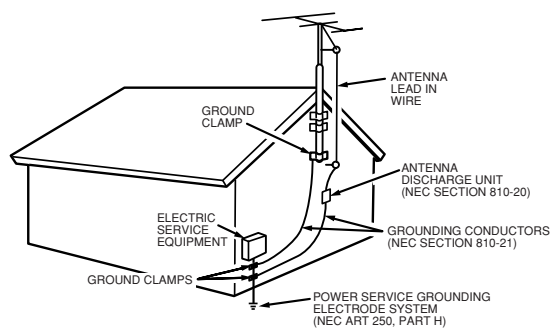

NEC - NATIONAL ELECTRICAL CODE

This Class B digital apparatus complies with Canadian ICES-003.

Cet appareil numérique de la Classe B est conforme à la norme NMB-003 du Canada.

TABLE OF CONTENTS

■ PRECAUTIONS	2	■ DVD SETUP	23
Laser Safety	2	Language Setting	23
Important Safety Instructions	3	Display Setting	23
■ INTRODUCTION	5	Audio Setting	24
About Copyright	5	Parental Control	24
Supplied Accessories	5	PARENTAL LEVEL	24
Symbols Used in This Manual	5	IF YOU FORGET THE PASSWORD	24
■ ABOUT THE DISCS	6	CONTROL LEVELS	24
Playable Discs	6	■ MAINTENANCE	25
Disc Types	6	■ TROUBLESHOOTING GUIDE	26
■ FEATURES	7	■ SPECIFICATIONS	27
■ FUNCTIONAL OVERVIEW	8		
FRONT PANEL	8		
REMOTE CONTROL	8		
Tour of the remote control	9		
Display	11		
Displays During Operation	11		
Using the remote control	11		
Loading the Batteries	11		
■ HOOK UPS	12		
Description - rear panel	12		
Connection to an audio system	13		
Connection to a TV (for video)	14		
■ PLAYING A DISC	15		
Basic Playback	15		
CANCELLING AND CALLING BACK			
PBC FUNCTION	15		
General Features	15		
FL OFF Mode	15		
Pause	15		
Disc Menus	15		
Title Menu	15		
CALLING UP A MENU SCREEN DURING			
PLAYBACK	15		
Step by Step Playback	16		
Resume	16		
Fast Forward / Reverse Search	16		
Slow Forward / Slow Reverse	16		
Zoom	16		
Track	17		
Title / Chapter Search	17		
Time Search	17		
Repeat	17		
REPEAT TITLE / CHAPTER	17		
REPEAT TRACK	17		
A-B REPEAT	18		
Program (CD)	18		
Random Playback (CD)	18		
MP3 / JPEG / WMA Playback	18		
Slide Show Mode	20		
On-Screen Information	20		
Track Selection	20		
Random Playback (MP3/JPEG/WMA)	20		
Program (MP3/JPEG/WMA)	20		
Audio Language or Sound Mode	21		
Stereo Sound Mode	21		
Subtitle Language	21		
Camera Angle	21		
Changing the On-Screen Display	22		
Marker Setup Screen	22		
Black Level Setting	22		
Virtual Surround	22		

INTRODUCTION

The serial number of this product may be found on the back of the DVD player. No others have the same serial number as yours. You should record the number and other vital information here and retain this book as a permanent record of your purchase to aid identification in case of theft. Serial numbers are not kept on file.

Date of Purchase	
Dealer Purchase from	
Dealer Address	
Dealer Phone No.	
Model No.	
Serial No.	



About Copyright

Unauthorized copying, broadcasting, public performance and lending of discs are prohibited. This product incorporates copyright protection technology that is protected by method claims of certain U.S. patents and other intellectual property rights owned by Macrovision Corporation and other rights owners. Use of this copyright protection technology must be authorized by Macrovision Corporation, and is intended for home and other limited viewing uses only unless otherwise authorized by Macrovision Corporation. Reverse engineering or disassembly is prohibited.

Apparatus Claims of U. S. Patent Nos, 4,631,603, 4,577,216, 4,819,098, and 4,907,093 licensed for limited viewing uses only.

Supplied Accessories

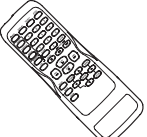
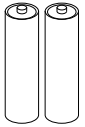
Please check to make sure the following items are included with the main unit in the carton.

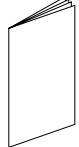
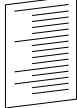
Remote control..... 1 	"AA" (R6P) batteries 2 	Audio cable 1 	Video cable 1 	Operating Instruction.... 1 	Warranty Card for USA..... 1 Warranty Card for Canada... 1 
--	---	--	--	---	--

Symbols Used in this Manual

The following symbols appear below in some headings and notes in this manual, with the following meanings.

- DVD-V** : Description refers to playback of DVD-Video discs.
- CD** : Description refers to playback of Audio CDs.
- MP3** : Description refers to playback of discs formatted with MP3.
- VCD** : Description refers to playback of Video CDs.
- JPEG** : Description refers to viewing of JPEG discs.
- WMA** : Description refers to playback of discs formatted with WMA.
- QUICK** : Description refers to the items to be set in the QUICK mode.

Playable Discs

The following discs can be played back on this DVD player.

Usable discs	Mark (logo)	Recorded signals	Disc Size
DVD-Video (NOTE 1)		Digital video (MPEG2)	12 cm
DVD-R DVD-RW (NOTE 2)	 		8 cm
CD CD-R CD-RW (NOTE 3)	 	Digital audio MP3 WMA (NOTE 4) Digital picture (JPEG)	12 cm 8 cm
Video CD	 	Sound and Pictures	12 cm 8 cm (Singles)
Picture CD		JPEG	12 cm

- NOTE 1: Some DVD-Video discs do not operate as described in this manual due to the intentions of the discs' producers.
- NOTE 2: Playing DVD-R and DVD-RW discs on a DVD recorder can be played. Discs that have not been finalized cannot be played. Depending on the disc's recording status, the disc may not be accepted or may not be played normally (the picture or sound may be not be smooth, etc.).
- NOTE 3: Some of CD-R/CD-RW discs may be incompatible because of "scratch and stain of disc", "Recording condition", and "Characteristic of Recorder".
- NOTE 4: Windows Media and the Windows logo are trademarks or registered trademarks of Microsoft Corporation in the United States and/or other countries.

This player conforms to the NTSC color system. You cannot play discs recorded in other color systems such as PAL.

- Some discs include region codes as shown below.



- The number inside the symbol refers to a region of the world, and a disc encoded in a specific region format can only be played back on DVD players with the same region code.

The following discs cannot be played back on this DVD player.

- DVD with region codes other than 1 or ALL.
 - DVD-ROM
 - DVD-RAM (Never play back, otherwise malfunction may result.)
 - CD-ROM
 - VSD
 - CDV (Only plays back the audio part.)
 - CD-G (Only plays back the sound.)
 - CD-R/CD-RW (Only plays back the discs which Audio CD/MP3/JPEG/WMA is recorded.)
 - CD-I (Never play back, otherwise malfunction may result.)
 - Photo CD (Never play back, otherwise malfunction may result.)
 - Super Audio CD
 - DVD-Audio
- Any other discs without compatibility indications.

Disc Types

[DVD-Video]

Data on a DVD is divided into sections called "titles," and then into subsections called "chapters," each of which is given a title or chapter number. Playback conditions are preset on some DVD-Video discs, and these playback conditions take priority over user operations on this player. If a function you selected does not run as desired, refer to the manual accompanying the disc.

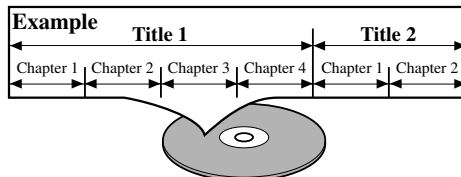

[Audio CD, Video CD]

Data on an Audio CD, or a Video CD is divided into sections called "tracks," each of which is given a track number.

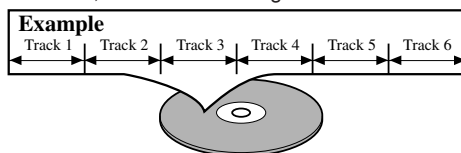

ABOUT THE PBC FUNCTION OF VIDEO CD

This unit conforms to ver.1.1 and ver.2.0 of Video CD standard, with PBC function.

Ver.1.1 (without PBC function): You can enjoy playback picture as well as music CD.

Ver.2.0 (with PBC function): While using a Video CD with PBC function, "PBC" appears on the screen and the display.

What is PBC? "PBC" stands for the Playback Control. You can play interactive software using menu screens. Refer to instructions in the Video CD.

NOTE:

When playing Video CDs with PBC function, some operations (e.g., select and repeat tracks) cannot be performed unless the function is cancelled temporarily (refer to page 15).

[MP3, JPEG, WMA]

Data on a MP3 is divided into sections called "groups," and then into subsections called "tracks," each of which is given an album or track number.

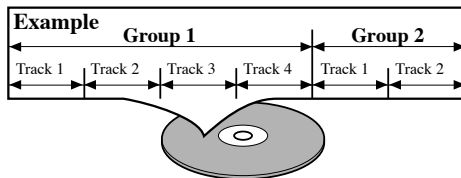

CAUTION:

- Use caution not to pinch your finger in the disc slot.
- Be sure to remove a disc and unplug the AC power cord from the outlet before carrying the DVD player.

- **Dolby Digital Sound**
By hooking this player up to a Multi-Channel Dolby Digital decoder, you can enjoy high-quality 5.1ch Dolby Digital surround sound as heard in the movie theaters.
- **DTS(Digital Theater System)**
When this player is connected to the DTS decoder, you can enjoy 5.1 channel surround system which reproduces the original sound as truly as possible. 5.1 channel surround system is developed by the Digital Theater System, Inc.
- **Progressive Scan system**
Unlike conventional interlace scanning, the progressive scan system provides less flickering and images in higher resolution than that of traditional television signals.
- **Still/fast/slow/step playback**
Various playback modes are available including still pictures, fast forward/reverse, slow motion and step frames.
- **Random playback for Audio CD, MP3, JPEG, and WMA**
This player can shuffle the order of tracks to play them in random order.
- **Program playback for Audio CD, MP3, JPEG, and WMA**
You can program the order of tracks to play them in any desired order.
- **DVD menus in a desired language**
You can display DVD menus in a desired language, if available on a DVD.
- **Auto standby**
When the screen saver program is activated for 35 minutes, the power is automatically turned off.
- **Subtitles in a desired language**
You can select a desired language for the display subtitles, if that language is available on a disc.
- **Selecting a camera angle**
You can select the desired camera angle, if a disc contains sequences recorded from different angles.
- **Choices for audio language and sound mode**
You can select the desired audio language and sound mode, if different languages and modes are available on a disc.
- **Parental lock**
You can set the control level to limit playback of discs which may not be suitable for children.
- **Automatic detection of discs**
This player automatically detects if a loaded disc is DVD-Video, Audio CD, MP3, JPEG, or WMA.
- **Playing an MP3 disc**
You can enjoy MP3 files which are recorded on CD-R/RW.
- **Direct Search**
You can search the desired title, chapter, and track with numeric button during playback or in stop mode.
- **On-screen display**
Information about the current operation can be displayed on a TV screen, allowing you to confirm the currently active functions (such as program playback), on the TV screen using the remote control.
- **FL OFF Mode**
You can turn off the display.
- **Search**
Group search: Search for the group designated by user is possible.
Chapter search: Search for the chapter designated by user is possible.
Title search: Search for the title designated by user is possible.
Track search: Search for the track designated by user is possible.
Time search: Search for the time designated by user is possible.
- **Repeat**
Chapter: Repeated playback of the chapter of the disc being played is possible.
Title: Repeated playback of the title of the disc being played is possible.
Track: Repeated playback of the track of the disc being played is possible.
ALL: Repeated playback is possible. (exclude DVD-Video)
A-B: The part between A and B designated by user is possible.
Group: Repeated playback of the folder of the MP3/JPEG/WMA disc being played is possible.
- **Zoom**
2-time or 4-time magnified screen can be displayed.
- **Marker**
The part designated by user can be called back.
- **Resume Play**
User can resume to playback from the part at which the play was stopped even if the power turn off.
- **Component Video Out Jacks**
Jacks located on the back of the DVD Player which are used to send high-quality video to a TV via Component Video In Jacks.
- **Bit rate indication**
- **DRC (Dynamic range control)**
You can control the range of sound volume.
- **Displaying a JPEG picture**
Kodak Picture CDs can be played. Still images stored in JPEG format on CD-R/RW can also be played.
- **Reproducing WMA data**
You can enjoy WMA files which are recorded on CD-R/RW.

“Kodak Picture CD COMPATIBLE” is trademark of Eastman Kodak Company.

“WMA” (Windows Media Audio) is a new audio codec developed by Microsoft® in the United States of America.

FRONT PANEL

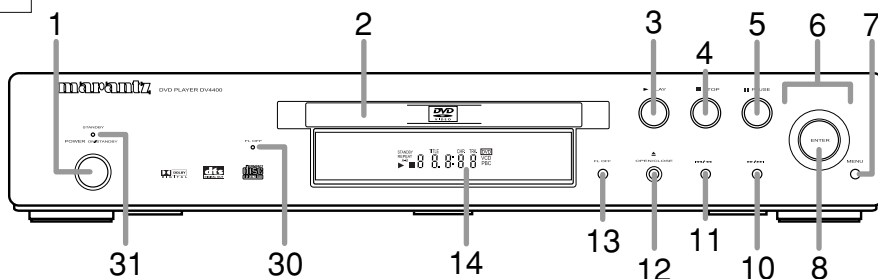

REMOTE CONTROL

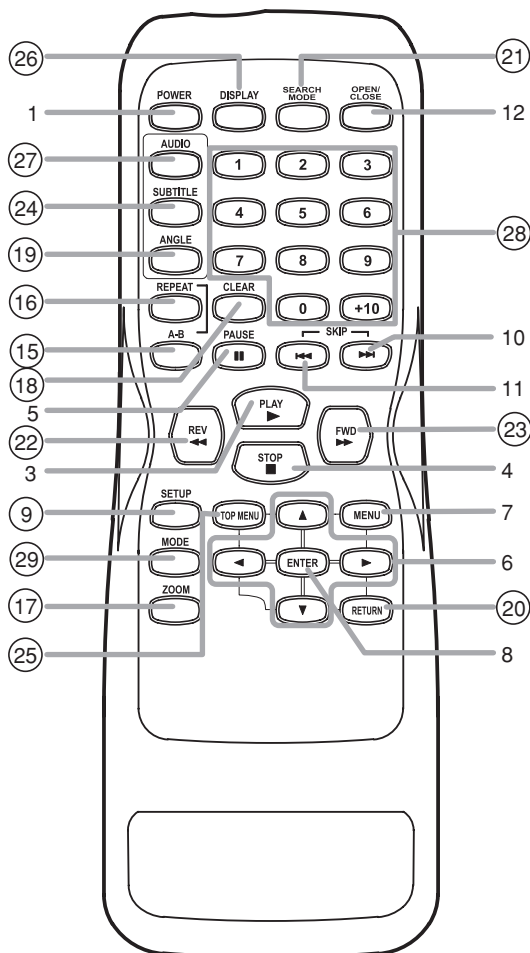













The buttons with circled numbers can only be operated with the remote control.





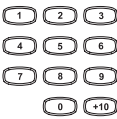



1. **POWER Button** [page 15]
2. **Disc loading tray**
3. **PLAY Button** [page 15]
4. **STOP Button** [page 15]
5. **PAUSE Button** [page 15]
6. **Cursor Buttons** [page 15]
Use when making settings while watching the display on a TV screen.
7. **MENU Button** [page 15]
8. **ENTER Button** [page 15]
9. **SETUP Button** [page 23]
10. **▶▶(SKIP UP/FWD) Button** [page 17]
Plays back from the beginning of the next chapter or track. Hold down to fast forward playback.
11. **◀◀(SKIP DOWN/REV) Button** [page 17]
Plays back from the beginning of the current chapter or track. Hold down to fast reverse playback.
12. **OPEN/CLOSE Button** [page 15]
13. **FL OFF Button** [page 15]
14. **Display, Remote Sensor Window**
15. **A-B REPEAT Button** [page 17]
16. **REPEAT Button** [page 17]
17. **ZOOM Button** [page 16]
18. **CLEAR Button** [page 17]
19. **ANGLE Button** [page 21]
Press to change the camera angle to see the sequence being played back from a different angle.
20. **RETURN Button** [page 15]
21. **SEARCH MODE Button** [page 17]
22. **◀◀(FR SEARCH) Button** [page 16]
23. **▶▶(FF SEARCH) Button** [page 16]
24. **SUBTITLE Button** [page 21]
Press to select a desired subtitle language.
25. **TOP MENU Button** [page 15]
26. **DISPLAY Button** [page 20]
27. **AUDIO Button** [page 21]
Press to select a desired audio language or sound mode.
28. **Numeric Buttons** [page 17]
29. **MODE Button** [page 18]
30. **FL OFF Indicator**
This indicator lights when the FL OFF button is ON.
31. **STANDBY Indicator**
This indicator lights when the DVD player turns off.

Tour of the remote control

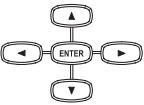
Buttons on remote control work in different ways for DVD, VCD, and CD :
Refer to the following table for correct use.

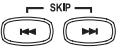
	DVD	VCD	CD
POWER 	<ul style="list-style-type: none"> Press this to switch the power between on and standby. 	<ul style="list-style-type: none"> Press this to switch the power between on and standby. 	<ul style="list-style-type: none"> Press this to switch the power between on and standby.
A-B REPEAT Button 	<ul style="list-style-type: none"> Marks a segment to repeat between A and B. 	<ul style="list-style-type: none"> Marks a segment to repeat between A and B. 	<ul style="list-style-type: none"> Marks a segment to repeat between A and B.
REPEAT Button 	<ul style="list-style-type: none"> Allows you to repeat play a Title, or Chapter. 	<ul style="list-style-type: none"> Allows you to repeat play a Track or Disc. 	<ul style="list-style-type: none"> Allows you to repeat play a Track or Disc.
MODE Button 	<ul style="list-style-type: none"> To set black level on/off. To activate the 3D sound (Virtual surround system). 	<ul style="list-style-type: none"> To set black level on/off. To activate the 3D sound (virtual surround system). 	<ul style="list-style-type: none"> Allows you to program a specific order or random playback. To activate the 3D sound (virtual surround system).
ZOOM Button 	<ul style="list-style-type: none"> To magnify part of picture (x2/x4). 	<ul style="list-style-type: none"> To magnify part of picture (x2). 	—
ANGLE Button 	<ul style="list-style-type: none"> Accesses various camera angles on a disc. 	—	—
SUBTITLE Button 	<ul style="list-style-type: none"> Accesses various subtitles on a disc. 	—	—
AUDIO Button 	<ul style="list-style-type: none"> Accesses various audio functions on a disc. 	<ul style="list-style-type: none"> To select STEREO, L-CH or R-CH. 	<ul style="list-style-type: none"> To select STEREO, L-CH or R-CH.
DISPLAY Button 	<ul style="list-style-type: none"> Displays the current disc mode. 	<ul style="list-style-type: none"> Displays the current disc mode. 	<ul style="list-style-type: none"> Displays the current disc mode.
SEARCH MODE Button 	<ul style="list-style-type: none"> To search chapter, title, or time. To rapidly return to a location of disc. 	<ul style="list-style-type: none"> To search track or time. To rapidly return to a location of disc. 	<ul style="list-style-type: none"> To search track or time. To rapidly return to a location of disc.
OPEN/CLOSE Button 	<ul style="list-style-type: none"> To open or close the disc tray. 	<ul style="list-style-type: none"> To open or close the disc tray. 	<ul style="list-style-type: none"> To open or close the disc tray.
NUMERIC Buttons 	<ul style="list-style-type: none"> To select chapter directly. 	<ul style="list-style-type: none"> To select track directly. 	<ul style="list-style-type: none"> To select track directly.
CLEAR Button 	<ul style="list-style-type: none"> Clear the markers. 	<ul style="list-style-type: none"> Clear the markers. 	<ul style="list-style-type: none"> Clear the markers. Removes status No. in program input.

Tour of the remote control

	DVD	VCD	CD
MENU Button 	<ul style="list-style-type: none"> • Brings up the Menu on a disc. 	—	—
TOP MENU Button 	<ul style="list-style-type: none"> • Brings up the Top Menu on a disc. 	—	—
ENTER, CURSOR Buttons 	<ul style="list-style-type: none"> • Moves the cursor and determines its position. 	<ul style="list-style-type: none"> • Moves the cursor and determines its position. 	<ul style="list-style-type: none"> • Moves the cursor and determines its position.
RETURN Button 	<ul style="list-style-type: none"> • Returns to a previous menu. 	<ul style="list-style-type: none"> • Returns to a previous menu. 	—
SETUP Button 	<ul style="list-style-type: none"> • Brings up the DVD player's Setup menu. 	<ul style="list-style-type: none"> • Brings up the DVD player's Setup menu. 	<ul style="list-style-type: none"> • Brings up the DVD player's Setup menu.
SKIP Buttons 	<ul style="list-style-type: none"> • To skip Chapters 	<ul style="list-style-type: none"> • To skip Tracks. 	<ul style="list-style-type: none"> • To skip Tracks.
SEARCH Buttons 	<ul style="list-style-type: none"> • Allows you to search forward/backward through a disc (x2. x8. x50. x100). 	<ul style="list-style-type: none"> • Allows you to search forward/backward through a disc (x2. x8. x30). 	<ul style="list-style-type: none"> • Allows you to search forward/backward through a disc (x16).
STOP Button 	<ul style="list-style-type: none"> • To stop playback. 	<ul style="list-style-type: none"> • To stop playback. 	<ul style="list-style-type: none"> • To stop playback.
PLAY Button 	<ul style="list-style-type: none"> • Begin disc play. 	<ul style="list-style-type: none"> • Begin disc play. 	<ul style="list-style-type: none"> • Begin disc play.
PAUSE Button 	<ul style="list-style-type: none"> • Pause disc play. • Advances playback one frame at a time. 	<ul style="list-style-type: none"> • Pause disc play. • Advances playback one frame at a time. 	<ul style="list-style-type: none"> • Pause disc play.

Display

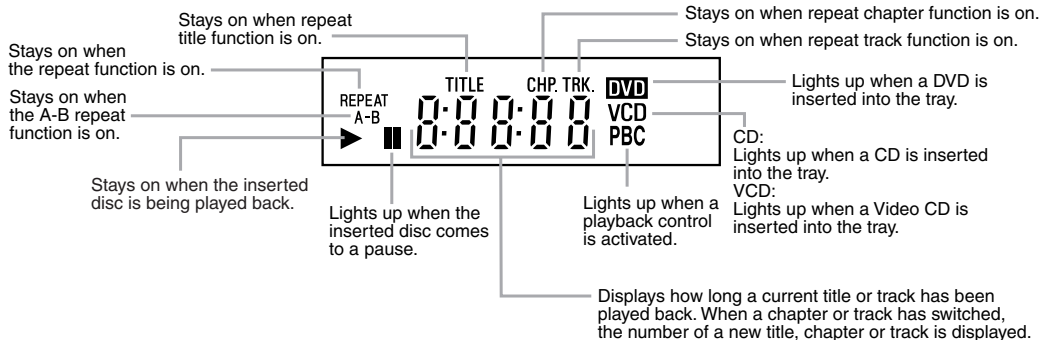

Displays During Operation

	Power on
	No disc inserted
	Tray open
	Tray closed
	Loading the Disc
	Power off

Loading the Batteries

1. Open the battery compartment cover.

2. Insert two "AA" (R6P) batteries, with each one oriented correctly.

3. Close the cover.

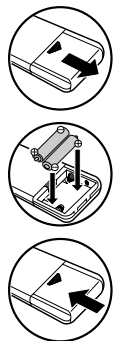

NOTES

- Do not mix alkaline and manganese batteries.
- Do not mix old and new batteries.

Using the remote control

Keep in mind the following when using the remote control:

- Make sure that there is no obstacle between the remote and the remote sensor on the unit.
- Use within the operating range and angle, as shown.

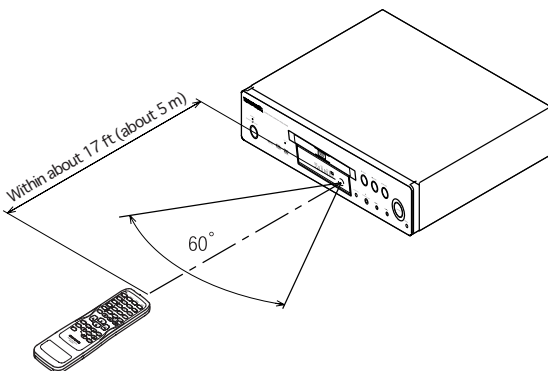

Cautions On Batteries

- Use "AA" (R6P) batteries in this remote control unit.
- Replace the batteries with new ones approximately once a year, though this depends on the frequency with which the remote control unit is used.
- If the remote control unit does not operate from close to the main unit, replace the batteries with new ones, even if less than a year has passed.
- The included battery is only for verifying operation. Replace it with a new battery as soon as possible.
- When inserting the batteries, be careful to do so in the proper direction, following the ⊕ and ⊖ marks in the remote control unit's battery compartment.
- To prevent damage or battery fluid leakage:
 - Do not use a new battery with an old one.
 - Do not use two different types of batteries.
 - Do not short-circuit, disassemble, heat or dispose of batteries in flames.
- Remove the batteries when not planning to use the remote control unit for a long period of time.
- If the batteries should leak, carefully wipe off the fluid from the inside of the battery compartment, then insert new batteries.

Description - rear panel

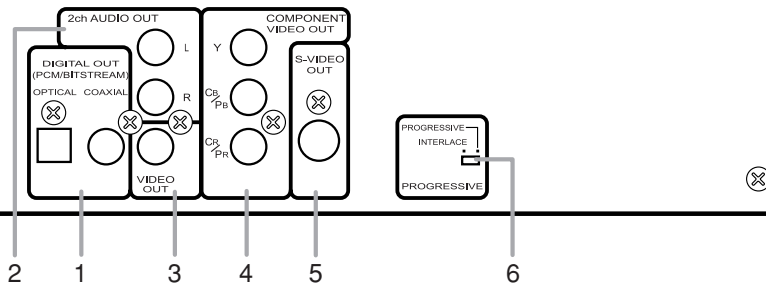
**1. DIGITAL OUT JACKS**

Use either an optical or coaxial digital cable to connect to an AV amplifier with a built-in decoder (AV control center).

2. 2ch AUDIO OUT JACKS

Connect to the Audio input jacks of A/V-compatible TV or wide screen TV, Stereo system.

3. VIDEO OUT JACK

Use a video cable to connect one of the jack to Video input on your A/V-compatible TV or wide screen TV, Stereo system.

4. COMPONENT VIDEO OUT JACKS

Use these jacks if you have a TV with Component Video in jacks. These jacks provide C_b/P_b, C_r/P_r and Y video. Along with S-Video, Component Video provides the best picture quality.

5. S-VIDEO OUT JACK

Use the S-Video cable to connect this jack to the S-Video jack on your A/V-compatible TV or wide screen TV for a higher quality picture.

6. PROGRESSIVE switch**Selecting Progressive Scan (480p or Interlaced 480i) Playback**

- If your TV is compatible with progressive scanning (480p), connect the TV to the Component Video Output jacks of the DVD player and set the Progressive switch on the back of the DVD player to "PROGRESSIVE". Next, set your TV to the progressive scan mode.

If your TV is not compatible with progressive scan, keep the Progressive switch to "INTERLACE".

- Use a commercially available adaptor if the video input jacks of your TVs or monitors are the BNC type.

What is Progressive Scanning?

- Unlike conventional interlace scanning, the progressive scan system provides less flickering and images in higher resolution than that of traditional (480i) television signals.

NOTE

- When the Progressive switch is set to "PROGRESSIVE", no video signal will be output from the VIDEO OUT or S-VIDEO OUT jack.

Manufactured under license from Dolby Laboratories. "Dolby" and the double-D symbol are trademarks of Dolby Laboratories.

"DTS" and "DTS Digital Out" are trademarks of Digital Theater Systems, Inc.

The following show examples of connections commonly used to connect the DVD player either TV and other components.

If using this DVD player to playback a DVD in a 5.1 channel Dolby Digital surround or DTS surround format, the DVD player outputs a Dolby Digital or DTS data stream from its OPTICAL or COAXIAL DIGITAL AUDIO OUT jacks. By hooking the player up to a Dolby Digital or DTS decoder, you can enjoy a more convincing, realistic ambience with powerful and high-quality surround sound of a professional standard, which can be heard in movie theaters. Use an audio coaxial or optical digital cable (not included) for the audio connections. Use audio cables (commercially available) for the 5.1 CH audio connection.

Notes

- Be sure to turn off the power to all components in the system before connecting another component.
- Refer to the Instruction Manuals for your TV, stereo system and any other components to be connected to the DVD player.

Connection to an audio system

Method 1

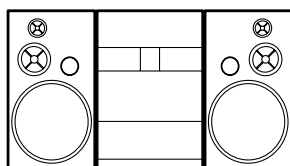

Stereo system

Method 2



Dolby Digital decoder or DTS decoder

AUDIO

Audio Input Jacks

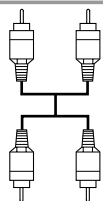
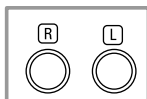

Digital Audio Input Jacks

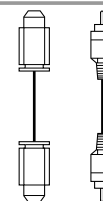
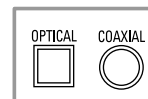

DVD

Analog Audio Out

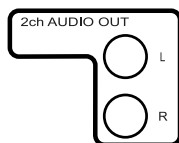

Digital Audio Out

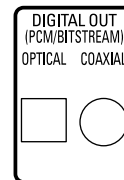

- **Method 1** DVD Player + Stereo system
- **Method 2** DVD Player + Dolby Digital decoder or DTS decoder

NOTES

- If output Dolby Digital audio, connect to a Dolby Digital decoder, and set Dolby Digital to ON for audio output in the setup mode. (See page 24)
- If output DTS audio, connect to a DTS decoder, and set DTS to "ON" for audio output in the setup mode. (See page 24)
- Unless connected to a Dolby Digital decoder or a DTS decoder, set Dolby Digital or DTS to "OFF" for audio output in the setup mode. Playing a DVD using incorrect settings may generate noise distortion, and may also damage the speakers. (See page 24)
- The audio source on a disc in a 5.1 channel Dolby Digital surround format cannot be recorded as digital sound by an MD or DAT deck.
- Set Dolby Digital and DTS to "OFF" for audio output in the setup mode for method 1 only. Playing a DVD using incorrect settings may generate noise distortion, and may also damage the speakers. (Refer to page 24 to set "ON" Dolby Digital and DTS)

Optical cable (not supplied)

- Optical cable (not supplied) may be damaged when bent at sharp angles. Ensure cables are coiled in loops with a diameter of 15 cm or more when storing them.
- Use a cable which is 3m or shorter.
- Insert cable plugs firmly into the connectors when making connections.
- If a plug has minor scratches or is dirty, clean it with a soft cloth before inserting it into a connector.

Connection to a TV (for video)

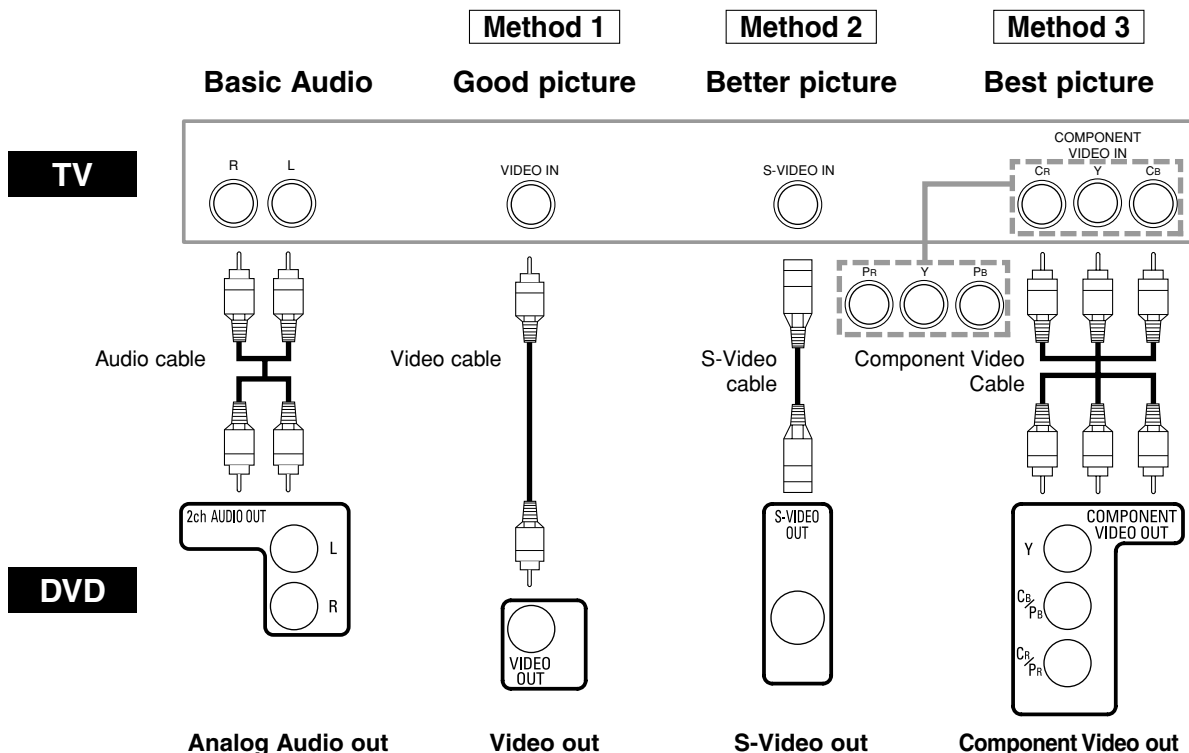

- **Method 1** DVD Player + TV with Video Input Jack
- **Method 2** DVD Player + TV with S-Video Input Jack
- **Method 3** DVD Player + TV with Component Video Jacks

NOTES

- If your TV is compatible with progressive scanning (480p), connect the TV to the Component Video Output jacks of the DVD player. Refer to page 12.
- Connect the DVD player directly to a TV. If the A/V cables are connected to a VCR, pictures may be distorted due to the copy protection system.
- S-Video output connector
The video signals are divided into color (C) and brightness (Y) signals, achieving a clearer picture.
If the TV is equipped with a S-Video input connector, we recommend connecting it to the this product's S-Video output connector using a commercially available S-Video connection cord.

HOW TO CONNECT TO A TV WITHOUT AUDIO/VIDEO INPUT JACKS

If your TV does not have RCA type audio and video input jacks it is still possible to connect this DVD player to your TV's 75-ohm coaxial antenna terminal using an optional Stereo Audio/Video RF Modulator, not included. Connect the audio and video outputs of the DVD player to the audio and video inputs on the RF Modulator, and then connect the coaxial output of the RF Modulator (usually marked "TO TV") to the 75 ohm coaxial antenna terminal on your TV. Follow the instruction supplied with the RF Modulator for more details.

If your TV's 75 ohm coaxial antenna terminal is already occupied by an antenna or cable box connection, remove that cable from your TV's antenna terminal and reconnect it to the coaxial antenna input terminal of the RF Modulator (usually marked "ANT IN"), then connect the RF modulator to your TV's antenna terminal as described above.

NOTE

- The picture quality from DVD discs will not be as good if the DVD player is connected to the TV's antenna terminal through an RF Modulator.

Basic Playback

DVD-V VCD CD

Getting started

- Turn on the power of the TV, amplifier and any other components which are connected to the DVD.
- Make sure the TV and audio receiver (commercially available) are set to the correct channel.

- 1 Press the **POWER** button.
 - "P-ON" will appear briefly on the display panel.
- 2 Press the **OPEN/CLOSE** button to open disc loading tray.
- 3 Place the disc in the tray, with the label facing up.

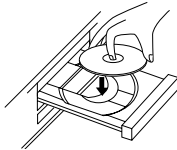

- 4 Press the **PLAY** button.
 - The tray will close automatically, and playback will then start from the first chapter or track of the disc. If the playback does not start automatically, press the **PLAY** button.
 - When you playback the DVD with a title menu, it may appear on the screen. In this case, refer to "TITLE MENU".

- 5 Press the **STOP** button to stop playback.

NOTES:

- A "prohibited icon" may appear at the top-right on the TV screen during operation, warning that a prohibited operation has been encountered by the DVD player or the disc.
- With DVDs that use some titles for playback program signals, playback may start from the second title, or it may skip these titles.
- During the playback of two layered disc, pictures may stop for a moment. This happens when the 1st layer switches to the 2nd layer. This is not a malfunction.
- The operation may vary when you playback DVDs with disc menu or Video CDs with PBC. Refer to the manual accompanying the disc for details.



CANCELLING AND CALLING BACK PBC FUNCTION

VCD

- 1 Insert a Video CD.
- 2 Press the **STOP** button.
- 3 Press the **numeric buttons** to enter the desired Track number.
 - PBC function is now cancelled and the playback of the Video CD will start.
- 4 To call back PBC function, press the **STOP** button twice, and then press the **PLAY** button.
 - Title menu will appear on the display.

General Features

DVD may contain menus to navigate the disc and access special features. Press the appropriate numerical key or use the **cursor buttons** (▼/▲/▶/◀) to highlight your selection in the DVD main menu and press the **ENTER** button to confirm.

NOTE:

- Unless stated, all operations described are based on remote control use. Some operations can be carried out using the menu bar on the TV screen.

FL OFF Mode

- 1 Press the **FL OFF** button on the front panel to turn off the display.
 - The FL OFF indicator will light up.

NOTES:

- In SETUP menu, the FL OFF mode is not available.
- The FL OFF mode will be released when you press the buttons listed below.
 - OPEN/CLOSE** button (on both the remote and the front panel), **SETUP**, **POWER** or **DISPLAY** button (on the remote), **ON/STANDBY** or **FL OFF** button (on the front panel).
- To call back the setting in SETUP menu, turn off (STANDBY) the DVD player first and turn it on again.

Pause

DVD-V VCD CD MP3 WMA

- 1 During playback, press the **PAUSE** button.
 - Playback will pause and sound will be muted.
- 2 To continue playback, press the **PLAY** button.



Disc Menus

DVD-V

- 1 Press the **MENU** button.
 - The DVD main menu will appear.
- 2 If the feature is not available,  symbol may appear on the TV screen.
- 3 If disc menu is available on the disc, audio language, subtitle options, chapters for the title and other options will appear for selection.
- 4 Press the **cursor buttons** (▼/▲/▶/◀) to select an item, and the **ENTER** button to confirm selection.

Title Menu

DVD-V

- 1 Press the **TOP MENU** button.
 - The title menu will appear.
- 2 If the feature is not available,  symbol may appear on the TV screen.
- 3 Press the **cursor buttons** (▼/▲/▶/◀) to select an item, and the **ENTER** button to confirm selection.
 - Playback will begin at the selected Title.

VCD

- 1 When playing a Video CD with PBC function, the title menu will appear automatically.
- 2 Press the **numeric buttons** to select the desired title.
 - Playback will begin at the selected title.
- 3 Press the **RETURN** button to go back to the title menu.

CALLING UP A MENU SCREEN DURING PLAYBACK

DVD-V

- Press the **MENU** button to call up the DVD main menu.
- Press the **TOP MENU** button to call up the title menu.

NOTE:

- Contents of menus and corresponding menu operations may vary between discs. Refer to the manual accompanying the disc for details.

Step by Step Playback

DVD-V VCD

- 1 During playback, press the **PAUSE** button.
 - Playback will pause and sound will be muted.



- 2 The disc advances by one frame each time the **PAUSE** button is pressed.
- 3 To exit step by step playback, press the **PLAY** button.

Resume

DVD-V CD VCD

- 1 During playback, press the **STOP** button.
 - Resume message will appear on the TV screen.

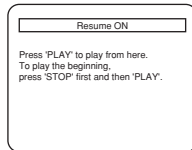

- 2 Press the **PLAY** button, playback will resume from the point at which playback was stopped.
 - To cancel resume, press the **STOP** button twice.

NOTES:

- The resume playback takes a little longer to take place compared to the normal playback.
- Some Video CDs with PBC function resume playback from the beginning of the track.
- The resume information stays on even when the power is switched off.

Fast Forward / Reverse Search

DVD-V VCD CD MP3 WMA

- 1 During playback, press the **FF** or **REW** button repeatedly to select the required forward or reverse speed: x2, x8, x50, x100.
 - If you are using **FF** or **REW** button on the front panel, press and hold it for more than 1.5 sec (the longer you hold it, the faster the speed will be). When you reach the desired speed, release the button.

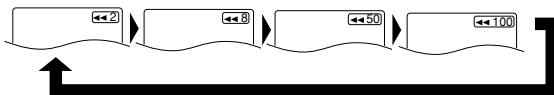

- For Video CDs, the playback speed is x2, x8 or x30.
 - For Audio CDs, the speed is fixed at x16.
 - For MP3 and WMA the speed is fixed at x8.
- 2 To return to normal playback, press the **PLAY** button.

Slow Forward / Slow Reverse

DVD-V VCD

- 1 During playback, press the **PAUSE** button.
- 2 Press the **SLF** or **SLR** button.
 - Slow motion playback will begin and sound will be muted.
- 3 Press the **SLF** or **SLR** button repeatedly to select the required speed: 1/16, 1/8, 1/2 of the normal playback.
 - If you are using **SLF** or **SLR** button on the front panel, press and hold it for more than 1.5 sec (the longer you hold it, the faster the speed will be). When you reach the desired speed, release the button.

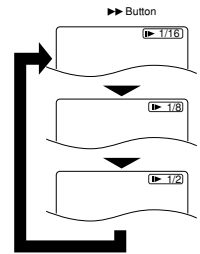

- 4 To return to normal playback, press the **PLAY** button.

NOTE:

- Only Slow Forward is available when playing Video CD. Forward speed can be selected from 1/16, 1/8, or 1/2.

Zoom

DVD-V VCD

The Zoom function allows you to enlarge the video image and to pan through the enlarged image.

- 1 Press the **ZOOM** button during playback.
 - Playback will continue.
- 2 Press the **ZOOM** button repeatedly to select the required zoom factor: x2, x4 or OFF.
 - Only x2 zoom is available on Video CDs.



- 3 Use the **cursor buttons** (**DOWN** / **UP** / **RIGHT** / **LEFT**) to move the zoomed picture across the screen.

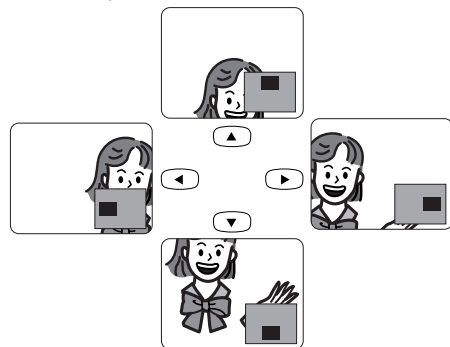

- 4 To exit zoom mode, press the **ZOOM** button to OFF.

NOTES:

- Zooming function does not work while disc menu is shown.
- x4 zoom is not available on some discs.

Track

CD VCD MP3 WMA

There are three ways to begin playback on an Audio CD, Video CD, MP3 or WMA disc at a specific Track.

By using the Numeric buttons

- Press the **numeric buttons** to enter the desired Track number.
 - Playback will start at the selected track.
 - For single digit tracks (1-9), press a single number (eg. track 3, press 3).
 - To play track 26, press +10, 2, 6 on the numerical button.

By using the SEARCH MODE button (Audio CD/Video CD)

- Press the **SEARCH MODE** button.
 - The track search display appears.

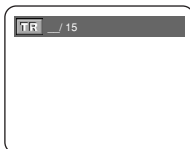

- Within 30 seconds, select a desired track number using the **numeric buttons**. For single digits press "0" first.
 - Playback will start at the selected track.

By using the SKIP buttons ◀◀▶▶

During playback, press the **SKIP ▶▶** button to move to the next track. Press it repeatedly to skip subsequent tracks. Press the **SKIP ◀◀** button to go back to the beginning of the current track. Press it repeatedly to go to the previous tracks.

- Track number will appear briefly on the DVD display panel.
- If any **SKIP** button is pressed while the playback is paused, the playback will be paused again after skipping to the next track.

NOTE:

- The **SKIP ◀◀ ▶▶** buttons are not available when playback is stopped.

Title / Chapter Search

DVD-V

By using the SEARCH MODE buttons

- Press the **SEARCH MODE** button once for the Chapter search, twice for the Title search during playback.

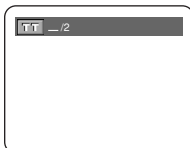

- Enter the desired chapter/title number with the **numeric buttons**.

By using the SKIP buttons ◀◀▶▶

During playback, press the **SKIP ▶▶** button to move to the next chapter. Press it repeatedly to skip subsequent chapters. Press the **SKIP ◀◀** button to go back to the beginning of the current chapter. Press it repeatedly to go to the previous chapter.

Time Search

DVD-V CD VCD

- During playback, press the **SEARCH MODE** button three times (CD, VCD: twice) to display the Time Search on the TV screen.
- Within 30 seconds, enter a desired disc time with the **numeric buttons**.
 - Playback will start at the specified time.
- Press the **CLEAR** button to erase the incorrect input.



Repeat

The **REPEAT** button is available only during playback.

REPEAT TITLE / CHAPTER

DVD-V

To activate the repeat function, press the **REPEAT** button during playback.

- The repeat mode changes as described below every time you press the button.

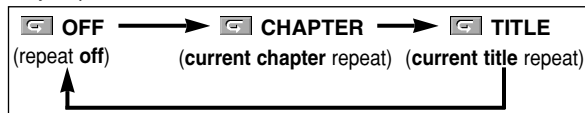

NOTES:

- Repeat Title/Chapter is not available with some scenes.
- The REPEAT setting will be cleared when moving to other title or chapter.

REPEAT TRACK

CD VCD

To activate the repeat function, press the **REPEAT** button during playback.

- The repeat mode changes as described below every time you press the button.



NOTES:

- The REPEAT setting will be cleared when moving to other track.
- Repeat playback does not function during A-B repeat playback.
- Repeat playback is not available when playing the Video CD with PBC function.

MP3 JPEG WMA

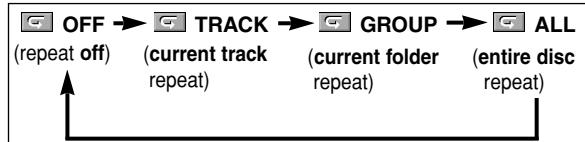

A-B REPEAT

DVD-V **CD** **VCD**

1 Press the **A-B REPEAT** button at your chosen starting point.

- **A-** appears briefly on the TV screen.

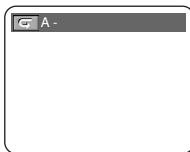

2 Press the **A-B REPEAT** button again at your chosen end point.

- **A-B** appears briefly on the TV screen, and the repeat sequence begins.

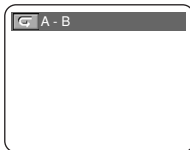

3 To exit the sequence, press the **A-B REPEAT** button.



NOTES:

- The A-B repeat section can only be set within the current title (for DVDs), or current track (for Audio CDs).
- A-B Repeat is not available with some scenes in DVD.
- To cancel the A point which was set, press the **CLEAR** button.
- A-B Repeat playback does not function during title, chapter, track or all repeat playback.

Program

CD

You may determine the order in which tracks will play.

1 In stop mode, press the **MODE** button.

- The PROGRAM screen will appear.

2 Press the **cursor buttons** (▲ or ▼) to select a track, then press the **ENTER** button.

- Press the **CLEAR** button to erase the most recently entered program.

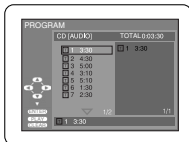

3 Press the **PLAY** button to play the programmed tracks.

NOTES:

- While the program is being played back, the **STOP** button works as follows.
- Press the **STOP** button once and then the **PLAY** button again, playback will restart from the point where the **STOP** button was pressed. (Program continued)
- Press the **STOP** button twice and then the **PLAY** button again, playback will restart from the track in the usual way. (Program cleared)
- Up to 99 programs can be entered.
- If you wish to repeat the current track in the program, press the **REPEAT** button repeatedly until **TRACK** appears during playback. If you wish to repeat the entire program press the **REPEAT** button repeatedly until **ALL** appears during playback.
- Refer to page 20 for program playback of MP3, WMA, and JPEG.

Random Playback

CD

This shuffles the playing order of tracks instead of playback in the original sequence.

1 In stop mode, press the **MODE** button twice.

- **RANDOM** screen appears.

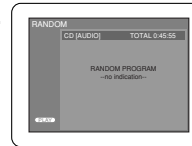

2 Press the **PLAY** button to start random playback.

NOTES:

- If you wish to repeat the current track in the random selection, press the **REPEAT** button repeatedly until **TRACK** appears during playback. If you wish to repeat the entire random selection press the **REPEAT** button repeatedly until **ALL** appears during playback.
- Refer to page 20 for random playback of MP3, WMA, and JPEG.

MP3 / JPEG / WMA Playback

MP3 **JPEG** **WMA**

This DVD player can reproduce images and sounds from data recorded in MP3, JPEG and WMA formats on CD-R and CD-RW discs.

The DVD player can also run JPEG files stored on Kodak picture CD.

The user can enjoy picture images on the television set by reproducing picture CDs.

* Picture CD is a service to convert a photograph taken by conventional film camera into digital data and write the data on a CD.

For details of Picture CD, contact a shop that deals with developing service of Kodak Inc.

Information on MP3, JPEG and WMA discs

- A file with an extension of “.mp3 (MP3)” is called an “MP3 file”.
- A file with an extension of “.jpg (JPG)” or “.jpeg (JPEG)” is called a “JPEG file”.
The DVD player can run an image file conforming to the Exif* specification.
- * This is a file format, Exchangeable Image File format established by Japanese Electronic Industry Development Association (JEIDA).
- A file with an extension of “.wma (WMA)” is called a “WMA file”.
- Files whose extension is other than “.mp3 (MP3)”, “.jpg (JPG)”, “.jpeg (JPEG)” and “.wma (WMA)” will not be listed in the MP3, JPEG, or WMA menu.
- If the file is not recorded in MP3, JPEG or WMA format, noise may be produced even if the file extension is either of “.mp3 (MP3)”, “.jpg (JPG)”, “.jpeg (JPEG)” and “.wma (WMA)”.

PLAYING A DISC

When a disc with MP3, JPEG or WMA files is inserted in the DVD player, the track menu will appear on the TV screen, and number of tracks is displayed on the front panel.

1 Place the disc in the tray with the label facing up.

For discs on which MP3, JPEG or WMA tracks are recorded:

- An MP3, JPEG or WMA track menu screen appears.
- A symbol of "M" is shown on the top of the group name.
- A symbol of "J" is shown on the top of MP3 files.
- A symbol of "C" is shown on the top of JPEG files.
- A symbol of "W" is shown on the top of WMA files.
- If the picture extends beyond the scope of screen, a down arrow "▼" appears, indicating that the user can view another part of the picture on the next page. If an up arrow "▲" appears, it indicates that the user can view another part on the previous page. The current page number and the number of total pages are shown on the right of the down arrow "▼".
- The system can recognize up to 255 groups (or folders) and up to 256 tracks. (This applies to the case where mixed MP3, JPEG and WMA files are recorded.)
- If no MP3, JPEG or WMA files are found in the group, the group is not displayed.
- The DVD player can reproduce data recorded as per ISO 9660 Level 1, Level 2 or Joliet on the disc.
- It can also run a disk on which data is recorded in a multi-session.
- For more details of recording systems, see the instruction manual for the CD-R / CD-RW drive or the writing software.

Applicable MP3 file		Remarks
Sampling frequency	44.1kHz 48kHz	• It is prohibited to record MP3 sound on a digital device when connection is made digitally.
Type	MPEG1 audio layer 3	• MP3 files recorded at fixed bit rate of 112 kbps or higher are recommended.

Applicable JPEG file		Remarks
Size of image	Upper limit: 6300x5100 dots Lower limit: 32x32 dots	• A JPEG image that extends beyond the screen is reduced so that it will be displayed within the screen.

Applicable WMA file		Remarks
Sampling frequency	44.1kHz 48kHz	• Those frequencies are applicable to WMA version 8 only, not to WMA version 9.
Bit rate	48–192kbps	• Ensure that the copyright function is set to off when preparing a WMA disc.
Type	WMA version 8	• A prohibition "disable" symbol will appear if the user attempts to run a non-reproducible file such as copyright-protected.

For discs of JPEG or Kodak picture CD:

- A JPEG or Kodak Picture CD menu appears.
- If all menu items cannot be displayed in the screen scope, a prompt symbol "▶▶" appears at the right bottom of the screen, indicating that the user can view remaining items on the next page. If another prompt symbol "◀◀" appears, it indicates that the user can view other items on the previous page. The track number of the currently highlighted item and the total tracks are shown at the center bottom of the screen.
- If a prompt symbol "▶▶" is shown at the right bottom, use the **SKIP ▶▶** button to view the next page. If another prompt symbol "◀◀" is shown at the left bottom, use the **SKIP ◀◀** button to view the previous page.
- It may take some time until all menu items are displayed on the menu screen.

1 For JPEG, press the **cursor buttons** (▲/▼), or for Kodak Picture CD, press the **cursor buttons** (◀/▶/▲/▼), select a desired group or track to be played, then press the **PLAY** or **ENTER** button.

- If an MP3 or WMA file is selected, reproduction will start from the selected track and go to the next one in turn.

- If a JPEG or Kodak picture CD file is selected, an image will be reproduced from the selected track and go to the next one in turn.

A track is displayed for five seconds and then the next track is displayed.

Every press on the **cursor button** ▶ will turn the image clockwise by 90 degrees when an image is displayed.

A press on the **cursor button** ◀ will turn the image counterclockwise by 90 degrees.

- If a group is selected, press the **cursor button** ▲/▼ to select a desired group, then press the ▶, **PLAY** or **ENTER** button to select a track. If you press the **PLAY** or **ENTER** button, reproduction of the picture will start.

Notes on MP3, JPEG and WMA:

- Select "FIRST PLAY" and press the **PLAY** button, playback from the top of the disc in the order of tracks and groups.
- The ninth and deeper hierarchies cannot be played.
- The name of group and track can be displayed in up to 25 characters. Unrecognizable characters will be replaced with asterisks.
- Un-reproducible groups or tracks may be displayed depending on the recording conditions.
- If the **TOP MENU** button is pressed when a file list is displayed, "FIRST PLAY" will be highlighted.

2 Press the **STOP** button, to stop playback.

Notes on Kodak picture CD:

- A press on the **STOP** button will highlight the previously displayed track on the menu screen. Press the **STOP** button again or press the **TOP MENU** button, and the menu screen displays Tracks 1 to 6, where Track 1 is highlighted.

Slide Show Mode

JPEG

You can switch to the slide show mode during playback.

- 1 Press the **MODE** button during playback.
 - The slide show mode screen will appear.
 - The slide show mode cannot be switched when it is stopped, or from the file list screen or the Picture CD menu screen.
- 2 Press the **ENTER** button.
 - The slide show mode will change.
 - 1 The entire image appears in one time.
 - 2 The image appears gradually and then disappears.
- 3 Press the **MODE** button to exit.

On-Screen Information

MP3

JPEG

WMA

You can check each file during playback.

- 1 Press the **DISPLAY** button.
 - The name of the file currently in play will be displayed.
- <Example: MP3>
- 2 Press the **DISPLAY** button again to show the track number, the elapsed time, the repeat status, and the playback status at the top of the screen.
 - \hookleftarrow will be displayed when the repeat play has been selected.
 - \hookleftarrow T- indicates Track repeat
 - \hookleftarrow G - indicates Group (folder) repeat
 - \hookleftarrow A - indicates Disc repeat
 - 3 Press the **DISPLAY** button again to exit.
 - During program or random playback, each playback status will be displayed when you press the **DISPLAY** button. Then press the **DISPLAY** button again to exit.

Track Selection

MP3

JPEG

WMA

- 1 Press the **SEARCH MODE** button during playback.
 - The FILE LIST will appear.
- 2 Select a desired track using the **cursor buttons** (\blacktriangledown / \blacktriangle / \blacktriangleright / \blacktriangleleft).
 - Press the \blacktriangleright button when you want to go to the next hierarchy.
 - Press the \blacktriangleleft button when you want to go back to the previous hierarchy.
- 3 Press the **PLAY** button to start playing

NOTES:

- Press the **SEARCH MODE** button to exit.
- Some selections may require additional time to be recognized.
- During play, a desired track can be directly searched. Just type in the TRACK number with the numeric buttons.
- If the typed TRACK number is not available, the "disable" symbol appears and the direct search mode is cancelled.
- Playback cannot be started from a desired time count.
- Pressing the **SKIP** button $\blacktriangleright\blacktriangleright$ or $\blacktriangleleft\blacktriangleleft$ will play the next or previous file.
- The **SEARCH** button is not effective for Picture CD.

Random Playback

MP3

JPEG

WMA

- 1 Press the **MODE** button twice while playback is stopped.

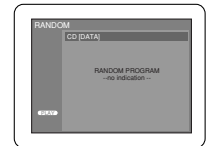

- 2 Press the **PLAY** button to play the tracks in random order.
 - Random play starts.
 - For a disc containing mixed MP3, JPEG and WMA files, random play of those files will be performed.

Program

MP3

JPEG

WMA

This feature allows you to program a MP3 disc to play in a desired sequence.

- 1 Press the **MODE** button while playback is stopped.
 - The PROGRAM screen will appear.
- 2 Press the \blacktriangle or \blacktriangledown button to select a group, then press the **ENTER** button.
 - A track selection screen appears.
- 3 Press the \blacktriangle or \blacktriangledown button to select a track, then press the **ENTER**, button to save it in a program.
 - Press the **CLEAR** button to erase the incorrect input.
 - The programmed track is displayed in the right-hand screen.
 - If the entire program cannot be displayed at once on the screen, " \blacktriangledown " appears to go to the next page.
 - Pressing the \blacktriangleleft button will show a list of folders that belong to the one-level upper hierarchy than the currently selected folder.
- 4 Press the **PLAY** button to start programmed playback.
 - Programmed play starts.

NOTES:

- Press the **CLEAR** button, and the last-programmed entry will be deleted.
- Press the **RETURN** button, and the STOP screen will show up with the program contents in memory.
- Press the **STOP** button, and then press the **PLAY** button. Playback will restart from the beginning of the track being played previously.(Program cleared)
- The program setting will be cancelled when the power is turned off or the disc tray is opened.
- Up to 99 tracks can be set in a program.
- If a disc in inserted that contains mixed MP3, JPEG and WMA files, program setting allows 99 tracks for combination of MP3, JPEG and WMA files.
- If eight or more tracks have been set in a program, the user can switch the right part of the screen with the **SKIP** button $\blacktriangleleft\blacktriangleleft$ or $\blacktriangleright\blacktriangleright$.

Audio Language or Sound Mode

DVD-V

The DVD player allows you to select a language during DVD disc (if multi language available) playback.

- 1 Press the **AUDIO** button during playback.
- 2 Press the **AUDIO** button repeatedly to select your desired language.

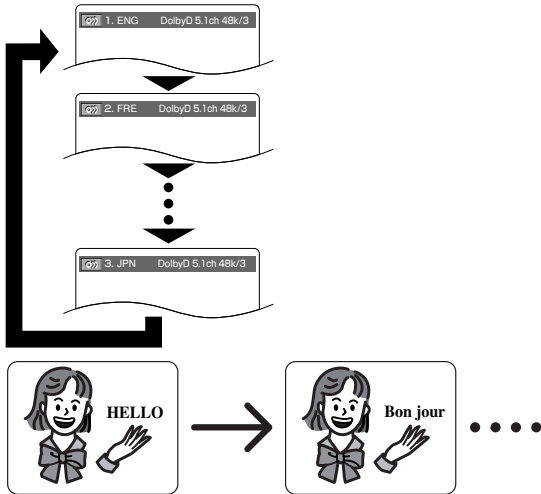

NOTES:

- The sound mode cannot be changed during playback of discs not recorded in double sound.
- Pressing the **AUDIO** button may not work on some DVDs with multiple audio languages (e.g. DVDs which allow audio language setting on the disc menu).

Stereo Sound Mode

CD VCD

- 1 Press the **AUDIO** button repeatedly during playback to select between STEREO, L-CH or R-CH.
 STEREO - both right and left channels are active (stereo)
 L-CH - only left channel is active
 R-CH - only right channel is active

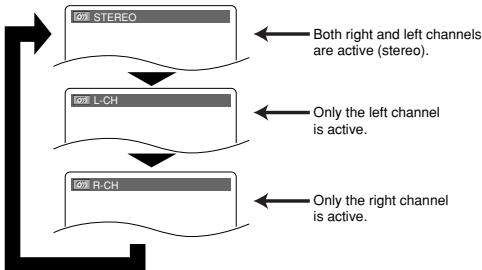

NOTES:

- If the Virtual Surround setting is ON, the sound mode will be fixed to STEREO, and can not be changed.
- Stereo sound mode will not be changed when playing DTS CD.

Subtitle Language

DVD-V

The DVD player allows you to select a language for subtitle during DVD disc (if available) playback.

- 1 Press the **SUBTITLE** button during playback.
- 2 Press the **SUBTITLE** button repeatedly to select your desired subtitle language.
 - The selected language will be displayed on the display bar at the top of the screen.
- 3 To turn off subtitles, press the **SUBTITLE** button repeatedly until OFF appears.

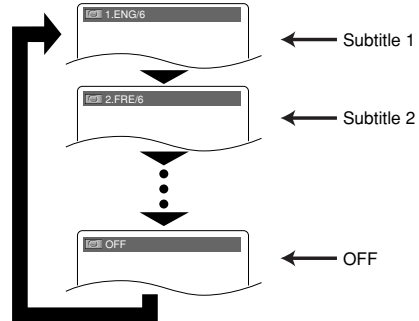

NOTES:

- Some discs allow audio language setting/subtitle language setting on the disc menu. (Operation varies between discs, so refer to the manual accompanying the disc.)
- If the desired language is not shown after pressing the **SUBTITLE** button several times, the disc does not have subtitles in that language.
- If you choose a Language that has a 3-letter language code, the code will be displayed every time you change the Subtitle language setting. If you choose any other languages, '---' will be displayed instead. (Refer to page 25.)

Camera Angle

DVD-V

Some DVD discs contain scenes which have been shot simultaneously from various angles. You can change the camera angle when the (CAM) mark appears on the screen.

- 1 Press the **ANGLE** button during playback.
 - The selected angle will be displayed on the display bar at the top of the screen.
- 2 Press the **ANGLE** button repeatedly to select your desired angle.

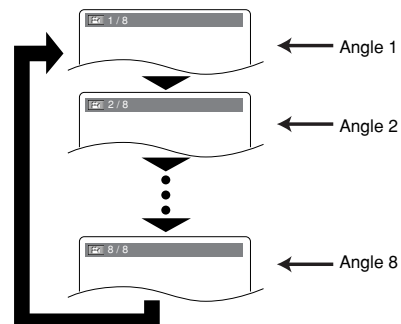

In Setup menu, QUICK mode and CUSTOM mode are available. QUICK mode consists of the setting menus often needed, and you can make all settings required in CUSTOM mode. You can make the settings of the items with **QUICK** mark in QUICK mode.

Language Setting

Language options are not available with some discs.

- 1 Press the **SETUP** button in STOP mode.
- 2 Press the **▶** button to select CUSTOM, then press the **ENTER** button.
 - CUSTOM mode will appear.
- 3 Press the **◀** or **▶** button to select LANGUAGE, then the **ENTER** button to confirm.

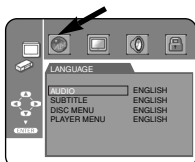

- 4 Press the **▲** or **▼** button to select the below items, then press the **ENTER** button.

AUDIO (Default : ENGLISH)

- Sets the audio language.

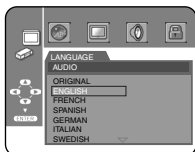

SUBTITLE (Default : ENGLISH)

- Sets the subtitle language.

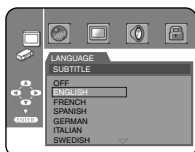

DISC MENU (Default : ENGLISH)

- Sets the language for DVD Menu.



PLAYER MENU

(Default : ENGLISH) **QUICK**

- Sets the language for the On-Screen display.



- 5 Press the **▲** or **▼** button to select a setting, then press the **ENTER** button.
 - If OTHER is selected in the AUDIO, SUBTITLE or DISC MENU screen, press four-digit number to enter the code for the desired language. (Refer to the language code list on page 25).
 - Only the languages supported by the disc can be selected.

- 6 Press the **SETUP** button to exit.

NOTE:

- Language Setting for Dialog and Subtitle is not available with some discs. Then use the **AUDIO** and **SUBTITLE** buttons. Details are on page 21.

Display Setting

You can change certain aspects of the DVD display screens, on-screen messages and the display panel on the front of the DVD player.

- 1 Press the **SETUP** button in STOP mode.
- 2 Press the **▶** button to select CUSTOM, then press the **ENTER** button.
 - CUSTOM mode will appear.
- 3 Press the **◀** or **▶** button to select DISPLAY, then the **ENTER** button to confirm.

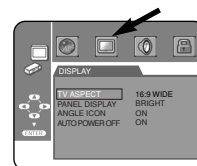

- 4 Press the **▲** or **▼** button to select the below items, then press the **ENTER** button.

TV ASPECT (Default : 16:9 WIDE)

QUICK

- Press the **▲** or **▼** button for an item selection, then press the **ENTER** button.
- Select 4:3 LETTER BOX for a black bars appears on top and bottom of the screen.
- Select 4:3 PAN & SCAN for a full height picture with both sides trimmed.
- Select 16:9 WIDE if a wide-screen TV is connected to the DVD player.

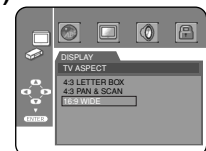

PANEL DISPLAY (Default : BRIGHT)

- Press the **▲** or **▼** button for an item select BRIGHT, DIMMER and AUTO, then press the **ENTER** button.
- This adjust the brightness of the display panel with the factory default BRIGHT.
- When AUTO is selected, the display dims only during playback.

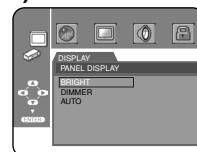

ANGLE ICON (Default : ON)

- Press the **ENTER** button repeatedly to turn Angle mark ON or OFF.

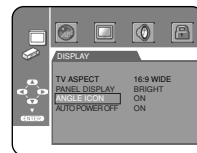

AUTO POWER OFF (Default : ON)

- Press the **ENTER** button repeatedly to turn Auto Power ON or OFF.
- It will turn the DVD player to off automatically after 35 minutes of no use.

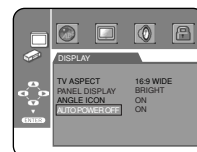

- 5 Press the **SETUP** button to exit.

NOTE:

- Be sure to press the **SETUP** button, or the setting will not work.

Audio Setting

Choose the appropriate Audio settings for your equipment as it only affect during the playback of DVD discs of the DVD player.

- 1 Press the **SETUP** button in STOP mode.
- 2 Press the **▶** button to select CUSTOM, then press the **ENTER** button.
 - CUSTOM mode will appear.
- 3 Press the **◀** or **▶** button to select AUDIO, then the **ENTER** button to confirm.

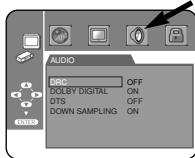

- 4 Press the **▲** or **▼** button to select the below items, then press the **ENTER** button.

DRC (Dynamic Range Control) (Default : OFF)

- To compress the range of sound volume.

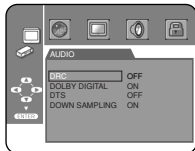

DOLBY DIGITAL (Default : ON)

QUICK

- Set to ON when the player is connected to Dolby Digital Decoder.
- ON : Output by Dolby Digital
- OFF : Convert the Dolby Digital to PCM

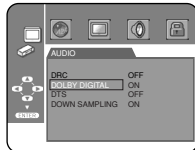

DTS (Default : ON)

- ON : Output by DTS sound
- Set to DTS when the unit is connected to DTS Decoder.
- OFF : No DTS sound will be output.

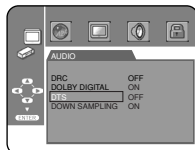

DOWN SAMPLING (Default : ON)

- Set to ON when outputting in 48kHz.

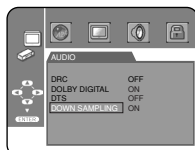

When playing disc with copyright Protection

- Even If you select OFF, copyright protection will be activated and sound will be down sampled at 48kHz.

- 5 Press the **SETUP** button to exit.

Parental Control

Ratings Control limits playback of discs with unsuitable audience ratings. A four digit code established by the user will unlock the parental lock.

This feature allows you to prevent discs with objectionable scenes from being played by your children.

PARENTAL LEVEL

Rating Level allows you to set the rating level of your DVD discs. Playback will stop if the disc's ratings exceed the level you set.

- 1 Press the **SETUP** button in STOP mode.
- 2 Press the **▶** button to select CUSTOM, then press the **ENTER** button.
- 3 Press the **◀** or **▶** button to select PARENTAL, then press the **ENTER** button.
- 4 Enter your four-digit password then press the **ENTER** button.

- 5 Press the **▲** or **▼** button to select PARENTAL LEVEL, then press the **ENTER** button.

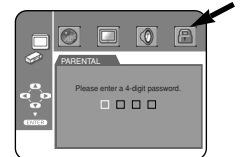

- 6 Press the **▲** or **▼** button to select the desired level, then press the **ENTER** button.

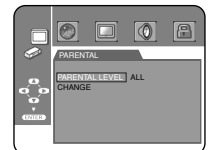

- 7 Press the **SETUP** button to exit.

NOTES:

- When doing this for the first time, enter any 4 digits. (except for 4737) That number will be used as the password from the second time onward.
- To change the password, press the **▲** or **▼** button to select CHANGE at step 5, then press the **ENTER** button. Enter the four-digit password, then press the **ENTER** button.
- With some DVDs, it may be difficult to find if they are compatible with parental lock. Be sure to check if the parental lock function operates in the way that you have set.
- Record the password in case you forget it.
- The parental lock level is equivalent to the following USA movie ratings.

LEVEL 7: NC-17
 LEVEL 6: R
 LEVEL 4: PG13
 LEVEL 3: PG
 LEVEL 1: G

The parental lock levels for "CANADA" are included for future use. Check the appropriate parental lock level when you buy a DVD video disc equipped with the parental lock feature in the future.

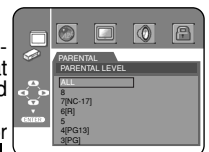

IF YOU FORGET THE PASSWORD

- 1 Press **4, 7, 3, 7** at step 4.
 - Password will be cleared and rating level will be set to ALL.
- 2 Repeat steps 5-7 to re-establish the parental lock.

CONTROL LEVELS

- **ALL**
Parental lock is cancelled.
- **Level 8**
DVD software of any grade (adult/general/children) can be played back.
- **Levels 7 to 2**
Only DVD software intended for general use and children can be played back.
- **Level 1**
Only DVD software intended for children can be played back, with those intended for adult and general use prohibited.

DVD SETUP

Language	Code	Language	Code	Language	Code	Language	Code
A-B							
Abkhazian	4748	Frisian	5271	Malay	5965	Somali	6561
Afar	4747	Galician	5358	Malayalam	5958	Spanish [SPA]	6165
Afrikaans	4752	Georgian	5747	Maltese	5966	Sundanese	6567
Albanian	6563	German [GER]	5051	Maori	5955	Swahili	6569
Amharic	4759	Greek [GRE]	5158	Marathi	5964	Swedish [SWE]	6568
Arabic	4764	Greenlandic	5758	Moldavian	5961	T	
Armenian	5471	Guarani	5360	Mongolian	5960		Tagalog
Assamese	4765	Gujarati	5367	Nauru	6047	Tajik	6653
Aymara	4771	Hausa	5447	Nepali	6051	Tamil	6647
Azerbaijani	4772	Hebrew	5569	Norwegian [NOR]	6061	Tatar	6666
Bashkir	4847	Hindi	5455	O-R		Telugu	6651
Basque	5167	Hungarian [HUN]	5467		Occitan	6149	Thai
Bengali;Bangla	4860	Icelandic [ICE]	5565	Oriya	6164	Tibetan	4861
				Oromo(Afan)	6159	Tigrinya	6655
Bhutani	5072	Indonesian	5560	Panjabi	6247	Tonga	6661
Bihari	4854	Interlingua	5547	Pashto;Pushto	6265	Tsonga	6665
Bislama	4855	Interlingue	5551	Persian	5247	Turkish [TUR]	6664
Breton	4864	Inupiak	5557	Polish	6258	Turkmen	6657
Bulgarian	4853	Irish [IRI]	5347	Portuguese [POR]	6266	Twi	6669
Burmese	5971	Italian [ITA]	5566	Quechua	6367	U-Z	
Byelorussian	4851	Japanese [JPN]	5647	Rhaeto-Romance	6459		Ukrainian
Cambodian	5759	Javanese	5669	Romanian [RUM]	6461	Urdu	6764
		Kannada	5760	Russian [RUS]	6467	Uzbek	6772
Catalan	4947	Kashmiri	5765	S		Vietnamese	6855
Chinese [CHI]	7254	Kazakh	5757		Samoan	6559	Volapuk
Corsican	4961	Kinyarwanda	6469	Sangho	6553	Welsh	4971
Croatian	5464	Kirghiz	5771	Sanskrit	6547	Wolof	6961
Czech	4965	Kirundi	6460	Scots Gaelic	5350	Xhosa	7054
Danish [DAN]	5047	Korean [KOR]	5761	Serbian	6564	Yiddish	5655
Dutch [DUT]	6058	Kurdish	5767	Serbo-Croatian	6554	Yoruba	7161
English [ENG]	5160	L-N		Sesotho	6566	Zulu	7267
Esperanto	5161		Laothian	5861	Setswana	6660	
Estonian	5166	Latin	5847	Shona	6560		
Faroese	5261	Latvian;Lettish	5868	Sindhi	6550		
		Lingala	5860	Singhalese	6555		
Fiji	5256	Lithuanian	5866	Siswat	6565		
Finnish [FIN]	5255	Macedonian	5957	Slovak	6557		
French [FRE]	5264	Malagasy	5953	Slovenian	6558		

If you choose a Language that has a 3-letter language code, the code will be displayed every time you change the Audio or Subtitle language setting on page 21. If you choose any other languages, '---' will be displayed instead. (3-letter language code is written in bracket.)

MAINTENANCE

Cleaning the Cabinet

- Use a soft cloth slightly moistened with a mild detergent solution. Do not use a solution containing alcohol, spirits, ammonia or abrasives.

Cleaning Discs

- When a disc becomes dirty, clean it with a cleaning cloth. Wipe the disc from the center out. Do not wipe in a circular motion.
- Do not use solvents such as benzine, thinner, commercially available cleaners, detergent, adrasive cleaning agents or antistatic spray intended for analogue records.

Cleaning the disc lens

- If the player still does not perform properly when it is operated while referring to the relevant sections and to "TROUBLESHOOTING GUIDE" in this Operating Instruction, the laser optical pickup unit may be dirty. Consult your dealer or an Authorized Service Center for inspection and cleaning of the laser optical pickup unit.

Disc Handling

- Use discs which have the following logos on them. (Optical audio digital discs.)
- Handle the discs so that fingerprints and dust do not adhere to the surfaces of the discs.
- Always store the disc in its protective case when it is not used.
- Note that discs with special shapes (heart-shaped discs, octagonal discs, etc.) cannot be played on the this product. Do not attempt to play such discs, as they may damage the player.



Make your contribution to the environment!!!

- Used up batteries do not belong in the dust bin.
- You can dispose of them at a collection point for used up batteries or special waste. Contact your council for details.

TROUBLESHOOTING GUIDE

If the DVD player does not perform properly when operated as instructed in this Operating Instruction, check the player, consulting the following checklist.

Problem	Solution
No power	<ul style="list-style-type: none"> -Check if the AC power cord is properly connected. -Unplug the outlet once, and wait for 5-10seconds and then plug it in again
No sound or picture	<ul style="list-style-type: none"> -Check if the TV is switched on. -Check the video connection -Check the VIDEO/AUDIO cable connections to the TV (See Connecting to a TV) -Check if the progressive switch is set correctly according to your TV. If your TV is not compatible with progressive scan, keep the Progressive switch to "INTERLACE."
Distorted picture	<ul style="list-style-type: none"> -Sometimes a small amount of picture distortion may appear. This is not a malfunction. -Connect the player directly to the TV.
Completely distorted picture or black/white picture with DVD	<ul style="list-style-type: none"> -Connect DVD player directly to the TV. -Make sure the disc is compatible with the DVD player.
No sound or distorted sound	<ul style="list-style-type: none"> -Adjust the volume. -Check that the speakers are connected correctly.
No audio at digital output	<ul style="list-style-type: none"> -Check the digital connections. -Check if the audio format of the selected audio language matches your receiver capabilities.
Picture freezes momentarily during playback	<ul style="list-style-type: none"> -Check the disc for fingerprints/scratches and clean with a soft cloth wiping from center to edge. -Clean the disc
Disc can't be played	<ul style="list-style-type: none"> -Clean the disc -Ensure the disc label is facing up. -Check if the disc is defective by trying another disc. -Cancel the parental lock or change the control level. -Insert a correct disc that plays on this player.
No return to start-up screen when disc is removed	<ul style="list-style-type: none"> -Reset the player by switching the player off, then on again.
The player does not respond to the remote control	<ul style="list-style-type: none"> -Aim the remote control directly at the sensor on the front of the player. -Reduce the distance to the player. -Replace the batteries in the remote control. -Re-insert the batteries with their polarities (+/- signs) as indicated.
Buttons do not work or player stops responding	<ul style="list-style-type: none"> -To completely reset the player, unplug the AC cord from the AC outlet for 5-10 seconds.
Player does not respond to some operating commands during playback	<ul style="list-style-type: none"> -Operations may not be permitted by the disc. Refer to the instructions of the disc.
DVD player cannot read CDs/DVDs	<ul style="list-style-type: none"> -Use a commonly available cleaning CD/DVD to clean the lens before sending the DVD player for repair.
Angle does not switch	<ul style="list-style-type: none"> -The angle cannot be switched for DVDs which do not contain multiple angles. In some cases multiple angles are only recorded for specific scenes.
Playback does not start when the title is selected	<ul style="list-style-type: none"> -Check the "PARENTAL" setting.
The password for rating level has been forgotten	<ul style="list-style-type: none"> -Enter the default password "4737", then your forgotten password will be cleared

NOTES:

Some functions are not available in specific modes, but this is not a malfunction. Read the description in this Operating Instruction for details on correct operations.

- Playback from a desired track and random playback are not available during program playback.

SPECIFICATIONS

SIGNAL SYSTEM

NTSC color

APPLICABLE DISCS

- (1) DVD-Video Discs
 - 1-layer 12cm single-sided discs, 2-layer 12cm single-sided discs, 2-layer 12cm double-sided discs (1 layer per side)
 - 1-layer 8cm single-sided discs, 2-layer 8cm single-sided discs, 2-layer 8cm double-sided discs (1 layer per side)
- (2) DVD-R/DVD-RW
- (3) Compact discs (Audio CD, Video CD)
 - 12cm discs, 8cm discs
- (4) CD-R/CD-RW

S-VIDEO OUTPUT

Y output level: 1Vp-p (75Ω/ohms)
 C output level: 0.286Vp-p
 Output connectors: S connectors, 1 set

VIDEO OUTPUT

Output level: 1Vp-p (75Ω/ohms)
 Output connector: Pin jacks, 1 set

COMPONENT OUTPUT

Y output level: 1Vp-p (75Ω/ohms)
 Cb/Pb output level: 0.7Vp-p (75Ω/ohms)
 Cr/Pr output level: 0.7Vp-p (75Ω/ohms)
 Output connector: Pin jacks, 1 set

AUDIO OUTPUT

Output level: 2Vrms
 2 channel (L, R) output connector: Pin jack, 1 set

AUDIO OUTPUT PROPERTIES

- (1) Frequency response
 - 1 DVDs (linear PCM) : 4Hz to 22kHz (48 kHz sampling)
 - : 4Hz to 44kHz (96 kHz sampling)
 - 2 CDs : 4Hz to 20kHz
- (2) S/N ratio : 115dB
- (3) Total harmonic distortion: 1kHz CD: 0.003%
- (4) Dynamic range : DVD: 100dB
 CD: 98dB

DIGITAL AUDIO OUTPUT

Optical digital output: Optical connector, 1 set
 Coaxial digital output: Pin jack, 1 set

POWER SUPPLY

AC 120V, 60Hz

POWER CONSUMPTION

11W (Standby: 0.4W)

MAXIMUM EXTERNAL DIMENSIONS

440 (width) x 75 (height) x 211 (depth) mm
 (17-5/16" x 2-61/64" x 8-5/16") (including protruding parts)

MASS

2.1Kg (4.6lbs)

REMOTE CONTROL UNIT

RC6400DV
 Infrared pulse type
 Supply: DC 3V, 2 R6P/AA batteries

www.marantz.com

You can find your nearest authorized distributor or dealer on our website.

JAPAN	Marantz Japan, Inc.	35-1 Sagami Ohno 7-Chome, Sagamihara-shi, kanagawa 228-8505, Japan
U.S.A	Marantz America, Inc.	1100 Maplewood Drive, Itasca, IL 60143, U.S.A.
EUROPE	Marantz Europe B.V.	P.O. Box 8744, 5605 LS Eindhoven, The Netherlands

marantz[®] is a registered trademark.



2003/10

MITi

44AW851250

Printed in China

OVMN03859
E57M0UD ★★★★★

Free Manuals Download Website

<http://myh66.com>

<http://usermanuals.us>

<http://www.somanuals.com>

<http://www.4manuals.cc>

<http://www.manual-lib.com>

<http://www.404manual.com>

<http://www.luxmanual.com>

<http://aubethermostatmanual.com>

Golf course search by state

<http://golfingnear.com>

Email search by domain

<http://emailbydomain.com>

Auto manuals search

<http://auto.somanuals.com>

TV manuals search

<http://tv.somanuals.com>