

Marshall Electronics  
Broadcast Multimedia Division

Marshall Electronics  
El Segundo, California  
[www.LCDRacks.com](http://www.LCDRacks.com)

15" Rackmountable  
LCD PANEL with  
Audio

V-R151P

# Table of Contents

<b>1. Installation</b> .....	3
1) Before Installation .....	3
2) Components .....	3
3) Operation .....	3
4) Tally .....	3
5) Mounting .....	3
6) Connections .....	4,5
<b>2. TV</b> .....	6
1) TV Mode Selection .....	6
2) Value Default .....	6
3) Channel ADD/REMOVE .....	6
4) Air / CAble TV .....	6
5) Volume Adjust .....	6
6) Control Change .....	6
<b>3. Computer</b> .....	7
1) Computer Mode Selection .....	7
2) Horizontal pan / Vertical Pan control .....	7
3) Value Default .....	7
4) Color Change .....	7
5) Input Condition Control.....	7
<b>4. Composite Video / S-VHS</b> .....	8
1) Composite Video / S-VHS Selection .....	8
2) Value Default .....	8
3) Video Mode .....	8
4) Volume Adjust .....	8
5) Color Change .....	8
<b>5. Menu Tree</b> .....	9
1) TV .....	9
2) Computer .....	10
3) Video .....	10
4) OSD Control .....	10
5) System Control Menu Tree.....	10
<b>6. Warranty</b> .....	11

## 6. Warranty

Marshall Electronics warrants to the first consumer, that this **V-R151P** rackmount monitor will, under normal use, be free from defects in workmanship and materials, when received in its original container, for a period of one year from the purchase date.

This warranty is extended to the first consumer only and proof of purchase is necessary to honor the warranty. If there is no proof of purchase provided with a warranty claim, Marshall Electronics reserves the right, not to honor the warranty set forth above. Therefore, labor and parts may be charged to you.

This warranty does not apply to product exterior and cosmetics. Misuse, abnormal service or handling, improper alterations or modifications in design or construction, voids this warranty. No sales personnel of the seller, nor any other person is authorized to make any warranties other than those described above, or to extend the duration of any warranties on behalf of Marshall Electronics, beyond the time period described above.

Due to constant effort to improve products and product features, specifications may change without notice.

MONITOR

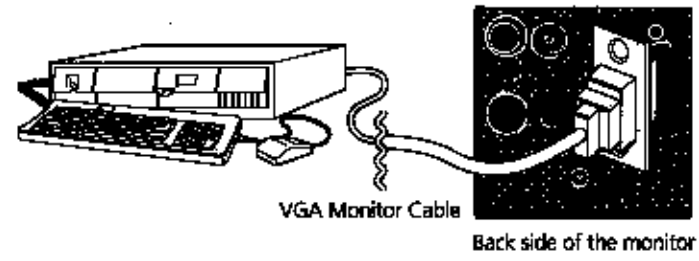

TV ON AIR

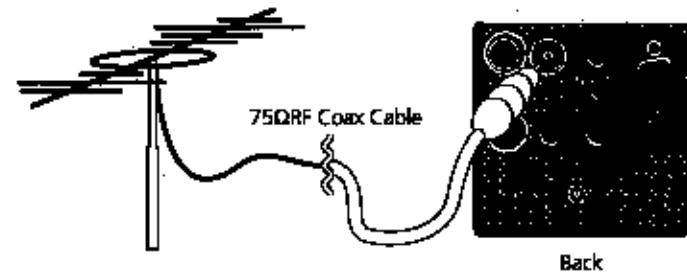

CABLE TV

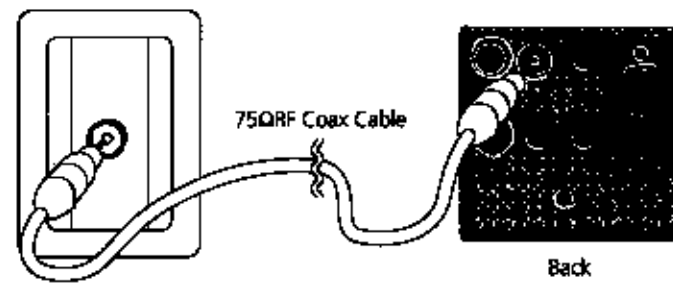

5. Menu Tree

1) TV

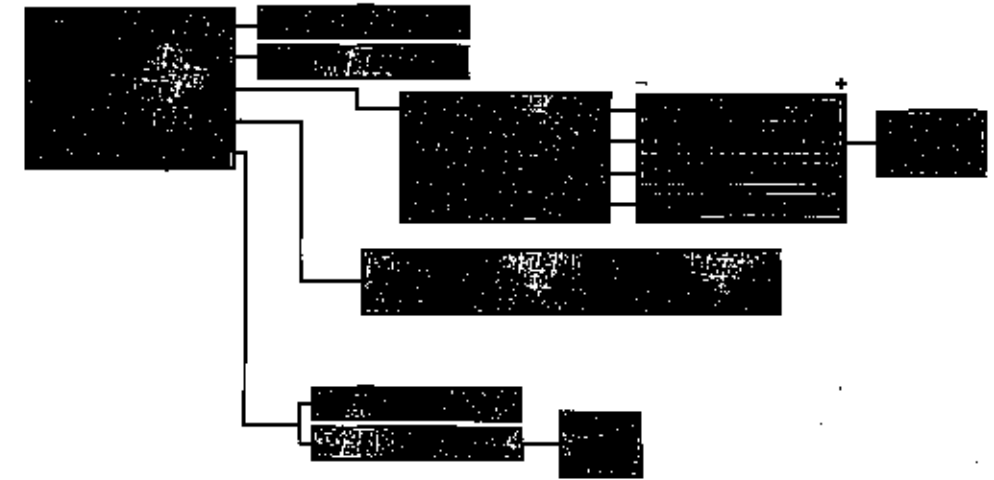

2) PC Monitor

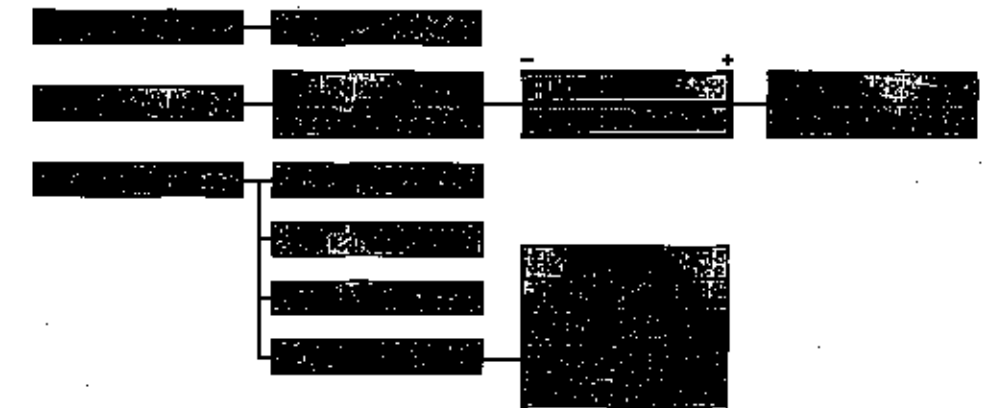

### 3) VIDEO

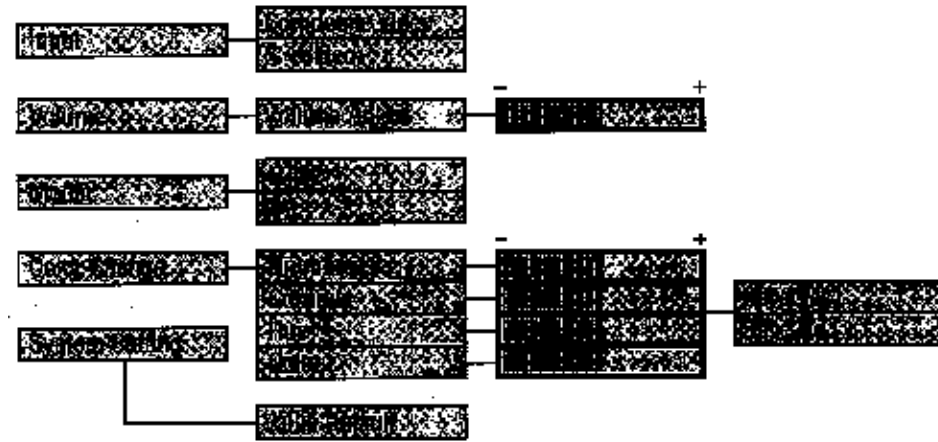

### 4) OSD ( On Screen Display) control

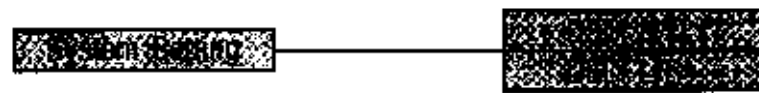

Press Menu → Select (System Setting) → Select OSD U/D) or OSD L/R) → use the UP, DOWN keys

### 5) System Control Menu Tree

	PC	TV	COMPOSITE	S-VHS
HORIZONTAL PAN	0			
VERTICAL PAN	0			
VALUE DEFAULT	0	0	0	0
CHANNEL ADD / REMOVE		0		
TV=AIR CH		0		
MODE			0	0
INPUT CONDITION	0			
VOLUME ADJUSTMENT		0	0	0
BRIGHTNESS	0	0	0	0
CONTRAST	0	0	0	0
HUE		0	0	0
COLOR		0	0	0

## 1. Installation

### 1) Before Installation

- Before using your monitor, make sure to read this manual carefully. In case of any problems with installation, contact Marshall Electronics.
- The monitor should be handled with caution and not be exposed to impact or shock.
- The display area is highly prone to scratches. Use cleaner suggested by the authorized service center.
- Do not expose the monitor in high temperature or in high humidity.
- There are no user serviceable parts inside your monitor. To avoid risk of electric shock, do not open your monitor case!

### 2) Components

- Rackmountable TFT LCD Monitor- 1 pc
- DC Power Supply Adapter -1 pc
- Power Cable 1- pc
- Computer Cable 1 pc

### 3) Operation

Multiple Input Terminal

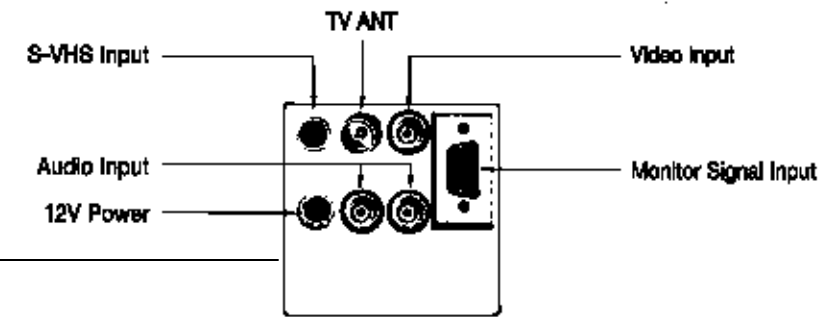

### 4) Tally

The V-R151P comes with a tally light installed at the top right-hand corner of the unit. The light is operated by inserting a 2.5mm plug into the jack marked 'TALLY' on the rear of the unit. The light will come on by **closing** the two contacts together. **DO NOT GIVE POWER TO THIS PLUG IT IS SELF-POWERED.**

### 5) Mounting

The V-R151P is designed to fit in a EIA standard 19" rack. It requires 6 rack units of vertical space and is secured with eight screws. It may be necessary to center the unit up or down so that it does not touch any adjacent units when the unit is tilted up or down.



## 2. TV Mode

### 1) TV Mode Selection

Press **Menu** → **Select** (INPUT) Using UP, DOWN keys → **Select** (TV)

### 2) Value Default

Press **Menu** → **Select** (SYSTEM SETTING) → **Select** (VALUE DEFAULT) System control values will be initialized as this monitor is originally manufactured.

### 3) Channel ADD / Remove

Press **Menu** → **Select** (CHANNEL ADD/ REM) → when you select a channel which has already been added, (ADD/REMOVE) will turn into (REMOVE) to remove the channel from your favorite channel list. To add the channel, **Select** (ADD) and press **Select**.

### 4) Air/ Cable TV

Press **Menu** → **Select** (SYSTEM SETTING) → **Select** (TV) **Select** (AIR) or (CABLE)

### 5) Volume Adjust

Press **Menu** → **Select** (VOLUME ADJUST) → Use UP, DOWN keys → press **Select** (If you press **Menu** before pressing **Select**, volume adjust will become invalid.)

### 6) Color Change

Press **Menu** → **Select** (COLOR CHANGE) **Select** one of 4 modes → to set you can control **Selected** sub-menu with UP, DOWN keys → press **Select** → sub-menu (4 color mode) will appear → repeat the above steps until you have settled color change → press **Menu** → when you press **Menu**, you will be asked whether (SAVE YES) or to (SAVE NO) → **Select** one of the two options.  
(If you press menu before selecting (SAVE YES,) color change will become invalid.)

## 3. Computer

### 1) Computer Mode Selection

Press **Menu** → **Select** (INPUT) using the UP, DOWN keys → press **Select** (MONITOR) and then press select.

### 2). Horizontal Pan / Vertical Pan Control

Press **Menu** → **Select** (HORIZONTAL PAN ) or (VERTICAL PAN) → control (HORIZONTAL PAN) or (VERTICAL PAN) by pressing the UP, DOWN keys.

### 3) Value Default

Press **Menu** → **Select** (SYSTEM SETTING) → press **Select** (VALUE DEFAULT) → press **Select** (System control values will be initialized as this monitor is manufactured.)

### 4) Color Change

Press **Menu** → **Select** (COLOR CHANGE) → **Select** one of 4 modes to set → you can control selected sub-menu with the UP, DOWN keys → press **Select** → sub-menu (4 color mode) will appear → repeat the above steps until you have settled color change → press **Menu** → when you press menu, you will be asked whether (SAVE YES) or (SAVE NO) → **Select** one of the two options.

Color Change sub-menu will be limited to Brightness/Contrast only.

(If you press menu before selecting (SAVE YES), color will become invalid.)

### 5) Input Condition Control

Press **Menu** → **Select** (SYSTEM SETTING) → **Select** (INPUT CONDITION) → **Select** one of the five modes to set.

Control the selected sub-menu with Select key

After tuning is settled, use **Menu** key to escape from menu tree

## 4. Composite Video / S-VHS

### 1) Composite Video / S-VHS Selection

By Remote Control

Press **Video** or **S-VHS** on remote control directly.

By Menu key

Press **Menu** → **Select** (INPUT) using the UP, DOWN keys → press **Select** (COMPOSITE) or (S-VHS) and then press **Select**

### 2) Value Default

Press **Menu** → **Select** (MODE) → press **Select** → **Select** (NTSC) or (PAL) depends on manufactured country Video Mode will not work on (TV) and (Monitor)

### 3) Volume Adjust

Press **Menu** → **Select** (VOLUME ADJUST) → use the UP, DOWN keys → press **Select**  
(If you press menu before pressing select, volume adjust will become invalid, )

### 4) Color Change

Press **Menu** → **Select** (COLOR CHANGE) → **Select** one of 4 modes to set → you can control selected sub-menu with the UP, DOWN keys → press **Select** → sub-menu (4 color mode will appear → repeat the above steps until you have settled color change → press **Menu** → when you press **Menu**, you will be asked whether (SAVE YES) or (SAVE NO) → **Select** one of the two options.

(If you press menu before selecting (SAVE, YES) color change will become invalid.)

INSTALLATION cont.

## POWER SUPPLY

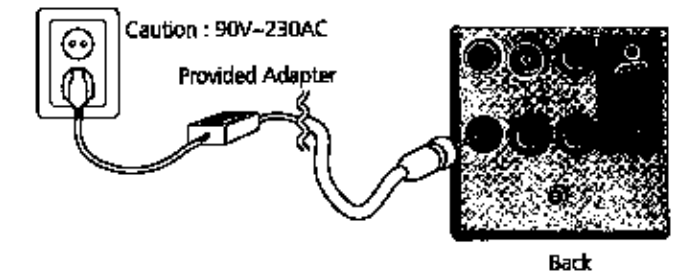

## CAMCORDER / Composite Video / DVD

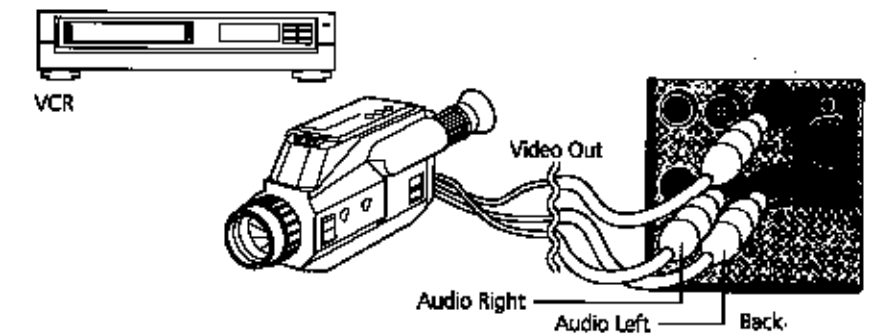

## S-VHS

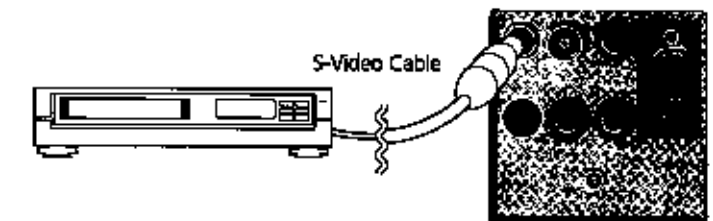

## Free Manuals Download Website

<http://myh66.com>

<http://usermanuals.us>

<http://www.somanuals.com>

<http://www.4manuals.cc>

<http://www.manual-lib.com>

<http://www.404manual.com>

<http://www.luxmanual.com>

<http://aubethermostatmanual.com>

Golf course search by state

<http://golfingnear.com>

Email search by domain

<http://emailbydomain.com>

Auto manuals search

<http://auto.somanuals.com>

TV manuals search

<http://tv.somanuals.com>