

INSTALLER: THESE INSTRUCTIONS MUST BE CONVEYED TO AND REMAIN WITH THE HOMEOWNER.

CERTIFIED UNDER CANADIAN AND AMERICAN NATIONAL STANDARDS, CSA 2.22, AND ANSI Z21.50 RESPECTIVELY FOR VENTED GAS FIREPLACES.



GAS - INSERTS

**INSTALLATION AND OPERATION INSTRUCTIONS FOR
GAS-FIRED VENTED FIREPLACE**

NATURAL GAS MODEL **GI 3600 - N**

PROPANE GAS MODEL **GI 3600 - P**

CERTIFIED FOR CANADA AND UNITED STATES USING ANSI / CSA METHODS

WARNING: If the information in these instructions is not followed exactly, a fire or explosion may result causing property damage, personal injury or death.

FOR YOUR SAFETY

Do not store or use gasoline or other flammable vapours and liquids in the vicinity of this or any other appliance.

WHAT TO DO IF YOU SMELL GAS:

- Do not try to light any appliance.
- Do not touch any electrical switch.
- Do not use any phone in your building.
- Immediately call your gas supplier from a neighbor's phone. Follow the gas supplier's instructions.
- If you cannot reach your gas supplier, call the fire department.

Installation and service must be performed by a qualified installer, service agency or the gas supplier.



Wolf Steel Ltd., 24 Napoleon Rd., Barrie, ON L4M 4Y8 Canada • (705)721-1212 • fax(705)722-6031

www.napoleonfireplaces.com • ask@napoleon.on.ca

W415-0061/B/01.11.05

TABLE of CONTENTS

PG 2-5 INTRODUCTION	8	OPERATION / MAINTENANCE CONT'D
Warranty		Operating Instructions
General Instructions		Maintenance
General Information	9	BLOWER SYSTEM
Care of Glass, & Plated Parts		Blower Replacement Instructions
5 INSTALLATION	9	ADJUSTMENTS
6-7 FINISHING		Pilot Burner Adjustment
Brick panels		Venturi Adjustments
Log Placement/Charcoal Embers	10-11	REPLACEMENTS
Louvre Installation		Ordering Replacement Parts
Logo Placement		Replacement Parts
7 OPERATION / MAINTENANCE		Accessories / Options
Spill Switch	12-13	TROUBLE SHOOTING GUIDE
Venting Action Check	14	SERVICE HISTORY

PLEASE RETAIN THIS MANUAL FOR FUTURE REFERENCE

WARNING

- Do not burn wood or other materials in this fireplace.
- Adults and especially children should be alerted to the hazards of high surface temperatures and should stay away to avoid burns or clothing ignition. Supervise young children when they are in the same room as the fireplace.
- Due to high temperatures, the fireplace should be located out of traffic and away from furniture and draperies.
- Clothing or other flammable material should not be placed on or near the fireplace.
- Any safety screen or guard removed for servicing must be replaced prior to operating the fireplace.
- It is imperative that the control compartments, burners and circulating blower and its passageway in the fireplace and venting system are kept clean. The fireplace and its venting system should be inspected before use and at least annually by a qualified service person. More frequent cleaning may be required due to excessive lint from carpeting, bedding material, etc. The fireplace area must be kept clear and free from combustible materials, gasoline and other flammable vapours and liquids.
- Under no circumstances should this fireplace be modified.
- This fireplace must not be connected to a chimney flue pipe serving a separate solid fuel burning appliance.
- Do not use this fireplace if any part has been under water. Immediately call a qualified service technician to inspect the fireplace and to replace any part of the control system and any gas control which has been under water.
- Do not operate the fireplace with the glass door removed, cracked or broken. Replacement of the glass should be done by a licensed or qualified service person.
- Do not strike or slam shut the fireplace glass door.

NAPOLEON gas fireplaces are manufactured under the strict Standard of the world recognized ISO 9001 : 2000 Quality Assurance Certificate.

NAPOLEON products are designed with superior components and materials, assembled by trained craftsmen who take great pride in their work. The burner and valve assembly are leak and test-fired at a quality test station. The complete fireplace is thoroughly inspected by a qualified technician before packaging to ensure that you, the customer, receives the quality product that you expect from NAPOLEON.

NAPOLEON GAS FIREPLACE PRESIDENT'S LIFETIME LIMITED WARRANTY

The following materials and workmanship in your new NAPOLEON gas fireplace are warranted against defects for as long as you own the fireplace. This covers: combustion chamber, heat exchanger, stainless steel burner, phazer™ logs and embers, ceramic glass (thermal breakage only), gold plated parts against tarnishing, porcelainized enamelled components and aluminum extrusion trims.

Electrical (110V and millivolt) components and wearable parts such as blowers, gas valves, thermal switch, switches, wiring, remote controls, ignitor, gasketing, and pilot assembly are covered and NAPOLEON will provide replacement parts free of charge during the first year of the limited warranty.

Labour related to warranty repair is covered free of charge during the first year. Repair work, however, requires the prior approval of an authorized company official. Labour costs to the account of NAPOLEON are based on a predetermined rate schedule and any repair work must be done through an authorized NAPOLEON dealer.

CONDITIONS AND LIMITATIONS

NAPOLEON warrants its products against manufacturing defects to the original purchaser only -- i.e., the individual or legal entity (registered customer) whose name appears on the warranty registration card filed with NAPOLEON -- provided that the purchase was made through an authorized NAPOLEON dealer and is subject to the following conditions and limitations:

This factory warranty is nontransferable and may not be extended whatsoever by any of our representatives.

The gas fireplace must be installed by a licenced, authorized service technician or contractor. Installation must be done in accordance with the installation instructions included with the product and all local and national building and fire codes.

This limited warranty does not cover damages caused by misuse, lack of maintenance, accident, alterations, abuse or neglect and parts installed from other manufacturers will nullify this warranty.

This limited warranty further does not cover any scratches, dents, corrosion or discolouring caused by excessive heat, abrasive and chemical cleaners nor chipping on porcelain enamel parts, mechanical breakage of PHAZER™ logs and embers, nor any venting components used in the installation of the fireplace.

NAPOLEON warrants its stainless steel burners against defects in workmanship and material for life, subject to the following conditions: During the first 10 years NAPOLEON will replace or repair the defective parts at our option free of charge. From 10 years to life, NAPOLEON will provide replacement burners at 50% of the current retail price.

In the first year only, this warranty extends to the repair or replacement of warranted parts which are defective in material or workmanship provided that the product has been operated in accordance with the operation instructions and under normal conditions.

After the first year, with respect to this President's Limited Lifetime Warranty, NAPOLEON may, at its discretion, fully discharge all obligations with respect to this warranty by refunding to the original warranted purchaser the wholesale price of any warranted but defective part(s).

After the first year, NAPOLEON will not be responsible for installation, labour or any other costs or expenses related to the reinstallation of a warranted part, and such expenses are not covered by this warranty.

Notwithstanding any provisions contained in this President's Limited Lifetime Warranty, NAPOLEON'S responsibility under this warranty is defined as above and it shall not in any event extend to any incidental, consequential or indirect damages.

This warranty defines the obligations and liability of NAPOLEON with respect to the NAPOLEON gas fireplace and any other warranties expressed or implied with respect to this product, its components or accessories are excluded.

NAPOLEON neither assumes, nor authorizes any third party to assume, on its behalf, any other liabilities with respect to the sale of this product. NAPOLEON will not be responsible for: over-firing, downdrafts, spillage caused by environmental conditions such as rooftops, buildings, nearby trees, hills, mountains, inadequate vents or ventilation, excessive venting configurations, insufficient makeup air, or negative air pressures which may or may not be caused by mechanical systems such as exhaust fans, furnaces, clothes dryers, etc.

Any damages to fireplace, combustion chamber, heat exchanger, brass trim or other component due to water, weather damage, long periods of dampness, condensation, damaging chemicals or cleaners will not be the responsibility of NAPOLEON.

The bill of sale or copy will be required together with a serial number and a model number when making any warranty claims from your authorized dealer. The warranty registration card must be returned within fourteen days to register the warranty.

NAPOLEON reserves the right to have its representative inspect any product or part thereof prior to honouring any warranty claim.

GENERAL INSTRUCTIONS

THIS GAS FIREPLACE SHOULD BE INSTALLED AND SERVICED BY A QUALIFIED INSTALLER to conform with local codes. Installation practices vary from region to region and it is important to know the specifics that apply to your area,

for example: in Massachusetts State:

- The fireplace damper must be removed or welded in the open position prior to installation of a fireplace insert or gas log.
- The appliance off valve must be a "T" handle gas cock.
- The flexible connector must not be longer than 36 inches.
- The appliance is not approved for installation in a bedroom or bathroom unless the unit is a direct vent sealed combustion product.
- WARNING: This product must be installed by a licensed plumber or gas fitter when installed within the commonwealth of Massachusetts.

In absence of local codes, install to the current National Fuel Gas Code, ANSI Z223.1, or the current CAN/CGA B149, Installation Codes.

Purge all gas lines with the glass door of the fireplace removed. Assure that a continuous gas flow is at the burner before installing the door.

Under extreme vent configurations, allow several minutes (5-15) for the flame to stabilize after ignition.

Altitudes greater than 4000ft. require a minimum vent run of 12ft.

The fireplace and its individual shutoff valve must be disconnected from the gas supply piping system during any pressure testing of that system at test pressures in excess of 1/2 psig (3.5 kPa). The fireplace must be isolated from the gas supply piping system by closing its individual manual shutoff valve during any pressure testing of the gas supply piping system at test pressures equal to or less than 1/2 psig (3.5 kPa).

A 1/8 inch NPT plug, accessible for test gauge connection, must be installed immediately upstream of the gas supply connection to the stove.

This fireplace must be connected to any accepted lined chimney system listed to ULC-S635M (in Canada) or UL-1777 (in USA). The venting connection must be in compliance with the vent manufacturers installation instructions. The draft hood must be installed so it is in the same atmospheric pressure zone as the combustion air inlet to the fireplace.

Provide adequate ventilation and combustion air. Provide adequate accessibility clearance for servicing and operating the fireplace. Never obstruct the front opening of the fireplace.

This insert must be recessed into a vented noncombustible woodburning fireplace (prefabricated or masonry) only. The minimum fireplace size in which the heater is to be installed is:

HEIGHT 17½ inches WIDTH 25½ inches DEPTH 16½ inches

The minimum distance, from the bottom of a combustible mantle projecting 6" maximum from the wall to the top of the unit, is 8".

The fireplace, when installed, must be electrically connected and grounded in accordance with local codes. In the absence of local codes, use the current CSA C22.1 CANADIAN ELECTRICAL CODE in Canada or the ANSI/NFPA 70 NATIONAL ELECTRICAL CODE in the United States. The blower power cord must be connected into a properly grounded receptacle. The grounding prong must not be removed from the cord plug.

GENERAL INFORMATION

FOR YOUR SATISFACTION, THIS FIREPLACE HAS BEEN TEST-FIRED TO ASSURE ITS OPERATION AND QUALITY! Maximum input is 24,000 BTU/hr for natural gas and 22,000 BTU/hr for propane. When the fireplace is installed at elevations above 4,500ft, and in the absence of specific recommendations from the local authority having jurisdiction, the certified high altitude input rating shall be reduced at the rate of 4% for each additional 1,000ft. Maximum output for natural gas is 15,900 BTU/hr and 16,000 BTU/hr for propane.

Minimum inlet gas supply pressure is 4.5 inches water column for natural gas and 11 inches water column for propane. This fireplace is certified for bedroom and bedsitting room installation. Maximum inlet gas pressure is 7 inches water column for natural gas and 13 inches water column for propane. Manifold pressure under flow conditions is 3.5 inches water column for natural gas and 10 inches water column for propane.

No external electricity (110 volts or 24 volts) is required for the gas system operation.

Expansion / contraction noises during heating up and cooling down cycles are normal and to be expected. Change in flame appearance from "HI" to "LO" is more evident in natural gas than in propane.

CARE OF GLASS AND PLATED

Do not use abrasive cleaners to clean plated parts. Buff lightly with a clean dry cloth. The glass is 3/16" ceramic glass available from your Napoleon / Wolf Steel Ltd. dealer. ***Do not substitute materials.*** Clean the glass after the first 10 hours of operation with a recommended gas fireplace glass cleaner. Thereafter clean as required.

Do not clean glass when hot! If the glass is not kept clean permanent discoloration and / or blemishes may result.

FIGURE 1

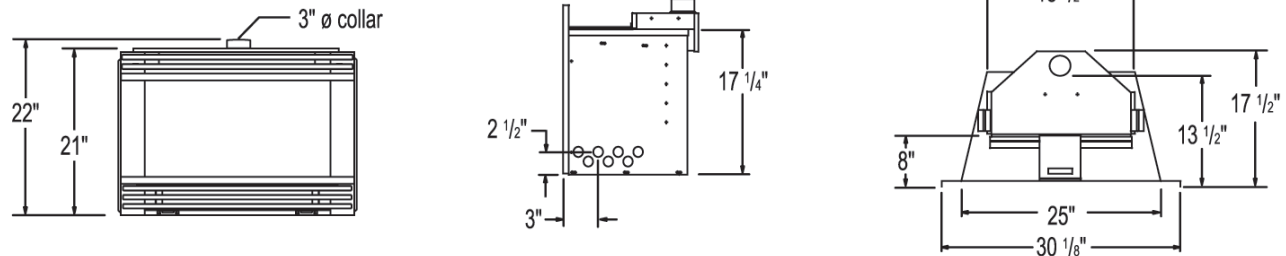

INSTALLATION

Clean out ashes from the inside of the wood-burning fireplace. Make sure that the chimney and wood-burning fireplace are in a clean and sound condition and constructed of non-combustible materials. If necessary have any repair work done by a qualified person before installing the insert. Remove the existing fireplace damper or lock into an open position.

Using screws, attach the fireplace warning tag (W385-0199) to the inside of the firebox of the fireplace into which the insert is being installed.

WARNING: THIS FIREPLACE HAS BEEN CONVERTED FOR USE WITH A GAS FIREPLACE INSERT ONLY AND CANNOT BE USED FOR BURNING WOOD OR SOLID FUELS UNLESS ALL ORIGINAL PARTS HAVE BEEN REPLACED AND THE FIREPLACE IS RE-APPROVED BY THE AUTHORITY HAVING JURISDICTION.

ATTENTION: CE FOYER A ETE CONVERTI AFIN D'ETRE UTILISE SEULEMENT COMME FOYER ENCASTRE AU GAZ ET NE PEUT ETRE UTILISE POUR BRULER DU BOIS OU TOUT AUTRE COMBUSTIBLE SOLIDE, SANS QUE TOUTES LES PIECES ORIGINALES AIENT ETE REMPLACEES ET QUE LE FOYER SOIT APPROUVE DE NOUVEAU PAR LES AUTORITES AYANT JURISDICTION. W385-0199

The sheet-metal parts of the fireplace, in which the gas fireplace insert is to be installed, must not be cut.

If the wood-burning factory-built fireplace has no gas access hole(s) provided, an access hole of 1 1/2 inch or less may be drilled through the lower sides or bottom of the fireplace in a proper workman like manner. This access hole must be plugged with non-combustible insulation after the gas supply line has been installed.

Ensure that existing chimney cleanouts fit properly.

The refractory, glass doors, screen rails, screen mesh and log grates may be removed from the fireplace before installing the gas fireplace insert.

Smoke shelves, shields and baffles may be removed if attached by mechanical fasteners.

The ventilation openings in the fireplace may be obstructed by the backer plates, aluminium trim etc. but these parts are not to be applied so as to have an airtight seal.

Line the chimney with a 3" or 4" diameter approved liner. With a 4" liner, an increaser must be connected between the dilution draft hood and the liner. Chimney installation must conform to both national and local code requirements. The liner must be continuous from the fireplace to the chimney cap.

FIGURE 2

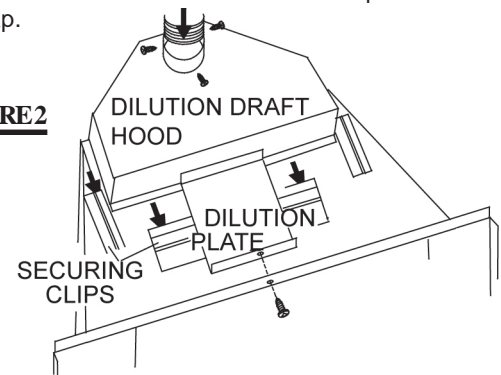

Remove the securing screw from the front of the dilution plate. Push the dilution draft hood out of the securing clips and attach the liner using 3 screws equally spaced. Pack insulation around the liner at the damper area to prevent air flow from entering the chimney. Move the insert into the centre of the woodburning fireplace making sure that the dilution draft hood inserts back into its securing clips. Level using the four leveling screws located front and back on either side of the fireplace base. Leveling the insert will eliminate rocking or excessive noise when the fan is in operation. Replace the securing screw to the front of the dilution plate.

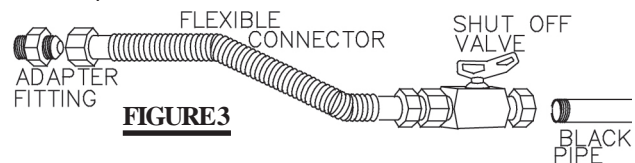

Install rigid black pipe, a flex connector, if local codes permit, or 1/2" type L, copper tubing with a 3/8" to 1/2" adapter and a shut off valve to the fireplace. Seal and tighten securely. The adapter will be required between the gas valve and the copper tubing or flex connector. **Do not kink flexible connector!** Check for gas leaks by brushing on a soap and water solution. **Do not use open flame!**

6

An on/off switch has been included and can be located at the right side trim. For ease of accessibility, this switch may be replaced with a wall switch or substituted with a millivolt thermostat that may be installed in a convenient location on any wall. Route a 2 strand solid core millivolt wire through the electrical hole located at the bottom right side of the unit. The recommended maximum lead length depends on wire size:

WIRE SIZE	MAX. LENGTH
14gauge	100 feet
16gauge	60 feet
18gauge	40 feet

Attach the two leads to terminals 1 and 3 located on the gas valve.

FIGURE4

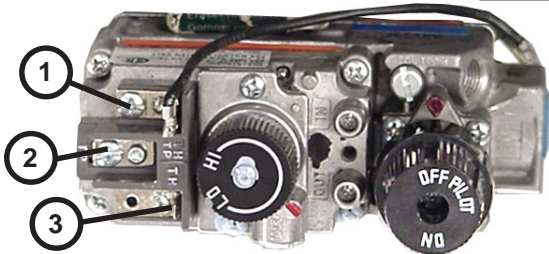

Do not connect the gas valve to electricity (110 volts or 24 volts).

The insert can be equipped with a flashing kit to close off most fireplace openings. Mount the flashing inside the unit's outer shell using 4 securing screws. The flashing and trim are available in many finishes to accent any room decor. Objects placed in front of the fireplace should be kept a minimum of 48" away from the front face.

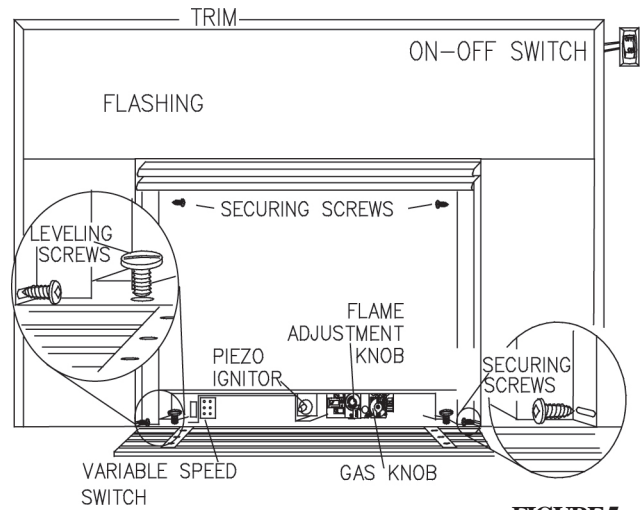

FIGURE5

FINISHING

FIBRE FIREBRICK PANELS

To give your insert that authentic masonry fireplace look, optional fibre firebrick panels are available at your Napoleon / Wolf Steel Ltd. dealer. Complete installation and maintenance instructions are included with the kit.

LOG PLACEMENT

PHAZER™ logs and charcoal embers, exclusive to Napoleon Fireplaces, provide a unique and realistic glowing effect that is different in every installation. Take the time to carefully position the charcoal embers for a maximum glowing effect.

1. Place the front log onto the main burner, pushing it as close as possible to the burner ports without blocking/covering them. The left and right spacing between the log ends and the burner ports should be equal.

YOU MAY FIND IT EASIER TO PLACE SOME CHARCOAL EMBERS BENEATH THE FRONT LOG NOW.

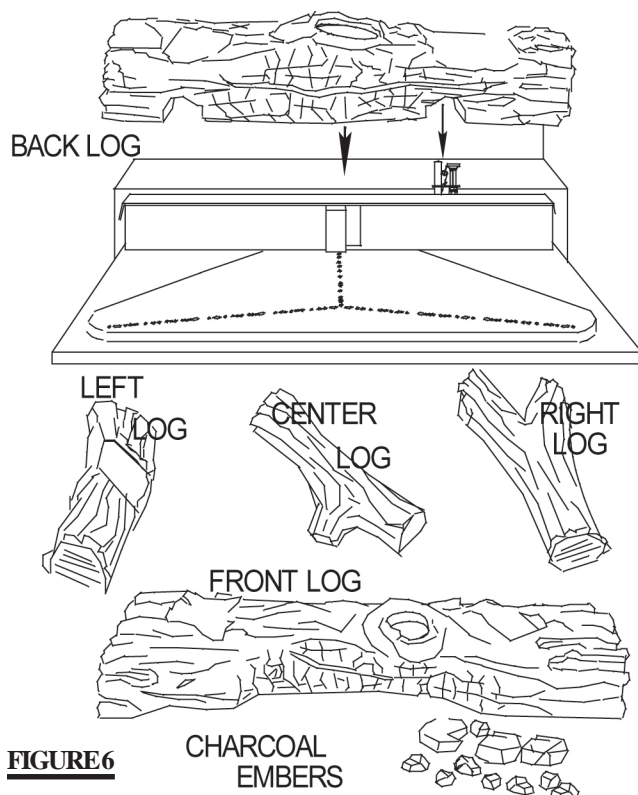

FIGURE 6

2. Place the back log onto the step located at the back of the combustion chamber. The notch situated at the lower right of the back log should be centered evenly above the pilot assembly.

3. While supporting the back log, to prevent it from falling forward, set the three smaller logs into the pockets and grooves of the front and back logs, respectively. Log colours may vary. During the initial use of the fireplace, the colours will become more uniform as colour pigments burn in during the heat activated curing process.

POSITIONING THE LOGS IMPROPERLY WILL CAUSE FLAME IMPINGEMENT AND CARBONING.

CHARCOAL EMBERS

Randomly place the embers beneath the front log, covering all of the burner area beneath the hollowed out section of the log. Place the remaining embers along the front. Keep ember dust away from burner ports to avoid plugging them.

Fine dust found in bottom of bag not to be used.

PHAZER™ logs and charcoal embers glow when exposed to direct flame. Use only certified **PHAZER™** logs and charcoal embers available from your Napoleon / Wolf Steel Ltd. dealer.

FIGURE 7

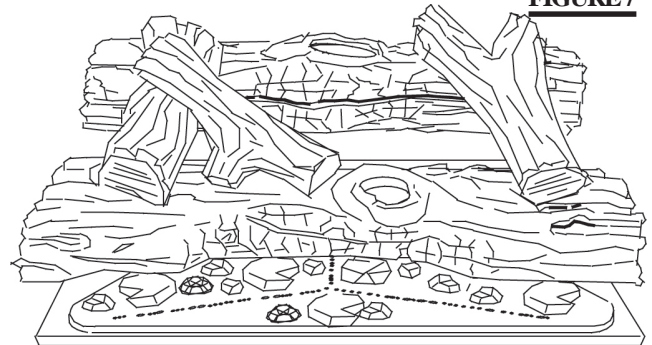

FLUSH LOUVRE KIT, GI-1L

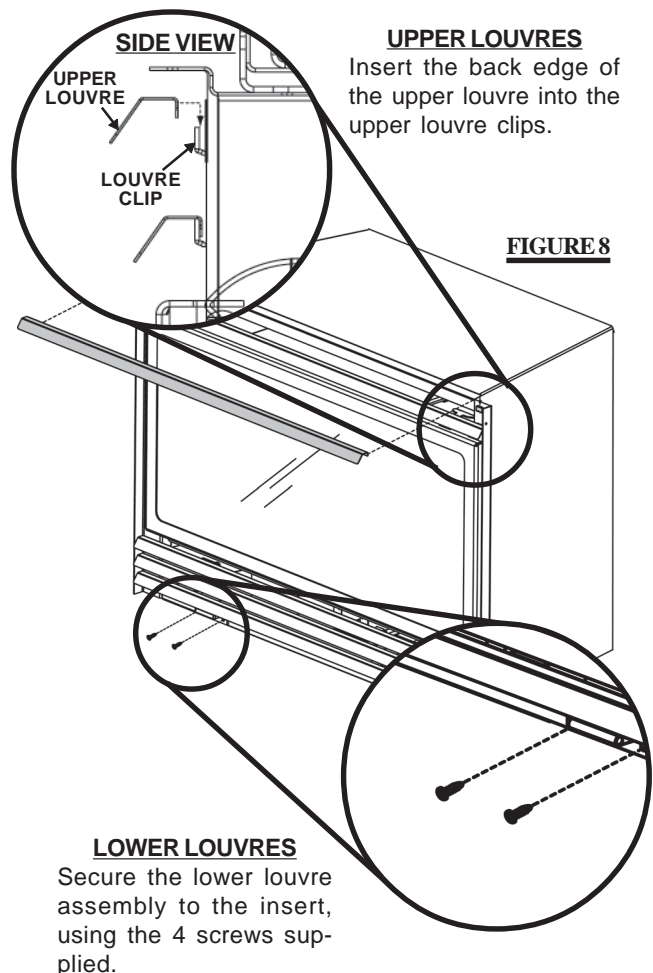

FIGURE 8

UPPER LOUVRES

Insert the back edge of the upper louvre into the upper louvre clips.

SIDE VIEW

UPPER LOUVRE

LOUVRE CLIP

LOWER LOUVRES

Secure the lower louvre assembly to the insert, using the 4 screws supplied.

LOGO PLACEMENT



Remove the backing of the logo supplied and place on the glass viewing area, as indicated.

FIGURE 9

OPERATION / MAINTENANCE

SPILL SWITCH

This is a thermally activated switch, attached to the back of the unit and extending up into the dilution draft hood, which senses the change in temperature and shuts down the gas valve in the event of a severe downdraft of air or a blocked or disconnected vent.

It acts as a safety shut-off to prevent a build up of carbon monoxide or an explosion of unburnt gases during start up. If the flue is blocked or has no "draw", the spill switch will automatically shut off the supply of gas within about 5-10 minutes.

TAMPERING WITH THE SWITCH CAN RESULT IN CARBON MONOXIDE (CO) POISONING AND POSSIBLE DEATH.

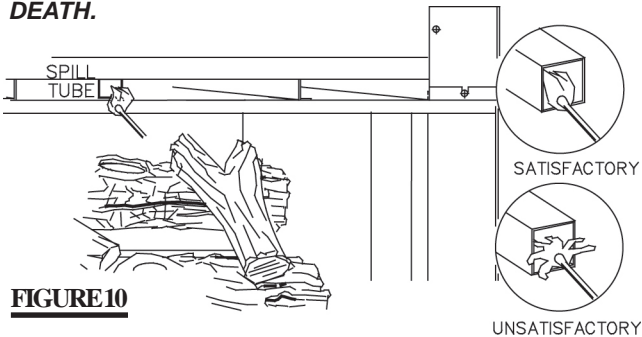

FIGURE 10

When lit for the first time, the fireplace will emit a slight odour for a few hours. This is a normal temporary condition caused by the curing of the logs and the "burn-in" of internal paints and lubricants used in the manufacturing process and will not occur again. Simply open a window to sufficiently ventilate the room.

VENTING ACTION CHECK

A CHECK FOR CORRECT VENTING ACTION MUST BE MADE BEFORE THE INSTALLED INSERT IS LEFT WITH THE CUSTOMER.

Test after installing the unit into a vented non-combustible fireplace in the following manner:

1. Close all doors and windows in the room; start exhaust fans in the home; turn fireplace blower off.
2. Set controls to "high" and light the unit.
3. Wait 5 minutes. Light a match and hold it to the spill tube opening.
4. Venting action is satisfactory if smoke is drawn into the spill tube. Venting action is unsatisfactory if the flame and smoke are not drawn into the tube.
5. If venting action is unsatisfactory, turn the unit off, wait 10 minutes and try again. If the smoke or flame is still not drawn into the spill tube, turn the unit off and check for vent blockage or restriction. If necessary, consult with a qualified air quality specialist.

After extended periods of non-operation such as following a vacation or a warm weather season, the fireplace may emit a slight odour for a few hours. This is caused by dust particles in the heat exchanger burning off. Open a window to sufficiently ventilate the room.





FOR YOUR SAFETY READ BEFORE LIGHTING:

- A** This fireplace has a pilot which must be lit by hand while following these instructions exactly.
- B** Before lighting, smell all around the fireplace area for gas and next to the floor because some gas is heavier than air and will settle on the floor.
- C** Use only your hand to push in or turn the gas control knob. Never use tools. If the knob will not push in or turn by hand, do not try to repair it. Call a qualified service technician. Force or attempted repair may result in a fire or explosion.
- D** Do not use this fireplace if any part has been under water. Immediately call a qualified service technician to inspect the unit and replace any part of the control system and any gas control touched by water.

WHAT TO DO IF YOU SMELL GAS:

- Do not try to light any appliance.
- Do not touch any electrical switch; do not use any phone in your building.
- Immediately call your gas supplier from a neighbour's phone. Follow the gas supplier's instructions.
- If you cannot reach your gas supplier, call the fire department.

LIGHTING INSTRUCTIONS

- 1.Stop!** Read all the safety information above. When lighting and re-lighting, the gas knob cannot be turned from "pilot" to "off" unless the knob is depressed.
- Turn off all electrical power to the stove.
- Turn the gas knob  clockwise to off.
- Wait 5 minutes for any gas in the combustion chamber to escape. Continue to the next step if you do NOT smell any gas. *If you smell gas, STOP!* and follow the instructions in "What to do if You Smell Gas" listed above.
- If the unit is equipped with a flame adjustment valve, turn  clockwise to off.
- Locate the pilot situated in front of the rear log.
- Turn the gas knob  counter-clockwise to "pilot" position.
- Depress and hold the gas knob while lighting the pilot with the push button ignitor. Keep the knob fully depressed for one (1) minute, then release. If the pilot does not continue to burn, repeat steps 3 through 7.
- With the pilot lit, turn the gas knob counter-clockwise  to "on" position.
- If your insert is equipped with a flame adjustment valve, push and turn the knob to "high".
- If your insert is equipped with a remote "on-off" switch, the main burner may not come on when you turn the gas valve to "on" or "high". **The remote switch must be in the "on" position as well to ignite the main burner.**
- Turn on all electrical power to the insert.

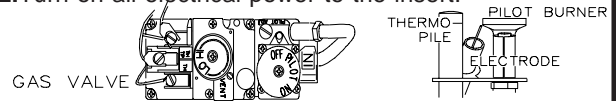
**TO TURN OFF GAS**

- Turn off all electrical power to the unit if service is to be performed.
- Push in gas control knob slightly and turn  clockwise to off. **DO NOT FORCE.**

MAINTENANCE**TURN OFF THE GAS AND ELECTRICAL POWER BEFORE SERVICING THE FIREPLACE.**

CAUTION: Label all wires prior to disconnection when servicing controls. Wiring errors can cause improper and dangerous operation. Verify proper operation after servicing. This insert and its venting system should be inspected before use and at least annually by a qualified service person. The fireplace area must be kept clear and free of combustible materials, gasoline or other flammable vapours and liquids. The flow of combustion and ventilation air must not be obstructed.

- In order to properly clean the burner and pilot assembly, remove the logs to expose both assemblies.
- Keep the control compartment, logs, burner, air shutter opening and the area surrounding the logs clean by vacuuming or brushing, *at least once a year.*

- Check to see that all burner ports are burning. Clean out any of the ports which may not be burning or are not burning properly.
- Check to see that the pilot flame is large enough to engulf the thermopile on one leg and reaches toward the burner on the other leg.
- Replace the cleaned logs.
- Check to see that the main burner ignites completely on all openings when the gas knob for the burner is turned on. A 5 to 10 second total light-up period is satisfactory. If ignition takes longer, consult your Napoleon dealer / distributor.
- Check that the door gasketing is not broken or missing. Replace if necessary.

BLOWER SYSTEM

The Napoleon gas fireplace insert comes standard with a blower, a heat sensor, variable on/off speed control and a power cord. Because the blower is thermally activated, when turned on, it will automatically start approximately 15 minutes after lighting the fireplace and will run for approximately 30 minutes after the fireplace has been turned off. Use of the fan increases the output of heat. Air, drawn in through the lower louvre access door, is driven up the back of the firebox, and exhausted as hot air between the upper louvres.

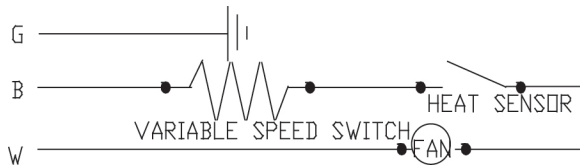

FIGURE 11

Drywall dust will penetrate into blower bearings causing irreparable damage and must be prevented from coming into contact with the blower or its compartment. Any damage resulting from this condition is not covered by the warranty policy.

BLOWER REPLACEMENT INSTRUCTIONS

- Turn off the gas and electric power to the unit.
- Remove the upper glass bracket. Loosen the lower glass bracket and remove the glass.
- Remove the logs.
- Remove the burner assembly.
- Remove the eight screws holding the access door in place on the control assembly (located at the back of the burner support).
- Remove the four screws holding the blower duct and slide it forward from beneath the burner support.
- Disconnect the electrical connectors at the blower.
- Remove the blower.

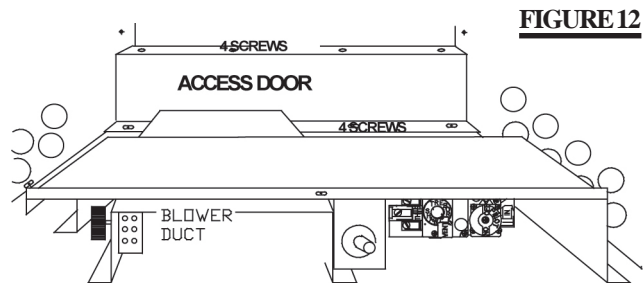

FIGURE 12

ADJUSTMENTS

PILOT BURNER ADJUSTMENT

1. Remove the pilot adjustment cap.
2. Adjust the pilot screw to provide properly sized flame.
3. Replace the adjustment cap.

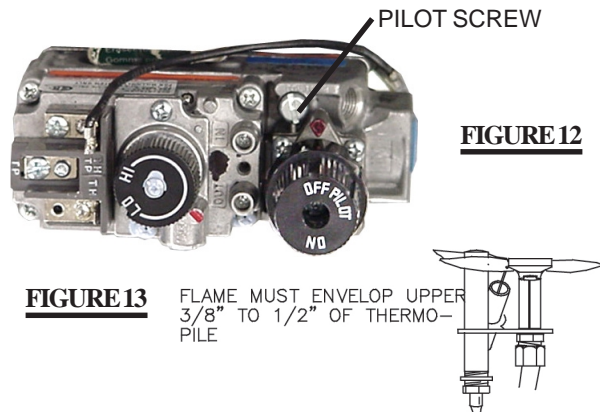

FIGURE 12

FIGURE 13

FLAME MUST ENVELOP UPPER 3/8" TO 1/2" OF THERMO-PILE

VENTURI ADJUSTMENT

Natural gas models have air shutters set at 1/16 (.063") inch open. Propane gas models have air shutters set at 3/16 (.188) inch open. Closing the air shutter will cause a more yellow flame, but can lead to carboning. Opening the air shutter will cause a more blue flame, but can cause flame lifting from the burner ports. The flame may not appear yellow immediately; allow 15 to 30 minutes for the final flame colour to be established.

AIR SHUTTER ADJUSTMENT MUST ONLY BE DONE BY A QUALIFIED GAS INSTALLER!

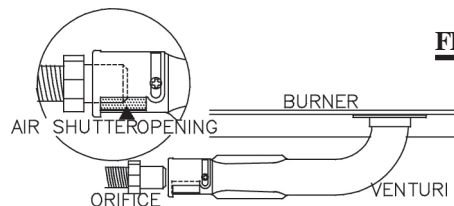

FIGURE 14

REPLACEMENTS

Contact your dealer for questions concerning prices and availability of replacement parts. Normally all parts can be ordered through your Napoleon dealer or distributor.

FOR WARRANTY REPLACEMENT PARTS, A PHOTOCOPY OF THE ORIGINAL INVOICE WILL BE REQUIRED TO HONOUR THE CLAIM.

*** IDENTIFIES ITEMS WHICH ARE NOT ILLUSTRATED. FOR FURTHER INFORMATION, CONTACT YOUR NAPOLEON DEALER.**

When ordering replacement parts always give the following information:

1. MODEL & SERIAL NUMBER OF FIREPLACE
2. INSTALLATION DATE OF FIREPLACE
3. PART NUMBER
4. DESCRIPTION OF PART
5. FINISH

REPLACEMENT PARTS

#	PART #	DESCRIPTION
1	GL-610	LOG SET ASSEMBLY c/w CHARCOAL EMBERS
2	W135-0007	BACK LOG
3	W135-0052	FRONT LOG
4	W135-0015	RIGHT LOG
5	W135-0016	LEFT LOG
6	W135-0009	CENTER LOG
7*	W550-0001	CHARCOAL EMBERS
8*	W385-0245	NAPOLEON LOGO
9	W725-0036	NATURAL GAS VALVE - REMOTE RBT SHAW
9	W725-0037	PROPANE GAS VALVE - REMOTE RBT SHAW
10	W100-0058	PROPANE GAS PILOT ASSEMBLY
10	W100-0057	NATURAL GAS PILOT ASSEMBLY
11	W455-0025	#18 NATURAL GAS PILOT INJECTOR
11	W455-0084	#10 PROPANE GAS PILOT INJECTOR
12	W357-0001	PIEZO IGNITER - CHANNEL
13	W680-0004	THERMOPILE
14	W010-0364	BURNER ASSEMBLY
15	W455-0017	#42 DMS NATURAL GAS BURNER ORIFICE
15	W455-0003	#54 DMS PROPANE GAS BURNER ORIFICE
16	W010-0440	DOOR GLASS w/ TOP GASKET
17*	W562-0012	GLASS GASKET (2 PC - SIDE)
18*	W562-0011	GLASS GASKET (TOP)
19*	W690-0002	THERMAL SENSING SWITCH
20	GZ-552	REPLACEMENT BLOWER
21	KB35	VARIABLE SPEED SWITCH C/W KNOB
22*	W080-0062	UPPER GLASS BRACKET
23*	W080-0079	LOWER GLASS BRACKET
24*	W660-0009	BURNER ON/OFF SWITCH
25*	W660-0006	SPILL SWITCH

ACCESSORIES

#	PART #	DESCRIPTION
FOR OPENINGS SMALLER THAN 27" X 42":		
26	GI-900B6	DELUXE 6" FLASHING KIT - POLISHED BRASS
26	GI-900AB6	DELUXE 6" FLASHING KIT - ANTIQUE BRASS
26	GI-900K6	DELUXE 6" FLASHING KIT - BLACK
26	GI-900SS6	DELUXE 6" FLASHING KIT - STAINLESS STEEL
26	GI-909S6	DELUXE 6" PORCELAIN FLASHING KIT - ALMOND
26	GI-909K6	DELUXE 6" PORCELAIN FLASHING KIT - BLACK
26	GI-909F6	DELUXE 6" PORCELAIN FLASHING KIT - GREEN
FOR OPENINGS SMALLER THAN 30" X 48":		
26	GI-900B9	DELUXE 9" FLASHING KIT - POLISHED BRASS
26	GI-900AB9	DELUXE 9" FLASHING KIT - ANTIQUE BRASS
26	GI-900K9	DELUXE 9" FLASHING KIT - BLACK
26	GI-900SS9	DELUXE 9" FLASHING KIT - STAINLESS STEEL
26	GI-909S9	DELUXE 9" PORCELAIN FLASHING KIT - ALMOND
26	GI-909K9	DELUXE 9" PORCELAIN FLASHING KIT - BLACK
26	GI-909F9	DELUXE 9" PORCELAIN FLASHING KIT - GREEN
FOR OPENINGS SMALLER THAN 28" X 47":		
27	GI-93K	BASIC FLASHING KIT - BLACK
27	GI-93PB	BASIC FLASHING KIT - POLISHED BRASS
28*	GI-92PB	2" TRIM FOR GI-93K
FOR OPENINGS SMALLER THAN 26" X 42":		
27	GI-63K	BASIC FLASHING KIT - BLACK
27	GI-63PB	BASIC FLASHING KIT - POLISHED BRASS
27	GI-63AB	BASIC FLASHING KIT - ANTIQUE BRASS
28*	GI-2PB	2" TRIM FOR GI-63K
PER-TRM		
29*	W470-0002	ENAMEL TOUCH UP AND BRUSH (SPECIFY COLOUR)
30*	W690-0001	MILLIVOLT THERMOSTAT
31*	W660-0011	HANDHELD REMOTE WITH DIGITAL READOUT / THERMOSTATIC
32*	GD660	WALL SWITCH & 20FT WIRE
33	GI-777KT	DECORATIVE BRICK PANELS
34	GI-787KT	DECORATIVE BRICK PANEL FOR BAY DOOR
35	GIBS	BAY SCREEN
36	GIBG	BAY GLASS
37	GI360B-KT	BAY DOOR ASSEMBLY
38	GI-LB36G	BAY WINDOW LOUVRES - GOLD
38	GI-LB36PB	BAY WINDOW LOUVRES - POLISHED BRASS
38	GI-LB36AB	BAY WINDOW LOUVRES - ANTIQUE BRASS
38	GI-LB36K	BAY WINDOW LOUVRES - BLACK
38	GI-LB36SS	BAY WINDOW LOUVRES - STAINLESS STEEL
39	GI-1LG	GOLD PLATED LOUVRES UPPER & LOWER
39	GI-1LK	FLUSH LOUVRES & DOOR TRIM - BLACK
39	GI-1LPB	FLUSH LOUVRES & DOOR TRIM - POLISHED BRASS
39	GI-1LAB	FLUSH LOUVRES & DOOR TRIM - ANTIQUE BRASS
39	GI-1LSS	FLUSH LOUVRES & DOOR TRIM - STAINLESS STEEL
40*	W175-0172	NG TO LP CONVERSION KIT
40*	W175-0191	LP TO NG CONVERSION KIT

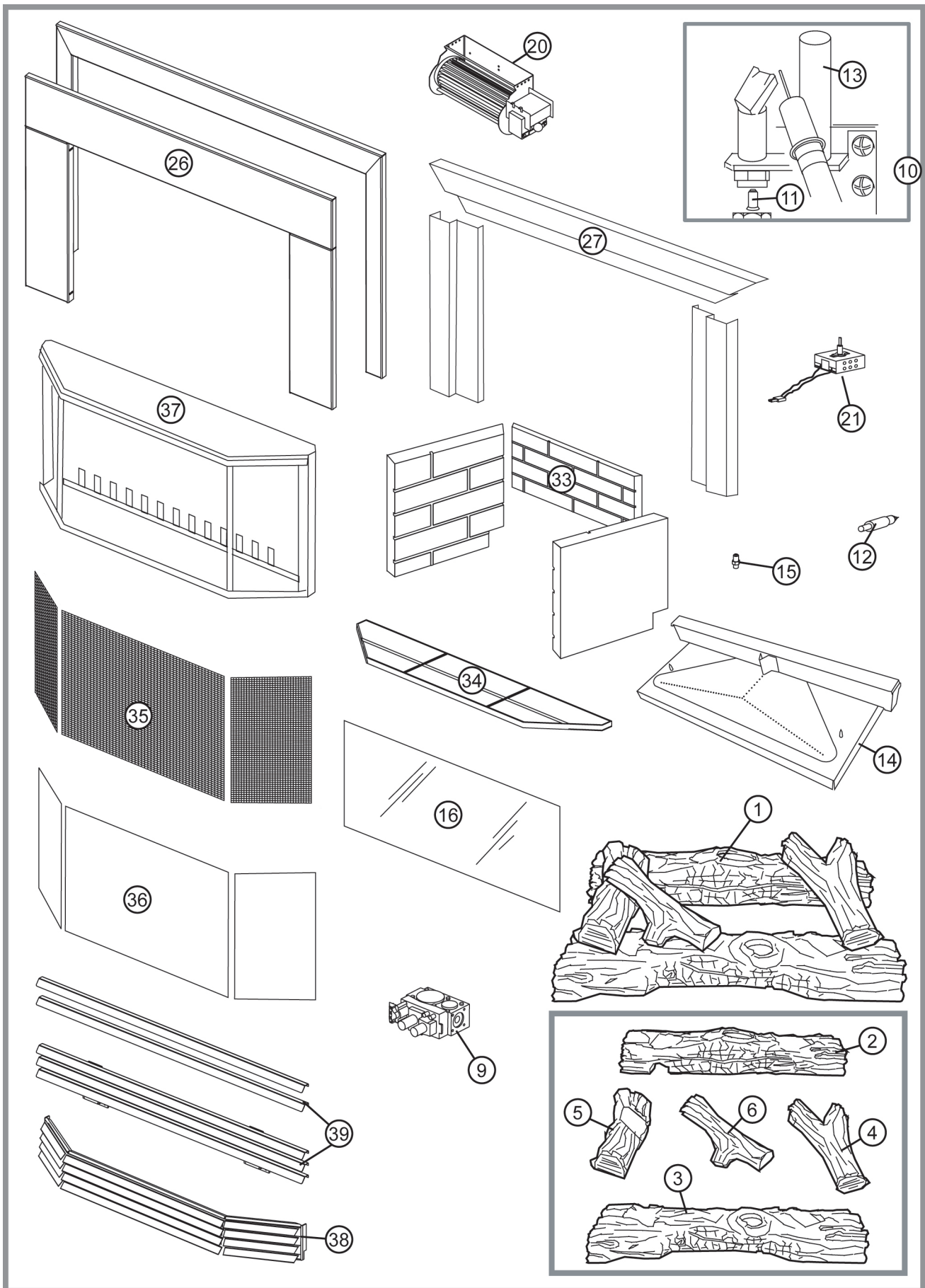

TROUBLE SHOOTING GUIDE

BEFORE ATTEMPTING TO TROUBLESHOOT, PURGE YOUR UNIT AND INITIALLY LIGHT THE PILOT AND THE MAIN BURNER WITH THE GLASS DOOR REMOVED.

SYMPTOM	PROBLEM	TEST SOLUTION
Pilot goes out when the gas knob is released.	System is not correctly purged.	- purge the gas line with the glass door removed.
	Out of propane gas.	- fill the tank.
	Pilot flame is not large enough	- turn up the pilot flame.
	Pilot flame is not engulfing the thermopile.	- gently twist the pilot head to improve the flame pattern around the thermopile.
	Thermopile shorting.	- clean thermopile and valve connection. - check that thermopile insulation is not frayed and grounding out on the housing or the burner support. - replace thermopile. - replace valve.
	Faulty thermopile.	- replace.
Pilot will not light.	Faulty valve.	- replace.
	No spark at pilot burner	- check that the wire is connected to the push button ignitor. - check if the push button ignitor needs tightening. - replace pilot assembly if the wire insulation is broken or frayed. - replace pilot assembly if the ceramic insulator is cracked or broken. - replace the push button ignitor.
	Spark gap is incorrect	- spark gap should be 1/16" to 1/8" from the electrode tip and the pilot burner. Light the pilot with a match and adjust the electrode tip to the required spark gap and proper location.
	No gas at the pilot burner	- check that the manual valve is turned on. - check the pilot orifice for blockage. - replace the valve. - call the gas distributor.
	Out of propane gas	- fill the tank.
	Pilot goes out while standing; Main burner is in 'OFF' position.	Gas piping is undersized.
Pilot burning; no gas to main burner; gas knob is on; wall switch is on.		Wall switch is defective
	Wall switch wiring is defective.	- disconnect the switch wires from the valve & connect a jumper wire across terminals 1 and 3; if the main burner lights, check the wires for defects and/or replace wires.
	Main burner orifice is plugged.	- remove stoppage in orifice.
	Remote gas valve operator is defective.	- connect a jumper wire across terminals 1 and 3; if main burner does not light, replace gas valve.
Main burner flame is a blue, lazy, transparent flame.	Insufficient secondary air.	- increase fresh air supply (open door, window, add make-up air supply)
	Downdraft or blockage in chimney.	- remove blockage. - check that chimney is installed to building codes (3ft above highest roof line or 2ft higher than any portion of a building within a horizontal radius of 10ft of the chimney.)

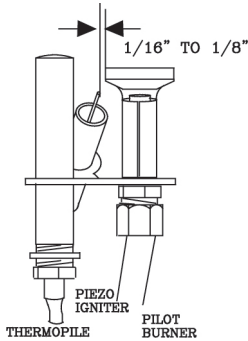

SYMPTOM	PROBLEM	TEST SOLUTION
Main burner goes out; pilot goes out.	Refer to "Main burner goes out; pilot stays on"	
	Chimney down-drafting	- wait ten minutes. Shut off all exhaust fans in the house (ie: kitchen and bathrooms), furnace, and clothes dryer. Open windows and/or doors. Start fireplace and monitor its operation. Close doors and windows and start appliances as before; room is in negative pressure; increase fresh air supply.
	Chimney is blocked	- check for chimney blockage.
	Liner disconnected from insert.	- re-attach liner.
	Faulty spill switch.	- replace.
Main burner goes out; pilot stays on.	Pilot flame is not large enough or not engulfing the thermopile.	- turn on pilot flame. Gently twist the pilot head to improve the flame pattern around the thermopile.
	Thermopile shorting.	- clean thermopile and thermopile connection to valve.
Carbon is being deposited on glass, logs or combustion chamber surfaces.	Air shutter has become blocked	- ensure air shutter opening is free of lint or other obstructions.
	Flame is impinging on the logs or combustion chamber.	- check that the logs are correctly positioned. - open air shutter to increase the primary air. - check the input rate: check the manifold pressure and orifice size as specified by the rating plate values. - check that the door gasketing is not broken or missing and that the seal is tight. - check that both 4" and 7" vent liners are free of holes and well sealed at all joints. - check that minimum rise per foot has been adhered to for any horizontal venting.
Remote wall switch is in off position; main burner comes on when gas knob is turned to "ON" position.	Wall switch is mounted upside down.	- reverse.
	Remote wall switch is grounding.	- replace.
	Remote wall switch wire is grounding.	- check for ground (short); repair ground or replace wire.
	Faulty valve.	- replace.
Exhaust fumes smelled in room, headaches.	Fireplace is spilling.	- check for chimney blockage. - check that chimney is installed to building code. - room is in negative pressure; increase fresh air supply.
Carbon is being deposited on glass, logs or combustion chamber surfaces.	Flame is impinging on the logs or combustion chamber.	- check that the logs are correctly positioned. - open air shutter to increase the primary air. - check the input rate: check the manifold pressure and orifice size as specified by the rating plate values.
White / grey film forms.	Sulphur from fuel is being deposited on glass, logs or combustion chamber surfaces.	- clean the glass with a recommended gas fireplace glass cleaner. DO NOT CLEAN GLASS WHEN HOT. If deposits are not cleaned off regularly, the glass may become permanently marked.

Free Manuals Download Website

<http://myh66.com>

<http://usermanuals.us>

<http://www.somanuals.com>

<http://www.4manuals.cc>

<http://www.manual-lib.com>

<http://www.404manual.com>

<http://www.luxmanual.com>

<http://aubethermostatmanual.com>

Golf course search by state

<http://golfingnear.com>

Email search by domain

<http://emailbydomain.com>

Auto manuals search

<http://auto.somanuals.com>

TV manuals search

<http://tv.somanuals.com>