

Nikon

DIGITAL CAMERA

COOLPIX L340



Reference Manual

En

Introduction	⇒ i
Table of Contents	⇒ x
Parts of the Camera	⇒ 1
Preparing for Shooting	⇒ 6
Basic Shooting and Playback Operations	⇒ 12
Shooting Features	⇒ 22
Playback Features	⇒ 45
Recording and Playing Back Movies	⇒ 52
Using Menus	⇒ 58
Connecting the Camera to a TV, Printer, or Computer	⇒ 85
Technical Notes	⇒ 94

Introduction

Read This First

To get the most from this Nikon product, be sure to read “For Your Safety” (📖v-vii), and all other instructions thoroughly and keep them where they will be read by all who use the camera.

- If you want to start using the camera right away, see “Preparing for Shooting” (📖6) and “Basic Shooting and Playback Operations” (📖12).

Other Information

- Symbols and Conventions

Symbol	Description
☑	This icon marks cautions and information that should be read before using the camera.
📝	This icon marks notes and information that should be read before using the camera.
📖	This icon marks other pages containing relevant information.

- SD, SDHC, and SDXC memory cards are referred to as “memory cards” in this manual.
- The setting at the time of purchase is referred to as the “default setting.”
- The names of menu items displayed in the camera monitor, and the names of buttons or messages displayed on a computer monitor appear in bold.
- In this manual, images are sometimes omitted from monitor display samples so that monitor indicators can be more clearly shown.

Information and Precautions

Life-Long Learning

As part of Nikon's "Life-Long Learning" commitment to ongoing product support and education, continually updated information is available online at the following websites:

- For users in the U.S.A.: <http://www.nikonusa.com/>
- For users in Europe and Africa: <http://www.europe-nikon.com/support/>
- For users in Asia, Oceania, and the Middle East: <http://www.nikon-asia.com/>

Visit these websites to keep up-to-date with the latest product information, tips, answers to frequently asked questions (FAQs), and general advice on digital imaging and photography. Additional information may be available from the Nikon representative in your area. Visit the website below for contact information.

<http://imaging.nikon.com/>

Use Only Nikon Brand Electronic Accessories

Nikon COOLPIX cameras are designed to the highest standards and include complex electronic circuitry. Only Nikon brand electronic accessories (including battery chargers, batteries, and AC adapters) certified by Nikon specifically for use with this Nikon digital camera are engineered and proven to operate within the operational and safety requirements of this electronic circuitry.

THE USE OF NON-NIKON ELECTRONIC ACCESSORIES COULD DAMAGE THE CAMERA AND MAY VOID YOUR NIKON WARRANTY.

For more information about Nikon brand accessories, contact a local authorized Nikon dealer.

Before Taking Important Pictures

Before taking pictures on important occasions (such as at weddings or before taking the camera on a trip), take a test shot to ensure that the camera is functioning normally. Nikon will not be held liable for damages or lost profits that may result from product malfunction.

About the Manuals

- No part of the manuals included with this product may be reproduced, transmitted, transcribed, stored in a retrieval system, or translated into any language in any form, by any means, without Nikon's prior written permission.
- Illustrations and monitor content shown in this manual may differ from the actual product.
- Nikon reserves the right to change the specifications of the hardware and software described in these manuals at any time and without prior notice.
- Nikon will not be held liable for any damages resulting from the use of this product.
- While every effort was made to ensure that the information in these manuals is accurate and complete, we would appreciate it were you to bring any errors or omissions to the attention of the Nikon representative in your area (address provided separately).

Notice Concerning Prohibition of Copying or Reproduction

Note that simply being in possession of material that was digitally copied or reproduced by means of a scanner, digital camera or other device may be punishable by law.

• Items prohibited by law from being copied or reproduced

Do not copy or reproduce paper money, coins, securities, government bonds or local government bonds, even if such copies or reproductions are stamped "Sample." The copying or reproduction of paper money, coins, or securities which are circulated in a foreign country is prohibited. Unless the prior permission of the government was obtained, the copying or reproduction of unused postage stamps or post cards issued by the government is prohibited.

The copying or reproduction of stamps issued by the government and of certified documents stipulated by law is prohibited.

• Cautions on certain copies and reproductions

The government has issued cautions on copies or reproductions of securities issued by private companies (shares, bills, checks, gift certificates, etc.), commuter passes, or coupon tickets, except when a minimum of necessary copies are to be provided for business use by a company. Also, do not copy or reproduce passports issued by the government, licenses issued by public agencies and private groups, ID cards and tickets, such as passes and meal coupons.

• Comply with copyright notices

The copying or reproduction of copyrighted creative works such as books, music, paintings, woodcut prints, maps, drawings, movies, and photographs is governed by national and international copyright laws. Do not use this product for the purpose of making illegal copies or to infringe copyright laws.

Disposing of Data Storage Devices

Please note that deleting images or formatting data storage devices such as memory cards or built-in camera memory does not completely erase the original image data. Deleted files can sometimes be recovered from discarded storage devices using commercially available software, potentially resulting in the malicious use of personal image data. Ensuring the privacy of such data is the user's responsibility.

Before discarding a data storage device or transferring ownership to another person, erase all data using commercial deletion software, or format the device and then completely refill it with images containing no private information (for example, images of empty sky). Care should be taken to avoid injury or damage to property when physically destroying data storage devices.

For Your Safety

To prevent damage to your Nikon product or injury to yourself or to others, read the following safety precautions in their entirety before using this equipment. Keep these safety instructions where all those who use the product will read them.



This icon marks warnings, information that should be read before using this Nikon product, to prevent possible injury.

WARNINGS

Turn off in the event of malfunction

Should you notice smoke or an unusual smell coming from the camera or AC adapter, unplug the AC adapter and remove the batteries immediately, taking care to avoid burns. Continued operation could result in injury. After removing or disconnecting the power source, take the equipment to a Nikon-authorized service representative for inspection.

Do not disassemble

Touching the internal parts of the camera or AC adapter could result in injury. Repairs should be performed only by qualified technicians. Should the camera or AC adapter break open as the result of a fall or other accident, take the product to a Nikon-authorized service representative for inspection, after unplugging the product and/or removing the batteries.

Do not use the camera or AC adapter in the presence of flammable gas

Do not use electronic equipment in the presence of flammable gas, as this could result in explosion or fire.

Handle the camera strap with care

Never place the strap around the neck of an infant or child.

Keep out of reach of children

Particular care should be taken to prevent infants from putting the batteries or other small parts into their mouths.

Do not remain in contact with the camera, battery charger, or AC adapter for extended periods while the devices are on or in use

Parts of the devices become hot. Leaving the devices in direct contact with the skin for extended periods may result in low-temperature burns.

⚠ Do not leave the product where it will be exposed to extremely high temperatures, such as in an enclosed automobile or in direct sunlight

Failure to observe this precaution could cause damage or fire.

⚠ Observe caution when handling batteries

Batteries may leak or explode if improperly handled. Observe the following precautions when handling batteries for use in this product:

- Before replacing the batteries, turn the product off. If you are using an AC adapter, be sure it is unplugged.
- Use only the batteries approved for use in this product (📖7). Do not combine old and new batteries or batteries of different makes or types.
- When charging Nikon EN-MH2 rechargeable Ni-MH batteries, use only the specified charger and charge the batteries four at a time. When replacing the batteries with EN-MH2-B2 batteries (available separately), purchase two sets (total of four batteries).
- The EN-MH2 rechargeable batteries are for use with Nikon digital cameras only, and are compatible with COOLPIX L340.
- Insert batteries in the correct orientation.
- Do not short or disassemble batteries or attempt to remove or break battery insulation or casing.
- Do not expose batteries to flame or to excessive heat.
- Do not immerse in or expose to water.
- Do not transport or store with metal objects such as necklaces or hairpins.
- Batteries are prone to leakage when fully discharged. To avoid damage to the product, be sure to remove the batteries when no charge remains.
- Discontinue use immediately should you notice any change in the batteries, such as discoloration or deformation.
- If liquid from damaged batteries comes in contact with clothing or skin, rinse immediately with plenty of water.

⚠ Observe the following precautions when handling the Battery Chargers (available separately)

- Keep dry. Failure to observe this precaution could result in fire or electric shock.
- Dust on or near the metal parts of the plug should be removed with a dry cloth. Continued use could result in fire.
- Do not handle the power cable or go near the battery charger during lightning storms. Failure to observe this precaution could result in electric shock.
- Do not damage, modify, forcibly tug or bend the power cable, place it under heavy objects, or expose it to heat or flames. Should the insulation be damaged and the wires become exposed, take it to a Nikon-authorized service representative for inspection. Failure to observe these precautions could result in fire or electric shock.

- Do not handle the plug or battery charger with wet hands. Failure to observe this precaution could result in electric shock.
- Do not use with travel converters or adapters designed to convert from one voltage to another or with DC-to-AC inverters. Failure to observe this precaution could damage the product or cause overheating or fire.

 **Use appropriate cables**

When connecting cables to the input and output jacks, use only the cables provided or sold by Nikon for the purpose, to maintain compliance with product regulations.

 **Do not touch the moving parts of the lens**

Failure to observe this precaution could result in injury.

 **Handle moving parts with care**

Be careful that your fingers or other objects are not pinched by the lens cover or other moving parts.

 **Using the flash close to your subject's eyes could cause temporary visual impairment**

The flash should be no less than 1 meter (3 ft 4 in.) from the subject. Particular care should be observed when photographing infants.

 **Do not operate the flash with the flash window touching a person or object**

Failure to observe this precaution could result in burns or fire.

 **Avoid contact with liquid crystal**

Should the monitor break, care should be taken to avoid injury caused by broken glass and to prevent liquid crystal from the monitor touching the skin or entering the eyes or mouth.

 **Follow the instructions of airline and hospital personnel**

Notices

Notices for Customers in the U.S.A.

Federal Communications Commission (FCC) Radio Frequency Interference Statement

This equipment has been tested and found to comply with the limits for a Class B digital device, pursuant to Part 15 of the FCC rules. These limits are designed to provide reasonable protection

against harmful interference in a residential installation. This equipment generates, uses, and can radiate radio frequency energy and, if not installed and used in accordance with the instructions, may cause harmful interference to radio communications. However, there is no guarantee that interference will not occur in a particular installation. If this equipment does cause harmful interference to radio or television reception, which can be determined by turning the equipment off and on, the user is encouraged to try to correct the interference by one or more of the following measures:

- Reorient or relocate the receiving antenna.
- Increase the separation between the equipment and receiver.
- Connect the equipment into an outlet on a circuit different from that to which the receiver is connected.
- Consult the dealer or an experienced radio/television technician for help.



CAUTIONS

Modifications

The FCC requires the user to be notified that any changes or modifications made to this device that are not expressly approved by Nikon Corporation may void the user's authority to operate the equipment.

Interface Cables

Use the interface cables sold or provided by Nikon for your equipment. Using other interface cables may exceed the limits of Class B Part 15 of the FCC rules.

Notice for Customers in the State of California

WARNING

Handling the cord on this product will expose you to lead, a chemical known to the State of California to cause birth defects or other reproductive harm.

Wash hands after handling.

Nikon Inc.,

1300 Walt Whitman Road, Melville, New York 11747-3064, U.S.A.

Tel: 631-547-4200

Notice for Customers in Canada

CAN ICES-3 B / NMB-3 B

Notices for Customers in Europe

This symbol indicates that electrical and electronic equipment is to be collected separately.

The following apply only to users in European countries:

- This product is designated for separate collection at an appropriate collection point. Do not dispose of as household waste.
- Separate collection and recycling helps conserve natural resources and prevent negative consequences for human health and the environment that might result from incorrect disposal.
- For more information, contact the retailer or the local authorities in charge of waste management.



This symbol on the batteries indicates that the batteries are to be collected separately.

The following apply only to users in European countries:

- All batteries, whether marked with this symbol or not, are designated for separate collection at an appropriate collection point. Do not dispose of as household waste.
- For more information, contact the retailer or the local authorities in charge of waste management.





Table of Contents

Introduction	i
Read This First	i
Other Information.....	i
Information and Precautions.....	ii
For Your Safety	v
WARNINGS	v
Notices	viii

Parts of the Camera	1
The Camera Body.....	1
The Monitor	3
Shooting Mode	3
Playback Mode	5

Preparing for Shooting.....	6
Attaching the Camera Strap and Lens Cap	6
Insert the Batteries and Memory Card	7
Applicable Batteries.....	7
Removing the Batteries or Memory Card	8
Memory Cards and Internal Memory.....	8
Turn the Camera On and Set the Display Language, Date, and Time	9
Raising and Lowering the Flash.....	11

Basic Shooting and Playback Operations	12
Shooting with Scene Auto Selector Mode.....	12
Using the Zoom.....	14
The Shutter-release Button.....	15
Play Back Images.....	16
Delete Images	17
Changing the Shooting Mode	19
Using the Flash, Self-timer, Etc.....	20
Recording Movies	21

Shooting Features	22
 (Scene Auto Selector) Mode.....	22
Scene Mode (Shooting Suited to Scenes)	23
Tips and Notes.....	24
Shooting with Panorama Assist.....	26
Playback with Panorama Assist.....	28
Special Effects Mode (Applying Effects When Shooting)	29
Smart Portrait Mode (Capturing Images of Smiling Faces)	30
 (Auto) Mode.....	31
Flash Mode.....	32
Self-timer.....	34
Macro Mode (Taking Close-up Pictures).....	35
Exposure Compensation (Adjusting Brightness).....	36
Default Settings (Flash, Self-timer, Etc.).....	37
Focusing	39
Using Face Detection.....	39
Using Skin Softening.....	40
Using Target Finding AF.....	41
Subjects Not Suitable for Autofocus.....	42
Focus Lock.....	43
Functions That Cannot Be Used Simultaneously When Shooting	44
Playback Features	45
Playback Zoom.....	45
Thumbnail Playback/Calendar Display.....	46
Editing Images (Still Images)	47
Before Editing Images.....	47
Quick Effects: Changing Hue or Mood.....	47
D-Lighting: Enhancing Brightness and Contrast.....	48
Skin Softening: Softening Skin Tones.....	49
Small Picture: Reducing the Size of an Image.....	50
Crop: Creating a Cropped Copy.....	51
Recording and Playing Back Movies	52
Operations During Movie Playback.....	55
Editing Movies.....	56

Using Menus.....	58
The Shooting Menu (for  (Auto) Mode).....	60
Image Mode (Image Size and Quality).....	60
White Balance (Adjusting Hue).....	62
Continuous Shooting.....	64
ISO Sensitivity.....	65
AF Area Mode.....	66
The Smart Portrait Menu.....	67
Skin Softening.....	67
Smile Timer.....	67
Blink Proof.....	68
The Playback Menu.....	69
Slide Show.....	69
Protect.....	70
Rotate Image.....	70
Copy (Copy Between the Memory Card and Internal Memory).....	71
The Image Selection Screen.....	72
The Movie Menu.....	73
Movie Options.....	73
Autofocus Mode.....	73
Wind Noise Reduction.....	74
The Setup Menu.....	75
Time Zone and Date.....	75
Monitor Settings.....	77
Date Stamp.....	79
Vibration Reduction.....	80
AF Assist.....	80
Sound Settings.....	81
Auto Off.....	81
Format Card/Format Memory.....	82
Language.....	83
Video Mode.....	83
Reset All.....	84
Battery Type.....	84
Firmware Version.....	84

Connecting the Camera to a TV, Printer, or Computer	85
Connecting the Camera to a TV (Playback on a TV)	87
Connecting the Camera to a Printer (Direct Print)	88
Connecting the Camera to a Printer	88
Printing Images One at a Time	89
Printing Multiple Images	90
Using ViewNX 2 (Transferring Images to a Computer)	92
Installing ViewNX 2	92
Transferring Images to a Computer	92

Technical Notes	94
Caring for the Product	95
The Camera	95
Batteries.....	96
Memory Cards.....	97
Cleaning and Storage	98
Cleaning	98
Storage	98
Error Messages	99
Troubleshooting	102
File Names	108
Optional Accessories	109
Specifications	110
Approved Memory Cards.....	113
Index	115



A series of horizontal dashed lines spanning the width of the page, intended for handwriting practice.

Parts of the Camera

The Camera Body

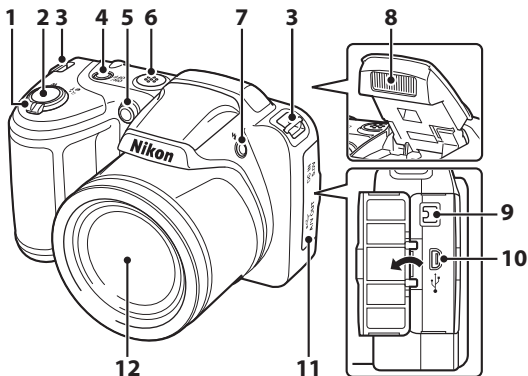

1	Zoom control..... 14	6	Speaker
	W : Wide-angle..... 14	7	⚡ (flash pop-up) button..... 11, 32
	T : Telephoto..... 14	8	Flash..... 11, 32
	🖼️ : Thumbnail playback..... 46	9	DC input connector (for connection with optional AC adapter)..... 109
	🔍 : Playback zoom..... 45	10	USB/audio/video output connector..... 85
	❓ : Help 23	11	Connector cover 85
2	Shutter-release button..... 13	12	Lens
3	Eyelet for camera strap..... 6		
4	Power switch/power-on lamp..... 9		
5	Self-timer lamp 34		
	AF-assist illuminator		

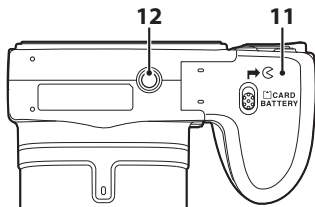
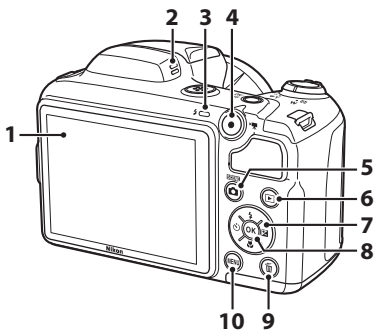

1 Monitor	3	7 Multi selector	58
2 Microphone		8 (apply selection) button	58
3 Flash lamp.....	33	9 (delete) button	17
4 (movie-record) button.....	52	10 MENU (menu) button.....	58
5 (shooting mode) button	22, 23, 29, 30, 31	11 Battery-chamber/ memory card slot cover	7
6 (playback) button	16	12 Tripod socket	112

The Monitor

The information that is displayed in the monitor during shooting and playback changes depending on the camera's settings and state of use.

By default, information is displayed when the camera is turned on and when you operate the camera, and turns off after a few seconds (when **Photo info** is set to **Auto info** in **Monitor settings** (📖77)).

Shooting Mode

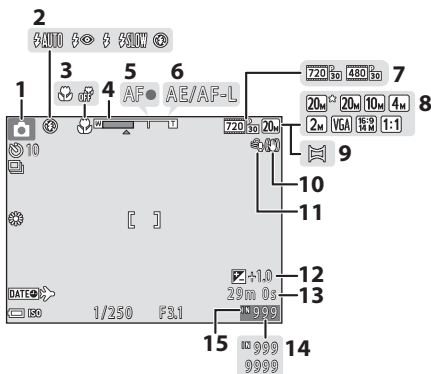

1	Shooting mode 19, 22, 23, 29, 30, 31
2	Flash mode 32
3	Macro mode 35
4	Zoom indicator 14, 35
5	Focus indicator 13
6	AE/AF-L indicator 27
7	Movie options 73
8	Image mode 60

9	Panorama assist 26
10	Vibration reduction icon 80
11	Wind noise reduction 74
12	Exposure compensation value ... 36
13	Remaining movie recording time 52
14	Number of exposures remaining (still images) 10
15	Internal memory indicator 10

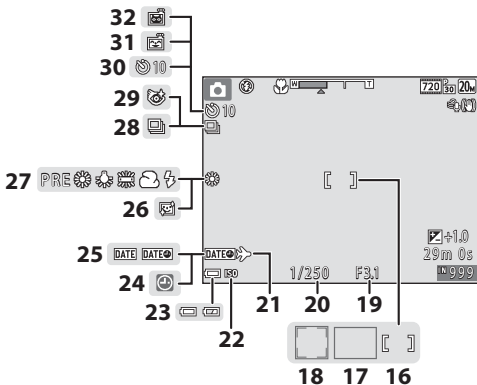

16	Focus area (center).....	43, 66	24	“Date not set” indicator	103
17	Focus area (target finding AF)	41, 66	25	Date stamp.....	79
18	Focus area (face detection, pet detection).....	25, 30, 39	26	Skin softening.....	67
19	Aperture value.....	15	27	White balance mode.....	62
20	Shutter speed	15	28	Continuous shooting mode	25, 64
21	Travel destination icon.....	75	29	Blink proof icon.....	68
22	ISO sensitivity.....	65	30	Self-timer indicator.....	34
23	Battery level indicator.....	10	31	Smile timer	67
			32	Pet portrait auto release.....	25

Playback Mode

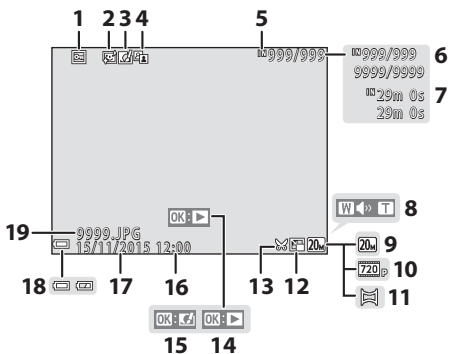

1	Protect icon.....	70	11	Panorama assist.....	28
2	Skin softening icon.....	49	12	Small picture icon	50
3	Quick effects icon.....	47	13	Crop icon.....	45, 51
4	D-Lighting icon.....	48	14	Movie playback guide Panorama assist playback guide	
5	Internal memory indicator		15	Quick effects guide	
6	Current image number/ total number of images		16	Time of recording	
7	Movie length or elapsed playback time		17	Date of recording	
8	Volume indicator.....	55	18	Battery level indicator.....	10
9	Image mode.....	60	19	File number and type	108
10	Movie options.....	73			

Preparing for Shooting

Attaching the Camera Strap and Lens Cap

Attach the lens cap to the camera strap, and then attach the strap to the camera.

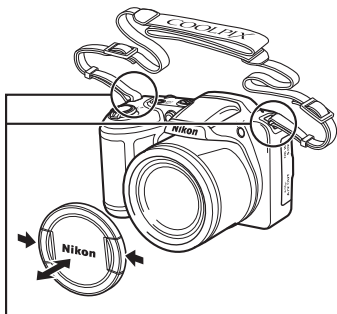
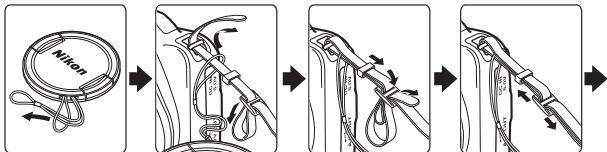

Attach them at two places.

Lens Cap

When the camera is not in use, protect the lens by attaching the lens cap.

Insert the Batteries and Memory Card

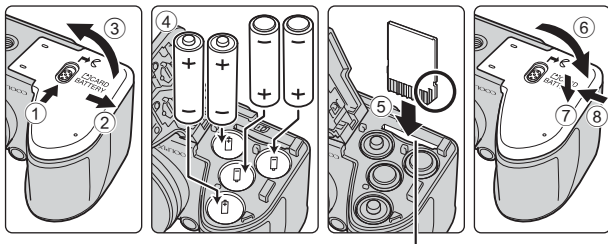

Memory card slot

- Hold the camera upside down to prevent the batteries from falling out, confirm that the positive (+) and negative (-) terminals of the batteries are oriented correctly, and insert the batteries.
- Slide the memory card in until it clicks into place (5).
- Be careful not to insert the batteries or memory card upside-down or backward, as this could cause a malfunction.
- When closing the cover, slide it while securely holding down the area marked (7).

Formatting a Memory Card

The first time you insert a memory card that has been used in another device into this camera, make sure to format it with this camera. Insert the memory card into the camera, press the **MENU** button, and select **Format card** in the setup menu (58).

Applicable Batteries

- Four LR6/L40 (AA-size) alkaline batteries (included batteries)
- Four FR6/L91 (AA-size) lithium batteries
- Four EN-MH2 rechargeable Ni-MH (nickel metal hydride) batteries
- * EN-MH1 rechargeable Ni-MH batteries cannot be used.

✓ Notes About the Batteries

- Do not combine old and new batteries or batteries of different makes or types.
- Batteries with the following defects cannot be used:

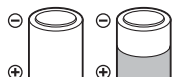

Batteries with peeling



Batteries with insulation that does not cover the area around the negative terminal

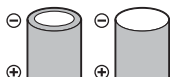

Batteries with a flat negative terminal

✓ Notes About EN-MH2 Rechargeable Ni-MH Batteries

When using EN-MH2 batteries with the camera, charge four batteries at a time using Battery Charger MH-73 (p.96).

🔪 Alkaline Batteries

Performance of alkaline batteries may vary greatly depending on the manufacturer.

Removing the Batteries or Memory Card

Turn the camera off and make sure that the power-on lamp and monitor have turned off, and then open the battery-chamber/memory card slot cover.

- Gently push the memory card into the camera to partially eject the memory card.
- Be careful when handling the camera, batteries, and memory card immediately after using the camera, as they may become hot.

Memory Cards and Internal Memory

Camera data, including images and movies, can be saved either on a memory card or in the camera's internal memory. To use the camera's internal memory, remove the memory card.

Turn the Camera On and Set the Display Language, Date, and Time

When the camera is turned on for the first time, the language-selection screen and the date and time setting screen for the camera clock are displayed.

- 1 Remove the lens cap, and then press the power switch to turn on the camera.

- The monitor turns on.
- To turn the camera off, press the power switch again.

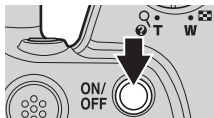

- 2 Use the multi selector ▲▼ to select the desired language and press the **OK** button.

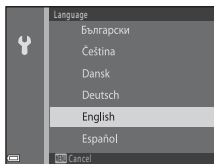

- 3 Select **Yes** and press the **OK** button.

- 4 Select your home time zone and press the **OK** button.

- Press ▲ to display ☀ above the map and enable daylight saving time. Press ▼ to disable it.

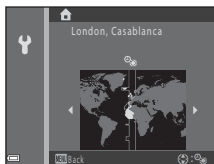

- 5 Use ▲▼ to select the date format and press the **OK** button.

6 Set the date and time, and press the **OK** button.

- Use **◀▶** to select a field and then use **▲▼** to set the date and time.
- Select the minute field and press the **OK** button to confirm the setting.

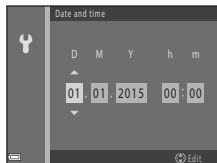

7 When the confirmation dialog is displayed, use **▲▼** to select **Yes** and press the **OK** button.

8 Press the **📷** (shooting mode) button.

- The lens extends.

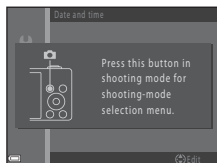

9 Select **Scene auto selector** and press the **OK** button.

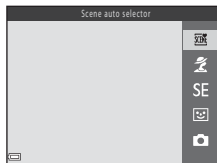







- The shooting screen is displayed, and you can take pictures in scene auto selector mode. The camera automatically selects the optimum scene mode.
- Battery level indicator
 - : The battery level is high.
 - : The battery level is low.
- Number of exposures remaining is displayed when no memory card is inserted in the camera, and images are saved in the internal memory.



Battery level indicator

Number of exposures remaining

Changing the Language or the Date and Time Setting

- You can change these settings using the **Language** and **Time zone and date** settings in the  setup menu (58).
- You can enable or disable daylight saving time in the  setup menu by selecting **Time zone and date** followed by **Time zone**. Press the multi selector  and then  to enable daylight saving time and move the clock forward one hour, or  to disable daylight saving time and move the clock back one hour.

The Clock Battery

- The camera's clock is powered by a built-in backup battery. The backup battery charges when the main batteries are inserted into the camera or when the camera is connected to an optional AC adapter, and it can run the clock for several days after about 10 hours of charging.
- If the camera's backup battery becomes exhausted, the date and time setting screen is displayed when the camera is turned on. Set the date and time again (9).

Raising and Lowering the Flash

Press the  (flash pop-up) button to raise the flash.

- Push the flash down gently to lower the flash until it clicks into place when not in use.

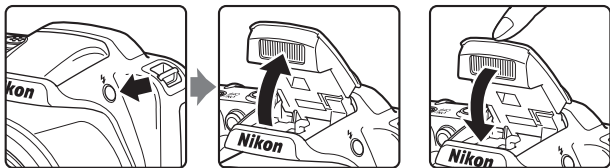

Basic Shooting and Playback Operations

Shooting with Scene Auto Selector Mode

1 Hold the camera steady.

- Keep fingers and other objects away from the lens, flash, AF-assist illuminator, microphone, and speaker.

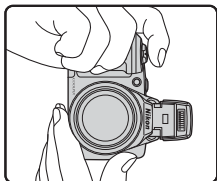
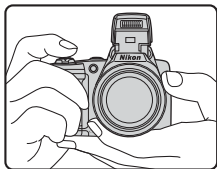

2 Frame the picture.

- Move the zoom control to change the zoom lens position.
- When the camera recognizes the shooting scene, the shooting mode icon changes accordingly.

Zoom out Zoom in



Shooting mode icon

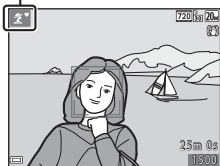

3 Press the shutter-release button halfway.

- When the subject is in focus, the focus area or focus indicator is displayed in green.
- When you are using digital zoom, the camera focuses in the center of the frame and the focus area is not displayed.
- If the focus area or focus indicator flashes, the camera is unable to focus. Modify the composition and try pressing the shutter-release button halfway again.

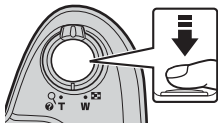

4 Without lifting your finger, press the shutter-release button the rest of the way down.



Notes About Saving Images or Movies

The indicator showing the number of exposures remaining or the indicator showing the remaining recording time flashes while images or movies are being saved. **Do not open the battery-chamber/memory card slot cover or remove the batteries or memory card** while an indicator is flashing. Doing this could result in loss of data, or in damage to the camera or the memory card.

The Auto Off Function

- When no operations are performed for about 30 seconds, the monitor turns off, the camera enters standby mode, and then the power-on lamp flashes. The camera turns off after remaining in standby mode for about three minutes.
- To turn the monitor back on while the camera is in standby mode, perform an operation such as pressing the power switch or shutter-release button.

When Using a Tripod

- We recommend using a tripod to stabilize the camera in the following situations:
 - When the flash is lowered in dark locations or when using a shooting mode in which the flash does not fire
 - When the zoom is at a telephoto position
- When using a tripod to stabilize the camera during shooting, set **Vibration reduction to Off** in the setup menu (📖58) to prevent potential errors caused by this function.

Using the Zoom

When you move the zoom control, the zoom lens position changes.

- To zoom in: Move toward **T**
- To zoom out: Move toward **W**

When you turn the camera on, the zoom moves to the maximum wide-angle position.

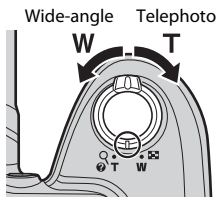

- A zoom indicator is displayed on the shooting screen when the zoom control is moved.
- Digital zoom, which allows you to further magnify the subject up to approximately 4x the maximum optical zoom ratio, can be activated by moving and holding the zoom control toward **T** when the camera is zoomed in to the maximum optical zoom position.

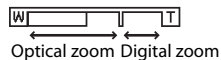



Digital Zoom

The zoom indicator changes to blue when the digital zoom is activated, and it changes to yellow when the zoom magnification is increased further.

- Zoom indicator is blue: Image quality is not noticeably reduced by using the Dynamic Fine Zoom.
- Zoom indicator is yellow: There may be cases in which image quality is noticeably reduced.
- The indicator remains blue across a wider area when the image size is smaller.

The Shutter-release Button

<p>Press halfway</p> 	<p>To set focus and exposure (shutter speed and aperture value), press the shutter-release button lightly until you feel a slight resistance. Focus and exposure remain locked while the shutter-release button is pressed halfway.</p>
<p>Press all the way</p> 	<p>Press the shutter-release button all the way to release the shutter and take a picture. Do not use force when pressing the shutter-release button, as this may result in camera shake and blurred images. Press the button gently.</p>





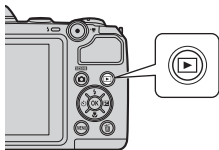

Play Back Images

1 Press the  (playback) button to enter playback mode.

- If you press and hold down the  button while the camera is turned off, the camera turns on in playback mode.



2 Use the multi selector to select an image to display.

- Press and hold down    to scroll through the images quickly.
- To return to shooting mode, press the  button or shutter-release button.
- When  is displayed in full-frame playback mode, you can press the  button to apply an effect to the image.

Display the previous image



Display the next image

- Move the zoom control toward **T** () in full-frame playback mode to zoom in on an image.





- In full-frame playback mode, move the zoom control toward **W** () to switch to thumbnail playback mode and display multiple images on the screen.



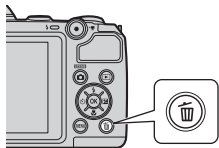

Delete Images

- 1 Press the  (delete) button to delete the image currently displayed in the monitor.

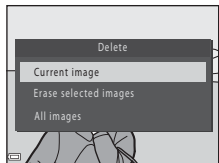

- 2 Use the multi selector   to select the desired deletion method and press the  button.
 - To exit without deleting, press the **MENU** button.



- 3 Select **Yes** and press the  button.
 - Deleted images cannot be recovered.

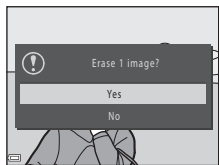

Deleting the Image Captured While in Shooting Mode

When using shooting mode, press the  button to delete the last image that was saved.

Operating the Erase Selected Images Screen

1 Use the multi selector ◀▶ to select an image to be deleted, and then use ▲ to display 🗑️.

- To undo the selection, press ▼ to remove 🗑️.
- Move the zoom control (📖1) toward **T** (🔍) to switch to full-frame playback or **W** (📐) to switch to thumbnail playback.



2 Add 🗑️ to all images that you want to delete and then press the **OK** button to confirm the selection.

- A confirmation dialog is displayed. Follow the on-screen instructions to complete operations.

Changing the Shooting Mode

The shooting modes described below are available.

- **SCN Scene auto selector**

The camera automatically recognizes the shooting scene when you frame a picture, making it easier to take pictures using settings that suit the scene.

- **SCN Scene mode**

Camera settings are optimized according to the scene that you select.

- **SE Special effects**

Effects can be applied to images during shooting.

- **SPR Smart portrait**



When the camera detects a smiling face, the shutter is released automatically without you pressing the shutter-release button (smile timer). You can also use the skin softening option to smooth the skin tones of human faces.

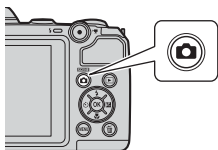

- **CAM Auto mode**

Used for general shooting. Settings can be changed to suit the shooting conditions and the type of shot that you want to capture.

- 1 When the shooting screen is displayed, press the  (shooting mode) button.



- 2 Use the multi selector   to select a shooting mode and press the  button.

- When scene mode or special effects mode is selected, press  to select a scene mode or effect before pressing the  button.

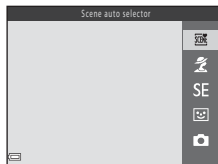

Using the Flash, Self-timer, Etc.

When the shooting screen is displayed, you can press the multi selector ▲ (⚡) ◀ (🕒) ▼ (🌸) ▶ (📷) to set the functions described below.



- **⚡ Flash mode**
You can select a flash mode to match the shooting conditions when the flash is raised.
- **🕒 Self-timer**
The camera releases the shutter 10 seconds after you press the shutter-release button.
- **🌸 Macro mode**
Use macro mode when you take close-up pictures.
- **📷 Exposure compensation**
You can adjust overall image brightness.

The functions that can be set vary depending on the shooting mode.

Recording Movies

Display the shooting screen and press the ● (▶🎬 movie-record) button to start recording a movie. Press the ● (▶🎬) button again to end recording.



- To play back a movie, select a movie in full-frame playback mode and press the OK button.









Shooting Features

(Scene Auto Selector) Mode



The camera automatically recognizes the shooting scene when you frame a picture, making it easier to take pictures using settings that suit the scene.

Enter shooting mode →  (shooting mode) button →  (scene auto selector) mode →  button



When the camera automatically recognizes the shooting scene, the shooting mode icon displayed on the shooting screen changes accordingly.

	Portrait
	Landscape
	Night portrait
	Night landscape
	Close-up
	Backlighting
	Other scenes

Notes About (Scene Auto Selector) Mode





- Depending on shooting conditions, the camera may not select the desired scene mode. In this case, select another shooting mode (19).
- When the digital zoom is in effect, the shooting mode icon changes to .

Functions Available in (Scene Auto Selector) Mode

















- Self-timer (34)
- Exposure compensation (36)
- Image mode (60)

Scene Mode (Shooting Suited to Scenes)

When a scene is selected, camera settings are automatically optimized for the selected scene.

Enter shooting mode →  (shooting mode) button →  (second icon from the top*) →  →  → select a scene →  button

* The icon of the last scene selected is displayed.

 Portrait (default setting)	 Dusk/dawn ^{1, 2, 3}
 Landscape ^{1, 2}	 Night landscape ^{1, 2, 3}
 Sports ² (📖24)	 Close-up ² (📖24)
 Night portrait ³ (📖24)	 Food ² (📖24)
 Party/indoor ² (📖24)	 Fireworks show ^{1, 3} (📖24)
 Beach ²	 Backlighting ² (📖25)
 Snow ²	 Panorama assist ² (📖26)
 Sunset ^{2, 3}	 Pet portrait (📖25)

¹ The camera focuses at infinity.

² The camera focuses on the area in the center of the frame.

³ Use of a tripod is recommended, because the shutter speed is slow. Set **Vibration reduction** (📖80) to **Off** in the setup menu when using a tripod to stabilize the camera during shooting.

Displaying a Description of Each Scene Mode (Help Display)

Select a scene and move the zoom control (📖1) toward **T** (🔍) to view a description of that scene. To return to the previous screen, move the zoom control toward **T** (🔍) again.

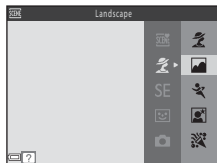

Tips and Notes

Sports

- While the shutter-release button is held all the way down, the camera shoots up to about 4 images continuously at a rate of about 1 fps (when **Image mode** is set to  **5152x3864**).
- The frame rate for continuous shooting may vary depending on the current image mode setting, the memory card used, or shooting conditions.
- Focus, exposure, and hue are fixed at the values determined with the first image in each series.

Night portrait

- The flash always fires. Raise the flash before shooting.



Party/indoor

- To avoid the effects of camera shake, hold the camera steady. Set **Vibration reduction** (80) to **Off** in the setup menu when using a tripod to stabilize the camera during shooting.

Close-up

- Macro mode (35) is enabled and the camera automatically zooms to the closest position at which it can focus.

Food

- Macro mode (35) is enabled and the camera automatically zooms to the closest position at which it can focus.
- You can adjust hue by using the multi selector  . The hue setting is saved in the camera's memory even after the camera is turned off.







Fireworks show

- The shutter speed is fixed at four seconds.



Backlighting

- The flash always fires. Raise the flash before shooting.

Pet portrait

- When you point the camera at a dog or cat, the camera detects the pet's face and focuses on it. By default, the camera detects a dog or cat face and automatically releases the shutter (pet portrait auto release).
- On the screen displayed when  **Pet portrait** is selected, select  **Single** or  **Continuous**.
 -  **Single**: The camera captures one image when a dog or cat face is detected.
 -  **Continuous**: The camera captures three images continuously when a dog or cat face is detected.

Pet Portrait Auto Release

- Press the multi selector  to change the **Pet portrait auto release** setting.
 - : The camera detects a dog or cat face and automatically releases the shutter.
 - **OFF**: The camera does not release the shutter automatically, even if a dog or cat face is detected. Press the shutter-release button.
- **Pet portrait auto release** is set to **OFF** after five bursts have been taken.
- Shooting is also possible by pressing the shutter-release button, regardless of the **Pet portrait auto release** setting. When  **Continuous** is selected, you can take pictures continuously while holding down the shutter-release button all the way.

Focus Area

- When the camera detects a face, the face is displayed inside a yellow border. When the camera acquires focus on a face displayed inside a double border (focus area), the double border changes to green. If no faces are detected, the camera focuses on the subject in the center of the frame.
- Under some shooting conditions, the pet face may not be detected and other subjects may be displayed inside a border.

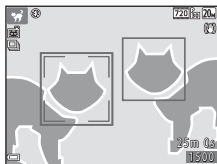

4 Press the **OK** button when shooting is complete.

- The camera returns to step 1.



✓ **Notes About Panorama Assist**

- Up to three images can be taken and combined in a panorama series. Shooting automatically ends after the third image is taken.
- A panorama image may not be saved if the translucent portion of an image is not properly aligned with the subject when taking the next image.
- The range of the image seen in the saved image is narrower than that seen in the monitor at the time of shooting.
- If shooting ends after only the first image is taken, the camera cannot scroll the playback of the image (📖28).
- Shooting for the panorama series is terminated if the auto off function (📖81) initiates standby mode during shooting. Setting the time allowed to elapse before the auto off function is enabled to a longer setting is recommended.
- Images cannot be deleted while shooting in panorama assist mode. When shooting a new image, return to step 1 and start over again.

📌 **AE/AF-L Indicator**

In panorama assist scene mode, exposure, white balance, and focus for all images in a panorama are fixed at the values for the first image in each series. When the first image is taken, **AE/AF-L** is displayed in the monitor to indicate that exposure, white balance, and focus are locked.



Playback with Panorama Assist

Switch to playback mode (📖16), display an image captured using panorama assist in full-frame playback mode, and then press the **OK** button to scroll the image in the direction that was used when shooting.

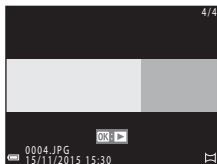

Playback controls are displayed in the monitor during playback.

Use the multi selector **◀▶** to select a control, and then press the **OK** button to perform the operations described below.

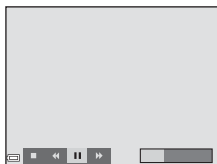

Function	Icon	Description	
Rewind	◀	Hold down the OK button to scroll backward quickly.	
Advance	▶	Hold down the OK button to scroll forward quickly.	
Pause	⏸	Pause playback. The operations listed below can be performed while paused.	
		◀	Hold down the OK button to rewind.
		▶	Hold down the OK button to scroll.
	▶	Resume automatic scrolling.	
End	■	Switch to full-frame playback mode.	

✓ Notes About Panorama Assist Images







- The images cannot be edited on this camera.
- This camera may not be able to scroll the playback of, or zoom in on, panorama assist images captured with another make or model of digital camera.

✓ Notes About Printing Panorama Images



The entire image may not be able to be printed depending on the printer's settings. Additionally, printing may not be possible depending on the printer.

Special Effects Mode (Applying Effects When Shooting)





Effects can be applied to images during shooting.

Enter shooting mode →  (shooting mode) button → SE (third icon from the top*) →     → select an effect →  button

* The icon of the last effect selected is displayed.

Type	Description
SE Nostalgic sepia (default setting)	Adds a sepia tone and reduces the contrast to simulate the qualities of an old photograph.
 High-contrast monochrome	Changes the image to black and white and gives it sharp contrast.
 Selective color*	Creates a black and white image in which only the specified color remains.
POP Pop*	Increases the color saturation of the entire image to create a bright look.
 Photo illustration*	Emphasizes outlines and reduces the number of colors to create images with the ambience of illustrations.
CO Cyanotype	Changes the color of the entire image into blue monotone.

* Hue is not applied to movies.

- The camera focuses on the area in the center of the frame.
- When **Selective color** is selected, use the multi selector   to select the desired color, and press the  button to apply the color. To change the color selection, press the  button again.



Smart Portrait Mode (Capturing Images of Smiling Faces)

When the camera detects a smiling face, you can take a picture automatically without pressing the shutter-release button (smile timer (📖67)). You can use the skin softening option to smooth the skin tones of human faces.

Enter shooting mode → 📷 (shooting mode) button → 😊 Smart portrait mode → Ⓞ button

1 Frame the picture.

- Point the camera at a human face.

2 Without pressing the shutter-release button, wait for the subject to smile.

- If the camera detects that the face framed by the double border is smiling, the shutter is automatically released.
- Whenever the camera detects a smiling face, it automatically releases the shutter.

3 End automatic shooting.

- Perform one of the operations listed below to end shooting.
 - Set **Smile timer** to **Off**.
 - Press the 📷 button and select a different shooting mode.

✓ Notes About Smart Portrait Mode

Under some shooting conditions, the camera may be unable to detect faces or smiles (📖39). The shutter-release button can also be used for shooting.

📌 When the Self-timer Lamp Flashes



When using smile timer, the self-timer lamp flashes when the camera detects a face and flashes quickly immediately after the shutter is released.

Functions Available in Smart Portrait Mode

- Flash mode (📖32)
- Self-timer (📖34)
- Exposure compensation (📖36)
- Smart portrait menu (📖67)





(Auto) Mode

Used for general shooting. Settings can be adjusted to suit the shooting conditions and the type of shot you want to capture.

Enter shooting mode →  (shooting mode) button →  (auto) mode
→  button

- You can change how the camera selects the area of the frame to focus on by changing the **AF area mode** setting (66).
The default setting is **Center**.

Functions Available in (Auto) Mode

- Flash mode (32)
- Self-timer (34)
- Macro mode (35)
- Exposure compensation (36)
- Shooting menu (60)

Flash Mode

You can select a flash mode to match the shooting conditions.

1 Press the ⚡ (flash pop-up) button.

- The flash pops up.
- The flash does not fire while it is lowered. ⚡ is displayed to indicate that the flash does not fire.

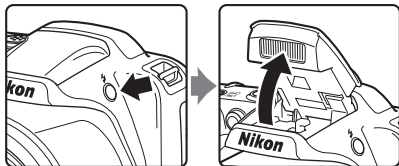

2 Press the multi selector ▲ (⚡).



3 Select the desired flash mode (📖33) and press the Ⓞ button.

- If the setting is not applied by pressing the Ⓞ button within a few seconds, the selection will be canceled.

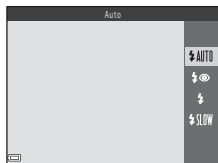

✓ Lowering the Flash

Push the flash down gently to lower the flash until it clicks into place when not in use (📖11).

The Flash Lamp

- The status of the flash can be confirmed by pressing the shutter-release button halfway.
 - On: The flash fires when you press the shutter-release button all the way down.
 - Flashing: The flash is charging. The camera cannot shoot images.
 - Off: The flash does not fire when a picture is taken.
- If the battery level is low, the monitor turns off while the flash is charging.

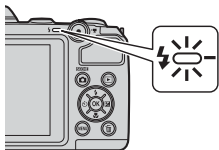

Available Flash Modes

AUTO Auto

The flash fires when necessary, such as in dim lighting.

- The flash mode icon on the shooting screen is displayed only immediately after the setting is made.

Auto with red-eye reduction

Reduce “red-eye” in portraits caused by the flash.

Fill flash

The flash fires whenever a picture is taken. Use to “fill-in” (illuminate) shadows and backlit subjects.

SLOW Slow sync

Suited to evening and night portraits that include background scenery. The flash fires when necessary to illuminate the main subject; slow shutter speeds are used to capture background at night or under dim lighting.

The Flash Mode Setting

- The setting may not be available with some shooting modes (book 37).
- The setting applied in  (auto) mode is saved in the camera’s memory even after the camera is turned off.

Red-eye Reduction

If the camera detects red eye while saving an image, the affected area is processed to reduce red-eye before the image is saved.

Note the following when shooting:

- More time than usual is required to save images.
- Red-eye reduction may not produce the desired results in some situations.
- In rare cases, red-eye reduction may be applied unnecessarily to other areas of the image. In these cases, select another flash mode and take the picture again.

Self-timer

The camera is equipped with a self-timer that releases the shutter 10 seconds after you press the shutter-release button.

Set **Vibration reduction** (📖80) to **Off** in the setup menu when using a tripod to stabilize the camera during shooting.

1 Press the multi selector ◀ (🕒).



2 Select **ON** and press the **OK** button.

- If the setting is not applied by pressing the **OK** button within a few seconds, the selection will be canceled.
- When the shooting mode is **Pet portrait** scene mode, 📷 (pet portrait auto release) is displayed (📖25). The self-timer cannot be used.

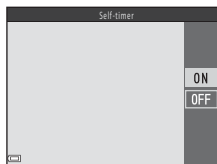

3 Frame the picture and press the shutter-release button halfway.

- Focus and exposure are set.

4 Press the shutter-release button the rest of the way down.

- Countdown starts. The self-timer lamp flashes and then glows steadily about one second before the shutter is released.
- When the shutter is released, the self-timer is set to **OFF**.
- To stop the countdown, press the shutter-release button again.

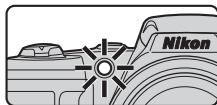

Macro Mode (Taking Close-up Pictures)

Use macro mode when taking close-up pictures.

- 1 Press the multi selector ▼ (👉).



- 2 Select **ON** and press the **OK** button.

- If the setting is not applied by pressing the **OK** button within a few seconds, the selection will be canceled.

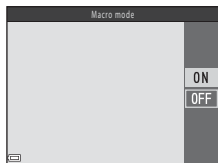

- 3 Move the zoom control to set the zoom ratio to a position where **👉** and the zoom indicator are displayed in green.



- When the zoom ratio is set to a position where **👉** and the zoom indicator are displayed in green, the camera can focus on subjects as close as approximately 10 cm (4 in.) from the lens.
- When the zoom position is in the area indicated by ①, the camera can focus on subjects as close as approximately 1 cm (0.4 in.) from the lens.

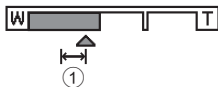

✓ Notes About Using the Flash

The flash may be unable to light the entire subject at distances of less than 50 cm (1 ft 8 in.).

📎 The Macro Mode Setting

- The setting may not be available with some shooting modes (📖37).
- If the setting is applied in **📷** (auto) mode, it will remain saved in the camera's memory even after the camera is turned off.

Exposure Compensation (Adjusting Brightness)

You can adjust overall image brightness.

- 1 Press the multi selector ► (⊕/⊖).



- 2 Select a compensation value and press the **OK** button.

- To brighten the image, set a positive (+) value.
- To darken the image, set a negative (-) value.
- The compensation value is applied, even without pressing the **OK** button.

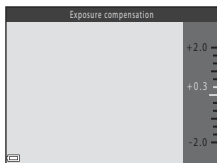

























































Exposure Compensation Value

- The setting may not be available with some shooting modes (📖37).
- If the setting is applied in  (auto) mode, it will remain saved in the camera's memory even after the camera is turned off.

Default Settings (Flash, Self-timer, Etc.)

Default settings for each shooting mode are listed below.

	Flash ¹ (📖32)	Self-timer (📖34)	Macro (📖35)	Exposure compensation (📖36)
 (scene auto selector)	 AUTO ²	Off	Off ³	0.0
Scene				
 (portrait)	 	Off	Off ⁴	0.0
 (landscape)	 	Off	Off ⁴	0.0
 (sports)	 	Off ⁴	Off ⁴	0.0
 (night portrait)	 	Off	Off ⁴	0.0
 (party/indoor)	 	Off	Off ⁴	0.0
 (beach)	 AUTO	Off	Off ⁴	0.0
 (snow)	 AUTO	Off	Off ⁴	0.0
 (sunset)	 	Off	Off ⁴	0.0
 (dusk/dawn)	 	Off	Off ⁴	0.0
 (night landscape)	 	Off	Off ⁴	0.0
 (close-up)	 	Off	On ⁴	0.0
 (food)	 	Off	On ⁴	0.0
 (fireworks show)	 	Off ⁴	Off ⁴	0.0 ⁴
 (backlighting)		Off	Off ⁴	0.0
 (panorama assist)	 	Off	Off	0.0
 (pet portrait)	 		Off	0.0
SE (special effects)	 	Off	Off	0.0
 (smart portrait)	 AUTO ⁸	Off ⁹	Off ⁴	0.0
 (auto)	 AUTO	Off	Off	0.0

- 1 The setting that is used when the flash is raised.
- 2 Cannot be changed. The camera automatically selects the flash mode appropriate for the scene it has selected.
- 3 Cannot be changed. The camera enters macro mode when  is selected.
- 4 Cannot be changed.
- 5 Cannot be changed. The flash mode setting is fixed at fill flash with slow sync and red-eye reduction.
- 6 Slow sync with red-eye reduction flash mode may be used.
- 7 Self-timer cannot be used. Pet portrait auto release can be turned on or off (25).
- 8 Cannot be used when **Blink proof** is set to **On**.
- 9 Can be set when **Smile timer** is set to **Off**.

Focusing

The focus area varies depending on the shooting mode.

Using Face Detection

In the following shooting modes, the camera uses face detection to automatically focus on human faces.

- **SCN** (scene auto selector) mode (📖22)
- **Portrait** or **Night portrait** scene mode (📖23)
- Smart portrait mode (📖30)

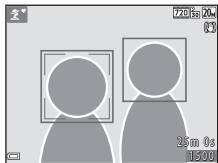

If the camera detects more than one face, a double border is displayed around the face that the camera focuses on, and single borders are displayed around the other faces.

If the shutter button is pressed halfway when no faces are detected:

- In **SCN** (scene auto selector) mode, the focus area changes depending on the scene.
- In **Portrait** and **Night portrait** scene modes or in smart portrait mode, the camera focuses in the center of the frame.

✓ Notes About Face Detection

- The camera's ability to detect faces depends on a variety of factors, including the direction in which the faces are looking.
- The camera cannot detect faces in the following situations:
 - When faces are partially hidden by sunglasses or otherwise obstructed
 - When faces take up too much or too little of the frame

Using Skin Softening

When the shutter is released while using one of the shooting modes listed below, the camera detects human faces and processes the image to soften facial skin tones (up to three faces).

- Smart portrait mode (📖30)
- **SCN** (scene auto selector) mode (📖22)
- **Portrait** or **Night portrait** in scene mode (📖23)

Skin softening can also be applied to saved images (📖49) even after shooting.

Notes About Skin Softening

- It may take more time than usual to save images after shooting.
- Under some shooting conditions, the desired skin softening results may not be achieved, and skin softening may be applied to areas of the image where there are no faces.

Using Target Finding AF

When **AF area mode** (📖66) in 📷 (auto) mode is set to **Target finding AF**, the camera focuses in the manner described below when you press the shutter-release button halfway.

- The camera detects the main subject and focuses on it. When the subject is in focus, the focus area is displayed in green. If a human face is detected, the camera automatically sets focus priority on it.

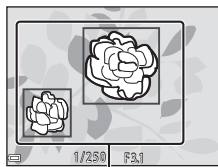

Focus areas

- If no main subject is detected, the camera focuses on the subject in the center of the frame. When the subject is in focus, the focus area is displayed in green.

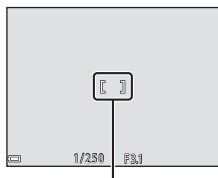

Focus area

✓ Notes About Target Finding AF

- Depending on shooting conditions, the subject that the camera determines to be the main subject may vary.
- The main subject may not be detected when using certain **White balance** settings.
- The camera may not detect the main subject appropriately in the following situations:
 - When the subject is very dark or bright
 - When the main subject lacks clearly defined colors
 - When the shot is framed so that the main subject is at the edge of the monitor
 - When the main subject is composed of a repeating pattern

Subjects Not Suitable for Autofocus

The camera may not focus as expected in the following situations.

In rare cases, the subject may not be in focus despite the fact that the focus area or the focus indicator is displayed in green:

- Subject is very dark
- Objects of sharply differing brightness are included in the scene (e.g. the sun behind the subject makes that subject appear very dark)
- No contrast between the subject and surroundings (e.g. a portrait subject wearing a white shirt is standing in front of a white wall)
- Several objects are at different distances from the camera (e.g. the subject is inside a cage)
- Subjects with repeating patterns (window blinds, buildings with multiple rows of similarly shaped windows, etc.)
- Subject is moving rapidly

In the situations noted above, try pressing the shutter-release button halfway to refocus several times, or focus on another subject positioned at the same distance from the camera as the actual desired subject, and use focus lock (43).

Focus Lock

Focus lock shooting is recommended when the camera does not activate the focus area that contains the desired subject.

1 Set **AF area mode** to **Center** in  (auto) mode ( 66).

2 Position the subject in the center of the frame and press the shutter-release button halfway.

- The camera focuses on the subject and the focus area is displayed in green.
- Exposure is also locked.

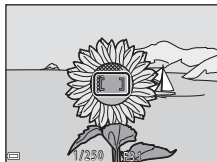

3 Without lifting your finger, recompose the picture.

- Make sure to maintain the same distance between the camera and the subject.

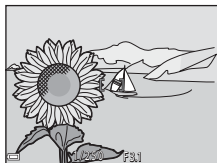

4 Press the shutter-release button the rest of the way down to take the picture.



Functions That Cannot Be Used Simultaneously When Shooting

Some functions cannot be used with other menu options.

Restricted function	Option	Description
Flash mode	Continuous (📖64)	When Continuous is selected, the flash cannot be used.
	Blink proof (📖68)	When Blink proof is set to On , the flash cannot be used.
Self-timer	Smile timer (📖67)	When Smile timer is selected, the self-timer cannot be used.
Continuous	Self-timer (📖34)	When the self-timer is used, the setting is fixed at Single .
AF area mode	White balance (📖62)	When a setting other than Auto is selected for White balance in Target finding AF mode, the camera does not detect the main subject.
Shutter sound	Continuous (📖64)	When Continuous is selected, the shutter sound is disabled.

Playback Features

Playback Zoom

Moving the zoom control toward **T** (🔍 playback zoom) in full-frame playback mode (📖16) zooms in on the image.

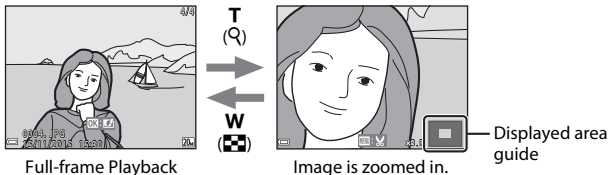

- You can change the magnification rate by moving the zoom control toward **W** (📐) or **T** (🔍).
- To view a different area of the image, press the multi selector ▲▼◀▶.
- When a zoomed image is displayed, press the **OK** button to return to full-frame playback mode.

Cropping Images

When a zoomed image is displayed, you can press the **MENU** button to crop the image to include only the visible portion and save it as a separate file (📖51).

Thumbnail Playback/Calendar Display

Moving the zoom control toward **W** (🗪) thumbnail playback) in full-frame playback mode (📖16) displays images as thumbnails.



- You can change the number of thumbnails displayed by moving the zoom control toward **W** (🗪) or **T** (📖).
- While using thumbnail playback mode, press the multi selector **▲▼◀▶** to select an image and then press the **OK** button to display that image in full-frame playback mode.
- While using calendar display mode, press **▲▼◀▶** to select a date and then press the **OK** button to display the images captured on that day.

✓ Notes About Calendar Display

Images captured when the camera's date is not set are treated as images captured on January 1, 2015.

Editing Images (Still Images)

Before Editing Images

You can easily edit images on this camera. Edited copies are saved as separate files. Edited copies are saved with the same shooting date and time as the original.

Restrictions on Image Editing

- An image can be edited up to 10 times.
- You may not be able to edit images of a certain size or with certain editing functions.

Quick Effects: Changing Hue or Mood

Processes images with a variety of effects.

You can select **Miniature effect**, **Fisheye**, **Cross process (red)**, **Cross process (yellow)**, **Cross process (green)**, **Cross process (blue)**, **Soft**, **Cross screen**, **Toy camera effect 1**, **Toy camera effect 2**, or **Painting**.

- 1 Display the image to which you want to apply an effect in full-frame playback mode and press the **OK** button.



- 2 Use the multi selector **▲▼◀▶** to select the desired effect and press the **OK** button.

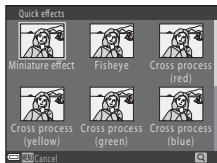

- Move the zoom control (**1**) toward **T** (**Q**) to switch to full-frame playback or **W** (**Q**) to switch to thumbnail playback.
- To exit without saving the edited image, press the **MENU** button.





- 3 Select **Yes** and press the **OK** button.

- An edited copy is created.

D-Lighting: Enhancing Brightness and Contrast



Press the  button (playback mode) → select an image → MENU button → D-Lighting →  button

Use the multi selector ▲▼ to select **OK** and press the  button.

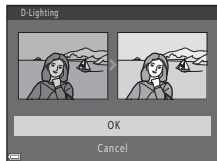
- The edited version is displayed on the right.
- To exit without saving the copy, select **Cancel** and press the  button.



Skin Softening: Softening Skin Tones

Press the  button (playback mode) → select an image → MENU button → Skin softening →  button

1 Use the multi selector ▲▼ to select the amount of effect applied and press the  button.

- The confirmation dialog is displayed with the face to which the effect was applied enlarged in the monitor.
- To exit without saving the copy, press ◀.



2 Preview the result and press the  button.



- Skin tones of up to 12 faces, in the order of that closest to the center of the frame, are softened.
- If more than one face was processed, use ◀▶ to display a different face.
- Press the MENU button to adjust the amount of effect applied. The monitor display returns to that shown in step 1.







Notes About Skin Softening

- Skin softening cannot be applied if no faces are detected in the image.
- Depending on the direction in which faces are looking, or the brightness of faces, the camera may be unable to accurately detect faces, or the skin softening function may not perform as expected.

Small Picture: Reducing the Size of an Image

Press the  button (playback mode) → select an image → MENU button → Small picture →  button

1 Use the multi selector   to select the desired copy size and press the  button.

- Images captured at an image mode setting of  **5120×2880**, only **640×360** is displayed.

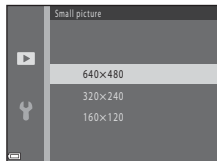

2 Select **Yes** and press the  button.

- An edited copy is created (compression ratio of approximately 1:16).

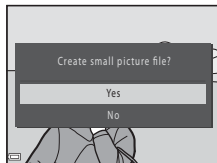

Notes About Small Picture

Images with an aspect ratio of 1:1 cannot be edited.

Crop: Creating a Cropped Copy

1 Move the zoom control to enlarge the image (📖45).

2 Adjust the image so that only the portion that you want to keep is displayed, and then press the **MENU** (menu) button.

- Move the zoom control toward **T** (📏) or **W** (📏) to adjust the magnification rate. Set a magnification rate at which **MENU**:📏 is displayed.
- Use the multi selector ▲▼◀▶ to scroll to the portion of the image that you want to display.



3 Select **Yes** and press the **OK** button.

- An edited copy is created.



Image Size

When the image size of the cropped copy is 320 x 240 or smaller, the image is displayed at a smaller size during playback.

Cropping the Image in Its Current "Tall" Orientation

Use the **Rotate image** option (📖70) to rotate the image so that it is displayed in landscape orientation. After cropping the image, rotate the cropped image back to "tall" orientation.

Recording and Playing Back Movies

1 Display the shooting screen.

- Check the remaining amount of movie recording time.

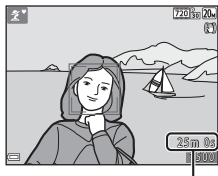

Remaining movie recording time

2 Lower the flash (11).

- Recording movies while the flash is raised may cause the audio to be muffled.

3 Press the movie-record button to start movie recording.

- The camera focuses in the center of the frame.



4 Press the movie-record button again to end recording.

5 Select a movie in full-frame playback mode and press the button to play it back.

- An image with a movie options icon is a movie.



Movie options

Area Captured in Movies

- The area that is captured in a movie varies depending on the **Movie options** settings in the movie menu.
- If **Photo info** in **Monitor settings** (📖77) in the setup menu is set to **Movie frame+auto info**, you can confirm the area that will be captured in a movie before you start recording.

Maximum Movie Recording Time

Individual movie files cannot exceed 4 GB in size or 29 minutes in length, even when there is sufficient free space on the memory card for longer recording.

- The remaining recording time for a single movie is displayed on the shooting screen.
- The actual remaining recording time may vary depending on the movie content, subject movement, or type of memory card.
- Memory cards with an SD Speed Class rating of 6 or faster are recommended when recording movies (📖113). Movie recording may stop unexpectedly when memory cards with a lower Speed Class rating are used.

Notes About Camera Temperature

- The camera may become hot when shooting movies for an extended period of time or when the camera is used in a hot area.
- If the inside of the camera becomes extremely hot when recording movies, the camera will automatically stop recording.
The amount of time remaining until the camera stops recording (⚠️10s) is displayed.

After the camera stops recording, it turns itself off.

Leave the camera off until the inside of the camera has cooled.

Notes About Movie Recording

Notes About Saving Images or Movies

The indicator showing the number of exposures remaining or the indicator showing the remaining recording time flashes while images or movies are being saved. **Do not open the battery-chamber/memory card slot cover or remove the batteries or memory card** while an indicator is flashing. Doing this could result in loss of data, or in damage to the camera or the memory card.

Notes About Recorded Movies

- There may be some degradation in image quality when digital zoom is used. When switching from optical zoom to digital zoom while recording movies, the zoom operation stops temporarily.
- The sounds of zoom control operation, zoom, autofocus lens drive movement, vibration reduction, and aperture operation when brightness changes may be recorded.
- Smear (📖96) visible in the monitor with movie recording is recorded with movies. Avoiding bright objects such as the sun, reflections of the sun, and electric lights is recommended.
- Depending on the distance to the subject or the amount of zoom applied, colored stripes may appear on subjects with repeating patterns (fabrics, lattice windows, etc.) during movie recording and playback. This occurs when the pattern in the subject and the layout of the image sensor interfere with each other; it is not a malfunction.

Notes About Autofocus for Movie Recording

Autofocus may not perform as expected (📖42). Should this occur, try the following:

1. Set **Autofocus mode** in the movie menu to **Single AF** (default setting) before starting movie recording.
2. Frame another subject (positioned at the same distance from the camera as the intended subject) in the center of the frame, press the  (📹 movie-record) button to start recording, and modify the composition.

Operations During Movie Playback

To adjust the volume, move the zoom control while a movie is playing (📖1).



Volume indicator

Playback controls are displayed in the monitor. The operations described below can be performed by using the multi selector ◀▶ to select a control and then pressing the Ⓞ button.



When paused

Function	Icon	Description	
Rewind	◀	Hold down the Ⓞ button to rewind the movie.	
Advance	▶	Hold down the Ⓞ button to advance the movie.	
Pause	⏸	Pause playback. The operations listed below can be performed while paused.	
		◀	Rewind the movie one frame. Hold down the Ⓞ button for continuous rewinding.
		▶	Advance the movie one frame. Hold down the Ⓞ button for continuous advancing.
		▶	Resume playback.
		Extract the desired portion of a movie and save it as a separate file.	
End	■	Return to full-frame playback mode.	

Editing Movies

The desired portion of a recorded movie can be saved as a separate file.

1 Play back a movie and pause at the start point of the portion that you want to extract (📖55).

2 Use the multi selector ◀▶ to select 📄 in the playback controls, and then press the Ⓞ button.

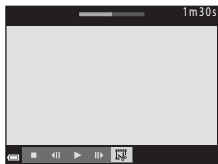

3 Use ▲▼ to select ✂ (choose start point) in the editing controls.

- Use ◀▶ to move the start point.
- To cancel editing, select ↵ (return), and press the Ⓞ button.

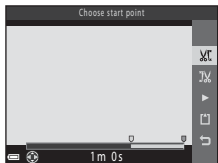

4 Use ▲▼ to select 📄 (choose end point).

- Use ◀▶ to move the end point.
- To preview the specified portion, select ▶ and then press the Ⓞ button. Press the Ⓞ button again to stop previewing.

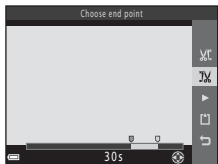

5 Use ▲▼ to select 📁 (save) and press the Ⓞ button.

- Follow the instructions on the screen to save the movie.

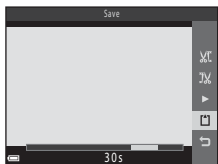

Notes About Movie Editing

- Use batteries with a sufficient amount of charge remaining to prevent the camera from turning off during editing. When the battery level indicator is , movie editing is not possible.
- A movie that was created by editing cannot be trimmed again.
- The actual trimmed portion of a movie may differ slightly from the portion selected using the start and end points.
- Movies cannot be trimmed so that they are less than two seconds long.

Using Menus

You can set the menus listed below by pressing the **MENU** (menu) button.

- **📷 Shooting menu**

Available by pressing the **MENU** button when the shooting screen is displayed.

Allows you to change image size and quality, continuous shooting settings, etc.

- **▶ Playback menu**

Available by pressing the **MENU** button when viewing images in full-frame playback mode or thumbnail playback mode.

Allows you to edit images, play slide shows, etc.

- **🎬 Movie menu**

Available by pressing the **MENU** button when the shooting screen is displayed.

Allows you to change movie recording settings.

- **🔧 Setup menu**

Allows you to adjust basic camera functions such as date and time, display language, etc.

1 Press the **MENU** (menu) button.

- The menu is displayed.

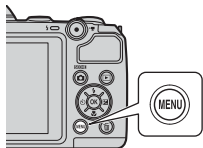

2 Press the multi selector ◀.

- The current menu icon is displayed in yellow.

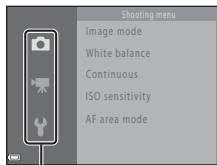

Menu icons

3 Select a menu icon and press the **OK** button.

- The menu options become selectable.

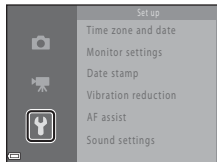

4 Select a menu option and press the **OK** button.

- Certain menu options cannot be set depending on the current shooting mode or the state of the camera.

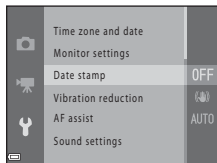

5 Select a setting and press the **OK** button.

- The setting you selected is applied.
- When you are finished using the menu, press the **MENU** button.
- When a menu is displayed, you can switch to shooting mode by pressing the shutter-release button, button, or button.

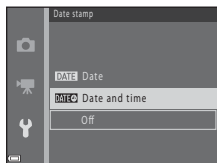

The Shooting Menu (for (Auto) Mode)











Image Mode (Image Size and Quality)

Enter shooting mode* → MENU button → Image mode → 

* This setting can also be changed in shooting modes other than auto. The changed setting is also applied to other shooting modes.

Select the combination of image size and compression ratio to be used when saving images.

The higher the image mode setting, the larger the size at which it can be printed, and the lower the compression ratio, the higher the quality of the images, but the number of images that can be saved is reduced.

Option*	Compression ratio	Aspect ratio (horizontal to vertical)
 20M* 5152×3864★	Approx. 1:4	4:3
 20M 5152×3864 (default setting)	Approx. 1:8	4:3
 10M 3648×2736	Approx. 1:8	4:3
 4M 2272×1704	Approx. 1:8	4:3
 2M 1600×1200	Approx. 1:8	4:3
 VGA 640×480	Approx. 1:8	4:3
  16:9 14M 5120×2880	Approx. 1:8	16:9
  1:1 3864×3864	Approx. 1:8	1:1

* The numerical values indicate the number of pixels that are captured.
Example:  20M 5152×3864 = approx. 20 megapixels, 5152 × 3864 pixels

Notes About Printing Images at 1:1 Aspect Ratio

Change the printer setting to “Border” when printing images at a 1:1 aspect ratio. Some printers may not be able to print images at a 1:1 aspect ratio.





Notes About Image Mode

This function may not be available to use in combination with other functions (📖44).





Number of Images That Can Be Saved

- The approximate number of images that can be saved can be checked in the monitor when shooting (📖10).
- Note that due to JPEG compression, the number of images that can be saved may vary greatly depending on the image content, even when using memory cards with the same capacity and the same image mode setting. In addition, the number of images that can be saved may vary depending on the make of the memory card.
- If the number of exposures remaining is 10,000 or more, the number of exposures remaining display shows “9999”.

White Balance (Adjusting Hue)

Enter shooting mode →  (shooting mode) button →  (auto) mode
→  button → MENU button → White balance →  button

Adjust white balance to suit the light source or weather conditions in order to make the colors in images match what you see with your eyes.

Option	Description
AUTO Auto (default setting)	White balance is automatically adjusted.
PRE Preset manual	Use when the desired result is not achieved with Auto, Incandescent , etc. (📖63).
 Daylight	Use under direct sunlight.
 Incandescent	Use under incandescent lighting.
 Fluorescent	Use under fluorescent lighting.
 Cloudy	Use under overcast skies.
 Flash	Use with the flash.

Notes About White Balance

- Lower the flash when white balance is set to any setting other than **Auto** and **Flash** (📖11).
- This function may not be available to use in combination with other functions (📖44).

Using Preset Manual

Use the procedure below to measure the white balance value under the lighting used during shooting.

1 Place a white or gray reference object under the lighting that will be used during shooting.

2 Use the multi selector ▲▼ to select **Preset manual** in the **White balance** menu, and press the **OK** button.

- The camera zooms in to the position for measuring white balance.

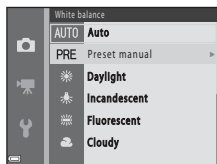

3 Select **Measure**.

- To apply the last measured value, select **Cancel** and press the **OK** button.

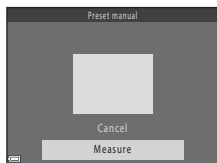

4 Frame the white or gray reference object in the measuring window, and press the **OK** button to measure the value.

- The shutter is released and measurement is complete (no image is saved).

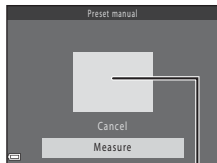







Measuring window

✓ Notes About Preset Manual

A value for flash lighting cannot be measured with **Preset manual**. When shooting using the flash, set **White balance** to **Auto** or **Flash**.

Continuous Shooting





Enter shooting mode →  (shooting mode) button →  (auto) mode
→  button → MENU button → Continuous →  button

Option	Description
 Single (default setting)	One image is captured each time the shutter-release button is pressed.
 Continuous	While the shutter-release button is held all the way down, images are captured continuously. <ul style="list-style-type: none">The frame rate for continuous shooting is about 1 fps and the maximum number of continuous shots is about 4 (when image mode is set to  5152x3864).

Notes About Continuous Shooting

- Focus, exposure, and white balance are fixed at the values determined with the first image in each series.
- The frame rate for continuous shooting may vary depending on the current image mode setting, the memory card used, or shooting condition.
- This function may not be available to use in combination with other functions (44).

ISO Sensitivity

Enter shooting mode →  (shooting mode) button →  (auto) mode
→  button → MENU button → ISO sensitivity →  button

A higher ISO sensitivity allows darker subjects to be captured. Additionally, even with subjects of similar brightness, pictures can be taken at faster shutter speeds, and blurring caused by camera shake and subject movement can be reduced.

- When a higher ISO sensitivity is set, images may contain noise.

Option	Description
AUTO Auto (default setting)	Sensitivity is automatically selected from the range of ISO 80 to 1600.
80, 100, 200, 400, 800, 1600	Sensitivity is locked at the specified value.





Notes About ISO Sensitivity

This function may not be available to use in combination with other functions (44).



ISO Sensitivity Display on the Shooting Screen

When **Auto** is selected, **ISO** is displayed when the ISO sensitivity increases.

AF Area Mode

Enter shooting mode →  (shooting mode) button →  (auto) mode
→  button → MENU button → AF area mode →  button

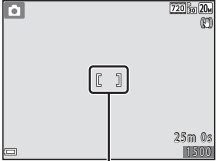
Set how the camera selects the focus area for autofocus.

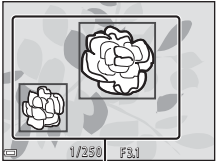
Option	Description
[] Center (default setting)	The camera focuses on the subject in the center of the frame.  Focus area
[] Target finding AF	When the camera detects the main subject, it focuses on that subject. See "Using Target Finding AF" ( 41) for more information.  Focus areas

Notes About AF Area Mode

- When digital zoom is in effect, the camera focuses in the center of the frame regardless of the **AF area mode** setting.
- This function may not be available to use in combination with other functions (44).

The Smart Portrait Menu

- See “Image Mode (Image Size and Quality)” (📖60) for information about **Image mode**.

Skin Softening

Enter shooting mode → 📷 (shooting mode) button → 😊 Smart portrait mode → Ⓞ button → MENU button → Skin softening → Ⓞ button

Option	Description
😊 On (default setting)	When the shutter is released, the camera detects one or more human faces (up to three), and processes the image to soften facial skin tones before saving the image.
Off	Turns the skin softening off.

The result of skin softening effect on your subject cannot be confirmed when framing images for shooting. Play back the images to check the results after shooting.





Smile Timer

Enter shooting mode → 📷 (shooting mode) button → 😊 Smart portrait mode → Ⓞ button → MENU button → Smile timer → Ⓞ button

The camera detects human faces and then automatically releases the shutter whenever a smile is detected.

Option	Description
😊 On (default setting)	Enables the smile timer.
Off	Turns the smile timer off.

Blink Proof

Enter shooting mode →  (shooting mode) button →  Smart portrait mode →  button → MENU button → Blink proof →  button

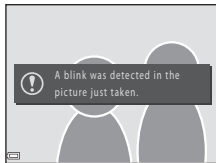

Option	Description
 On	<p>The camera automatically releases the shutter twice with every shot and saves one image in which the subject's eyes are open.</p> <ul style="list-style-type: none">• If the camera saved an image in which the subject's eyes may have been closed, the dialog shown on the right is displayed for a few seconds.• The flash cannot be used.
Off (default setting)	Turns the blink proof off.



The Playback Menu



- See “Editing Images (Still Images)” (📖47) for information about image editing functions.

Slide Show

Press the  button (playback mode) → MENU button → Slide show →  button



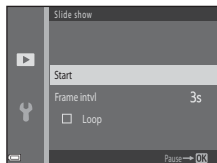

Play back images one by one in an automated “slide show.” When movie files are played back in the slide show, only the first frame of each movie is displayed.

1 Use the multi selector ▲▼ to select **Start** and press the button.

- The slide show begins.
- To change the interval between images, select **Frame intvl**, press the  button, and specify the desired interval time before selecting **Start**.
- To repeat the slide show automatically, select **Loop** and press the  button before selecting **Start**.
- The maximum playback time is up to about 30 minutes even if **Loop** is enabled.



2 End or restart the slide show.



- The screen shown on the right is displayed after the slide show ends or is paused. To exit the show, select  and then press the  button. To resume the slide show, select  and then press the  button.



Operations During Playback

- Use the multi selector ◀▶ to display the previous/next image. Press and hold to rewind/fast forward.
- Press the  button to pause or end the slide show.

Protect



Press the  button (playback mode) → MENU button → Protect →  button

The camera protects selected images from accidental deletion.



Select images to protect or cancel protection from the image selection screen (72).

Note that formatting the memory card or the camera's internal memory permanently deletes all data including protected files (82).

Rotate Image

Press the  button (playback mode) → MENU button → Rotate image →  button

Specify the orientation in which saved images are displayed during playback. Still images can be rotated 90 degrees clockwise or 90 degrees counterclockwise.

Select an image from the image selection screen (72). When the Rotate image screen is displayed, press the multi selector  to rotate the image 90 degrees.



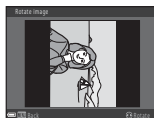

Rotate 90 degrees
counterclockwise



Rotate 90 degrees
clockwise

Press the  button to finalize display orientation, and save orientation information with the image.

Copy (Copy Between the Memory Card and Internal Memory)

Press the  button (playback mode) → MENU button → Copy →  button

Images can be copied between a memory card and the internal memory.

- When a memory card that contains no images is inserted and the camera is switched to playback mode, **Memory contains no images.** is displayed. In that case, press the MENU button to select **Copy**.

- 1** Use the multi selector ▲▼ to select a destination option to which images are copied and press the  button.

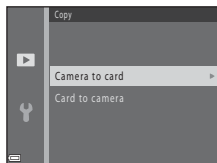

- 2** Select a copy option and press the  button.

- When you choose **Selected images**, use the image selection screen to specify images (72).

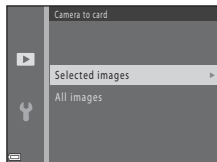

Notes About Copying Images

- Only files in formats that this camera can record can be copied.
- Operation is not guaranteed with images captured with another make of camera or that have been modified on a computer.

The Image Selection Screen

When an image selection screen such as the one shown on the right is displayed while operating the camera, follow the procedures described below to select the images.



1 Use the multi selector ◀▶ to select an image.

- Move the zoom control (📄1) toward **T** (🔍) to switch to full-frame playback or **W** (📄) to switch to thumbnail playback.
- Only one image can be selected for **Rotate image**. Proceed to step 3.



2 Use ▲▼ to select or deselect (or to specify the number of copies).

- When an image is selected, an icon is displayed with the image. Repeat steps 1 and 2 to select additional images.





3 Press the (OK) button to apply image selection.

- When a confirmation dialog is displayed, follow the on-screen instructions to operate.



The Movie Menu

Movie Options



Enter shooting mode → MENU button →  menu icon → Movie options →  button

Select the desired movie option to record.

- Memory cards with an SD Speed Class rating of 6 or faster are recommended for recording movies ( 113).

Option (Image size/Frame rate, File format)	Image size	Aspect ratio (horizontal to vertical)
 720/30p (default setting)	1280 × 720	16:9
 480/30p	640 × 480	4:3



Autofocus Mode

Enter shooting mode → MENU button →  menu icon → Autofocus mode →  button

Set how the camera focuses in movie mode.

Option	Description
AF-S Single AF (default setting)	Focus is locked when movie recording starts. Select this option when the distance between the camera and subject will remain fairly consistent during movie recording.
AF-F Full-time AF	The camera focuses continuously during movie recording. Select this option when the distance between the camera and subject will change significantly during recording. The sound of the camera focusing may be heard in the recorded movie. Use of Single AF is recommended to prevent the sound of the camera focusing from interfering with recording.

Wind Noise Reduction

Enter shooting mode → MENU button →  menu icon → Wind noise reduction →  button

Option	Description
 On	Reduces the sound that is produced when wind passes over the microphone during movie recording. Other sounds may become difficult to hear during playback.
Off (default setting)	Wind noise reduction is disabled.

The Setup Menu

Time Zone and Date

Press the **MENU** button → **Y** menu icon → Time zone and date → **OK** button

Set the camera clock.

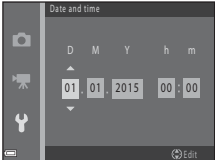
Option	Description
Date and time	<ul style="list-style-type: none">• Select a field: Press the multi selector ◀▶.• Edit the date and time: Press ▲▼.• Apply the setting: Select the minute setting and press the OK button. 
Date format	Select Year/Month/Day , Month/Day/Year , or Day/Month/Year .
Time zone	Set time zone and daylight saving time. <ul style="list-style-type: none">• When Travel destination (📍) is set after having set the home time zone (🏠), the time difference between the travel destination and the home time zone is automatically calculated, and the date and time are saved for the selected region.

Setting the Time Zone

- 1 Use the multi selector ▲▼ to select **Time zone** and press the **OK** button.

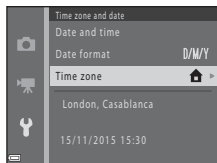

- 2 Select **Home time zone** or **Travel destination** and press the **OK** button.

- The date and time displayed in the monitor changes depending on whether the home time zone or travel destination is selected.

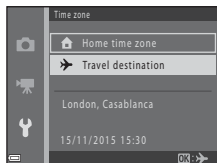

- 3 Press ►.

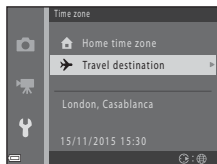

- 4 Use ◀▶ to select the time zone.

- Press ▲ to enable daylight saving time function, and ☀ is displayed. Press ▼ to disable the daylight saving time function.
- Press the **OK** button to apply the time zone.
- If the correct time is not displayed for the home or travel destination time zone setting, set the appropriate time in **Date and time**.

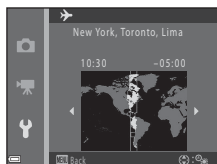







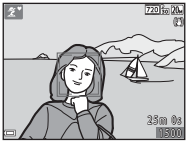

Monitor Settings

Press the **MENU** button → **Y** menu icon → Monitor settings → **OK** button

Option	Description
Photo info	Set whether or not to display information in the monitor.
Brightness	Adjust the brightness. <ul style="list-style-type: none">• Default setting: 3

Photo Info

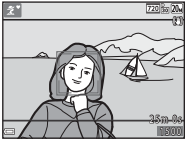
	Shooting mode	Playback mode
Show info	 The monitor shows a woman in a boat. Information is overlaid: top right shows '720' and '20'; bottom right shows '23m 0s' and '1500'.	 The monitor shows the same woman in a boat. Information is overlaid: top right shows '4/9'; bottom center shows '00:25' and 'OK'; bottom right shows '1500'.
Auto info (default setting)	The same information as shown in Show info is displayed, and it is hidden as shown in Hide info if no operations are performed for a few seconds. The information is displayed again when an operation is performed.	
Hide info	 The monitor shows the woman in a boat with no information overlaid.	 The monitor shows the woman in a boat with no information overlaid.

	Shooting mode	Playback mode
Framing grid+auto info	 <p>In addition to the information shown in Auto info, a framing grid is displayed to help frame pictures. The framing grid is not displayed while recording movies.</p>	 <p>Same as Auto info.</p>
Movie frame+auto info	 <p>In addition to the information shown in Auto info, a frame is displayed before movie recording begins that represents the area that will be captured when recording movies. The movie frame is not displayed while recording movies.</p>	 <p>Same as Auto info.</p>

Date Stamp

Press the **MENU** button → **Y** menu icon → Date stamp → **OK** button

The shooting date and time can be stamped on images when shooting. The information can be printed even when using a printer that does not support the date imprinting function.



Option	Description
DATE Date	Date is stamped on images.
DATE  Date and time	Date and time are stamped on images.
Off (default setting)	Date and time are not stamped on images.

Notes About Date Stamp

- Stamped dates form a permanent part of image data and cannot be deleted. The date and time cannot be stamped on images after they have been captured.
- The date and time cannot be stamped in the following situations:
 - When using **Panorama assist** or **Pet portrait** (when  **Continuous** is selected) scene mode
 - When shooting movies
- The stamped date and time may be difficult to read when using a small image size.

Printing a Shooting Date on Images Without a Date Stamp

You can transfer images to a computer and use the ViewNX 2 software ( 92) to imprint the shooting date on the images when they are printed.

Vibration Reduction

Press the **MENU** button → **V** menu icon → **Vibration reduction** → **OK** button

Select the vibration reduction setting used when shooting.

Select **Off** when using a tripod to stabilize the camera during shooting.

Option	Description
 On (default setting)	Compensation for camera shake is performed using lens shift VR.
Off	Compensation is not performed.

Notes About Vibration Reduction

- After turning on the camera or after switching from playback mode to shooting mode, wait for the shooting mode screen to be displayed completely before taking pictures.
- Images in the camera monitor may be displayed blurry immediately after shooting.
- The effects of camera shake may not be completely eliminated in some situations.

AF Assist

Press the **MENU** button → **V** menu icon → **AF assist** → **OK** button

Option	Description
AUTO Auto (default setting)	The AF-assist illuminator automatically lights up when you press the shutter-release button under dim lighting. The illuminator has a range of about 4.5 m (14 ft) at the maximum wide-angle position and about 3.0 m (9 ft 10 in.) at the maximum telephoto position. <ul style="list-style-type: none"> • Note that for some scene modes, the AF-assist illuminator may not light.
Off	The AF-assist illuminator does not light.

Sound Settings

Press the **MENU** button → **Y** menu icon → Sound settings → **OK** button

Option	Description
Button sound	<p>When On (default setting) is selected, the camera produces one beep when operations are performed, two beeps when focus is acquired on the subject, and three beeps when an error occurs. The start-up sound is also produced.</p> <ul style="list-style-type: none"> • Sounds are disabled when using Pet portrait scene mode.
Shutter sound	<p>When On (default setting) is selected, the shutter sound is produced when the shutter is released.</p> <ul style="list-style-type: none"> • The shutter sound is not produced when using continuous shooting mode, when recording movies, or when using Pet portrait scene mode.

Auto Off

Press the **MENU** button → **Y** menu icon → Auto off → **OK** button

Set the amount of time that elapses before the camera enters standby mode (📖13).

You can select **30 s** (default setting), **1 min**, **5 min**, or **30 min**.

Setting the Auto Off Function

The time that passes before the camera enters standby mode is fixed in the following situations:

- When a menu is displayed: 3 minutes
- When shooting using **Pet portrait auto release**: 5 minutes (when auto off is set to **30 s** or **1 min**)
- When shooting using **Smile timer**: 5 minutes (when auto off is set to **30 s** or **1 min**)
- When the AC Adapter EH-67 is connected: 30 minutes

Format Card/Format Memory

Press the **MENU** button → **Y** menu icon → Format card/Format memory → **OK** button

Use this option to format a memory card or the internal memory.

Formatting the memory cards or internal memory permanently deletes all data. Data that has been deleted cannot be recovered. Make sure to save important images to a computer before formatting.

Formatting a Memory Card

- Insert a memory card into the camera.
- Select **Format card** in the setup menu and then press the **OK** button.

Formatting the Internal Memory

- Remove the memory card from the camera.
- Select **Format memory** in the setup menu and then press the **OK** button.

To start formatting, select **Format** on the screen that is displayed and press the **OK** button.

- Do not turn the camera off or open the battery-chamber/memory card slot cover during formatting.

Language

Press the **MENU** button → **Y** menu icon → Language → **OK** button

Select a language for display of camera menus and messages.

Video Mode

Press the **MENU** button → **Y** menu icon → Video mode → **OK** button

Adjust settings for connection to a TV.

Select from **NTSC** and **PAL**.

Both **NTSC** and **PAL** are standards for analog color television broadcasting.

Reset All

Press the **MENU** button → **Y** menu icon → **Reset all** → **OK** button

When **Reset** is selected, the camera's settings are restored to their default values.

- Some settings, such as **Time zone and date** or **Language**, are not reset.



Resetting File Numbering

To reset file numbering to "0001", delete all images saved on the memory card or in the internal memory (📖17) before selecting **Reset all**.

Battery Type

Press the **MENU** button → **Y** menu icon → **Battery type** → **OK** button

To ensure that the camera shows the correct battery level (📖10), select the type that matches the batteries currently in use.

Option	Description
 Alkaline (default setting)	LR6/L40 (AA-size) alkaline batteries
 COOLPIX (Ni-MH)	Nikon EN-MH2 rechargeable Ni-MH (nickel metal hydride) batteries
 Lithium	FR6/L91 (AA-size) lithium batteries

Firmware Version

Press the **MENU** button → **Y** menu icon → **Firmware version** → **OK** button

View the current camera firmware version.

Connecting the Camera to a TV, Printer, or Computer

You can enhance your enjoyment of images and movies by connecting the camera to a TV, printer, or computer.

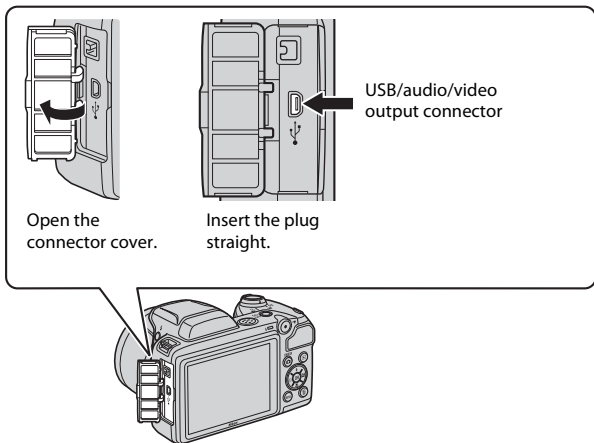

- Before connecting the camera to an external device, make sure the remaining battery level is sufficient and turn the camera off. Before disconnecting, make sure to turn the camera off.
- If the AC Adapter EH-67 (available separately) is used, this camera can be powered from an electrical outlet. Do not use any other make or model of AC adapter as it may cause the camera to heat up or malfunction.
- For information about the connection methods and subsequent operations, refer to the documentation included with the device in addition to this document.

Viewing images on a TV

📖 87



Images and movies captured with the camera can be viewed on a TV.

Connection method: Connect the video and audio plugs of the optional audio video cable to the TV's input jacks.

Printing images without using a computer

📖 88



If you connect the camera to a PictBridge-compatible printer, you can print images without using a computer.

Connection method: Connect the camera directly to the printer's USB port with the included USB cable.

Viewing and organizing images on a computer

📖 92



You can transfer images to a computer to perform simple retouching and manage image data.

Connection method: Connect the camera to the computer's USB port with the USB cable.

- Before connecting to a computer, install ViewNX 2 on the computer (📖 92).

Connecting the Camera to a TV (Playback on a TV)

1 Turn off the camera and connect it to the TV.

- Make sure that the plugs are properly oriented. Do not insert or remove the plugs at an angle when connecting or disconnecting them.

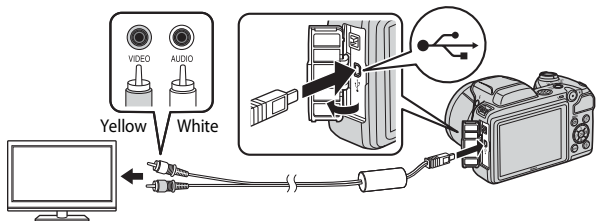

2 Set the TV's input to external input.

- See the documentation provided with your TV for details.

3 Hold down the (playback) button to turn on the camera.

- Images are displayed on the TV.
- The camera monitor does not turn on.

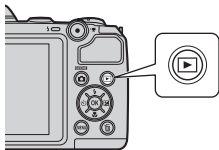

Connecting the Camera to a Printer (Direct Print)

Users of PictBridge-compatible printers can connect the camera directly to the printer and print images without using a computer.

Connecting the Camera to a Printer

- 1 Turn on the printer.
- 2 Turn off the camera and connect it to the printer using the USB cable.
 - Make sure that the plugs are properly oriented. Do not insert or remove the plugs at an angle when connecting or disconnecting them.

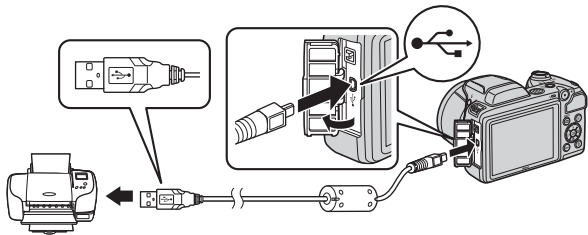

- 3 Turn on the camera.
 - The **PictBridge** startup screen (①) is displayed in the camera monitor, followed by the **Print selection** screen (②).



Printing Images One at a Time

- 1** Use the multi selector ◀▶ to select the desired image and press the **OK** button.

- Move the zoom control toward **W** (📐) to switch to thumbnail playback or **T** (🔍) to switch to full-frame playback.



- 2** Use ▲▼ to select **Copies** and press the **OK** button.

- Use ▲▼ to set the desired number of copies (up to nine) and press the **OK** button.

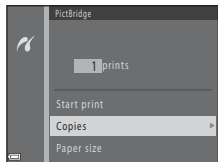

- 3** Select **Paper size** and press the **OK** button.

- Select the desired paper size and press the **OK** button.
- To print with the paper size setting configured on the printer, select **Default**.
- The paper size options available on the camera vary depending on the printer that you use.

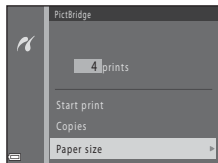

- 4** Select **Start print** and press the **OK** button.

- Printing starts.

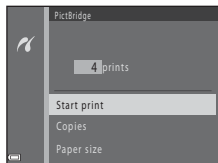

Printing Multiple Images

- 1 When the **Print selection** screen is displayed, press the **MENU** (menu) button.

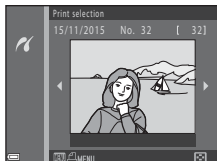

- 2 Use the multi selector ▲▼ to select **Paper size** and press the **OK** button.

- Select the desired paper size and press the **OK** button.
- To print with the paper size setting configured on the printer, select **Default**.
- The paper size options available on the camera vary depending on the printer that you use.
- To exit the print menu, press the **MENU** button.

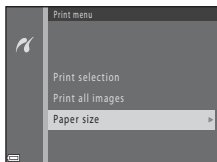

- 3 Select **Print selection** or **Print all images** and press the **OK** button.

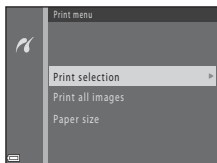

Print selection

Select images (up to 99) and the number of copies (up to 9) of each.

- Use the multi selector ◀▶ to select images, and use ▲▼ to specify the number of copies to be printed.
- Images selected for printing are indicated by 🖨️ and the number of copies to be printed. To cancel the print selection, set the number of copies to 0.
- Move the zoom control toward **T** (📷) to switch to full-frame playback or **W** (📱) to switch to thumbnail playback.
- Press the **OK** button when setting is complete. When the screen for confirming the number of print copies is displayed, select **Start print** and press the **OK** button to start printing.



Print all images

One copy each of all images saved in the internal memory, or on the memory card, is printed.

- When the screen for confirming the number of print copies is displayed, select **Start print** and press the **OK** button to start printing.

Using ViewNX 2 (Transferring Images to a Computer)

Installing ViewNX 2

ViewNX 2 is free software that enables you to transfer images and movies to your computer so that you can view, edit, or share them. To install ViewNX 2, download the ViewNX 2 installer from the website below and follow the on-screen installation instructions.

<http://nikonimglib.com/nvnx/>

For system requirements and other information, see the Nikon website for your region.

Transferring Images to a Computer

1 Prepare a memory card that contains images.

You can use any of the methods below to transfer images from the memory card to a computer.

- **SD memory card slot/card reader:** Insert the memory card into the card slot of your computer or the card reader (commercially available) that is connected to the computer.
- **Direct USB connection:** Turn the camera off and ensure that the memory card is inserted in the camera. Connect the camera to the computer using the USB cable. Turn the camera on.

To transfer images that are saved in the camera's internal memory, remove the memory card from the camera before connecting it to the computer.

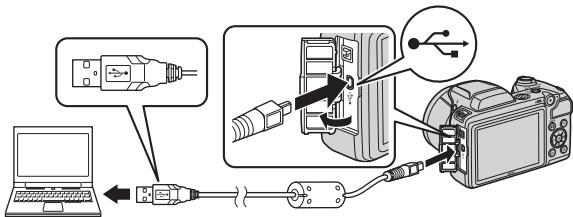

If a message is displayed prompting you to choose a program, select Nikon Transfer 2.

- **When using Windows 7**

If the dialog shown at right is displayed, follow the steps below to select Nikon Transfer 2.

- 1 Under **Import pictures and videos**, click **Change program**. A program selection dialog will be displayed; select **Import File using Nikon Transfer 2** and click **OK**.
- 2 Double-click **Import File**.



If the memory card contains a large number of images, it may take a while for Nikon Transfer 2 to start. Wait until Nikon Transfer 2 starts.

✓ Notes About Connecting the USB Cable

Operation is not guaranteed if the camera is connected to the computer via a USB hub.

2 After Nikon Transfer 2 starts, click **Start Transfer**.

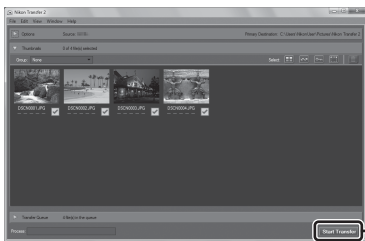

- Image transfer begins. When image transfer is complete, ViewNX 2 starts and the transferred images are displayed.
- Consult online help for more information on using ViewNX 2.

3 Terminate the connection.

- If you are using a card reader or card slot, choose the appropriate option in the computer operating system to eject the removable disk corresponding to the memory card and then remove the memory card from the card reader or card slot.
- If the camera is connected to the computer, turn the camera off and disconnect the USB cable.

Technical Notes

Caring for the Product	95
The Camera.....	95
Batteries	96
Memory Cards.....	97
Cleaning and Storage	98
Cleaning.....	98
Storage	98
Error Messages	99
Troubleshooting	102
File Names	108
Optional Accessories.....	109
Specifications.....	110
Approved Memory Cards	113
Index.....	115

Caring for the Product

Observe the precautions described below in addition to the warnings in "For Your Safety" (v–vii) when using or storing the device.

The Camera

Do Not Apply Strong Impact to the Camera

The product may malfunction if subjected to strong shock or vibration. In addition, do not touch or apply force to the lens.

Keep Dry

The device will be damaged if immersed in water or subjected to high humidity.

Avoid Sudden Changes in Temperature

Sudden changes in temperature, such as when entering or leaving a heated building on a cold day, can cause condensation to form inside the device. To prevent condensation, place the device in a carrying case or a plastic bag before exposing it to sudden changes in temperature.

Keep Away from Strong Magnetic Fields

Do not use or store this device in the vicinity of equipment that generates strong electromagnetic radiation or magnetic fields. Doing so could result in loss of data or camera malfunction.

Do Not Point the Lens at Strong Light Sources for Extended Periods

Avoid pointing the lens at the sun or other strong light sources for extended periods when using or storing the camera. Intense light may cause the image sensor to deteriorate or produce a white blur effect in photographs.

Turn the Product Off Before Removing or Disconnecting the Power Source or Memory Card

Do not remove the batteries while the product is on, or while images are being saved or deleted. Forcibly cutting power in these circumstances could result in loss of data or in damage to product memory or internal circuitry.

Notes About the Monitor

- Monitors and electronic viewfinders are constructed with extremely high precision; at least 99.99% of pixels are effective, with no more than 0.01% being missing or defective. Hence while these displays may contain pixels that are always lit (white, red, blue, or green) or always off (black), this is not a malfunction and has no effect on images recorded with the device.
- Images in the monitor may be difficult to see under bright lighting.
- Do not apply pressure to the monitor, as this could cause damage or malfunction. Should the monitor break, care should be taken to avoid injury caused by broken glass and to prevent the liquid crystal from the display touching the skin or entering the eyes or mouth.

Notes About Smear

White or colored streaks may be visible when bright subjects are framed in the monitor. This phenomenon, known as “smear,” occurs when extremely bright light strikes the image sensor; it is characteristic of image sensors and does not indicate a malfunction. Smear may also take the form of partial discoloration in the monitor during shooting. It does not appear in images saved with the camera except in the case of movies. When shooting movies, we recommend that you avoid bright subjects such as the sun, reflected sunlight, and electric lights.

Batteries

Precautions for Use

- Note that the batteries may become hot after use.
- Do not use batteries beyond their recommended expiration date.
- Do not turn the camera on and off repeatedly if discharged batteries are inserted in the camera.

Carrying Spare Batteries

We recommend carrying spare batteries depending on where you are shooting. It may be difficult to purchase batteries in certain areas.

Charging Batteries

If using optional rechargeable batteries, charge the batteries before taking pictures. Batteries are not fully charged at the time of purchase.

Be sure to read and follow the warnings noted in the operating instructions included with the battery charger.

Charging Rechargeable Batteries

- Do not mix batteries with different amounts of charge remaining, or batteries of a different make or model.
- When using EN-MH2 batteries with this camera, charge four batteries at a time using Battery Charger MH-73. Use only Battery Charger MH-73 to charge EN-MH2 batteries.
- When using Battery Charger MH-73, only charge EN-MH2 batteries.
- EN-MH1 rechargeable Ni-MH batteries cannot be used.

Notes About Rechargeable Ni-MH Batteries

- If you repeatedly charge rechargeable Ni-MH batteries while they still have some charge remaining, the message **Battery exhausted.** may be displayed prematurely when using the batteries. This is due to the “memory effect,” in which the amount of charge the batteries can hold decreases temporarily. Use the batteries until there is no charge remaining and they will return to their normal behavior.
- Rechargeable Ni-MH batteries discharge even when not being used. We recommend charging the batteries just before using them.

Using the Batteries When Cold

On cold days, the capacity of batteries tends to decrease. If exhausted batteries are used at a low temperature, the camera may not turn on. Keep spare batteries in a warm place and exchange as necessary. Once warmed, cold batteries may recover some of their charge.

Battery Terminals

Dirt on the battery terminals may prevent the camera from functioning. Should the battery terminals become dirty, wipe them off with a clean, dry cloth before use.

Remaining Battery Charge

If you insert discharged batteries into the camera, the camera may indicate that the batteries have adequate charge remaining. This is a characteristic of batteries.

Recycling Used Batteries

Replace the batteries when they no longer hold a charge. Used batteries are a valuable resource. Please recycle used batteries in accordance with local regulations.

Memory Cards

Precautions for Use

- Use only Secure Digital memory cards. See "Approved Memory Cards" (📖113) for recommended memory cards.
- Be sure to follow the precautions described in the documentation included with the memory card.
- Do not put labels or stickers on memory cards.

Formatting

- Do not format the memory card using a computer.
- The first time you insert a memory card that has been used in another device into this camera, be sure to format it with this camera.
We recommend formatting new memory cards with this camera before using them with this camera.
- **Note that formatting a memory card permanently deletes all images and other data on the memory card.** Be sure to make copies of any images you wish to keep before formatting the memory card.
- If the message **Card is not formatted. Format card?** is displayed when the camera is turned on, the memory card must be formatted. If there is data that you do not want to delete, select **No**. Copy the necessary data to a computer, etc. If you want to format the memory card, select **Yes**. The confirmation dialog will be displayed. To start formatting, press the **OK** button.
- Do not perform the following during formatting, while data is being written to or deleted from the memory card, or during data transfer to a computer. Failure to observe this precaution could result in the loss of data or in damage to the camera or memory card:
 - Open the battery-chamber/memory card slot cover to remove/insert the batteries or memory card.
 - Turn off the camera.
 - Disconnect the AC adapter.

Cleaning and Storage

Cleaning

Do not use alcohol, thinner, or other volatile chemicals.

Lens	Avoid touching glass parts with your fingers. Remove dust or lint with a blower (typically a small device with a rubber bulb attached to one end that is pumped to produce a stream of air out the other end). To remove fingerprints or other stains that cannot be removed with a blower, wipe the lens with a soft cloth, using a spiral motion that starts at the center of the lens and working toward the edges. If this fails, clean the lens using a cloth lightly dampened with commercial lens cleaner.
Monitor	Remove dust or lint with a blower. To remove fingerprints and other stains, clean the monitor with a soft, dry cloth, being careful not to apply pressure.
Body	Use a blower to remove dust, dirt, or sand, then wipe gently with a soft, dry cloth. After using the camera at the beach or other sandy or dusty environment, wipe off any sand, dust, or salt with a dry cloth lightly dampened with fresh water and dry thoroughly. Note that foreign matter inside the camera could cause damage not covered by the warranty.



Storage



Remove the batteries if the camera will not be used for an extended period. To prevent mold or mildew, take the camera out of storage at least once a month. Turn the camera on and release the shutter a few times before putting the camera away again. Do not store the camera in any of the following locations:







- Places that are poorly ventilated or subject to humidity of over 60%
- Exposed to temperatures above 50°C (122°F) or below -10°C (14°F)
- Next to equipment that produces strong electromagnetic fields, such as televisions or radios

Error Messages

Refer to the table below if an error message is displayed.

Display	Cause/Solution	
Turn the camera off, remove the lens cap, and turn the camera on.	The lens cap may be attached, or a lens error occurred. Make sure that the lens cap has been removed, and turn the camera off and then on again. If the error persists, contact your retailer or Nikon-authorized service representative.	6, 102
Memory card is write protected.	The write-protect switch is in the "lock" position. Slide the write-protect switch to the "write" position.	–
This card cannot be used.	An error occurred while accessing the memory card. <ul style="list-style-type: none"> • Use an approved memory card. • Check that the terminals are clean. • Confirm that the memory card is correctly inserted. 	7, 113
This card cannot be read.		
Card is not formatted. Format card?	The memory card has not been formatted for use in the camera. Formatting deletes all data saved on the memory card. If you need to keep copies of any images, make sure to select No and save the copies to a computer or other medium before formatting the memory card. Select Yes and press the  button to format the memory card.	97
Out of memory.	Delete images or insert a new memory card.	7, 17
Image cannot be saved.	An error occurred while saving the image. Insert a new memory card or format the memory card or internal memory.	82
	The camera has run out of file numbers. Insert a new memory card or format the memory card or internal memory.	82
	There is insufficient space to save the copy. Delete images from the destination.	17

Display	Cause/Solution	
Image cannot be modified.	Check that the images can be edited.	47, 106
Cannot record movie.	A time-out error occurred while saving the movie on the memory card. Select a memory card with a faster write speed.	53, 113
Memory contains no images.	There are no images in the internal memory or on the memory card. <ul style="list-style-type: none"> Remove the memory card to play back images in the internal memory. To copy the images saved in the camera's internal memory to the memory card, press the MENU button to select Copy in the playback menu. 	8 71
File contains no image data.	The file was not created or edited with this camera. The file cannot be viewed on this camera. View the file using a computer or the device used to create or edit this file.	–
All images are hidden.	There are no images available for a slide show, etc.	69
This image cannot be deleted.	The image is protected. Disable protection.	70
Raise the flash.	The flash is lowered. Raise the flash when shooting in Night portrait or Backlighting scene mode.	24, 25, 32
Communications error	An error occurred while communicating with the printer. Turn the camera off and reconnect the USB cable.	88
System error	An error occurred in the camera's internal circuitry. Turn the camera off, remove and reinsert the batteries, and turn the camera on. If the error persists, contact your retailer or Nikon-authorized service representative.	102
Printer error: check printer status.	After solving the problem, select Resume and press the  button to resume printing.*	–
Printer error: check paper.	Load the specified size of paper, select Resume , and press the  button to resume printing.*	–

Display	Cause/Solution	
Printer error: paper jam.	Remove the jammed paper, select Resume , and press the  button to resume printing.*	–
Printer error: out of paper.	Load the specified size of paper, select Resume , and press the  button to resume printing.*	–
Printer error: check ink.	There is a problem with the printer's ink. Check the ink, select Resume , and press the  button to resume printing.*	–
Printer error: out of ink.	Replace the ink cartridge, select Resume , and press the  button to resume printing.*	–
Printer error: file corrupt.	There is a problem with the image file to be printed. Select Cancel and press the  button to cancel printing.	–



* See the documentation provided with your printer for further guidance and information.

Troubleshooting



If the camera fails to function as expected, check the list of common problems below before consulting your retailer or Nikon-authorized service representative.

Power, Display, Settings Issues









Problem	Cause/Solution	
The camera is on but does not respond.	Wait for recording to end. If the problem persists, turn the camera off. If the camera does not turn off, remove and reinsert the battery or batteries or, if you are using an AC adapter, disconnect and reconnect the AC adapter. Note that although any data currently being recorded will be lost, data that have already been recorded will not be affected by removing or disconnecting the power source.	–
The camera cannot be turned on.	The batteries are exhausted.	7, 96
The camera turns off without warning.	<ul style="list-style-type: none">• The camera automatically turns off to save power (auto off function).• The camera and batteries may not work properly at low temperatures.• The inside of the camera has become hot. Leave the camera off until the inside of the camera has cooled, and then try turning it on again.	13 96 –
The monitor is blank.	<ul style="list-style-type: none">• The camera is off.• The camera automatically turns off to save power (auto off function).• The flash lamp flashes while the flash is charging. Wait until charging is complete.• The camera is connected to a TV or computer.	9 13 – –
The camera becomes hot.	The camera may become hot when used for an extended period of time to shoot movies or when used in a hot environment; this is not a malfunction.	–
The monitor is hard to read.	<ul style="list-style-type: none">• Adjust the monitor brightness.• The monitor is dirty. Clean the monitor.	77 98

Problem	Cause/Solution	
 flashes on the screen. Date and time of recording are not correct.	<ul style="list-style-type: none"> If the camera clock has not been set,  flashes on the shooting screen, and images and movies saved before the clock is set are dated "00/00/0000 00:00" and "01/01/2015 00:00" respectively. Set the correct time and date for Time zone and date in the setup menu. The camera clock is not as accurate as ordinary watches or clocks. Periodically compare the time of the camera clock with that of a more accurate timepiece, and reset as required. 	3, 75
No indicators displayed in monitor.	Hide info is selected for Photo info in Monitor settings in the setup menu.	77
Date stamp not available.	Time zone and date has not been set in the setup menu.	75
Date not stamped on images even when Date stamp is enabled.	<ul style="list-style-type: none"> The current shooting mode does not support Date stamp. The date cannot be stamped on movies. 	79
Screen for setting time zone and date is displayed when the camera is turned on.	The clock battery is exhausted; all settings were restored to their default values.	9, 11
The camera settings reset.		
The camera makes sound.	When Autofocus mode is set to Full-time AF or while in some shooting modes, the camera may produce an audible focusing sound.	19, 73

Shooting Issues

Problem	Cause/Solution	
Cannot switch to shooting mode.	Disconnect the USB cable.	85
Cannot take pictures or record movies.	<ul style="list-style-type: none"> When the camera is in playback mode, press the  button, Shutter-release button, or  button. When menus are displayed, press the MENU button. The flash is charging while the flash lamp is flashing. The batteries are exhausted. 	1, 16
		58
		33
		7, 96

Problem	Cause/Solution	
The camera cannot focus.	<ul style="list-style-type: none"> The subject is too close. Try shooting using scene auto selector mode, Close-up scene mode, or macro mode. The subject is hard to focus on. Set AF assist in the setup menu to Auto. Turn the camera off and then on again. 	19, 20, 22, 24, 35 42 80 –
Images are blurred.	<ul style="list-style-type: none"> Use the flash. Increase the ISO sensitivity value. Enable Vibration reduction. Use a tripod to stabilize the camera (using the self-timer at the same time is more effective). 	32 65 80 34
Streaks of light or partial discoloration are visible in the monitor.	Smear may occur when extremely bright light strikes the image sensor. When recording movies, avoiding bright objects, such as the sun, reflections of the sun, and electric lights is recommended.	96
Bright specks appear in images captured with flash.	The flash is reflecting off particles in the air. Lower the flash.	11, 32
Flash does not fire.	<ul style="list-style-type: none"> The flash is lowered. A scene mode that restricts the flash is selected. A function that restricts the flash is enabled. 	11, 32 37 44
Digital zoom cannot be used.	Digital zoom cannot be used in the following shooting modes: <ul style="list-style-type: none"> Portrait, Night portrait, or Pet portrait scene mode Smart portrait mode 	23 30
No sound when the shutter is released.	<ul style="list-style-type: none"> Off is selected for Shutter sound in Sound settings in the setup menu. No sound is produced with some shooting modes and settings, even when On is selected. Do not block the speaker. 	81 1
AF-assist illuminator does not light.	Off is selected for AF assist in the setup menu. AF-assist illuminator may not light depending on the current scene mode, even when Auto is selected.	80

Problem	Cause/Solution	
Images appear smeared.	The lens is dirty. Clean the lens.	98
Colors are unnatural.	White balance or hue is not adjusted properly.	24, 62
Randomly spaced bright pixels ("noise") appear in image.	The subject is dark and the shutter speed is too slow, or ISO sensitivity is too high. Noise can be reduced by: <ul style="list-style-type: none"> Using the flash Specifying a lower ISO sensitivity setting 	32 65
Images are too dark (underexposed).	<ul style="list-style-type: none"> The flash is lowered or a shooting mode that restricts the flash is selected. The flash window is blocked. The subject is beyond the range of the flash. Adjust exposure compensation. Increase ISO sensitivity. The subject is backlit. Select Backlighting scene mode or raise the flash and set the flash mode setting to  (fill flash). 	11, 32, 37 12 111 36 65 25, 32
Images are too bright (overexposed).	Adjust exposure compensation.	36
Unexpected results when flash set to   (auto with red-eye reduction).	Use any scene mode other than Night portrait , and change the flash mode to any setting other than   (auto with red-eye reduction) and try taking the picture again.	32, 37
Skin tones are not softened.	<ul style="list-style-type: none"> In some shooting conditions, facial skin tones may not be softened. For images containing four or more faces, try using the Skin softening effect in the playback menu. 	40 49
Saving images takes time.	It may take more time to save images in the following situations: <ul style="list-style-type: none"> When the noise reduction function is in operation, such as when shooting in a dark environment When shooting in Panorama assist scene mode When the flash mode is set to   (auto with red-eye reduction) When the skin softening function is applied while shooting 	– 26 33 40, 67

Playback Issues

Problem	Cause/Solution	
File cannot be played back.	<ul style="list-style-type: none"> • This camera may not be able to play back images saved with another make or model of digital camera. • This camera cannot play back movies recorded with another make or model of digital camera. • This camera may not be able to play back data edited on a computer. 	–
Cannot zoom in on image.	<ul style="list-style-type: none"> • Playback zoom cannot be used with movies, and images with an image size of 160 × 120 or smaller. • When viewing small images, the playback magnification rate that is displayed may not match the actual image magnification rate. • This camera may not be able to zoom in on images captured with another make or model of digital camera. 	–
Cannot edit images.	<ul style="list-style-type: none"> • Images with an image size of 160 × 120 or smaller cannot be edited. • Some images cannot be edited. Images that have already been edited may not be edited again. • There is not enough free space on the memory card or in the internal memory. • This camera is unable to edit images captured with other cameras. • Editing functions used for images are not available for movies. 	– 47 – – –
Cannot rotate image.	This camera cannot rotate images captured with another make or model of digital camera.	–
Images are not displayed on TV.	<ul style="list-style-type: none"> • Video mode is not correctly set in the setup menu. • The memory card contains no images. • Remove the memory card to play back images in the internal memory. 	58, 83 – 8
Nikon Transfer 2 does not start when the camera is connected to a computer.	<ul style="list-style-type: none"> • The camera is off. • The batteries are exhausted. • The USB cable is not correctly connected. • The camera is not recognized by the computer. • The computer is not set to start Nikon Transfer 2 automatically. For more information about Nikon Transfer 2, refer to help information contained in ViewNX 2. 	– 85 85, 92 – –

Problem	Cause/Solution	
Images to be printed are not displayed.	<ul style="list-style-type: none"> • The memory card contains no images. • Remove the memory card to print images in the internal memory. 	– 8
Cannot select paper size with the camera.	<p>The camera cannot be used to select the paper size in the following situations, even when printing from a PictBridge-compatible printer. Use the printer to select the paper size.</p> <ul style="list-style-type: none"> • The printer does not support the paper sizes specified by the camera. • The printer automatically selects the paper size. 	–

File Names

Images or movies are assigned file names as follows.

File name: DSCN0001.JPG

(1) (2) (3)

(1) Identifier	Not shown on the screen of the camera. <ul style="list-style-type: none">• DSCN: Original still images, movies• SSCN: Small picture copies• RSCN: Cropped copies• FSCN: Images created by an image editing function other than crop and small picture, movies created by the movie editing function
(2) File number	Assigned in ascending order, starting with "0001" and ending with "9999."
(3) Extension	Indicates file format. <ul style="list-style-type: none">• .JPG: Still images• .MOV: Movies

Optional Accessories

Battery charger, rechargeable batteries*	<ul style="list-style-type: none">• Battery Charger MH-73 (includes four EN-MH2 rechargeable Ni-MH batteries)• Replacement rechargeable batteries: Rechargeable Ni-MH batteries EN-MH2-B4 (set of four EN-MH2 batteries)
AC adapter	AC Adapter EH-67
Audio/video cable	Audio Video Cable EG-CP14
Hand strap	Hand Strap AH-CP1

* When using EN-MH2 rechargeable Ni-MH batteries with the camera, charge the batteries four at a time using Battery Charger MH-73. Also, do not charge batteries at the same time if they have different amounts of charge remaining (📖96). EN-MH1 rechargeable Ni-MH batteries cannot be used.

Availability may vary with country or region.

See our website or brochures for the latest information.

Specifications

Nikon COOLPIX L340 Digital Camera

Type	Compact digital camera
Number of effective pixels	20.2 million (Image processing may reduce the number of effective pixels.)
Image sensor	$\frac{1}{2.3}$ -in. type CCD; approx. 20.48 million total pixels
Lens	NIKKOR lens with 28x optical zoom
Focal length	4.0–112 mm (angle of view equivalent to that of 22.5–630 mm lens in 35mm [135] format)
f/-number	f/3.1–5.9
Construction	12 elements in 9 groups (1 ED lens element)
Digital zoom magnification	Up to 4x (angle of view equivalent to that of approx. 2520 mm lens in 35mm [135] format)
Vibration reduction	Lens shift
Autofocus (AF)	Contrast-detect AF
Focus range	<ul style="list-style-type: none">• [W]: Approx. 50 cm (1 ft 8 in.)–∞, [T]: Approx. 1.5 m (5 ft)–∞• Macro mode: Approx. 1 cm (0.4 in.) (when zoom is set to middle position)–∞ (All distances measured from center of front surface of lens)
Focus-area selection	Center, face detection, target finding AF
Monitor	7.5 cm (3-in.), approx. 460k-dot, TFT LCD with anti-reflection coating and 5-level brightness adjustment
Frame coverage (shooting mode)	Approx. 99% horizontal and vertical (compared to actual picture)
Frame coverage (playback mode)	Approx. 100% horizontal and vertical (compared to actual picture)
Storage	
Media	Internal memory (approx. 43 MB), SD/SDHC/SDXC memory card
File system	DCF and Exif 2.3 compliant
File formats	Still images: JPEG Movies: MOV (Video: H.264/MPEG-4 AVC, Audio: PCM monaural)

Image size (pixels)	<ul style="list-style-type: none"> • 20M (High) [5152 × 3864★] • 20M [5152 × 3864] • 10M [3648 × 2736] • 4M [2272 × 1704] • 2M [1600 × 1200] • VGA [640 × 480] • 16:9 [5120 × 2880] • 1:1 [3864 × 3864]
ISO sensitivity (Standard output sensitivity)	ISO 80–1600
Exposure	
Metering mode	Matrix, center-weighted (digital zoom less than 2×), spot (digital zoom 2× or more)
Exposure control	Programmed auto exposure and exposure compensation (–2.0 – +2.0 EV in steps of 1/3 EV)
Shutter	Mechanical and charge-coupled electronic shutter
Speed	<ul style="list-style-type: none"> • 1/1500–1 s • 4 s (Fireworks show scene mode)
Aperture	Electronically-controlled ND filter (–3.3 AV) selection
Range	2 steps (f/3.1 and f/9.9 [W])
Self-timer	10 s
Flash	
Range (approx.) (ISO sensitivity: Auto)	[W]: 0.5–4.7 m (1 ft 8 in.–15 ft) [T]: 1.5–2.4 m (5 ft–7 ft 10 in.)
Flash control	TTL auto flash with monitor preflashes
Interface	
USB connector	Hi-Speed USB <ul style="list-style-type: none"> • Supports Direct Print (PictBridge) • Also used as audio/video output connector (NTSC or PAL can be selected for video output.)
DC input connector	For AC Adapter EH-67 (available separately)
Supported languages	Arabic, Bengali, Bulgarian, Chinese (Simplified and Traditional), Czech, Danish, Dutch, English, Finnish, French, German, Greek, Hindi, Hungarian, Indonesian, Italian, Japanese, Korean, Marathi, Norwegian, Persian, Polish, Portuguese (European and Brazilian), Romanian, Russian, Serbian, Spanish, Swedish, Tamil, Telugu, Thai, Turkish, Ukrainian, Vietnamese

Power sources	<ul style="list-style-type: none"> • Four LR6/L40 (AA-size) alkaline batteries • Four FR6/L91 (AA-size) lithium batteries • Four EN-MH2 rechargeable Ni-MH batteries (available separately) • AC Adapter EH-67 (available separately)
Battery life¹	
Still images	<ul style="list-style-type: none"> • Approx. 370 shots when using alkaline batteries • Approx. 960 shots when using lithium batteries • Approx. 600 shots when using EN-MH2 batteries
Movies (actual battery life for recording)²	<ul style="list-style-type: none"> • Approx. 2 h 5 min when using alkaline batteries • Approx. 5 h 40 min when using lithium batteries • Approx. 3 h 40 min when using EN-MH2 batteries
Tripod socket	1/4 (ISO 1222)
Dimensions (W × H × D)	Approx. 111.1 × 76.3 × 83.3 mm (4.4 × 3.1 × 3.3 in.) (excluding projections)
Weight	Approx. 430 g (15.2 oz) (including batteries and memory card)
Operating environment	
Temperature	0°C–40°C (32°F–104°F)
Humidity	85% or less (no condensation)

- Unless otherwise stated, all figures assume fresh LR6/L40 (AA-size) alkaline batteries and an ambient temperature of 23 ±3°C (73.4 ±5.4°F) as specified by the Camera and Imaging Products Association (CIPA).

¹ Battery life may vary depending on conditions of use, such as the interval between shots or the length of time that menus and images are displayed. The included batteries are for trial use only. Figures listed for lithium batteries are measured using commercially available FR6/L91 (AA-size) Energizer(R) Ultimate Lithium batteries.

² Individual movie files cannot exceed 4 GB in size or 29 minutes in length. Recording may end before this limit is reached if camera temperature becomes elevated.

- Nikon will not be held liable for any errors this manual may contain.
- The appearance of this product and its specifications are subject to change without notice.

Approved Memory Cards

The following Secure Digital (SD) memory cards have been tested and approved for use in this camera.

- Memory cards with an SD Speed Class rating of 6 or faster are recommended for recording movies. When using a memory card with a lower Speed Class rating, movie recording may stop unexpectedly.

	SD memory card	SDHC memory card	SDXC memory card
SanDisk	–	4 GB, 8 GB, 16 GB, 32 GB	64 GB, 128 GB
TOSHIBA	–	4 GB, 8 GB, 16 GB, 32 GB	64 GB
Panasonic	2 GB	4 GB, 8 GB, 16 GB, 32 GB	64 GB
Lexar	–	8 GB, 16 GB, 32 GB	64 GB, 128 GB

- Contact the manufacturer for details on the above cards. We cannot guarantee camera performance when using memory cards made by other manufacturers.
- If you use a card reader, make sure that it is compatible with your memory card.

Trademark Information

- Windows is either a registered trademark or trademark of Microsoft Corporation in the United States and/or other countries.
- Adobe, the Adobe logo, and Reader are either trademarks or registered trademarks of Adobe Systems Incorporated in the United States and/or other countries.
- SDXC, SDHC, and SD Logos are trademarks of SD-3C, LLC.



- PictBridge is a trademark.
- All other trade names mentioned in this manual or the other documentation provided with your Nikon product are the trademarks or registered trademarks of their respective holders.

AVC Patent Portfolio License

This product is licensed under the AVC Patent Portfolio License for the personal and non-commercial use of a consumer to (i) encode video in compliance with the AVC standard ("AVC video") and/or (ii) decode AVC video that was encoded by a consumer engaged in a personal and non-commercial activity and/or was obtained from a video provider licensed to provide AVC video. No license is granted or shall be implied for any other use. Additional information may be obtained from MPEG LA, L.L.C.

See <http://www.mpegla.com>.

FreeType License (FreeType2)

Portions of this software are copyright © 2012 The FreeType Project (<http://www.freetype.org>). All rights reserved.

MIT License (HarfBuzz)

Portions of this software are copyright © 2015 The HarfBuzz Project (<http://www.freedesktop.org/wiki/Software/HarfBuzz>). All rights reserved.

Index

Symbols

AE/AF-L 27

T (Telephoto) 14

W (Wide-angle) 14

Q Playback zoom 16, 45

Thumbnail playback 16, 46

SCN Scene auto selector mode

..... 19, 22

S Scene mode 19, 23

SE Special effects mode 19, 29

Smart portrait mode 19, 30

Auto mode 19, 31

Playback mode 16

Y Setup menu 58, 75

OK Apply selection button 2, 58

Shooting mode button 2, 19

Movie-record) button 2, 21

Playback button 2, 16

Delete button 2, 17

MENU Menu button 2, 58

Flash (pop-up) button 1, 11, 32

Flash mode 20, 32

Self-timer 20, 34

Macro mode 20, 35

Exposure compensation 20, 36

Help 23

A

AC adapter 109

AF area mode 66

AF assist 80

AF-assist illuminator 1

Alkaline batteries 7

Aperture value 15

Audio/video cable 86, 87, 109

Audio/video-in jack 86, 87

Auto flash 33

Auto mode 19, 31

Auto off 13, 81

Autofocus 42, 73

Autofocus mode 73

B

Backlighting 23, 25

Battery 7, 11

Battery charger 109

Battery level 10

Battery type 84

Battery-chamber/memory card slot

cover 2

Beach 23

Blink proof 68

Brightness 77

Button sound 81

C

Calendar display 46

Close-up 23, 24

Compression ratio 60

Computer 86, 92

Connector cover 1

Continuous shooting 64

Copy 71

Crop 45, 51

Cyanotype **CO** 29

D

Date and time 9, 75

Date format 9, 75











Date stamp 79







Daylight saving time 9, 76

DC input connector 1

Delete 17

Digital zoom 14

Direct print	86, 88	L	Landscape 	23
D-Lighting	48	Language.....		83
Dusk/dawn 	23	Lens.....		1, 110
E		Lithium batteries.....		7
Editing images.....	47	M		
Editing movies.....	56	Macro mode.....		20, 35
EN-MH2.....	96, 109	Memory card.....		7, 97, 113
Exposure compensation.....	20, 36	Memory card slot.....		7
Eyelet for camera strap.....	1	Microphone.....		2
E		Monitor.....		2, 3, 98
Face detection.....	39	Monitor settings.....		77
File names.....	108	Movie menu.....		58, 73
Fill flash.....	33	Movie options.....		73
Fireworks show 	23, 24	Movie recording.....		21, 52
Firmware version.....	84	Multi selector.....		2, 58
Flash.....	1, 11, 32	N		
Flash lamp.....	2, 33	Night landscape 		23
Flash mode.....	20, 32	Night portrait 		23, 24
Focus.....	39	Nikon Transfer 2.....		93
Focus area.....	13	Nostalgic sepia SE		29
Focus indicator.....	3	Number of exposures remaining		
Focus lock.....	43		10, 61
Food 	23, 24	O		
Format internal memory.....	82	Optical zoom.....		14
Format memory cards.....	7, 82	Optional accessories.....		109
Formatting.....	7, 82	P		
Full-frame playback.....	16	Panorama assist playback.....		28
Full-time AF.....	73	Panorama assist 		23, 26
H		Paper size.....		89, 90
Help.....	23	Party/indoor 		23, 24
High-contrast monochrome 		Pet portrait auto release.....		25
.....	29	Pet portrait 		23, 25
I		Photo illustration 		29
Image mode.....	60	Photo info.....		77
Internal memory.....	8	PictBridge.....		86, 88
ISO sensitivity.....	65	Playback.....		16, 55

Playback menu	58, 69	Single-frame shooting.....	64
Playback mode	16	Skin softening.....	49, 67
Playback zoom.....	16, 45	Slide show	69
Pop 	29	Slow sync.....	33
Portrait 	23	Small picture.....	50
Power switch/power-on lamp... 1, 9		Smart portrait menu.....	58, 67
Preset manual	63	Smart portrait mode.....	19, 30
Pressing halfway	15	Smile timer	67
Print	86, 89, 90	Snow 	23
Printer	86, 88	Sound settings	81
Protect.....	70	Speaker	1
Q		Special effects mode.....	19, 29
Quick effects.....	47	Sports 	23, 24
R		Strap.....	6
Rechargeable battery	109	Sunset 	23
Rechargeable nickel-metal hydride batteries	7	T	
Red-eye reduction.....	33	Target finding AF.....	41, 66
Remaining movie recording time	52, 53	Telephoto.....	14
Reset all	84	Thumbnail playback.....	16, 46
Rotate image	70	Time difference.....	76
S		Time zone.....	9, 75
Scene auto selector mode.... 19, 22		Time zone and date.....	9, 75
Scene mode	19, 23	Tripod socket.....	2, 112
SD Memory card.....	7, 97, 113	TV.....	86, 87
Selective color 	29	U	
Self-timer	20, 34	USB cable.....	85, 88, 92
Self-timer lamp	1, 34	USB/audio/video output connector	1, 85, 87, 88, 92
Setup menu.....	58, 75	V	
Shooting	12, 19	Vibration reduction	80
Shooting menu	58, 60	Video mode	83
Shooting mode	19	ViewNX 2.....	92
Shutter sound.....	81	Volume.....	55
Shutter speed.....	15	W	
Shutter-release button	1, 13	White balance.....	62
Single AF	73	Wide-angle	14
		Wind noise reduction.....	74

Z

Zoom	14
Zoom control	1, 12, 14
Zoom in.....	14
Zoom out.....	14

No reproduction in any form of this manual, in whole or in part (except for brief quotation in critical articles or reviews), may be made without written authorization from NIKON CORPORATION.

NIKON CORPORATION

© 2015 Nikon Corporation



CT4L01(11)

6MN51311-01

Download from www.Softmanuals.com. All Manuals Search And Download.

Free Manuals Download Website

<http://myh66.com>

<http://usermanuals.us>

<http://www.somanuals.com>

<http://www.4manuals.cc>

<http://www.manual-lib.com>

<http://www.404manual.com>

<http://www.luxmanual.com>

<http://aubethermostatmanual.com>

Golf course search by state

<http://golfingnear.com>

Email search by domain

<http://emailbydomain.com>

Auto manuals search

<http://auto.somanuals.com>

TV manuals search

<http://tv.somanuals.com>