

Nikon

FG

INSTRUCTION MANUAL

NOMENCLATURE

- 1 Film advance lever
- 2 A/P setting lock button
- 3 Shutter speed/mode selector
- 4 Neckstrap eyelet
- 5 Hand grip
- 6 Self-timer lever
- 7 Reflex mirror
- 8 Lens aperture scale
- 9 Distance scale
- 10 Depth-of-field indicators
- 11 Aperture/distance scale index



- 12 Exposure compensation dial lock
- 13 Exposure compensation dial
- 14 Exposure compensation dial index
- 15 Exposure compensation button
- 16 Meter coupling lever
- 17 Lens mounting index
- 18 Lens release button
- 19 Infrared focusing index
- 20 Lens aperture ring
- 21 Lens mounting ring
- 22 Lens focusing ring

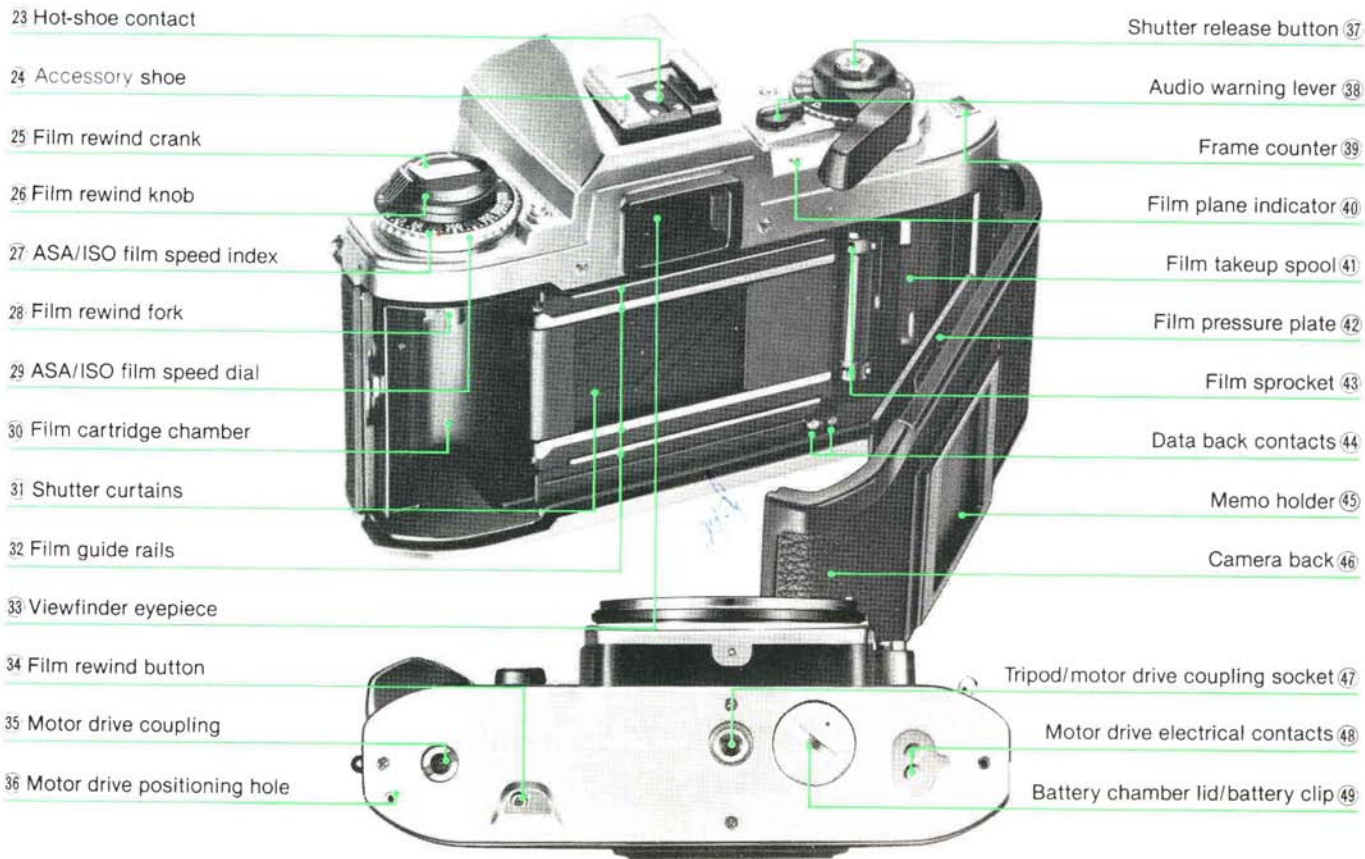

NOMENCLATURE	2
FOREWORD	5
BASIC OPERATION	6
NIKON AND NIKKOR LENSES	
FOR THE NIKON FG	19
CONTROLS IN DETAIL	20
Shutter Speed/Mode Selector Dial.	20
Exposure Measuring System.	21
LED Viewfinder Indications.	22
Exposure information.	22
Improper exposure warning information. .	23
Flash ready-light information.	23
How To Determine Shooting Modes.	24
P—programmed exposure mode.	24
A—automatic exposure mode.	28
Manual exposure mode.	35
Shutter Release Button.	38
Film Advance Lever.	39
Frame Counter.	39
Audio Warning Lever.	40
ASA/ISO Film Speed Dial.	41
Exposure Compensation Dial.	42
Exposure Compensation Button.	43
Self-Timer Lever.	44
Film Plane Indicator.	44
Handgrip.	45
Memo Holder.	46
Infrared Focusing Index.	46

FLASH PHOTOGRAPHY	47
Accessory Shoe.	48
Viewfinder Ready-Light.	48
Nikon FG and Speedlight Combinations. . . .	49
CLOSE-UP PHOTOGRAPHY	50
ACCESSORIES	52
Electronic Flash Units.	52
Motor Drive MD-14.	53
Data Back MF-15.	54
Other Accessories.	55
TIPS ON CAMERA CARE	58
OPTIMUM BATTERY PERFORMANCE	59
SPECIFICATIONS	60
IMPORTANT	63

As Nikon's selective-exposure 35mm SLR camera, the Nikon FG gives you the choices not only of total-exposure programming but also aperture-priority automatic exposure as well as full manual control. Compact and lightweight, the FG additionally offers such advanced photographic features as an exposure compensation dial, an exposure compensation button and an audio warning system, plus its own matching electronic flash with TTL measurement, automatic motor drive and automatic data back. And of course with the FG, you've full admission into the comprehensive Nikon System of over sixty interchangeable lenses and a host of accessories and equipment. To get the most out of your FG, study the instructions in this manual carefully. Every basic operation and all controls and features are explained in detail. Practise using your FG without film until you are familiar with the simple operating instructions, then keep this manual on hand for ready reference. A few minutes now is your assurance of the best future results as you enter the exciting world of selective-exposure photography with the Nikon FG.

BASIC OPERATION



1. Remove the battery clip.

Use a coin to twist the lid counter-clockwise to unscrew it.



2. Install the battery or batteries.

Wipe battery terminals clean and insert either one 3V lithium battery, two 1.55V silver-oxide batteries, or two 1.5V alkaline manganese batteries into the battery clip, making sure each "+" sign is up.

Caution: Keep batteries away from infants and small children. In case a battery is accidentally swallowed, call a doctor immediately as the material inside the batteries can cause serious problems.

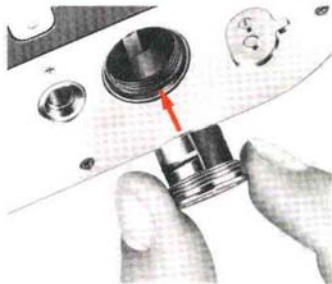

3. Replace the battery clip.

Slip the battery clip back into the camera body and screw it clockwise tightly in place.

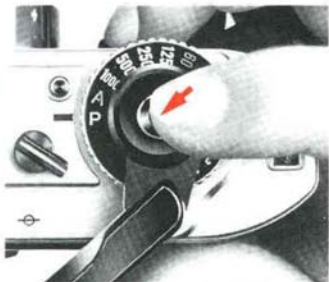

4. Check the battery power.

Looking through the viewfinder ³³, depress the shutter release button ³⁷ halfway and confirm that any of the red LEDs (light emitting diodes) light up steadily or blink continuously for 16 seconds after you have taken your finger off the button. This means battery installation is proper and power is sufficient. If no LEDs light up or if they turn off immediately when you take your finger off the button, replace the battery (ies).

Note: To check battery power, set the shutter speed/mode selector dial ³ to any setting except M90 and B.

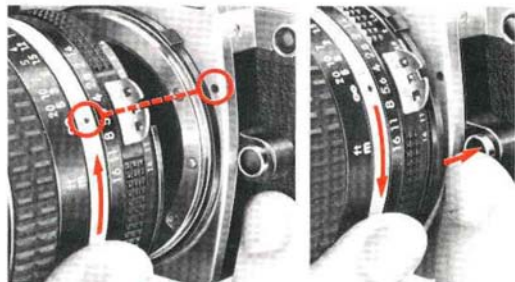

5. Mount the lens.

Grasp the lens by its mounting ring, then line up the aperture/distance scale index ¹¹ on the lens and the mounting index ¹⁷ on the camera body and twist the lens counterclockwise until it clicks into place. Make sure the aperture/distance scale index is exactly on top.

To remove, while pushing the lens release button ¹⁸, turn the lens clockwise.



6. Open the camera back.

Pull up the film rewind knob ²⁶ as far as it will go and the camera back will pop open.

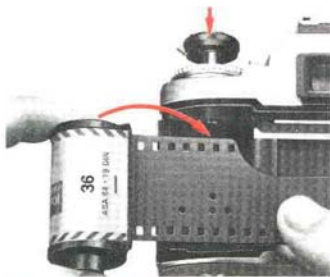

7. Load the film.

Drop the film cartridge ³⁰ into the film cartridge chamber so the film leader points towards the takeup spool ⁴¹, and while rotating the rewind knob push it back down to secure the cartridge in place.

Notes:

- 1) All 35 mm film can be used
- 2) Avoid loading film in direct sunlight. If there is no shade available, turn your back to the sun and use your own shadow to shield the camera.

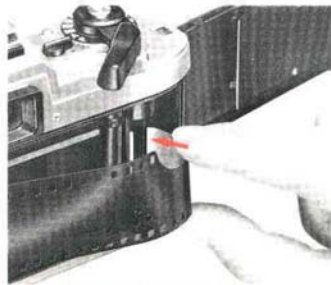

8. Insert the film leader in the takeup spool.

Pull the leader across the camera and insert it into any one of the slots in the takeup spool.

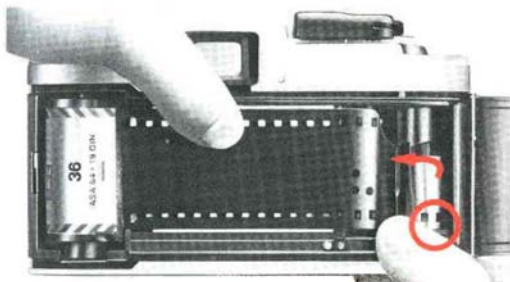

9. Engage the film's perforations with the sprocket teeth.

Advance the takeup spool slightly with your finger to engage the film's perforations with the teeth of the takeup spool and the sprocket ⁴³. Confirm the film is located properly between both guide rails ³² and that there is no film slack.

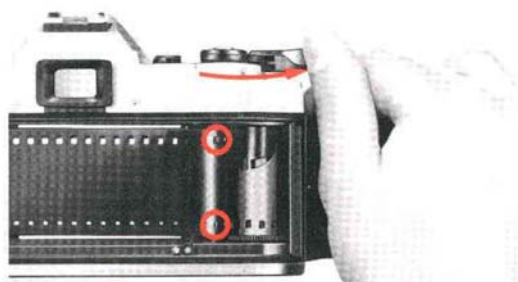

10. Advance the film with the film advance lever.

Alternately wind the film advance lever and depress the shutter release button until the perforations on both film edges are securely engaged with the sprocket teeth and the film is advanced properly.



- 11. Close the camera back.**
Snap the camera back shut.

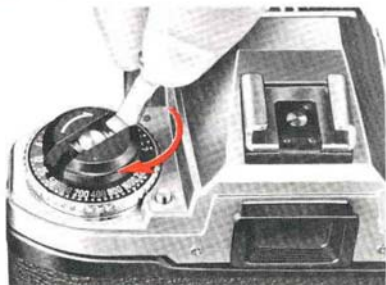

- 12. Take up the film slack.**
Fold out the film rewind crank ²⁵ and rotate it gently in the direction of the arrow until you feel a slight resistance. Then fold the crank back in.

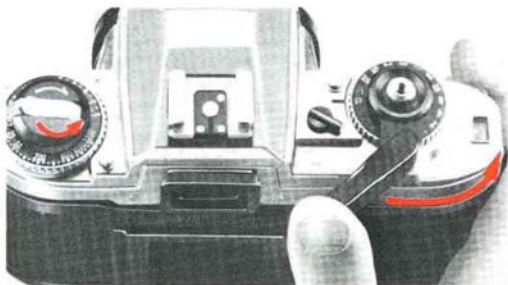

13. Make blank exposures until the frame counter shows "1."

To dispose of the first few frames exposed during film loading, continue to alternately advance the film and depress the shutter release button until the frame counter shows "1." Check that the rewind knob is rotating, indicating the film has been loaded correctly and is being advanced. If the knob does not rotate, reload the film.

Note: Do not take pictures prior to frame "1" as the meter does not function until the counter reaches "1." Up to "1," the 1/60 and 1/125 sec. LEDs in the viewfinder will blink, showing the shutter is automatically set at 1/90 sec.

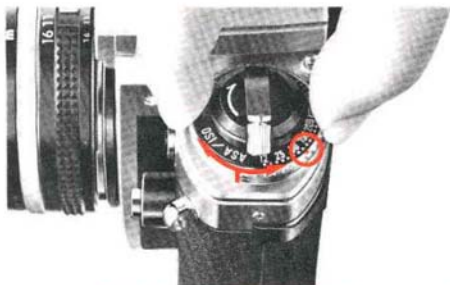

14. Set the ASA/ISO film speed dial.

Lift up the ASA/ISO film speed dial and rotate it in either direction until the index dot is opposite the film speed in use. Make sure the exposure compensation dial is set at "0." These actions are essential to activate the camera's exposure meter for correct exposure of the film being used.

Note: Film speed is printed on the film package and cartridge.

BASIC OPERATION—continued

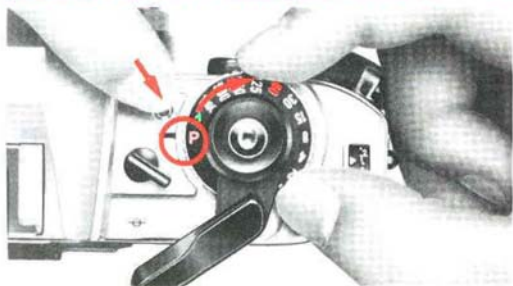

15. Set the shutter speed/mode selector to P.

While depressing the A/P setting lock button (2), turn the shutter speed/mode selector until P is opposite the index. The built-in locking mechanisms at P and A ensure that the dial cannot be accidentally shifted from either the P or A position during shooting.

Note: The Nikon FG camera has two more shooting modes besides P (Program), A (Auto) and manual. For details of shooting at these modes, see pages 28~34 for A (Auto) and pages 35~37 for manual.

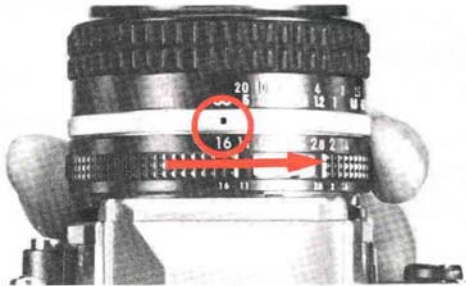

16. Set the lens f/stop to its minimum aperture opening (i.e., the largest f/number).

Turn the aperture ring of the lens until the largest f/number is opposite the aperture index. If the aperture is not set to f/11 or larger, both warning LEDs in the viewfinder will blink alternately, warning of improper setting.



17. Turn the audio warning lever ⑮ to switch it on.

Turn the lever as far as it will go, uncovering the audio warning mark ().



18. Hold the camera steady.

Fold out the film advance lever to the stand-off position. With your right hand grasping the hand-grip ⑤ steadily and your right index finger resting comfortably on the shutter release button, position your right thumb between the camera body and the lever. Then cradle the camera in the left hand with the thumb and fingers holding the lens focusing ring. The camera may be switched from horizontal- to vertical-format shooting in this position.

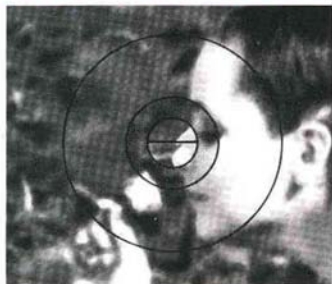

Out of focus



In focus

19. Compose and focus on the subject.

While looking through the viewfinder, compose your photo with the main subject in the center to assure correct exposure. Then turn the focusing ring  of the lens until the subject looks clear. The FG employs the standard Type K focusing screen for all-purpose photography. For precise pinpoint focusing for subjects with distinct contours, use the central split-image rangefinder and turn the focusing ring until the split image becomes whole. For rapid focusing and for subjects with indistinct outlines, use the micro-

prism collar and turn the focusing ring until the shimmering image becomes sharp. When doing close-ups or macrophotography or shooting with telephoto lenses of maximum apertures of approx. $f/4.5$ or smaller, the split-image spot and microprism collar are likely to darken. Therefore, use the matte outer field and turn the focusing ring until the image becomes sharp.

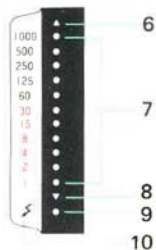
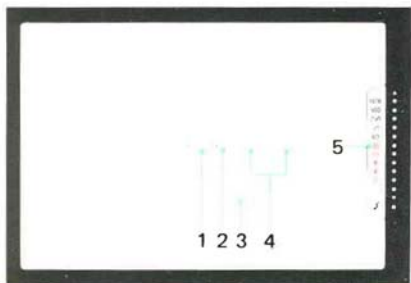

1. 3mm dia. split-image spot
2. 1mm-wide micropism collar
3. 12mm dia. area
4. Fine matte/Fresnel outer field
5. Shutter speed scale
6. Top warning LED
7. Shutter speed LEDs
8. Bottom warning LED
9. Flash ready-light
10. Thunderbolt mark

Notes:

- 1) The meter reads the light over the entire focusing screen but is distinctly biased toward the central 12mm dia. area.
- 2) Frame coverage is approx. 92% which means actual photographs will be slightly larger than the finder image.

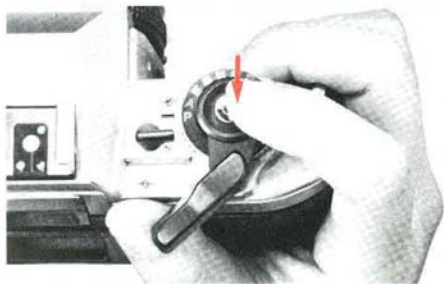

20. Take the photograph.

Look through the viewfinder and press the shutter release button halfway to turn on the exposure meter. When the audio warning does not sound, depress the button all the way to take the picture. In this case, the proper shutter speed to match scene brightness is displayed by the LED inside the viewfinder. If the warning sounds, check the viewfinder information. If either the top or bottom warning LED blinks, the available light is too bright or too dim for the meter's range and correct exposure is not possible without adjustment. Use either a neutral density filter to reduce the amount of light reaching the film or artificial light to increase the subject's brightness. If the LED at 1/30 sec. or below lights up, shutter speed is too slow and blur may result. In this case, use a tripod to prevent blurred images. When you correct the exposure, the audio warning will stop.

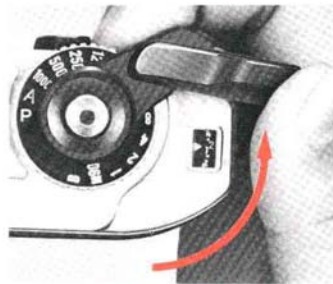

21. Advance the film.

Stroke the film advance lever to transport the film to the next frame.

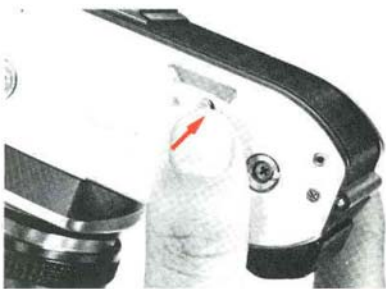

22. At the end of the roll, push the rewind button.

After the last exposure, the film advance lever will not move. Depress the film rewind button on the camera base plate to disengage the film sprocket drive so you can rewind the exposed film back into its cartridge.

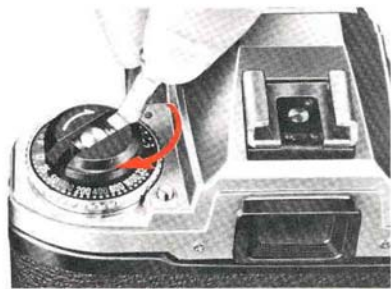

23. Rewind the film.

Fold out the film rewind crank and turn it gently in the direction of the arrow until you feel an increased tension. Give it a few more turns until the tension is gone and the crank turns freely, indicating the film leader is rewound completely back into the cartridge.



24. Remove the film cartridge.

Open the camera back by pulling up the rewind knob and take out the film cartridge. Avoid unloading in direct sunlight. If there is no shade available, turn your back to the sun and use your own shadow to shield the camera.

The lenses usable for the Nikon FG are all the AI-type Nikon/Nikkor lenses, including most of the AI converted lenses, certain Reflex Nikkor and PC Nikkor lenses. Non-AI Nikkor lenses and lenses of other manufacturers which do not have the AI feature must not be forcibly mounted on the FG. Attempts to mount such lenses will damage the camera's indexing mechanism. Note that in addition to non-AI lenses, the following lenses cannot be used:

- AI-converted 55 mm f/1.2 (No. 184711~970110)
- AI-converted 28 mm f/3.5 (No. 625611~999999)
- AI-converted 35 mm f/1.4 (No. 385001~400000)
- Fisheye Nikkor 6mm f/5.6 (all lenses)
- Fisheye Nikkor 10mm f/5.6 OP (all lenses)
- Reflex Nikkor 1000 mm f/11 (No. 143000 or smaller)
- Reflex Nikkor 2000 mm f/11 (No. 200310 or smaller)
- PC Nikkor 28 mm f/4 (No. 180900 or smaller)
- PC Nikkor 35 mm f/2.8 (No. 851001~906200)
- Zoom Nikkor 180~600 mm f/8 ED
(No. 174180 or smaller)
- Zoom Nikkor 200~600 mm f/9.5
(No. 301922 or smaller)
- Zoom Nikkor 360~1200 mm f/11 ED
(No. 174127 or smaller)
- Focusing Unit AU-1

When using the Teleconverter TC-200, TC-201, TC-301 or TC-14A

Exposure compensation, which is required when using Nikon AI-type cameras with lenses having a maximum aperture faster than f/2 or faster than f/1.8 (when using the TC-14A), is not necessary when using the FG in its P or A mode. In the A mode, however, note that the actual shutter speed will be faster than that indicated in the viewfinder by less than one step. Therefore, before shooting, be sure that the shutter speed LED(s) in the viewfinder indicates a speed slower than 1/250 sec. In the manual mode, exposure compensation using the ASA/ISO film speed dial is necessary. See the teleconverter's instruction manual for complete details.

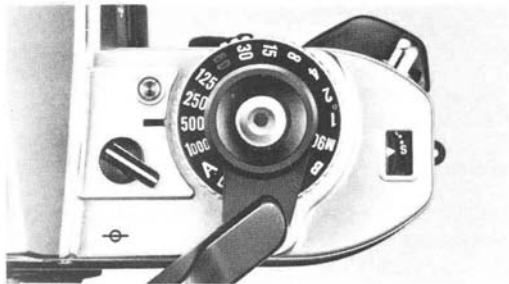

The Nikon FG offers programmed mode operation, aperture-priority automatic mode operation, and manual control of all shutter speeds from 1 to 1/1000 sec., including M90 and B (Bulb) settings. To set the desired shooting mode or shutter speed, rotate the shutter speed/mode selector dial until the desired setting click-stops opposite the index line. Note that at A and P settings, a locking mechanism is provided to prevent accidental shifts of the setting. To rotate the dial to or from the A or P setting, depress the lock button  provided. The shutter speed/mode selector dial has the following settings: B, M90, eleven speeds

from 1 to 1/1000 sec., A and P. Intermediate settings cannot be used.

P (Programmed)

Used for completely automatic programmed mode shooting. The optimum combination of shutter speed and aperture value is automatically set by the FG's microcomputer, depending upon scene brightness and the film speed in use. The electronically controlled shutter speed is stepless between 1 and 1/1000 sec.

A (Auto)

Used for aperture-priority automatic mode shooting. The f/stop is set manually and the FG's microcomputer selects the matching electronically controlled shutter speeds steplessly between 1 and 1/1000 sec., depending on the scene's brightness and the film speed in use.

Manual

Used for full manual control of both f/stop and shutter speed. All of the eleven shutter speeds indicated on the dial are electronically set, with accuracy assured by a quartz oscillator controlling shutter timing. Each number shown on the scale is reciprocal, i.e., 2 means 1/2 second, and 125 means 1/125 second. A one-step change will either halve or double the exposure, e.g., a shutter speed of 1/125 sec. lets in twice as much light as a setting of 1/250 sec., and half as

much light as 1/60 sec.

Note: When you set the shutter speed/mode selector dial to either M90 or B, the exposure meter does not work and the viewfinder LEDs don't light.

M90 (1/90 sec.)

At this setting, the shutter operates mechanically at 1/90 sec., and is used mainly when the battery is drained and other shutter speed modes are not operable, and for flash photography with an electronic flash.

B (Bulb)

At this mechanical setting, the shutter curtains ③ remain open as long as you press the shutter release button. B is used for long time exposures.

Note: When the shutter speed/mode selector dial is set somewhere between 1 sec. and M90 and the shutter release button ③ is accidentally depressed, the shutter curtains remain open. If the film is rewound in this situation, every frame will be re-exposed, damaging the pictures taken. Therefore, before rewinding make sure that the selector dial is not in this intermediate position.

The Nikon FG employs TTL (through-the-lens) center-weighted full-aperture exposure measurement which measures the amount of light passing through the lens with the aperture fully open, thus always assuring a bright finder image during shooting. Exposure measurement emphasis is placed especially on the brightness in the 12mm dia. central area (refer to page 15), although the meter reads the light over the entire focusing screen. Thus, correct exposure is assured when shooting with the main subject situated in this central area.

On both P and A modes, the FG employs instantaneous stopped-down exposure measurement. This measurement system sets the optimum combination of shutter speed and aperture at the actual split-second moment of picture taking, assuring accurate exposures even if the light changes at the very last instant. A sensitive SPD (silicon photodiode) is used to measure light intensity.

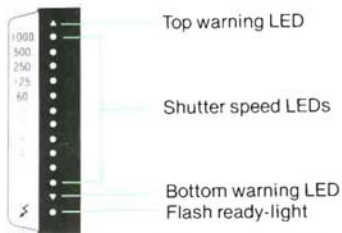

LED Viewfinder Indications

Red LEDs (light emitting diodes) located opposite the shutter speed scale at the right-hand side of the viewfinder light up when the shutter release button is depressed halfway. These function in three capacities—for exposure information, for improper exposure warning, and for convenient flash shooting.

Exposure information on P or A



on manual



☀ = Blinking LED
• = Steadily lighting LED

Exposure information

On P or A, a steady LED indicates the shutter speed automatically set. Two adjacent LEDs indicate set speed is intermediate between the two. On manual, a steady LED indicates the shutter speed set manually and the blinking LED(s) signals the correct speed to match the selected aperture.

Notes:

- 1) At M90 and B, there is no LED display.
- 2) Shutter speed selection is stepless on P and A; however on manual, intermediate speeds cannot be set.

Possible overexposure



Possible underexposure



Shutter speed is too slow



Flash ready-light



Improper exposure warning information

On P or A, a blinking top warning LED indicates possible overexposure. In this case, use a neutral density filter or change to a slower speed film. A blinking lower warning LED signals possible underexposure, necessitating an electronic flash or a change to the B setting for long exposure. On P, A and manual, an LED lighting at 1/30 sec. or below indicates shutter speed is too slow for hand-held shooting and a tripod is necessary to steady the camera or a high-speed film or electronic flash should be used.

Note: When using a tripod with a large head, use Nikon's tripod adapter to mount the FG; otherwise contact between lens barrel and head may make it difficult to operate the lens.

Flash ready-light information

An LED opposite the thunderbolt mark enables you to confirm flash readiness without removing your eye from the viewfinder [33](#).

Correct exposure—whether your photo comes out just right and neither too dark (underexposed) nor too light (overexposed)—depends on two factors in relation to your film: light and time. These factors are controlled by f/stop (aperture opening) and shutter speed. The FG offers three different ways (modes) to expose photos—P (Program), A (Auto) and manual. Depending on photographic conditions and your own personal requirements, choose any one of these three. On P, exposure measurements are totally handled by the camera, so all you do to take perfect pictures is focus and shoot. On A, still enabling automatic exposure, f/stop selection is under your control, allowing you to create special depth-of-field effects, and the FG matches with the correct shutter speed. (For details on depth of field, refer to page 32.) On manual, both f/stop and shutter speed selection are controlled by you, giving you the chance to achieve special effects and to grow in your photographic skills.

P—programmed exposure mode

A new feature with the Nikon FG, the P mode not only greatly simplifies operation, but also lets you concentrate completely on picture composition and further, gives you greater opportunities to shoot, especially in quickly changing situations or for candid shots, because no exposure calculation is necessary. On P, the optimum combination of stepless shutter speed and stepless f/stop is determined by the FG's microcomputer at the instant of exposure, according to a scientifically pre-arranged program. Perfect exposure is thus assured for every shot.

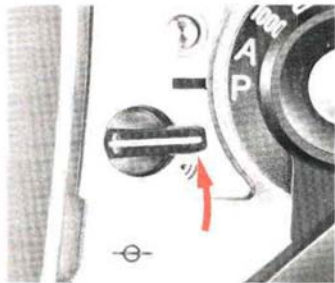
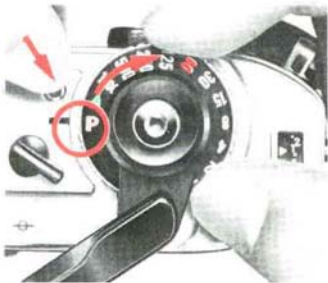

P mode operation

- (1) While depressing the A/P setting lock button, turn the selector dial to P.
- (2) Set the f/stop of the lens to its minimum aperture opening (i.e., the largest f/number).
- (3) Turn on the audio warning system.
- (4) While looking through the viewfinder, depress the shutter release button halfway to turn on the exposure meter.

If the audio warning does not sound, exposure is correct—just focus and shoot. One lighted LED in the viewfinder signals what shutter speed is set. Two lighted LEDs indicate the set shutter speed is intermediate between the two lighted LEDs.

If the audio warning does sound, improper exposure may result and you must check the LED viewfinder indications (explained on the following page) for necessary adjustments.

CONTROLS IN DETAIL—continued

Too much light



Too little light



Shutter speed is too slow



f/stop is not set at f/11 or a larger f/number.



During blank exposure both 1/60 and 1/125 sec. LEDs light up.



- Either upper or lower warning LED blinks. A blinking upper LED means too much light; try either a neutral density filter or change to a slower speed film. A blinking lower LED means too little light; use an electronic flash or switch from P to a long exposure at B setting.
- The LED lights up at 1/30 sec. or below. Shutter speed is too slow for hand-held shooting and picture blur may result. Use a tripod to steady the camera, change to high-speed film, or use an electronic flash.

Notes:

- 1) If the f/stop is not set at f/11 or a larger f/number, both warning LEDs blink alternately. Reset the f/stop to its minimum aperture setting (the largest f/number). When using a Nikon Teleconverter TC-200, TC-300, or TC-14, PK ring or AI-converted lens, be sure to set the aperture to its minimum opening since the warning LEDs will not blink in warning.
- 2) If you do not wish to turn on the audio warning system, check the LEDs in the viewfinder before shooting to confirm if any adjustments are necessary in order to assure correct exposure.
- 3) During blank exposures before the frame counter reaches "1," both the 1/60 and 1/125 sec. LEDs will light up as the shutter is automatically set at 1/90 sec. Do not take pictures before "1" as the exposure meter does not operate until "1."

Programmed exposure measurement graph

The graph represents the optimum combinations of f/stop and shutter speed, for the brightness of any scene, which were determined through intensive statistical and empirical studies and fed into the FG's computer brain for its pre-arranged exposure program. Thus, when actual exposure measurement takes place at the time of shooting, the ideal combination for actual conditions is selected and perfect exposure results for every shot.

(Graph—green line represents the curve for the f/1.4 lens. For lenses with other apertures, the graph is read from that particular aperture opening until intersection with the diagonal line and then in the same downward line, e.g., the black line for the f/4 lens.)

Notes:

1) On P, the following lenses will cause slower shutter speeds than those indicated in the viewfinder while correct exposure is assured. Therefore, in cases where more exact shutter speed information is desired, A or manual mode is recommended:

- 50mm f/1.2 Nikkor (No. 250525 or smaller)
- 58mm f/1.2 Noct-Nikkor (No. 175000 or smaller)
- ED 50~300mm f/4.5 Zoom Nikkor (No. 179500 or smaller)
- Every AI-converted 85mm f/1.8 Nikkor
- Every AI-converted 105mm f/4 Micro Nikkor
- Every AI-converted 85~250mm f/4 Zoom Nikkor

2) On P, the following lenses and accessories cannot be used as they do not have an aperture coupling device. Use

these lenses on A or manual modes.

All Reflex Nikkors

All PC Nikkors

(when perspective is shifted, use manual mode)

Bellows attachment

Extension Ring Set K

3) On P, when using teleconverters or AI-converted lenses of maximum apertures of f/4.5 or smaller, shutter speeds available are limited to very slow ones. Therefore, A or manual mode is recommended.

4) On P, when using AI-converted lenses of maximum aperture larger than f/2.8, the metering range for the higher EV values will be reduced down to a maximum of two EVs depending on the aperture.

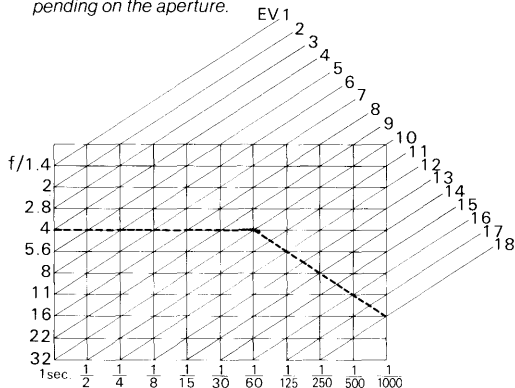

A—automatic exposure mode

With the FG set on A, you select the f/stop and the computer matches it with the correct stepless shutter speed. The A mode is especially useful for creating special effects in depth of field while still using the camera on automatic mode to assure perfect exposure (aperture-priority selection). Deeper depth of field (or greater focus zone in foreground and background around subject) is achieved as you stop down the lens to its smaller aperture openings (larger f/numbers). Shallower depth of field (softly blurred both in front and behind your main subject) results from larger aperture openings (smaller f/numbers) and emphasizes the main subject.

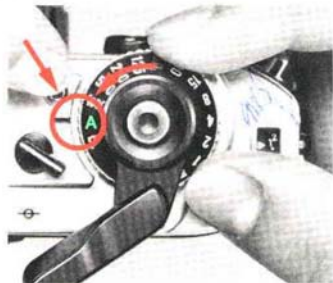

A mode operation—aperture-priority selection

- (1) Depress the A/P setting lock button and rotate the dial until the "A" click-stops opposite the index line.

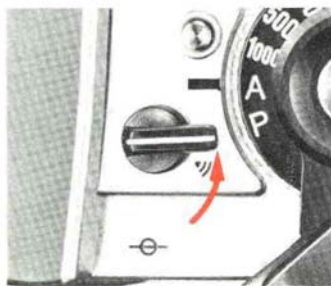

- (2) Set the desired f/stop on the lens.
- (3) Turn on the audio warning system.
- (4) While looking through the viewfinder, depress the shutter release button halfway to turn on the exposure meter. If the audio warning does not sound, the scene brightness is within the FG's metering range—focus and shoot. The shutter speed automatically set is indicated in the viewfinder by either one LED or two LEDs. If the audio warning sounds, LEDs in the viewfinder will indicate one of the conditions described on the next page.

CONTROLS IN DETAIL—continued

Overexposure Underexposure Picture blur



- The top warning LED blinks to warn of overexposure.
- The bottom warning LED blinks to warn of underexposure.
- The LED lights up at 1/30 sec. or below to warn of picture blur.

In these cases, to adjust exposure, rotate the lens aperture ring to a larger or smaller value as indicated below until the blinking LED disappears and an LED(s) lights up steadily opposite 1/60 sec. or faster.

- Overexposure—Rotate to a larger f/number. If after this the LED still blinks, use a neutral density filter or change to a slower speed film.
- Underexposure—Rotate to a smaller f/number. If after this the LED still blinks, use an electronic flash or switch from A to B (Bulb) setting for long exposures. If the LED at 1/30 sec. or below lights up

after adjustment, picture blur may result—use a tripod, higher speed film or electronic flash.

- Picture blur—Rotate to a smaller f/number. If the shutter speed does not increase above 1/30 sec., use a tripod to steady the camera, change to a higher speed film or use an electronic flash.

Note: If the audio warning system is not turned on, check the LEDs in the viewfinder for improper exposure conditions before shooting



Set the desired speed by turning the lens aperture ring.



A mode operation — shutter speed priority selection

For shooting moving subjects, the FG also enables you to select the shutter speed on A mode to either freeze the action and produce sharp outlines with a faster shutter speed, or to cause an intentional blur by choosing a slower shutter speed. To operate the FG as a shutter-speed priority automatic camera,

depress the shutter release button halfway and match the lighted LED with the speed you desire by turning the lens aperture ring 20 . Improper exposure is indicated by LEDs and the audio warning system as in aperture-priority selection.

Depth of field

Depth of field refers to the clear focus zones in front of and behind the main subject when you focus the lens. With the FG's aperture-priority automatic exposure, you have full control over depth of field by varying the *f*/stop. The following are important points to remember.

- (1) By stopping down the aperture to smaller openings (larger *f*/numbers), depth of field becomes deeper and not only your main subject but foreground and background will also be in clear focus. On the contrary, by opening up the aperture to larger openings (smaller *f*/numbers), depth of field becomes shallower and both fore- and background will be out of focus, thus enabling you to emphasize the main subject.
- (2) The farther the subject from the camera, the deeper the depth of field; the closer to the camera, the shallower the depth of field.
- (3) Usually, background clarity is sharper than that of the foreground; thus, in shallow depth-of-field situations, you can expect your foreground images to be less clear than those behind the subject.
- (4) The shorter the focal length of the lens, the deeper the depth of field.
- (5) With Nikkor or Nikon Series E lenses, depth of field is indicated by pairs of colored lines on the lens which correspond to the colors of the *f*/number. Therefore, depth-of-field range can be obtained by the corresponding distance scale.



Lens set at $f/1.4$

Only main subject is in focus



Lens set at $f/16$

Most objects near to far are in focus

Download from [Www.Somanuals.com](http://www.Somanuals.com). All Manuals Search And Download.

EV Range

The FG's meter may be used only within the meter's exposure value (EV) range which determines the possible combinations of aperture and shutter speed, depending on the film speed in use. The chart shows the relationships between the f/stop, shutter speed and film speed, indicating the functioning shutter

speeds (for metering purposes) with any film speed/aperture combination. Careful attention to this chart will assure precise exposure, automatically, over the complete exposure control and meter range capabilities of your Nikon FG.

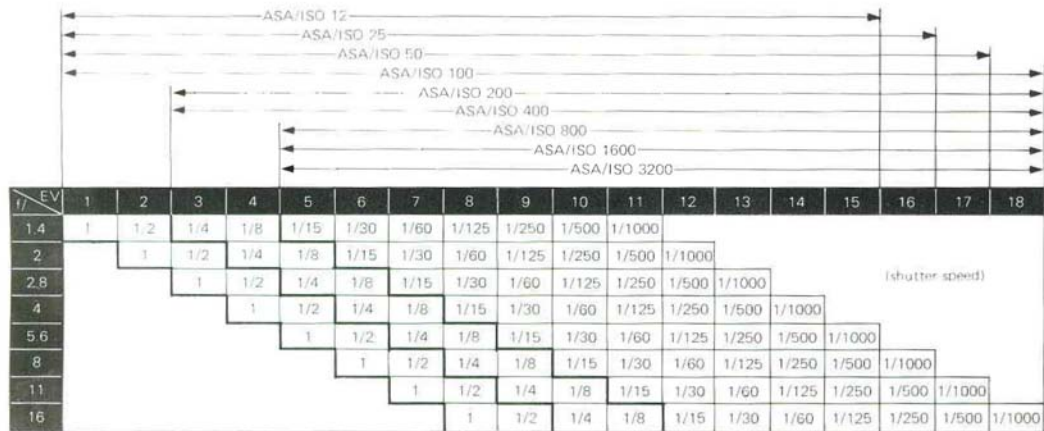

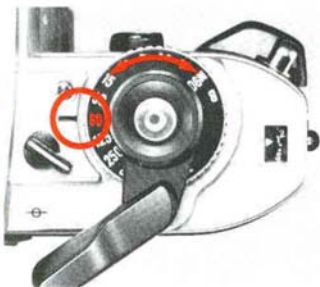

Manual exposure mode

Manual operation allows you to shoot at your choice of any combination of the f/stops and eleven shutter speeds on the camera's dials. (Note that you cannot set shutter speed between numbered settings.) By varying these combinations, you can achieve not only correct exposure but also such special effects as under- or overexposure, blurred action, etc. Manual is also valuable to develop your photographic instincts and skills, and is additionally recommended when an electronic flash other than the Nikon dedicated flash unit is used.

How to select f/stop and shutter speeds

Exposure is determined by the combination of the shutter speed and f/stop (aperture opening). As the numbers on either the f/stop or shutter speed dials increase by one value, the amount of light entering the film is reduced by approximately one half. For example, the amount of light at 1/125 sec. is about one-half that at 1/60 sec., and the amount of light at f/16 is one-half that at f/11. Brighter scenes require either faster shutter speeds or smaller aperture openings (larger f/numbers) or a combination of both which will give the same amount of exposure; darker scenes require the reverse. For example, 1/250 sec. at f/8 is the same as either 1/500 sec. at f/5.6 or 1/125 sec. at f/11.

Shutter speed/aperture combination to give the same exposure.

Shutter speed (sec.)	1/1000	1/500	1/250	1/125	1/60
Aperture (f/number)	4	5.6	8	11	16

Manual mode operation

- (1) Set the f/stop you desire or turn the shutter speed/mode selector dial to any of eleven numbered settings you desire. (Note that you cannot set the dial between indicated settings.)
- (2) While looking through the viewfinder, depress the shutter release button halfway and check the lighted LEDs.
 - The blinking LED(s) indicates the shutter speed selected by the FG's microcomputer to match the f/stop you have set.
 - The lighted LED indicates the shutter speed you have set.
- (3) If one LED is blinking, to get the correct exposure rotate the aperture ring and/or the shutter speed dial so that both the blinking LED and the steadily lighted LED are aligned and only one LED lights up steadily. If two LEDs are blinking, rotate the aperture ring and/or shutter speed dial until one LED lights up steadily or the blinking LEDs come as close as possible to it; then make further fine adjustments by rotating the aperture ring so that only one LED lights up steadily.
- (4) If you wish to create intentional under- or over-exposure, set either the aperture ring or shutter speed dial so that your selected shutter speed is displayed in the viewfinder either above or below that selected by the FG.

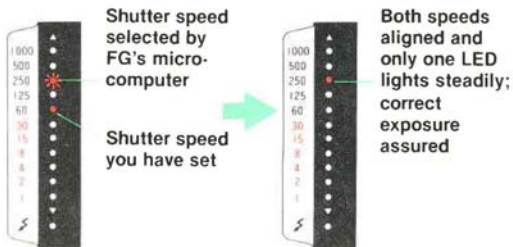

Notes:

- 1) At the mechanical settings of M90 and B, the meter does not function and no LEDs are displayed.
- 2) The audio warning system does not function on manual.



Fast shutter speed
(freeze action)



Slow shutter speed
(intentional blur)

Download from Www.Somanuals.com. All Manuals Search And Download.

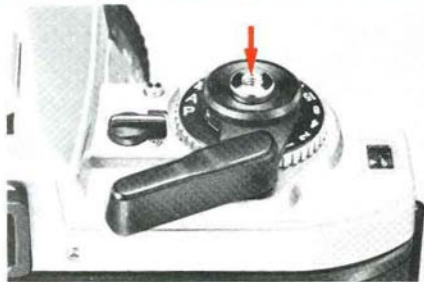

Shutter Release Button

Depressing the shutter release button halfway switches on the exposure meter for approx. 16 sec., even after taking your finger off the button, and causes the viewfinder LED(s) to light up steadily. Pushing the button all the way down releases the shutter.

To check battery power, depress the button halfway. If the viewfinder LED(s) lights steadily, power is sufficient. If the LED(s) disappears the instant you remove your finger from the button, power is weak and you must change batteries. If you continue to use

the camera in this situation, the batteries will be completely exhausted: when the shutter release button is depressed, the shutter curtains will not open and the mirror will be locked in the up position. To return the mirror to its place, switch to the B setting.

The shutter release button is threaded at the center to accept a standard cable release.

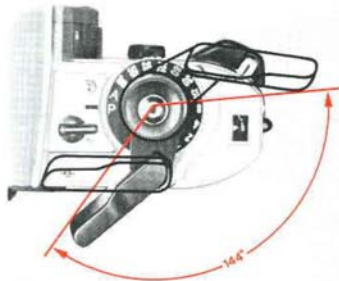

Film Advance Lever

The film advance lever is coaxial with the shutter release button and is specially contoured to fit the thumb. A hinged lever, it fits snugly to the camera body. It has a throw of 144°, and is operated in one complete stroke or a series of shorter ones. After completion of film winding, the lever quick-returns to the stand-off position when your finger is taken off the lever.

Notes:

- 1) At the end of the roll the lever will not wind. In this case, don't force the lever, just release your finger, depress the film rewind button  and rewind the film.
- 2) Be sure to release your finger from the shutter release button while advancing the film to prevent taking a picture accidentally at the instant the film is advanced.

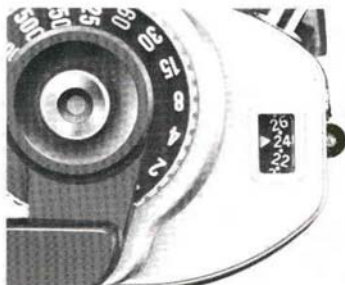

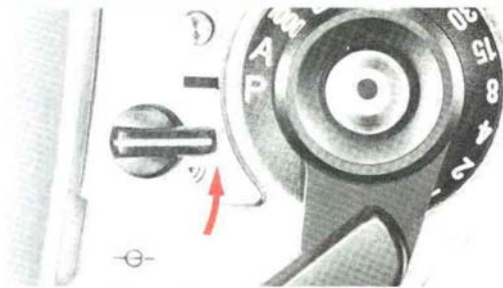

Frame Counter

To keep track of the number of exposed frames, the frame counter is graduated from S (Start = two frames below 0) to 36. After "1," and starting from "2," every two frames are numbered in white with white indices in between. When making blank shots with the shutter speed/mode selector set at other than M90 and B, the 1/60 and 1/125 sec. LEDs will blink until the frame counter reaches "1," showing that the shutter is firing at 1/90 sec. Only after "1," will both the meter and viewfinder information work normally. Don't take pictures until the frame counter reaches "1." The frame counter automatically resets to "S" when the camera back is opened.



Audio Warning Lever

To prevent incorrect exposure or blurred photos resulting from extreme shooting conditions, the Nikon FG is equipped with an audio warning device, operable on P or A modes, in addition to the visual LED warning indications. To switch the device on, turn the lever as far as it will go, uncovering the audio warning mark (), and depress the shutter release button halfway. While the button is depressed, the audio warning will sound indicating that scene brightness is out of the metering range of 1~1/1000 sec, which results in over- or underexposure, or that shutter speed is too slow for hand-held shooting.

Check the viewfinder for LED indications and adjust exposure as on pages 26~27 or 30~31. If you don't want to hear the warning sound, simply turn the lever to the OFF position (to cover the  mark), but be sure to check the viewfinder LED before shooting to confirm if scene brightness is within metering range.

Note: The audio warning device does not function even with the lever set at ON when both top and bottom warning LEDs are alternately blinking to warn of improper aperture setting on P.

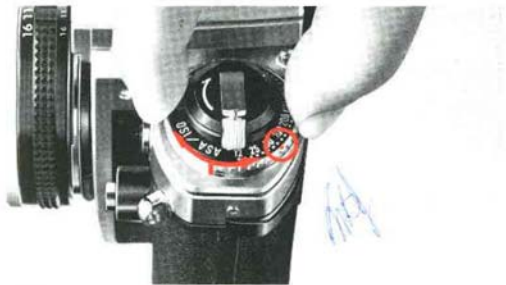

ASA/ISO Film Speed Dial

The scale on the ASA/ISO dial has numbered settings for speeds from ASA/ISO 12 to 3200. Two dots between each number stand for intermediate settings, such as 64, 80, etc. The 64, 100 and 400 settings are indicated in red. The table gives the speeds for all intermediate settings. To set the film speed in use, lift up the dial and rotate it until the desired number (or dot representing the film speed) click-stops opposite the index dot ☉ .

ASA/ISO is a numerical rating of the film's sensitivity to a given amount of light. The higher the number, the



greater the sensitivity, and vice versa. The film's ASA/ISO is indicated on the cartridge itself, on the film carton and on the data sheet packed inside.

This dial can also be used to compensate exposure, as in the following example: with ASA/ISO 100 film, set the dial to 50 to overexpose +1 step; to 25 for +2 steps; to 200 for -1 step; to 400 for -2 steps. After compensated shootings, be sure to return the dial to the film's original speed.

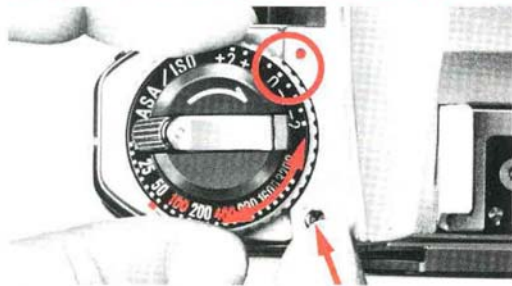

Exposure Compensation Dial

For unusual lighting situations, such as shown in the diagram, the exposure compensation dial allows adjustments to prevent over- or underexposure. Also, the dial can be used to intentionally obtain special effects like over- or underexposure, even under normal lighting conditions. Conveniently operable on P and A, the dial ranges from +2EV to -2EV in one-half increments.

To operate, press the lock button (12) and turn the dial until it click-stops opposite the desired compensation value. On P, each increment causes a corresponding shift in both shutter speed and f/stop (except for when the graph line becomes horizontal, and then only shutter speed is shifted); on A, shutter speed

Suggested Applications for Exposure Compensation



- +2 white background, snow scene
- +1 white background occupying half of viewing area
- 1 spotlighted subject, black background occupying half of viewing area
- 2 black background

only is shifted, corresponding to the compensated amount. New shutter speed setting is visible in the viewfinder. After taking the picture, return the dial to 0, or incorrect exposures will result in ordinary shooting. In addition to the dial, exposures can be compensated with the exposure compensation button (15), by changing the ASA/ISO setting, and by changing shutter speed or aperture setting in the manual mode.

Note: At ASA/ISO 25: Only 1 step compensation in the + direction; - direction is normal. At ASA/ISO 1600: Only 1 step compensation in the - direction; + direction is normal. At ASA/ISO 12: Cannot compensate in the + direction; - direction is normal. At ASA/ISO 3200: Cannot compensate in the - direction; + direction is normal.



Exposure Compensation Button

Conveniently operable on P and A, this gives a compensation of +2EV to quickly and easily adjust exposure when shooting snow scenes, sidelit or backlit subjects, or in cases where the main subject and background are strongly contrasted. Keep the button depressed as you press the shutter release button. On P, both f/stop and shutter speed are shifted toward a slower speed and smaller f/number by an equivalent of two EVs, according to the programmed graph. On A, shutter speed is shifted two stops, e.g., from 1/250 sec. to 1/60 sec. On both P and A, the new shutter speed is displayed in the viewfinder.



Backlit subject



After compensated

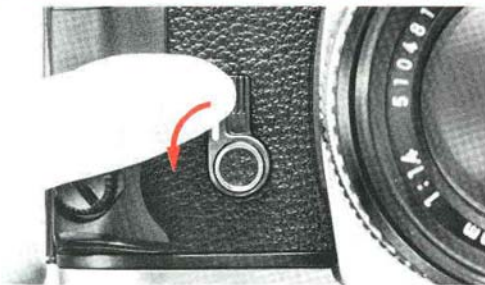

Self-Timer Lever

This provides an approx. 10-sec. exposure delay. Independent of the shutter mechanism, the self-timer can be set either before or after the film is advanced. It can be operated at all modes except the B setting. Slide the lever away from the lens as far as it will go, cover the viewfinder eyepiece to prevent stray light from entering through the viewfinder, then depress the shutter release button. After use, return the lever to its original position. The self-timer is cancellable any time before shooting by returning the lever to its original position.

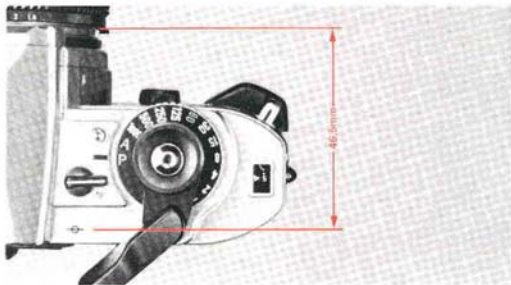

Film Plane Indicator

The film plane indicator (\ominus) is engraved on the top deck just behind the audio warning lever. It indicates the exact position of the film plane inside the camera and is used to measure the exact distance between the subject and film plane, such as in macrophotography. The distance between the film plane and lens mounting flange is exactly 46.5mm.

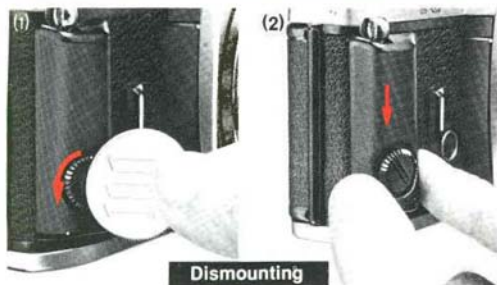

Hand Grip

This not only allows steady shooting but also a secure comfortable fit in your hand. When shooting with motor drive, the grip should be dismantled. To do this, (1) insert a coin into the slot, turn the screw counterclockwise until it loosens, (2) then slide it down until it separates from the body. To reattach, (1) align the grip attachment screw with the inner hole in the hand grip, (2) slip the grip up until it stops, then screw clockwise until it becomes tight.

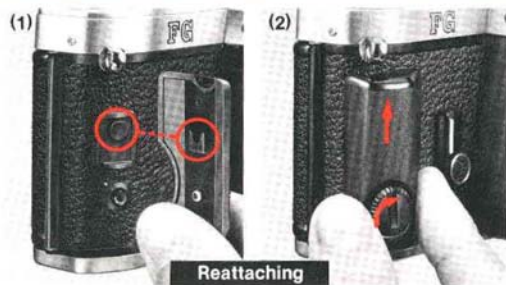



Memo Holder 18

As a reminder of film type, ASA/ISO speed, and the number of exposures on the roll in use, clip off the end of the film carton and insert into the memo holder.



Infrared Focusing Index 19

The red dot located just beside the focusing index on most lenses is the infrared focusing index. When shooting with black-and-white infrared film, it is necessary to refocus the lens to compensate for the fact that infrared rays focus at a point slightly in front of visible light. To use the index, focus on your subject through the viewfinder, then look at the lens and take note of the focused distance. Finally, reset the focusing ring so that the desired distance is aligned with the red dot.

Electronic flashes are convenient not only for night or low-light shooting but also as a supplemental light to fill in shadows in the daytime. When shooting with electronic flashes such as the Nikon Speedlights SB-18, SB-16B and SB-15, the FG's shutter speed is automatically switched to 1/90sec. on P, A and on manual modes when the manual shutter speed is 1/125sec. or above. If the manual shutter speed is 1/60sec. or below, the shutter will operate at the set speed. The Nikon FG directly accepts the Nikon SB-18, SB-16B and SB-15 which have an ISO-type hot-shoe mount, and the SB-12, SB-16A and SB-17 via the Flash Unit Coupler AS-6. Be sure to check the guide number of the flash unit and set the aperture to match the shooting distance. The sync contact of the FG is an X-contact only and synchronizes at the speed of 1/90sec. or slower. Flash bulbs can also be used at the following shutter speed sync ranges:

		Shutter speed (sec.)												
		1/1000	1/500	1/250	1/125	1/90	1/60	1/30	1/15	1/8	1/4	1/2	B	
Flashbulb	Speedlight													
	FP													
	M													
	MF													

Synchronised
 Cannot be used

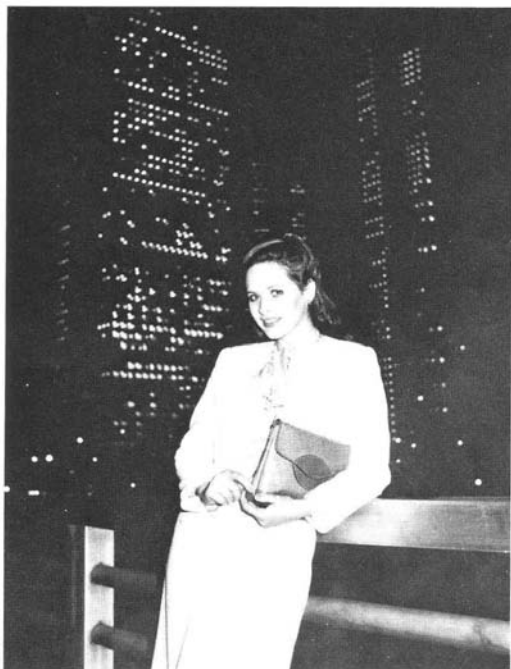

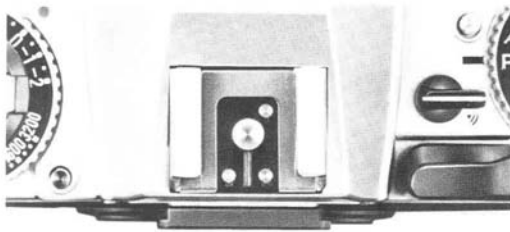

Located at the top of the pentaprism viewfinder, the hot shoe allows direct mounting of the Nikon Speedlight SB-18, SB-16B, SB-15 or any electronic flash with an ISO-type mounting foot. Other flash units may be mounted with an adapter—see the table on the next page. Four electrical contacts provide synchronization of the flash unit, flash output stop signal on TTL mode, identification of the TTL flash, and both ready-light indication in the camera's viewfinder (via an LED) and auto switching to the proper sync speed of 1/90sec. with some Nikon dedicated flashes.

Note: Use of other manufacturer's flash units, even with the same ISO-type mounting foot, may cause abnormalities in shutter speed precision or even breakage of the IC circuit.



When the Nikon FG is used together with Nikon flash units such as the SB-18, SB-16B, SB-15, etc., a viewfinder ready-light LED opposite the thunderbolt mark lights up when the flash is fully charged or recycled. This way, you're easily informed of flash readiness without having to take your eye off the viewfinder. Depending on which Nikon flash unit is attached, the same LED blinks to warn of insufficient flash output, incorrect setting of the flash unit or incorrect setting of the FG. For more detailed information, refer to the flash unit's instruction manual.

Note: When the camera's meter switch is off, the ready-light will not light up except at the M90 or B setting.

Speedlight	Connection	Camera's ready-light indication	Shutter speed automatically switched to 1/90 sec.	Usable flash modes
SB-19	direct	provided	yes	auto
SB-18	direct	provided	yes	TTL, manual
SB-17	Via AS-6 coupler	provided	yes	auto, manual, MD
SB-16A	Via AS-6 coupler	provided	yes	auto, manual, MD
SB-16B	direct	provided	yes	TTL, auto, manual, MD
SB-15	direct	provided	yes	TTL, auto, manual, MD
SB-11/14	Via SC-13 sensor cord	provided	yes	auto, manual
SB-12	Via AS-6 coupler	provided	yes	manual
SB-10	direct	provided	yes	auto, manual
SB-7E	Via AS-2 coupler	not provided	no	auto, manual
SB-E	direct	provided	yes	auto

For nature lovers, scientists, even general use, close-up photography provides the means to see the world in all its smallest details. The following are available for close-up work at a shorter distance than that of the index engraved on the lens:

- (1) Close-up lenses—No. 0, No. 1, No. 2, No. 3T, No. 4T, No. 5T and No. 6T lenses; direct mounting; normal exposure method.
- (2) Auto rings—PK-11, PK-12 and PK-13; mount between lens and camera body; usable only in combination with AI lenses; normal exposure method.
- (3) Bellows Focusing Attachment PB-6—Use the aperture control lever of the PB-6 for stop-down measurement as follows: on A, release the shutter button after turning the PB-6's aperture control lever; on manual, turn the aperture control of the PB-6 and turn either the f/stop or shutter dial until only the steady LED begins to light, indicating correct exposure for manual mode. Note that P (Program) mode is unusable. Shooting magnification is successively changeable by the expansion and contraction of the bellows. Any combination of Nos. 1, 2, and 3 is possible.

- (4) Micro-Nikkor 55mm f/2.8, 105mm f/2.8 and 200mm f/4 (IF)—When using AI-type Micro-Nikkor lenses at a shooting magnification range from 1/2 to 1/1, use the Auto Ring PK-13 or Teleconverter TC-201 (in the case of the TC-201, usable from infinity to 1/1 magnification) with the 55mm f/2.8; use the PN-11 with the 105mm f/2.8. In the case of the 200mm f/4 (IF), the Teleconverter TC-301 is recommended for photos with a wide magnification range from infinity to 1/1. Because both the auto rings and teleconverters have automatic aperture coupling devices, they enable automatic exposure control when combined with Micro-Nikkor lenses.

For close-up photography with these accessories, it is recommended to shoot at A or manual modes since depth of field is generally shallow and you must stop your aperture down as much as possible to get the greatest area of clear focus. In focusing, it is essential to focus on the matte field. To measure the exact distance between the subject and the film plane, use the film plane indicator.



Designed to complement the versatility of the FG, Nikon has three electronic flash units which mount directly to the camera's accessory shoe and feature automatic TTL (through-the-lens) control of the flash exposure. Also, with the camera on P, A, or a manual setting of 1/125sec. or faster, the FG is automatically switched to 1/90sec.—the correct synchronization speed for flash photography. Nothing could be easier.

Speedlight SB-15

Features special tilting flashtube module for bounce flash or shooting close-ups. Guide number of 25 (ASA/ISO 100 and meters) or 41 (ASA/ISO 25 and feet).

Speedlight SB-16B

Most versatile direct-mounting flash from Nikon. Truly creative bounce flash possible with two flash heads: main head has zoom settings for 28, 35, 50, and 85mm lenses and tilts back 90° and rotates 270°; smaller secondary head faces straight ahead to provide a catchlight in the eyes. Special MD (motor drive) setting allows shooting of 8 consecutive frames at 4 frames per second. Powerful guide number of 32 (ASA/ISO 100 and meters) or 52 (ASA/ISO 25 and feet).

Speedlight SB-18

Lightweight and easy to operate. Choice of TTL or manual control. Guide number of 20 (ASA/ISO 100 and meters) or 33 (ASA/ISO 25 and feet).



SB-15



SB-18

Made for the Nikon FG, the MD-14 Motor Drive enables shooting up to 3.2 fps (frames per second) on high speed setting, or 2fps on low speed setting, using the FG's shutter release button as the motor drive trigger and for auto winding. One-frame-at-a-time picture taking is also possible, enabling you to follow a moving subject without ever taking your eye from the subject. To attach, remove the FG's hand grip ⑤ and engage the tripod socket ④7 of the camera with the attachment screw. The MD-14 is also operable with the Nikon EM camera, providing the same shooting ratio as that for the Nikon FG. The FG also accepts the compact, lightweight MD-E Motor Drive for 1.5 fps shooting. Attachment and operation are the same as above.

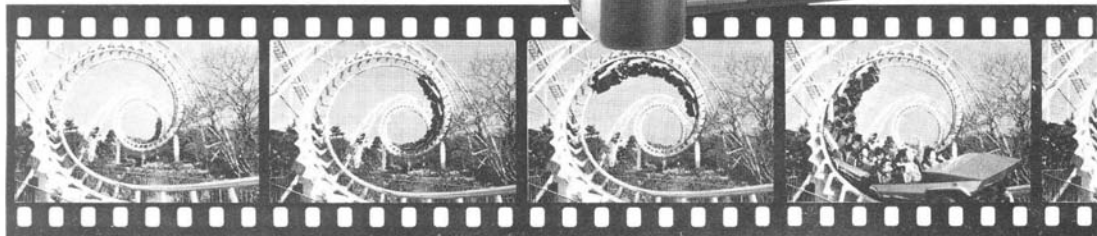

To keep track of when photos were taken, the FG accepts the slim, lightweight Data Back MF-15 which slips on in place of the FG's regular camera back 46 with no sync cord needed. Three imprinting modes are possible: year/month/day (up to year 2100), day/hour/minute, or picture counting (up to 2000); displayed on the data back in clear LCDs and printed, if you choose, on the photo in unobtrusive red LED numerals. For double-duty as a handy clock, a quartz timer with alarm function is incorporated.



Eyepiece correction lenses

To correct both near- and far-sightedness, nine lenses are available from -5 to $+3$ diopter values. These values are derived from the dioptre of both the finder and the correction lens.

Rubber eyecup

By helping to block stray light from entering the eyepiece, this improves the apparent brightness and contrast of the viewfinder image and facilitates focusing. Attach directly to the viewfinder or eyepiece correction lens' frame.

Eyepiece adapter

Used when attaching the Magnifier DG-2. Be sure to lift the adapter before opening the camera back.

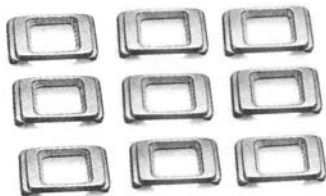

Semi-soft cases

Two types are available: the CF-17 for use with standard lenses and the CF-18 for use with the Nikon Series E 36~72 mm f/3.5 or smaller lenses. The CF-18A Front-Flap for use with the Zoom-Nikkor 35~70mm f/3.5 lens and the CF-19D Camera Case Base Portion for use when the Data Back MF-15 is attached are also available.



Custom shoulder bags

Three types are available: CB-1, blue; CB-2, green; CB-3, beige.

Neckstrap

Available in several colors: AN-1, leather; AN-4Y, AN-4B, AN-6Y and AN-6W, webbed nylon.

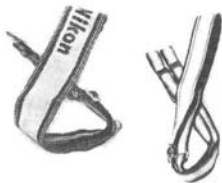

Shutter Release Adapter AR-8

For use with the Cable Release AR-2 or Double Cable Release AR-4. Screw into the center of the shutter release button.



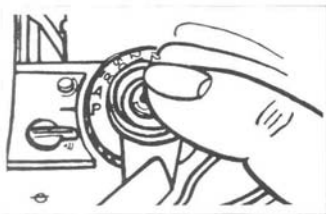

- Don't force your camera's controls—they are designed to work with a minimum of pressure



- Clean all lens and prism surfaces periodically with a blower-type brush or lens tissue moistened with an approved photo lens cleaning liquid.

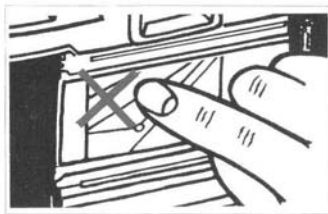

- Avoid touching the camera's interior surfaces, especially the shutter curtains 31 and film pressure plate 42.



- If the camera body is exposed to rain or mist, wipe moisture gently with a soft cloth and dry the camera. After using the camera near salt water, take care that you wipe it with a cloth moistened with pure water to remove possible traces of salt.

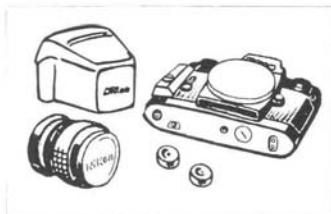

- Store your camera, lenses and accessories in a cool, dry place. Remove the batteries when the camera or accessories are not to be used for an extended period.



- Dispose of used batteries properly—never throw them into fire. For battery performance by brand, refer to manufacturer's literature.

Caution: Keep batteries away from infants and small children. In case a battery is accidentally swallowed, call a doctor immediately as the material inside the batteries can cause serious problems.

New batteries: Between manufacturing and first use, all batteries exhibit some drain. Therefore, care should be taken to purchase the newest (and freshest) ones possible. To help you do this, some manufacturers stamp the date of manufacture on the bottom of each battery. Ask your camera dealer for assistance in interpreting the codes.

Temperature: Battery life ratings are based on operation at around 25°C (77°F). At other temperatures, battery life is shortened. Spare batteries should therefore be kept available if operation in low temperatures is anticipated.

Continuous use: Batteries are drained much more quickly by continuous use than by intermittent use.

Storage: When not in use, the batteries should be removed to prevent damage from leakage. To minimize drain during the period of disuse, store the batteries in a cool, dry place.

Battery brand: Do not use mixed brands of batteries, nor batteries with different model numbers. Also, avoid mixing new and old batteries since proper performance will not be obtained and battery leakage into your FG may occur.

Polarity: When installing batteries, observe the voltage polarities carefully. Reversal of positive (+) and negative (-) terminals will result in leakage. If leakage should occur, clean carefully or take your FG to your dealer.

Type of camera	Electronically controlled 35 mm single-lens reflex camera	Manual mode exposure control	Both aperture and shutter speed set manually. Shutter speed timing controlled by quartz
Picture format	24 mm×36 mm (standard 35 mm film format)	Viewfinder information	Shutter speed scale with LED display, exposure warning signal, ready-light when used with electronic flash
Lens mount	Nikon bayonet mount	Exposure meter	TTL center-weighted full-aperture measurement; meter incorporates one silicon photodiode (SPD)
Lenses	Nikkor 50/1.2, 50/1.4, 50/1.8, Nikon Series E 50/1.8 as standard; more than 60 Nikkor and Nikon Series E lenses available	Metering range	EV 1 to EV 18 (i.e., f/1.4 at 1 sec. to f/16 at 1/1000 sec. at ASA/ISO 100 and with 50 mm f/1.4 lens)
Shutter	Electronically controlled vertical-travel metal focal-plane shutter	Film speed range	ASA/ISO 12~3200
Shutter speeds	Stepless speeds from 1 to 1/1000 sec. on P (Program) and A (Auto) modes; 11 speeds quartz-controlled from 1 to 1/1000 sec. on manual; mechanically controlled, 1/90 sec. at M90 setting and long exposure at B setting	Audio warning alarm	“Beep-beep” warning sound activated when shutter release button is pressed halfway if shutter speed is approx. 1/30 sec. and below, or above approx. 1/1000 sec.; can be turned off via audio warning lever
P (Program) mode exposure control	Light intensity feed-back type; shutter speed and aperture set automatically and steplessly	Exposure compensation dial	+2EV~-2EV in 1/2 increments
A (Auto) mode exposure control	Aperture priority type; aperture set manually while shutter speed set automatically and steplessly		

Exposure compensation button	Approx. +2EV when exposure compensation button is kept depressed as shutter release button is depressed	Hot-shoe contacts	Standard ISO-type accepts Nikon Speedlight SB-18, SB-16B, SB-15 or other ISO-type Nikon flash unit directly
Viewfinder	Fixed eyelevel pentaprism type with built-in TTL exposure meter; approx. 92% frame coverage	Flash synchronization	Speeds up to 1/90sec. with electronic flash; with the Nikon dedicated flash unit, flash sync is automatically set to 1/90sec. when shutter speed/mode selector is set at P, A or manually 1/125~1/1000sec.; while set to 1~1/60sec. manually, the shutter speed will operate as set; the flash ready-light lights up when flash is recycled
Focusing screen	Fixed-type Nikon standard Type K screen; comprised of central split-image rangefinder spot, microprism collar and matte/Fresnel outer field; 12mm-dia. reference circle denotes area of center-weighted metering		
Finder magnification	0.84X (50mm lens set at infinity)	Ready-light	Incorporated in the viewfinder
Film advance	Via film winding lever of 144° winding angle; hinged type; either one continuous stroke or series of shorter strokes possible	Motor drive coupling	Electrical contacts and mechanical coupler built in for operation with the Motor Drive MD-14 or MD-E
Frame counter	Additive type; automatically resets to "S" when camera back is opened	Camera back	Swings open when film rewind knob is pulled up; memo holder provided; interchangeable with the Data Back MF-15
Film rewind	Manual; film rewind crank rotates after rewind button is depressed		

Self-timer	Lever provided can be set for up to approx. 10 sec. exposure delay; setting cancellable before actual shutter release
Reflex mirror	Instant-return non-locakble type
Hand grip	Detachable type
Power source	Two 1.55V silver-oxide batteries (S-76 or SR-44 type), two 1.5V alkaline-manganese batteries (LR-44 type) or one 3V lithium battery (CR-1 3N type)
Power ON/OFF switch	Meter switched on when shutter release button is pressed halfway; stays switched on for approx. 16 seconds after finger is lifted off button
Dimensions	136.0mm(W)× 87.5mm(H)× 54mm (D)
Weight	Approx. 490g (body only)
Camera cases	Semi-soft cases CF-17, 18 and 19D

The camera body you purchased is packaged separately from the lens. Before mounting the lens, check if it is capable of Automatic Maximum Aperture Indexing (AI) operation with your camera body by verifying that the lens' aperture ring is fitted with a meter coupling ridge as illustrated at the right.

If the lens is fitted with the meter coupling ridge, it is capable of full-aperture exposure measurement; to attach it to the camera, follow the directions provided in the Basic Operation section of this instruction manual. If the lens is non-AI, it cannot be mounted on the Nikon FG. For further details on usable lenses and their recommended modes, please refer to pages 19 and 27.

Note: AI-conversion of most non-AI Nikkor lenses having both an automatic diaphragm and meter coupling prong is available at reasonable cost for the convenience of Nikkor lens users. Please contact your local authorized Nikon dealer.

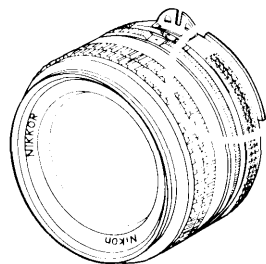
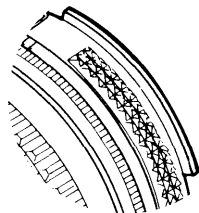

Free Manuals Download Website

<http://myh66.com>

<http://usermanuals.us>

<http://www.somanuals.com>

<http://www.4manuals.cc>

<http://www.manual-lib.com>

<http://www.404manual.com>

<http://www.luxmanual.com>

<http://aubethermostatmanual.com>

Golf course search by state

<http://golfingnear.com>

Email search by domain

<http://emailbydomain.com>

Auto manuals search

<http://auto.somanuals.com>

TV manuals search

<http://tv.somanuals.com>