

Panasonic®

■ This product is eligible for the AVCCAM
3 Year Warranty Repair Program. For
details, see page 6.

Operating Instructions **Vol.1**

Memory Card Camera-Recorder

Model No. **AG-AC130AP**

Volume **1**

Note that Operating Instructions Vol.1 describes basic operations of the Memory Card Camera-Recorder.

For instructions on advanced operations of the Memory Card Camera-Recorder, refer to Operating Instructions Vol.2 (pdf file) contained in the supplied CD-ROM. (Page 10)

AVCCAM

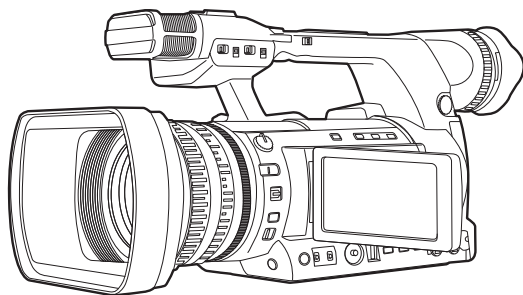

AVCHD™



DOLBY
DIGITAL
STEREO CREATOR

HDMI™
HIGH DEFINITION MULTIMEDIA INTERFACE

Before operating this product, please read the instructions carefully and save this manual for future use.

SS0412SI0 -YI
Printed in Japan

ENGLISH
VQT4K21 (E)



CAUTION
RISK OF ELECTRIC SHOCK
DO NOT OPEN



CAUTION: TO REDUCE THE RISK OF ELECTRIC SHOCK, DO NOT REMOVE COVER (OR BACK). NO USER-SERVICEABLE PARTS INSIDE. REFER TO SERVICING TO QUALIFIED SERVICE PERSONNEL.



The lightning flash with arrowhead symbol, within an equilateral triangle, is intended to alert the user to the presence of uninsulated "dangerous voltage" within the product's enclosure that may be of sufficient magnitude to constitute a risk of electric shock to persons.



The exclamation point within an equilateral triangle is intended to alert the user to the presence of important operating and maintenance (servicing) instructions in the literature accompanying the appliance.

WARNING:

- To reduce the risk of fire or electric shock, do not expose this equipment to rain or moisture.
- To reduce the risk of fire or electric shock hazard, keep this equipment away from all liquids. Use and store only in locations which are not exposed to the risk of dripping or splashing liquids, and do not place any liquid containers on top of the equipment.

WARNING:

Always keep memory cards or accessories (coin battery, microphone holder screws, microphone holder adaptor, INPUT terminal covers) out of the reach of babies and small children.

CAUTION:

To reduce the risk of fire or electric shock and annoying interference, use the recommended accessories only.

CAUTION:

Do not jar, swing, or shake the unit by its handle while the conversion lens or another accessory is attached. Due to the added weight of the conversion lens, any strong jolt to the handle may damage the unit or result in personal injury.

CAUTION:

The mains plug of the power supply cord shall remain readily operable.
The AC receptacle (mains socket outlet) shall be installed near the equipment and shall be easily accessible.
To completely disconnect this equipment from the AC mains, disconnect the power cord plug from the AC receptacle.

CAUTION:

Danger of explosion or fire if battery is incorrectly replaced or mistreated.

- Do not disassemble the battery or dispose of it in fire.
- Do not store in temperatures over 60°C (140°F).
- Do not expose the battery to excessive heat such as sunshine, fire or the like.

For Battery Pack

- Use specified charger.
- Replace only with same or specified type.

For Battery of Remote Controller

- Replace battery with part No. CR2025 only.
- Do not recharge the battery.

CAUTION:

In order to maintain adequate ventilation, do not install or place this unit in a bookcase, built-in cabinet or any other confined space.

To prevent risk of electric shock or fire hazard due to overheating, ensure that curtains and any other materials do not obstruct the ventilation.

CAUTION:

Do not lift the unit by its handle while the tripod is attached. When the tripod is attached, its weight will also affect the unit's handle, possibly causing the handle to break and hurting the user. To carry the unit while the tripod is attached, take hold of the tripod.

CAUTION:

Excessive sound pressure from earphones and headphones can cause hearing loss.

CAUTION:

Do not leave the unit in direct contact with the skin for long periods of time when in use.
Low temperature burn injuries may be suffered if the high temperature parts of this unit are in direct contact with the skin for long periods of time. When using the equipment for long periods of time, make use of the tripod.

CAUTION:

Keep metal objects (such as necklaces and hairpins) away from the battery.
Short-circuiting may occur across the terminals, causing the battery to heat up, and you may seriously burn yourself if you touch the battery in this state.

CAUTION:

This apparatus can be operated at a voltage in the range of 110-240 V AC.
Voltages other than 120 V are not intended for U.S.A. and Canada.
Operation at a voltage other than 120 V AC may require the use of a different AC plug. Please contact either a local or foreign Panasonic authorized service center for assistance in selecting an alternate AC plug.

FCC NOTICE (USA)

Declaration of Conformity

Model Number: AG-AC130AP
Trade Name: Panasonic
Responsible Party: Panasonic Corporation of North America One Panasonic Way, Secaucus, NJ 07094
Support contact: 1-800-524-1448

This device complies with Part 15 of the FCC Rules.

Operation is subject to the following two conditions:

(1) This device may not cause harmful interference, and (2) this device must accept any interference received, including interference that may cause undesired operation.

To assure continued compliance, follow the attached installation instructions and do not make any unauthorized modifications.

CAUTION:

This equipment has been tested and found to comply with the limits for a Class B digital device, pursuant to Part 15 of the FCC Rules. These limits are designed to provide reasonable protection against harmful interference in a residential installation. This equipment generates, uses and can radiate radio frequency energy and, if not installed and used in accordance with the instructions, may cause harmful interference to radio communications. However, there is no guarantee that interference will not occur in a particular installation. If this equipment does cause harmful interference to radio or television reception, which can be determined by turning the equipment off and on, the user is encouraged to try to correct the interference by one of the following measures:

- Reorient or relocate the receiving antenna.
- Increase the separation between the equipment and receiver.
- Connect the equipment into an outlet on a circuit different from that to which the receiver is connected.
- Consult the dealer or an experienced radio/TV technician for help.

The user may find the booklet "Something About Interference" available from FCC local regional offices helpful.

FCC Warning:

To assure continued FCC emission limit compliance, follow the attached installation instructions and the user must use only shielded interface cables when connecting to host computer or peripheral devices. Also any unauthorized changes or modifications to this equipment could void the user's authority to operate this device.

NOTIFICATION (Canada)

This class B digital apparatus complies with Canadian ICES-003.
Cet appareil numérique de la classe B est conforme à la norme NMB-003 du Canada.

IMPORTANT SAFETY INSTRUCTIONS

- 1) Read these instructions.
- 2) Keep these instructions.
- 3) Heed all warnings.
- 4) Follow all instructions.
- 5) Do not use this apparatus near water.
- 6) Clean only with dry cloth.
- 7) Do not block any ventilation openings. Install in accordance with the manufacturer's instructions.
- 8) Do not install near any heat sources such as radiators, heat registers, stoves, or other apparatus (including amplifiers) that produce heat.
- 9) Do not defeat the safety purpose of the polarized or grounding-type plug. A polarized plug has two blades with one wider than the other. A grounding-type plug has two blades and a third grounding prong. The wide blade or the third prong are provided for your safety. If the provided plug does not fit into your outlet, consult an electrician for replacement of the obsolete outlet.
- 10) Protect the power cord from being walked on or pinched particularly at plugs, convenience receptacles, and the point where they exit from the apparatus.
- 11) Only use attachments/accessories specified by the manufacturer.
- 12) Use only with the cart, stand, tripod, bracket, or table specified by the manufacturer, or sold with the apparatus. When a cart is used, use caution when moving the cart/apparatus combination to avoid injury from tip-over.
- 13) Unplug this apparatus during lightning storms or when unused for long periods of time.
- 14) Refer all servicing to qualified service personnel. Servicing is required when the apparatus has been damaged in any way, such as power-supply cord or plug is damaged, liquid has been spilled or objects have fallen into the apparatus, the apparatus has been exposed to rain or moisture, does not operate normally, or has been dropped.



IMPORTANT

"Unauthorized recording of copyrighted television programs, video tapes and other materials may infringe the right of copyright owners and be contrary to copyright laws."



A lithium ion/polymer battery that is recyclable powers the product you have purchased. Please call 1-800-8-BATTERY for information on how to recycle this battery.

For USA-California Only

This product contains a CR Coin Cell Lithium Battery which contains Perchlorate Material – special handling may apply.

See www.dtsc.ca.gov/hazardouswaste/perchlorate

Brazil Only

Brasil Apenas

■ Manuseio de baterias usadas



BRASIL

Após o uso, as pilhas e /ou baterias poderão ser entregues ao estabelecimento comercial ou rede de assistência técnica autorizada.

Cobrir os terminais positivo (+) e negativo (-) com uma fita isolante adesiva, antes de depositar numa caixa destinada para o recolhimento. O contato entre partes metálicas pode causar vazamentos, gerar calor, romper a blindagem e produzir fogo.

Não desmonte, não remova o invólucro, nem amasse a bateria. O gás liberado pela bateria pode irritar a garganta, danificar o lacre do invólucro ou o vazamento provocar calor, ruptura da blindagem e produzir fogo devido ao curto circuito dos terminais. Não incinere nem aqueça as baterias, elas não podem ficar expostas a temperaturas superiores a 100°C (212°F). O gás liberado pela bateria pode irritar a garganta, danificar o lacre do invólucro ou o vazamento provocar calor, ruptura da blindagem e produzir fogo devido ao curto circuito dos terminais provocado internamente.

Evite o contato com o líquido que vazar das baterias. Caso isto ocorra, lave bem a parte afetada com bastante água. Caso haja irritação, consulte um médico.

Para remover a bateria

Bateria Principal de Energia

Pressione o botão para liberar a bateria.

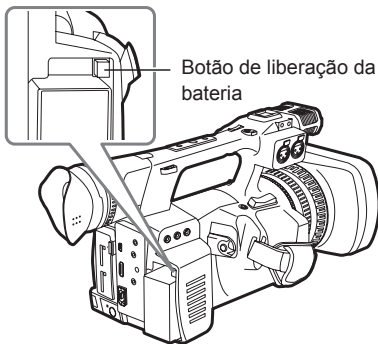

Bateria do Controle Remoto

1) Empurre a trava na direção exibida pela seta ① para remover o suporte.

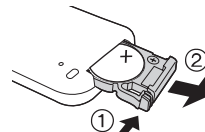

2) Remova a bateria tipo botão do suporte da bateria.

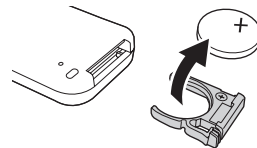

■ **Batteries that may be used with this product (Correct as of September 2011)**

Panasonic CGA-E/625 (bundled) and VW-VBG6 (optional) batteries may be used with this product. The CGA-E/625 (bundled) and VW-VBG6 (optional) batteries contain a function to enable verification as to whether they may be safely used with this product.

It has been found that counterfeit battery packs which look very similar to the genuine product are made available to purchase in some markets. Some of these battery packs are not adequately protected with internal protection to meet the requirements of appropriate safety standards. There is a possibility that these battery packs may lead to fire or explosion. Please be advised that we are not liable for any accident or failure occurring as a result of use of a counterfeit battery pack. To ensure that safe products are used we would recommend that a genuine Panasonic battery pack is used.

AC Adaptor (Battery Charger)

The rating plate is on the underside of the AC Adaptor (Battery Charger). Disconnect the AC mains plug from the AC mains socket when not in use.

AVCCAM 3 Year Warranty Repair Program*¹

Thank you for purchasing this Panasonic AVCCAM device.
Register as a user for this device to receive a special service warranty up to three years of free warranty repairs.

Customers who register as users on the website will receive an extended warranty repair valid for up to three years.



	1 st year	2 nd year	3 rd year
AVCCAM device* ²	Basic warranty* ³	Extended warranty repair* ⁴	

*1: Please note that this extended warranty is not available in some countries/regions. *2: Not all models eligible for extended warranty coverage. *3: The basic warranty period may vary depending on the country/region. *4: Not all repair work is covered by this extended warranty.



Details about user registration and the extended warranty: http://panasonic.biz/sav/pass_e
Please note, this is a site that is not maintained by Panasonic Canada Inc. The Panasonic Canada Inc. privacy policy does not apply and is not applicable in relation to any information submitted. This link is provided to you for convenience.

-
- The SDHC logo and SDXC logo are trademarks of SD-3C, LLC.
 - “AVCHD” and the “AVCHD” logo are trademarks of Panasonic Corporation and Sony Corporation.
 - The “DV” is a registered trademark.
 - Manufactured under license from Dolby Laboratories.
Dolby and the double-D symbol are trademarks of Dolby Laboratories.
 - HDMI, the HDMI logo, and High-Definition Multimedia Interface are trademarks or registered trademarks of HDMI Licensing LLC.
 - Microsoft®, Windows®, and Windows Vista® are either registered trademarks or trademarks of Microsoft Corporation in the United States and/or other countries.
 - Screenshots are used in accordance with Microsoft Corporation guidelines.
 - IBM and PC/AT are registered trademarks of International Business Machines Corporation.
 - Intel® is a registered trademark or a trademark of Intel Corporation in the United States and/or other countries.
 - Apple®, Macintosh®, and Mac OS® are trademarks or registered trademarks of Apple Inc. in the United States and/or other countries.
 - Other model names, company names, and product names listed in these operating instructions are trademarks or registered trademarks of their respective companies.
 - This product is licensed under the AVC Patent Portfolio License for the personal and non-commercial use of a consumer, and no license is granted or shall be implied for any use other than the personal uses detailed below.
 - To encode video in compliance with the AVC standard (“AVC Video”)
 - To decode AVC Video that was encoded by a consumer engaged in a personal and non-commercial activity
 - To decode AVC Video that was obtained from a video provider licensed to provide AVC Video
Additional information may be obtained from MPEG LA, LLC (<http://www.mpegla.com>).
 - Separate license contracts must be obtained from MPEG LA where SD Memory Cards containing information recorded with this product are to be distributed to end users for commercial purposes. “End user” refers to persons or organizations handling such contents for personal use.

■ How to read this document

Illustrations

- Illustrations of the camera, menu screens, and other items, may vary from the actual items.
- In order to identify the terminals on the camera body, the supplied protective caps are not illustrated except in “Description of parts” (Pages 19, 20).

Reference pages

- Reference pages in this document are indicated by (Page 00).

SD/SDHC/SDXC memory cards

- SD/SDHC/SDXC memory cards are all described as memory cards. Each name is described when explained individually.

Notations

- The menu items displayed on the screen are enclosed in square brackets like [Menu items], and characters printed on camera and the remote control are enclosed in angle brackets as in <item name>.

Menu display language

- [English] is set in the factory settings. You can change the display language in [LANGUAGE] item of the [OTHER FUNCTIONS] screen.

How to use the camera

This camera is equipped with a 1/3, 2.2 mega pixel 3MOS sensor and an optical 22X cam-type zoom lens. It supports simultaneous and relay recording using two memory card slots. In addition, it is a hand-held camera-recorder that supports commercial HD mode (AVCHD)/SD mode (DV) recording.

- In this document, "HD mode" is referred to as "AVCHD mode" and "SD mode" is referred to as "DV mode".

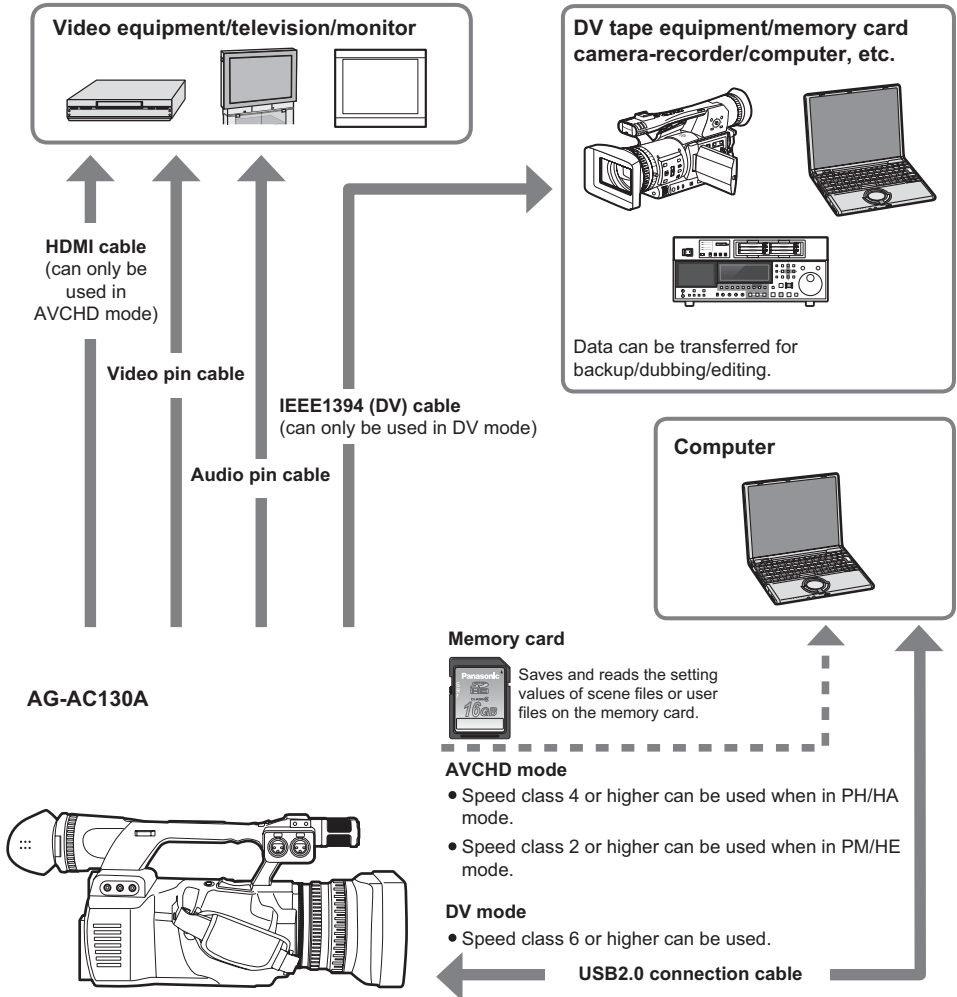

Contents

Volume 1 (This Book)

Read this first!	2
How to use the camera	8
Please read before use	11
Compatible memory card for this camera.....	11
CLASS 4 (SD speed class 4).....	12
CLASS 6 (SD speed class 6).....	12
Operating precautions	13

Before use

Before using the camera	15
Accessories	17
Optional accessories	17

Description of parts

Description of parts	18
Left side	18
Top and right side	19
Front side and rear side.....	20
Remote control	21

Preparation

Recharging the battery	21
Recharging	21
Power sources	23
Using the battery.....	23
Using the AC adaptor.....	24
Adjusting the hand strap	24
Attaching the shoulder strap	25
Attaching/removing the lens hood	25
Attaching/removing the lens cap	25
Fitting the eye cup	26
The remote control	26
Inserting the battery	26
Remote control usable range.....	26
Turning the camera ON/OFF	27
Switching to AVCHD mode/DV mode	27
Setup menu basic operations	28
Using the setup menu	28
Initializing the setup menu	29
Setting the calendar	30

Menu

Setup menu structure	32
<CAMERA> mode menu	32
Playback <PB> mode menu	34

Reference

Specifications	35
-----------------------------	-----------

Shooting

- Using the viewfinder
- Tally lamp
- Basic shooting operations
- Using the zoom function
- Shooting in manual mode
- Shooting in 1080i/480i progressive mode
- Using convenient shooting functions
- Using special functions for recording
- Adjusting the shutter speed
- Changing audio input
- Using shooting settings (scene files)
- Storing scene files and other settings on memory cards
- Clip metadata (AVCHD mode only)
- Using the counter
- Charging the built-in battery/setting the time code

Playback

- Basic playback operations
- Thumbnail screen
- Playback settings [PLAY SETUP]
- Thumbnail operations
- Useful playback functions

Editing

- Connecting external devices
- Nonlinear editing
- How to handle data recorded on the memory card
- Dubbing

Displays

- Screen displays

Menu

- Setup menu list

Reference

- Before calling for service
- Updating the firmware incorporated into the unit
- Cleaning
- Storage precautions
- Recording format list
- Index

■ How to open the operating instruction manual PDF files

Discontinue installation if the installation screen of the software opens as a result of inserting the CD-ROM. When [INDEX.pdf] on the CD-ROM is opened, a list of the operating instruction manuals will be displayed. Click on the document name of the manual to be opened.

■ Adobe® Reader® is required to read PDF files.

It can be downloaded from the home page of Adobe Systems.

Please read before use

Compatible memory card for this camera

■ Shooting in AVCHD mode

Speed class 4 or above is required for recording in PH mode/HA mode. Speed class 2 or above is required for recording in PM mode/HE mode. It is recommended that you use the following Panasonic memory cards. (As of September, 2011)

■ Shooting in DV mode

Speed class 6 or above memory cards are required. It is recommended that you use the following Panasonic memory cards. (As of September, 2011)

Memory card type	Storage capacity	AVCHD shooting/playback	DV shooting/playback	Saving/reading user files and scene files and reading metadata (AVCHD only)
SD memory card	8 MB 16 MB	Cannot be used.	Cannot be used.	Can be used.
	32 MB 64 MB 128 MB 256 MB	Successful operation is not guaranteed. Shooting may suddenly stop with certain SD memory cards.		
	512 MB	Can be used.	Can be used.	
	1 GB			
	2 GB			
SDHC memory card	4 GB	Can be used.	Can be used.	
	6 GB		—	
	8 GB		Can be used.	
	12 GB		—	
	16 GB		Can be used.	
	32 GB			
SDXC memory card	48 GB	Can be used.	Can be used.	
	64 GB			

—: No available Panasonic memory cards

- Please see our support page at the following website for the latest information not included in these operating instructions.
<http://pro-av.panasonic.net/>
- This camera supports FAT12 and FAT16 formatted SD memory cards, FAT32 formatted SDHC memory cards, and exFAT formatted SDXC memory cards that are compliant with the SD standard.
- SDHC memory cards of 4 GB or above that do not have the SDHC logo and SDXC memory cards of 48 GB or above that do not have the SDXC logo are not compliant with the SD standard.
- Use this camera to format memory cards. Formatting memory cards on computers or other devices may cause recording to take longer than normal, or may cause memory cards to become incompatible with this product. (Page 13 of Vol.2) (Use this camera to reformat any memory cards that have been formatted on computers or other devices.)
- Multimedia cards cannot be used.

CLASS 4 (SD speed class 4)

This refers to a class 4 speed standard (SD speed class) for the continuous writing of data between SD compatible devices and memory cards as designated by the SD standard.

When the use of an SD speed class 4 memory card is recommended for SD-compatible products, this indicates that stable recording operation can be achieved by using memory cards of class 4 and above.

CLASS 6 (SD speed class 6)

This refers to a class 6 speed standard (SD speed class) for the continuous writing of data between SD compatible devices and memory cards as designated by the SD standard.

When the use of an SD speed class 6 memory card is recommended for SD-compatible products, this indicates that stable recording operation can be achieved by using memory cards of class 6 and above.

UHS-I compatibility

- UHS-I (Ultra High Speed I) is speed standard for SD memory card. You can use a UHS-I memory card, which performs as an SD speed class 10 memory card on this camera.

Reminders for handling

- Do not allow dirt, water, or other substances to come into contact with the terminal on the back of the memory card.
 - Do not leave the memory card in the following places:
 - Direct sunlight or places of high temperature, such as near heating equipment
 - Humid and dusty locations
 - Locations with high variations in temperature (where condensation occurs)
 - Locations that are subject to static electricity and electromagnetic waves
 - Store memory cards in bags or cases after use.
-
-

Operating precautions

When using the camera in the rain, snow, or at the beach, do not allow water to get into it.

- Doing so will cause damage to the camera and the memory card. (This may result in irreparable damage.)

Keep the camera away from devices (such as TV sets and video game machines) that generate magnetic fields.

- Using the camera on top of or near a television set may cause distortions in the image or sound due to the electromagnetic waves that the television emits.
- The powerful magnetic fields generated by speakers or large motors may damage recorded content or distort images.
- The electromagnetic waves emitted from a microcomputer may adversely affect the camera and cause images or sound to be distorted.
- If the camera is adversely affected by devices that generate magnetic fields and it no longer operates properly, turn it off and remove the battery or unplug the AC adaptor from the power outlet. Then install the battery again or reconnect the AC adaptor. After this, turn the camera back on.

Do not use the camera near radio transmitters or high-voltage equipment.

- Using the camera near radio transmitters or high-voltage equipment may adversely affect the recorded images or sound.

Do not allow sand or dust to get into the camera when using it at the beach or other similar places.

- Sand and dust can damage the camera or memory card. (Be careful when inserting or removing a memory card.)

AC adaptor (battery charger) and battery

- If the <CHARGE> lamp continues to flash even when the battery temperature is normal, the battery or AC adaptor (battery charger) might be damaged. Contact your dealer.
- The battery takes longer to charge when it is warm.
- Using the AC adaptor (battery charger) near radios may distort their sound. Keep the AC adaptor (battery charger) 1 meter or more away from radios.
- The AC adaptor (battery charger) may make some noise when in use, but this is normal.

Be careful not to drop the camera when carrying it around.

- Strong impacts may damage the camera unit and cause it to stop working properly.
- Handle the camera with care using the hand strap or shoulder strap to carry it.

Do not spray the camera with insecticides or other volatile substances.

- Spraying the camera with insecticides or other volatile substances may deform it or cause the coating to peel off.
- Do not leave the camera in contact with rubber or PVC products for extended periods of time.

After use, remove the battery or disconnect the AC power supply cord from the power outlet.

Battery characteristics

This camera uses a rechargeable lithium ion battery. It generates electrical energy through an internal chemical reaction. This reaction is easily influenced by the ambient temperature and humidity, and the effective operating time of the battery is reduced as the temperature rises or falls. If you use this camera at locations with extremely low temperatures, its operating time will be reduced.

If the battery becomes extremely hot, a protective function will engage and you will not be able to use it for a while.

Make sure to remove the battery after use.

Completely remove the battery from the camera. (Even if you turn the camera off, leaving the battery attached still consumes a small amount of electricity.) The battery will over-discharge if you leave it in the camera for long periods of time and may become impossible to recharge.

Do not remove the battery when the POWER switch is ON.

Turn the POWER switch OFF and make sure that the mode lamp is completely off before removing the battery.

Protect the battery terminals.

Do not allow dust or foreign substances to cling to the battery terminals.

If you accidentally drop the battery, check the body and terminals if they have been deformed.

Inserting a deformed battery into the camera or the AC adaptor (battery charger) may damage the camera or the AC adaptor (battery charger).

Reminders when discarding memory cards or transferring them to others

Formatting memory cards or deleting data using the functions of this camera or a computer will merely change the file management information and will not completely erase the data stored in the memory cards. It is recommended that you physically destroy memory cards when discarding them, or use data deletion software for commercially available for computers to completely erase the data when transferring them to others. Users are responsible for managing the data stored in their memory cards.

Liquid crystal displays

- Images or characters can linger on the screen of the LCD or viewfinder if they are left displayed for a long time, but you can fix this by leaving the camera off for several hours.
- The LCD monitor is managed with high precision to ensure that 99.99% of the pixels are effective leaving only 0.01% of pixels that are either dead or remain on all the time. This is normal and will have no effect on recorded images.
- Dew may form on the LCD monitor if you use the camera in locations of intensely varying temperatures. Wipe it dry with a soft, dry cloth.
- The LCD monitor may appear a little dimmer right after turning on a cold camera. The brightness will go back to normal when the internal temperature increases.

Do not point the eyepiece of the lens or viewfinder at the sun.

Doing so may damage the internal parts.

Protective caps for the terminals

Keep protective caps fitted over connecting terminals that are not being used.

Mosaic-like noise may appear on the playback images in the following shooting conditions.

- When there is a complex pattern in the background
- When moving the camera a long distance or moving quickly
- When the subject is moving quickly (Especially when shooting in HE mode)

Depending on the signal reading system of the pickup devices (MOS sensor), the following problems may occur.

- A subject that quickly crosses the screen may appear distorted in some shooting conditions.
- When a subject is lit by the flash, the screen may appear split horizontally. (The possibility of the occurrence may be reduced by setting the shutter speed lower.)

Before using the camera

Always take trial shots

- When shooting important events (such as weddings), make sure to take trial shots to confirm that sound and image are being properly recorded before actual shooting.

Be sure to check and set the calendar and time zone

- These settings affect the control and playback sequence of recorded contents. Check and set the calendar and time zone before shooting. (Page 30)

There are no guarantees for recorded content

- In the unlikely event that content that was not recorded due to a malfunction in the camera or the memory card in use, please understand that no compensation can be provided.

Copyrights

- Copyright laws forbid the use of video and audio material that you recorded for any purpose other than your own personal enjoyment.

Caution regarding laser beams

- The lens may suffer damage if struck by a laser beam. Make sure that laser beams do not strike the lens when shooting in an environment where laser devices are used.

Media that can be used with this camera

- SD/SDHC/SDXC memory cards can be used. See page 11 for details.

Attaching the camera to a tripod

- The tripod hole supports 1/4-20UNC and 3/8-16UNC screws. Use it according to the fixing screw diameter of the tripod.
- The depth of the tripod hole is 5.5 mm. Do not tighten the tripod screw excessively when attaching this camera to a tripod.

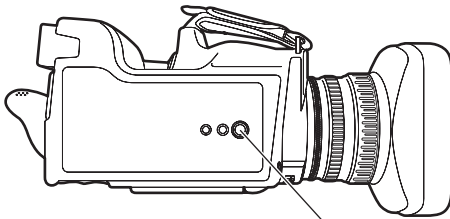

Attach the tripod to the tripod hole on the bottom side.

■ What is AVCHD?

AVCHD is a standard for recording and playback of high definition video. Video is compressed in the MPEG-4 AVC/H.264 format, and audio is recorded in Dolby Digital.

■ What is DV?

DV is a format that adopts the AVI Type2 file format that can record and play back video in DV mode. It records audio in linear PCM format.

Regarding SDHC/SDXC memory card and recorded video compatibility, take note of the following:

SDHC/SDXC memory cards

- SDHC/SDXC memory cards cannot be used with non-SDHC/SDXC-compatible equipment.
- When using another device, ensure that it supports SDHC/SDXC memory cards.



Compatibility of video recorded in AVCHD mode

- Recorded video cannot be used with non-AVCHD-compatible equipment.
- Playback may not always be possible on all AVCHD-compatible equipment. In such instances, play your video using this camera.







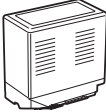

Compatibility of video recorded in DV mode

- When playing back memory cards recorded using the DV mode of the camera in Panasonic AG-HMC80 series
 - [?] is displayed on the clip on the thumbnail screen.
 - The playback will be images only. Audio is not played back.
 - You cannot delete or repair a recorded clip, or add or remove a shot mark.
- When playing back a memory card recorded using a camera in Panasonic AG-HMC80 series on this camera
 - [?] is displayed on the clip on the thumbnail screen.
 - Both image and audio can be played back.
 - You cannot delete or repair a recorded clip, or add or remove a shot mark.

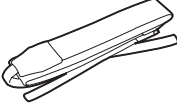
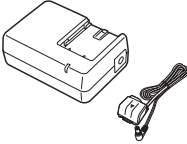

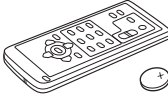

-
-
- For details about clips, see "Thumbnail screen" (Page 51 of Vol.2).
-
-

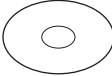
Accessories

Before use

<p>Battery*</p> 	<p>Eye cup (Page 26)</p> 	<p>Shoulder strap (Page 25)</p> 	<p>AC adaptor (Battery charger)/ DC cord</p> 
<p>AC power supply cables</p> 	<p>Wireless remote control and coin battery (CR2025) (Page 26)</p> 	<p>Microphone holder (Page 63 of Vol.2)</p> 	<p>Microphone holder screws (Page 63 of Vol.2)</p> <p>Length 6 mm (2 pieces)</p>  <p>Length 12 mm (2 pieces)</p> 
<p>Microphone holder adaptor (Page 63 of Vol.2)</p> 	<p>CD-ROM</p>  <ul style="list-style-type: none"> - Operating Instructions (PDF) - AVCCAM Restorer Software - AVCCAM SD Card File Recovery Software 		

The following accessories are attached to the unit.

<p>Lens cap (Page 25)</p> 	<p>INPUT terminal cap (2 pieces)</p> 	<p>Lens hood (Page 25)</p> 	<p>Hand strap (Page 24)</p> 
---	--	--	---

* The battery provided with this product is CGA-E/625. If you need an additional battery, see the following optional accessories list.

- Consult your dealer when purchasing additional accessories.
- Adequately process the AC cord cap and the packaging material after taking out the product.

Optional accessories

- **XLR microphone**
AG-MC200G
- **Battery**
VW-VBG6 (7.2 V, 5800/5400 (typ./min.) mAh)

Description of parts

Left side

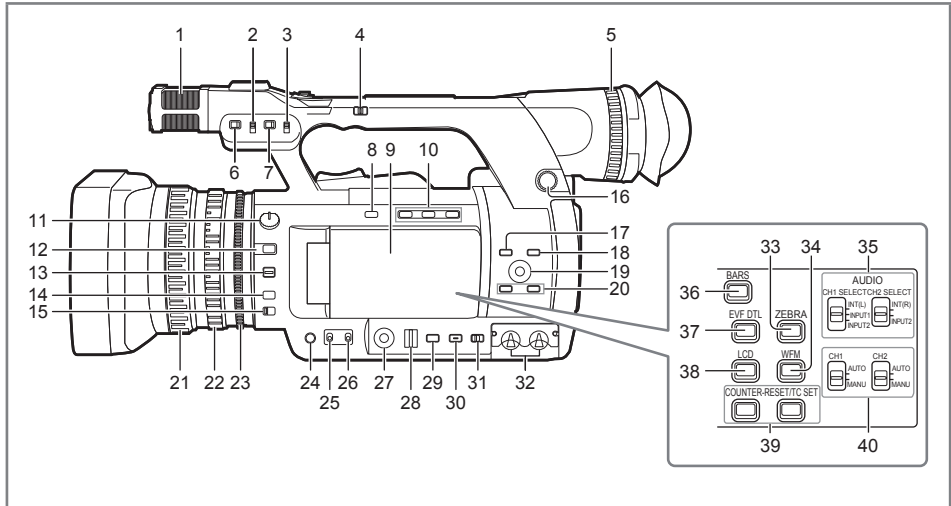

- | | |
|---|--|
| <ul style="list-style-type: none"> 1 Built-in microphone (Page 37 of Vol.2) 2 INPUT1 switch (MIC POWER + 48V) (Page 38 of Vol.2) 3 INPUT2 switch (MIC POWER + 48V) (Page 38 of Vol.2) 4 HANDLE ZOOM switch (Page 17 of Vol.2) 5 Diopter adjustment dial (Page 5 of Vol.2) 6 INPUT1 LINE/MIC switch (Page 38 of Vol.2) 7 INPUT2 LINE/MIC switch (Page 38 of Vol.2) 8 OIS button (Page 27 of Vol.2) 9 LCD monitor (Page 6 of Vol.2) 10 USER button (Page 27 of Vol.2) 11 ND FILTER dial (Page 20 of Vol.2) 12 FOCUS ASSIST button (Page 19 of Vol.2) 13 FOCUS switch (Page 18 of Vol.2) 14 PUSH AUTO button (Page 18 of Vol.2) 15 ZOOM switch (Page 17 of Vol.2) 16 SCENE FILE dial (Page 40 of Vol.2) 17 MENU button (Page 28) 18 EXEC button (Page 57 of Vol.2) 19 OPERATION lever (Page 28) 20 AUDIO MON/ADV button (Page 29 of Vol.2) 21 Focus ring (Page 18 of Vol.2) | <ul style="list-style-type: none"> 22 Zoom ring (Page 17 of Vol.2)
If you do not need the zoom ring pin, attach it to the zoom ring pin hole (Page 19) to prevent the loss. 23 IRIS ring (Page 19 of Vol.2) 24 IRIS button (Page 19 of Vol.2) 25 GAIN switch (Page 20 of Vol.2) 26 WHITE BAL switch (Page 20 of Vol.2) 27 FUNCTION knob (Page 26 of Vol.2) 28 SHTR dial (Page 34 of Vol.2) 29 DIAL SEL button (Page 34 of Vol.2) 30 DISP/MODE CHK button (Page 25 of Vol.2) 31 AUTO/MANU switch (Page 18 of Vol.2) 32 AUDIO LEVEL knob (CH1, CH2) (Page 39 of Vol.2) 33 ZEBRA button (Page 25 of Vol.2) 34 WFM button (Page 28 of Vol.2) 35 AUDIO CH1/CH2 SELECT switch (Page 37 of Vol.2) 36 BARS button (Page 28 of Vol.2) 37 EVF DTL button (Page 6 of Vol.2) 38 LCD button (Page 8 of Vol.2) 39 COUNTER-RESET/TC SET button (Page 46 of Vol.2) 40 AUDIO AUTO/MANU CH1/CH2 switch (Page 39 of Vol.2) |
|---|--|

Top and right side

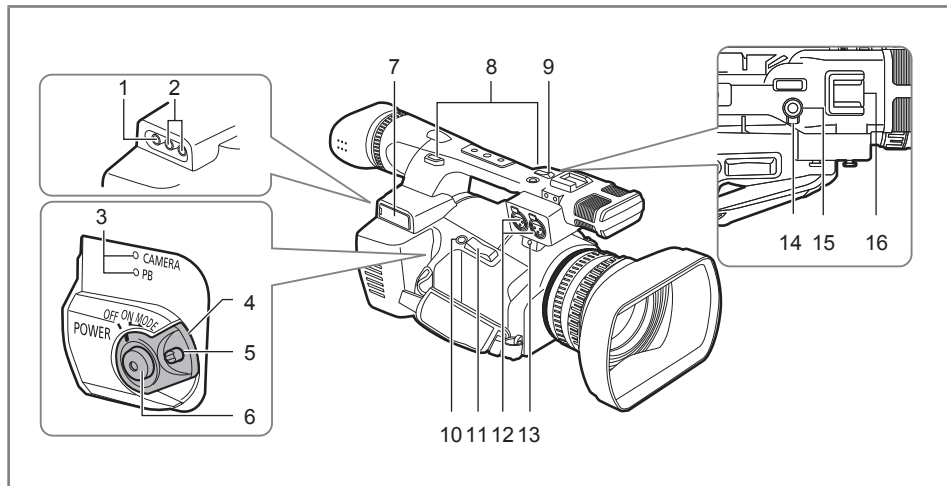

Description
of parts

- 1 VIDEO OUT (TC PRESET IN/OUT) terminal (Page 66 of Vol.2)
- 2 AUDIO OUT CH1/CH2 terminal (Page 66 of Vol.2)
- 3 Mode lamp (Page 27)
- 4 POWER/MODE switch (Page 27)
- 5 Lock release button (Page 27)
- 6 START/STOP button (Page 11 of Vol.2)
- 7 Protective caps
Keep protective caps fitted over connecting terminals that are not being used.
- 8 Shoulder strap mounting location (Page 25)
- 9 Zoom lever (handle side) (Page 17 of Vol.2)
- 10 REC CHECK button (Page 12 of Vol.2)
- 11 Zoom lever (Page 17 of Vol.2)
- 12 AUDIO INPUT1/2 terminal (XLR 3-pin) (Page 38 of Vol.2)
- 13 Zoom ring pin hole
- 14 HOLD switch (Page 24 of Vol.2)
- 15 START/STOP button (handle side) (Page 24 of Vol.2)
- 16 Accessory shoe

Front side and rear side

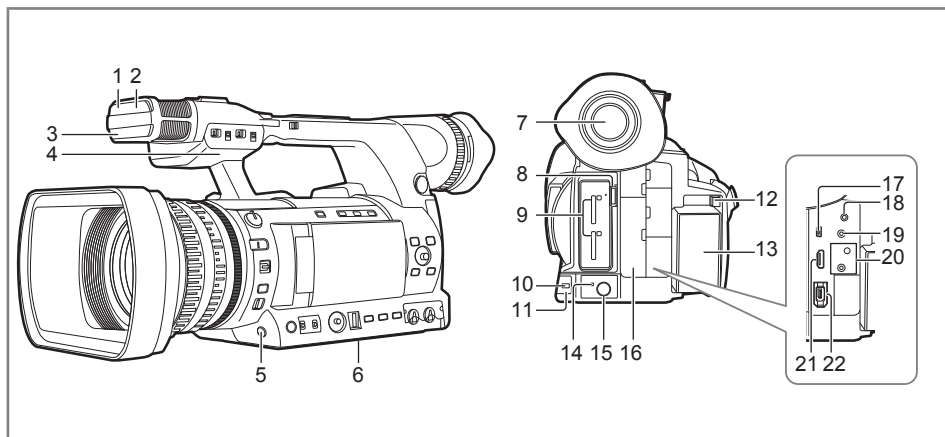

- 1 Remote control sensor (front) (Page 26)
- 2 Natural light sensor (Page 22 of Vol.2)
- 3 Tally lamp (front) (Page 9 of Vol.2)
- 4 Built-in speaker (Page 62 of Vol.2)
- 5 AWB button (Page 20 of Vol.2)
- 6 Tripod hole (bottom) (Page 15)
- 7 Viewfinder (Page 5 of Vol.2)
- 8 Memory card slot cover and OPEN lever (Page 10 of Vol.2)
- 9 Memory card slot and memory card access lamp (Page 12 of Vol.2)
- 10 Tally lamp (rear) (Page 9 of Vol.2)
- 11 Remote control sensor (rear) (Page 26)
- 12 Battery release button (Page 23)
- 13 Battery compartment (Page 23)
- 14 HD indicator (Page 27)
- 15 SLOT SEL button (Page 12 of Vol.2)
- 16 Protective caps
Keep protective caps fitted over connecting terminals that are not being used.
- 17 USB2.0 terminal (Page 64 of Vol.2)
- 18 Headphone jack (3.5 mm stereo mini jack) (Page 63 of Vol.2)
- 19 INDEX REMOTE jack (2.5 mm super mini jack)

20 CAM REMOTE jack*

FOCUS/IRIS (3.5 mm mini jack)

You can connect a remote control unit (optional) to control the FOCUS and IRIS operations.

ZOOM S/S (2.5 mm super mini jack)

You can connect a remote control unit to control the zoom and recording start/stop operation.

- * Do not connect any equipment except the remote control to the <CAM REMOTE> jack. Connecting any equipment other than the remote control may cause the image brightness to change or the images to appear out of focus.

21 HDMI OUT terminal (Page 66 of Vol.2)

22 DV OUT terminal (Page 65 of Vol.2)

Remote control

When using the remote control, set the [IR REMOTE] on the [OTHER FUNCTIONS] menu to [ON]. The factory setting is set to [OFF]. (Page 93 of Vol.2)

Take note that the following buttons are for functions that cannot be executed on this camera.

-  button
- PHOTO SHOT button

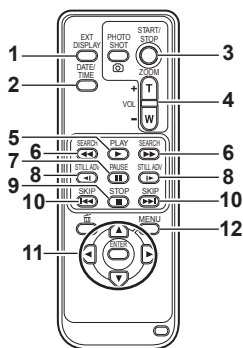

Remote control usable range (Page 26)

- 1 **EXT DISPLAY button**
(Page 62 of Vol.2)
- 2 **DATE/TIME button** (Page 62 of Vol.2)
- 3 **START/STOP button**
Same function as the <START/STOP> button on the camera.
- 4 **ZOOM/VOL button**
(Page 62 of Vol.2)
- 5 **PLAY button** (Page 50 of Vol.2)
- 6 **SEARCH button** (Page 50 of Vol.2, Page 61 of Vol.2)
- 7 **PAUSE button** (Page 50 of Vol.2)
- 8 **STILL ADV button** (Page 62 of Vol.2)
- 9 **STOP button** (Page 50 of Vol.2)
- 10 **SKIP button** (Page 50 of Vol.2, Page 61 of Vol.2)
- 11 **OPERATION buttons**
Same function as the OPERATION lever on the camera.
- 12 **MENU button**
Same function as the MENU button on the camera.

Description of parts

Preparation

Recharging the battery

Recharging

The battery is not charged at the time of purchase. Charge the battery before use. It is recommended that you keep one extra battery as a spare.

1 Connect the power cord to the AC adaptor.

- Disconnect the DC cord. The battery cannot be charged if the DC cord is connected.

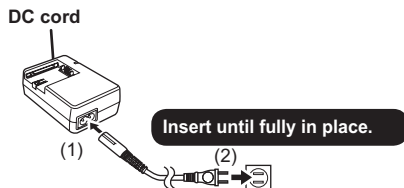

2 Insert the battery.

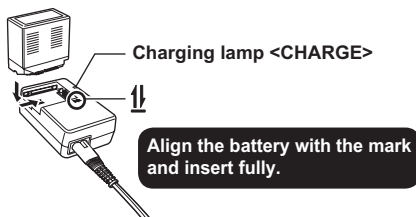

■ Charging lamp

ON: Charging

OFF: Charging complete

Flashing: See below

■ If the charging lamp is flashing

Confirm that there is no dirt, dust, or foreign substances attached to the connectors of the battery or the AC adaptor and ensure that the adaptor has been connected correctly.

- If there is dirt, dust, or foreign substances on the connectors, disconnect the power plug from the socket before cleaning.
- If the charging lamp continues to flash, the battery or the AC adaptor may be damaged. Consult the dealer where it was purchased.

■ Charging time and available recording time standards

Battery model	Voltage/ capacity	Charging time	Maximum continuous recording time
CGA-E/625 (bundled)	7.2 V/ 5800/5400 (typ./min.) mAh	Approx. 5 hours and 50 minutes	Approx. 3 hours and 30 minutes
VW-VBG6 (optional)	7.2 V/ 5800/5400 (typ./min.) mAh	Approx. 5 hours and 50 minutes	Approx. 3 hours and 30 minutes







- The figures in the preceding table are for normal temperature conditions (temperature 25°C (77°F)/ humidity 60%). This only serves as a guide since charging may take longer in high or low temperatures.
- Charging may take longer if the battery has not been in use for a long period of time.
- Given here are the standard maximum continuous recording times when recording in PH 1080/60i mode using the viewfinder with no connections to any external devices and with the LCD monitor closed.
- This serves only as a guide as available recording times may vary according to usage conditions.
- Charging times are based on the time to charge batteries from an empty state.

■ Remaining battery capacity display

When using Panasonic batteries that are compatible with this product, the remaining battery capacity is displayed in minutes.

[] 1h30m

The time remaining (as shown previously) is displayed after a brief pause.

- As battery capacity decreases, the display will change as follows: [] → [] → [] → [] → []. When there are only 3 minutes or less of capacity left, [] will be displayed in red, and when the battery becomes empty, [] will flash.
 - The remaining battery capacity may not be displayed correctly when the battery is used in high or low temperatures, or when the battery has not been used for a long period of time. To ensure that the remaining battery capacity is displayed correctly, use the battery completely from a fully-charged state and charge it again. (Remaining battery capacity may still not be displayed correctly if the battery has been used for long periods in high or low temperatures, or if the battery has already been recharged numerous times.)
 - This only serves as a guide as remaining battery capacity display times may vary according to usage conditions.
 - The remaining battery capacity display will momentarily disappear when switching between modes, when conducting REC CHECK operations, or when changing the LCD brightness since the capacity is recalculated during these times.
 - This is not displayed when using the AC adaptor.
-
- The battery and the camera itself becomes hot while it is being used or charged.
 - Available recording time is reduced if you repeatedly start and stop recording.
 - The battery takes longer to charge when it is warm.
 - Using the AC adaptor near radios may distort their sound. Keep the AC adaptor 1 meter or more away from radios.
 - The AC adaptor may make some noise when in use, but this is normal.
 - The battery cannot be recharged when a DC cord is connected to the AC adaptor.
-

Power sources

Using the battery

Installation

- 1 Insert the battery until it clicks into place.

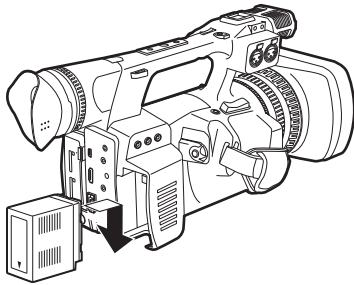

Removal

- 1 Turn the POWER/MODE switch <OFF> (Page 27), and confirm that the mode lamp is off.
- 2 Remove the battery while pressing the battery release button. Support the battery with your hand to ensure that it will not fall.

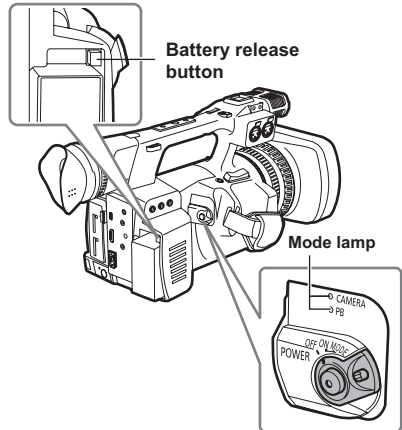

Using the AC adaptor

Installation

- 1 Connect the DC cord to the AC adaptor.
- 2 Plug the AC cord into the power outlet.
- 3 Insert the DC cord's battery connector until it clicks into place.

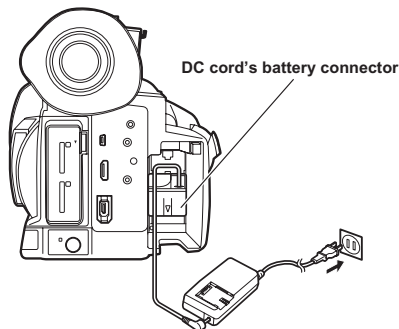

Removal

- 1 Turn the POWER/MODE switch <OFF> (Page 27), and confirm that the mode lamp is off.
- 2 Remove the DC cord's battery connector while pressing the battery release button.
- 3 Disconnect the AC cord from the power outlet.

- The battery cannot be recharged when a DC cord is connected to the AC adaptor.
- Disconnect the AC cord from the power outlet when this device is not in use.

CAUTION:

- This apparatus can be operated at a voltage in the range of 110 – 240 V AC. Voltages other than 120 V are not intended for U.S.A. and Canada. Operation at a voltage other than 120 V AC may require the use of a different AC plug. Please contact either a local or foreign Panasonic authorized service center for assistance in selecting an alternate AC plug.

Adjusting the hand strap

Adjust the hand strap to suit your hand.

- 1 Open the cover and adjust the length of the strap.
- 2 Close the cover.
 - Make sure that the cover is firmly closed.

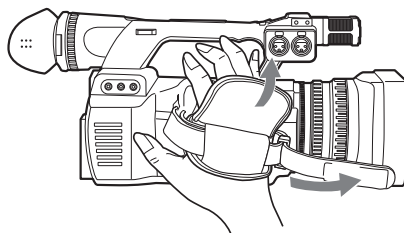

Attaching the shoulder strap

It is recommended that you attach the shoulder strap to avoid dropping the camera.

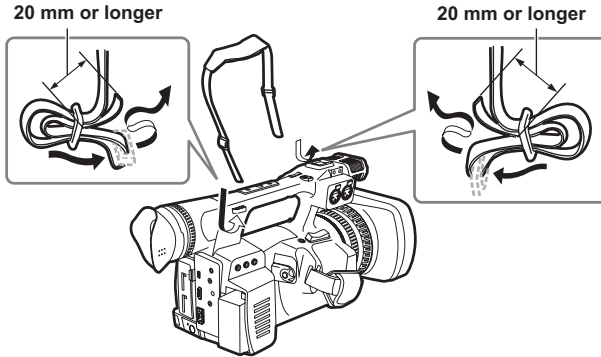

Attaching/removing the lens hood

Removing the lens hood

- Turn the lens hood counterclockwise to remove it.

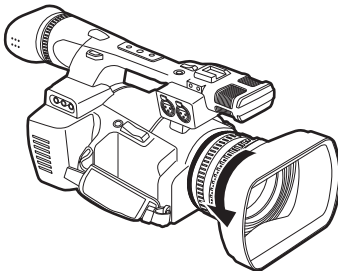

Attaching the lens hood

- Attach the lens hood to the camera with the lens hood guide facing up and aligned to the center of the camera.
- Turn the lens hood clockwise until it clicks and locks into place.

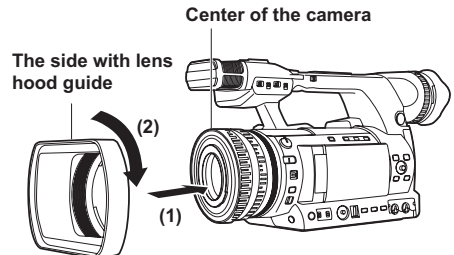

Attaching/removing the lens cap

Removing the lens cap

- Pinch the lens cap to remove it.

Attaching the lens cap

- Pinch the lens cap to attach it.
- Keep the lens cap attached when the camera is not in use to protect the lens.

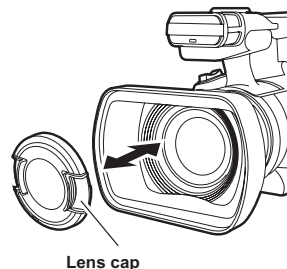

Fitting the eye cup

Attach the eye cup by fitting the eye cup holder and the ridges of the eye cup together.

- Turning the eye cup after attaching it may cause the eye cup holder to come off. If the eye cup holder does come off, see “Cleaning the viewfinder” (Page 102 of Vol.2) and refit it.

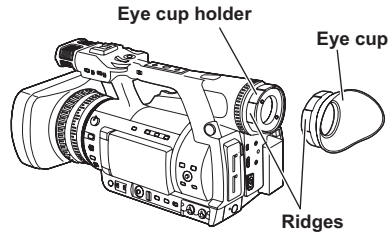

The remote control

Inserting the battery

- 1 Remove the holder while pushing the catch in the direction shown by arrow (1).**

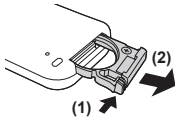

- 2 Insert the battery with the side marked with <+> facing up.**

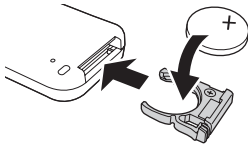

- 3 Return the holder to its original position.**

- When the battery (CR2025) runs out, replace it with a new one. (Battery life depends on the frequency of usage but is approximated at about one year.)

If the remote control unit fails to work even when it is operated near the camera's remote control sensor, it means that the battery has run out.

- **Keep the battery out of the reach of children.**

Remote control usable range

For the remote control sensor,

Distance: Approx. within 5 m

Angle: Approx. 10° upward, 15° downward, and 15° sideways

(using the accessory battery)

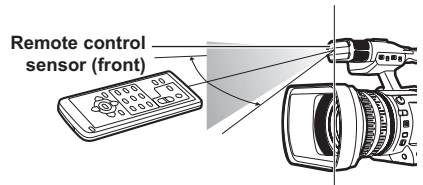
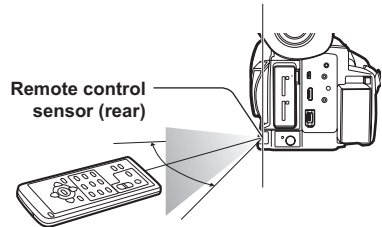

- These are the operation range values when the remote control is used indoors. If used outdoors or if strong light is hitting the remote control sensor, the remote control may not operate properly even within the said ranges.
- The remote control is set to [OFF] in the factory settings. When using the remote control, set the [IR REMOTE] on the [OTHER FUNCTIONS] menu to [ON]. (Page 93 of Vol.2)

Turning the camera ON/OFF

Turning on the power:

Turn the POWER/MODE switch up to the <ON> position while pressing the lock release button.

The mode lamp <CAMERA> lights up in red and the camera goes to recording standby status (<CAMERA> mode).

- If the POWER/MODE switch is turned up to the <MODE> position, the mode lamp <PB> will light up in green and the camera goes to <PB> mode. (Page 50 of Vol.2)
- Every time the switch is turned to the <MODE> position, the mode will change between <CAMERA> mode and <PB> mode.

Turning off the power:

Turn the POWER/MODE switch up to the <OFF> position while pressing the lock release button.

The mode lamp <CAMERA>/<PB> goes off.

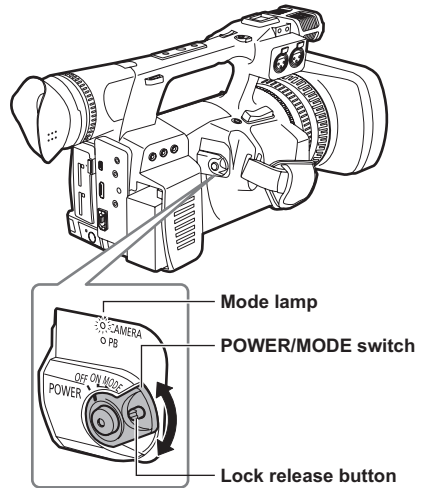

Preparation

Switching to AVCHD mode/DV mode

- 1** Turn the camera's POWER/MODE switch <ON>. (Page 27)
- 2** Press the <MENU> button.
- 3** Set [AVCHD] or [DV] from the [HD/SD MODE] items in the setup menu [RECORDING SETUP] screen.
- 4** When the [TURN POWER OFF] message is displayed, turn the power OFF and then ON again.

When the power is turned on again, the mode changes.

- For instructions on how to turn the camera ON/OFF, refer to page 27.
- When you switch to AVCHD mode, <HD> indicator will light up in blue.
- When you switch to DV mode, <HD> indicator will turn off.

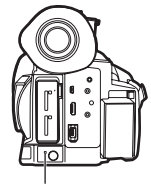

Setup menu basic operations

You can change camera settings using the setup menu according to the shooting scene and recording details.

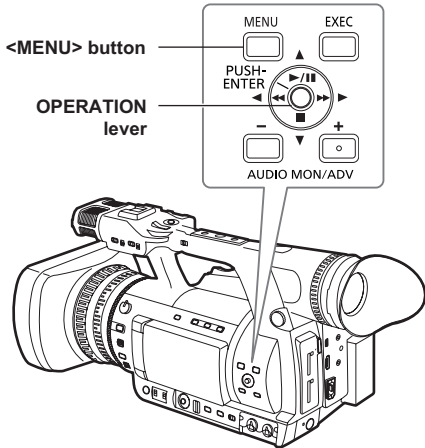

2 Tilt the **OPERATION** lever in the <▲><▼> directions to move the yellow cursor to the function you wish to set.

3 Press the **OPERATION** lever (or tilt it in the <▶> direction) to display the setting items.
Example:

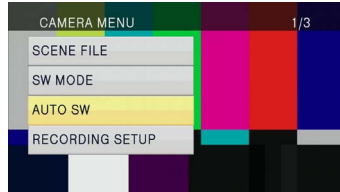

4 Tilt the **OPERATION** lever in the <▲><▼> directions to move to the function you wish to set.
Example:

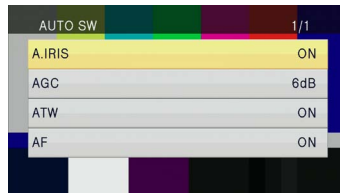

Using the setup menu

- The menu items displayed in gray characters cannot be changed.

1 Press the <MENU> button when the camera is not shooting or playing back video.

The following menu screens are displayed on the viewfinder and LCD monitor.

<CAMERA> mode (Example)

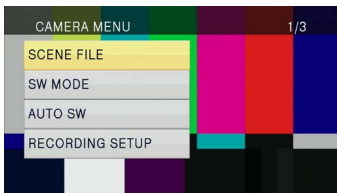

<PB> mode (Example)

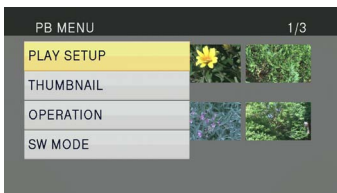

5 Press the **OPERATION** lever (or tilt it in the <▶> direction) to make the setting.

When changing values or other parameters, tilt the **OPERATION** lever in the <▲><▼> directions to change the setting value. Select the item you wish to set, and then press the **OPERATION** lever to confirm.

Example:

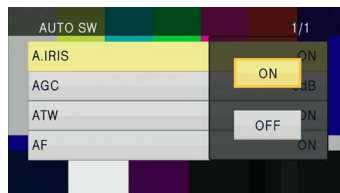

- Tilt the **OPERATION** lever in the <◀> direction to return to the previous menu.

6 Repeat steps 4 to 5 to change other items.

Press the <MENU> button to complete settings and return to the normal screen.

- In some menus, tilting the OPERATION lever in the <◄► direction or pushing the OPERATION lever changes the setting value and returns the previous menu.

7 Repeat steps 2 to 5 to change other functions.

Press the <MENU> button to complete settings and return to the normal screen.

Initializing the setup menu

The setup menu is divided into user files and scene files and you can initialize each one to its factory settings.

To initialize user files (all items other than scene files)

By selecting [INIT] in the [LOAD/SAVE/INIT] item of the [USER FILE] screen, you can restore the current user file menu setting to its factory setting.

To initialize scene files

Among the six scene files, select the file you wish to initialize using the <SCENE FILE> dial. Then by selecting [INIT] in the [LOAD/SAVE/INIT] item of the [SCENE FILE] screen, you can restore the setting value of only the selected scene file to its factory setting.

-
- To initialize user files and scene files at the same time, restore a user file and all six scene files to their factory settings by selecting [YES] in the [MENU INIT] item of the [OTHER FUNCTIONS] screen.
 - Time code/[OPERATION TIME] item/[CLOCK SET] item/[TIME ZONE] item setting values are not initialized.
-

Setting the calendar

The [CLOCK SET] value is recorded in the contents (clip) and affects the playback sequence of the thumbnails. Before shooting, be sure to check/set the [TIME ZONE] and [CLOCK SET]. This section will explain the steps on how to set the calendar to September 22, 2011, 17:20.

- 1 Turn the camera's POWER/MODE switch <ON>. (Page 27)
- 2 Press the <MENU> button.
 - Menu operation (Page 28)
 - Operations can also be performed using buttons on the remote control that correspond to those on the camera. For details, see "Remote control" (Page 21).
- 3 Select the [TIME ZONE] item on the setup menu [OTHER FUNCTIONS] screen and press the OPERATION lever (or tilt it to the <>> direction).

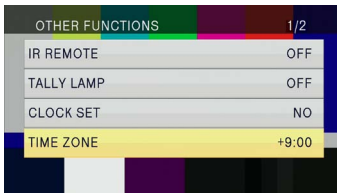

- 4 Since pressing the OPERATION lever will display the settings screen, tilt the OPERATION lever in the <▲><▼> directions to set the time difference from Greenwich Mean Time, then press the OPERATION lever again. Factory default setting is [0:00].

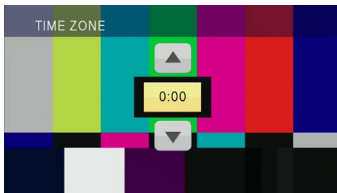

- 5 Tilt the OPERATION lever in the <▲> direction and select [YES] in the [CLOCK SET] item on the setup menu [OTHER FUNCTIONS] screen.

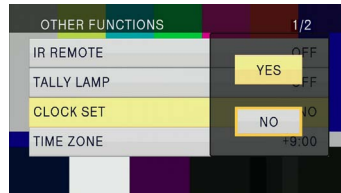

- 6 Tilt the OPERATION lever in the <▲><▼> directions to set to [2011].



- 7 Tilt the OPERATION lever in the <>> direction to change to the next item, then tilt the lever in the <▲><▼> directions to set to [SEP].



8 Repeat steps 6 and 7 to set the remaining items.



- The date can be set to any date between January 1, 2000 and December 31, 2039.
- For any date after December 31, 2039, [-] will appear on the display.
- Time is displayed in the 24-hour format.

9 When settings are complete, press the OPERATION lever.

-
- The time can be inaccurate so confirm that the time is correct before shooting.
 - When using the camera overseas, do not set the [CLOCK SET] to the local time but instead enter the time difference from Greenwich Mean Time according to the [TIME ZONE].
(Page 94 of Vol.2)
-

Setup menu structure

<CAMERA> mode menu

CAMERA MENU

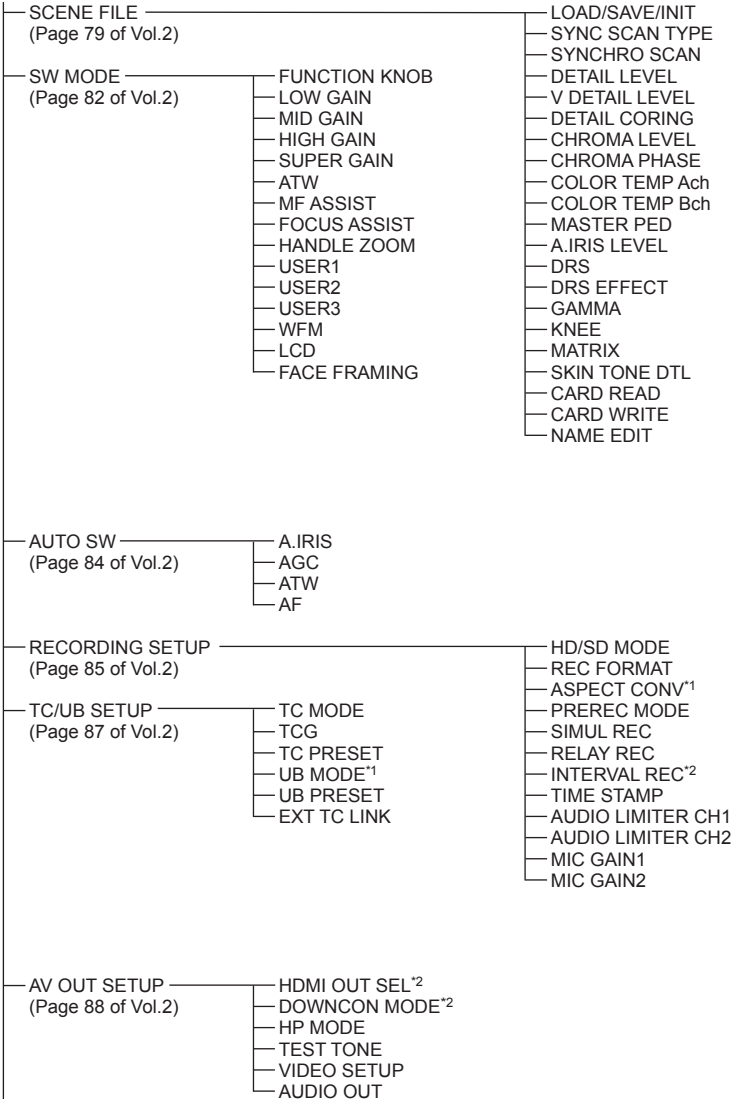

*1 Only in DV mode.

*2 Only in AVCHD mode.

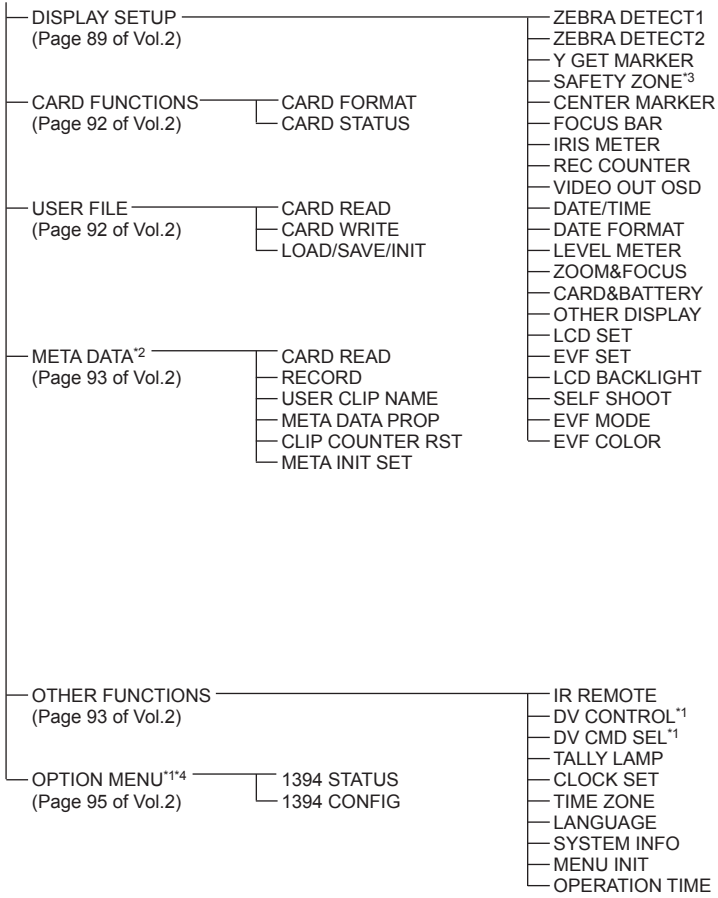

*1 Only in DV mode.
 *2 Only in AVCHD mode.
 *3 Only Limited functions are available in DV mode.
 *4 You can display the OPTION MENU by pressing the CHK button while pressing the DISP/MODE CHK button.

Playback <PB> mode menu

PB MENU

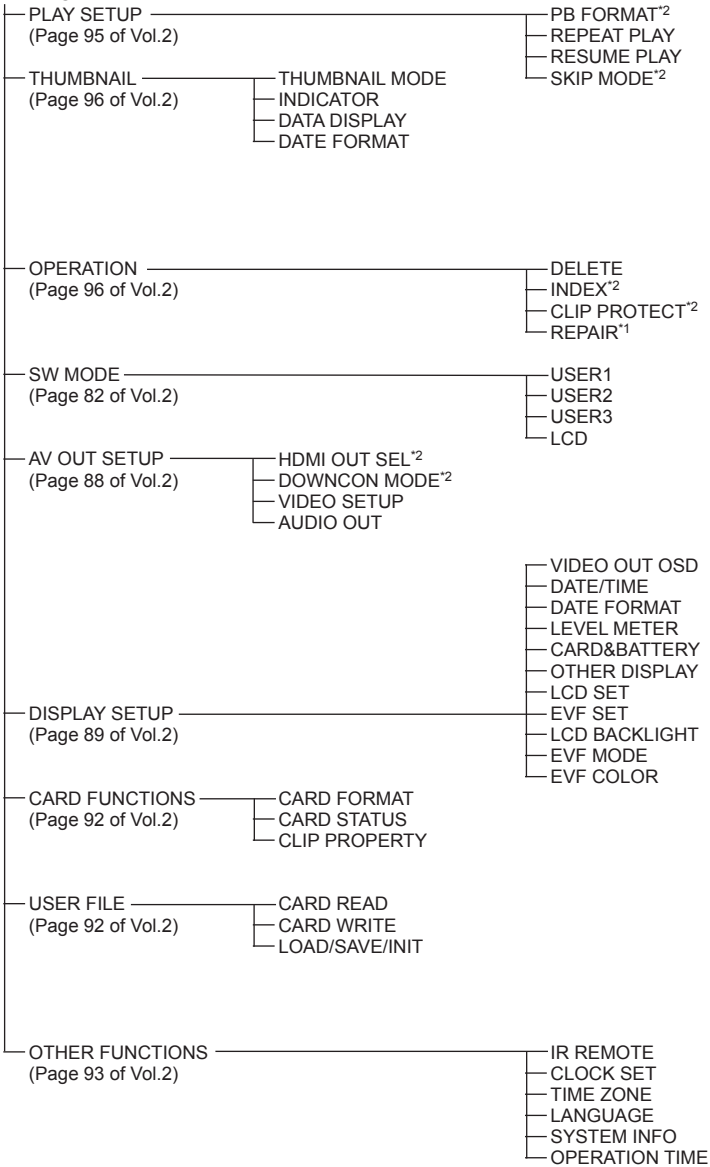

*1 Only in DV mode.

*2 Only in AVCHD mode.

Specifications

General

Supply voltage

DC 7.2 V (when the battery is used)/
DC 7.3 V (when the AC adaptor is used)

Power consumption

Recording: 11.6 W



indicates safety items.

Ambient operating temperature

0°C - 40°C (32°F to 104°F)

Ambient operating humidity

10% to 80% (no condensation)

Weight

Approx. 2.4 kg (5.3 lb) (excluding the battery and accessories)

Dimensions (W x H x D)

180 mm x 195 mm x 438 mm (7 inches x 7-11/16 inches x 17-1/4 inches)
(excluding width, height, depth, and protruding part)

Camera

Pickup devices

1/3 MOS fixed pickup device x 3
(2.2 mega pixels progressive supported)

Lens

Optical image stabilizer lens,
Electric/manual switching, 22X zoom,
F1.6 - 3.2 (f = 3.9 mm to 86 mm)
(35 mm conversion: 28 mm - 616 mm)

Color separation optical system

Prism format

Filter diameter

72 mm

ND filter

OFF, 1/4, 1/16, 1/64

Minimum shooting distance

Approx. 1 m

Gain settings

0/+3/+6/+9/+12/+15/+18/+24/+30 dB
* +24 dB and +30 dB are assigned to the USER
button (S.GAIN)

Color temperature settings

ATW, ATW LOCK, preset 3200 K,
preset 5600 K, preset VAR, Ach, Bch

Digital zoom

2X/5X/10X

* Assigned to the USER button (ratio is changed every time the button is pressed)

Minimum subject illumination

0.4 lx (F1.6, gain +30 dB, shutter speed 1/30 seconds)

Lens hood

Wide field large lens hood

Shutter speed

Preset

60i/60P mode:

1/60, 1/100, 1/120, 1/250, 1/500, 1/1000,
1/2000 seconds

30P mode:

1/30, 1/50, 1/60, 1/120, 1/250, 1/500,
1/1000, 1/2000 seconds

24P mode:

1/24, 1/50, 1/60, 1/120, 1/250, 1/500,
1/1000, 1/2000 seconds

* Underline indicates value when shutter is OFF

Synchro scan

when SYNC SCAN TYPE = sec

60i/60P mode:

1/60.0 seconds - 1/249.8 seconds

30P mode:

1/30.0 seconds - 1/249.8 seconds

24P mode:

1/24.0 seconds - 1/249.8 seconds

when SYNC SCAN TYPE = deg

3.0d - 180.0d - 360.0d

(0.5d increments, angle display)

Slow shutter speed

60i/60P mode:

1/8, 1/15, 1/30 seconds

30P mode:

1/8, 1/15 seconds

24P mode:

1/6, 1/12 seconds

Image/Recording/Playback

■ AVCHD mode

Recording format

AVCHD standard compliant

Compression formats

MPEG-4 AVC/H.264

Recording media

SD memory card:

512 MB, 1 GB, up to 2 GB

(FAT12, FAT16 formats supported)

SDHC memory card:

4 GB, 6 GB, 8 GB, 12 GB, 16 GB, 32 GB

(FAT32 format supported)

SDXC memory card:

48 GB, 64 GB, up to 2 TB

(exFAT format supported)

However, memory cards above Class 4 is supported in PH/HA mode, and memory cards above Class 2 is supported in PM/HE mode.

Recording format (recording mode and resolution)

(The frame rates in the setup menu are 60P, 60i, 30P, and 24P.)

PH 1080/59.94i

PH 1080/29.97P

PH 1080/23.98P (Native recording)

PH 720/59.94P

PH 720/29.97P

PH 720/23.98P (Native recording)

PM 720/59.94P

HA 1080/59.94i

HE 1080/59.94i

Transmission rate

PH mode: Approx. 21 Mbps (VBR)

PM mode: Approx. 8 Mbps (VBR)

HA mode: Approx. 17 Mbps (VBR)

HE mode: Approx. 6 Mbps (VBR)

Interval recording

OFF/1 s/10 s/30 s/1 min/2 min

* For the recording mode, PH 1080/24P fixed, and shooting time has a maximum of 168 hours (1 week)

■ DV mode

Recording format

DV standard compliant

File format

AVI Type2

Recording media

SD memory card:

512 MB, 1 GB, 2 GB

(FAT12, FAT16 formats supported)

SDHC memory card:

4 GB, 8 GB, 16 GB, 32 GB

(FAT32 format supported)

SDXC memory card:

48 GB, 64 GB, up to 2 TB

(exFAT format supported)

However, it is possible to use Class 6 or higher.

Recording format (recording mode and resolution)

(The frame rates in the setup menu are 60i, 30P, and 24P.)

480/59.94i

480/29.97P

480/23.98P

Image output

■ AVCHD mode

HDMI OUT terminal

HDMI (HDMI Type A terminal)

1080/60i, 720/60P, 480/60P

(VIERA Link not supported)

VIDEO OUT terminal

Pin jack, 1.0 V [p-p], 75 Ω

480/60i

■ DV mode

VIDEO OUT terminal

Pin jack, 1.0 V [p-p], 75 Ω

480/60i

Audio recording playback

■ AVCHD mode

Compression formats

Recording/Playback:
Dolby Digital/2 ch

Sampling frequency

48 kHz

Encoding

16 bit

Compressed bit rate

PH mode: 384 kbps
PM/HA/HE mode: 256 kbps

■ DV mode

Compression formats

Recording/Playback:
linear PCM (digital 2 ch)

Sampling frequency

48 kHz

Encoding

16 bit

Audio input

Built-in microphone

Stereo microphone

XLR input

XLR (3-pin) x 2 (AUDIO INPUT1, AUDIO INPUT2), LINE/MIC selectable, high impedance
LINE: 0 dBu
MIC: -40/-50/-60 dBu (menu selectable)
MIC POWER +48 V ON/OFF switchable

Audio output

Audio output

Output level: 600 Ω , 316 mV
Pin jack x 2 (CH1, CH2)

HDMI OUT (AVCHD mode only)

2 ch (linear PCM)/5.1ch (Dolby Digital)

Headphones

3.5 mm diameter, stereo mini jack x 1

Speaker

Round, 20 mm diameter

Other terminals

Camera remote terminal

2.5 mm diameter, super mini jack x 1 (ZOOM S/S)
3.5 mm diameter, mini jack x 1 (FOCUS/IRIS)

INDEX remote terminal

2.5 mm diameter, super mini jack x 1

TC PRESET IN/OUT terminal

VIDEO OUT terminal dual-purpose
IN: 1.0 V - 4.0 V [p-p], 10 k Ω
OUT: 2.0 V \pm 0.5 V [p-p], low impedance

USB2.0 terminal

Memory card reader/writer function (without copyright protection)
Type mini B connector (USB2.0 compliant)

DV OUT terminal (DV mode only)

6-pin (IEEE1394 standard compliant), digital output only

Monitor

LCD

3.45 inch wide LCD color monitor
(approx. 920,000 dots)

Viewfinder

0.45 inch wide LCD color monitor
(approx. 1,220,000 dots equivalent)

AC adaptor

Power Source:

110 V - 240 V AC, 50 Hz/60 Hz
22 W

Power Output:

7.3 V DC, 1.75 A (Camera-recorder)
8.4 V DC, 1.3 A (Charge)



indicates safety items.

Weight

Approx. 140 g (0.31 lb)

Dimensions (W x H x D)

103 mm x 36 mm x 62 mm
(4-1/16 inches x 1-13/32 inches x 2-7/16 inches)

Information on Disposal in other Countries outside the European Union



These symbols are only valid in the European Union. If you wish to discard these items, please contact your local authorities or dealer and ask for the correct method of disposal.

Panasonic Corporation

Web Site: <http://panasonic.net>

© Panasonic Corporation 2012

Download from [Www.Somanuals.com](http://www.Somanuals.com). All Manuals Search And Download.

Free Manuals Download Website

<http://myh66.com>

<http://usermanuals.us>

<http://www.somanuals.com>

<http://www.4manuals.cc>

<http://www.manual-lib.com>

<http://www.404manual.com>

<http://www.luxmanual.com>

<http://aubethermostatmanual.com>

Golf course search by state

<http://golfingnear.com>

Email search by domain

<http://emailbydomain.com>

Auto manuals search

<http://auto.somanuals.com>

TV manuals search

<http://tv.somanuals.com>