

OWNER'S MANUAL

DieHard®

12/2/75 AMP FULLY AUTOMATIC BATTERY CHARGER ENGINE STARTER

Model No.
200.713121



CAUTION:

Before first use of charger, read this manual, and follow all its Safety and Operating Instructions with every charger use.

Save these instructions.

Made in U.S.A. of U.S. and imported parts.

Sears, Roebuck and Co., Hoffman Estates, IL 60179 U.S.A.

598-198

SAFETY

OPERATION

MAINTENANCE

TROUBLESHOOTING

PARTS

TABLE OF CONTENTS

WARRANTY	2
SAFETY	3
Important Safety Instructions	3
OPERATION	4
Before Using Your Battery Charger	5
Assembling your charger	5
Plugging it in	5
Using an extension cord	5
Preparing Your Battery to be Charged	6
Using Your Battery Charger	6
Setting the controls	6
Charging your battery	8
Inside vehicle	8
Outside vehicle	9
Using the Engine Start Feature	10
Calculating Charge Time	11
MAINTENANCE AND CARE	12
TROUBLESHOOTING	13
PARTS	14
Wiring Diagram	15

Please read this Owner's Manual before using your Battery Charger

The DieHard model 200.713121, Fully Automatic Battery Charger/Engine Starter, offers a wide range of features for home or light commercial use. This manual will show you how to use your charger safely and effectively. Please read and follow these instructions and precautions carefully.

WARRANTY

FULL THREE YEAR WARRANTY

Within three years from the date of purchase, this battery charger fails due to a defect in materials or workmanship, RETURN IT TO THE PLACE OF PURCHASE, and it will be repaired or replaced free of charge.

This warranty gives you specific legal rights, and you may also have other rights which vary from state to state.

Sears, Roebuck and Co., Dept. 817WA, Hoffman Estates, IL 60179

IMPORTANT SAFETY INSTRUCTIONS

WARNING: To reduce the risk of explosion, explosive gases, or injury while using your battery charger, follow the precautions listed below:

- Read all instructions and cautions printed on the battery charger, battery, and vehicle or equipment using battery.
- Use charger only on lead-acid type rechargeable batteries, such as those used in cars, trucks, tractors, airplanes, vans, RV's, trolling motors, etc. This charger is not intended to supply power to a low voltage electrical system.
- Use only attachments recommended or sold by manufacturer. The use of attachments not recommended by the manufacturer may result in fire, electric shock, or injury.
- Do not disassemble charger. Take it to a qualified service professional if service or repair is required. Incorrect assembly may result in fire or electrical shock.
- To reduce risk of electrical shock, unplug the charger from the outlet before attempting any maintenance or cleaning.
- Always charge battery in a well ventilated area.
- Battery chargers get hot during operation and must have proper ventilation. Air needs to flow around entire charger.
- Do not set charger on flammable materials like carpeting, upholstery, paper, cardboard etc. Charger may damage leather and melt plastic and rubber.

HELP US HELP YOU —

Remember:

- **Place** charger as far away from battery being charged as the charger cables will permit.
- **Do not** expose charger to rain or snow.
- **Never** charge a frozen battery. If battery fluid (electrolyte) becomes frozen, bring battery into a warm area to thaw before you begin charging.
- **Never** allow battery acid to drip on charger when reading specific gravity or filling battery.
- **Never** set a battery on top of the charger.
- **Never** place charger directly above battery being charged. The gases from the battery will corrode and damage the charger.
- **Never** use charger for charging dry-cell batteries that are commonly used with home appliances like radios, stereos, remote controls, etc. These batteries may burst and cause personal injury.
- **Never** touch the battery clamps together when the charger is on. You will cause a spark.
- **Never** operate charger if it has received a hard blow, been dropped, or otherwise damaged. Take it to a qualified professional for inspection and repair.
- **Be sure** to position the charger power cord to prevent it from being stepped on, tripped over, or damaged.
- **Never** pull out the plug by the cord when unplugging the charger. Pulling on the cord may cause damage to the cord or the plug.
- **Do not** operate the charger if it has a damaged power cord or plug. Have the cord replaced.

Personal Safety Precautions

For your own personal safety, please follow the following precautions:

- **Wear complete eye and clothing protection** when working with lead-acid batteries.
- **Be sure** that someone is within range of your voice to come to your aid if needed while you work with or are near a lead-acid battery.
- **Have plenty of fresh water and soap** nearby for use in case battery acid contacts your eyes, skin, or clothing. If this happens, wash immediately with soap and water. Then get medical attention.
- **Avoid touching your eyes** while working with a battery. Acid particles (corrosion) may get into your eyes. If this occurs, flush eyes immediately with running cold water for at least 10 minutes. Then immediately get medical attention.
- **Remove all personal metal items** from your body, such as rings, bracelets, necklaces, and watches while working with a lead-acid battery. A battery can produce a short circuit current high enough to weld a ring (or the like) to metal, causing a severe burn.
- **Take care** not to drop any metal tool or metal object onto the battery. This may spark or short circuit the battery or another electrical device that may cause an explosion.
- **Always** operate your battery charger in an open, well ventilated area.
- **Never** smoke or allow a spark or flame in the vicinity of the battery or engine. Batteries generate explosive gases.
- **Neutralize** any acid spills thoroughly with baking soda before attempting to clean up.

BEFORE USING YOUR BATTERY CHARGER

It is important to understand your charger's requirements. This section will tell you about your charger's electrical requirements and how to prepare a battery for charging.

ASSEMBLING YOUR CHARGER

Included with your battery charger are two cord wrap posts for storage of the clamp cables.

To install, align the three tabs to correspond with the three receptacles and push until you hear a snap.

Wrap clamp cord after unplugging the power cord and store your charger in a dry location.

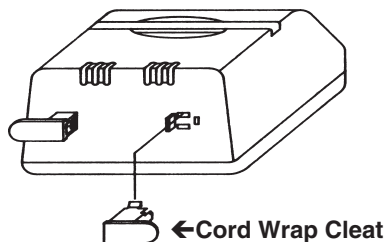

PLUGGING IT IN

WARNING: Electrical Shock Hazard. Be sure that the power cord fits properly into the outlet. If not, have a qualified technician install a proper outlet. Never alter the AC cord or plug provided.

Improper connection can result in electrical shock.

Your charger requires a 120V receptacle installed according to all local codes and ordinances.

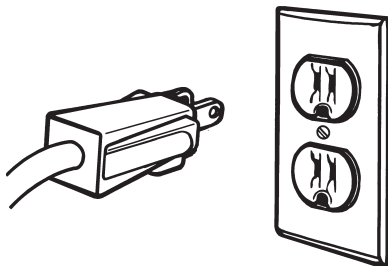

USING AN EXTENSION CORD

The use of an extension cord is not recommended. If you must use an extension cord, please make sure that you follow these guidelines:

- Make sure that the pins on charger's power cord fit firmly into the extension cord, and that the extension cord fits firmly into the receptacle.
- Check that the extension cord is properly wired and in good electrical condition.
- Make sure that the wire size is large enough for its length and for the AC ampere rating as specified in the chart below.

MINIMUM RECOMMENDED EXTENSION CORD				
Length of Cord, in Feet	25	50	100	150
AWG* Size of Cord	18	16	12	10

*AWG=American Wire Gauge

PREPARING YOUR BATTERY TO BE CHARGED

It is important that you read and follow these guidelines while you are preparing to charge your battery.

- Make sure that you have a 12 volt or 6 volt lead-acid battery. Set the selector switch to match the voltage rating of the battery to be charged.
- Clean the battery terminals. Be careful to keep corrosion from getting in or around your eyes.
- For batteries with removable cell caps, if required by the manufacturer, add distilled water to each cell until the battery acid reaches the level recommended. This will help purge excessive gases from the cells. Be careful not to overfill. If you have a sealed battery without cell caps, no action is necessary. Continue to the next step listed below.
- Take time to read all battery manufacturer's specific precautions, such as removing or not removing cell caps while charging, and recommended rates of charge.
- Wear safety glasses. See additional "Personal Safety Precautions" on page 4.
- Be sure that the area around the battery is well ventilated while it is being charged.
- If it is necessary to remove the battery from the vehicle to charge it, always remove the grounded terminal from the battery first. Turn off all vehicle accessories to avoid sparks from occurring.

NOTE: A marine battery installed in a boat must be removed and charged on shore.

USING YOUR BATTERY CHARGER

To obtain the best results from your battery charger, you must know how to use it properly. This section will tell you how to set the controls, how to charge a battery in or out of a vehicle, and how to use the engine start feature.

SETTING THE CONTROLS

All controls are located on the front of the charger. Follow these instructions to obtain the correct charge level for your battery.

SELECTOR SWITCHES:

Your charger has three switches:

- Use the left switch to match the battery voltage—either 6 or 12 volt.
- Use the center switch to select a charge type—MANUAL, AUTOMATIC DEEP CYCLE or AUTOMATIC REGULAR.

- Use the right switch to select a charge rate—2 AMP charge, 12 AMP charge, or 75 AMP ENGINE START.

Battery Voltage:

Select the voltage of your battery. The most common applications will be 12 volt.



Charge Type:

- Use the **MANUAL** setting only if you check the charging progress frequently. The charger will not stop charging when the battery reaches full charge, possibly damaging the battery if left on too long. You must monitor and unplug the charger when battery is fully charged.
- Use the **AUTOMATIC DEEP CYCLE** setting for all deep cycle battery charging. The charger will automatically stop charging when the battery reaches full charge and begin charging again when battery requires.
- Use the **AUTOMATIC REGULAR** setting for all but deep cycle batteries. The charger will automatically stop charging when the battery reaches full charge and begin charging again when battery requires.
- A severely discharged battery may not have enough charge to start the control circuit in an **AUTOMATIC** setting. In this case, charge on **MANUAL** until the battery has enough charge to accept an **AUTOMATIC** setting.

AUTOMATIC DEEP CYCLE



Charge Rate:

- Use the **2 AMP** charge rate setting for charging small batteries and warming large batteries. The lower the charge rate, the longer it will take to charge the battery.
- Use the **12 AMP** rate setting for automotive, deep cycle and other large batteries.
- Use the **75 AMP ENGINE START** setting only to assist in cranking the engine.

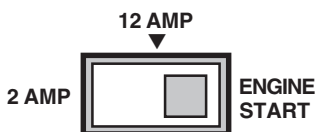

AMMETER:

The ammeter indicates the measured amount of amperes being drawn by the battery. When you first start charging a battery, the reading will be high, with the needle near 12 using the 12 amp charging rate.

- In the **MANUAL** setting, as the battery charges, the needle will fall to about 5 to 6 amps, indicating a charged battery.
- In both **AUTOMATIC** settings, the needle will fall to zero and the charger will shut off when the charger's control circuit senses a full charge. A freshly charged battery's voltage will drop shortly after charging stops, and the charger, if left connected, may resume charging. This off-and-on cycling will continue until the battery's voltage no longer drops enough to restart the charger.
- At the 2 amp charging rate you will notice very little needle movement.

When cranking the engine while using the **ENGINE START** feature, the needle will swing into the **Start** (red) area of the scale.

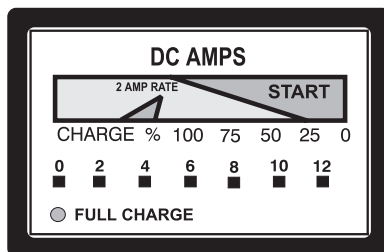

LED INDICATOR:

The green LED INDICATOR will glow when the charger senses that the battery has reached a full charge.

- When using the **MANUAL** charge rate, stop charging when the LED glows and the **AMMETER** needle is about 5 to 6 amps in the 12 Amp setting.

- For deep cycle batteries, you may wish to allow the battery another one or two hours of charging after the LED glows to obtain a maximum charge.
- When using the AUTOMATIC charge rates, the LED will cycle on and off indicating the charger is maintaining the battery's state-of-charge.

CHARGING YOUR BATTERY

Charging your battery inside the vehicle:

1. Arrange the power cord and charging leads carefully to avoid damage that could be caused by the hood, door, or moving engine parts.
2. Keep clear of fan blades, belts, pulleys, and other parts that can cause injury.
3. Check the polarity of the battery posts as indicated on the battery case: POSITIVE (POS, P, or +) and NEGATIVE (NEG. N or -).

NOTE: The positive post on top-post battery is usually larger than the negative post.

4. Identify which battery post is ground or connected to the chassis. **THE NEGATIVE POST IS NORMALLY THE ONE THAT IS GROUNDED.**

5. **To charge a negative grounded post system:** Connect the red (POSITIVE) battery charger clamp to the ungrounded POSITIVE (POS, P, +) post of the battery. Rock or twist the clamps back and forth to make a solid connection. Then connect the black (NEGATIVE) clamp to a heavy, unpainted metal part of the chassis or engine block, away from the battery. **DO NOT** connect clamp to carburetor, fuel lines or sheet metal parts. (See Figure A.)

To charge a positive grounded post system: Connect the black (NEGATIVE) battery charger clamp to the ungrounded NEGATIVE (NEG, N, -) post of the battery. Then

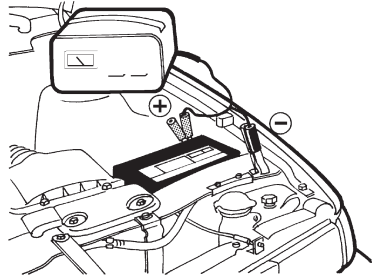

NEGATIVE GROUNDED SYSTEM
Figure A

connect the red (POSITIVE) clamp to a heavy, unpainted metal part of the chassis or engine block, away from the battery. **DO NOT** connect clamp to carburetor, fuel lines, or sheet metal parts. **IMPORTANT:** Wear safety glasses and turn face away from the battery when making connections.

6. For automatic charging, select AUTOMATIC DEEP CYCLE or AUTOMATIC REGULAR as a charge type, then select a charge rate. The charger will stop charging when the battery is fully charged.
7. For manual charging, select MANUAL as a charge type then select a charge rate. The charger **will not stop** charging when the battery is fully charged—you must monitor and unplug charger when battery is fully charged. **Avoid over charging,** monitor the AMMETER frequently when in the MANUAL mode.
8. Next plug the power cord into an AC outlet.
9. When the battery is fully charged, in the MANUAL mode, the AMMETER pointer will fall to about half the charge rate selected. For specific positions, refer to the "Ammeter" section in "Using Your Battery Charger" on page 6.
10. When the battery is fully charged, unplug the charger power cord before attempting to disconnect charger clamps.

10. When the battery is fully charged, first unplug the charger power cord. Then, standing away from the battery, remove the charger clamp from the chassis first, then from the battery post.
11. Clean and store the battery charger in a dry location.

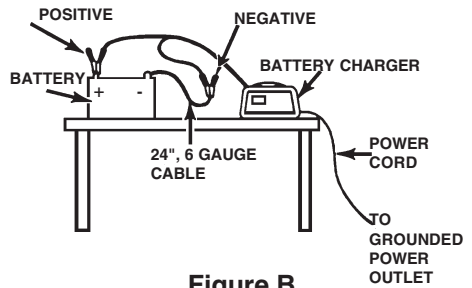

Figure B

Charging your battery outside the vehicle:

1. Remove the battery from vehicle, making sure to disconnect grounded terminal first with all accessories and lights turned off in the vehicle.
2. Check the polarity of the battery posts as indicated on the battery case: POSITIVE (POS, P, +) and NEGATIVE (NEG, N, -). **NOTE:** On top-post batteries, the positive battery terminal usually has a larger diameter post than the negative one.
3. Connect the red (POSITIVE) charger clamp to the POSITIVE post of the battery. Be sure to rock the clip back and forth to make a solid connection.
4. Attach a 6-gauge (AWG) or a 4-gauge (SAE) insulated battery cable at least 24-inches long to the NEGATIVE battery post. This cable will provide a safer connection, if arcing and sparking occur, it will be at a distance from the battery. **NOTE:** The battery cable is not provided with the charger, but may be purchased at most automotive stores.
5. Take the other end of the 6-gauge (AWG) or a 4-gauge (SAE) insulated 24-inch cable and, standing as far away from the battery as possible, connect the black (NEGATIVE) lead of the charger to the free end of the cable. Rock the clamp to make a solid connection. **IMPORTANT:** Wear safety glasses and face away from the battery while making this final connection.
6. For automatic charging, select AUTOMATIC REGULAR or AUTOMATIC DEEP CYCLE depending on the type of battery, then select a charge rate. The charger will quit when the battery is fully charged and will restart if the battery voltage drops too low.
7. For manual charging, select MANUAL as a charge type then select a charge rate. The charger **will not stop** charging when the battery is fully charged; you must monitor and unplug charger when battery is fully charged. **Avoid over charging;** monitor the AMMETER frequently when in the manual mode.
8. Plug the power cord into an AC outlet.
9. When the battery is fully charged in the MANUAL mode, the AMMETER pointer will fall to about half the charge rate selected. For specific positions, refer to the "Ammeter" section in "Using Your Battery Charger" on page 6.
10. When the battery is fully charged, unplug the charger power cord before attempting to disconnect charger clamps.
11. Standing away from the battery, remove the negative lead from the insulated cable connected to the NEGATIVE post first. Then remove the lead from the POSITIVE post.
12. Clean and store the charger in a dry location.

USING THE ENGINE START FEATURE

Your battery charger can be used to jump start your car if the battery is low. Follow these instructions on how to use the ENGINE START feature.

1. Connect the charger to the battery and vehicle as instructed in the "Charging your battery" section on page 8.
2. Set the right hand SELECTOR SWITCH on ENGINE START.
3. Crank the engine for **no more than 5 seconds**. If it does not start, **wait at least 4 minutes** before cranking again. In extreme cold or if the battery is severely discharged, charge the battery in the 12 amp position for about 5 minutes before cranking the engine.
4. After the engine starts, unplug the charger power cord from the AC outlet. Then disconnect the charger from the battery.

IMPORTANT: Do not try to start the engine without a battery in it. You could cause damage to the electrical system.

If the engine does turn over, but never starts up, there is not a problem with the starting system, there is a problem somewhere else in the vehicle. STOP cranking the engine until the other problem has been identified and corrected.

CALCULATING CHARGE TIME

Battery Rating Method

Use the following table to more accurately determine the time it will take to fully charge a battery that is initially at 50% State-of-Charge. Identify your battery type and its associated Charge Time in the table. Common battery types are:

- Small batteries, motorcycles, garden tractors, etc., are usually rated in Amp-Hours (**AH**).
- Car and truck batteries, usually rated in Reserve Capacity (**RC**), Cold Cranking Amps (**CCA**), or both.
- Marine, or deep cycle batteries, usually rated in either Amp-Hours or Reserve Capacity (**RC**).

Charge Time Table for Batteries at 50% State-of-Charge

Battery Type	Battery Rating			Charge-Time (Hours)		
	AH	RC	CCA	2 AMP	12 AMP	75 AMP
Motorcycle and tractor	6 - 12			2 - 4	NA	NA
	12 - 32			4 - 10	NA	NA
Car and Truck		40 - 60	200 - 315	8 - 11	1 - 2	NA
		60 - 85	315 - 550	11 - 16	2 - 3	NA
		85 -190	550 - 1000	16 - 35	3 - 5¼	NA
Marine and Deep Cycle	40	80		15	2½	NA
	80	140		26	4½	NA
	95	160		30	5	NA
	105	180		33	5½	NA

NA = Not Allowed. DO NOT charge at this setting

Voltmeter Method

To find the time needed to fully charge your battery, determine the battery's charge level with a voltmeter or electronic State-of-Charge Tester. Use the table below to convert Voltmeter and State-of-Charge readings at room temperature to the appropriate Charge Factor. Then use the formulas that follow the table to determine the approximate Charge Time.

Charge Factor Table

Voltmeter Reading		State-of-Charge Reading	Charge Factor
12 Volt Battery	6 Volt Battery		
12.67	6.34	100%	0
12.45	6.22	75%	0.25
12.25	6.12	50%	0.50
12.06	6.03	25%	0.75
11.86	5.93	0%	1

Charge Time Needed if Amp-Hours is Known

- Find the Charge Factor for your battery in the table on page 11.
- Multiply by the Amp-Hour rating of the battery.
- Divide by the Charger Setting (either 2 Amp or 12 Amp).
- Multiply by 1.25 to get the approximate *Hours Needed* to bring the battery to full charge.

Example: 15 Amp-Hour (AH) Battery, 50% State-of-Charge,
2 Amp Charger Setting

$[(AH \times \text{Charge Factor}) \div \text{Charger Setting}] \times 1.25 = \text{Hours Needed}$

$(15 \times 0.5 \div 2) \times 1.25 = 4.7 \text{ Hours}$

Charge Time Needed if Reserve Capacity is Known

- Find the Charge Factor for your battery in the table on page 11.
- Multiply by the Reserve Capacity rating of the battery.
- Divide by the Charger Setting (either 2 Amp or 12 Amp).
- Multiply by 0.73 to get the approximate *Hours Needed* to bring the battery to full charge.

Example: 95-Minute Reserve Capacity (RC) Battery, 25%
State-of-Charge, 12 Amp Charger Setting

$[(RC \times \text{Charge Factor}) \div \text{Charger Setting}] \times 0.73 = \text{Hours Needed}$

$[(95 \times 0.75) \div 12] \times 0.73 = 4.3 \text{ Hours}$

MAINTENANCE AND CARE

To keep your battery charger working properly for years:

1. Clean the clamps each time you are finished charging. Wipe off any battery fluid that may have come in contact with the clamps to prevent corrosion.
2. Coil the input and output cords neatly when storing the charger. This will help prevent accidental damage to the cords and charger.

TROUBLESHOOTING

Performance problems often result from little things that you can fix yourself. Please read through this chart for a possible solution if a problem occurs.

PROBLEM	POSSIBLE CAUSE	SOLUTION/REASONS
No ammeter reading.	Clamps not making good connection. 2-amp charge rate. No AC power reaching charger.	Check for poor connection at battery. Make sure clamps and posts are clean. Battery may not accept an AUTOMATIC charge if severely discharged. Use MANUAL setting, see "Using Your Battery Charger" on page 6. Ammeter needle will indicate little activity at the 2-amp charge rate. Check AC outlet and extension cords for loose fitting plug. Check for open fuse or circuit breaker supplying AC outlet.
Circuit breaker in charger cycles on and off with a clicking sound in the MANUAL setting.	Shorted battery clamps. Shorted battery. Charger leads reversed on battery.	Separate the clamps. Circuit breaker cycles when current draw is too high. Check for worn cables and replace if needed. Have a Sears technician test the battery. Correct connections.
Ammeter reads less than selected charge rate when charging.	Extension cord too long or gauge too small. Battery has weak cell or sulfated plate. Battery is partially charged.	Use shorter or heavier extension cord. Sulfated battery will eventually take a normal charge if left connected. If the battery will not take a charge, have it tested by a Sears technician. Continue charging battery.
Charger makes a loud buzz or hum.	Transformer laminations vibrate (buzz). Shorted diode (hum).	Continue charging. Buzz is not abnormal. Have charger tested by qualified technician.
Short start cycle when cranking engine.	Drawing more than 75 amps 7 seconds or less. Failure to wait for 4 minutes (240 seconds) between cranks.	Crank time varies with the amount of current drawn from the charger. If cranking draws more than 75 amps, crank time may be less than 7 seconds. Wait 4 minutes before next crank.

**If the above solutions do not eliminate the problem...call toll-free from anywhere in the U.S.A.
1-800-SEARS-64 • (1-800-732-7764) 7 AM to 4:30 PM CST Monday through Friday**

PARTS

This section shows an illustration of your battery charger. Use it to become familiar with where all the parts are located, and what they look like.

REPLACEMENT PARTS LIST MODEL 713121

Item	Description	Part Number	Item	Description	Part Number
1	Transformer	93026483	8	Handle	3599000270
2	Diode Asm Kit	2299000976	9	Switch - left DPDT	0499000060
3	PC Board Asm	2299000966	10	Switch - right DPDT	0499000068
4	Circuit Breaker	3999000088	11	Meter	5399100093
5	DC Cable Asm	3899000850	12	Cord Wrap Cleats	1199004390
6	SCR 55A	3100300017	13	Owner's Manual	0000000598
7	Power Cord	90026111M	14	Faceplate	0899001076

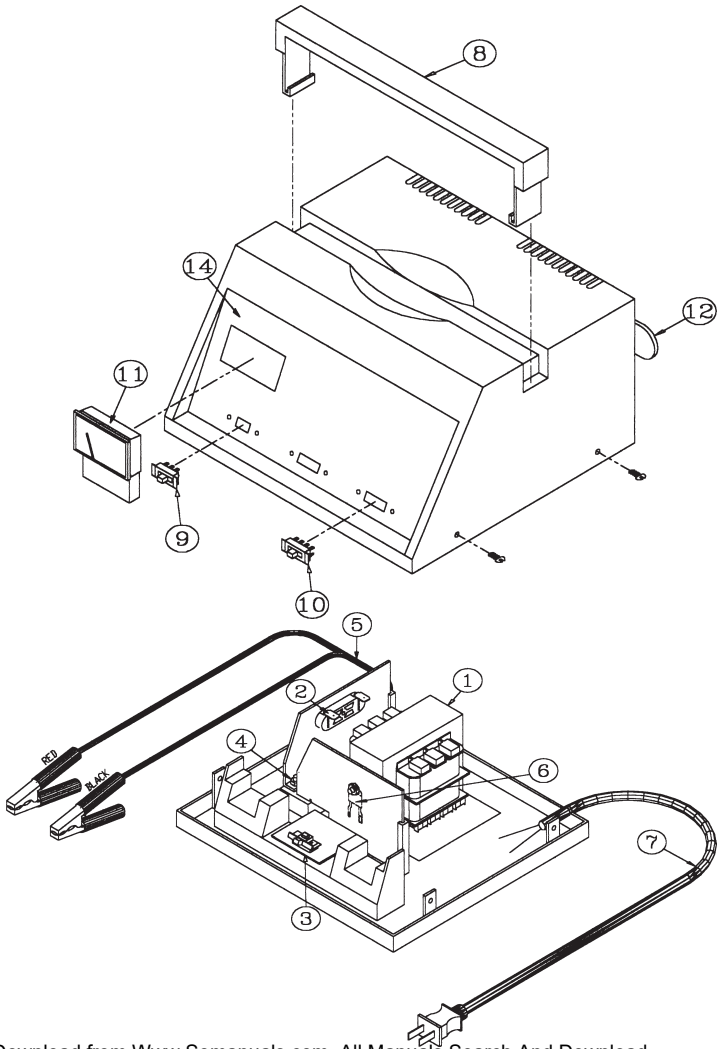

WIRING DIAGRAM

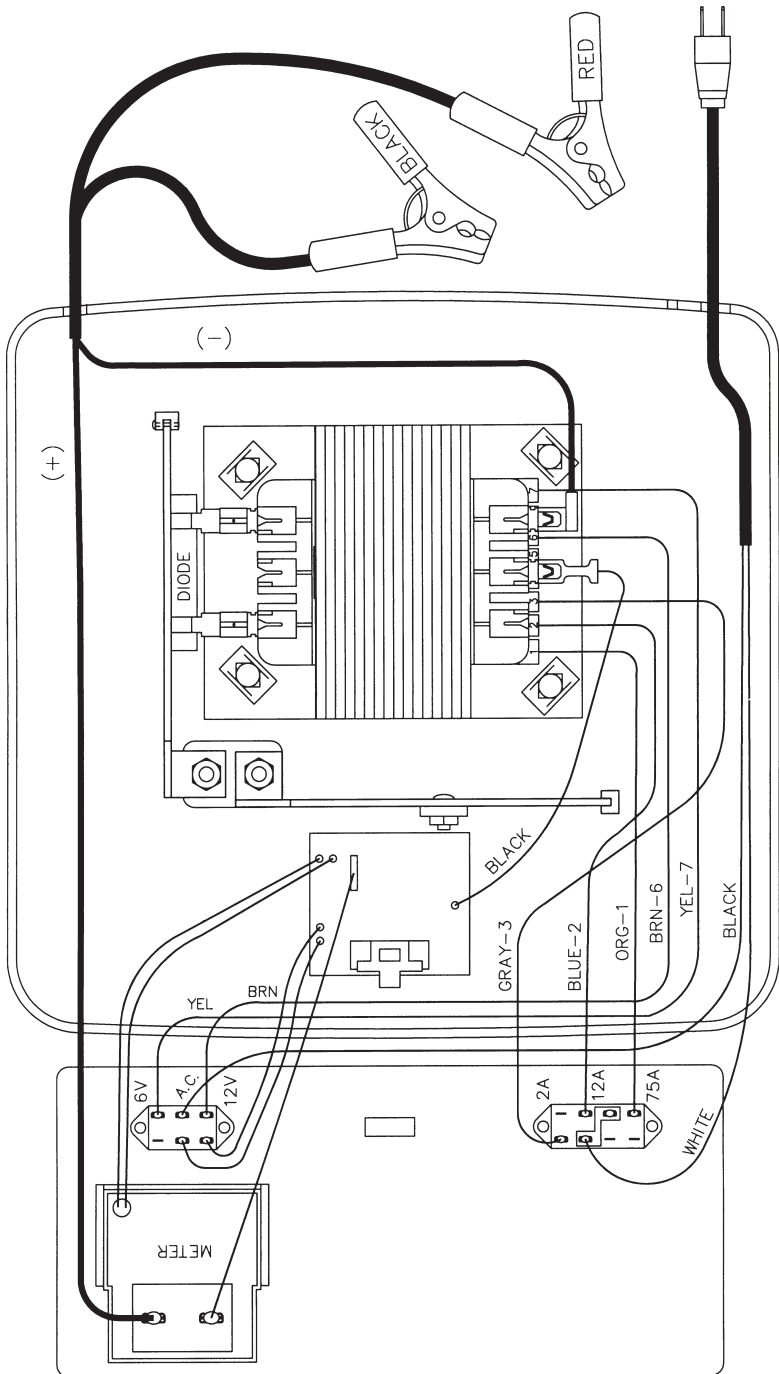

For information about troubleshooting

Call toll-free from anywhere in the U.S.A.

7 am to 4:30 pm CST Monday through Friday

1-800-732-7764

**For the repair or replacement
parts you need**

Call 7 am - 7 pm, 7 days a week

1-800-366-PART

(1-800-366-7278)

**For the location of an authorized
Sears Service Center in your area**

Call 24 hours a day, 7 days a week

1-800-488-1222

**When requesting service or
ordering parts, always provide
the following information:**

- **Product Type: 12/2/75 AMP
Fully Automatic Battery Charger**
- **Model Number: 200.713121**
- **Part Number (See Page 14)**
- **Part Description (See Page 14)**

Free Manuals Download Website

<http://myh66.com>

<http://usermanuals.us>

<http://www.somanuals.com>

<http://www.4manuals.cc>

<http://www.manual-lib.com>

<http://www.404manual.com>

<http://www.luxmanual.com>

<http://aubethermostatmanual.com>

Golf course search by state

<http://golfingnear.com>

Email search by domain

<http://emailbydomain.com>

Auto manuals search

<http://auto.somanuals.com>

TV manuals search

<http://tv.somanuals.com>