

# **SEARS**

## **OWNER'S MANUAL**

**MODEL NOS.  
625.348234  
Clarifier**

**625.348241  
Neutralizer**

**625.348251  
Taste & Odor**

Caution:  
Read and Follow  
All Safety Rules and  
Operating Instructions  
Before First Use of  
This Product.

If you have questions when  
installing, operating or main-  
taining your filter, and when  
setting the timer, call this  
toll-free number...

**1-800-426-9345**

**SAVE THIS MANUAL**

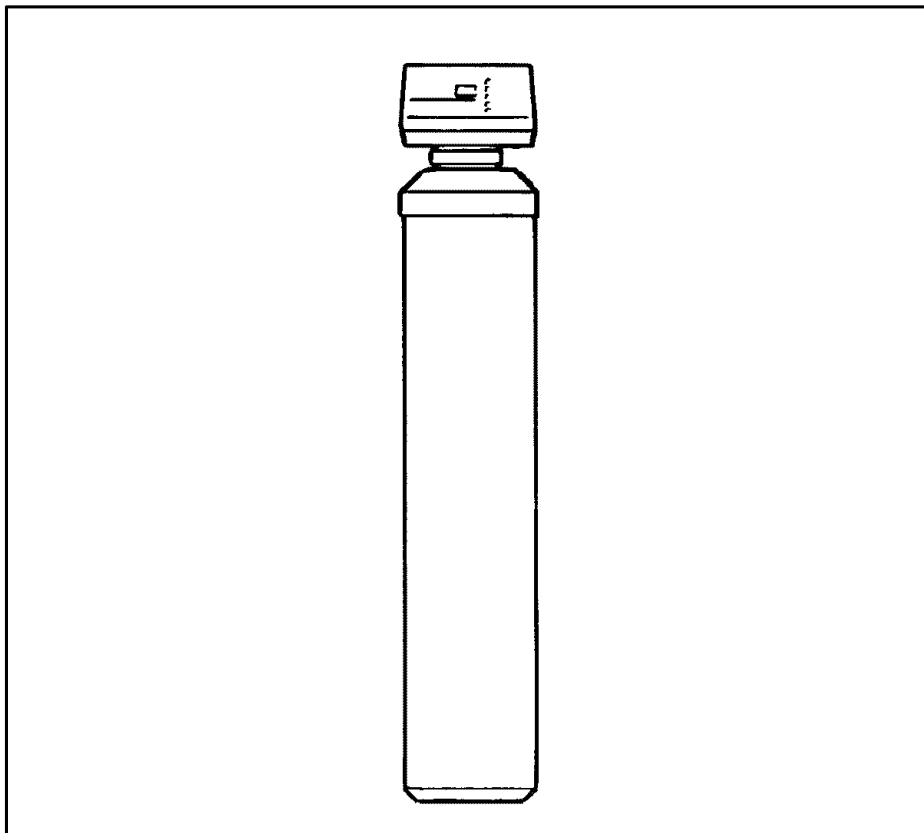

# **Kenmore**

## **Water Filters**

- ◆ Warranty
- ◆ Start Up / Setting Timer
- ◆ How It Works
- ◆ Care Of
- ◆ Specifications
- ◆ Repair Parts

---

**Sears, Roebuck and Co., Hoffman Estates, IL 60179 USA**

---

# WARRANTY

## SEARS RESIDENTIAL WATER FILTER FULL ONE YEAR WARRANTY ON FILTER

For one year from the date of purchase, when this water filter is installed and maintained in accordance with our instructions, Sears will repair, free of charge, defects in materials or workmanship in this water filter.

## FULL FIVE YEAR WARRANTY AGAINST LEAKS

For five years from the date of purchase, Sears will furnish and install a new current model water filter tank, free of charge, if the tank develops a leak.

TO OBTAIN WARRANTY SERVICE, SIMPLY CONTACT THE NEAREST SEARS SERVICE CENTER THROUGHOUT THE UNITED STATES. "This warranty applies only while this product is in use in the United States."

This warranty gives you specific legal rights, and you may have other rights which vary from state to state.

Sears, Roebuck and Co., D/817 WA, Hoffman Estates, IL 60179

If you want your water filter professionally installed, talk to your Sears Salesman. He will arrange for a prompt, quality installation by Sears Authorized installers.

### SEARS INSTALLATION POLICY

All installation labor arranged by Sears shall be performed in a neat, workmanlike manner in accordance with generally accepted trade practices. Further, all installations shall comply with all local laws, codes, regulations and ordinances. Customer shall also be protected, during installation, by insurance relating to Property Damage, Workman's Compensation and Public Liability.

### SEARS INSTALLATION WARRANTY

In addition to any warranty extended to you on the Sears merchandise involved, which warranty becomes effective the date the merchandise is installed, should the workmanship of any Sears arranged installation prove faulty within one year, Sears will, upon notice from you, cause such faults to be corrected at no additional cost to you.

### FACTS AND FIGURES TO KEEP

Fill in the blanks below and keep this book in a safe place so you always have these facts.

Water Filter Model No. † \_\_\_\_\_

Serial Number \_\_\_\_\_

Date Installed \_\_\_\_\_

Iron Content \_\_\_\_\_ Parts Per Million

\*pH \_\_\_\_\_ Taste And/Or Odor \_\_\_\_\_

Water Pressure \_\_\_\_\_ Pounds /Square Inch

Water Flow Rate \_\_\_\_\_ Gallons Per Minute

†The model number is on the rating decal, located on the back of the filter top cover.

# TABLE OF CONTENTS

---

---

	<b>PAGE NO.</b>	
<b>SECTION 1</b>	<b>FILTER START UP</b>	
A. SAFETY GUIDES		4
B. CHECK LIST OF STEP-BY-STEP GUIDES TO INSTALL		5
C. SANITIZING THE WATER FILTER		6
D. PROGRAM THE TIMER		7-8
<b>SECTION 2</b>	<b>HOW YOUR WATER FILTER WORKS</b>	
A. FACE PLATE TIMER FEATURES		9-10
B. FILTER APPLICATIONS		11
C. FILTERED WATER SERVICE, AND BACKWASH		12
<b>SECTION 3</b>	<b>CARE OF YOUR FILTER</b>	
A. KEEP THE FILTER FROM FREEZING		13
B. ADDING MINERAL . . . NEUTRALIZER FILTER		14-15
C. REPLACING MINERAL . . . TASTE & ODOR FILTER		16
D. HELPFUL HINTS CHECKLIST		17
<b>SECTION 4</b>	<b>OTHER THINGS TO KNOW</b>	
A. DIMENSIONS/SPECIFICATIONS		18
<b>SECTION 5</b>	<b>SERVICER'S TECH INFORMATION</b>	
A. ELECTRICAL CONNECTIONS		19
B. BACKWASH CYCLE TIMES		20
C. DIAGNOSTICS		21
D. "QUICK-CHECK" TROUBLESHOOTING		22
E. ROTARY VALVE SERVICE		23
F. WATER FLOW THROUGH THE FILTER VALVE		24
<b>SECTION 6</b>	<b>REPAIR PARTS</b>	25-27

# SECTION 1

---

---

1A.

## SAFETY GUIDES

---

▲ Read all steps, guides and rules carefully before installing and using your new water filter. Follow all steps exactly to correctly install. Failure to follow them could cause personal injury or property damage. Reading this book will also help you to get all of the benefits from your water filter.

▲ Your water filter will improve your water as described on page 11. It will not soften water or remove iron. It will not purify polluted water or make it safe to drink. Also see the specifications on page 18.

▲ Protect the filter and piping from freezing. Damage from freezing voids the filter warranty. See page 13.

**PLEASE READ AND COMPLY WITH THE FOLLOWING GUIDES TO PREVENT DAMAGE TO THE FILTER OR OTHER PROPERTY, PERSONAL INJURY, OR POSSIBLE FATAL SHOCK.**

▲ THIS FILTER WORKS ON 24 VOLTS ONLY. BE SURE TO USE THE TRANSFORMER INCLUDED, AND PLUG IT INTO A 120V OUTLET.

▲ Unplug the transformer right away if the power cable should become damaged or frayed. Make repairs before plugging back into the power outlet.

▲ Always unplug the filter from electrical power before removing outer valve covers.

## 1B. CHECK LIST OF ALL STEP BY STEP GUIDES TO INSTALL

Refer to the Installation Manual, part no. 7146611, for step-by-step guides.

To be sure you have done all the steps to install the filter, read the following list. Page numbers referred to are in the Installation Manual.

- ✓ Is the house water flow going INTO the filter valve INLET? Trace piping to be sure . . . page 9.
- ✓ Is the plumbing bypass valve (or 3 valves) set for SERVICE? . . . See FIG. 8, page 18 of this manual.
- ✓ Is the valve drain hose connected the right way, and without sharp bends or kinks that could stop or reduce water flow? . . . page 14.
- ✓ Is the filter power cable connected to the transformer . . . and is the transformer plugged into an inside, 120V-60Hz electrical outlet? . . . page 17.
- ✓ Be sure to restart the water heater . . . page 18.

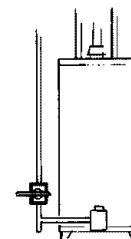
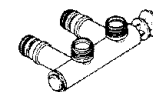
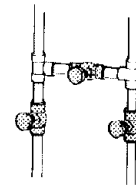
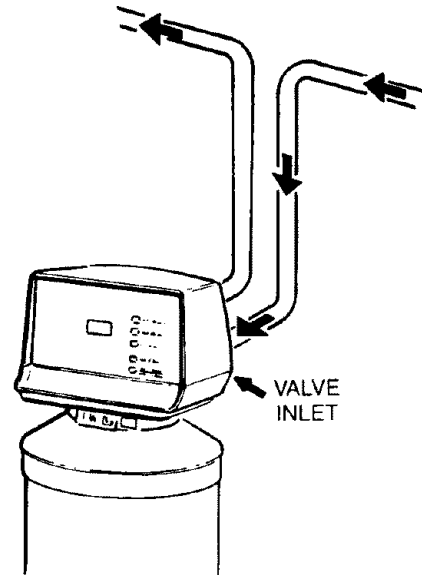

## 1C. SANITIZING THE WATER FILTER

Care is taken at the factory to keep your water filter clean and sanitary. Materials used to make the filter will not infect or contaminate your water supply, and will not cause bacteria to form or grow. However, during shipping, storage, installing and operating, bacteria could get into the filter. For this reason, sanitizing as follows is suggested<sup>①</sup> when installing.

1. Press and HOLD button **5** on the face plate until RCHG begins to flash in the display (12:00 AM began to flash when the transformer was plugged in). Water will begin to run from the drain hose as the filter valve moves into backwash position.

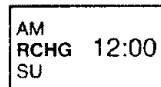

After 5 to 10 minutes, press **5** again to move the filter valve into fast rinse position (water stops, then begins to run from drain hose again).

2. In about 2 minutes, PUT THE BYPASS VALVE(S) IN BYPASS POSITION (SEE FIG. 8, PAGE 18). Then, press button **5** once again to return the filter valve to service position. Doing this releases water pressure in the filter.
3. Carefully remove the large plastic clip at the filter valve inlet (see Key No. 41, page 26). Pull the valve adaptor from the filter inlet.

### NOTE:

If bypass valve, Sears Stock No. 42-3437 is installed, or if plumbing is too rigid to move, also disconnect the outlet side and move the filter away from plumbing.

4. Put 1 teaspoon (0.1 ounce) of calcium hypochlorite into the valve inlet as far as possible.

### NOTE:

You can buy calcium hypochlorite in tablet or granular form using trade names such as Perchloron and HTH.

5. Be sure the valve inlet is clean, for a good sealing surface for the valve adaptor o-ring. Then, reconnect plumbing to the filter. AFTER INSTALLING THE LARGE PLASTIC CLIP, PULL OUTWARD ON THE VALVE ADAPTOR TO BE SURE IT'S PROPERLY HELD IN PLACE.
6. SLOWLY, reposition the bypass valve(s) to service . . . FIG. 8, page 18. Open the nearest filtered water faucet until you can smell chlorine, then close.
7. Again, put the bypass valve(s) in bypass position. Allow the filter to stand idle for about 45 minutes, while the chlorine sanitizes.
8. After the 45 minutes, return the bypass valve(s) to service. Then, press face plate button **5** to start a backwash. While the filter completes this automatic backwash and fast rinse . . . takes about 35 minutes . . . turn to page 7 and make the timer settings.
9. When the backwash/fast rinse is over (water flow to drain stops), open filtered water faucets until chlorine odor is gone, then close the faucets.

<sup>①</sup> Recommended by the Water Quality Association. On some water supplies, the water filter may need periodic disinfecting.

## 1D. PROGRAM THE TIMER

FIG. 1

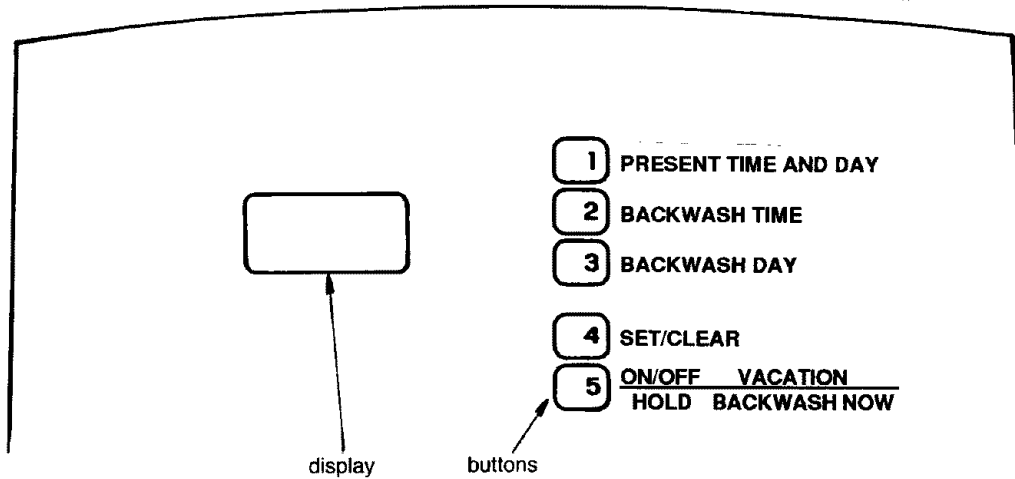

When the transformer is plugged into the electrical outlet, 12:00 AM, SUnDay began to flash in the time display. Set the **time of day**, present **day of week**, and **days/time of backwash**, as follows.

### 1. SET TIME OF DAY

- Press the PRESENT TIME AND DAY button **1** once. The hour display continues to flash.
- Press the SET/CLEAR button **4** until the present hour of the day shows in the display. Be sure AM for morning hours, or PM for afternoon and evening hours shows.

NOTE:

Press SET/CLEAR and quickly release to move the hour display ahead 1 at a time to the correct hour. Or, hold the SET/CLEAR button to move the display ahead 2 hours each second, to the correct hour.

- Press button **1** once to steady the hour display, and minutes begin to flash. Repeat step 1b to set the correct minutes.
- Press button **1** again to steady the minute display (day will begin flashing). Figure 2 shows the timer set at 3:30 PM.

### 2. SET PRESENT DAY OF WEEK

- Press the SET/CLEAR button **4** to set the present day of the week in the display.

NOTE:

Press SET/CLEAR and quickly release to move the day display 1 at a time. Or, hold the SET/CLEAR button to move the day display ahead 2 days each second.

- Press the PRESENT TIME AND DAY button **1** again to steady the entire display. Figure 2 shows the timer set at TUESday.

FIG. 2

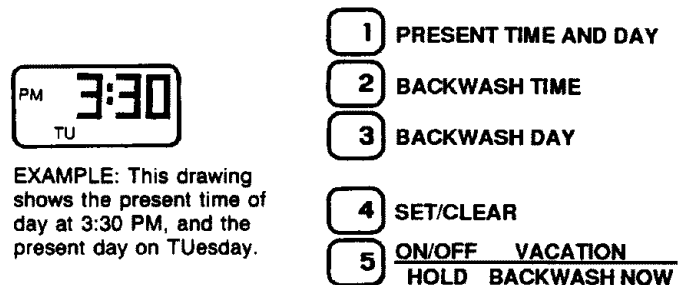

EXAMPLE: This drawing shows the present time of day at 3:30 PM, and the present day on TUESday.

(continued)

## 1D. PROGRAM THE TIMER

### 3. SET DAYS OF BACKWASH

**IF YOU HAVE A WATER SOFTENER OR OTHER AUTOMATIC FILTER . . .** A good water flow rate is needed for proper recharging and/or backwashing of all water conditioners. To help assure good water flow, you should offset the timers on each conditioner so recharges do not occur on the same days, or at the same time.

- . . . Most Sears water softeners are factory set (many are adjustable ) to recharge from 2:00 to 4:00 am.
- . . . Set the filter to backwash on different days, or . . .
- . . . Set the filter to backwash either before or after other equipment, or . . .
- . . . Offset the timers on all equipment to begin recharges on backwashes at 12:00, 2:00 and 4:00 AM, or 1:00, 3:00 and 5:00 AM, etc.

- a. Read the BACKWASHING GUIDE for your type of filter.
- b. Press the BACKWASH DAY BUTTON [3] AND Sunday begins to flash.

If you want backwashes on Sunday (from guide), press the SET/CLEAR button [4] to display **ON**.

If you do not want Sunday backwashes, press button [4] to display **OFF**.

NOTE:

The timer is factory programmed to backwash on Monday, Wednesday and Saturday.

- c. Press button [3] again to display a flashing **MONday**. As you did in step b above, press button [4] to display **ON** for backwash on Monday, or **OFF** for no backwash on Monday.
- d. Press button [3] for every day of the week, each time using button [4] to display **ON** (for backwash) or **OFF** (no backwash) as needed.
- e. After setting **ON** or **OFF** for Saturday, press button [1] to return the present time in the display.

### 2. SET TIME OF BACKWASH

The filter is factory set to begin backwashes at 12:00 AM, ending at about 12:40 AM. If a different backwash time is desired, or needed (see note under step 3), do the following.

- a. Press the BACKWASH TIME button [2] once, to display a flashing 12:00 AM, the factory setting.
- b. Press the SET/CLEAR button [4] until the desired backwash starting time shows in the display.

NOTE: Press button [4] and quickly release to move the display ahead 1 hour at a time. Or, hold button [4] to move the display ahead 2 hours each second.

- c. Press button [1] to return the present time.

## BACKWASHING GUIDE

### CLARIFIER FILTER

The clarifier needs backwashing when you can see sediments in the water, or when faucet water pressure drops. When that happens depends on how much sediment is in the water supply, and how much water your household uses. You can use the following table as a guide.

WATER CONDITION	BACKWASHES PER WEEK
normal sediments, dirt, etc.	1
normal sediments, dirt, etc., WITH iron	2-3
high sediments, dirt, etc.	2
high sediments, dirt, etc., WITH iron	3-4

NOTE:

The timer is factory programmed for Monday, Wednesday and Saturday recharge.

### NEUTRALIZER/TASTE & ODOR FILTERS

The filter mineral bed will trap and hold some dirt, sediments, iron, etc., that may be in your water supply. To flush them from the mineral bed, 1 backwash each week is recommended. Backwash also stirs the mineral bed which helps to keep water flowing through the entire bed instead of forming a channel.



## 2A. FACE PLATE TIMER FEATURES

### BACKWASH NOW

For times you expect to use more water than usual, use the BACKWASH NOW feature. Press the BACKWASH NOW-HOLD button [5] and hold in for 3 seconds. RCHG begins to flash in the display and a backwash starts right away. You will have filtered water when the backwash is over in about 35 minutes.

FIG. 3

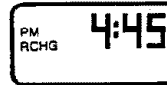

- 1 PRESENT TIME AND DAY
- 2 BACKWASH TIME
- 3 BACKWASH DAY
- 4 SET/CLEAR
- 5 ON/OFF VACATION  
HOLD BACKWASH NOW

**VACATION** — The day you leave on vacation, or other long absence, press (DO NOT HOLD IN) the ON/OFF-VACATION button [5]. VAC begins to flash in the display (FIG. 4). The timer will keep time, but the filter will not backwash and waste water.

FIG. 4



- 1 PRESENT TIME AND DAY
- 2 BACKWASH TIME
- 3 BACKWASH DAY
- 4 SET/CLEAR
- 5 ON/OFF VACATION  
HOLD BACKWASH NOW

### NOTE:

To shut off the water supply to the filter, use the plumbing bypass valve(s) . . . FIG. 8, page 18.

**When you return,** press the VACATION button again to return the filter to service, and the correct time of day in the display. **Remember to do this or the filter will not backwash to keep the mineral bed clean.**

### ERROR CODE

An error code could appear in the faceplate display if a problem occurs in the filter electronics. If you see an error code

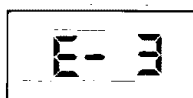

instead of the present time of day, please call your local Sears Service Department for service.

Continued

### 2A. FACE PLATE TIMER FEATURES

**TIMER "POWER-OUTAGE MEMORY"** — If electrical power to the timer goes off, the "memory" built into timer circuitry keeps **all** settings for 5 hours (minimum) or more. The display is blank and the filter will not backwash. When electrical power comes on, 1 of 2 things will happen.

1. The present time of day will show, meaning the timer memory has kept all settings.

**NOTE:**

If the filter was in a backwash when power was lost, it will now finish the cycle.

2. The display will show a time, but it will be flashing. The timer memory did **not** keep the time settings and they must be reset, pages 7 and 8.

**The flashing display is to remind you to reset the timer.**

**NOTE:**

When power comes on, the flashing display returns to a time of 12:00 AM Sunday, then begins to keep time again. If you do not reset all time settings, the filter will backwash 3 days each week. However, backwash will most likely be on the wrong days and at the wrong time.

If the filter was in a backwash when power went off, the valve will return to service position without finishing the cycle. To start another backwash. . . . . use BACKWASH NOW, page 9.

## 2B. FILTER APPLICATIONS

### IMPORTANT:

Sears water filters are sometimes installed alone in the water system, but most often other water treating equipment is needed. Always be sure to have your water tested by a qualified testing laboratory. If you need help, ask at your Sears store, or call Sears Water Line, 1-800-426-9345.

### CLARIFYING FILTER

A Sears Clarifying Filter takes sediments such as dirt, sand, silt, clay and fine organic matter out of water. You can see sediments in water by filling a clear drinking glass. When held up to light, you can see the particles floating in the water, or settled to the bottom of the glass. The filter is filled with "filter aggregate" mineral that traps and holds the sediments as the water flows through it.

The Clarifier is sometimes installed alone, but is often followed by a water softener. Besides softening the water, the water softener catches sediments that may get through the filter.

### NOTE:

If you will install the clarifying filter along with a Sears Solution Dispensing System, read the dispensing system owners manual for treating a private well before installing.

### NEUTRALIZER FILTER

All water, when chemically analyzed, is either acid, neutral or base (alkaline). To measure this, the water is given a pH value between 0 and 14. Water is acid if the pH is from 0 to 6.9. At 7, the water is neutral, and above that the water is alkaline.

Your Sears neutralizing filter treats acid water when the pH is from 6.0 to 6.7. A Sears Cartridge Filter with a Phosphate Crystal Cartridge is often used to treat water with a pH of 6.8 to 6.9. Acid water shortens the life of iron pipe, corrodes copper and brass pipe, and makes green stains on plumbing fixtures. In time, it will even etch porcelain enamel. The filter has a special mineral (Neutralite) that raises the pH of the water to help reduce these acid water problems.

### TASTE & ODOR FILTER

A Sears taste & odor filter removes most tastes, odors and certain organic colors from water. Bad tastes and odors come from many different causes. Often, one causes the other. The activated carbon bed, in the taste & odor filter, has a great ability for taking tastes and odors out of water.

### NOTE:

If your water has hydrogen sulfide (rotten egg taste or odor), be sure to get a qualified testing laboratories recommendation for proper treatment.

## 2C. FILTERED WATER SERVICE, AND BACKWASH

### SERVICE

#### CLARIFIER FILTER

During service (FIG. 5) water goes into the filter and DOWN through the bed of mineral. The mineral takes the dirt, sand, silt, clay and other sediments out of the water and holds it in the bed. Clear, clean water goes out of the filter and into the house pipes.

#### NEUTRALIZER FILTER

As low pH (acid) water flows DOWN through the filter, neutralite mineral is slowly dissolved to raise the pH. The neutralized or non-acid water then flows into the house water pipes. Because the neutralite does dissolve, you have to add new mineral at least once each year, and sometimes more often (see page 14).

#### TASTE AND ODOR FILTER

The taste and odor filter is filled with activated carbon. As water flows into and DOWN through the filter (FIG. 5), the tastes and/or odors are adsorbed and held by the carbon. Water without bad tastes or odors goes into the house pipes.

When the activated carbon no longer takes the tastes and/or odors out of the water, you must replace it (see page 16). The carbon usually lasts for up to 1 year, and sometimes longer. It depends on how much water you use, and how much taste and/or odor is in the water.

### BACKWASH

Backwash is a reverse or UPWARD fast flow of water through the filter. The fast, upward flow flushes dirt, sediment, iron, etc., from the mineral bed and to the drain. The bed is lifted and expanded for good cleaning. The bed is also mixed to remove any channels water flow may have formed through the mineral.

Following backwash, water again changes direction to flow downward through the bed at a fast rate. The mineral bed is repacked and prepared for return to service.

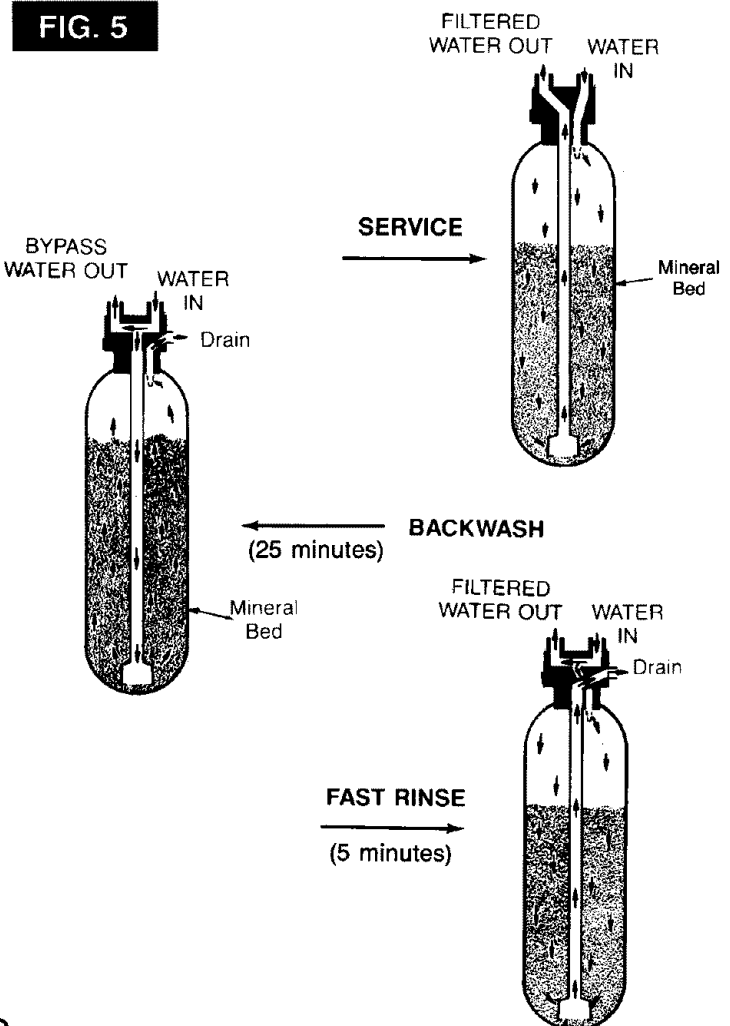

## 3A. KEEP THE FILTER FROM FREEZING

If the filter is installed where it could freeze (summer cabin, lake home, etc.), you must drain all water from it to stop possible freeze damage. To drain the filter —

1. Close the shut-off valve on the house main water pipe, near the water meter or pressure tank.
2. Open a faucet in the filtered water pipes to vent pressure in the filter.
3. Looking at FIG. 8 on page 18, move the stem in a single bypass valve to bypass. Close the inlet and outlet valve in a 3-valve bypass system, and open the bypass valve.
4. Unplug the transformer at the wall outlet.
5. Pull the holding clip to remove the drain fitting, with drain hose attached, from the valve. **DO NOT LOSE THE BLACK RUBBER FLOW PLUG AND RETAINER.**
6. Remove the plastic clips (see key #41, page 26) and pull the adaptors or bypass valve from the inlet and outlet.
7. Move the filter close to the floor drain. **SLOWLY** and **CAREFULLY** (the filter is heavy) tip the filter over so the valve inlet and outlet are over the drain. Allow water to drain from tank. **DO NOT REST THE FILTER ON THE INLET AND OUTLET FITTINGS OR THEY WILL BREAK.**
8. Tip the bottom of the filter up a few inches and hold until all water has drained. Leave the filter laying like this until you are ready to use it. Plug the inlet and outlet with rags to keep dirt, bugs, etc. out.

## 3B. ADDING MINERAL . . . NEUTRALIZER FILTER

The neutralite mineral is slowly dissolved to neutralize acid in the water (see page 12). If the filter was never serviced, all the mineral would dissolve. How fast it dissolves depends on how much water is used, the pH of the water, and other supply conditions.

Add new mineral (see below) about 6 months after installation. Before you add new mineral, use a yard stick or tape rule to measure the distance down to the top of the mineral bed (figure 6). If the measurement is 32" or less, over half of the mineral bed remains. You could wait 9 or 10 months before adding mineral the next time. However, if distance to the bed is 38" or more, less than 1/4 of the mineral remains and adding more mineral every 5 months may be better.

Use this measurement procedure each time, to adjust your mineral adding intervals to changing water use patterns and other conditions.

### STEPS TO ADD MINERAL

1. Press the face plate **BACKWASH NOW** button **5** and **hold** for 3 seconds, until RCHG begins to flash in the display.
2. When water begins to flow from the valve drain hose, place the bypass valve(s) in **BYPASS** position . . . see FIG. 8, page 18.

### CAUTION:

BE SURE TO DO STEPS 1 AND 2 AS INSTRUCTED, TO RELIEVE WATER PRESSURE IN THE TANK.

3. Unplug the transformer at the wall outlet.
4. Carefully, pull the 2 clips (key #41, page 26) at the inlet and outlet fittings. Slide the adaptors, or bypass valve, from the filter valve.
5. Referring to FIG. 7, remove the clamp retainers (2) and clamp sections (2) that hold the valve to the tank. Lift upward to remove the valve.

**FIG. 6** MEASURING FREEBOARD, ADDING MINERAL

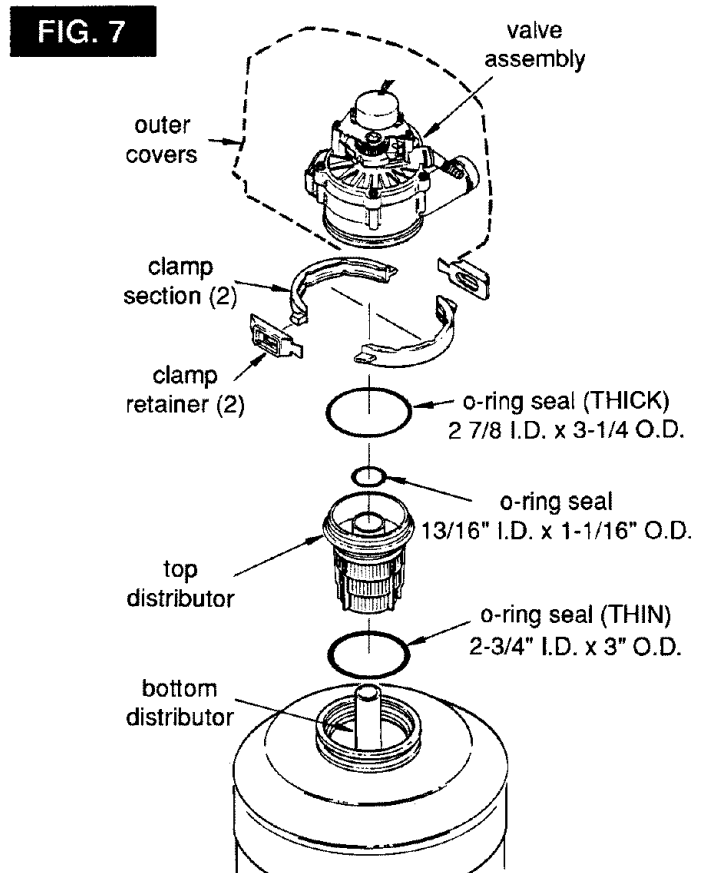
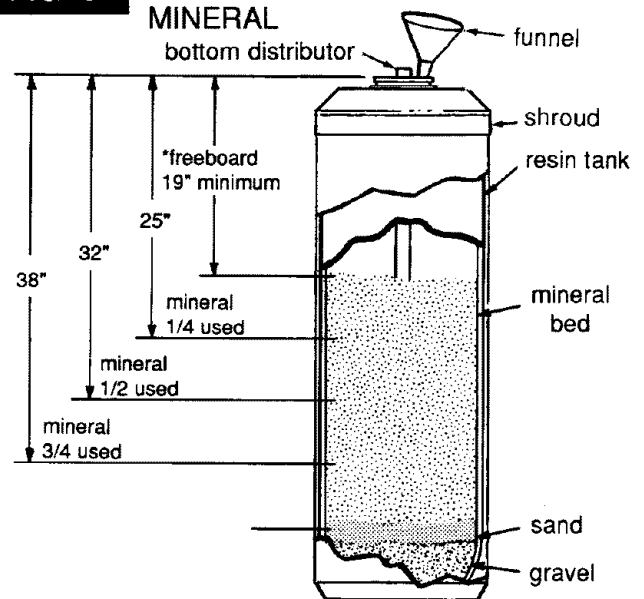

## **3B. ADDING MINERAL . . . NEUTRALIZER FILTER**

6. Remove the o-rings (3) and top distributor from the top of the tank.
7. To make room for the new mineral, use a hose to siphon water from the tank.
8. Using a large neck funnel, add new mineral into the tank.

### **IMPORTANT:**

**DO NOT ADD MINERAL INTO THE BOTTOM DISTRIBUTOR. Temporarily plug the distributor tube to prevent accidental mineral spills into it.**

**DO NOT OVERFILL the tank. Freeboard area (see FIG. 6) is needed for proper backwashing. If you have mineral remaining, you can use it the next time you refill the tank.**

9. Use water to flush the tank top opening. Then, replace the top distributor and 3 o-rings. Be sure to locate o-ring seals correctly . . . FIG. 7.
10. Carefully, install the valve assembly and retaining clamps. **DOUBLE-CHECK TO BE SURE CLAMPS AND RETAINERS ARE SECURELY FASTENED IN PLACE.**
11. Referring to your installation manual, reconnect the filter to the plumbing. **BE SURE THE PLUMBING IS HELD FIRMLY IN PLACE, IN THE VALVE INLET AND OUTLET.**
12. Place the valve drain hose at the drain point and secure in place.
13. Return the plumbing bypass valve(s) to SERVICE position.
14. Plug the transformer into the wall outlet. The filter will complete the backwash cycle, started in step 1, and will automatically return to service.

## 3C. REPLACING MINERAL . . . TASTE & ODOR FILTER

Average life of the activated carbon mineral bed is about 1 year (see page 12). It's time to replace the bed when the tastes and/or odors begin to return in the water supply. Do the following.

### STEPS TO REPLACE MINERAL

1. Press the face plate BACKWASH NOW button **5** and **hold** for 3 seconds, until RCHG begins to flash in the display.
2. When water begins to flow from the valve drain hose, place the bypass valve(s) in **BYPASS** position . . . see FIG. 8, page 18.

### CAUTION:

BE SURE TO DO STEPS 1 AND 2 AS INSTRUCTED, TO RELIEVE WATER PRESSURE IN THE TANK.

3. Unplug the transformer at the wall outlet.
4. Carefully, pull the 2 clips (key #41, page 26) at the inlet and outlet fittings. Slide the adaptors, or bypass valve, from the filter valve.
5. Referring to FIG. 7, page 14, remove the clamp retainers (2) and clamp sections (2) that hold the valve to the tank. Lift upward to remove the valve.
6. Remove the o-rings (3) and top distributor from the top of the tank.
7. Next to a floor drain, carefully tip the tank over, catching the used carbon in a burlap sack or other suitable container. Remove the bottom distributor assembly, and flush the inside of the tank with water.

### CAUTION:

HANDLE THE TANK CAREFULLY. FULL OF WATER AND CARBON, IT IS VERY HEAVY. DO NOT ATTEMPT TO LIFT IT BY YOURSELF. DO NOT DROP AND BREAK THE TANK.

8. Stand the tank upright and replace the bottom distributor assembly. Temporarily, plug the top end of the distributor (use rag, etc.) to prevent accidental mineral spills into it.
9. Using a large neck funnel (FIG. 6), first add 17 lbs. of gravel, followed by 10 lbs. of filter sand. Next, add the 1 cu. ft. of activated carbon. Use water sparingly to assist carbon flow through the funnel.

### NOTE:

Be sure the bottom distributor is centered in the tank while adding mineral.

10. Use water to flush the tank top opening. Then, replace the top distributor and 3 o-rings. Be sure to locate o-ring seals correctly . . . FIG. 7, page 14.
11. Carefully, install the valve assembly and retaining clamps. **DOUBLE-CHECK TO BE SURE CLAMPS AND RETAINERS ARE SECURELY FASTENED IN PLACE.**
12. Referring to your installation manual, reconnect the filter to the plumbing. **BE SURE THE PLUMBING IS HELD FIRMLY IN PLACE, IN THE VALVE INLET AND OUTLET.**
13. Place the valve drain hose at the drain point and secure in place.
14. Return the plumbing bypass valve(s) to SERVICE position.
15. Plug the transformer into the wall outlet. The filter will complete the backwash cycle, started in step 1, and will automatically return to service.

### NOTE:

All new carbon mineral contains some smaller than normal particles called "fines." Backwashing the filter removes the fines. If, after the backwash in step 15 is over, fines are still in the filtered water, repeat step 1 for added backwashing.



## 3D. BEFORE YOU CALL FOR SERVICE . . . HELPFUL HINTS CHECKLIST

PROBLEM	CAUSE	CORRECTION
FILTER WILL NOT BACKWASH	Manual bypass valve(s) in bypass position	See FIG. 8, page 18. Move stem in a single bypass valve to SERVICE. In a 3-valve bypass, open the inlet and outlet valves, close the bypass valve.
	Transformer unplugged at wall outlet, power cable disconnected, fuse blown/circuit breaker popped, or circuit switched off	Check for loss of power and correct. Reset the times and use the BACKWASH NOW feature . . . see page 9. Also see "Electric Power Outlet For Your Filter, page 17 in the installation manual.
	Timer in the vacation (VAC) position	Press the VACATION button <b>5</b> once to return the filter to service . . . see page 9.
	Timer not programmed for backwash	See page 8 to program a weekly schedule.
	An error code shows in the face plate display	See page 9.
	Backwash flow washer plugged	See key No. 38, page 26, and remove drain hose adaptor to clean.
	Drain hose plugged, kinked or bent	Straighten hose, or remove and clean.
LOW WATER PRESSURE AT HOUSE FAUCETS	Well pump pressure switch set too low	Adjust to a minimum of 20 psi.
	Backwash needed more often to keep filter mineral clean	See page 8 to program more backwashes.
FILTERED WATER CONTAINS SEDIMENTS, IRON, DIRT, SAND, ETC.	See all conditions under Filter Will Not Backwash, above.	
NEUTRALIZER FILTER ONLY: FILTER WATER IS ACID OR PARTLY ACID  NOTE:  Trace plumbing to be sure faucet(s) is on filtered water service.	Manual bypass valve(s) in bypass position	See above.
	Filter low on neutralite mineral	Add new mineral . . . see page 14.
TASTE & ODOR FILTER ONLY: FILTERED WATER HAS BAD TASTE AND/OR ODOR  NOTE:  Trace plumbing to be sure faucet(s) is on filtered water service.	Manual bypass valve(s) in bypass position	See above.
	Activated carbon mineral bed is exhausted	Replace mineral . . . see page 16.

## 4A. DIMENSIONS/SPECIFICATIONS

**FIG. 8** BYPASS VALVES

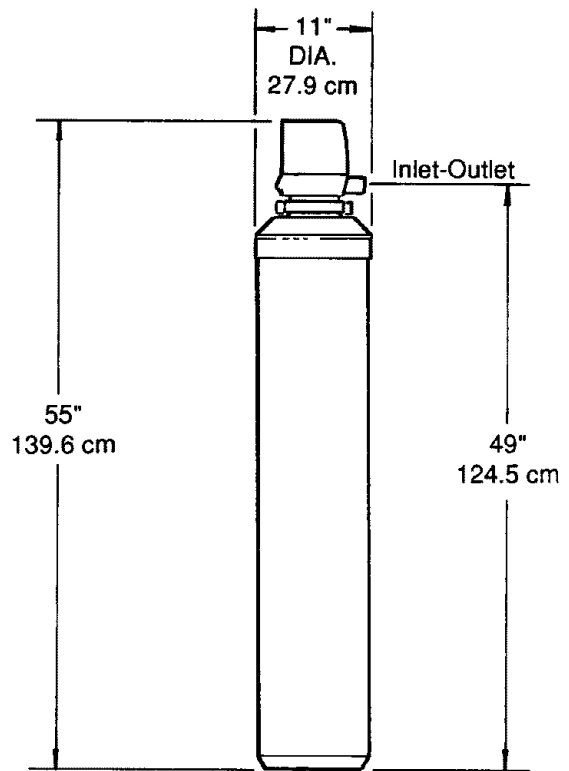
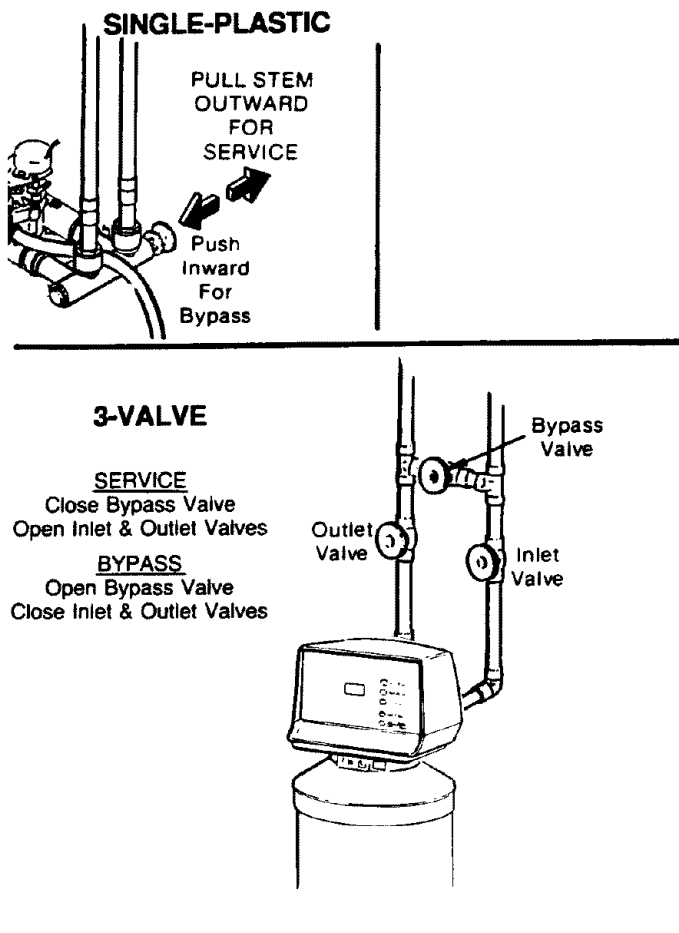

Mineral Tank Nominal Size: 10" dia. x 47" high

	CLARIFIER 625.348234	NEUTRALIZER 625.348241	TASTE & ODOR 625.348251
TYPE OF FILTERING MINERAL	Aggregate	Neutralite	Activated Carbon
AMOUNT OF FILTERING MINERAL	1.0 Cu. Ft. (.028 Cu M)		
WATER PRESS. LIMITS (Min.-Max.)	20 to 125 PSI (1.4 to 8.4 KG/Sq/Cm)		
MAXIMUM WATER TEMPERATURE	120 F (48.9 C)		
MINIMUM WELL PUMP CAPACITY	270 Gal/Hr (1022 Liter/Hr)		
MIN. PIPE SIZE TO FILTER	3/4 In. (19MM)		
BACKWASH FLOW RATE*	4.5 Gal/Min (17 Liter/Min)		
SERVICE FLOW RATE/ CAPACITY	See Rating Decal on Filter		

\* At 35 psi inlet water pressure

## 5A. ELECTRICAL CONNECTIONS

### IMPORTANT:

KEEP THIS MANUAL WITH YOUR WATER FILTER. IF REPAIRS ARE NEEDED, THE SERVICE TECHNICIAN MUST HAVE THE INFORMATION ON THE FOLLOWING 6 PAGES.

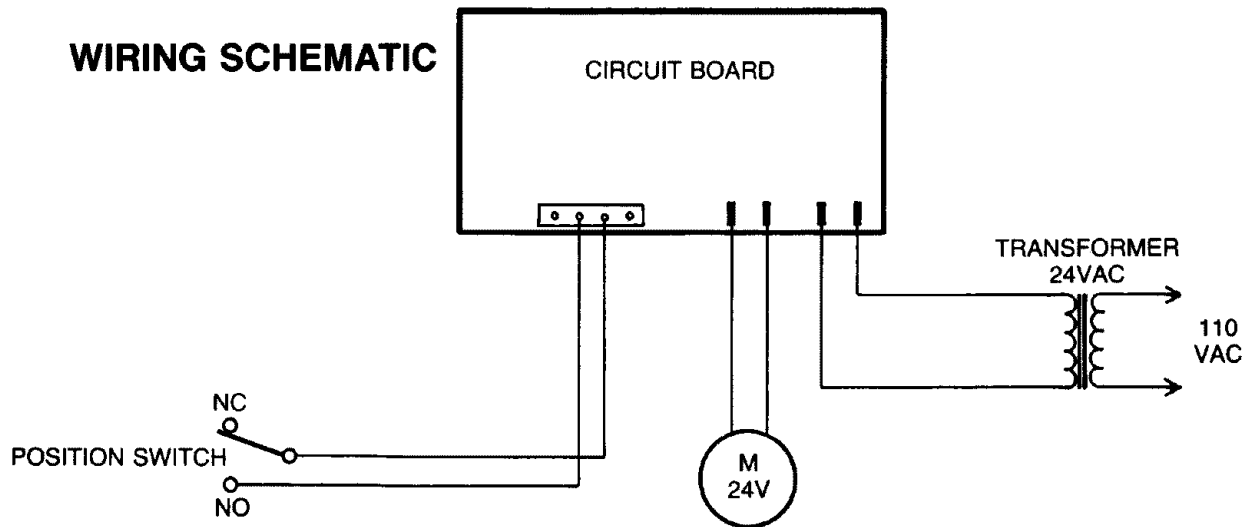

### FACE PLATE TIMER

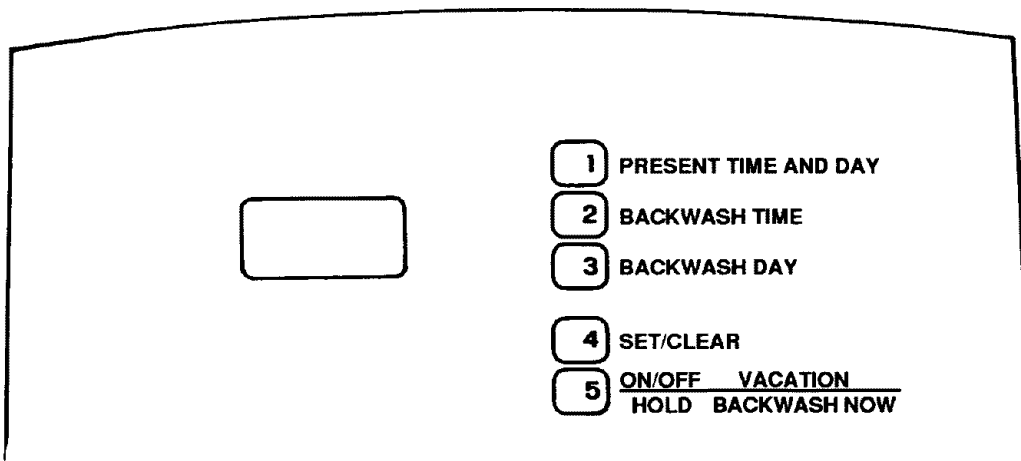

## 5B. BACKWASH CYCLE TIMES

Factory set cycle times are: BACKWASH . . . 25 min., FAST RINSE . . . 5 min. Do the following to check for correct cycle times.

**NOTE:**

Removing from electrical power (varies from 6 to 15 hours) resets timer to factory programming.

**DISPLAY MUST SHOW TIME AND DAY**

1. Press and hold **4** . . . entire display comes on.
2. Press **2** . . . 2:00 shows; meaning #2 cycle (not used) and 0 minutes.
  - a. If 2:00 does show, go to step 3.
  - b. If other than 2:00 (2:00 to 2:15), press **4** until 2:00 shows.
3. Press **2** . . . 3:25 shows meaning #3 cycle (backwash) and 25 minutes.
  - a. If 3:25 does show, go to step 4.
  - b. If other than 3:25 (3:00 to 3:30), press **4** until 3:25 shows.

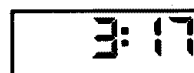
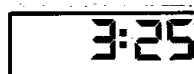
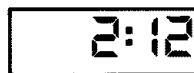

**NOTE:**

If the water supply has no iron and low sediment content, a shorter backwash time could be adequate, and will conserve water. On other water supplies, the filter may require a backwash longer than 25 minutes.

4. Press **2** . . . 4:05 shows; meaning #4 cycle (fast rinse) and 5 minutes.
  - a. If 4:05 does show, go to step 5.
  - b. If other than 4:05 (4:00 to 4:30), press **4** until 4:05 shows.
5. Press **2** . . . 18:88 shows.
6. Press **4** to return present time and day.



## 5C.

## DIAGNOSTICS

### AUTOMATIC ELECTRONIC DIAGNOSTICS

The face plate has a self-diagnostic function for the electrical system (except input power). The face plate monitors the electronic components and circuits for correct operation. If a malfunction occurs, an error code appears in the face plate display.

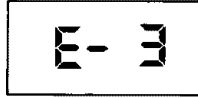

The chart below shows the error codes that could appear, and the possible defects for each code.

While an error code appears in the display, all face plate buttons are inoperable except the SET/CLEAR button. SET/CLEAR remains operational so the service person can make the MANUAL ADVANCE DIAGNOSTICS to further isolate the defect.

CODE	POSSIBLE DEFECT	
	MOST LIKELY ←	→ LESS LIKELY
E - 1	motor inop. / wiring harness or connection to switch / switch / face plate	
E - 2, E - 3	face plate	
E - 4	face plate / position switch	

**PROCEDURE FOR REMOVING ERROR CODE FROM FACE PLATE:** 1. Unplug transformer 2. Correct defect 3. Plug-in transformer 4. Wait for 6 minutes. The error code will return if the defect was not corrected.

### MANUAL ADVANCE DIAGNOSTIC

Use the following procedures to advance filter valve through recharge cycles to check operation.

Remove top cover to observe valve rotation.

DISPLAY MUST SHOW TIME AND DAY

1. Press and **hold** **4** for 3 seconds until 18:88 displays.



2. Press **3** to display position (P) switch open or closed indicator.

If valve is in service, backwash or fast rinse (see markings on cam under motor), display will show . . . (--), meaning the position switch is open.



While the valve is rotating from one cycle to another, the display shows (-P), meaning the position switch is closed.

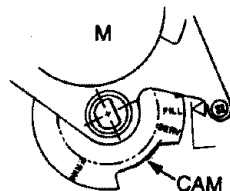

### NOTE:

While in manual advance, the time display automatically returns to the present time of day if a button is not pressed within 4 minutes.

3. To advance valve, press **5** each time you want to move into next cycle. (Pressing **5** while valve is rotating has no affect.)

— Press **5** to move filter into backwash. Look for a fast flow of water from drain hoses.

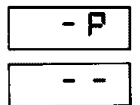

A slow flow indicates an obstructed top distributor, backwash flow plug, drain hose, or iron fouled mineral bed.

— Press **5** to move filter into fast rinse. Again look for fast drain flow.

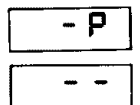

— To return filter to service, press **5**.

4. Press **3** to display 18:88.



5. Press **4** to return present time and day.

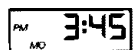

## 5D. "QUICK-CHECK" TROUBLESHOOTING

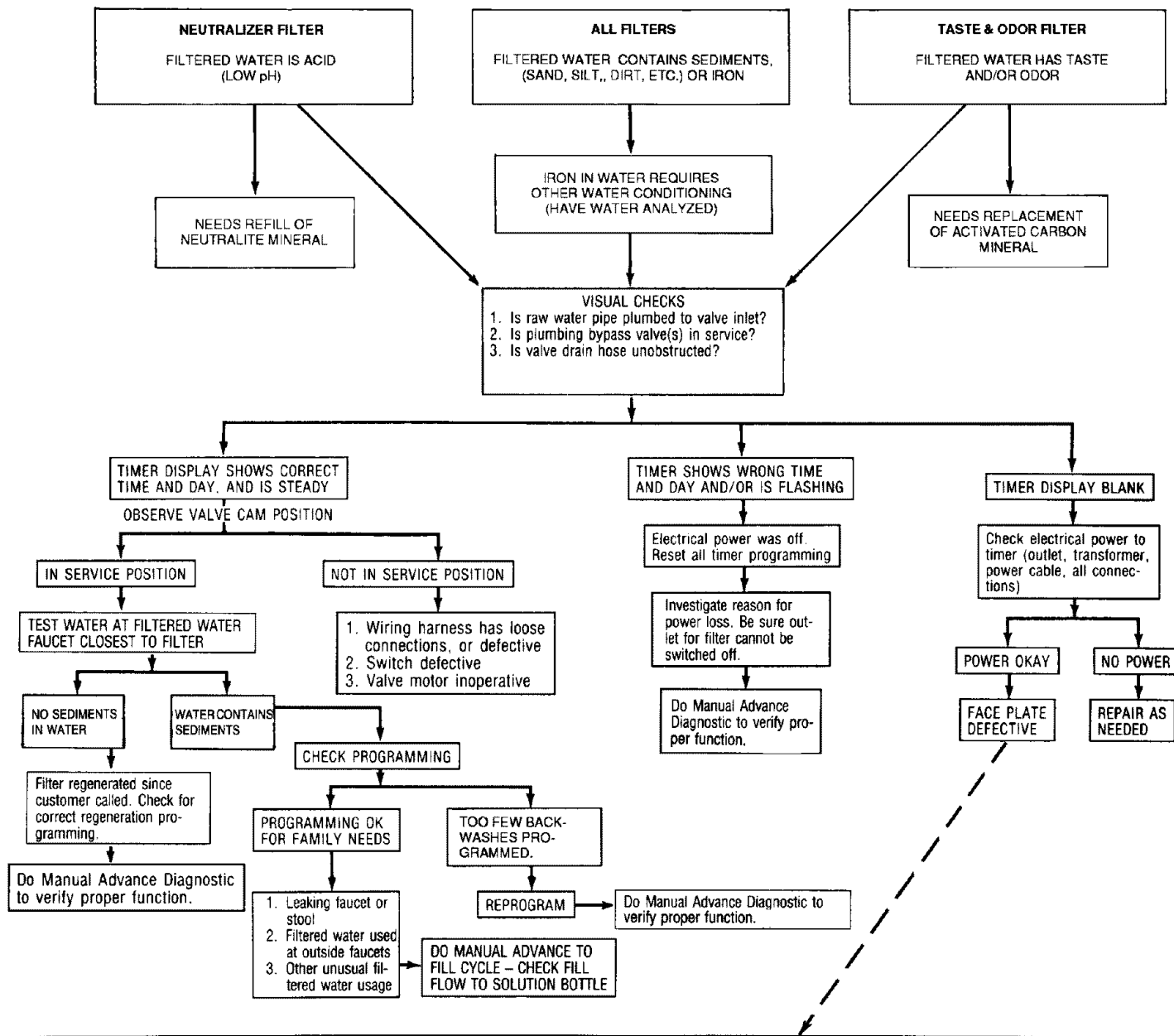

**FACE PLATE REPLACEMENT: BE SURE THE VALVE IS IN SERVICE POSITION (OBSERVE VALVE CYCLE INDICATOR) WHEN REPLACING THE FACE PLATE.**

If after installing and programming the replacement face plate, the valve is not in service position, do the following to assure correct cycle orientation, or timing, between the face plate and valve.

Use the MANUAL ADVANCE procedures, page 21. With the BACKWASH NOW button, advance through the recharge cycles until the valve stops in service position, and RECHARGE no longer flashes in the timer.

NOTE:

The valve motor may automatically drive through several valve positions while searching for service.

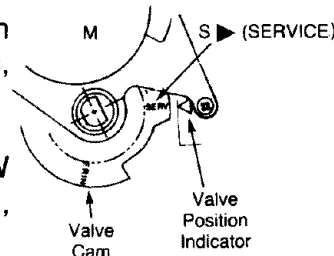

## 5E. ROTARY VALVE SERVICE

BEFORE WORKING ON THE VALVE, TURN OFF THE WATER SUPPLY AND DISCONNECT FROM ELECTRICAL POWER, TO RELIEVE PRESSURE...

... 3 VALVE BYPASS: Close the inlet valve and open a filtered water faucet. Then close the outlet valve and open the bypass valve.

... SEARS SPECIAL BYPASS: Slide the bypass valve stem to bypass position. Loosen the 3 hex head screws (see **A** in drawing) toward the backside of the valve to allow pressure water to bleed out (catch water with a rag).

### DISASSEMBLY

To remove a part or group of parts, refer to the valve drawing. A common screwdriver or nut driver, Phillips screwdriver and pliers are the only tools needed to completely disassemble.

### SERVICING THE VALVE

Inspect all o-rings, seals and gaskets for wear or defects.

Inspect the bottom surface of the rotor and disc for scratches, chips or wear.

### NOTE:

If replacement is needed, be sure to use the current replacement part.

### ASSEMBLY

Be sure all parts are in place and in the proper position. Lubricate ALL o-rings, and seals with FDA approved silicone grease. To install the rotor seal, first place the seal into the valve groove, rounded side down (see cross-section). Apply a light coating of silicone grease to the seal's crossing ribs. Then, carefully center the wear strip on the seal, and push it downward onto the seal.

Install the nozzle and venturi seal and drain seal. Assemble 2 o-rings and the wave washer onto the rotor and disc. Then center the rotor and disc, in the valve body, on the rotor seal.

Lower the cover onto the valve body and rotor shaft. Then install the cover holding screws. **BEFORE TIGHTENING THE SCREWS, INSTALL THE VALVE CAM AND GEAR, THEN TURN THE ROTOR (CLOCKWISE ONLY) TO SERVICE POSITION.**

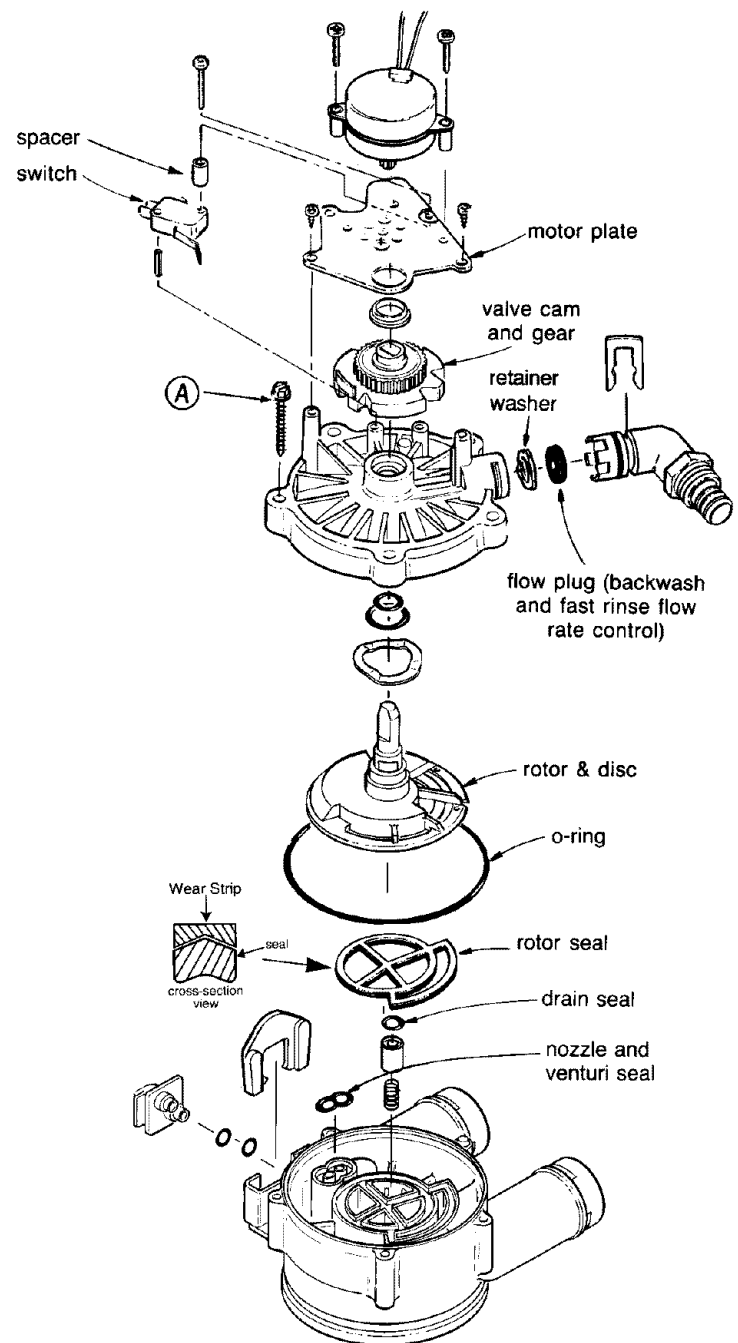

Tighten the screws using a criss-cross pattern. If a torque wrench is available, torque to 30-40 inch pounds.

Lubricate the gear on the motor, and the valve cam gear with Molykote grease, or other high quality gear lubricant.

Be sure to orient switch as shown, with lever toward the valve cam.

## 5F. WATER FLOW THROUGH THE FILTER VALVE

### SERVICE CYCLE

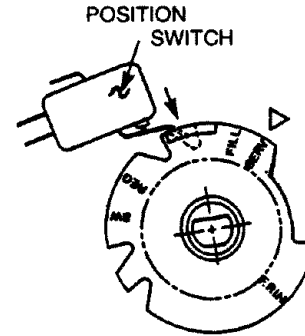
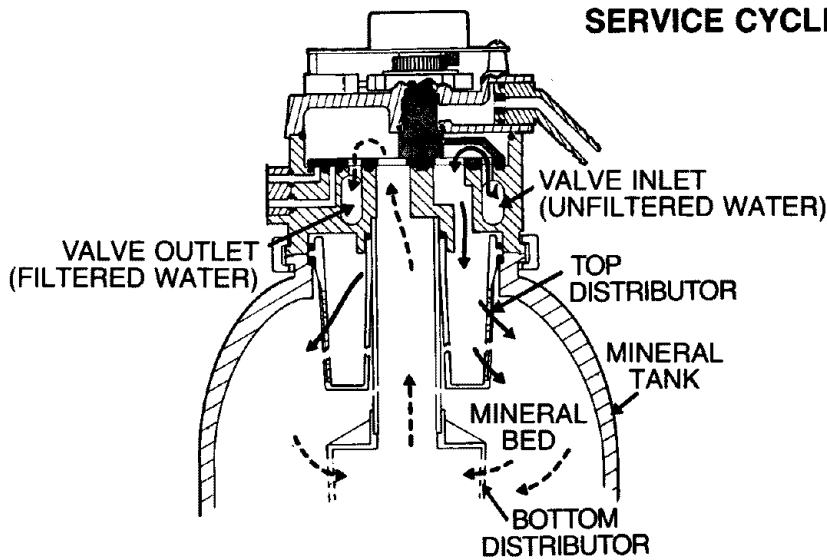

Hard, unfiltered water enters the valve inlet port. Internal valve porting routes the water down and out the top distributor, into the mineral tank. The water is filtered as it passes through the mineral bed, then enters the bottom distributor. Filtered water flows back into the valve and out the valve outlet, to the house filtered water pipes.

### BACKWASH CYCLE

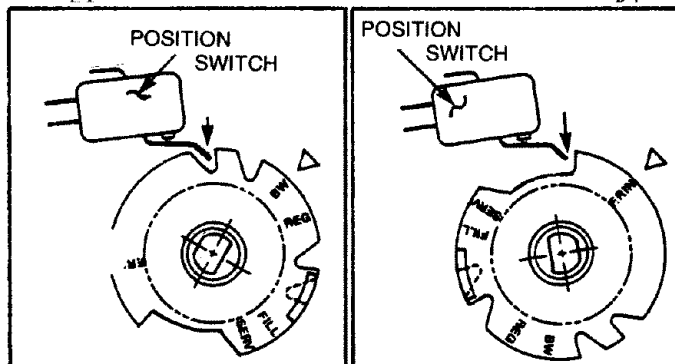
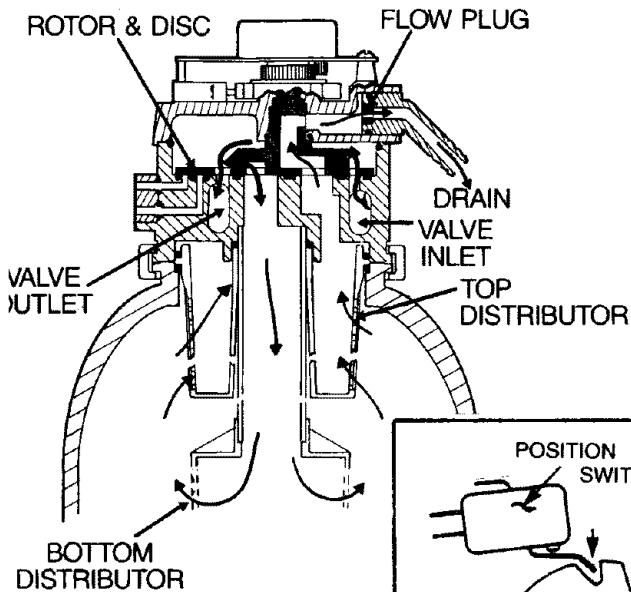

Timer/switch action allows the motor to turn the rotor & disc to place the valve in BACKWASH. Water is routed down and out the bottom distributor, up through the bed, and out the top distributor to the drain. The fast flow (controlled by a flow plug in the drain fitting) flushes dirt, sediments, and iron deposits to the drain.

During FAST RINSE, the rotor & disc is positioned so water flow enters the mineral tank through the top distributor, and

### FAST RINSE CYCLE

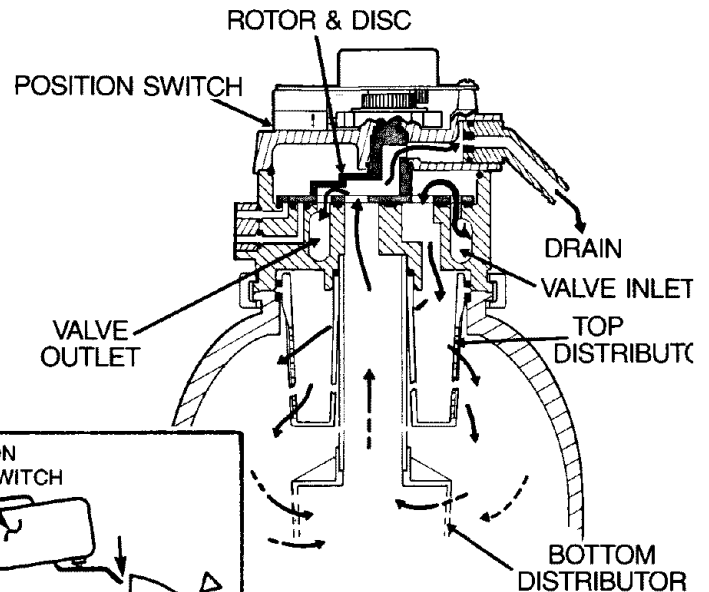

exits through the bottom distributor, to the drain. The fast flow of water downward through the mineral bed flushes any remaining sediments to the drain. The mineral bed is packed and prepared for return to service.

The solid state timer again energizes the motor to return the valve to **service**. As the valve rotates, the position switch lever drops to open the circuit. The valve remains positioned in service until the timer initiates the next regeneration.



## SEARS WATER FILTERS

Clarifier, Model No. 625.348234  
 Neutralizer, Model No. 625.348241  
 Taste & Odor, Model No. 625.348251

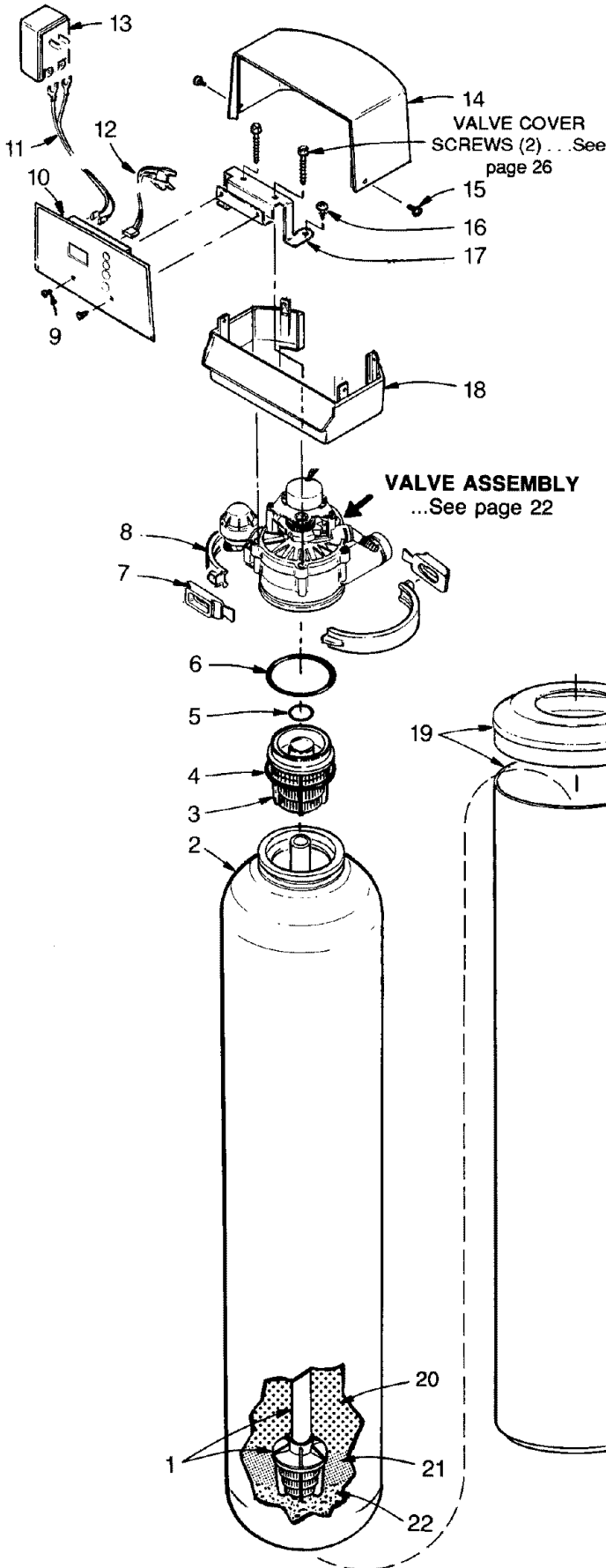

KEY NO.	PART NUMBER	DESCRIPTION
1	7105047	Bottom Distributor & Standpipe
2	7092202	Mineral Tank
3	7088855	Top Distributor
4	7170270	O-Ring, 2-3/4 x 3
5	7170254	O-Ring, 13/16 x 1-1/16
6	7170296	O-Ring, 2-7/8 x 3-1/4
7	7088033	Clamp Retainer (2 req.)
8	7176292	Clamp Section (2 req.)
9	0900300	Screw, #4-40 x 1/4 (2 req.)
10	7146093	Face Plate - Timer
11	7084330	Power Cord
12	7118333	Wire Harness
13	7095373	Transformer, 24V-10VA
14	7144449	Top Cover
15	7103972	Screw, #8 x 7/16 (4 req.)
16	0900291	Screw, #8-32 x 3/8 (2 req.)
17	7141530	Cover Bracket
18	7144431	Bottom Cover
19	7092210	Shroud
◆	7026196	Base (styrofoam)
20	0505647	Filter Agg. - Model No. 625.348234
	3423699	Neutralite - Model No. 625.348241
	3424509	Act. Carbon - Model No. 625.348251
21	0501783	Filter Sand, 10 lbs.
22	7124415	Gravel, 17 lbs.
◆	7207213	Owners Manual
◆	7146611	Installation Manual

◆ not illustrated

## SEARS WATER FILTERS

Clarifier

Model No. 625.348234

Neutralizer

Model No. 625.348241

Taste & Odor

Model No. 625.348251

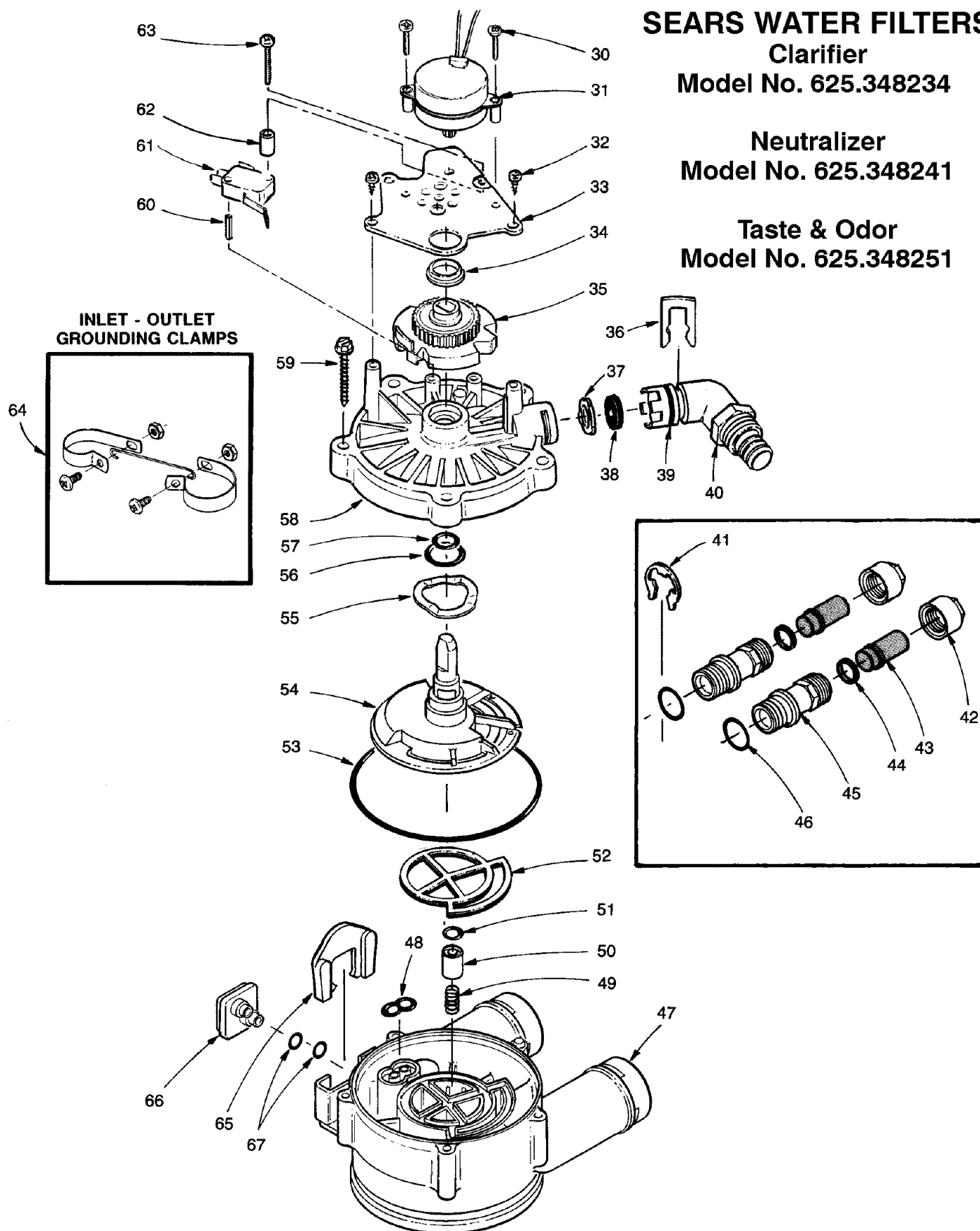

## SEARS WATER FILTERS

Clarifier, Model No. 625.348234  
Neutralizer, Model No. 625.348241  
Taste & Odor, Model No. 625.348251

### PARTS LIST

KEY NO.	PART NUMBER	DESCRIPTION	KEY NO.	PART NUMBER	DESCRIPTION
30	7131755	Screw, #6-20 x 7/8 (2 req.)	55	7082087	Wave Washer
31	7133008	Motor	56	7170212	O-Ring, 3/4 x 15/16
32	0900857	Screw, #6-20 x 3/8 (2 req.)	57	7170238	O-Ring, 7/16 x 5/8
33	7117808	Motor Plate	58	7085263	Valve Cover
34	0503288	Bearing	59	7074123	Screw, #10-14 x 2 (5 req.)
35	7113927	Cam and Gear	60	7077472	Expansion Pin
36	7142942	Clip (Drain)	61	7030713	Switch
37	7030585	Washer, Retainer	62	7117816	Spacer
38	0509537	Flow Plug	63	7070412	Screw, #4-24 x 1-1/8
39	7170327	O-Ring, 5/8 x 13/16	64	7112997	Ground Clamp Kit ●
40	7141239	Drain Hose Adaptor	65	7081201	Clip (Nozzle & Venturi)
41	7116713	Clip (2 req.) ●	66	7100940	Plug
42	0507369	Installation Nut (2 req.) [2]	67	7170319	O-Ring, 1/4 x 3/8 (2 req.)
43	0507615	Installation Tube (2 req.) [2]	◆	7111941	Small Parts Bag (Includes all items marked with ●)
44	7170335	Washer (2 req.) [2]	◆	7129716	Seal Kit (Incl. Key Nos. 48, 51, 52, 53, 56 and 57)
45	2207800	Installation Adaptor (2 req.) ●			
46	7170288	O-Ring, 15/16 x 1-3/16 (2 req.) ●			
47	7082053	Valve Body			
48	7081764	Seal			
49	7129889	Spring			
50	7092642	Plug (Drain Seal)			
51	7170204	O-Ring, 3/8 x 9/16			
52	7134224	Rotor Seal			
53	7170246	O-Ring, 3-3/8 x 3-5/8			
54	7199232	Rotor & Disc			

◆ Not illustrated

[2] Parts not included with filter  
— available from Sears Stock No. 42-3441

# **SEARS**

## **OWNER'S MANUAL**

**MODEL NOS.  
625.348234  
Clarifier**

**625.348241  
Neutralizer**

**625.348251  
Taste & Odor**

The model number of your water filter is found on the rating decal. This decal is on the backside of the top cover.

When requesting service or ordering parts, always provide the following information:

- ◆ Product Type
- ◆ Model Number
- ◆ Part Number
- ◆ Part Description

# **Kenmore**

## **Water Filters**

For the repair or replacement parts you need  
delivered directly to your home

Call 7 am – 7 pm, 7 days a week

**1 – 800 – 366 – PART**

(1 – 800 – 366 – 7278)

---

For in-home major brand repair service

Call 24 hours a day, 7 days a week

**1 – 800 – 4 – REPAIR**

(1 – 800 – 473 – 7247)

---

For the location of a  
**Sears Parts and Repair Center in your area**

Call 24 hours a day, 7 days a week

**1 – 800 – 488 – 1222**

---

For information on purchasing a **Sears  
Maintenance Agreement, or to inquire  
about an existing Agreement**

Call 9 am – 5 pm, Monday – Saturday

**1 – 800 – 827 – 6655**

---

**Sears, Roebuck and Co., Hoffman Estates, IL 60179 U.S.A.**

7207213 (2/99)

## Free Manuals Download Website

<http://myh66.com>

<http://usermanuals.us>

<http://www.somanuals.com>

<http://www.4manuals.cc>

<http://www.manual-lib.com>

<http://www.404manual.com>

<http://www.luxmanual.com>

<http://aubethermostatmanual.com>

Golf course search by state

<http://golfingnear.com>

Email search by domain

<http://emailbydomain.com>

Auto manuals search

<http://auto.somanuals.com>

TV manuals search

<http://tv.somanuals.com>