



# OPERATOR'S MANUAL

## 5-1/2 in. CORNER CAT®

### COMPACT FINISH SANDER

#### DOUBLE INSULATED

#### CFS1503

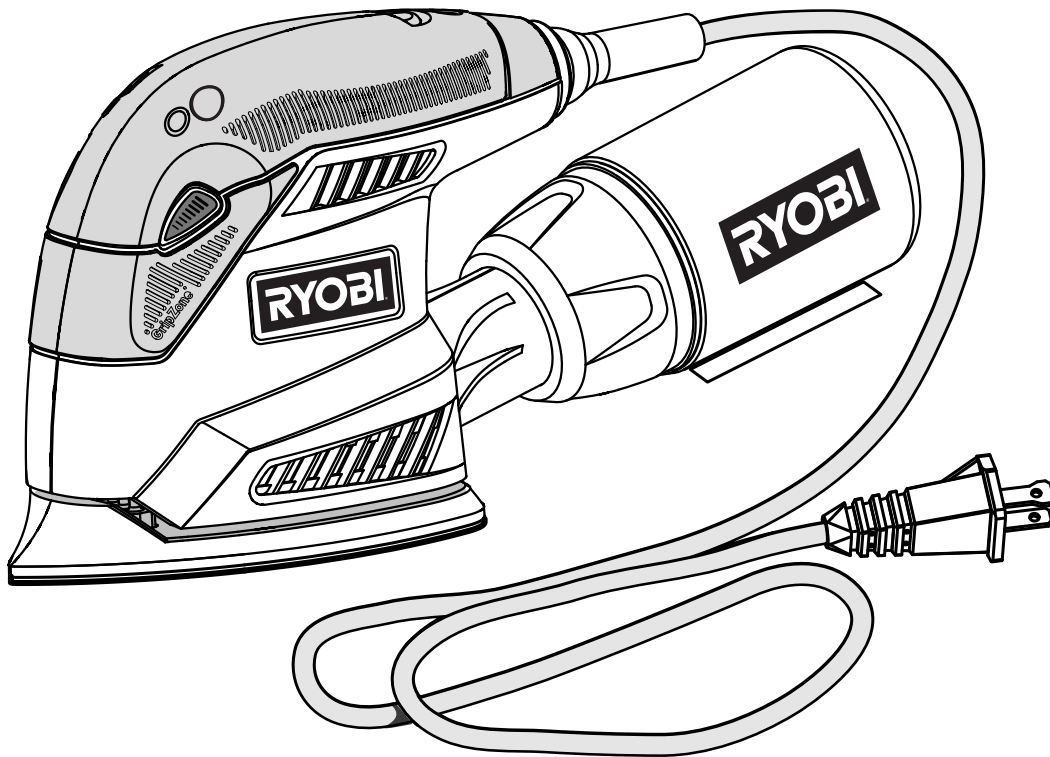

Your finish sander has been engineered and manufactured to our high standard for dependability, ease of operation, and operator safety. When properly cared for, it will give you years of rugged, trouble-free performance.

**WARNING:** To reduce the risk of injury, the user must read and understand the operator's manual before using this product.

Thank you for your purchase.

**SAVE THIS MANUAL FOR FUTURE REFERENCE**

# TABLE OF CONTENTS

■ Introduction .....	2
■ Warranty .....	2
■ General Safety Rules.....	3-4
■ Specific Safety Rules.....	4
■ Symbols.....	5-6
■ Electrical .....	7
■ Features.....	8
■ Assembly .....	9
■ Operation.....	9-13
■ Maintenance.....	13
■ Parts Ordering / Service .....	Back Page

## INTRODUCTION

This product has many features for making its use more pleasant and enjoyable. Safety, performance, and dependability have been given top priority in the design of this product making it easy to maintain and operate.

## WARRANTY

### **RYOBI® POWER TOOL - LIMITED TWO YEAR WARRANTY AND 30 DAY EXCHANGE POLICY**

One World Technologies, Inc., warrants its RYOBI® power tools with the following conditions:

**30-DAY EXCHANGE POLICY:** During the first 30 days after date of purchase, you may either request service under this warranty or you may exchange any RYOBI® power tool which does not work properly due to defective workmanship or materials by returning the power tool to the dealer from which it was purchased. To receive a replacement power tool or requested warranty service, you must present proof of purchase and return all original equipment packaged with the original product. The replacement power tool will be covered by the limited warranty for the balance of the two year period from the date of the original purchase.

**WHAT THIS WARRANTY COVERS:** This warranty covers all defects in workmanship or materials in your RYOBI® power tool for a period of two years from the date of purchase. With the exception of batteries, power tool accessories are warranted for ninety (90) days. Batteries are warranted for two years.

**HOW TO GET SERVICE:** Just return the power tool, properly packaged and postage prepaid, to an Authorized Service Center. You can obtain the location of the Service Center nearest you by contacting a service representative at One World Technologies, Inc., P.O. Box 1207, Anderson, SC 29622-1207, by calling 1-800-525-2579 or by logging on to [www.ryobitools.com](http://www.ryobitools.com). When you request warranty service, you must also present proof of purchase documentation, which includes the date of purchase (for example, a bill of sale). We will repair any faulty workmanship, and either repair or replace any defective part, at our option. We will do so without any charge to you. We will complete the work in a reasonable time, but, in any case, within ninety (90) days or less.

**WHAT'S NOT COVERED:** This warranty applies only to the original purchaser at retail and may not be transferred. This warranty only covers defects arising under normal usage and does not cover any malfunction, failure or defects resulting from misuse, abuse, neglect, alteration, modification or repairs by other than Authorized Service Centers. One World Technologies, Inc. makes no warranties, representations or promises as to the quality or performance of its power tools other than those specifically stated in this warranty.

**ADDITIONAL LIMITATIONS:** Any implied warranties granted under state law, including warranties of merchantability or fitness for a particular purpose, are limited to two years from the date of purchase. One World Technologies, Inc. is not responsible for direct, indirect, or incidental damages, so the above limitations and exclusions may not apply to you. This warranty gives you specific legal rights, and you may also have other rights which vary from state to state.

# GENERAL SAFETY RULES

## **WARNING!**

**Read all instructions.** Failure to follow all instructions listed below may result in electric shock, fire and/or serious injury. The term “power tool” in all of the warnings listed below refers to your mains-operated (corded) power tool or battery-operated (cordless) power tool.

## SAVE THESE INSTRUCTIONS

### WORK AREA SAFETY

- **Keep work area clean and well lit.** Cluttered or dark areas invite accidents.
- **Do not operate power tools in explosive atmospheres, such as in the presence of flammable liquids, gases or dust.** Power tools create sparks which may ignite the dust or fumes.
- **Keep children and bystanders away while operating a power tool.** Distractions can cause you to lose control.

### ELECTRICAL SAFETY

- **Power tool plugs must match the outlet. Never modify the plug in any way. Do not use any adapter plugs with earthed (grounded) power tools.** Unmodified plugs and matching outlets will reduce risk of electric shock.
- **Avoid body contact with earthed or grounded surfaces such as pipes, radiators, ranges and refrigerators.** There is an increased risk of electric shock if your body is earthed or grounded.
- **Do not expose power tools to rain or wet conditions.** Water entering a power tool will increase the risk of electric shock.
- **Do not abuse the cord. Never use the cord for carrying, pulling or unplugging the power tool. Keep cord away from heat, oil, sharp edges or moving parts.** Damaged or entangled cords increase the risk of electric shock.
- **When operating a power tool outdoors, use an extension cord suitable for outdoor use.** Use of a cord suitable for outdoor use reduces the risk of electric shock.

### PERSONAL SAFETY

- **Stay alert, watch what you are doing and use common sense when operating a power tool. Do not use a power tool while you are tired or under the influence of drugs, alcohol or medication.** A moment of inattention while operating power tools may result in serious personal injury.
- **Use safety equipment. Always wear eye protection.** Safety equipment such as dust mask, non-skid safety shoes, hard hat, or hearing protection used for appropriate conditions will reduce personal injuries.
- **Avoid accidental starting. Ensure the switch is in the off-position before plugging in.** Carrying power tools

with your finger on the switch or plugging in power tools that have the switch on invites accidents.

- **Remove any adjusting key or wrench before turning the power tool on.** A wrench or a key left attached to a rotating part of the power tool may result in personal injury.
- **Do not overreach. Keep proper footing and balance at all times.** This enables better control of the power tool in unexpected situations.
- **Dress properly. Do not wear loose clothing or jewelry. Keep your hair, clothing and gloves away from moving parts.** Loose clothes, jewelry or long hair can be caught in moving parts.
- **If devices are provided for the connection of dust extraction and collection facilities, ensure these are connected and properly used.** Use of these devices can reduce dust-related hazards.
- **Do not wear loose clothing or jewelry. Contain long hair.** Loose clothes, jewelry, or long hair can be drawn into air vents.
- **Do not use on a ladder or unstable support.** Stable footing on a solid surface enables better control of the power tool in unexpected situations.

### POWER TOOL USE AND CARE

- **Do not force the power tool. Use the correct power tool for your application.** The correct power tool will do the job better and safer at the rate for which it was designed.
- **Do not use the power tool if the switch does not turn it on and off.** Any power tool that cannot be controlled with the switch is dangerous and must be repaired.
- **Disconnect the plug from the power source and/or the battery pack from the power tool before making any adjustments, changing accessories, or storing power tools.** Such preventive safety measures reduce the risk of starting the power tool accidentally.
- **Store idle power tools out of the reach of children and do not allow persons unfamiliar with the power tool or these instructions to operate the power tool.** Power tools are dangerous in the hands of untrained users.
- **Maintain power tools. Check for misalignment or binding of moving parts, breakage of parts and any other condition that may affect the power tool's operation. If damaged, have the power tool repaired before use.** Many accidents are caused by poorly maintained power tools.
- **Keep cutting tools sharp and clean.** Properly maintained cutting tools with sharp cutting edges are less likely to bind and are easier to control.
- **Use the power tool, accessories and tool bits etc., in accordance with these instructions and in the manner intended for the particular type of power tool, taking into account the working conditions and the work to be performed.** Use of the power tool for operations different from those intended could result in a hazardous situation.

# GENERAL SAFETY RULES

## SERVICE

- **Have your power tool serviced by a qualified repair person using only identical replacement parts.** This will ensure that the safety of the power tool is maintained.

### **WARNING!**

To reduce the risk of injury, user must read instruction manual.











- **When servicing a power tool, use only identical replacement parts. Follow instructions in the Maintenance section of this manual.** Use of unauthorized parts or failure to follow Maintenance instructions may create a risk of shock or injury.

# SPECIFIC SAFETY RULES

- **Hold power tools by insulated gripping surfaces when performing an operation where the cutting tool may contact hidden wiring or its own cord.** Contact with a “live” wire will make exposed metal parts of the tool “live” and shock the operator.
- **Know your power tool. Read operator’s manual carefully. Learn its applications and limitations, as well as the specific potential hazards related to this power tool.** Following this rule will reduce the risk of electric shock, fire, or serious injury.
- **Always wear safety glasses. Everyday eyeglasses have only impact-resistant lenses; they are NOT safety glasses.** Following this rule will reduce the risk of serious personal injury.
- **Protect your lungs. Wear a face or dust mask if the operation is dusty.** Following this rule will reduce the risk of serious personal injury.
- **Protect your hearing. Wear hearing protection during extended periods of operation.** Following this rule will reduce the risk of serious personal injury.
- **Inspect power tool cords periodically and, if damaged, have repaired at your nearest Authorized Service Center. Constantly stay aware of cord location.** Following this rule will reduce the risk of electric shock or fire.
- **Check damaged parts. Before further use of the power tool, a guard or other part that is damaged should be carefully checked to determine that it will operate properly and perform its intended function. Check for alignment of moving parts, binding of moving parts, breakage of parts, mounting, and any other conditions that may affect its operation. A guard or other part that is damaged should be properly repaired or replaced by an authorized service center.** Following this rule will reduce the risk of shock, fire, or serious injury.
- **Make sure your extension cord is in good condition. When using an extension cord, be sure to use one heavy enough to carry the current your product will draw. A wire gauge size (A.W.G.) of at least 16 is recommended for an extension cord 50 feet or less in length. A cord exceeding 100 feet is not recommended. If in doubt, use the next heavier gauge. The smaller the gauge number, the heavier the cord. An undersized cord will cause a drop in line voltage resulting in loss of power and overheating.**
- **Inspect for and remove all nails from lumber before using this power tool.** Following this rule will reduce the risk of serious personal injury.
- **If the power supply cord is damaged, it must be replaced only by the manufacturer or by an authorized service center to avoid risk.**
- **Save these instructions.** Refer to them frequently and use them to instruct others who may use this power tool. If you loan someone this power tool, loan them these instructions also.



# SYMBOLS

Some of the following symbols may be used on this product. Please study them and learn their meaning. Proper interpretation of these symbols will allow you to operate the product better and safer.

SYMBOL	NAME	DESIGNATION/EXPLANATION
V	Volts	Voltage
A	Amperes	Current
Hz	Hertz	Frequency (cycles per second)
W	Watt	Power
min	Minutes	Time
~	Alternating Current	Type of current
≡	Direct Current	Type or a characteristic of current
$n_0$	No Load Speed	Rotational speed, at no load
	Class II Construction	Double-insulated construction
.../min	Per Minute	Revolutions, strokes, surface speed, orbits etc., per minute
	Wet Conditions Alert	Do not expose to rain or use in damp locations.
	Read The Operator's Manual	To reduce the risk of injury, user must read and understand operator's manual before using this product.
	Eye Protection	Always wear safety goggles or safety glasses with side shields and, as necessary, a full face shield when operating this product.
	Safety Alert	Precautions that involve your safety.
	No Hands Symbol	Failure to keep your hands away from the blade will result in serious personal injury.
	No Hands Symbol	Failure to keep your hands away from the blade will result in serious personal injury.
	No Hands Symbol	Failure to keep your hands away from the blade will result in serious personal injury.
	No Hands Symbol	Failure to keep your hands away from the blade will result in serious personal injury.
	Hot Surface	To reduce the risk of injury or damage, avoid contact with any hot surface.

# SYMBOLS

The following signal words and meanings are intended to explain the levels of risk associated with this product.

SYMBOL	SIGNAL	MEANING
	<b>DANGER:</b>	Indicates an imminently hazardous situation, which, if not avoided, will result in death or serious injury.
	<b>WARNING:</b>	Indicates a potentially hazardous situation, which, if not avoided, could result in death or serious injury.
	<b>CAUTION:</b>	Indicates a potentially hazardous situation, which, if not avoided, may result in minor or moderate injury.
	<b>CAUTION:</b>	(Without Safety Alert Symbol) Indicates a situation that may result in property damage.

## SERVICE

Servicing requires extreme care and knowledge and should be performed only by a qualified service technician. For service we suggest you return the product to the nearest **AUTHORIZED SERVICE CENTER** for repair. When servicing, use only identical replacement parts.



### **WARNING:**

To avoid serious personal injury, do not attempt to use this product until you read thoroughly and understand completely the operator's manual. If you do not understand the warnings and instructions in the operator's manual, do not use this product. Call Ryobi customer service for assistance.



### **WARNING:**



The operation of any power tool can result in foreign objects being thrown into your eyes, which can result in severe eye damage. Before beginning power tool operation, always wear safety goggles or safety glasses with side shields and, when needed, a full face shield. We recommend Wide Vision Safety Mask for use over eyeglasses or standard safety glasses with side shields. Always use eye protection which is marked to comply with ANSI Z87.1.

## SAVE THESE INSTRUCTIONS



# ELECTRICAL

## DOUBLE INSULATION

Double insulation is a concept in safety in electric power tools, which eliminates the need for the usual three-wire grounded power cord. All exposed metal parts are isolated from the internal metal motor components with protecting insulation. Double insulated tools do not need to be grounded.

### **WARNING:**

The double insulated system is intended to protect the user from shock resulting from a break in the tool's internal insulation. Observe all normal safety precautions to avoid electrical shock.

**NOTE:** Servicing of a product with double insulation requires extreme care and knowledge of the system and should be performed only by a qualified service technician. For service, we suggest you return the product to your nearest authorized service center for repair. Always use original factory replacement parts when servicing.

## ELECTRICAL CONNECTION

This product has a precision-built electric motor. It should be connected to a **power supply that is 120 volts, 60 Hz, AC only (normal household current)**. Do not operate this product on direct current (DC). A substantial voltage drop will cause a loss of power and the motor will overheat. If the product does not operate when plugged into an outlet, double-check the power supply.

## EXTENSION CORDS

When using a power tool at a considerable distance from a power source, be sure to use an extension cord that has the capacity to handle the current the product will draw. An undersized cord will cause a drop in line voltage, resulting in overheating and loss of power. Use the chart to determine the minimum wire size required in an extension cord. Only round jacketed cords listed by Underwriter's Laboratories (UL) should be used.

When working outdoors with a product, use an extension cord that is designed for outside use. This type of cord is designated with "WA" on the cord's jacket.

Before using any extension cord, inspect it for loose or exposed wires and cut or worn insulation.

\*\*Ampere rating (on product data plate)

Cord Length	Wire Size (A.W.G.)					
	0-2.0	2.1-3.4	3.5-5.0	5.1-7.0	7.1-12.0	12.1-16.0
25'	16	16	16	16	14	14
50'	16	16	16	14	14	12
100'	16	16	14	12	10	—

\*\*Used on 12 gauge - 20 amp circuit.

**NOTE:** AWG = American Wire Gauge

### **WARNING:**

Keep the extension cord clear of the working area. Position the cord so that it will not get caught on lumber, tools, or other obstructions while you are working with a power tool. Failure to do so can result in serious personal injury.

### **WARNING:**

Check extension cords before each use. If damaged replace immediately. Never use the product with a damaged cord since touching the damaged area could cause electrical shock resulting in serious injury.

# FEATURES

## PRODUCT SPECIFICATIONS

Sanding Pad Length.....5-1/2 in.  
Cord Length ..... 10 ft.  
Orbit Diameter..... 1/16 in.

No Load Speed ..... 12,500 r/min. (RPM)  
Input ..... 120 V, 60 Hz, AC only, 1.2 Amp

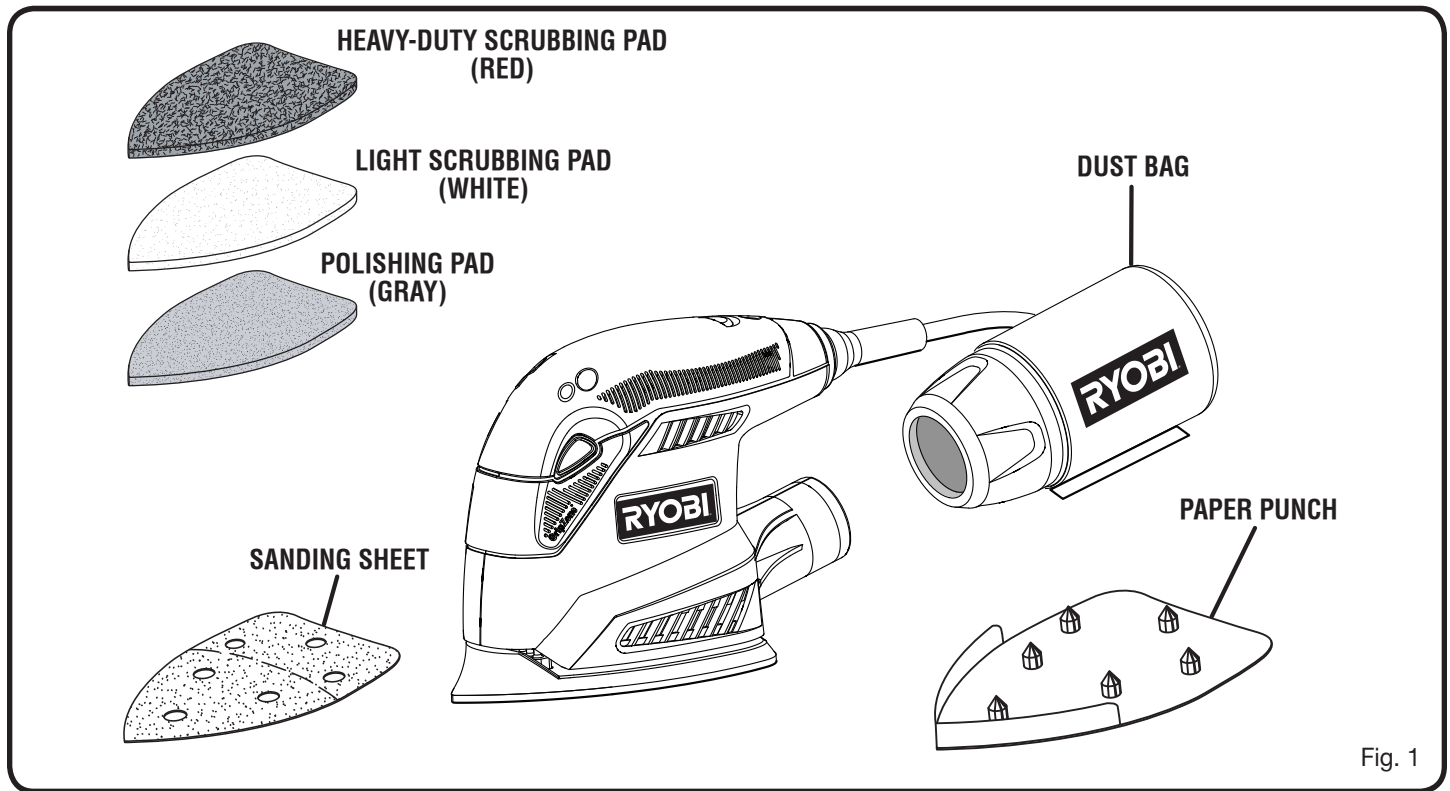

## KNOW YOUR COMPACT FINISH SANDER

See Figure 1.

The safe use of this product requires an understanding of the information on the product and in this operator's manual as well as a knowledge of the project you are attempting. Before use of this product, familiarize yourself with all operating features and safety rules.

### CIRCULAR SANDING ACTION

The oscillating action of the sander produces very quick, small circular motion of the sanding pad. The motion is ideal for producing a fine finished grain or, when using the scrubbing pad, removing light rust, paint, and other buildup from the work surface.

### DUST BAG

The dust bag collects dust through punched holes in the sandpaper and hook-and-loop pad, keeping dust to a minimum.

## GRIPZONE™ OVERMOLD TECHNOLOGY

The sander features GripZone™ overmold technology for improved comfort with a positive grip.

### PAPER PUNCH

The paper punch template punches sandpaper for proper fit and alignment.

### QUICK CHANGE HOOK-AND-LOOP PAD

The hook-and-loop design allows for quick change of sanding sheets and scrubbing pads. It also enables you to easily clean and reuse them.

### TRI-FLEX PAD DESIGN

The top two-thirds of each sanding sheet is a detachable triangle that can be rotated to extend sheet life and promote even wear.



# ASSEMBLY

## UNPACKING

This product has been shipped completely assembled.

- Carefully remove the product and any accessories from the box. Make sure that all items listed in the packing list are included.
- Inspect the product carefully to make sure no breakage or damage occurred during shipping.
- Do not discard the packing material until you have carefully inspected and satisfactorily operated the product.
- If any parts are damaged or missing, please call 1-800-525-2579 for assistance.

## PACKING LIST

5-1/2 in. Corner Cat® Compact Finish Sander  
60-grit Sanding Sheet (2)  
120-grit Sanding Sheet (3)  
240-grit Sanding Sheet (2)  
Heavy-duty Scrubbing Pad (Red)  
Light Scrubbing Pad (White)  
Polishing Pad (Gray)  
Dust Bag  
Paper Punch  
Tool Bag  
Operator's Manual

### **WARNING:**

If any parts are damaged or missing do not operate this product until the parts are replaced. Failure to heed this warning could result in serious personal injury.

### **WARNING:**

Do not attempt to modify this product or create accessories not recommended for use with this product. Any such alteration or modification is misuse and could result in a hazardous condition leading to possible serious personal injury.

### **WARNING:**

Do not connect to power supply until assembly is complete. Failure to comply could result in accidental starting and possible serious personal injury.

# OPERATION

### **WARNING:**

Do not allow familiarity with products to make you careless. Remember that a careless fraction of a second is sufficient to inflict serious injury.

### **WARNING:**

Always wear safety goggles or safety glasses with side shields when operating power tools. Failure to do so could result in objects being thrown into your eyes resulting in possible serious injury.

### **WARNING:**

Do not use any attachments or accessories not recommended by the manufacturer of this product. The use of attachments or accessories not recommended can result in serious personal injury.

## APPLICATIONS

You may use this product for the purposes listed below:

- Sanding on wood surfaces
- Removing rust from and sanding steel surfaces
- Polishing and scrubbing porcelain and metal

## SANDING SHEET SELECTION

Selecting the correct size grit and type sanding sheet is an important step in achieving a high quality finish. Aluminum oxide, silicon carbide, and other synthetic abrasives are best for power sanding. Natural abrasives, such as flint and garnet are too soft for economical use in power sanding.

In general, coarse grit will remove the most material and finer grit will produce the best finish in all sanding operations. The condition of the surface to be sanded will determine which grit will do the job. If the surface is rough, start with a coarse grit and sand until the surface is uniform. Medium grit may then be used to remove scratches left by the coarser grit and finer grit used for finishing of the surface. Always continue sanding with each grit until surface is uniform.

# OPERATION

## Sheet/Pad

Heavy scrubbing pad  
(Part no. CFS1501-36)  
Light scrubbing pad  
(Part no. CFS1501-37)  
Polishing pad  
(Part no. CFS1501-38)  
60-grit sanding sheet  
(Part no. CFS1501-33)  
120-grit sanding sheet  
(Part no. CFS1501-34)  
240-grit sanding sheet  
(Part no. CFS1501-35)

## Recommended Use

Paint and rust removal  
  
Light scrubbing and cleaning  
  
Polishing  
  
Coarse sanding  
  
Light sanding  
  
Finish sanding

## ATTACHING HOOK-AND-LOOP SANDING SHEETS

See Figure 2.

- Unplug the sander.
- Align holes in hook-and-loop type sanding sheet with holes in pad, then carefully press fuzzy side of the sanding sheet against pad as tightly as possible.

**NOTE:** Hook-and-loop type sanding sheets can be reused for the life of the sanding abrasive. It is recommended that you keep the sanding sheet backing clean to provide for best adhesion. Clean the sheet and hook-and-loop pad by brushing lightly with a light brush.

## ATTACHING THE DUST BAG

See Figure 3.

The dust bag provides a dust collection system for the sander. Sanding dust is drawn up through the holes of the sanding sheet and collected in the dust bag during sanding.

- Unplug the sander.
- Using a slight twisting motion, firmly slide dust bag assembly over blower exhaust on sander.

## TURNING THE SANDER ON/OFF

See Figure 4.

While holding the tool in normal operating position:

- Push the ON/OFF switch to the left to turn sander on.
- Push the ON/OFF switch to the right to turn sander off.

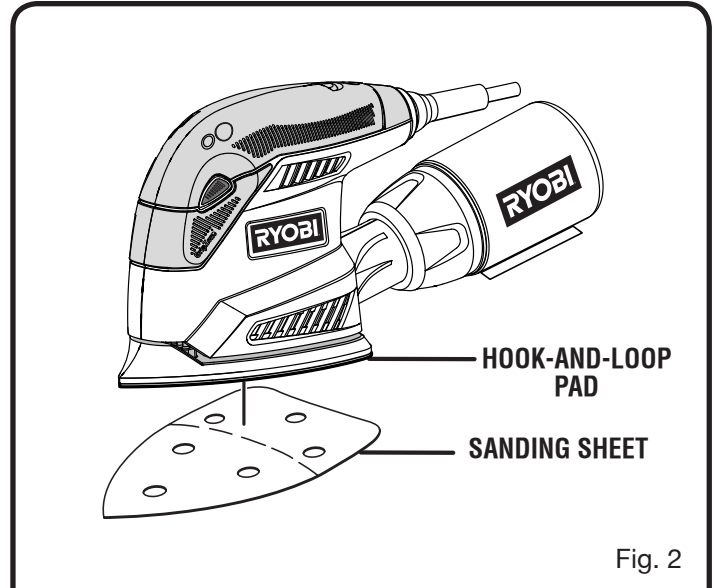

Fig. 2

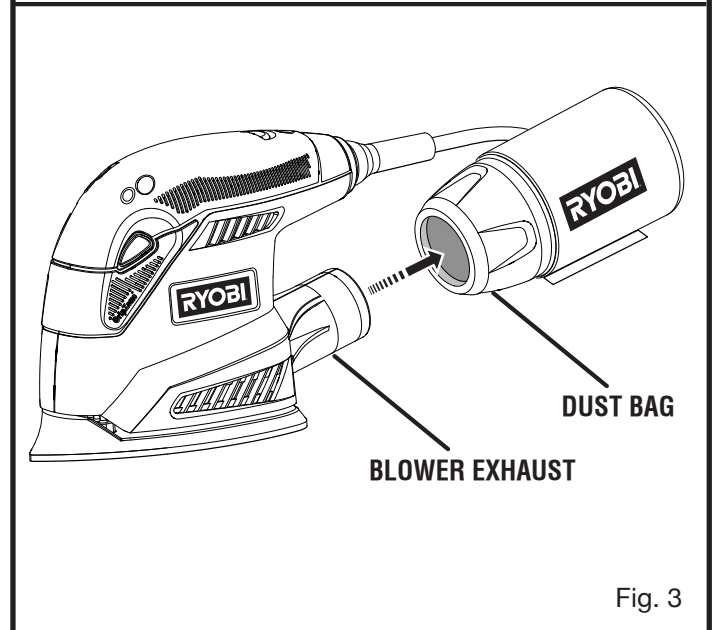

Fig. 3

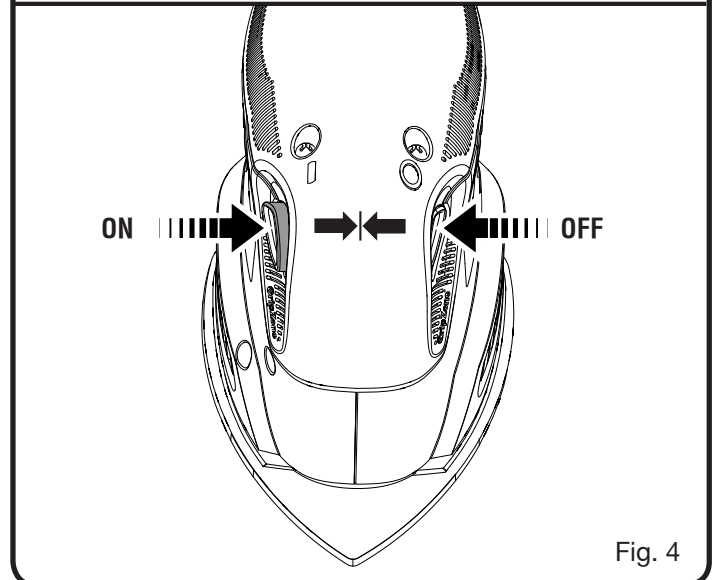

Fig. 4

# OPERATION

## OPERATING THE SANDER

See Figures 5 - 6.

### ⚠ CAUTION:

Keep the cord away from the sanding pad and position the cord so that it will not be caught on lumber, tools, or other objects during sanding.

- Secure the workpiece to prevent it from moving under the sander.

### ⚠ WARNING:

Unsecured workpieces could be thrown towards the operator, causing injury.

### ⚠ WARNING:

Keep your head away from the sander and sanding area. Hair could be drawn into sander causing serious injury.

- Hold the sander in front and away from you, keeping it clear of the workpiece.

### CAUTION:

To avoid motor damage resulting from overheating, do not cover the air vents with your hand.

- Start the sander and let the motor build to its maximum speed.
- Gradually lower sander onto the workpiece so that all of the sanding disc surface is in contact with workpiece.
- Move the sander slowly across the workpiece using small, circular motions.

**Do not force.** The weight of the unit supplies adequate pressure to do the work. Applying additional pressure only slows the motor, rapidly wears the sanding sheet, and greatly reduces sander speed. Excessive pressure will overload the motor causing possible damage from overheating and can result in inferior work. Any finish or resin on wood may soften from the frictional heat. Do not sand on one spot too long as the sander's rapid action may remove too much material, making the surface uneven.

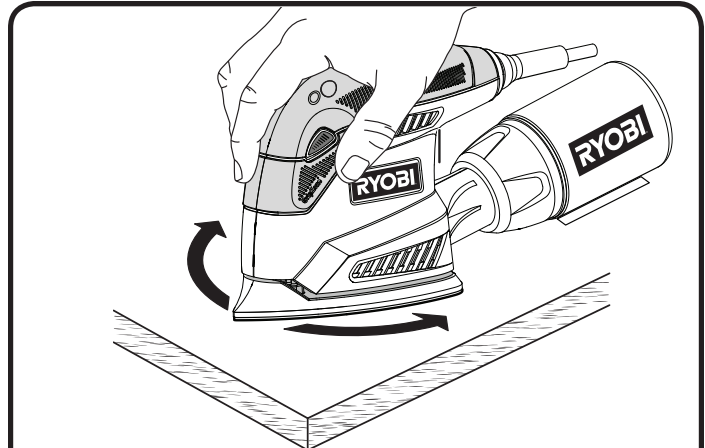

SANDING IN CIRCULAR MOTIONS

Fig. 5

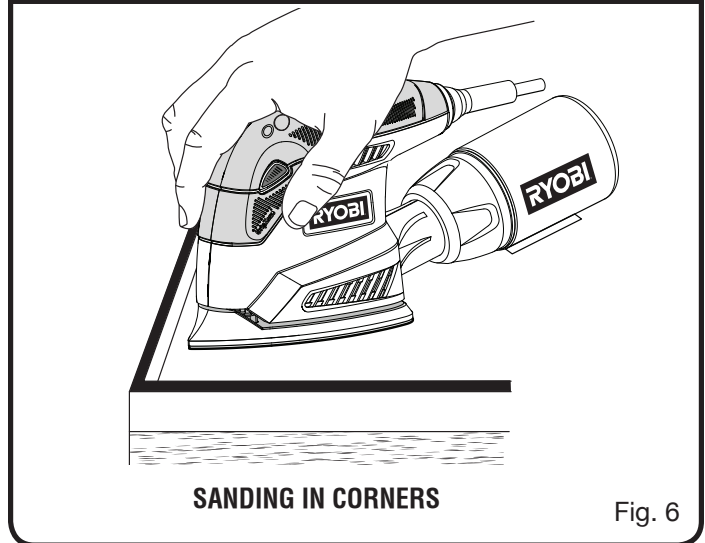

SANDING IN CORNERS

Fig. 6

Extended periods of sanding may overheat the motor. If this occurs, turn the sander off and wait until the sanding sheet comes to a complete stop. Remove sander from workpiece. Remove your hand from vent area. Turn sander on and run it free without a load to cool the motor.

For detail sanding such as corners and crevices, use the tip of the sanding sheet with small, back and forth motions.

# OPERATION

## EMPTYING THE DUST BAG

See Figure 7.

For more efficient operation, empty the dust bag when it is no more than half full to permit better air flow through the bag. Always empty and clean the dust bag thoroughly upon completion of a sanding operation and before storing.

### **⚠ WARNING:**

Collected dust from sanding surface coatings such as polyurethanes, linseed oil, etc. can self-ignite in the sander dust bag or elsewhere and cause fire. To reduce the risk of fire, empty the dust bag every 10-15 minutes while sanding. Never store or leave a sander without totally emptying its dust bag. Also follow the recommendations of the coatings manufacturers.

- Unplug the sander.
- Remove the dust bag from the sander.
- Shake out the dust.
- Reattach the dust bag to the sander.

For a more thorough cleaning of the dust bag, remove dust bag from dust bag frame and shake out dust. Replace dust bag over frame then install dust bag assembly on sander.

## CHANGING THE SANDING SHEETS AND PADS

See Figure 8.

The sander is packed with sanding sheets and pads designed for a variety of uses. To change, simply pull the used sheet or pad off the base and attach the desired sheet or pad by pressing the it onto the base of the sander.

## PAPER PUNCH

See Figure 9.

A paper punch template has been supplied with the sander for aligning and punching holes in sandpaper. The punched holes must align with the holes in the sander pad.

- Install sandpaper on the sander.
- Align the sander pad over the paper punch.
- Push down on the sander.

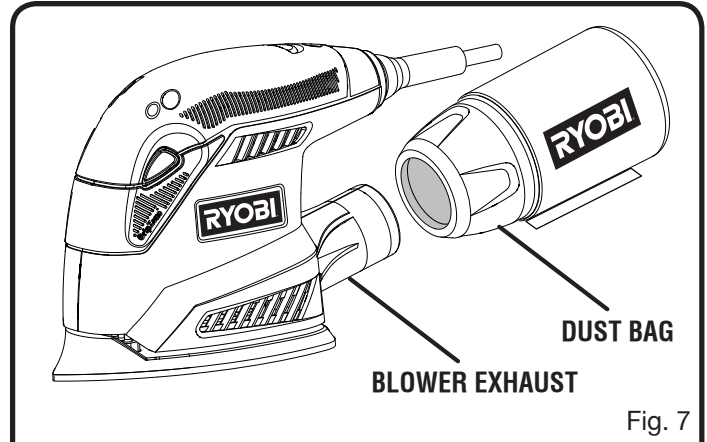

Fig. 7

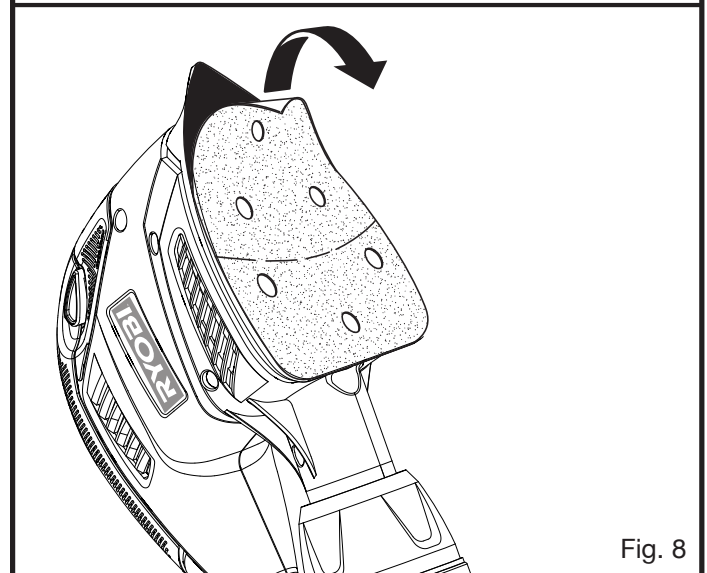

Fig. 8

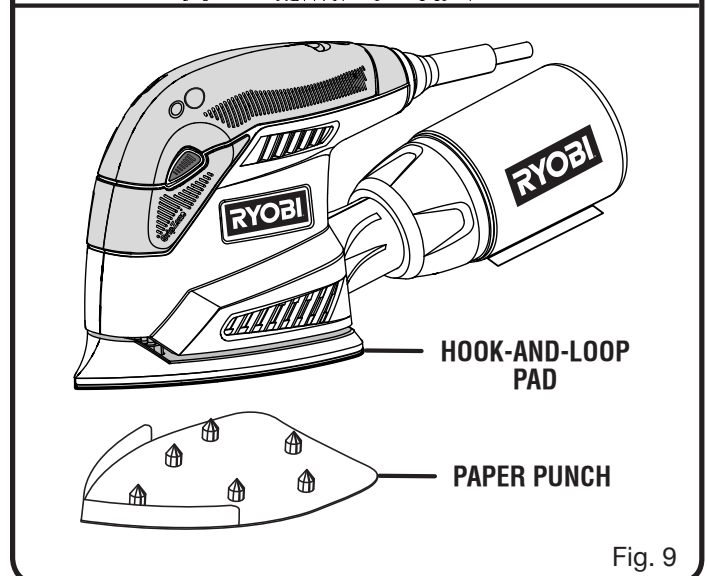

Fig. 9

# OPERATION

## ROTATING THE SANDING SHEETS

See Figure 10.

The majority of wear in a precision sanding application occurs at the tip of the sanding sheet. The unique Tri-Flex design of the sanding sheets allows you to detach and rotate the top two thirds of each, extending the life of the sheet.

To rotate the sheet, simply remove the top two thirds of sanding sheet along the perforation. Rotate the sheet so that a clean corner is located at the tip of the base. Press the sheet firmly onto the sander pad.

**NOTE:** Scrubbing and polishing pads are not perforated and cannot be rotated.

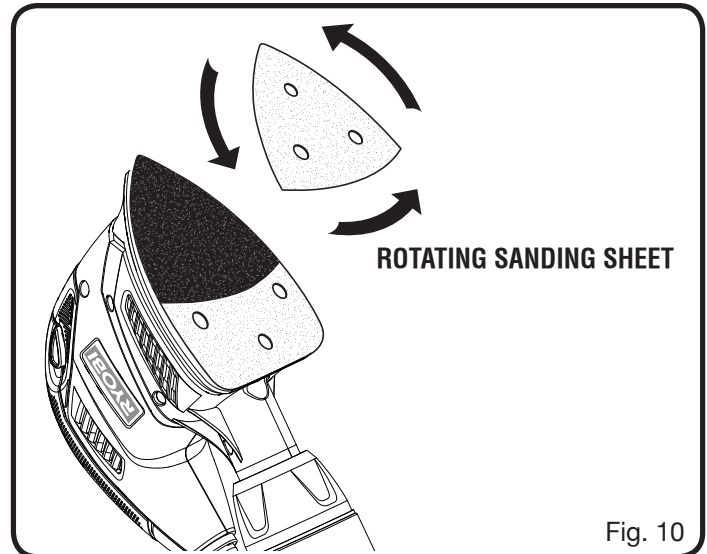

# MAINTENANCE

## **WARNING:**

When servicing, use only identical replacement parts. Use of any other parts may create a hazard or cause product damage.

## **WARNING:**

Always wear safety goggles or safety glasses with side shields during power tool operation or when blowing dust. If operation is dusty, also wear a dust mask.

## GENERAL MAINTENANCE

Avoid using solvents when cleaning plastic parts. Most plastics are susceptible to damage from various types of commercial solvents and may be damaged by their use. Use clean cloths to remove dirt, dust, oil, grease, etc.

## **WARNING:**

Do not at any time let brake fluids, gasoline, petroleum-based products, penetrating oils, etc., come in contact with plastic parts. Chemicals can damage, weaken or destroy plastic which may result in serious personal injury.

Electric tools used on fiberglass material, wallboard, spackling compounds, or plaster are subject to accelerated wear and possible premature failure because the fiberglass chips and grindings are highly abrasive to bearings, brushes, commutators, etc. Consequently, we do not recommend

using this product for extended work on these types of materials. However, if you do work with any of these materials, it is extremely important to clean the product using compressed air.

## LUBRICATION

All of the bearings in this product are lubricated with a sufficient amount of high grade lubricant for the life of the unit under normal operating conditions. Therefore, no further lubrication is required.

## CLEANING THE SCRUBBING PADS

To ensure longer life and optimum performance, periodically clean all residue and foreign materials from the scrubbing pads. This can be done simply by rinsing the pad with warm water until all foreign material has been washed away. After cleaning, gently squeeze the pad to remove excess water and allow pad to dry. Always store pads and sanding sheets flat in a cool, dry location.

## CLEANING THE SANDING SHEETS

The sanding sheets that came with the sander are made to be re-used. Therefore, it is important that they be cleaned periodically to remove sanding residue and foreign material that can accumulate over time.

To clean sanding sheets, rub the sheets with a hard rubber block.

## **WARNING:**

Always remove the scrubbing pad or sanding sheet from sander before cleaning. Failure to do so could cause serious personal injury.





# OPERATOR'S MANUAL

5-1/2 in. CORNER CAT®

**COMPACT FINISH SANDER**

**DOUBLE INSULATED**

**CFS1503**

## WARNING:

Some dust created by power sanding, sawing, grinding, drilling, and other construction activities contains chemicals known to cause cancer, birth defects or other reproductive harm. Some examples of these chemicals are:

- lead from lead-based paints,
- crystalline silica from bricks and cement and other masonry products, and
- arsenic and chromium from chemically-treated lumber.

Your risk from these exposures varies, depending on how often you do this type of work. To reduce your exposure to these chemicals: work in a well ventilated area, and work with approved safety equipment, such as those dust masks that are specially designed to filter out microscopic particles.

## ● PARTS AND SERVICE

Prior to requesting service or purchasing replacement parts, please obtain your model and serial number from the product data plate.

- MODEL NUMBER         CFS1503
- SERIAL NUMBER

## ● HOW TO OBTAIN REPLACEMENT PARTS:

Replacement parts can be purchased online at [www.ryobitools.com](http://www.ryobitools.com) or by calling 1-800-525-2579. Replacement parts can also be obtained at one of our Authorized Service Centers.

## ● HOW TO LOCATE AN AUTHORIZED SERVICE CENTER:

Authorized Service Centers can be located online at [www.ryobitools.com](http://www.ryobitools.com) or by calling 1-800-525-2579.

## ● HOW TO OBTAIN CUSTOMER OR TECHNICAL SUPPORT:

To obtain Customer or Technical Support please contact us at 1-800-525-2579.

RYOBI® is a registered trademark of Ryobi Limited used under license.

## ONE WORLD TECHNOLOGIES, INC.

1428 Pearman Dairy Road, Anderson, SC 29625

Phone 1-800-525-2579

[www.ryobitools.com](http://www.ryobitools.com)

987000-149

06-18-07 (REV:01)



## Free Manuals Download Website

<http://myh66.com>

<http://usermanuals.us>

<http://www.somanuals.com>

<http://www.4manuals.cc>

<http://www.manual-lib.com>

<http://www.404manual.com>

<http://www.luxmanual.com>

<http://aubethermostatmanual.com>

Golf course search by state

<http://golfingnear.com>

Email search by domain

<http://emailbydomain.com>

Auto manuals search

<http://auto.somanuals.com>

TV manuals search

<http://tv.somanuals.com>