

THE
LEADING
BRAND IN THE UK

Russell Hobbs®



Nutritionist®

Programmable Pressure Cooker

OWNER'S MANUAL
RHNPC800P

IMPORTANT SAFEGUARDS

When using electrical appliances, basic safety precautions should always be followed including the following:

1. Read all instructions before using appliance.
2. Do not touch hot surfaces. Use handles or knobs.
3. To protect against fire, electrical shock, and injury to persons, do not immerse Cord, Plug or Pressure Cooker Housing in water or other liquid.
4. Close supervision is necessary when any appliance is used near children. This appliance is not for use by children.
5. Unplug appliance from outlet when not in use and before cleaning. Allow to cool before putting on or taking off parts, and before cleaning the appliance.
6. Do not operate any appliance with a damaged cord or plug or after the appliance malfunctions, or has been dropped or damaged in any manner. Contact Consumer Service.
7. The use of accessory attachments not recommended by the appliance manufacturer may result in fire, electric shock, or injury to persons.
8. Do not use outdoors.
9. Do not let cord hang over edge of table or counter, or touch hot surfaces.
10. Do not place on or near a hot gas or electric burner, or in a heated oven.
11. To disconnect, press the START/STOP Button until the Red STOP Light illuminates and the Pressure Cooker beeps. Then remove plug from wall outlet
12. Do not use appliance for other than intended use.
13. Extreme caution must be used when moving an appliance containing hot oil or other hot liquids.
14. A fire may occur if the appliance is covered or touching flammable material, including curtains, draperies, walls, and the like, when in operation.
15. Do not attempt to dislodge food when the appliance is plugged in.
16. Do not fill the unit above the MAX Fill Line. When cooking foods that expand during cooking, such as rice or dried vegetables, do not fill the unit over 1/2 full. See Cooking with Your Pressure Cooker Section in this manual.
17. Do not cook foods such as applesauce, cranberries, pearl barley, oatmeal or other cereals, split peas, noodles, macaroni, rhubarb, or spaghetti. These foods tend to foam, froth and sputter, and may block the Steam Release Valve.
18. **CAUTION:** To reduce the risk of electric shock, cook only in the Removable Cooking Pot.

SAVE THESE INSTRUCTIONS

FOR HOUSEHOLD USE ONLY

ADDITIONAL IMPORTANT SAFEGUARDS

WARNING: *This appliance generates heat and escaping steam during use. Use proper precautions to prevent risk of burns, fires, or other injury to persons or damage property.*

1. Keep hands and face away from Steam Release Valve when releasing pressure.
2. Use extreme caution when removing the Lid after cooking. Serious burns can result from steam inside.
3. Never remove the Lid while the unit is in operation.
4. Do not use without the Removable Cooking Pot in place.
5. Do not cover the Pressure Valves with anything as an explosion may occur.
6. Do not touch the Removable Cooking Pot, any removable parts, or heating parts immediately after using. Let the unit cool completely first.
7. To reduce the risk of electric shock, cook only in the removable cooking pot. Do not pour liquid into the Housing.
8. Clean all parts thoroughly after each use.
9. Do not lift the Removable Cooking Pot containing food by using Lid Handles.
10. To relieve the pressure of this Programmable Pressure Cooker follow the instructions in this manual for either Quick Steam Release or Natural Steam Release. **DO NOT ATTEMPT TO COOL OR RELEASE PRESSURE USING WATER.**

3-PRONG GROUNDED TYPE PLUG

This appliance is equipped with a grounded type 3-wire cord (3-prong plug). This plug will only fit into an electrical outlet made for a 3-prong plug. This is a safety feature. If the plug should fail to fit the outlet, contact an electrician to replace the obsolete outlet. Do not attempt to defeat the safety purpose of the Grounding Pin part of the 3-prong plug.

SHORT CORD INSTRUCTIONS

A short power supply cord is provided to reduce the risk resulting from becoming entangled in or tripping over a longer cord.

Longer detachable power-supply cords or extension cords are available and may be used if care is exercised in their use.

If a longer detachable power-supply or extension cord is used, (1) the marked electrical rating of the cord set or extension cord should be at least as great as the electrical rating of the appliance, and (2) the cord should be arranged so that it will not drape over the countertop or tabletop where it can be pulled on by children or tripped over accidentally.

The extension cord should be a grounding-type 3-wire cord.

ELECTRIC POWER

If the electric circuit is overloaded with other appliances, your appliance may not operate. It should be operated on a separate electrical circuit.

PLASTICIZER WARNING

CAUTION: To prevent Plasticizers to migrate from the finish of the counter top or table top or other furniture, place NON-PLASTIC coasters or placemats between the appliance and the finish of the counter top or table top.

Failure to do so may cause the finish to darken, permanent blemishes may occur or stains can appear.

A NOTE REGARDING YOUR NUTRITIONIST® by RUSSELL HOBBS® PROGRAMMABLE ELECTRIC PRESSURE COOKER

Congratulations on your purchase of the Nutritionist® Programmable Electric Pressure Cooker featuring a Removable Cooking Pot with a non-stick interior finish. The special coating on the Removable Cooking Pot has been designed to add durability and ease of use and cleaning. It has been specially formulated for selected premium performance appliances.

The interior finish offers increased scratch and abrasion protection, while still maintaining the convenience of non-stick cooking and easy cleaning. It is great for the health conscious, allowing you to cook without fats or oils.

Care and cleaning of your Programmable Electric Pressure Cooker is a snap. Washing or rinsing with warm, soapy water and a sponge or a cloth is all that is needed. Do not use steel wool, course scouring pads or harsh abrasives on any non-stick surface. Not only are they unnecessary, but they may damage the coating.

Introduction

Congratulations! You are about to learn how to cook and prepare delicious, home made meals in a fraction of the time it normally takes, without sacrificing flavor or nutrition. Your Nutritionist® Programmable Pressure Cooker is quick, safe and easy to use. And best of all, it can shorten the traditional cooking time of most foods by up to 70 percent.

1. Your Programmable Pressure Cooker cooks like a traditional Pressure Cooker by combining steam heat and pressure for faster cooking times. Since an air tight seal is formed when the Lid is closed and locked, the heat and steam stay trapped inside the Removable Cooking Pot. As the steam builds and the pressure rises, the cooking temperature will get as hot as 250°F, which is 38°F hotter than when food is cooked in a standard pot with liquid. This combination of high heat and pressure cooks the food faster while retaining water soluble nutrients and flavor.
2. Your Nutritionist® Pressure Cooker takes the guesswork out of cooking under pressure. A built-in Thermostat knows exactly when low or high pressure is reached inside the Removable Cooking Pot and automatically adjusts the heat and triggers the timer to begin. These computerized functions eliminate the need to make heat adjustments, necessary when using a stovetop cooker.
3. The 1500 watt Heating Element allows for quick heating and for maintaining even cooking temperature and pressure.
4. The large, 8-quart capacity, heavy-duty, non-stick, aluminum Removable Cooking Pot heats up quickly and evenly.
5. The Nutritionist® Programmable Pressure Cooker has a BROWN Mode that allows you to sauté or brown food in the Removable Cooking Pot before cooking under pressure.
6. The Quick Steam Release Feature allows you to release pressure with the simple push of a button. Press this RELEASE Button in short bursts to prevent ejection of hot liquid along with steam.
7. The STEAM Mode heats cooking liquid in the Removable Cooking Pot to a boil in a matter of minutes for steaming an endless variety of foods like vegetables and shellfish (as well as rice).
8. The software incorporates a CANCEL feature for both COOK TIME and DELAY TIME during setup. If it becomes necessary to cancel or reset the time before cooking has begun, simply press the COOK TIME and START/STOP Buttons simultaneously to reset the Cook Time to "01"; or press the DELAY TIME and START/STOP Buttons simultaneously to reset the Delay Time to "00".
9. The WARM Mode holds and keeps cooked food warm for an unlimited period of time.
10. The sturdy, brushed stainless steel and molded Housing of your Nutritionist® Programmable Pressure Cooker is both attractive and functional.

Getting to Know Your Nutritionist® RHNPC800P Programmable Electric Pressure Cooker

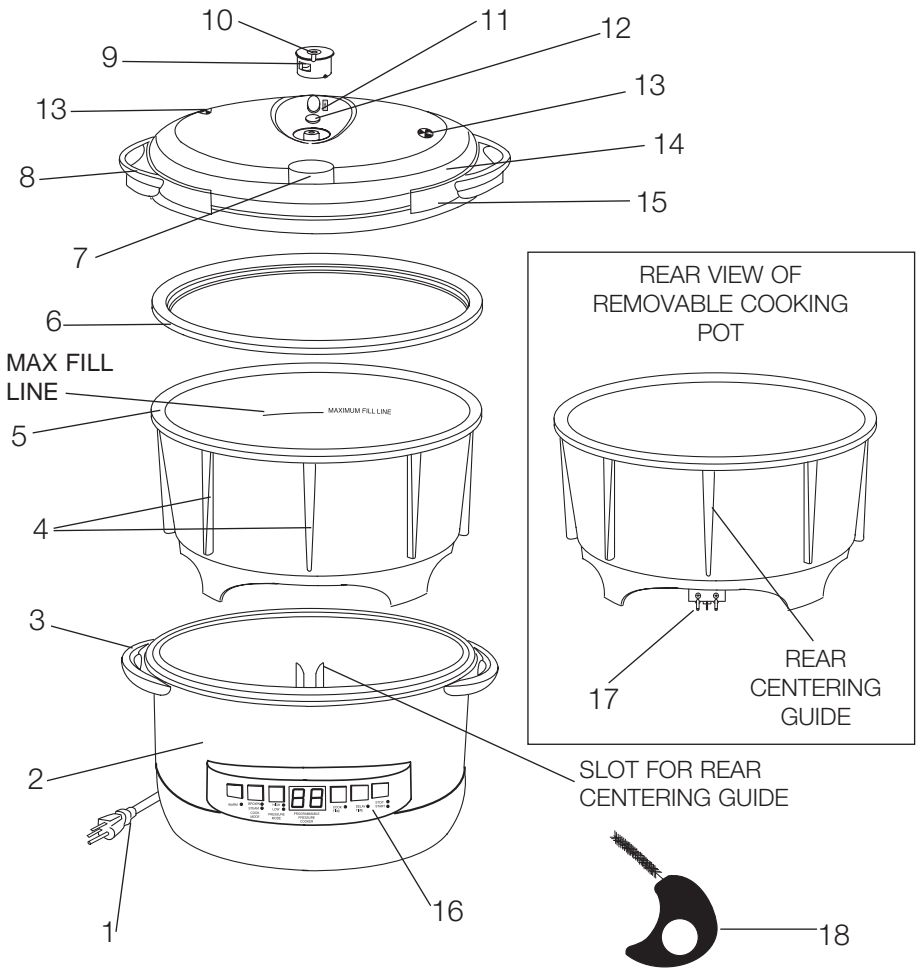

- | | |
|---|----------------------------------|
| 1. Power Cord and Plug | 10. Steam Release Valve |
| 2. Housing | 11. Safety Lock Button |
| 3. Lower Handles | 12. Pressure Indicator Rod |
| 4. Centering Guides | 13. Pressure Safety Valves (2) |
| 5. Removable Cooking Pot
(P/N 21413) | 14. Self Locking Lid (P/N 21320) |
| 6. Rubber Gasket (P/N 21321) | 15. Self Locking Grips |
| 7. QUICK STEAM RELEASE Button | 16. Control Panel |
| 8. Lid Handles | 17. Heating Element Pins |
| 9. Pressure Regulator Knob | 18. Cleaning Brush (P/N 21100A) |

Control Panel Options

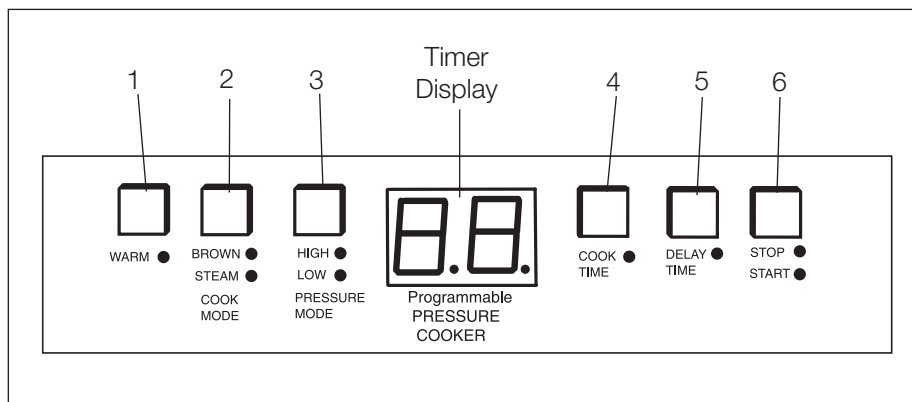

1. **WARM:** The Warm Mode holds and keeps cooked food warm for a long period of time. When you press the WARM Button the Red Indicator Light illuminates. Press START/STOP to activate. The Red Warm Indicator Light will flash, indicating WARM is working. To cancel or stop, press and hold START/STOP Button until the Red Stop Light illuminates and the Pressure Cooker beeps.
2. **COOK MODE (BROWN or STEAM):** For the BROWN Mode, press COOK MODE Button until the Red Indicator Light next to BROWN is lit. Press the START/STOP Button until the Green Start Indicator Light illuminates and the Red Brown Indicator Light flashes. The Clock will Display: "--" indicating that the Pressure Cooker is in the BROWN Mode and the appliance will begin to heat immediately and will remain hot until START/STOP Button is pressed again to end the BROWN Mode.

For the STEAM Mode and to bring water to a boil, press COOK MODE Button until Green Indicator Light next to STEAM is lit. Press COOK TIME Button to enter the cooking time desired. The Cook Time Red Indicator Light will be lit. Then press the START/STOP Button, the Green Start Light illuminates and the Green Steam Indicator Light will flash. The unit will begin to count down in minutes, and will beep 3 times and the STOP Light will illuminate when finished.

3. **PRESSURE MODE (HIGH or LOW):** For cooking food under LOW PRESSURE, press PRESSURE MODE Button until Green Indicator Light is lit; for HIGH PRESSURE, press until Red Indicator Light is lit. Press the COOK TIME Button to select the desired cooking time. The Cook Time Red Indicator Light will be lit. Then press the START/STOP Button to activate, the Green Start Light will illuminate and the Green or Red Pressure Indicator Light will flash.

Control Panel Options (Cont.)

Once pressure is reached, the unit will begin to count down in minutes and will beep 3 times when the cooking time has elapsed. The Pressure Cooker will beep periodically as a reminder that your cooking is completed. To cancel this, press and hold the START/STOP Button until it beeps. Let the pressure drop on its own by using the Natural Release Feature, or release pressure immediately by pressing the QUICK STEAM RELEASE Button in short bursts until pressure is reduced.

WARNING: DO NOT hold the QUICK STEAM RELEASE Button down, as hot liquids may be ejected. Press in short bursts until pressure is reduced.

NOTE: To cancel or stop cooking before time has elapsed, press and hold the START/STOP Button until the Red STOP Light illuminates and the Pressure Cooker beeps.

4. COOK TIME: Use this Timer when using the COOK MODE (STEAM) or the PRESSURE MODE (HIGH or LOW) settings. Press COOK TIME Button to set the desired cooking time.
5. DELAY TIME: Allows you to begin cooking food up to two hours later in 1/2 hour increments.
6. START/STOP: After choosing the desired modes: WARM, COOK MODE: (BROWN or STEAM), or PRESSURE MODE: (HIGH or LOW), and if appropriate, the COOK TIME, press the START/STOP Button to begin operating the appliance. The Green Indicator Light will be lit when START is chosen. The Red Indicator Light will illuminate for STOP. If you wish to change your selection, or to stop the appliance, press and hold START/STOP until the Red STOP Indicator Light illuminates and the Pressure Cooker beeps.

This Pressure Cooker has an idle mode. If you input a COOK TIME and/or DELAY TIME, but forget to select a program or if you forget to press START, the clock will display "--" after 5 seconds. This feature is for your convenience to show that the program is incomplete. The "--" signal indicates that the Pressure Cooker is not programmed properly and will not run. You can proceed with the program where you left off by pressing the COOK TIME or DELAY TIME Button. Your selected time will reappear. If this time does not appear, or if it is incorrect, simply enter the correct time and then press the START/STOP Button.

Instructions for Use

BEFORE USING FOR THE FIRST TIME

1. Before using the Programmable Pressure Cooker for the first time, wash the Removable Cooking pot, the Self-Locking Lid and the Rubber Gasket with warm soapy water. Rinse with clear water and dry thoroughly.
2. Make sure the Rubber gasket is seated properly around the Lid. To ensure correct fitting of the Rubber Gasket, fill the Removable Cooking Pot 2/3 full with water and run on HIGH PRESSURE for 15 minutes. Wait 15 minutes, then release pressure by pressing on the QUICK STEAM RELEASE Button in short bursts. The Pressure Indicator Rod will drop. Let the appliance cool to room temperature. Pour out the water. Rinse and towel dry the Removable Cooking Pot. The Pressure Cooker is now ready to be used.

BEFORE YOU BEGIN COOKING EACH TIME

For best results, always check that the Pressure Regulator knob, Pressure Indicator, Steam Release Valve and Safety Valves are in good working order and that there are no foreign particles blocking the Valve openings on the underside of the Lid. See Care and Cleaning Instructions.

IMPORTANT: The Rubber Gasket must be placed properly over the four hooks in the Lid as shown.

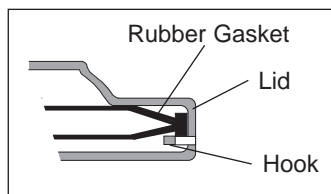

POWER SURGE PROTECTION FEATURE

This Pressure Cooker has a Back-up Feature to prevent malfunction in the event of power surges. If the Pressure Cooker is unplugged or switched off, allow at least 30 seconds for the program to clear before turning the unit back on.

NON-STICK SURFACE

Be sure to always use either plastic or wooden utensils so as not to scratch the non-stick surface. Never use metal tongs, forks, or knives as they can damage the coating on the Removable Cooking Pot.

Operating Instructions

1. Plug the cord into a grounded-type 120V AC electrical wall outlet.
2. Position the Removable Cooking Pot in the Housing so that its Rear Centering Guide slides into the Slot for Centering Guide on the inside of the Housing.
3. Choose the desired program by pressing either WARM, COOK MODE: (BROWN or STEAM), or PRESSURE MODE: (HIGH or LOW).

Operating Instructions (Cont.)

4. If using COOK MODE: (STEAM), or PRESSURE MODE: (HIGH or LOW), press COOK TIME until the desired time is set.
5. THE SELF-LOCKING LID MUST BE POSITIONED ON THE APPLIANCE WHEN COOKING UNDER PRESSURE OR WHEN STEAMING FOOD.

6. Place the Lid on the Pressure Cooker. To position and lock the Lid in place, pull the Lid Handles apart to hold open the Self-Locking Grips. See Figure 1. Place the Lid on top of the Removable Cooking Pot and release the Lid Handles so that the Self-Locking Grips close onto the rim of the Removable Cooking Pot.

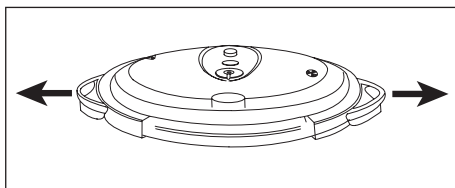

Figure 1

7. To cook under Pressure, slide the Safety Lock to the LOCK position. See Figure 2. Turn the Pressure Regulator Knob to Pressure (see Figure 3).
8. To steam food, leave the Safety Lock in the UNLOCK position. Turn the Pressure Regulator Knob to STEAM.
9. Press the START/STOP Button to illuminate the Green Indicator Light and to begin cooking. The Pressure Cooker will beep three times at the end of the cooking time and the STOP Light will automatically illuminate.
10. Press and hold the START/STOP Button until it beeps, and the Red Indicator Light is lit. Otherwise the Pressure Cooker will beep periodically as a reminder that your cooking is completed.

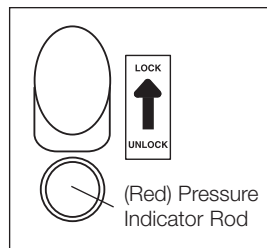

Figure 2

11. PRESSURE MUST BE FULLY RELEASED BEFORE OPENING THE LID. The Pressure Indicator Rod will be UP when the Pressure Cooker is under pressure, and DOWN when the pressure is released. After all pressure has been released, slide the Safety Lock to the UNLOCK position. Grasp the Lid Handles and pull out simultaneously to unclamp the Self-Locking Grips from the rim of the Removable Cooking Pot.
12. Allow the appliance to cool before cleaning. After it has cooled, unplug it from the wall outlet. Clean by following the Care and Cleaning Instructions in this manual.

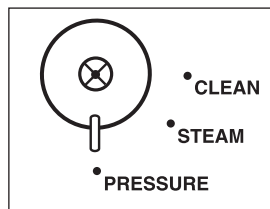

Figure 3

Cooking with Your Nutritionist® Programmable Electric Pressure Cooker

WARMING

This Mode reheats or keeps cooked food warm for an indefinite period of time. This program can either be used on its own or in conjunction with COOK MODE: STEAM or PRESSURE MODE: HIGH or LOW to keep food warm after cooking.

1. Place cooked food in the Removable Cooking Pot. Press WARM Button. The Red WARM Indicator Light will be lit. To start program, press START/STOP Button. The Green START Indicator Light will be lit and the Red WARM Indicator Light will flash.
2. If you would like to keep food warm after steaming or cooking with pressure, select COOK MODE: STEAM or PRESSURE MODE: HIGH or LOW. Set COOK TIME, then press the WARM Button. Press the START/STOP Button to begin the cooking process. The Red WARM Indicator Light will flash as the appliance automatically goes into the WARMING Mode after cooking. To end program or to reset, press and hold the START/STOP Button until it beeps and the Red Indicator Light is lit.

BROWNING

Braised foods often taste better when browned before cooking in liquid. The RHNPC800P Programmable Pressure Cooker has a built-in BROWN Mode.

For best results, food should be patted dry with paper towels and cut into small, uniform pieces. Brown or sauté food in small batches.

1. Place the Removable Cooking Pot into the Housing. Add the appropriate amount of oil as called for in the recipe. With the Lid off, press the COOK MODE Button for BROWN. The Red Indicator Light next to BROWN will be lit.
2. Press the START/STOP Button. The Green Indicator Light will be lit and the BROWN Mode Red Indicator Light will begin to flash. After approximately one minute of preheating, add food and begin browning.
3. During the BROWN Mode, the Pressure Cooker will beep 3 times every 10 minutes as a warning that this is a high temperature setting.
4. There is no time setting for the BROWN Mode. When desired browning is complete, press the START/STOP Button until it beeps and the Red Stop Indicator Light illuminates.

WARNING: Do not leave the Pressure Cooker unattended while browning foods.

Cooking with Your Pressure Cooker (Cont'd.)

STEAMING

This Mode quickly brings cooking liquid to a boil for steaming food.

1. Place the Removable Cooking Pot into the Housing.
2. To Steam food, pour 1-cup of water into the Removable Cooking Pot. Arrange food in a heat resistant steaming basket and use basket handles to lower basket into the Removable Cooking Pot. Fold handles down. (You may add more food on top of and around basket, but do not fill more than two thirds full.)
3. Place the Self-Locking Lid onto the Removable Cooking Pot. Keep the Safety Lock in the UNLOCK position. Turn the Pressure Regulator Knob to STEAM.
4. Press the COOK MODE Button for STEAM. The Green Indicator Light next to STEAM will be lit.
5. Press COOK TIME Button for the desired cooking time. Press the START/STOP Button; the Green Indicator Light will be lit and the Green STEAM Indicator Light will blink slowly and then faster as the temperature increases and the liquid comes to a boil.
6. The Lid can be opened while cooking to check the food.

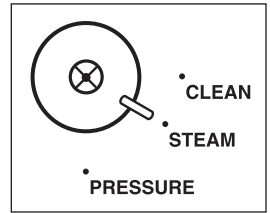

CAUTION: *Never place your face over the Pressure Cooker when removing the Lid.*

WARNING: *Use caution when opening Lid. Steam escapes as soon as the Lid is opened. Use oven mitts when handling hot materials.*

7. The Red Indicator Light will illuminate and the appliance will beep three times at the end of the preset cooking time. Press and hold START/STOP Button until it beeps.

NOTE: To cancel or stop cooking time before time has elapsed, press and hold the START/STOP Button until the Red STOP Light illuminates and the Pressure Cooker beeps.

PRESSURE COOKING

By cooking in the Nutritionist® Programmable Pressure Cooker at high temperature and pressure you are able to reduce the cooking time of most foods by up to 70 percent.

1. Place the Removable Cooking Pot in the Cool-to-the-Touch Housing. Brown ingredients, if you wish, then add remaining ingredients.
2. Add at least 1 cup (8 ounces) of liquid to the Removable Cooking Pot when cooking under pressure. Do not fill the Removable Cooking Pot more than one-third full when cooking dried beans and legumes; no more than half full when cooking soups and stews; and no higher than the MAX Fill Line when cooking vegetables or whole pieces of meat.

Cooking with Your Pressure Cooker (Cont.)

- Place the Self-Locking Lid on the Pressure Cooker. Slide the Safety Lock to LOCK position.
- Turn the Pressure Regulator to PRESSURE.
- Press the PRESSURE MODE Button for HIGH or LOW, as called for in the recipe. Typically, most foods are cooked under HIGH pressure.
- Press COOK TIME for the cooking time called for in the recipe or recommended in the Suggested Cooking Times Section of this manual. The cooking time begins from the moment pressure is reached and does not include the time it takes for the Pressure Cooker to come up to the selected pressure.
- Press START/STOP Button until the Green Indicator Light appears. If cooking under HIGH PRESSURE, the Red Indicator Light will blink slowly; the Green Indicator Light blinks when cooking under LOW PRESSURE. The Lights will blink faster as pressure builds and the cooking countdown begins.
- The Pressure Indicator Rod will rise as pressure builds. After cooking under pressure for the desired programmed time, the Pressure Cooker will beep three times and the Red STOP Light will illuminate. Press and hold the START/STOP Button until it beeps.
- Quick Steam Release/Natural Steam Release. After cooking is completed, you MUST release pressure using either the Natural Steam Release or Quick Steam Release feature.
- The Natural Release Feature is preferred when cooking foods like stocks, sauces, and certain large cuts of meat which will benefit from continued cooking in the Pressure Cooker as the pressure and temperature drop naturally as the unit cools. DO NOT use with foods that can over-cook easily and quickly. When pressure is completely released, the Pressure Indicator Rod will drop.
- To release pressure immediately after cooking, use the Quick Steam Release Feature. Press the QUICK STEAM RELEASE Button in short bursts only, until pressure is reduced – steam will stop coming out of the Steam Release Valve and the Pressure Indicator Rod will drop.

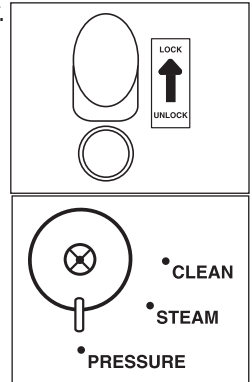

CAUTION: Escaping steam is very hot. To avoid serious injuries or burns, keep bare skin, face and eyes away from the Steam Release Valve.

CAUTION: When preparing recipes with a high volume of liquid, some liquid may spurt through the vent when you use the Quick Steam Release Feature. If this happens, allow the pressure to come down naturally, or wait for a minute, then resume releasing the steam in very short bursts.

Cooking with Your Pressure Cooker (Cont.)

PRESSURE COOKING (Continued)

12. Once pressure is released, regardless of method, slide the Safety Lock to UNLOCK. Remove the Lid, tilting it away from you to avoid steam. Check the food to see if it has been cooked sufficiently. If not, replace the Lid and slide the Safety Lock to LOCK. Repeat PRESSURE COOKING Steps 4-8, cooking under pressure an additional 2 to 3 minutes.
13. To pressure cook foods like vegetables, add water to the Removable Cooking Pot. Place a small heat resistant steaming rack or basket (NOT INCLUDED) in the Removable Cooking Pot. Place the food on the rack. For best results, do not overfill or pack the food down. Follow the same procedure for cooking under pressure, see PRESSURE COOKING Steps 3-8. Use the Quick Steam Release Feature for releasing the pressure.
14. Since steam is hotter than boiling water, always take care when opening the appliance after cooking under pressure. Never place your face over the Pressure Cooker when removing the Lid. Also, be aware that hot, boiling liquid increases in volume when under pressure.

CAUTION: Never attempt to open the Pressure Cooker before the red Pressure Indicator Rod has dropped.

When opening the Pressure Cooker after making soups and stock, let the food sit several minutes before releasing the pressure and removing the Lid to make sure the hot liquid will not boil over.

15. Since overcooked food cannot be corrected, it is advisable to err on the undercooked side by cooking an unfamiliar food for a shorter period of time than you may think necessary. You can always go back and continue cooking under pressure a minute or two longer if need be (see PRESSURE COOKING Steps 4-8).
16. It is easy to adapt your favorite recipe for use in the Nutritionist® Programmable Pressure Cooker. For the most part, soups, stews, braised and slow roasted meats and legumes, steamed and braised vegetables, and slow-simmered recipes like tomato sauce, provide the best results. Instructions and timing charts for cooking commonly prepared foods under pressure can be found in the following Section.

Bear in mind that the amount of cooking liquid used when adapting a recipe will be much less since you will be cooking in a sealed pot for a much shorter time. You must, however, use sufficient liquid, since the Pressure Cooker is constantly building steam during the entire cooking process. If you run out of liquid, and continue cooking, the food will not cook properly and may burn. While there is no universal guide for adapting recipes, trial and error will come into play until you understand how a Pressure Cooker cooks.

When adapting other pressure cooker recipes, use the HIGH PRESSURE Mode and cook for the shortest amount of time you expect it might take. If food is not fully cooked, replace the Lid, and slide the Safety Lock to the LOCK position. Repeat PRESSURE COOKING Steps 4-8, cooking under pressure until done.

Cooking with Your Pressure Cooker (Cont.)

PRESSURE COOKING (Continued)

17. Never try to force open the Self-Locking Lid. Built-in Safety Valves prevent opening the Lid while there is still pressure in the Removable Cooking Pot. All pressure and steam must first be released as explained in PRESSURE COOKING Steps 10 and 11.
18. **WARNING: Never deep-fry or pressure-fry in the Nutritionist® Programmable Pressure Cooker, regardless of whether the Lid is on or off. THIS IS DANGEROUS AND CAN CAUSE A FIRE AND SERIOUS DAMAGE.**
19. Do not cook dumplings or other foaming ingredients under pressure without adding oil. Oil controls foaming and diminishes the possibility that a particle of food will block the safety devices.

NOTE: To cancel or stop cooking time before time has elapsed, press and hold the START/STOP Button until the Red STOP Light illuminates and the Pressure Cooker beeps.

DELAY TIME

1. You can postpone cooking for up to two hours by using the DELAY TIME in conjunction with the WARM, COOK MODE: STEAM, and PRESSURE MODE: HIGH or LOW programs. It can be set in 1/2 hour increments.
2. After selecting the desired cooking program and cooking time, press the DELAY TIME Button for delay time desired.
3. Press START/STOP Button until the Green Indicator Light appears. The appliance will begin cooking after the set time has elapsed.
4. Do not use the DELAY TIME function when cooking perishable foods that may spoil if left out at room temperature.

FREQUENTLY ASKED QUESTION

Question

What happens if the Timer Display is NOT counting down the time?

Response

During the Pressure Modes: Hi or Low, the Timer begins counting down AFTER proper pressure has been reached. It counts actual "pressured cooking" time.

Cooking Times and Basic Instructions

In the following pages you'll find all the information you need for preparing a wide variety of ingredients in your Nutritionist® Programmable Electric Pressure Cooker.

NOTE: Unlike the microwave, pressure-cooking time does not increase when quantity increases. In other words, whether you cook 1 pound or 2 pounds of chicken drumsticks, timing will remain 12 minutes.

The only exception to this rule is when the size of individual ingredients increase. For example, a 3-pound pot roast takes 60 minutes while a 5-pound pot roast takes 80 minutes, and a large potato takes longer to cook than a small potato.

MEATS APPROXIMATE COOKING TIMES

FOOD	MINUTES UNDER HIGH PRESSURE
CHICKEN	
4-4 1/2 pound whole broiler	22-25
bone-in thighs/drumsticks	12
boneless thighs	10
bone-in split breasts	10
boneless breast cutlets, 3/4" wide strips	6
CORNISH HENS	
Whole, 1 1/4 to 1 1/2 pounds	10
TURKEY	
Drumsticks/thighs, 1 1/4 pounds	30
ground	3
BEEF	
Pot Roast, 5-pound boneless chuck	80 plus NPR
Brisket, 4 1/2 pounds boneless	70 plus NPR
Corned Beef, 3 pounds	70 plus NPR
Short Ribs, 2 inches thick	35 plus NPR
Stew Meat, 1-inch chunks	20 plus NPR
Stew Meat, 1/2-inch bits	15
Oxtails, 2-inch lengths	45 plus NPR
Meatballs, about 1-inch diameter	3
LAMB	
Shanks, 1 1/4 to 1 1/2 pounds each	20 plus NPR
Shoulder/leg, 1 1/2-inch chunks	18-20
PORK	
Picnic Shoulder, 4 to 4 1/2 pounds	60
Shoulder, butt, or loin, 1-inch cubes	10
Spare Ribs, 2-rib pieces	25-30
Chops, about 1-inch thick	10

*NPR stands for Natural Pressure Release.

Cooking Times and Basic Instructions (Cont.)

BASIC RECIPE FOR MEAT AND POULTRY

1. Brown meat, if desired.
2. Pour 1 cup water or broth into Pressure Cooker for meats that cook for less than 45 minutes. Increase to 1-1/2 cups liquid for meats that cook more than 45 minutes.
3. Add meat and remaining ingredients.
4. Set Pressure Mode to HIGH and set COOK TIME as suggested below. Press START/STOP Button to begin operation.
5. When the Pressure Cooker beeps, quickly release remaining pressure by pressing QUICK STEAM RELEASE Button in short bursts.

NOTE: WHEN COOKING BEEF, please use the Natural Steam Release for optimum tenderness.

NOTE: When using these suggested cooking charts, use the Quick Steam Release Feature except when otherwise indicated. Natural Steam Release will be indicated by the initials NPR.

VEGETABLES

- Peel vegetables when appropriate, or scrub them well. Keep in mind that hard vegetables such as potatoes and beets hold their shape better when the peel is left intact.
- Vegetables may be cooked whole or chopped into pieces. The larger the piece, the longer it will take to cook.
- Vegetables with the same cooking time may be cooked together.
- Since quick-cooking vegetables like asparagus and broccoli may easily be overcooked, it is best to steam rather than pressure-cook them.

BASIC RECIPE FOR VEGETABLES

1. Trim and cut vegetables according to sizes suggested below.
2. Pour 1 cup water into Pressure Cooker.
3. Arrange vegetables in steaming basket and lower into Pressure Cooker. (Alternatively cook vegetables directly in water or broth.)
4. Set Pressure Mode to HIGH and set COOK TIME as suggested below. Press START/STOP Button to begin operation.
5. When Pressure Cooker beeps, ALWAYS Quickly release pressure by pressing QUICK STEAM RELEASE Button in short burst.
6. If vegetables require more cooking, steam until done.

Cooking Times and Basic Instructions (Cont)

VEGETABLES APPROXIMATE COOKING TIMES

VEGETABLES	MINUTES UNDER HIGH PRESSURE
Artichokes	
large, 6 to 9 ounces each	6 to 9
baby, 1 ounce each	3 to 4
Beets	
large whole, 5 ounces each	22
small whole, 3 ounces each	13
1/4-inch slices	4
Carrots	
large, 2-inch chunks	5
1/4-inch slices	1
Collards	
coarsely chopped	5
Onions	
small, white (2 ounces each), whole	4
Parsnips	
1-inch chunks	3
1/4-inch slices	1
Potatoes	
Russet or Yukon gold, large (8-oz), halved	15
Russet or Yukon gold, large, quartered	7
Russet or Yukon gold, 1-inch chunks	5 to 6
New, medium (2 ounces), whole	8
New, small, whole	5
Sweet, large, quartered	5 to 7
Sweet, 1-inch chunks	4 to 5
Rutabaga	
1-inch chunks	5
Squash	
Acorn (2 pounds.), halved	7
Pattypan (2 pounds), whole	10
Winter, 1 1/2-inch chunks	3
Turnips	
large (4 ounces), quartered	3
small, (1 1/2 ounces), whole	7
1-inch chunks	2

Cooking Times and Basic Instructions (Cont.)

BEANS

Pressure-cooked beans are tender in record time. But since they can't be counted on to hold their shape, plan to use pressure-cooked beans for soups or stews rather than for bean salads.

GENERAL TIPS FOR COOKING BEANS

- Set dried beans in a strainer or colander and rinse well. Discard any broken beans.
- Pre-soaking beans is optional, but encourages more even cooking and aids digestibility. If time permits, soak beans in ample water to cover for 6 to 8 hours or overnight. Drain and rinse. Cook beans in fresh water.
- If you wish, add some onion, bay leaves, and garlic to flavor the beans and broth. Strained bean broth may be used as a base for soups and stews.
- Since the time required to cook beans varies from batch to batch, it is best to do the majority of cooking under pressure and then finish off the beans by cooking them uncovered on the BROWN setting.
- Add salt during the final few minutes of cooking. Adding salt at the beginning may harden bean skins and prevent proper cooking.
- Leftover beans may be frozen in convenient portion sizes.

PRECAUTIONS WHEN COOKING BEANS

- When cooking beans alone (rather than in a soup or stew), never fill Pressure Cooker more than one-third full.
- Always add at least 2 teaspoons of oil per cup of dried beans to control foaming action.
- Let the pressure come down naturally to avoid ejecting liquid from the vent and to prevent bean skins from splitting.
- Take great care when removing the Lid as there will be considerable steam in the Pressure Cooker.
- Clean the Pressure Regulator Knob, Steam Release Valve, Safety Valves and Rubber Gasket thoroughly after cooking beans.

BASIC RECIPE FOR BEANS

This recipe calls for 1 pound (about 2 1/2 cups) dried beans which will yield 5 to 6 cups cooked beans. You may cut this recipe in half, if you wish, but **DO NOT COOK MORE THAN THIS AMOUNT.**

- 1 pound beans, picked over and rinsed (preferably pre-soaked; see above)
- 2 quarts water
- 2 tablespoons vegetable oil
- 1 onion, peeled and halved (optional)
- 2 bay leaves (optional)
- 2 or 3 cloves garlic, peeled and crushed (optional)
- Salt to taste (add after cooking under pressure)

Cooking Times and Basic Instructions (Cont.)

BASIC RECIPE FOR BEANS (Continued)

1. Place beans, water, oil, and any optional ingredients in the Removable Cooking Pot.
2. Pull Lid Handles apart and set Lid on Cooker. Slide Safety Lock to LOCK position. Point Pressure Regulator Knob to PRESSURE.
3. Set Pressure Mode for HIGH and COOK TIME according to type of bean (see following chart). Press START/STOP Button to begin operation.
4. When Pressure Cooker beeps three times, STOP Light will illuminate. If time permits, allow pressure to come down naturally until the red Pressure Indicator Rod drops, about 30 minutes. Otherwise, allow pressure to come down naturally for 20 minutes and quick-release remaining pressure by pressing QUICK STEAM RELEASE Button in short bursts.
5. Slide Safety Lock to UNLOCK. Pull Handles apart and remove Lid.

CAUTION: WHEN REMOVING LID, STEP BACK AND TILT LID AWAY FROM YOU TO AVOID STEAM.

6. Add salt to taste. If beans are still quite hard, return to high pressure for a few more minutes. If beans require just a little more cooking, press the COOK MODE Button for BROWN. The Red Indicator Light next to BROWN will be lit. Then press the START and cook uncovered until done. Stir in more water if cooking liquid becomes very thick.
7. If time permits, allow beans to cool in cooking liquid.
8. Ladle beans into a colander set over a large bowl. Drain beans thoroughly. Remove bay leaves. Reserve cooking liquid for use as broth, if you wish.

BEANS APPROXIMATE COOKING TIMES

BEANS	MINUTES UNDER HIGH PRESSURE
Large beans, such as chickpeas, favas, and black soy beans	
SOAKED	10 plus NPR*
UNSOAKED	20 plus NPR*
Medium beans, such as red kidneys, Great Northern, and black beans	
SOAKED	3 plus NPR*
UNSOAKED	6 plus NPR*
Small beans, such as pinto, navies, and baby limas	
SOAKED	2 plus NPR*
UNSOAKED	4 plus NPR*

*NPR stands for Natural Pressure Release. If time permits, allow pressure to come down all the way, about 30 minutes. Otherwise, allow pressure to come down for 20 minutes and quickly release remaining pressure by pressing the QUICK STEAM RELEASE Button in short bursts.

Cooking Times and Basic Instructions (Cont.)

GRAINS

Whole grains cook so quickly in the Pressure Cooker that they can become a regular part of your diet. Here are a few things to keep in mind:

- Timing varies from one batch of grains to the next, depending upon age and storage conditions. So it is wise to do the majority of cooking under pressure and then do any additional cooking, if needed, on the STEAM setting. Remember that whole grains such as wheat berries and brown rice always remain a bit chewy, even when thoroughly cooked.
- Grains that have the same cooking time may be cooked together.
- Leftover grains may be frozen in convenient portion sizes. Defrost them in the microwave.

PRECAUTIONS WHEN COOKING GRAINS

- When cooking grains alone (rather than in a soup or stew), never fill Pressure Cooker more than one-third full.
- *TO CONTROL FOAMING AS GRAINS COOK, ALWAYS ADD 1 TABLESPOON OF OIL PER CUP OF DRIED GRAINS TO THE COOKING LIQUID.*
- Do not cook more than 2 cups of dried grains at a time.
- Clean the Pressure Regulator Knob, Steam Release Valve, Safety Valves and Rubber Gasket thoroughly after cooking grains.

GRAINS APPROXIMATE COOKING TIMES

GRAIN	MINUTES UNDER HIGH PRESSURE
Brown rice (Short and long grain)	12
Wheat Berries	15
Rye Berries	15
Kamut	15
Wild Rice	20

Cooking Times and Basic Instructions (Cont.)

BASIC RECIPE FOR GRAINS

This recipe calls for cooking grains in a fair amount of water, then draining off the excess. This approach accommodates the fact that no two batches of grains absorb the same amount of liquid. This recipe calls for 2 cups of dry grain which yields about 4 1/2 cups cooked. You may cut this recipe in half, if you wish, but **DO NOT COOK MORE THAN THIS AMOUNT.**

2 cups grains

6 1/2 cups water

2 tablespoons taste-free oil, such as canola

1/2 teaspoon salt (optional)

1. Place grains, water, oil, and salt (if using) in the Removable Cooking Pot.
2. Pull Lid Handles apart and set Lid on Pressure Cooker. Slide Safety Lock to LOCK position. Point Pressure Regulator Knob to PRESSURE.
3. Set Pressure Mode for HIGH and COOK TIME according to type of grain (see previous chart). Press the START/STOP Button to begin operation.
4. When Pressure Cooker beeps three times, STOP Light will illuminate.
5. Quickly release pressure by pressing QUICK STEAM RELEASE Button in short bursts. If liquid spurts from the regulator vent, wait a few seconds before continuing to release pressure.
6. If grains are not sufficiently tender, add a bit more water if mixture seems dry, and steam until done.
7. Use a ladle to transfer grains to a colander to drain. Bounce colander up and down a few times to release excess liquid. For drier, fluffier grains, transfer grains to a bowl and cover tightly with plastic wrap. Set aside for 10 minutes, then fluff.

FRUIT

The Pressure Cooker is good for stewing dried fruits or making quick compotes. You can also make a variety of recipes using fresh fruit, including whole, stuffed fresh apples, or wine-poached pears.

DRIED FRUIT

- Consult the following chart and use minimum timing for moist dried fruit and maximum timing if fruit is leathery and dry.
- You can mix fruits that have different cooking times if you don't mind that quicker-cooking fruits will become very soft.
- You can combine dried and fresh fruit in a compote, but keep in mind that the fresh fruit is likely to "melt down" into a sauce.
- If you wish, add a few tablespoons of fruit liquor before or after cooking.
- Do not cook dates under pressure as they dissolve into mush.
- Do not fill Pressure Cooker more than half full.

Cooking Times and Basic Instructions (Cont.)

DRIED FRUIT APPROXIMATE COOKING TIMES

DRIED FRUIT	MINUTES UNDER HIGH PRESSURE
Apple rings or slices	0*
Apricots	1
Figs	3 to 4
Peaches	3 to 4
Pears	4 to 5
Prunes	1 to 2
Raisins	1

*Set COOK TIME for 1 minute, but as soon as Pressure Indicator Rod comes up, press STOP Button and allow pressure to come down naturally.

BASIC RECIPE FOR DRIED FRUIT

4 cups dried fruit

3 cups water

A few thin slices lemon (optional)

1. Place fruit, water, and lemon (if using) in Removable Cooking Pot.
2. Pull Lid Handles apart and set Lid on Cooker. Slide Safety Lock to LOCK position. Point Pressure Regulator Knob to PRESSURE.
3. Set Pressure Mode for HIGH and COOK TIME according to type of fruit (see chart above). Press the START/STOP Button to begin operation.
4. When Pressure Cooker beeps 3 times, STOP Light will illuminate.
5. Press QUICK STEAM RELEASE Button in short bursts to release pressure.
6. If fruit is not sufficiently tender, replace Lid and steam until done.
7. Remove Lid with special care as there will be a fair amount of steam.

Makes 4 cups

Cooking Times and Basic Instructions (Cont.)

FRESH FRUIT

- For best flavor and texture, use ripe fruit that is still firm.
- You can cook fruit in a steaming basket or directly in the liquid.
- When cooking fruit directly in liquid, you may use wine instead of water.
- When cooking stuffed apples and Anjou pears, wrap them in aluminum foil to maintain their shape and keep their skins intact.
- To maintain shape, cook Bosc pears with peels intact; it is easy to slip peels off after cooking.
- When preparing foil-wrapped fruit, do not fill Pressure Cooker more than half full. When preparing unwrapped fruit, do not fill more than one-third full.

FRESH FRUIT APPROXIMATE COOKING TIMES

FRESH FRUIT	MINUTES UNDER HIGH PRESSURE
Apple, large, whole, stuffed, wrapped in foil	12 to 15
Anjou Pear, whole, wrapped in foil	4
Bosc Pear, whole, unwrapped	4
Pear, halved, cooked directly in liquid	1 plus NPR*

*NPR stands for Natural Pressure Release.

BASIC RECIPE FOR FRESH FRUIT

1. Place 1 cup water (or wine) in Removable Cooking Pot.
2. Place fruit either in a steaming basket or directly into liquid.
3. Pull Lid Handles apart and set Lid on Cooker. Slide Safety Lock to LOCK position. Point Pressure Regulator Knob to PRESSURE.
4. Set Pressure Mode for HIGH and COOK TIME according to chart above. Press the START/STOP Button to begin operation.
5. When Pressure Cooker beeps 3 times, STOP Light will illuminate.
6. Quickly release pressure by pressing QUICK STEAM RELEASE Button in short bursts. (If cooking halved pears, allow pressure to come down naturally.)
7. If fruit is not sufficiently cooked, replace Lid and steam until done.
8. Remove Lid with special care as there will be a fair amount of steam.

Care & Cleaning Instructions

1. Unplug and let the Nutritionist® Programmable Pressure Cooker cool to room temperature before cleaning.
2. Wash the Removable Cooking Pot with warm soapy water and a clean, soft cloth or sponge. Rinse off with clean water and dry thoroughly.
3. Remove the Rubber Gasket from the underside of the Self-Locking Lid. Wash both with warm soapy water and a clean, soft cloth or sponge. Rinse off with clean water and dry thoroughly.
4. The Rubber Gasket must always be properly positioned on the underside of the Lid. Check periodically to make sure that it is clean, flexible and not cracked or torn. If damaged, do not use this appliance. Contact the Consumer Service Department toll-free at 1-800-233-9054 for information on purchasing a replacement Gasket, (P/N 21321).
5. Wipe the Housing clean with a damp soft cloth or sponge. Do not pour any liquid into the Pressure Cooker's Housing.
6. Never use harsh chemical detergents, scouring pads or powders on any of the parts or components.
7. Always check that the Steam Release Valve and Pressure Safety Valves are in good working order. After unit is cooled, remove the Lid. Turn the Pressure Regulator Knob to CLEAN and carefully remove. Turn the Lid over and place on table top as shown below. Using the brush supplied, check and remove any food or foreign particles that may be lodged in the Steam Release Valve. Replace the Pressure Regulator Knob before using again.
8. In order to maintain the good performance of your Pressure Cooker, the bottom of the Removable Cooking Pot, in the area of the Sensor Pad, must be cleaned after each use. The Sensor must be free of dirt, food, or residue. To do so, wipe with a soft, damp cloth and be sure to dry thoroughly.
9. Any service requiring disassembly, other than the above cleaning, must be performed by a qualified appliance repair technician.
10. Store the Pressure Cooker with the Lid resting upside-down on the Removable Cooking Pot.

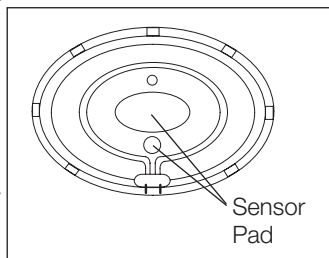
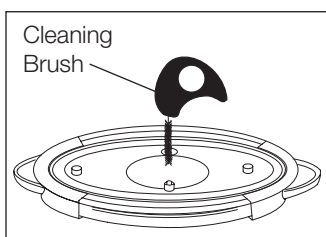
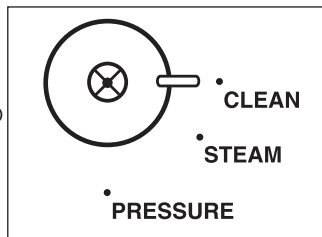

Recipe Guide

These recipes have been created for your 8-quart oval Programmable Pressure Cooker by Lorna Sass, the country's leading authority on pressure cooking. Lorna is author of the best-selling *COOKING UNDER PRESSURE* as well as *GREAT VEGETARIAN COOKING UNDER PRESSURE* and *THE PRESSURED COOK: OVER 75 ONE-POT MEALS IN MINUTES*.

All recipes copyright Lorna Sass, 2001.

CHICKEN BROTH (30 minutes, high pressure)

2 1/2 quarts water
4 pounds chicken backs, necks, wings, and bones, rinsed
3 large ribs celery, halved
2 large carrots
2 large onions, peeled and quartered
A few leek greens (optional)
Small bunch parsley
3 large bay leaves
1 teaspoon black peppercorns

1. Pour water into Pressure Cooker. Press COOK MODE Button until the Red Indicator Light next to BROWN is lit. Press the START/STOP Button until the Green START Indicator Light illuminates and the Red BROWN Indicator Light flashes.
2. As water begins to heat, add remaining ingredients.
3. Pull Lid Handles apart and set Lid on Pressure Cooker. Slide safety Lock to LOCK position. Point Pressure Regulator Knob to PRESSURE.
4. Set PRESSURE MODE for HIGH and COOK TIME for 30 minutes. Press START Button.
5. When Pressure Cooker beeps 3 times, STOP Light will illuminate. If time permits, allow pressure to release naturally (about 20 minutes). Otherwise, quickly release pressure by holding down QUICK STEAM RELEASE Button until red Pressure Indicator Rod drops.
6. Slide Safety Lock to UNLOCK. Pull Lid Handles apart and remove Lid.
7. Cool broth slightly. Ladle into large colander set over a large bowl or storage container. Press solids to release all liquid.
8. Divide broth into storage containers and refrigerate for up to 4 days or freeze for up to 3 months.

Makes about 3 quarts

VEGETABLE BROTH (15 minutes, high pressure)

There's no need to peel any of the vegetables, even the onions and garlic. Just trim and scrub or rinse as needed.

3 quarts water
1 pound carrots
7 ribs celery, halved
3 large onions, quartered
10 cloves garlic
1/2 ounce (1/2 cup loosely packed) dried mushrooms
Small bunch parsley
3 large bay leaves
1/2 teaspoon dried thyme leaves
1/2 teaspoon salt (optional)

1. Pour water into Pressure Cooker. Press COOK MODE Button until the Red Indicator Light next to BROWN is lit. Press the START/STOP Button until the Green START Indicator Light illuminates and the Red BROWN Indicator Light flashes.
2. As water begins to heat, add remaining ingredients.
3. Pull Lid Handles apart and set Lid on Pressure Cooker. Slide Safety Lock to LOCK position. Point Pressure Regulator Knob to PRESSURE.
4. Set PRESSURE MODE for HIGH and COOK TIME for 15 minutes. Press START Button.
5. When Pressure Cooker beeps three times, STOP Light will illuminate. If time permits, allow pressure to release naturally (about 20 minutes). Otherwise, quick-release pressure by holding down QUICK STEAM RELEASE Button until red Pressure Indicator Rod drops.
6. Slide Safety Lock to UNLOCK. Pull Lid Handles apart and remove Lid.
7. Cool broth slightly. Ladle into large colander set over a large bowl or storage container. Press solids to release all liquid.
8. Divide broth into storage containers and refrigerate for up to 4 days or freeze for up to 3 months.

Makes about 3 quarts

SMOKEY BLACK BEAN SOUP (22 minutes, high pressure)

Use either homemade unsalted chicken broth or low-sodium canned as the smoked ham hock and chorizo sausage usually provide sufficient salt for the entire soup.

- 1 tablespoon olive oil
- 3 cups coarsely chopped onions
- 1 tablespoon minced garlic
- 2 teaspoons whole cumin seeds
- 1 tablespoon dried oregano leaves
- 1 tablespoon sweet paprika
- 4 cups water
- 4 cups unsalted or low-sodium chicken broth or additional water
- 1 pound (2 1/2 cups) dried black beans, picked over and rinsed
- 1 meaty smoked ham hock or turkey drumstick
- 1/2 pound chorizo or kielbasa sausage, halved lengthwise, then cut into 1/2-inch slices
- 2 large green bell peppers, seeded and diced
- 3 large bay leaves
- 2 tablespoons dry sherry
- Salt to taste

Optional garnishes: chopped cilantro, diced tomato and/or avocado

1. Press COOK MODE Button until the Red Indicator Light next to BROWN is lit. Press the START/STOP Button until the Green START Indicator Light illuminates and the Red BROWN Indicator Light flashes. Heat oil in Pressure Cooker. Add onions, cook, stirring frequently, for 1 minute. Add garlic, cumin, and oregano. Cook onions about 2 minutes more. Turn off heat, stir in paprika. Immediately transfer onion mixture to a small bowl and set aside.
2. Add water, broth, beans, ham hock, sausage, peppers, bay leaves to Pressure Cooker.
3. Pull Lid Handles apart and set Lid on Pressure Cooker. Slide Safety Lock to LOCK position. Point Pressure Regulator Knob to PRESSURE.
4. Set PRESSURE MODE for HIGH and COOK TIME for 22 minutes. Press START Button.
5. When Pressure Cooker beeps three times, STOP Light will illuminate. Allow pressure to come down naturally for 10 minutes. Quickly release any remaining pressure by holding down QUICK STEAM RELEASE Button until red Pressure Indicator Rod drops.
6. Slide Safety Lock to UNLOCK. Pull Lid Handles apart and remove Lid.
7. Remove ham hock and bay leaves. Stir in onion mixture and sherry. Add salt to taste. Press COOK MODE Button until the Red Indicator Light next to BROWN is lit. Press the START/STOP Button until the Green START Indicator Light illuminates and the Red BROWN Indicator Light flashes. Boil uncovered, stirring occasionally, for 5 minutes (or longer, if needed, for beans to become very tender.)
8. Meanwhile, chop meat from ham hock (there won't be much) and add it to soup. Soup will thicken as it stands, but if you wish to thicken it immediately, mash about a cupful of beans against side of Pressure Cooker, blend mash into soup.
9. Garnish individual portions with cilantro, diced tomatoes and/or avocados, if you wish.

Serves 7 to 8

Adapted from THE PRESSURED COOK, copyright Lorna Sass, 1998. By permission of Harper Collins Publishers, Inc.

MINESTRONE (4 minutes, high pressure)

2 tablespoons olive oil

1/2 pound cremini or button mushrooms, sliced or quartered

1/2 teaspoon salt

1 1/2 cups chopped leeks or onions

2 large cloves garlic, sliced

4 cups chicken or vegetable broth

2 cups water

One 28-ounce can plum tomatoes (with liquid)

1 tablespoon dried Italian herb blend (available in supermarkets, or use
1 teaspoon each dried oregano, basil, and rosemary)

1/4 teaspoon crushed red pepper flakes (optional)

4 ribs celery, halved lengthwise and sliced

4 carrots, cut into 1/2-inch dice

1 pound potatoes, scrubbed and cut into 1/2-inch cubes

4 cups tightly packed chopped cabbage or kale

Salt and freshly ground black pepper to taste

3 tablespoons minced parsley

1/3 cup grated parmesan or romano cheese, plus more to pass at table

1. Press **COOK MODE** Button until the Red Indicator Light next to **BROWN** is lit. Press the **START/STOP** Button until the Green **START** Indicator Light illuminates and the Red **BROWN** Indicator Light flashes. Heat 1 tablespoon oil in Pressure Cooker. Add mushrooms and sprinkle with salt. Cook, stirring occasionally, until mushrooms are lightly browned. Add leeks and garlic and cook until leeks soften slightly, about 2 minutes.
2. Add broth, water, and tomatoes. Break up tomatoes with a large wooden or plastic spoon. Stir in herbs, red pepper flakes (if using), and vegetables. (Don't be concerned if cabbage reaches beyond maximum fill line as it will quickly wilt and shrink.)
3. Pull Lid Handles apart and set Lid on Pressure Cooker. Slide Safety Lock to **LOCK** position. Point Pressure Regulator Knob to **PRESSURE**.
4. Set **PRESSURE MODE** for **HIGH** and **COOK TIME** for 4 minutes. Press **START** Button.
5. When Pressure Cooker beeps three times, **STOP** Light will illuminate. Quickly release pressure by holding down **QUICK STEAM RELEASE** Button until red Pressure Indicator Rod drops.
6. Slide Safety Lock to **UNLOCK**. Pull Lid Handles apart and remove Lid.
7. Stir in additional tablespoon of oil and parsley. Season well with salt and pepper.
8. Serve in large soup bowls. Sprinkle each portion liberally with parmesan and pass remaining parmesan in a bowl.

Serves 6 to 8

MEDITERRANEAN FISH STEW (4 minutes, high pressure)

The vegetables for this stew are quickly cooked under pressure, then chunks of fish are added in the final moments and cooked on the BROWN mode. For optimum taste and visual appeal, use a variety of fish.

2 tablespoons olive oil

1 1/2 cups chopped leeks or onions

1 teaspoon whole fennel seeds (optional)

1/2 cup dry white wine or vermouth

Two 8-ounce bottles clam broth

One 28-ounce can plum tomatoes (with liquid)

1 pound potatoes, scrubbed and cut into 1/2-inch cubes

1 rib celery, diced

1 bay leaf

1 clove garlic, pushed through a press

2 pound fish fillets, such as swordfish, scrod, salmon, or snapper (or a combination), cut into 1-inch chunks

Salt and freshly ground pepper to taste

2 tablespoons chopped parsley

1. Press COOK MODE Button until the Red Indicator Light next to BROWN is lit. Press the START/STOP Button until the Green START Indicator Light illuminates and the Red BROWN Indicator Light flashes. Heat 1 tablespoon oil in Pressure Cooker. Add fennel seeds (if using). Add leeks and cook, stirring occasionally, until leeks soften slightly, about 2 minutes. Add wine and cook until about half evaporates.
2. Add clam broth and tomatoes. Break up tomatoes with a large wooden or plastic spoon. Stir in potatoes, celery, and bay leaf.
3. Pull Lid Handles apart and set Lid on Pressure Cooker. Slide Safety Lock to LOCK position. Point Pressure Regulator Knob to PRESSURE.
4. Set PRESSURE MODE for HIGH and COOK TIME for 4 minutes. Press START Button.
5. When Pressure Cooker beeps three times, STOP Light will illuminate. Quickly release pressure by holding down QUICK STEAM RELEASE Button until red Pressure Indicator Rod drops.
6. Slide Safety Lock to UNLOCK. Pull Lid Handles apart and remove Lid.
7. Remove bay leaf and stir in garlic. Press COOK MODE Button until the Red Indicator Light next to BROWN is lit. Press the START/STOP Button until the Green START Indicator Light illuminates and the Red BROWN Indicator Light flashes. Cook for 1 minute. Add fish, additional tablespoon of oil, and salt and pepper to taste. Cook until fish easily flakes, 2 to 3 minutes. Stir in parsley and serve in large soup bowls.

Serves 4

FRUIT-STUFFED LEMON CHICKEN

(22 minutes, high pressure)

The large size and oval shape of your Pressure Cooker makes it possible to cook a whole, stuffed chicken. Have toothpicks or small skewers on hand for securing the stuffing inside the chicken.

10 dried apricots, halved

8 pitted prunes, halved

3/4 cup seasoned croutons

1 large lemon, cut into thin wedges (discard pits)

One 4- to 4 1/2-pound broiler chicken

Salt and freshly ground pepper

1 tablespoon butter

1 cup chicken broth or water

1/4 teaspoon cinnamon

1 pound carrots, peeled and cut into 2-inch chunks

1 to 2 tablespoons freshly squeezed lemon juice (optional)

Garnish: 2 tablespoons minced parsley

1. In a bowl, toss together apricots, prunes, croutons, 3 lemon wedges.
2. Season chicken inside and out with salt and pepper. Press stuffing inside and close cavity with toothpicks or skewers. (Any extra stuffing may be added along with the carrots in Step 5.)
3. Press COOK MODE Button until the Red Indicator Light next to BROWN is lit. Press the START/STOP Button until the Green START Indicator Light illuminates and the Red BROWN Indicator Light flashes. Add butter to Pressure Cooker and, as it melts, spread with a rubber spatula to coat bottom of Pressure Cooker. Set chicken in Pressure Cooker, breast-side down, and brown well, 3 to 4 minutes. Flip over and brown back.
4. Tilt chicken up slightly, pour in broth. Sprinkle cinnamon lightly over top.
5. Add carrots, remaining lemon wedges, and any leftover stuffing.
6. Pull Lid Handles apart and set Lid on Pressure Cooker. Slide Safety Lock to LOCK position. Point Pressure Regulator Knob to PRESSURE.
7. Set PRESSURE MODE for HIGH, COOK TIME for 22 minutes. Press START Button.
8. When Pressure Cooker beeps three times, STOP Light will illuminate. Quickly release pressure by holding down QUICK STEAM RELEASE Button until red Pressure Indicator Rod drops.
9. Slide Safety Lock to UNLOCK. Pull Lid Handles apart and remove Lid.
10. Check chicken for doneness by cutting deeply into thigh joint. If chicken requires more cooking, replace Lid, press BROWN and START and cook until flesh is thoroughly cooked.
11. Transfer chicken, carrots, lemon wedges, and any loose pieces of stuffing onto serving platter. Reserve in a warm place or cover with foil.
12. To prepare sauce, ladle cooking liquid into a gravy separator. Pour de-fatted liquid into sauce boat and season to taste with salt, pepper, and lemon juice (if using).
13. Garnish chicken with parsley and serve sauce on the side.

Serves 4 to 6

CHICKEN BREAST CACCIATORE (6 minutes, high pressure)

This rustic stew could be a meal on its own, but it's also delicious over spiral pasta.

2 tablespoons olive oil

1 pound cremini or button mushrooms, quartered

1/2 teaspoon salt

2 cups chopped leeks or onions

1/2 cup dry red or white wine

4 1/2 pounds boneless chicken breast cutlets, skinned and cut lengthwise into 3/4-inch-wide strips

2 tablespoons flour

One 28-ounce bottle chunky pasta sauce

2 large green bell peppers, seeded and cut into 1-inch strips

One 6-ounce can pitted ripe black olives, drained

1/4 cup chopped parsley

Salt and freshly ground pepper to taste

Garnishes: 1/2 cup grated parmesan cheese, plus additional to pass at the table and 3 tablespoons additional chopped parsley

1. Press COOK MODE Button until the Red Indicator Light next to BROWN is lit. Press the START/STOP Button until the Green START Indicator Light illuminates and the Red BROWN Indicator Light flashes. Heat 1 tablespoon oil in Pressure Cooker. Add mushrooms and sprinkle with salt. Cook, stirring occasionally, until mushrooms are nicely browned, 4 to 5 minutes.
2. Add remaining tablespoon of oil and leeks, and cook until leeks soften slightly, about 2 minutes. Stir in wine and cook until about half evaporates.
3. Dust chicken lightly with flour. Add half of chicken and peppers, then pour half of pasta sauce on top. Add remaining chicken, peppers, and pasta sauce.
4. Pull Lid Handles apart and set Lid on Pressure Cooker. Slide Safety Lock to LOCK position. Point Pressure Regulator Knob to PRESSURE.
5. Set PRESSURE MODE for HIGH and COOK TIME for 6 minutes. Press START Button.
6. When Pressure Cooker beeps three times, STOP Light will illuminate. Quickly release pressure by holding down QUICK STEAM RELEASE Button until red Pressure Indicator Rod drops.
7. Slide Safety Lock to UNLOCK. Pull Lid Handles apart and remove Lid.
8. Stir in olives and parsley. Add salt and pepper to taste.

Garnish individual portions liberally with parmesan and a bit more parsley. Pass extra parmesan in a bowl.

Serves 6 to 8

TURKEY CHILI (3 minutes, high pressure)

1 tablespoon olive oil
1/2 pound smoked turkey sausage, cut into 1/4-inch slices
2 pounds ground turkey
2 cups coarsely chopped onions
2 teaspoons whole cumin seeds
1 cup chicken broth
1 1/2 tablespoons mild chili powder, plus more if needed
1/2 teaspoon salt, or to taste
1/4 teaspoon ground cinnamon
2 large green and 2 large red bell peppers, seeded and diced
One 15-ounce can diced or stewed tomatoes (with liquid)
1 or 2 cloves garlic, pushed through a press
2 tablespoons cornmeal or quick-cooking polenta, plus more if needed (optional)
Garnishes: sour cream and chopped cilantro

1. Press START and BROWN. Heat oil in Pressure Cooker and brown sausage well on both sides. Remove and set aside.
2. Add ground turkey and cook, stirring constantly and breaking up clumps, until it is no longer pink, 2 to 3 minutes. Stir in onions and cumin and cook an additional minute, stirring frequently.
3. Stir in broth, reserved sausage, chili powder, salt, cinnamon, and bell peppers. Pour tomatoes on top.
4. Pull Lid Handles apart and set Lid on Pressure Cooker. Slide Safety Lock to LOCK position. Point Pressure Regulator Knob to PRESSURE.
5. Set PRESSURE MODE for HIGH and COOK TIME for 3 minutes. Press START Button.
6. When Pressure Cooker beeps three times, STOP Light will illuminate. Quickly release pressure by holding down QUICK STEAM RELEASE Button until red Pressure Indicator Rod drops.
7. Slide Safety Lock to UNLOCK. Pull Lid Handles apart and remove Lid.
8. Press COOK MODE Button until the Red Indicator Light next to BROWN is lit. Press the START/STOP Button until the Green START Indicator Light illuminates and the Red BROWN Indicator Light flashes. Stir in garlic and adjust seasonings. If chili is too thin, sprinkle on corn meal while stirring. Cook until chili is thickened and garlic loses its raw taste, about 3 minutes.
9. Serve in large bowls, garnished with sour cream and cilantro.

Serves 4 to 6

Adapted from THE PRESSURED COOK, copyright Lorna Sass, 1998. By permission of Harper Collins Publishers, Inc.

POT ROAST WITH GARLIC SMASHED POTATOES

(80 minutes, high pressure)

Cook potatoes and whole garlic cloves along with your roast. Smash the potatoes with garlic and serve alongside the roast for a hearty one-pot meal.

You'll need a few metal or bamboo skewers for threading the garlic cloves - or you can wrap them loosely in a cheesecloth bundle.

5-pound boneless chuck beef chuck roast, tied with string

Salt and freshly ground pepper

2 tablespoons vegetable oil

2 cups chopped onions

1 cup chopped carrot

1 cup chopped celery

One 14.5-ounce can low-sodium beef broth

2 bay leaves

8 large potatoes, scrubbed (leave whole)

12 large cloves garlic, peeled

2 tablespoons butter

Garnish: 3 tablespoons chopped parsley

1. Season roast well with salt and pepper.
2. Press COOK MODE Button until the Red Indicator Light next to BROWN is lit. Press the START/STOP Button until the Green START Indicator Light illuminates and the Red BROWN Indicator Light flashes. Heat oil in Pressure Cooker and brown roast well on all sides. Remove and set aside.
3. Add onions, carrots, and celery and cook, stirring occasionally, until onions begin to brown, 2 to 3 minutes. Add broth and bay leaves. Return roast to Pressure Cooker. Set potatoes on top and around roast. Thread garlic cloves on skewers and set skewers on top of potatoes or roast.
4. Pull Lid Handles apart and set Lid on Pressure Cooker. Slide Safety Lock to LOCK position. Point Pressure Regulator Knob to PRESSURE.
5. Set PRESSURE MODE for HIGH and COOK TIME for 80 minutes. Press START Button.
6. When Pressure Cooker beeps three times, STOP Light will illuminate. Allow pressure to come down naturally for at least 15 minutes. If you wish, quick-release any remaining pressure by holding down QUICK STEAM RELEASE Button until red Pressure Indicator Rod drops.
7. Slide Safety Lock to UNLOCK. Pull Lid Handles apart and remove Lid.
8. Transfer potatoes and garlic to a bowl and cover with foil. Set roast on a cutting board. Let rest 5 to 10 minutes before slicing.
9. Strain cooking broth into a gravy separator and degrease broth. Discard bay leaves. Mash chopped vegetables and stir into about 2 cups of cooking broth to make a gravy. Season to taste. (If you wish, you may thicken remaining cooking broth with cornstarch or arrowroot for additional gravy.)
10. Mash potatoes and garlic cloves with butter. Season to taste and garnish with parsley. Serve alongside roast. Pass gravy in a sauceboat.

Serves 8

BUSY COOK'S BEEF STEW (20 minutes, high pressure)

3 1/2-pounds beef chuck roast, trimmed and cut into 1-inch chunks
(or use 3 1/2 pounds pre-cut stew meat)

Salt and freshly ground pepper

1/4 cup flour

1 to 2 tablespoons vegetable oil

1 cup dry red wine

1/2 cup beef or chicken broth or water

1/2 packet (about 2 tablespoons) onion soup mix

1 teaspoon dried thyme

1 pound baby-cut carrots

6 to 8 large potatoes, scrubbed and halved

One 10-ounce package frozen French-cut green beans (optional)

One 1-pound package frozen baby onions (optional)

1. Season meat with salt and pepper and toss in flour to coat lightly.
2. Press COOK MODE Button until the Red Indicator Light next to BROWN is lit. Press the START/STOP Button until the Green START Indicator Light illuminates and the Red BROWN Indicator Light flashes. Heat 1 tablespoon oil in Pressure Cooker and brown meat in two batches, adding more oil if needed. Return all browned meat to Pressure Cooker and add wine. Cook until half of wine evaporates.
3. Add broth, onion soup mix, and thyme. Set carrots and potatoes on top of meat.
4. Pull Lid Handles apart and set Lid on Pressure Cooker. Slide Safety Lock to LOCK position. Point Pressure Regulator Knob to PRESSURE.
5. Set PRESSURE MODE for HIGH and COOK TIME for 20 minutes. Press START Button.
6. When Pressure Cooker beeps three times, STOP Light will illuminate. Allow pressure to come down naturally for at least 15 minutes. If you wish, quick-release any remaining pressure by holding down QUICK STEAM RELEASE Button until red Pressure Indicator Rod drops.
7. Slide Safety Lock to UNLOCK. Pull Lid Handles apart and remove Lid.
8. Transfer potatoes to a bowl and cover with foil. Use a paper towel to sop up surface fat on stew. (Or refrigerate stew overnight and remove congealed fat; return to Pressure Cooker and press BROWN and START to reheat.)
9. If you wish to add frozen vegetables, stir them in. Press BROWN and START Button and cook until vegetables are tender, 4 to 5 minutes. Adjust seasonings.
10. To serve, divide potatoes among plates and ladle stew on top.

Serves 8

BRISKET IN BARBECUE SAUCE (70 minutes, high pressure)

Here's a recipe for fork-tender brisket in record time. Your favorite barbecue sauce will provide so much flavor that it's not necessary to brown the meat. Be forewarned: the brisket will shrink about 25%.

For best results, cook the brisket a day in advance and refrigerate the sliced meat and sauce overnight in separate containers. Remove the congealed fat from the sauce and reheat in a covered pot by simmering the slices and potatoes in the sauce. Just before serving, thicken sauce as described in Step 8 below.

- 1 tablespoon olive oil
- 1 1/2 pounds onions, peeled and cut into thick slices
- 3 large green bell peppers, seeded and cut into 1-inch slices
- 1/2 cup beef broth or water
- 4 1/2-pound boneless beef brisket, trimmed
- 1 1/4 cups store bought barbecue sauce
- 6 to 8 large potatoes, scrubbed and halved
- 3 tablespoons quick-cooking polenta or cornstarch
- Salt and freshly ground black pepper

1. Press COOK MODE Button until the Red Indicator Light next to BROWN is lit. Press the START/STOP Button until the Green START Indicator Light illuminates and the Red BROWN Indicator Light flashes. Heat oil in Pressure Cooker. Add onions and cook, stirring frequently, until they soften slightly, about 2 minutes.
2. Add peppers and broth and set brisket on top. Pour barbecue sauce over brisket. Arrange potatoes over and around brisket.
3. Pull Lid Handles apart and set Lid on Pressure Cooker. Slide Safety Lock to LOCK position. Point Pressure Regulator Knob to PRESSURE.
4. Set PRESSURE MODE for HIGH and COOK TIME for 70 minutes. Press START Button.
5. When Pressure Cooker beeps three times, STOP Light will illuminate. Allow pressure to come down naturally for at least 15 minutes. If you wish, quick-release any remaining pressure by holding down QUICK STEAM RELEASE Button until red Pressure Indicator Rod drops.
6. Slide Safety Lock to UNLOCK. Pull Lid Handles apart and remove Lid.
7. Transfer potatoes to a platter and cover with foil. Set brisket on a cutting board. Let cool slightly before slicing on the bias.
8. If serving immediately, strain cooking broth into a gravy separator and degrease. Return to Pressure Cooker along with vegetable solids. Press COOK MODE Button until the Red Indicator Light next to BROWN is lit. Press the START/STOP Button until the Green START Indicator Light illuminates and the Red BROWN Indicator Light flashes. If using polenta, stir it directly into sauce. If using cornstarch, dissolve it in 1/2 cup sauce and then stir mixture into remaining sauce in pot. Cook, stirring frequently, until sauce thickens, 1 to 3 minutes.
9. Arrange sliced brisket on platter along with potatoes. Pour some sauce on top and pass remaining sauce at the table.

Serves 6

SWEET-AND-SOUR PORK CHOPS WITH PINEAPPLE

(10 minutes, high pressure)

Serve this colorful Hawaiian-inspired medley over rice.

One 28-ounce can pineapple chunks in unsweetened pineapple juice

1/4 cup apple cider vinegar

1 1/2 tablespoons soy sauce, plus more if needed

1 tablespoon toasted (Asian) sesame oil

1 tablespoon brown sugar

1 teaspoon ground ginger

1 to 2 tablespoons peanut or canola oil

6 to 8 center-cut pork chops, about 1-inch thick, trimmed

2 large red onions, peeled and sliced in rings

3 large red bell peppers, seeded and cut into 1-inch strips

2 tablespoons cornstarch

Optional garnish: 3 tablespoons chopped cilantro

1. In a bowl, prepare sweet-and-sour sauce by combining pineapple (including juice), vinegar, soy sauce, sesame oil, brown sugar, and ginger. Set aside.
2. Press COOK MODE Button until the Red Indicator Light next to BROWN is lit. Press the START/STOP Button until the Green START Indicator Light illuminates and the Red BROWN Indicator Light flashes. Heat 1 tablespoon oil in Pressure Cooker and brown pork chops on both sides in batches, adding more oil if needed. Set chops aside.
3. Add onions and cook, stirring frequently, until they soften slightly, about 2 minutes. Layer pork chops and red peppers in Pressure Cooker and pour reserved sweet-and-sour sauce on top.
4. Pull Lid Handles apart and set Lid on Pressure Cooker. Slide Safety Lock to LOCK position. Point Pressure Regulator Knob to PRESSURE.
5. Set PRESSURE MODE for HIGH and COOK TIME for 10 minutes. Press START Button.
6. When Pressure Cooker beeps three times, STOP Light will illuminate. Quickly release pressure by holding down QUICK STEAM RELEASE button until red Pressure Indicator Rod drops.
7. Slide Safety Lock to UNLOCK. Pull Lid Handles apart and remove Lid.
8. With a slotted spoon, transfer chops to a large, deep serving platter.
9. Press COOK MODE Button until the Red Indicator Light next to BROWN is lit. Press the START/STOP Button until the Green START Indicator Light illuminates and the Red BROWN Indicator Light flashes. Dissolve cornstarch in 1/2 cup cooking liquid and stir this slurry into sauce. Cook, stirring frequently, until sauce thickens, 1 to 2 minutes. Add more soy sauce if needed.
10. Pour sauce over chops and garnish with cilantro, if you wish.

Serves 6

CURRIED CHICKPEAS WITH SPINACH

(18 minutes, high pressure)

Serve this flavor-packed vegetarian curry over rice, with a dollop of mango chutney on the side.

1 pound (2 1/2 cups) dried chickpeas, soaked overnight in ample water to cover

2 cups vegetable broth or water

One 13.5-ounce can coconut milk

2 tablespoons Madras-style mild curry powder (see Cook's Notes below)

Two 10-ounce packages frozen chopped spinach

2 large (about 1 pound) red onions, peeled and cut into eighths

One 15-ounce can diced tomatoes with chilies (including liquid)

Salt to taste

Garnishes: sour cream or yogurt and chopped cilantro

1. Drain chickpeas. Blend broth, coconut milk, and curry powder in Pressure Cooker. Add chickpeas and set frozen blocks of spinach and onions on top. Pour tomatoes over spinach and onions.
2. Pull Lid Handles apart and set Lid on Pressure Cooker. Slide Safety Lock to LOCK position. Point Pressure Regulator Knob to PRESSURE.
3. Set PRESSURE MODE for HIGH and COOK TIME for 18 minutes. Press START Button.
4. When Pressure Cooker beeps three times, STOP Light will illuminate. Quickly release pressure by holding down QUICK STEAM RELEASE Button until red Pressure Indicator Rod drops.
5. Slide Safety Lock to UNLOCK. Pull Lid Handles apart and remove Lid.
6. Stir well and add salt, if needed. Curry will quickly thicken as it stands, but if you wish to thicken immediately, mash some chickpeas against side of Pressure Cooker with a fork and stir them in.
7. Garnish individual portions with a dollop of sour cream and a sprinkling of cilantro.

Serves 7 to 8

Cook's Notes: One good brand of Madras curry powder is Merwanjee Poonjajee & Sons, available in gourmet shops and many supermarkets. The blend contains salt.

RISOTTO WITH SMOKED MOZZARELLA AND SUN-DRIED TOMATOES (4 minutes, high pressure)

Risotto normally takes about a half hour of constant stirring to prepare in the conventional way, but in the Pressure Cooker it's done in just a few minutes. This sophisticated Italian rice dish makes a fine substitute for pasta.

1 tablespoon olive oil (or use oil from sun-dried tomatoes)
3/4 cup chopped shallots or onions
2 cups Arborio rice (see Cook's Notes below)
2/3 cup dry white wine or vermouth
4 1/2 to 5 1/2 cups chicken or vegetable broth
6 ounces smoked mozzarella, grated (about 1 1/4 cups tightly packed)
2/3 cup coarsely chopped sun-dried tomatoes (oil-packed)
3 tablespoons chopped parsley
Salt and freshly ground pepper
Garnish: chopped parsley

1. Press COOK MODE Button until the Red Indicator Light next to BROWN is lit. Press the START/STOP Button until the Green START Indicator Light illuminates and the Red BROWN Indicator Light flashes. Heat oil in Pressure Cooker and cook shallots for 1 minute. Stir in rice, taking care to coat grains with oil.
2. Add wine and cook until most of it evaporates.
3. Stir in 4 1/2 cups broth.
4. Pull Lid Handles apart and set Lid on Pressure Cooker. Slide Safety Lock to LOCK position. Point Pressure Regulator Knob to PRESSURE.
5. Set PRESSURE MODE for HIGH and COOK TIME for 4 minutes. Press START Button.
6. When Pressure Cooker beeps three times, STOP Light will illuminate. Quickly release any remaining pressure by holding down QUICK STEAM RELEASE Button until red Pressure Indicator Rod drops.
7. Slide Safety Lock to UNLOCK. Pull Lid Handles apart and remove Lid.
8. Press COOK MODE Button until the Red Indicator Light next to BROWN is lit. Press the START/STOP Button until the Green START Indicator Light illuminates and the Red BROWN Indicator Light flashes. Stir risotto vigorously as it boils until rice is tender but still chewy. If the mixture becomes dry, gradually add more broth as needed. (Risotto should be slightly soupy.) Stir in mozzarella, sun-dried tomatoes and parsley. Season with salt and pepper to taste.
9. Ladle into large, shallow pasta or soup bowls. Garnish individual portions with parsley, and serve immediately.

Cook's Notes: Arborio is a plump Italian short-grain white rice traditionally used to make risotto. It is available in gourmet shops and many supermarkets. Carnaroli and Maratelli are two other types that may be substituted.

Serves 4 as main dish or 6 as appetizer

LEMON CHEESECAKE (35 minutes, high pressure)

To make this dense and delicious cheesecake, you'll need a 7-inch springform pan and aluminum foil (preferably extra-wide, heavy duty).

Butter for greasing springform pan

1/2 cup chocolate cookie or graham cracker crumbs

Two 8-ounce packages Philadelphia cream cheese (see Cook's Notes below)

1 cup sugar

1/2 cup sour cream or plain yogurt

2 tablespoons flour

Zest of 1 large lemon

2 1/2 tablespoons freshly squeezed lemon juice

3 large eggs

Garnishes: sliced strawberries, blueberries, or raspberries

1. Liberally butter springform pan. Coat sides with cookie crumbs and spread remaining crumbs evenly on bottom. Set aside.
2. In a food processor, blend cream cheese, sugar, sour cream, lemon zest and juice. Scrape down sides of bowl. Add eggs and process just until blended in.
3. Pour mixture into prepared pan. Place pan in center of a sheet of aluminum foil about 2 1/2 feet long. (If not heavy duty, use a double layer.) Press foil tightly against sides of pan. Bring two longer ends up to meet, then fold over to seal, creating a tent to allow space on top for cheesecake to puff up. Use another sheet of foil, if needed, so that pan and cheesecake are entirely enclosed.
4. Set rack in Pressure Cooker and gently place pan on top. Pour in enough water to reach halfway up sides of pan.
5. Pull Lid Handles apart and set Lid on Pressure Cooker. Slide Safety Lock to LOCK position. Point Pressure Regulator Knob to PRESSURE.
6. Set PRESSURE MODE for HIGH and COOK TIME for 35 minutes. Press START Button.
7. When Pressure Cooker beeps three times, STOP Light will illuminate. Allow pressure to come down naturally until red Pressure Indicator Rod drops, about 20 minutes.
8. Slide Safety Lock to UNLOCK. Pull Lid Handles apart and remove Lid.
9. Let cheesecake cool for a few minutes, then transfer to a cooling rack set over a plate to catch dripping water. Open foil seal. Use a paper towel to blot up any moisture on top of cheesecake. While cheesecake is still hot, gently smooth off top if necessary.
10. When cooled to room temperature, cover with plastic wrap and refrigerate at least 6 hours or overnight. (You may also freeze for up to 2 months.) When ready to serve, release and remove sides of springform pan. Leave base in place and set cheesecake on a platter. Arrange berries decoratively on top.

Serves 8

Cook's Notes: This recipe was tested with traditional cream cheese and sour cream. Low-fat or fat-free versions may prevent the cheesecake from setting properly.

All recipes copyright Lorna Sass, 2001.

LIMITED ONE YEAR WARRANTY

Warranty: This Russell Hobbs® product is warranted by Salton, Inc. to be free from defects in materials or workmanship for a period of (1) year from the original purchase date. This product warranty covers only the original consumer purchaser of the product.

Warranty Coverage: This warranty is void if the product has been damaged by accident in shipment, unreasonable use, misuse, neglect, improper service, commercial use, repairs by unauthorized personnel, normal wear and tear, improper assembly, installation or maintenance abuse or other causes not arising out of defects in materials or workmanship. This warranty is effective only if the product is purchased and operated in the USA, and does not extend to any units which have been used in violation of written instructions furnished with the product or to units which have been altered or modified or to damage to products or parts thereof which have had the serial number removed, altered, defaced or rendered illegible.

Implied Warranties: ANY IMPLIED WARRANTIES WHICH THE PURCHASER MAY HAVE ARE LIMITED IN DURATION TO ONE (1) YEAR FROM THE DATE OF PURCHASE. Some states do not allow limitations on how long an implied warranty lasts, so the above limitation may not apply to you.

Warranty Performance: During the above one-year warranty period, a product with a defect will be either repaired or replaced with a reconditioned comparable model (at our option) when the product is returned to the Repair Center, or the purchase price refunded. The repaired or replacement product will be in warranty for the balance of the one-year warranty period and an additional one-month period. No charge will be made for such repair or replacement.

Service and Repair: Should the appliance malfunction, you should first call toll-free 1 (800) 233-9054 between the hours of 9:00 am and 5:00 pm Central Standard Time and ask for CONSUMER SERVICE stating that you are a consumer with a problem. Please refer to model number RHNPC800P when you call.

In-Warranty Service (USA): For an appliance covered under the warranty period, no charge is made for service or postage. Call for return authorization (1 800 233-9054).

Out-of-Warranty Service: A flat rate charge by model is made for out-of-warranty service. Include \$10.00 (U.S.) for return shipping and handling. We will notify you by mail of the amount of the charge for service and require you to pay in advance for the repair or replacement.

For Products Purchased in the USA, but Used in Canada: You may return the product insured, packaged with sufficient protection, and postage and insurance prepaid to the USA address listed below. Please note that all customs duty / brokerage fees, if any, must be paid by you and we will require you to pay the cost of customs duty / brokerage fees to us in advance of our performing any service.

Risk During Shipment: We cannot assume responsibility for loss or damage during incoming shipment. For your protection, carefully package the product for shipment and insure it with the carrier. Be sure to enclose the following items with your appliance: any accessories related to your problem, your full return address and daytime phone number, a note describing the problem you experienced, a copy of your sales receipt or other proof of purchase to determine warranty status. C.O.D. shipments cannot be accepted.

To return the appliance, ship to:

Attn: Repair Center
Salton, Inc.
708 South Missouri Street
Macon, MO 63552

To contact us, please write to, call, or email:

Salton, Inc.
P.O. Box 7366
Columbia, MO 65205-7366
1 800 233-9054
Email: Salton@Saltonusa.com

Limitation of Remedies: No representative or person is authorized to assume for Salton, Inc. any other liability in connection with the sale of our products. There shall be no claims for defects or failure of performance or product failure under any theory of tort, contract or commercial law including, but not limited to negligence, gross negligence, strict liability, breach of warranty and breach of contract. Repair, replacement or refund shall be the sole remedy of the purchaser under this warranty, and **in no event shall Salton be liable for any incidental or consequential damages, losses or expenses.** Some states do not allow the exclusion or limitation of incidental or consequential damages, so the above limitation or exclusion may not apply to you.

Legal Rights: This warranty gives you specific legal rights, and you may also have other rights which vary from state to state.

For more information on Salton products: Visit our website: <http://www.salton-maxim.com>

© 2002 Salton, Inc.
All Rights Reserved

P/N 60907
Printed in China

Free Manuals Download Website

<http://myh66.com>

<http://usermanuals.us>

<http://www.somanuals.com>

<http://www.4manuals.cc>

<http://www.manual-lib.com>

<http://www.404manual.com>

<http://www.luxmanual.com>

<http://aubethermostatmanual.com>

Golf course search by state

<http://golfingnear.com>

Email search by domain

<http://emailbydomain.com>

Auto manuals search

<http://auto.somanuals.com>

TV manuals search

<http://tv.somanuals.com>