

# SHARP®

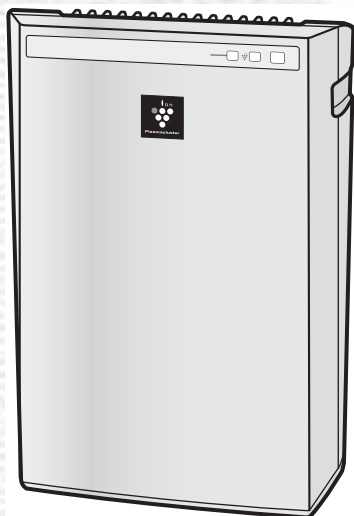

\*Plasmacluster is a trademark of Sharp Corporation.



**Free standing type**

# FU-Y30J-W

## AIR PURIFIER OPERATION MANUAL

ENGLISH

## Please read before operating your new Air Purifier

Some odour ingredients absorbed by the filter may become separated and may be discharged through the air outlet and result in additional odour. Depending on the usage environment, especially when the product is used in a condition significantly more severe than household use, this odour may become strong in a shorter period than expected. In this case we recommend purchasing the optional replacement filter.

## NOTE

- The air purifier is designed to remove air-suspended dust and odour, but not harmful gases (for example, carbon monoxide contained in cigarette smoke). If the odour sources still exist, it cannot completely remove the odour (for example, odours from construction materials and pet odours).
- It is suggested to open the window a bit when you are smoking in order to facilitate ventilation.

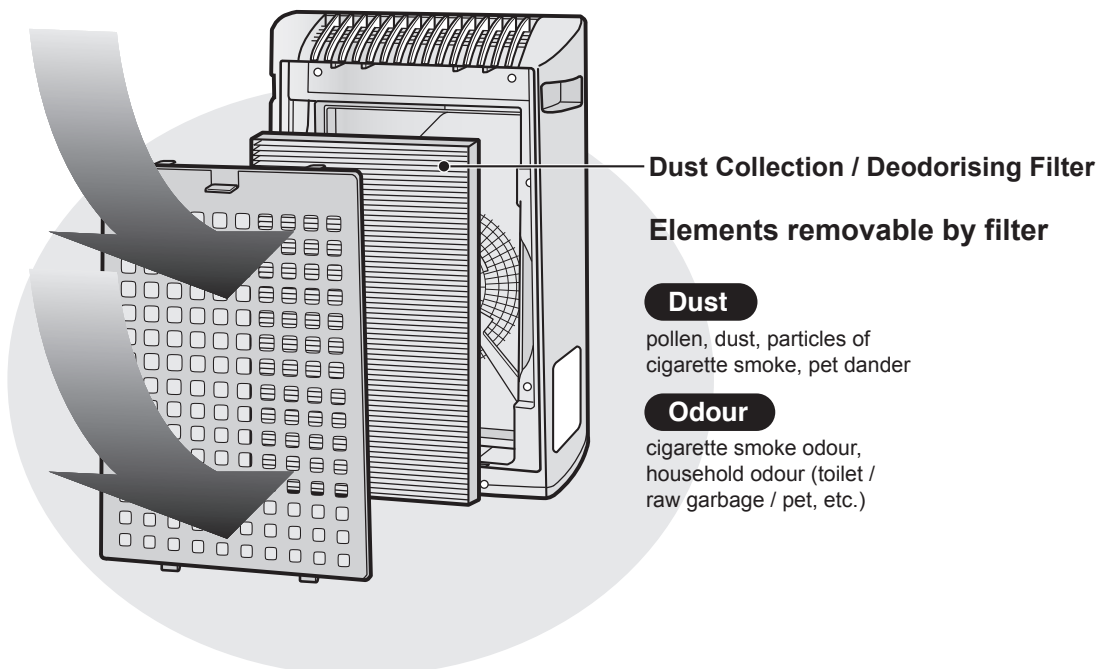

## FEATURES

### "Plasmacluster" technology

Plasmacluster technology uses plasma discharge to produce and release the same positive and negative ions as those found in nature ("Plasmacluster ions").

This is a unique air cleaning technology of the SHARP CORPORATION for breaking down and inactivating such potential allergens as the faecal matter or corpses of aerial mites\*<sup>1</sup>, viruses\*<sup>2</sup> and mould and bacteria\*<sup>3</sup> suspended in the air, and has been substantiated by third-party organisations both in Japan and overseas.

When there is a high density of Plasmacluster ions in the air, the smell of cigarette smoke trapped in curtains or sofas is removed in about 80 minutes\*<sup>4</sup>, and when clothing is hung in a place exposed to the direct air expelled from the unit generating Plasmacluster ions, the smell of sweat is reduced to a virtually imperceptible level in one night (about 6 hours).

\*1 Graduate School of Advanced Sciences of Matter, Hiroshima University, Japan

Measurement of action on the potential allergens of aerial mites (in the area of 13m<sup>2</sup>)

\*2 Retroscreen Virology, Ltd., London, UK  
Measurement of ratio of viruses eliminated from the air in a 1m<sup>3</sup> box

\*3 Ishikawa Health Service Association, Japan

Measurement of aerial mould and bacteria with an air sampler (13m<sup>2</sup>)

\*4 Japan Spinners Inspecting Foundation, Japan

Evaluation of deodorising effect on odour-imbued fragments of cloth

## CONTENTS

<b>IMPORTANT SAFETY INSTRUCTIONS</b> .....	E-2
• WARNING .....	E-2
• CAUTIONS CONCERNING OPERATION ...	E-3
• INSTALLATION GUIDELINES.....	E-3
• FILTER GUIDELINES .....	E-3
<b>PART NAMES</b> .....	E-4
• MAIN UNIT DISPLAY .....	E-4
• ILLUSTRATIVE DIAGRAM.....	E-4
• INCLUDED .....	E-5
• BACK.....	E-5
<b>PREPARATION</b> .....	E-6
• FILTER INSTALLATION .....	E-6
<b>OPERATION</b> .....	E-8
• MAIN UNIT OPERATION .....	E-8
<b>CARE AND MAINTENANCE</b> .....	E-9
• BACK PANEL .....	E-9
• UNIT .....	E-9
• FILTER REPLACEMENT GUIDELINES.....	E-10
<b>TROUBLESHOOTING</b> .....	E-11
<b>SPECIFICATIONS</b> .....	E-12

Thank you for purchasing the SHARP Air Purifier. Please read this manual carefully for the correct usage information. Before using this product, be sure to read the section: "Important Safety Instructions."

After reading this manual, retain it in a convenient location for future reference.

# IMPORTANT SAFETY INSTRUCTIONS

When using electrical appliances, basic safety precautions should be followed, including the following:

**WARNING** - To reduce the risk of electrical shock, fire or injury to persons:

- Read all instructions before using the unit.
- Use only a 220-240 volt outlet.
- **Do not use the unit if the power cord or plug is damaged or the connection to the wall outlet is loosened.**
- Periodically remove dust from the power plug.
- **Do not insert fingers or foreign objects into the air intake or outlet.**
- **When removing the power plug, always hold the plug and never pull the cord.**

Electrical shock and/or fire from short circuit may occur as a result.

- **Do not remove the plug when your hands are wet.**
- **Do not use this unit near gas appliances or fireplaces.**
- **Remove the power plug from the wall outlet before cleaning the unit and when not using the unit.**

Electrical shock from bad insulation and/or fire from short circuit may occur as a result.

- **If the power cord is damaged, it must be replaced by the manufacturer, its service agent, Sharp Approved Service Centre or similarly qualified person in order to avoid a hazard.**
- Do not operate when using aerosol insecticides or in rooms where there is oily residue, incense, sparks from lit cigarettes, chemical fumes in the air or in very high humidity conditions, such as a bathroom.
- Be cautious when cleaning the unit. Corrosive cleansers may damage the exterior.
- Only Sharp Approved Service Centres should service this air purifier. Contact your nearest Approved Service Centre for any problems, adjustments, or repairs.
- This appliance is not intended for use by persons (including children) with reduced physical, sensory or mental capabilities, or lack of experience and knowledge, unless they have been given supervision or instruction concerning use of the appliance by a person responsible for their safety.

Children should be supervised to ensure they do not play with the appliance.

**NOTE** - Radio or TV Interference

If this air purifier should cause interference to radio or television reception, try to correct the interference by one or more of the following measures:

- Reorient or relocate the receiving antenna.
- Increase the separation between the unit and radio/TV receiver.
- Connect the equipment into an outlet on a circuit different from that to which the receiver is connected.
- Consult the dealer or an experienced radio/TV technician for help.

# IMPORTANT SAFETY INSTRUCTIONS

## CAUTIONS CONCERNING OPERATION

- Do not block the air intake and/or outlet.
- Do not use the unit near or on hot objects, such as stoves or heaters or where it may come into contact with steam.
- Do not lay the unit down when turned on.
- **Always hold the handle on both sides of the unit when moving it.**  
Holding the back panel when carrying may cause it to detach, thus dropping the unit and resulting in personal injury.
- **Do not operate the unit without the filter.**
- **Do not wash and reuse the filter .**  
Not only does it not improve filter performance, but also may cause electrical shock or malfunction.
- **Clean the exterior with a soft cloth only.**  
Otherwise the unit surface may get damaged or cracked.  
In addition, the sensors may malfunction as a result.

## INSTALLATION GUIDELINES

- **During operation, please place the unit at least 2 m away from equipment utilizing electrical waves such as televisions, radios or wave clocks.**
- **Avoid locations where curtains, etc., come into contact with the air intake or outlet.**  
Curtains, etc., may become dirty or a until malfunction may occur.
- **Avoid locations where the unit is exposed to condensation, due to rapid temperature changes.**  
(If it is unavoidable please allow unit to stand for 1 hour before switching on.)  
(Use under appropriate conditions between 0 and 35°C in the room.)
- **Place on a stable surface with sufficient air circulation.**  
When placing the unit on a thick carpeted area, it may cause the unit to vibrate slightly.
- **Do not install when there is a possibility of soot, such as in a kitchen, etc.**  
The unit surface may crack as a result.
- **Leave about 60cm of space from the wall.**  
The wall behind the air outlet may become dirty as time passes. When using the unit for an extended period of time in the same location, use a vinyl sheet, etc., to prevent the wall from becoming dirty. In addition, periodically clean the wall.

## FILTER GUIDELINES

- Follow the instructions in this manual for correct care and maintenance of the filter.  
Use only filter designed for this product.

# PART NAMES

## MAIN UNIT DISPLAY

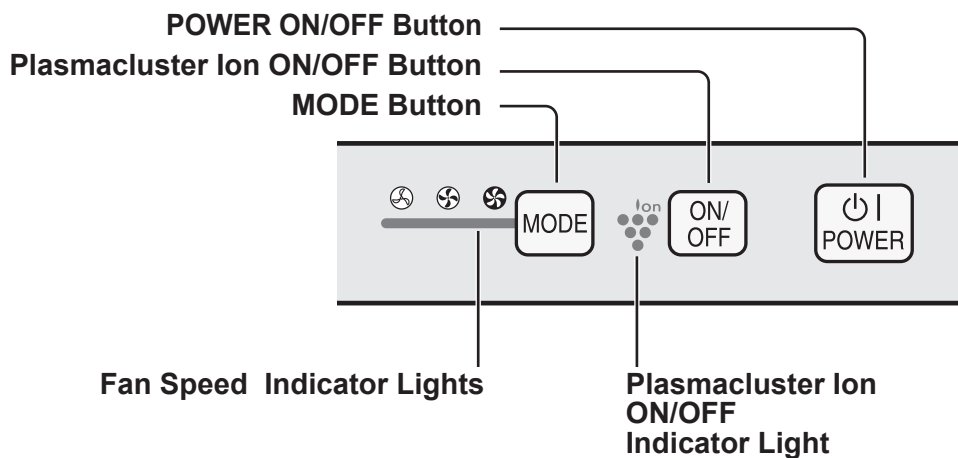

## ILLUSTRATIVE DIAGRAM

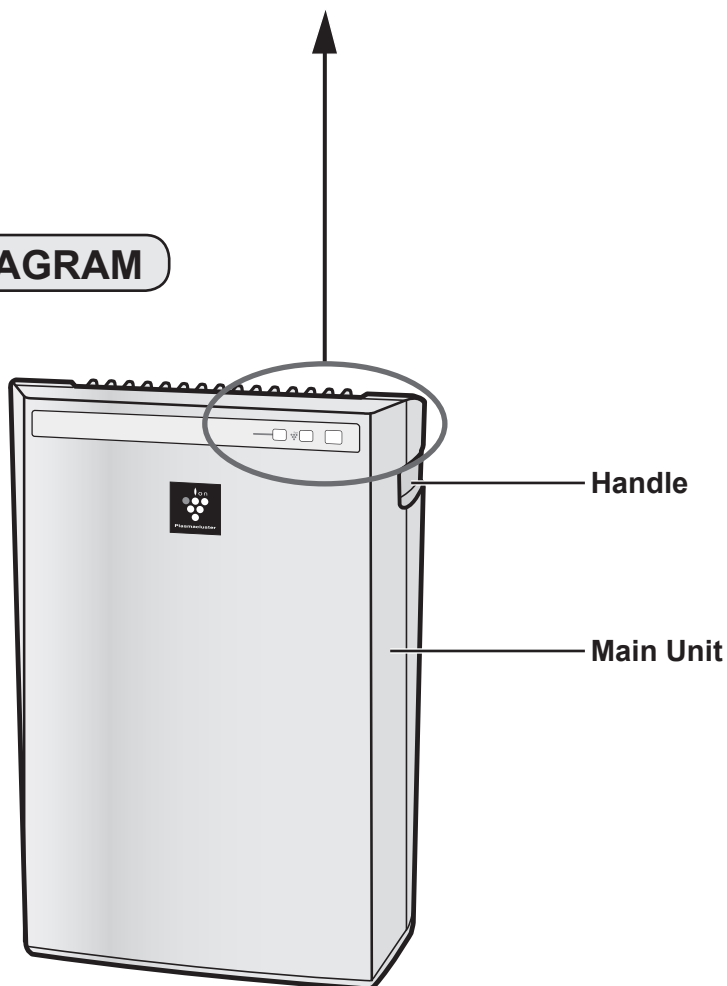

## INCLUDED

- Operation manual

## BACK

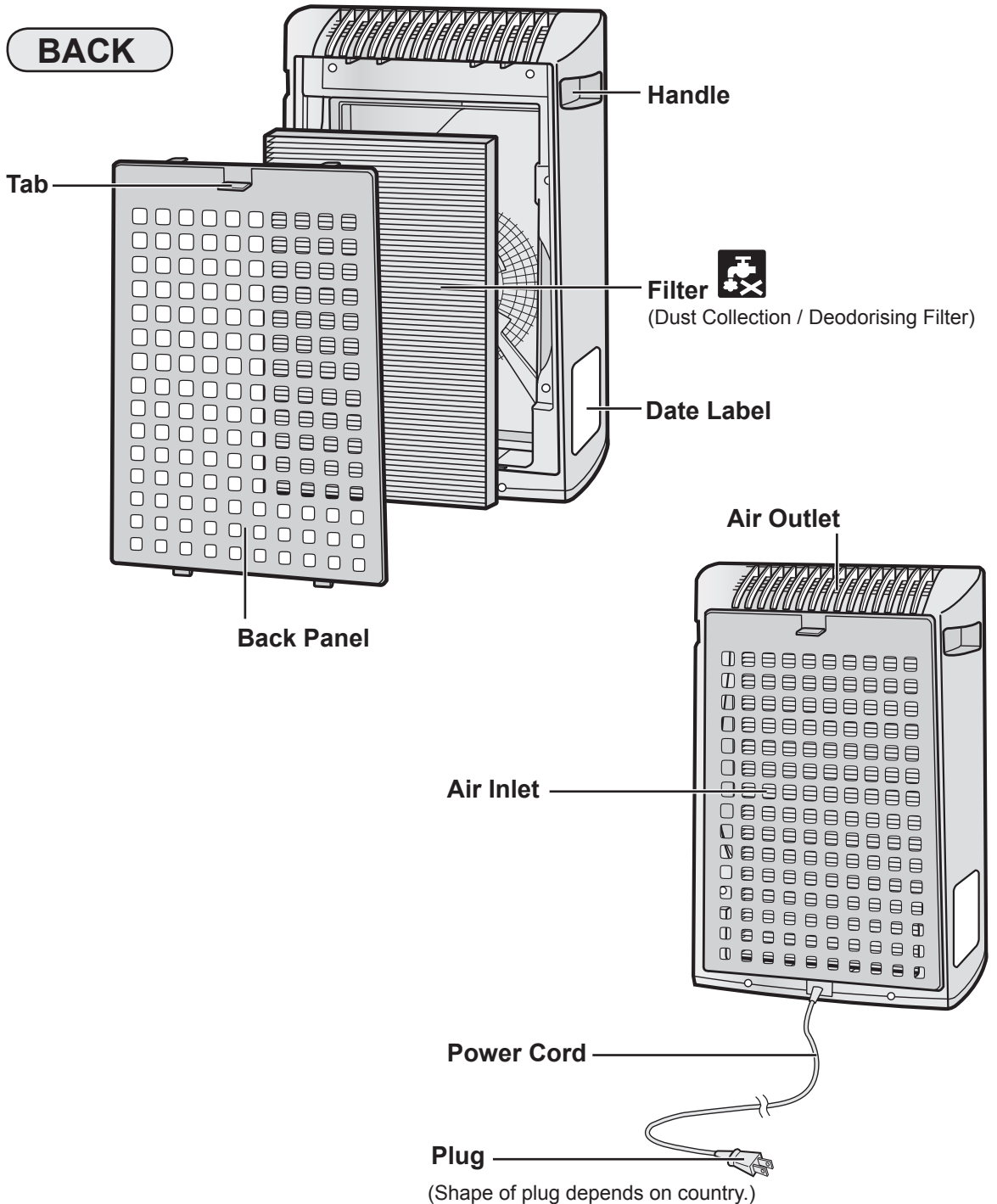

## FILTER INSTALLATION

To maintain the quality of the filter, they are installed in the main unit and packed in plastic bag. Be sure to remove the filter from the plastic bag before using the unit.

### 1 Remove the filter

- 1 Remove the Back Panel.**  
Pull the tab at the top of the Back Panel.

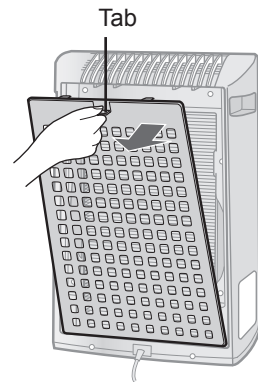

- 2 Remove the Filter from the plastic bag.**

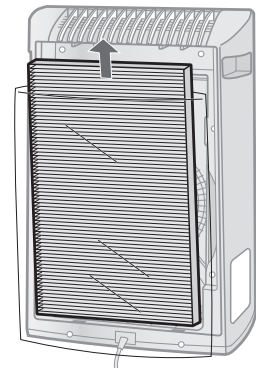

### 2 Intall the filter

- 1 Place the Filter within the main unit.**  
Do not install the filter backwards or the unit will not operate properly.

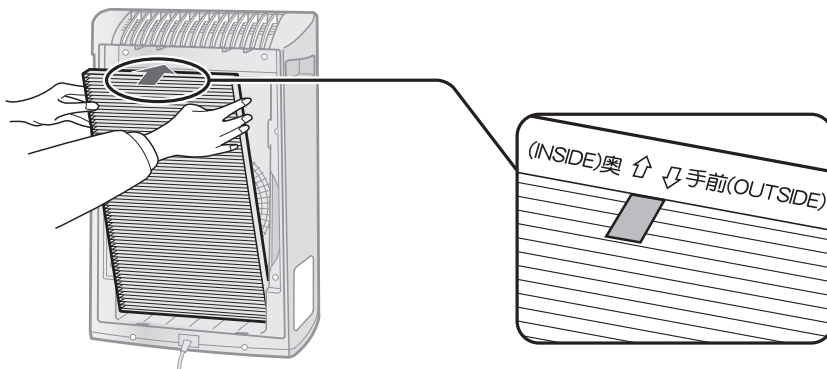



## 2 Replace the Back Panel to the main unit.

Push until it clicks into place.

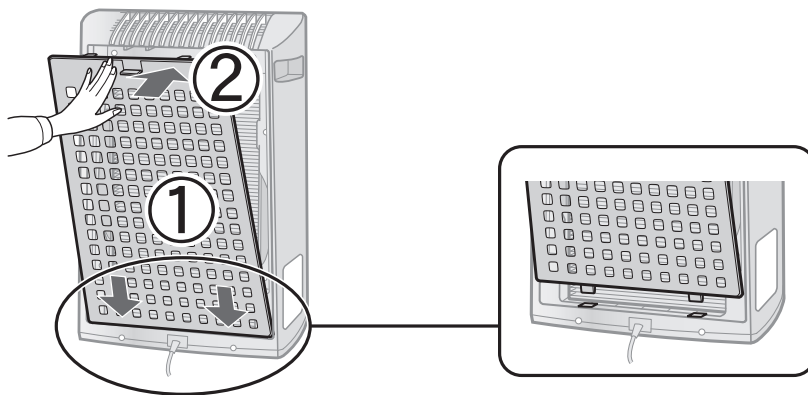

## 3 Fill in the usage start date on the Date Label.

Use the date as a guide for the filter replacement schedule.

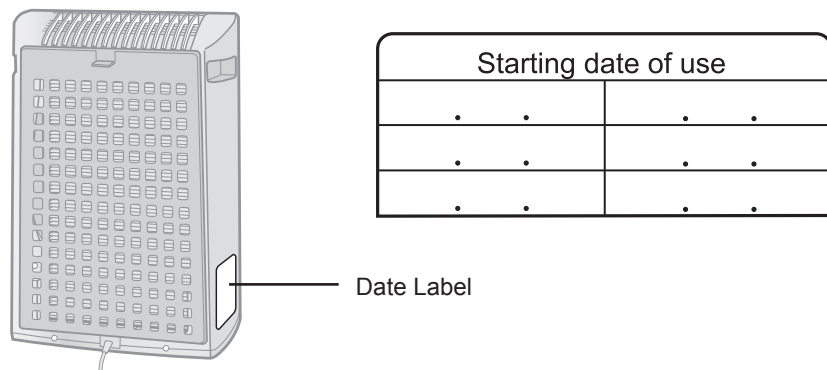

# OPERATION

## MAIN UNIT OPERATION

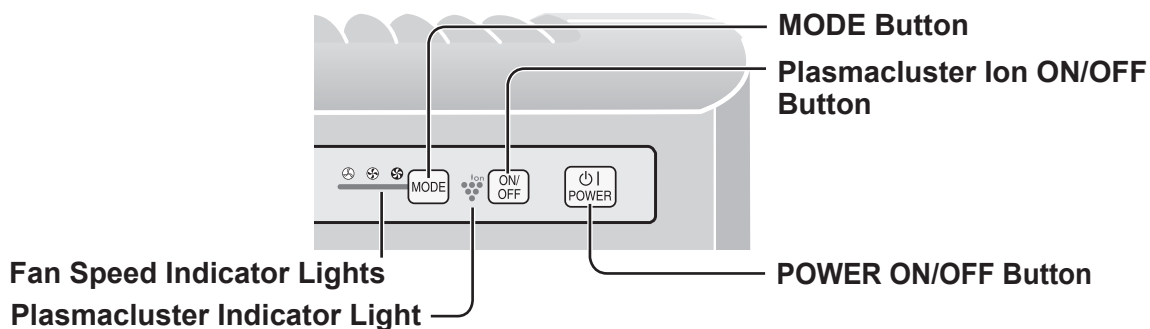

### Power ON/OFF Button

- Press to start operation (short beep) and stop operation (long beep)
- Plasmacluster Indicator Light and Fan Speed Indicator Light turn on/off.
- Unless the power cord has been unplugged, the operations starts in the previous mode it was operated in.



### MODE Button

- Press the MODE Button to select the desired fan speed. Indicator Lights will show the fan speed currently selected.
- The operation mode can be switched as below.

#### LOW operation

The unit will operate quietly using minimal air intake.

#### MEDIUM operation

The unit will operate at a fan speed of MEDIUM.

#### MAX operation

The unit will operate at a fan speed of MAX.



### Plasmacluster Ion ON/OFF Button

Press the Plasmacluster Ion ON/OFF Button to turn Plasmacluster Ion Mode ON and OFF. When Plasmacluster is ON, the Plasmacluster Indicator Light will turn on.(blue)

# CARE AND MAINTENANCE

To maintain optimum performance of this air purifier, please clean the unit including the filter periodically.

When cleaning the unit, be sure to unplug the power cord, and never handle the plug with wet hands. Electrical shock and/or bodily injury may occur as a result.

## BACK PANEL

**Care Cycle** Whenever dust accumulates on the unit or every 2 weeks

Gently remove dust from the back panel, using a vacuum cleaner attachment or similar tool.

### When the back panel has stubborn dirt

- 1** In case of heavy dirt, soak the back panel in water with kitchen detergent (for approx. 10min.). Avoid scrubbing the back panel hard when washing.
- 2** Rinse the back panel repeatedly with clean water to remove the solution residue.
- 3** Drip dry filter to remove excess water.

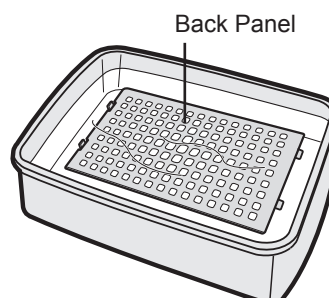
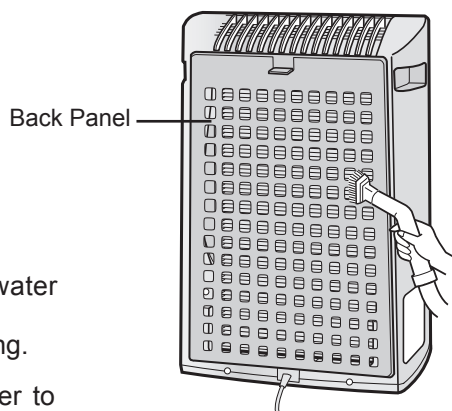

## UNIT

**Care Cycle** Whenever dust accumulates on the unit or every 1 month

To prevent dirt or stains on the main unit, clean as often as necessary. If stains are allowed to remain, they may become difficult to remove.

### Wipe with a dry, soft cloth

For stubborn stains or dirt, use a soft cloth dampened with warm water.

### Do not use volatile fluids

Benzene, paint thinner, polishing powder, etc., may damage the surface.

### Do not use detergents

Detergent ingredients may damage the unit.

# CARE AND MAINTENANCE

## FILTER REPLACEMENT GUIDELINES

Filter life vary depending on the room environment, usage, and location of the unit.

**If dust or odour persists, replace the filter.**

(Refer to “Please read before operating your new Air Purifier”)

### Guide for filter replacement timing

- The following filter life and replacement period is based on the condition of smoking 5 cigarettes per day and the dust collection/deodorisation power is reduced by half compared with that of new filter.

We recommend to replace the filter more frequently if the product is used in a condition significantly severer than normal household use.

•Filter	About 2 years after opening
---------	-----------------------------

## REPLACING THE FILTER

- 1 See page E-6,7 for directions on how to install the filter when replacing.
- 2 Fill in the usage start date of the filter on the Date Label.

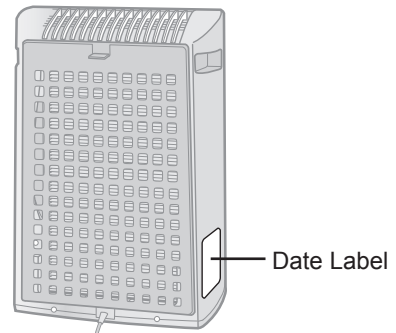

### Replacement Filters

Model : FZ-Y30SFJ

- Dust Collection / Deodorising Filter : 1 unit

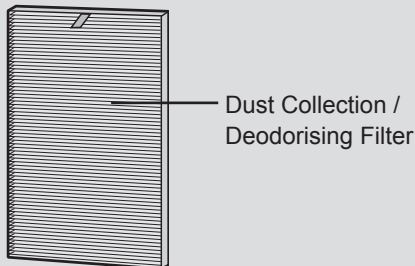

Please consult your dealer for purchase of the replacement filter.

### Disposal of Filter

Please dispose of the replaced filter according to the local disposal laws and regulations.

Filter materials :

- Filter : Polypropylene
- Frame : Polyester
- Deodoriser : Activated charcoal

# TROUBLESHOOTING

Before calling for repair, please review the list below, since the problem may not be a unit malfunction.

SYMPTOM	REMEDY (not a malfunction)
<b>Odours and smoke are not removed.</b>	<ul style="list-style-type: none"><li>• Clean or replace the filter if they appear to be heavily soiled. (Refer to E-9,E-10)</li></ul>
<b>A clicking or ticking sound is heard from the unit.</b>	<ul style="list-style-type: none"><li>• Clicking or ticking sounds may be audible when the unit is generating ions.</li></ul>
<b>The discharged air has an odour.</b>	<ul style="list-style-type: none"><li>• Check to see if the filter are heavily soiled. Replace the filter.</li><li>• Plasmacluster Air Purifiers emit small traces of ozone which may produce an odour. These ozone emissions are well below safety levels.</li></ul>

**If you still require service**, contact your SHARP approved service centre.

SHARP approved service centre locations can be found in the support area of our website:

Australia : <http://www.sharp.net.au>

New Zealand : <http://www.sharp.net.nz>

# SPECIFICATIONS

Model		FU-Y30J-W		
Power supply		220-240V 50/60Hz		
Fan Speed Operation	Fan Speed Adjustment	MAX	MED	LOW
	Rated Power	49W	32W	23W
	Fan Speed	180m <sup>3</sup> /hour	120m <sup>3</sup> /hour	60m <sup>3</sup> /hour
Recommended Room Size		~21m <sup>2</sup> *1		
High density Plasmacluster ion recommended room size		~13m <sup>2</sup> *2		
Cord Length		2.0m		
Dimensions		356mm(W)x180mm(D)x510mm(H)		
Weight		5.0kg		

\*1 Size of a room which is appropriate for operating the unit at maximum fan speed.

- It indicates the space where a certain amount of dust particles can be removed in 30 minutes(JEM1467).

\*2 Size of a room in which approximately 7000 ions can be measured per cubic centimeter in the center of the room (at a height of approximately 1.2 meters from the floor) when the product is placed next to a wall and run at the MAX operation position.

## Standby Power

In order to operate the electrical circuits while the power plug is inserted in the wall outlet, this product consumes about 1.0W of standby power.  
For energy saving, unplug the power cord when the unit is not in use.

**The class of the HEPA filter by EN 1822 is H10.**

# Memo

---

ENGLISH

# SHARP

**SHARP CORPORATION OF AUSTRALIA PTY.LTD.**

**A. B. N. 40 003 039 405**

1 HUNTINGWOOD DRIVE, HUNTINGWOOD, N.S.W. 2148

P.O.BOX 6827, BLACKTOWN. N.S.W. 2148

**SHARP CORPORATION OF NEW ZEALAND LIMITED**

59 HUGO JOHNSTON DRIVE PENROSE, AUCKLAND

Printed in China

TINS-A351KKRZ 09K – (CN) ①



## Free Manuals Download Website

<http://myh66.com>

<http://usermanuals.us>

<http://www.somanuals.com>

<http://www.4manuals.cc>

<http://www.manual-lib.com>

<http://www.404manual.com>

<http://www.luxmanual.com>

<http://aubethermostatmanual.com>

Golf course search by state

<http://golfingnear.com>

Email search by domain

<http://emailbydomain.com>

Auto manuals search

<http://auto.somanuals.com>

TV manuals search

<http://tv.somanuals.com>