

# SHARP®



**PORTABLE TYPE  
ROOM AIR CONDITIONER**  
INSTALLATION AND OPERATION  
MANUAL

**CLIMATISEUR DE CHAMBRE  
DE TYPE PORTATIF**  
MANUEL D'INSTALLATION ET  
D'UTILISATION

ENGLISH

FRANÇAIS

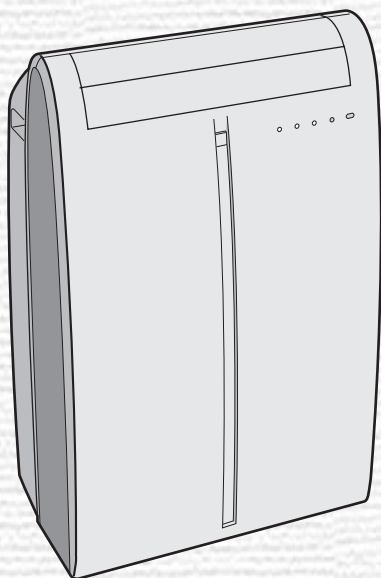

\* Plasmacluster is a trademark of SHARP Corporation.

\* Plasmacluster est une marque de commerce de SHARP Corporation.



This manual explains the proper use of your new air conditioner. Please read this manual carefully before using the product. This manual should be kept in a safe place for handy reference.

## CONTENTS

- FOR CUSTOMER ASSISTANCE (U.S.) ..... E-2
- CONSUMER LIMITED WARRANTY (U.S.) ..... E-3
- FOR CUSTOMER ASSISTANCE (CANADA) ..... E-4
- CONSUMER LIMITED WARRANTY (CANADA) ... E-5
- PRECAUTIONS ..... E-6
- LOCATION ..... E-9
- INCLUDED ..... E-9
- PART NAMES ..... E-10
- INSTALL WINDOW PANEL ..... E-12
- INSTALLATION AND REMOVAL OF EXHAUST HOSE... E-16
- PRE-OPERATION CHECKS ..... E-18
- COOL MODE ..... E-20
- DEHUMIDIFICATION MODE ..... E-21
- FAN MODE ..... E-22
- VENTILATION MODE ..... E-22
- TO CHANGE AIR FLOW DIRECTION ..... E-23
- PLASMACLUSTER OPERATION ..... E-24
- MEGA COOL OPERATION ..... E-25
- ONE-HOUR OFF TIMER ..... E-25
- TIMER OPERATION ..... E-26
- AUXILIARY MODE ..... E-28
- DRAINAGE ..... E-29
- MAINTENANCE ..... E-30
- BEFORE CALLING FOR SERVICE ..... E-31

### Declaration of Conformity

#### SHARP ROOM AIR CONDITIONER CV-P09FX

This device complies with Part 18 of FCC rules.

#### Responsible Party:

SHARP ELECTRONICS CORPORATION  
Sharp Plaza, Mahwah, New Jersey 07430-2135  
TEL: 1-800-BE-SHARP

# FOR CUSTOMER ASSISTANCE (the United States)

To aid in answering questions if you call for service or for reporting loss or theft, please record below the model and serial number located on the back side of the unit.

---

**MODEL NUMBER**

---

**SERIAL NUMBER**

---

**DATE OF PURCHASE**

---

**Dealer Name**

---

**Address**

---

**City**

---

**State**

---

**Zip**

---

**Telephone**

---

**TO PHONE:** Dial 1-800-BE-SHARP (237-4277) for:  
SERVICE (for your nearest Sharp Authorized Servicer)  
PARTS (for your Authorized Parts Distributor)  
ACCESSORIES  
ADDITIONAL CUSTOMER INFORMATION

**TO WRITE:** For service problems, warranty information, missing items and other assistance:  
Sharp Electronics Corporation  
Customer Assistance Center  
1300 Naperville Drive  
Romeoville, IL 60446-1091

**TO ACCESS THE INTERNET:** [www.sharppusa.com](http://www.sharppusa.com)

Please provide the following information when you write or call: model number, serial number, date of purchase, your complete mailing address (including zip code), your daytime telephone number (including area code) and description of the problem.

# CONSUMER LIMITED WARRANTY

## CONSUMER LIMITED WARRANTY FOR THE U.S. USERS

SHARP ELECTRONICS CORPORATION warrants to the first consumer purchaser that this Sharp brand product (the "Product"), when shipped in its original container, will be free from defective workmanship and materials, and agrees that it will, at its option, either repair the defect or replace the defective Product or part thereof with a new or remanufactured equivalent at no charge to the purchaser for parts or labor for the period(s) set forth below.

This warranty does not apply to any appearance items of the Product nor to the additional excluded item(s) set forth below nor to any Product the exterior of which has been damaged or defaced, which has been subjected to improper voltage or other misuse, abnormal service or handling, or which has been altered or modified in design or construction.

In order to enforce the rights under this limited warranty, the purchaser should follow the steps set forth below and provide proof of purchase to the servicer.

The limited warranty described herein is in addition to whatever implied warranties may be granted to purchasers by law. ALL IMPLIED WARRANTIES INCLUDING THE WARRANTIES OF MERCHANTABILITY AND FITNESS FOR USE ARE LIMITED TO THE PERIOD(S) FROM THE DATE OF PURCHASE SET FORTH BELOW. Some states do not allow limitations on how long an implied warranty lasts, so the above limitation may not apply to you.

Neither the sales personnel of the seller nor any other person is authorized to make any warranties other than those described herein, or to extend the duration of any warranties beyond the time period described herein on behalf of Sharp.

The warranties described herein shall be the sole and exclusive warranties granted by Sharp and shall be the sole and exclusive remedy available to the purchaser. Correction of defects, in the manner and for the period of time described herein, shall constitute complete fulfillment of all liabilities and responsibilities of Sharp to the purchaser with respect to the Product, and shall constitute full satisfaction of all claims, whether based on contract, negligence, strict liability or otherwise. In no event shall Sharp be liable, or in any way responsible, for any damages or defects in the Product which were caused by repairs or attempted repairs performed by anyone other than an authorized servicer. Nor shall Sharp be liable or in any way responsible for any incidental or consequential economic or property damage. Some states do not allow the exclusion of incidental or consequential damages, so the above exclusion may not apply to you.

THIS WARRANTY GIVES YOU SPECIFIC LEGAL RIGHTS. YOU MAY ALSO HAVE OTHER RIGHTS WHICH VARY FROM STATE TO STATE.

### Your Product Model Number & Description:

CV-P09FX Portable Air Conditioner. Be sure to have this information available when you need service for your Product.

### Warranty Period for this Product:

One (1) year parts and labor from date of purchase. The warranty period continues for a total of five (5) years from date of purchase for the Sealed Cooling System parts; labor and service are not provided free of charge for this additional period.

### Additional Item(s) Excluded From Warranty Coverage (if any):

Appearance items of the Product, filters, or accessories, or any printed materials.

### Where to Obtain Service:

Product which has been used for rental and/or commercial purposes.

### What to Do to Obtain Service:

From a Sharp Authorized Servicer located in the United States. To find the location of the nearest Sharp Authorized Servicer, call Sharp Toll Free at 1-800-BE-SHARP.

Contact your Sharp Authorized Servicer to obtain in-home service for this Product.

The Servicer will come to your home, and if it is necessary to remove the Product, the Servicer will reinstall it. Be sure to have Proof of Purchase available.

TO OBTAIN SUPPLY, ACCESSORY OR PRODUCT INFORMATION, CALL 1-800-BE-SHARP, OR VISIT OUR WEBSITE AT [www.sharpsusa.com](http://www.sharpsusa.com)

# SHARP®

## SHARP ELECTRONICS CORPORATION

Sharp Plaza, Mahwah, New Jersey 07430-2135

# FOR CUSTOMER ASSISTANCE (Canada)

To aid in answering questions if you call for service or for reporting loss or theft, please record below the model and serial number located on the back side of the unit.

---

**MODEL NUMBER**

---

**SERIAL NUMBER**

---

**DATE OF PURCHASE**

---

**Dealer Name**

---

**Address**

---

**City**

---

**Province**

---

**Postal Code**

---

**Telephone**

---

**TO PHONE:** Dial 1-905-568-7140 for:  
SERVICE (for your nearest Sharp Authorized Servicer)  
PARTS (for your Authorized Parts Distributor)  
ACCESSORIES  
ADDITIONAL CUSTOMER INFORMATION

**TO WRITE:** For service problems, warranty information, missing items and other assistance:  
Sharp Electronics of Canada Ltd.  
Customer Care  
335 Britannia Road East  
Mississauga, Ontario L4Z 1W9

**TO ACCESS THE INTERNET:** [www.sharp.ca](http://www.sharp.ca)

Please provide the following information when you write or call: model number, serial number, date of purchase, your complete mailing address (including Postal Code), your daytime telephone number (including area code) and description of the problem.

# SHARP®

## LIMITED WARRANTY

### Consumer Electronics Products

## Congratulations on your purchase!

Sharp Electronics of Canada Ltd. (hereinafter called "Sharp") gives the following express warranty to the first consumer purchaser for this Sharp brand product, when shipped in its original container and sold or distributed in Canada by Sharp or by an Authorized Sharp Dealer:

Sharp warrants that this product is free, under normal use and maintenance, from any defects in material and workmanship. If any such defects should be found in this product within the applicable warranty period, Sharp shall, at its option, repair or replace the product as specified herein.

This warranty shall not apply to:

- (a) Any defects caused or repairs required as a result of abusive operation, negligence, accident, improper installation or inappropriate use as outlined in the owner's manual.
- (b) Any Sharp product tampered with modified, adjusted or repaired by any party other than Sharp, Sharp's Authorized Service Centres or Sharp's Authorized Servicing Dealers.
- (c) Damage caused or repairs required as a result of the use with items not specified or approved by Sharp, including but not limited to head cleaning tapes and chemical cleaning agents.
- (d) Any replacement of accessories, glassware, consumable or peripheral items required through normal use of the product including but not limited to earphones, remote controls, AC adapters, batteries, temperature probe, stylus, trays, filters, belts, ribbons, cables and paper.
- (e) Any cosmetic damage to the surface or exterior that has been defaced or caused by normal wear and tear.
- (f) Any damage caused by external or environmental conditions, including but not limited to transmission line/power line voltage or liquid spillage.
- (g) Any product received without appropriate model, serial number and CSA and /or cUL markings.
- (h) Any products used for rental or commercial purposes.
- (i) Any installation, setup and/or programming charges.

Should this Sharp product fail to operate during the warranty period, warranty service may be obtained upon delivery of the Sharp product together with proof of purchase and a copy of this LIMITED WARRANTY statement to an Authorized Sharp Service Centre or an Authorized Sharp Servicing Dealer. In home warranty service may be provided at Sharp's discretion on any Sharp television with the screen size of 27" or larger and on any Sharp Over-the-Range Microwave Oven.

This warranty constitutes the entire express warranty granted by Sharp and no other dealer, service centre or their agent or employee is authorized to extend, enlarge or transfer this warranty on behalf of Sharp. To the extent the law permits, Sharp disclaims any and all liability for direct or indirect damages or losses or for any incidental, special or consequential damages or loss of profits resulting from a defect in material or workmanship relating to the product, including damages for the loss of time or use of this Sharp product or the loss of information. The purchaser will be responsible for any removal, reinstallation, transportation and insurance costs incurred. Correction of defects, in the manner and period of time described herein, constitute complete fulfillment of all obligations and responsibilities of Sharp to the purchaser with respect to the product and shall constitute full satisfaction of all claims, whether based on contract, negligence, strict liability or otherwise.

#### WARRANTY PERIODS:

WARRANTY PERIODS:	Parts & Labour (exceptions noted)
Audio Products	1 year
Camcorder	1 year
DVD Products	1 year
LCD Projector	1 year (lamp 90 days)
LCD TV	1 year
Microwave Oven	2 years (magnetron component-3 additional years)
Television Products	1 year (picture tube component-1 additional year)
VCR Products	1 year
Vacuum Cleaner	1 year
Air Purifier & Air Conditioners	1 year (filters 90 days)

To obtain the name and address of the nearest Authorized Sharp Service Centre or Dealer, please contact:  
SHARP ELECTRONICS OF CANADA LTD. 335 Britannia Road East Mississauga, Ontario L4Z 1W9

For more information on this Warranty, Sharp Canada Products, Accessory Sales, Dealer or Service Locations, please call (905) 568-7140

Visit our Web site: [www.sharp.ca](http://www.sharp.ca)



# PRECAUTIONS

Points to keep in mind when using your air conditioner.

## WARNINGS FOR USE

- **Install the air conditioner in accordance with the installation instructions in the latter section of this manual.**
- **Do not modify any part of this product.**
- **Do not insert anything into any part of the unit.**
- **Ensure the power supply used has an appropriate voltage rating.**  
Only use a three-pin grounded electrical AC socket rated 125V, 60Hz, and 15 amps or more as shown on the right.  
Use of a power supply with an improper voltage rating can result in damage to the unit and possibly fire.
- **Always use a fuse with the proper amp rating.**  
Do not, under any circumstances, use wire, pins or other objects in place of a proper fuse.
- **In the event of any abnormality with the air conditioner (ex. a burning smell), turn it off immediately and disconnect the power supply.**

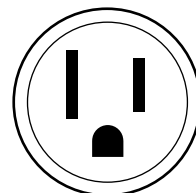

## WARNING FOR POWER SUPPLY CORD

- **This air conditioner uses a plug with a built-in fuse.**  
Read the precautions on the plug before using the air conditioner.
- **Always conduct a “Power Plug Check” (See Page 18) before use to confirm the power plug functions normally.**
- **This power plug must only be plugged into an appropriate wall socket. Do not use in conjunction with any extension cords.**
- **Push the power plug securely into the socket and make sure it is not loose.**
- **Do not pull, deform, or modify the power supply cord, or immerse it in water.**  
Pulling or misuse of the power supply cord can result in damage to the unit and cause electrical shock.
- **A damaged power supply cord must be replaced with a new power supply cord obtained from the product manufacturer and not repaired. Replacement must be performed by manufacturer's service agent in order to avoid a hazard.**

## NOTE

### Radio or TV Interference

If this room air conditioner should cause interference to radio or television reception, try to correct the interference by one or more of the following measures:

- Reorient or relocate the receiving antenna.
- Increase the separation between the room air conditioner and radio/TV receiver.
- Connect the room air conditioner into an outlet on a circuit different from that to which the radio/TV receiver is connected.
- Consult the dealer or an experienced radio/TV technician for help.



## WARNING ABOUT GROUNDING

- **Improper use of the grounding plug can result in the risk of electric shock.**

This appliance must be grounded. In the event of an electrical short circuit, grounding reduces the risk of an electric shock by providing a less resistant conduit for the electric current.

This appliance is equipped with a cord that has a grounding wire connected to a grounding plug. The plug must be plugged into a socket that is properly installed and grounded.

- **Do not under any circumstances cut or remove the round grounding pin from this plug.** Consult a qualified electrician or serviceman if the grounding instructions are not completely understood, or if in any doubt as to whether the appliance is properly grounded. If a grounding adapter is used, make sure the socket box is fully grounded.

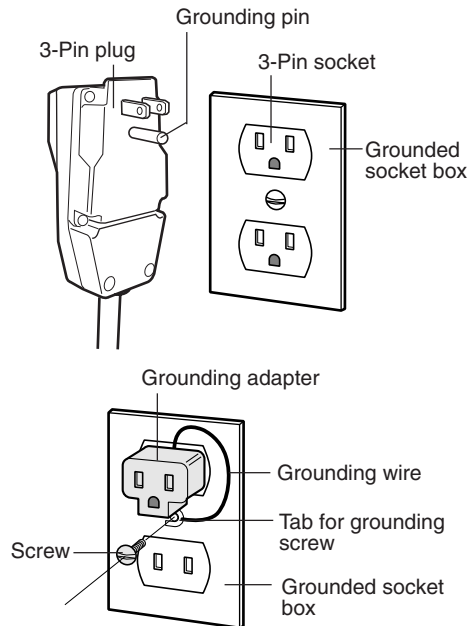

## USAGE CAUTIONS

- **Ventilate the room periodically during use, especially if using gas appliances.**
- **Be sure to turn the unit off and disconnect the power supply cord before performing any maintenance or cleaning.**
- **Do not splash or pour water directly onto the unit.**  
Water can cause electrical shock or equipment damage.
- **Drainage should be performed whenever moving the air conditioner. (See Page 29)**  
If any water remains in the tank, it may spill out while being moved.
- **Remove the window panel in the event of particularly adverse weather.**  
Extremely adverse weather may cause water to leak in through the openings.
- **To ensure proper drainage, the drainage hose must have no kinks or be on a different level during dehumidification mode.**  
The drained water may spill out into the room.
- **The temperature around the drainage hose must not be below freezing point when used.**  
Drained water may freeze inside the hose, causing water inside the unit to overflow into the room.
- **Do not block the exhaust air outlet with obstacles.**  
Cooling performance may be reduced or stop completely.

# PRECAUTIONS

## NOTES ON OPERATION

- **Allow 3 minutes for the compressor to restart cooling.**  
If you turn the air conditioner off and immediately restart it, allow three minutes for the compressor to restart cooling. There is an electronic device in the unit that keeps the compressor turned off for three minutes for safety.
- **In the event of a power failure during use, allow 3 minutes before restarting the unit.**  
After power is reinstated, restart the air conditioner. If the power was off for less than three minutes, be sure to wait at least three minutes before restarting the unit. If you restart the air conditioner within three minutes, a protective device in the unit may cause the compressor to shut off. This protective device will prevent cooling for about 5 minutes. Any previous settings will be canceled and the unit will return to its initial settings.
- **Low temperature operation: Is your unit freezing up?**  
Freezing may occur when the unit is set close to 64°F in low ambient temperature conditions, especially at night.  
In these conditions, a further temperature drop may cause the unit to freeze.  
Setting the unit to a higher temperature will prevent it from freezing.
- **Dehumidification mode increases room temperature.**  
The unit generates heat during dehumidification mode and the room temperature will rise. Warm air will be blown out from the Exhaust air outlet, but this is normal and does not indicate a problem with the unit.
- **This air conditioner blows the warm air generated by the unit outside the room via the exhaust hose while in cool mode.**  
Accordingly, the same amount of air as that blown out will enter the room from outside through any openings into the room.

## OPERATING CONDITIONS

- **The air conditioner must be operated within the temperature range indicated below.**

MODE	ROOM TEMPERATURE
COOL	64°F~95°F
Dehumidification	59°F~95°F

- A built-in safety device may cut off operation if the temperature exceeds these limits.
- When cooling operation is performed at high room temperature, the fan may run slightly slowed.

## ENERGY EFFICIENCY TIPS

- **Avoid direct sunlight.**  
Close blinds, drapes or shades to keep out direct sunlight while in cooling mode.
- **Keep the filter clean.**  
Keeping the filter clean greatly aids efficient operation.  
A dirty filter blocks the flow of air, making your air conditioner work harder and less efficiently. See page 30 on how to clean the filter.
- **Turn off unnecessary lights.**  
Your air conditioner must remove the heat produced by your lights or other heat-producing appliances. Turn off any lights or appliances that are not in use.
- **Turn off the air conditioner when no one is home.**  
Use only when necessary. The less time the air conditioner is used, the lower the running costs.

# LOCATION

- The air conditioner should be placed on a firm foundation to minimize noise and vibration. For safe and secure positioning, place the unit on a smooth, level floor strong enough to support the unit.
- The unit has casters to aid placement, but it should only be rolled on smooth, flat surfaces. Use caution when rolling on carpet surfaces. Do not attempt to roll the unit over objects.
- The unit must be placed within reach of a properly rated grounded socket.
- Never place any obstacles around the air inlet or outlet of the unit.
- Allow at least 12" (30cm) of space from the wall for efficient air-conditioning.

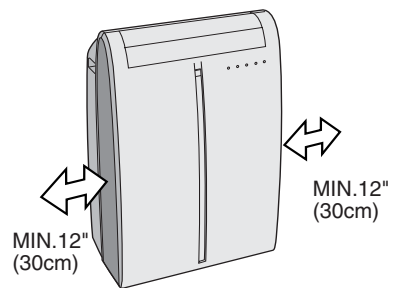

# INCLUDED

- Exhaust hose (1)    Window exhaust adapter (1)    Drainage Grommet (1)    Bracket (1)

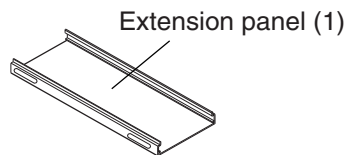
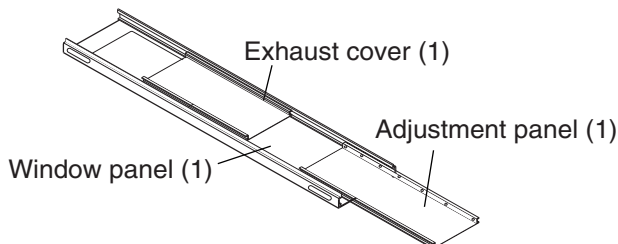
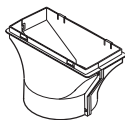
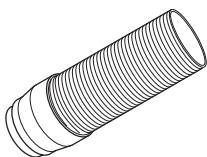

- Rain guard (2)    Insect guard net (1)    Foam seal (1)    Foam seal (3) (adhesive type)A    Foam seal (1) (adhesive type)B

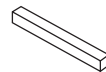
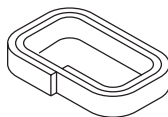
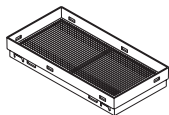

(thickness: 1/5")

(thickness: 2/5")

- Hose clamp (1)

- Screw (8)

- Remote control (1)

- Battery (2) (AAA.R03)

- Manual (1)

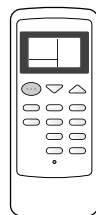

## SUGGESTED TOOLS FOR WINDOW PANEL INSTALLATION

1. Screwdriver (medium size Phillips)
2. Tape measure or ruler
3. Knife or scissors
4. Saw (In the event that the window panel needs to be cut down in size because the window is too narrow for direct installation.)

# PART NAMES

## FRONT VIEW

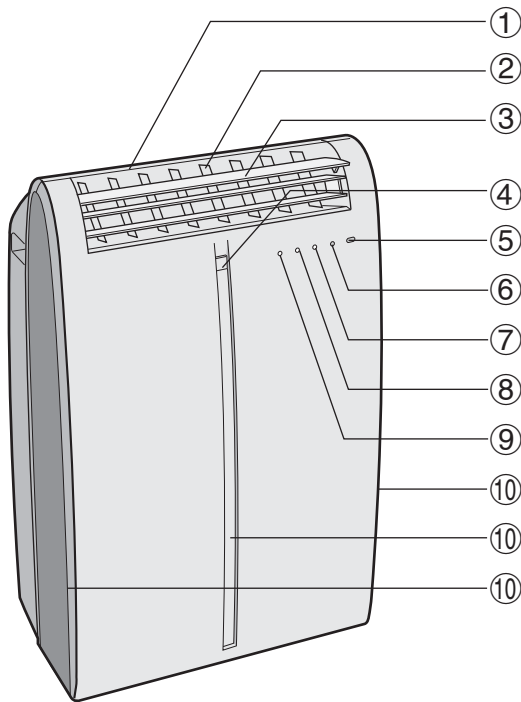

- ① Air Outlet
- ② Vertical louvers
- ③ Horizontal louvers
- ④ PLASMACLUSTER Lamp (blue)
- ⑤ Remote control signal receiver window
- ⑥ AUX. Button
- ⑦ OPERATION Lamp (red)
- ⑧ TIMER Lamp (orange)
- ⑨ MEGA COOL Lamp (green)
- ⑩ Air inlet

## REAR VIEW

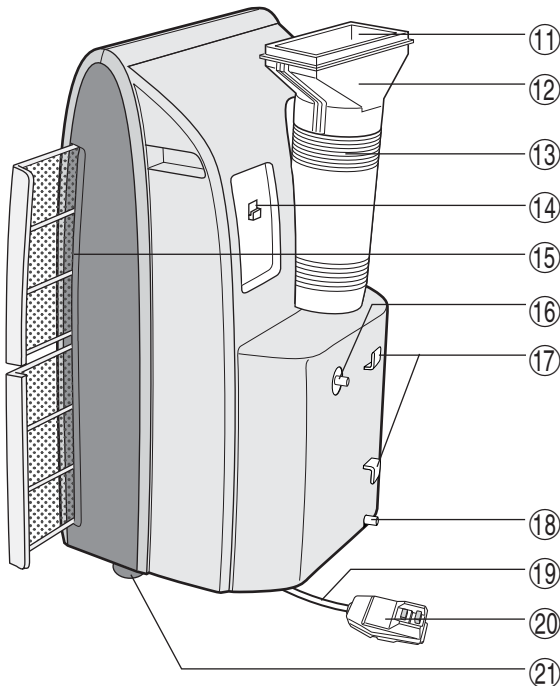

- ⑪ Exhaust air outlet
- ⑫ Window exhaust adapter
- ⑬ Exhaust hose
- ⑭ Remote control hook
- ⑮ Air filters
- ⑯ Drainage nozzle and stopcock
- ⑰ Power supply cord hooks
- ⑱ Drainpipe nozzle and stopcock
- ⑲ Power supply cord
- ⑳ Power plug
- ㉑ Casters(4)

NOTE: Actual unit might vary slightly from above illustration.

# REMOTE CONTROL

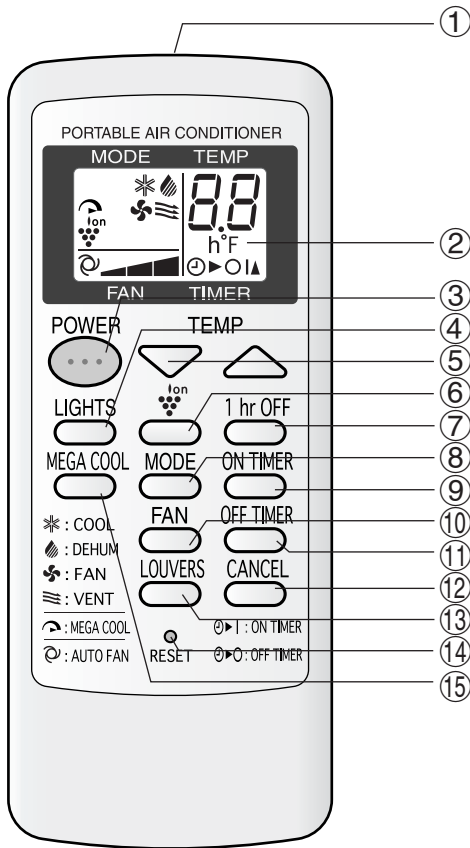

- ① Transmitter
- ② Display
- ③ POWER Button
- ④ LIGHTS Button
- ⑤ TEMPERATURE Button
- ⑥ PLASMACLUSTER Button
- ⑦ 1 hr OFF Button
- ⑧ MODE Button
- ⑨ ON TIMER Button
- ⑩ FAN Button
- ⑪ OFF TIMER Button
- ⑫ CANCEL Button
- ⑬ LOUVERS Button
- ⑭ RESET Button
- ⑮ MEGA COOL Button

# REMOTE CONTROL DISPLAY

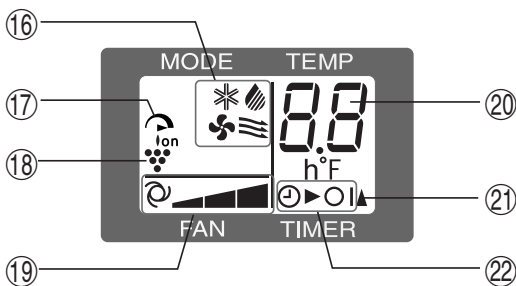

- ⑯ MODE SYMBOLS
  - ☼ : COOL
  - ☁ : DEHUMIDIFICATION
  - ☪ : FAN
  - ≡ : VENTILATION
- ⑰ MEGA COOL SYMBOL
- ⑱ PLASMACLUSTER SYMBOL
- ⑲ FAN SPEED SYMBOLS
  - ⌚ : AUTO
  - ▬ : Manual setting
- ⑳ TEMPERATURE AND TIMER COUNT DOWN INDICATOR
- ㉑ TRANSMITTING SYMBOL
- ㉒ ON TIMER / OFF TIMER SYMBOL

# INSTALL WINDOW PANEL

## Installation in a double-hung sash window

(See page 14 for installation in a sliding sash window. )

### 1 Connect the rain guards to the insect guard net.

Insert all three projections on each rain guard into the holes in the insect guard net. Side "A" will now be uppermost, as indicated in the diagram.

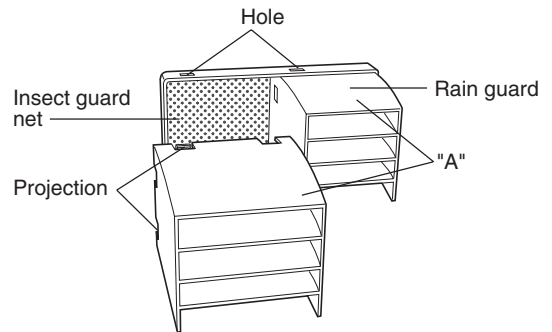

### 2 Attach the guard combined above to the window panel

Push the insect guard net firmly to ensure that its four projections fit into the holes in the window panel.

Side "A" will now be at the top, as indicated in the diagram.

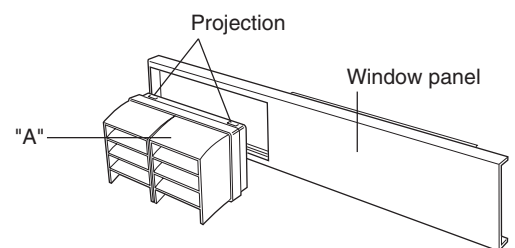

### 3 Cut the foam seal A (adhesive type) to the proper length and attach it to the window stool.

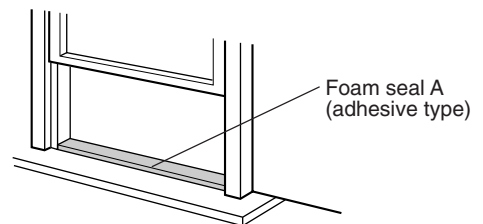

### 4 Attach the window panel to the window stool.

If the inner width of the window is between 22" (559mm) and 24" (609mm) inclusive.

The window panel cannot be installed in windows less than 22" (559mm) wide, as you will be unable to shut the exhaust cover.

- (1) Remove the adjustment panel from the window panel, and cut the window panel to the same width as the window.
- (2) Open the window sash and place the window panel on the window stool
- (3) Secure the window panel to the window stool with 2 screws.

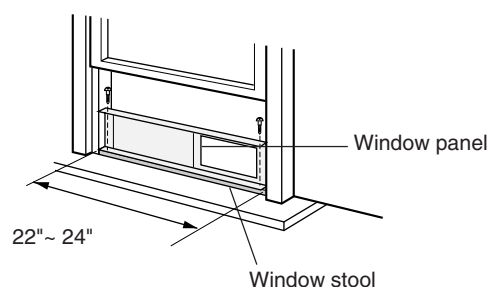
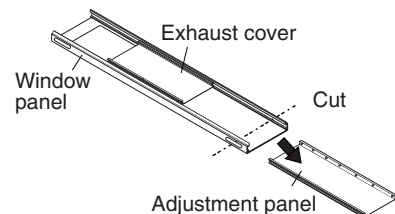

If the inner width of the window is between 24" (609mm) and 36.8" (934mm) inclusive.

- (1) Open the window sash and place the window panel on the window stool.
- (2) Slide the adjustment panel to fit the window frame width.
- (3) Secure the window panel to the stool with 3 screws.

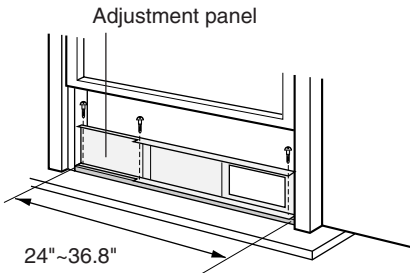

If the inner width of the window is between 36.8" (934mm) and 48" (1219mm) inclusive.

- (1) Attach the extension panel to the adjustment panel.
- (2) Open the window sash and place the window panel on the window stool.
- (3) Slide the adjustment and extension panels to fit the window frame width.
- (4) Secure the window panel to the window stool with 4 screws.

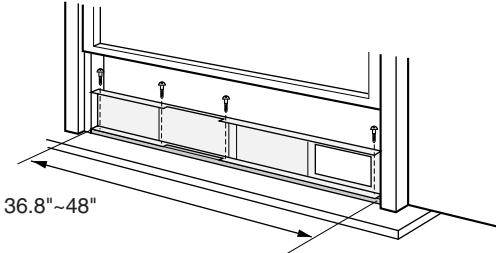
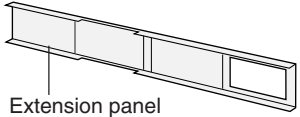

**5 Cut the foam seals (adhesive type) A and B to the proper length and attach it to the window panel.**

Attach foam seal A to the window panel and extension panel, and attach foam seal B to the adjustment panel.

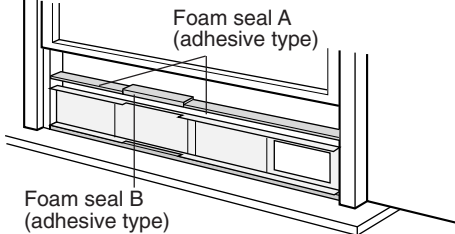

**6 Close the window sash securely against the Window panel.**

**7 Cut the foam seal to an appropriate length and seal the opening between the top of the inner window sash and the outer window sash.**

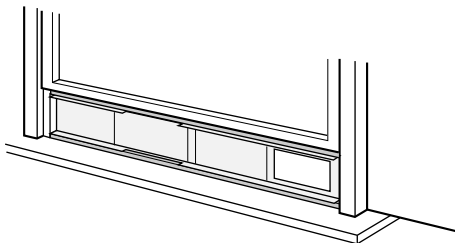

**8 Attach a bracket with the screw.**

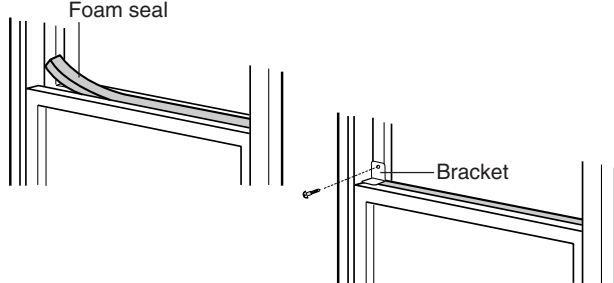

# INSTALL WINDOW PANEL

## Installation in a sliding sash window

(See page 12 for installation in a double-hung window.)

### 1 Connect the rain guards to the insect guard net.

Insert all three projections on each rain guard into the holes in the insect guard net. Side "A" will now be uppermost, as indicated in the diagram.

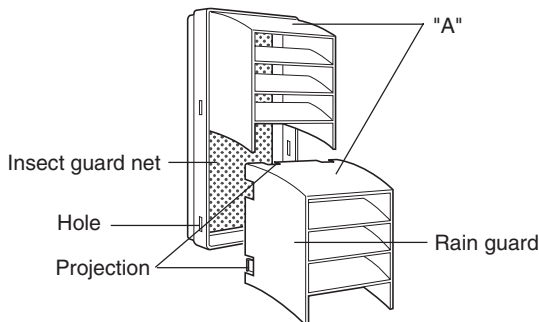

### 2 Attach the guard combined above to the window panel.

Push the insect guard net firmly to ensure that its four projections fit into the holes in the window panel. Side "A" will now be at the top, as indicated in the diagram, when it is installed in the window.

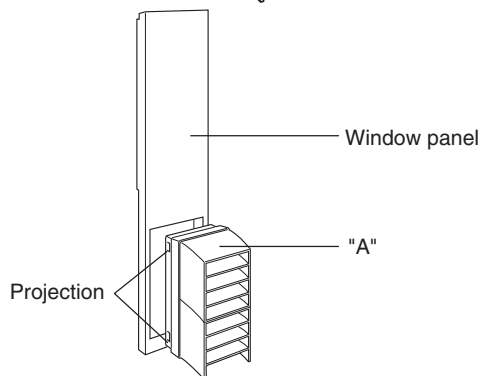

### 3 Cut the foam seal A (adhesive type) to the proper length and attach it to the window frame.

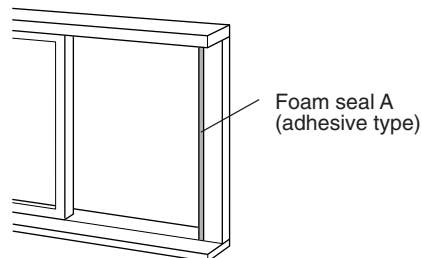

### 4 Install the window panel into the window frame.

If the inner height of the window is between 22" (559mm) and 24" (609mm) inclusive.

The window panel cannot be installed in windows less than 22" (559mm) high, as you will be unable to shut the exhaust cover.

- (1) Remove the adjustment panel from the window panel, and cut the window panel to the same height as the window.
- (2) Open the window sash and place the window panel on the window frame.
- (3) Secure the window panel to the window frame with 2 screws.

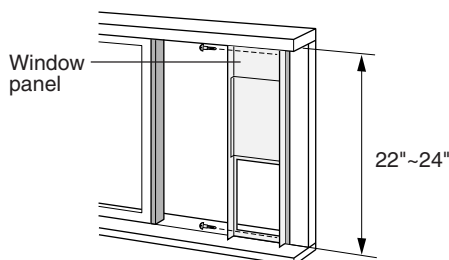
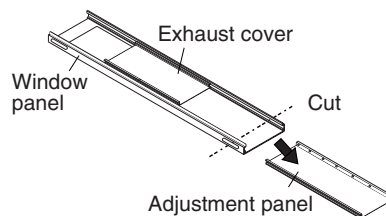



If the inner height of the window is between 24" (609mm) and 36.8" (934mm) inclusive.

- (1) Open the window sash and place the window panel on the window frame.
- (2) Slide the adjustment panel to fit the window frame height.
- (3) Secure the window panel to the window frame with 3 screws.

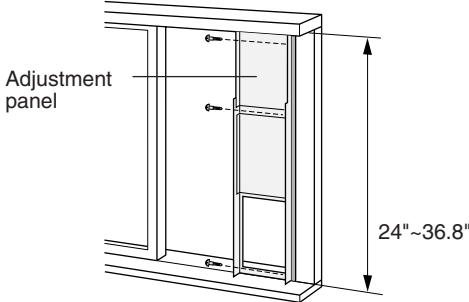

If the inner height of the window is between 36.8" (934mm) and 48" (1219mm) inclusive.

- (1) Attach the extension panel to the adjustment panel.
- (2) Open the window sash and place the window panel on the window frame.
- (3) Slide the adjustment and extension panels to fit the window frame height.
- (4) Secure the window panel to the window frame with 4 screws.

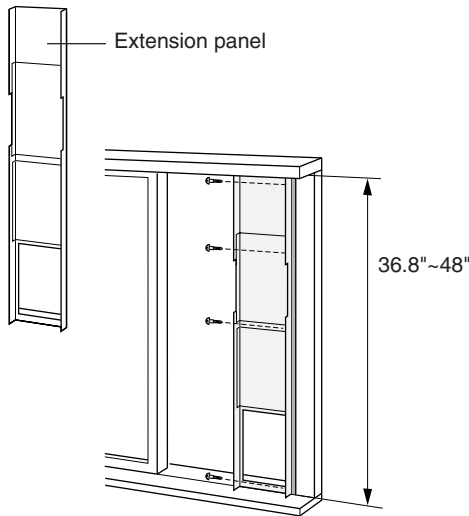

**5 Cut the foam seals (adhesive type) A and B to the proper length and attach them to the window panel.**

Attach foam seal A to the window panel and extension panel, and attach foam seal B to the adjustment panel.

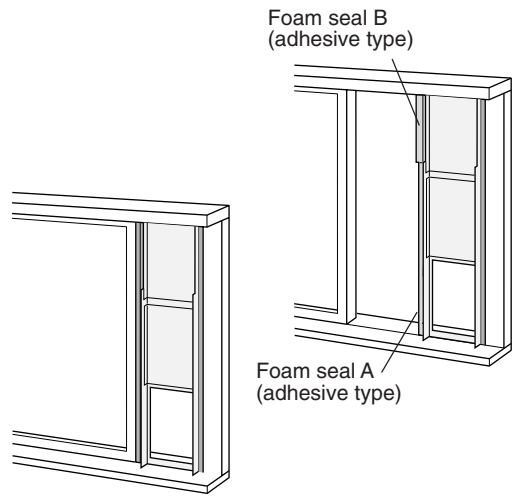

**6 Close the window sash securely against the Window panel.**

**7 Cut the foam seal to an appropriate length and seal the opening between the side of the inner window sash and the outer window sash.**

**8 Attach a bracket with the screw.**

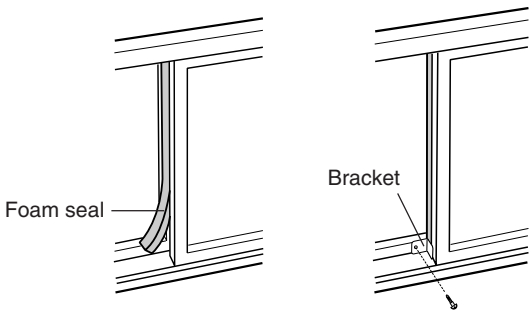

# INSTALLATION AND REMOVAL OF EXHAUST HOSE

The exhaust hose must be installed or removed in accordance with the usage mode.

MODE	EXHAUST HOSE
COOL, FAN, VENTILATION, DEHUMIDIFICATION with no container	Install
DEHUMIDIFICATION with container(minimum capacity 3 gallons)	Remove

## Installation of the exhaust hose

### 1 Attach the window exhaust adapter to the exhaust hose.

Extend one end of the exhaust hose and insert it into the window exhaust adapter, and turn it (approx. three times) until it stops.

Make sure they are securely attached afterwards.

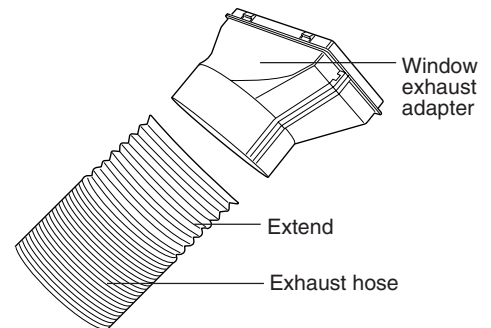

### 2 Attach the exhaust hose adapter to the unit.

Insert the two projections on the exhaust hose adapter into the two holes on the unit, and firmly attach them to each other.

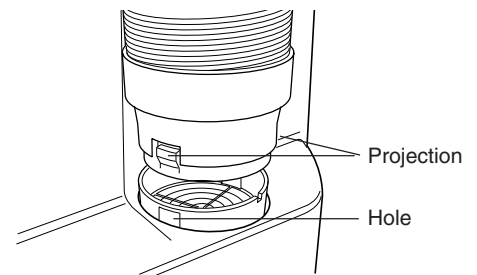

### 3 Slide and open the exhaust cover on the window panel, and attach the window exhaust adapter.

Surface of window exhaust adapter marked "TOP" should be at the top when it is installed in a double-hung sash window.

Surface of window exhaust adapter marked "TOP" should be on the window frame side when it is installed in a sliding sash window.

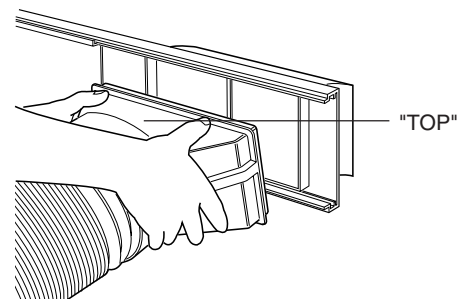

The exhaust hose should be as short as possible for operational efficiency; however, it must not be twisted or bent.

**Unacceptable**

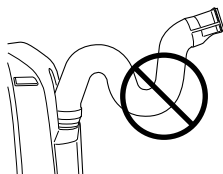

**Acceptable**

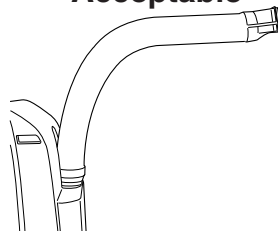

**Acceptable**

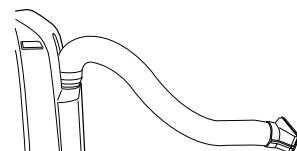

## Removal of the exhaust hose

### 1 Remove the window exhaust adapter.

Pull out and remove the window exhaust adapter by pushing down two "PUSH" markings, and slide and close the exhaust cover in the window panel.

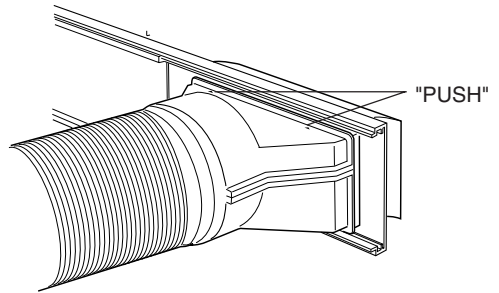

### 2 Remove the exhaust hose adapter from the unit.

Lift up and remove the exhaust hose adapter from the unit by pushing down on the two projections.

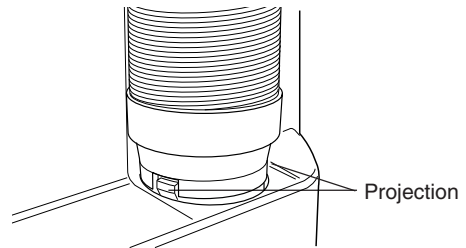

# PRE-OPERATION CHECKS

## POWER PLUG CHECK

This air conditioner uses a fused power plug. Always check the power plug before use.

- 1 Press the RESET button.**
- 2 Insert the power plug into the wall socket.**
- 3 Press the TEST button.**  
You will hear a **CLICK** if the circuit breaker is functioning correctly.
- 4 Press the RESET button until you hear another CLICK.**  
The circuit breaker is activated, power is supplied, and the air conditioner is now ready for use.

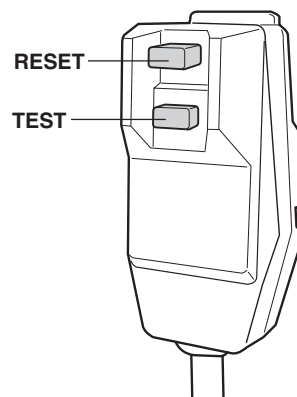

**Do not attempt to use the air conditioner if the above procedure is impossible, as it is malfunctioning. Disconnect the power plug and request service.**

## LOADING BATTERIES Use two AAA (R03) batteries.

- 1 Remove the battery cover at the back of the remote control.**
- 2 Insert batteries into the compartment, making sure the  $\oplus$  and  $\ominus$  polarities are correctly aligned.**
  - Lines will appear on the display when batteries are properly installed.
- 3 Reattach the battery cover.**
- 4 Press the RESET button using a thin pointed implement.**

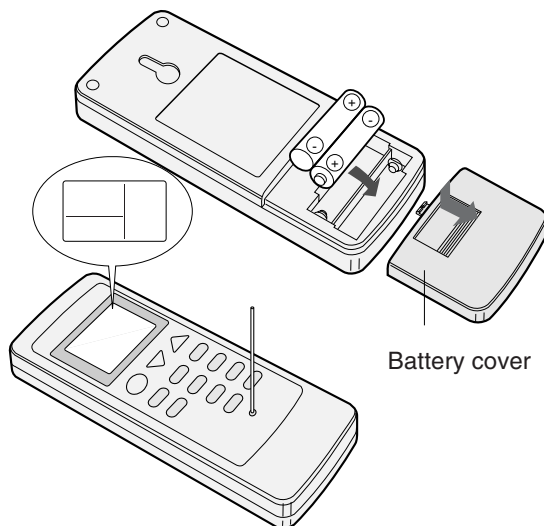

### NOTES:

- The battery should last approximately one year under normal use.
- When replacing the batteries, always change both batteries at the same time, and make sure they are the same type.
- If the remote control does not operate normally after replacing the batteries, press the RESET button using a thin pointed implement.
- If you will not be using the unit for a prolonged period, remove the batteries from the remote control.

## HOW TO USE THE REMOTE CONTROL

Point the remote control towards the units signal receiver window and press the desired button. A beep will sound when the unit receives the signal.

- Make sure nothing, such as curtains, blocks the signal receiver window.
- The remote control operates up to 23 feet (7 meters) away.

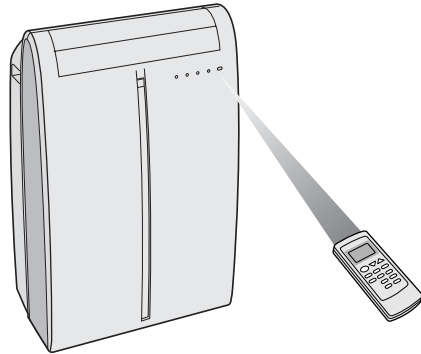

### CAUTION

- Do not expose the signal receiver window to direct sunlight. This may adversely affect its operation. If necessary, close the curtains to block out the sunlight.
- Use of a fluorescent lamp in the same room may interfere with transmission of the signal.
- The unit may be affected by signals emitted from other remote controllers for televisions, VCRs or other equipment used in the same room.
- Do not leave the remote control exposed to direct sunlight or near a heater. Protect the remote control from moisture and shock which can discolor or damage it.

**To prevent the remote control from being misplaced, hook it to the unit when not in use.**

When attached, to remove the remote control from the unit, lift the remote control up slightly and pull it out.

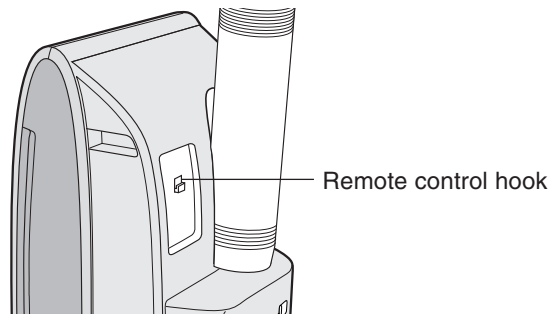

# COOL MODE

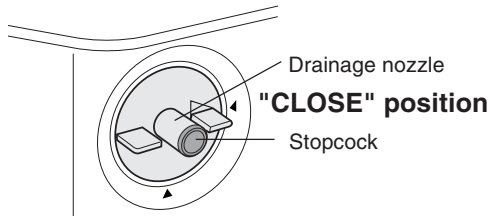

Install the exhaust hose (See Page16), turn the drainage nozzle to the **CLOSE** position, and check the drainage nozzle is covered with the stopcock.

- 1 Press the **MODE** button to select **COOL** mode.



- 2 Press the **POWER** button to start operation.

- The red OPERATION lamp on the unit will light.

- 3 Press the **TEMPERATURE** button to set the desired temperature.

- The temperature can be set within the range of 64°F to 86°F.

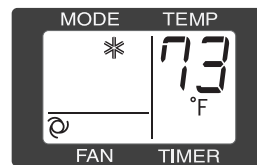
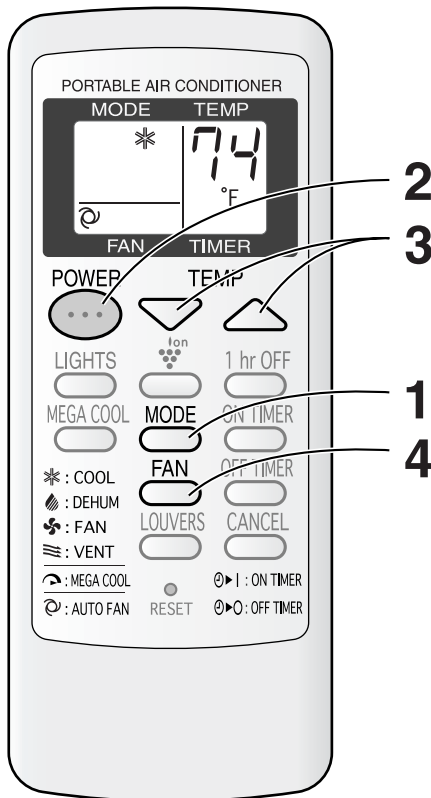

- 4 Press the **FAN** button to set the desired fan speed.

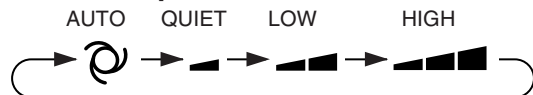

## TO TURN OFF

Press the **POWER** button again.

- The red OPERATION lamp on the unit will turn off.

# DEHUMIDIFICATION MODE

In this mode, the air conditioner dehumidifies the room.

## Dehumidification with container

- 1 Remove the exhaust hose (See Page 17)
- 2 Turn the drainage nozzle to the OPEN position.
- 3 Pull the stopcock out from the drainage nozzle.
  - When the stopcock is removed, a small amount of water may be discharged from the drainage nozzle.
  - Always perform this procedure with the unit turned off. Drain water will spout out if attempted during operation.
- 4 Insert the hose clamp into a standard commercially-available hose (5/8" inner diameter, 7/8" outer diameter) and attach the drain grommet to the hose.
- 5 Attach the hose to the drainage nozzle, and secure it with the hose clamp.
  - Insert the hose securely into a container with a minimum capacity of 3 gallons. Be sure to monitor the water level in the container and empty as necessary. Do not operate in dehumidify mode for more than 8 hours at a time. Be sure to empty the water container whenever dehumidify mode is started. Failure to empty the water container can cause the container to overflow and cause damage to underlying materials.
  - Set the hose sloping downwards for easier drainage. Moreover, do not bend the hose at any point, nor allow the end to be submerged in water.

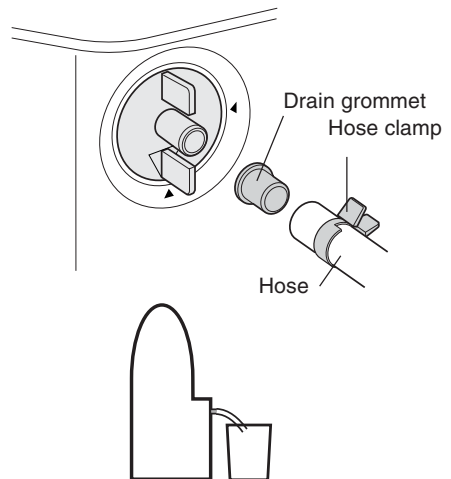
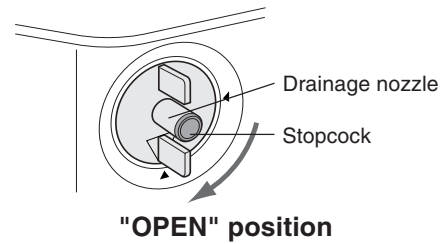

## Dehumidification with no container

If draining of the water is not desirable, install the exhaust hose (See Page 16), turn the drainage nozzle to the CLOSE position, and check that the drainage nozzle is covered with the stopcock. In this operation, the water tank inside the unit may be full, the unit stops operating and then the TIMER, OPERATION and MEGA COOL lamps are blinking, depending on room condition. In this case, drain out the water within the unit (See Page 29).

ENGLISH

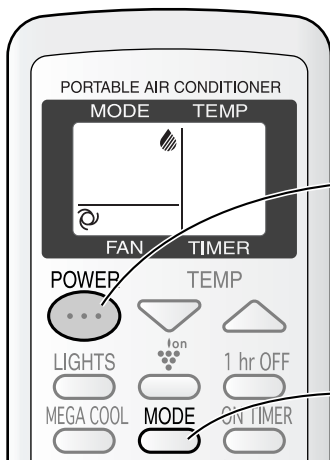

- 1 Press the MODE button to select DEHUMIDIFICATION mode.



- 2 Press the power button to start operation.

- The red OPERATION lamp on the unit will light.
- The temperature cannot be set.
- The fan speed is preset to AUTO and cannot be changed.

### TO TURN OFF

Press the POWER button again.

- The red OPERATION lamp on the unit will turn off.

### CAUTION

When operating dehumidification with container, the unit generates heat during dehumidification mode and the room temperature will rise. Operate dehumidification with no container if you don't want the room temperature to rise. This will help to slightly drop the room temperature, but dehumidification performance will become less effective than when operating dehumidification with container.

# FAN MODE

In this mode, the air conditioner simply circulates the air without cooling it.

Install the exhaust hose (See Page16), turn the drainage nozzle to the CLOSE position, and check the drainage nozzle is covered with the stopcock.

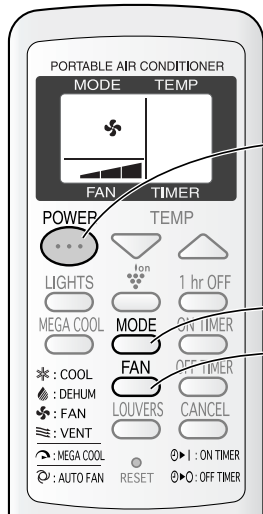

**1 Press the MODE button to select FAN mode.**



**2 Press the POWER button to start operation.**

- The red OPERATION lamp on the unit will light.
- The temperature cannot be set.

**3 Press the FAN button to set the desired fan speed.**

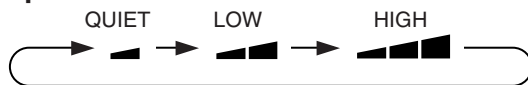

## TO TURN OFF

**Press the POWER button again.**

- The red OPERATION lamp on the unit will turn off.

# VENTILATION MODE

In this mode, the air conditioner ventilates the air to outdoors.

Install the exhaust hose (See Page 16), turn the drainage nozzle to the CLOSE position, and check the drainage nozzle is covered with the stopcock.

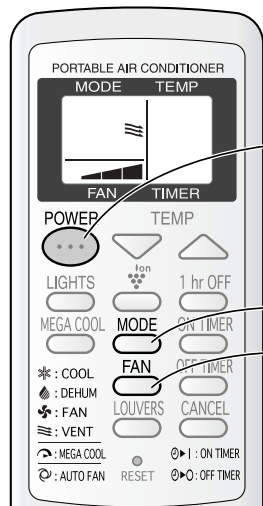

**1 Press the MODE button to select VENT mode.**



**2 Press the POWER button to start operation.**

- The red OPERATION lamp on the unit will light.
- The temperature cannot be set.

**3 Press the FAN button to set the desired fan speed.**

- Although the louvers are closed and no air blows out into the room, the external ventilation fan speed changes.

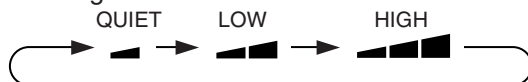

## TO TURN OFF

**Press the POWER button again.**

- The red OPERATION lamp on the unit will turn off.



# TO CHANGE AIR FLOW DIRECTION

## UP / DOWN AIR FLOW DIRECTION

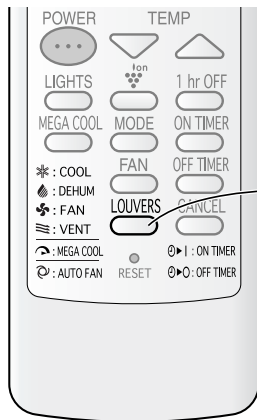

**1** Press the **LOUVERS** button on the remote control.

- The horizontal louvers will swing continuously.

**2** Press the **LOUVERS** button again when the horizontal louvers are at the desired position.

- The horizontal louvers will stop moving.
- The adjusted position will be memorized and the same position will be set automatically when operated the next time.

### NOTE

- During VENTILATION mode, UP/DOWN air flow direction cannot be changed.

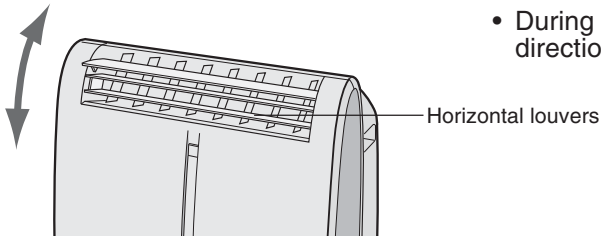

## LEFT / RIGHT AIR FLOW DIRECTION

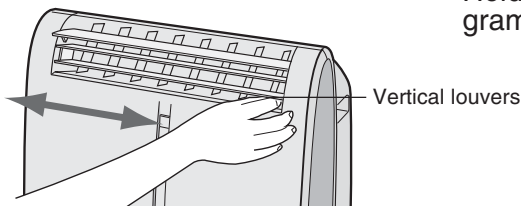

Hold the vertical louver as shown in the diagram and adjust the air flow direction.

### CAUTION

Never attempt to adjust the horizontal louvers manually.

- Manual adjustment of the horizontal louvers can cause the unit to malfunction when the remote control is used for adjustment.
- When the horizontal louvers are positioned at the lowest position in the COOL or DEHUMIDIFICATION mode for an extended period of time, condensation may result.

Do not adjust the vertical louvers to the extreme left or right in the COOL mode with the fan speed set to "QUIET (■)" for an extended period of time.

Condensation may form on the louvers.

# PLASMACLUSTER OPERATION

The Plasmacluster ion generator inside the air conditioner will release positive and negative Plasmacluster ions into the room. Approximately the same numbers of positive and negative ions released into the air.

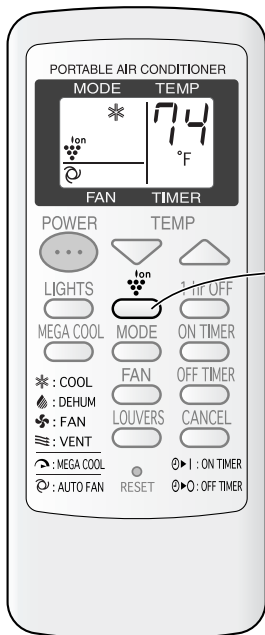

## 1 Press the PLASMACLUSTER button during operation.

- The remote control will display “”.
- The blue PLASMACLUSTER lamp on the unit will light.

### TO CANCEL

## 1 Press the PLASMACLUSTER button again.

- The PLASMACLUSTER lamp on the unit will turn off.

### NOTES:

- Use of the PLASMACLUSTER function will be memorized and it will be activated the next time you turn on the air conditioner.
- To turn off the PLASMACLUSTER Lamp, press the LIGHTS button.
- PLASMACLUSTER operation cannot be set during VENTILATION mode.

# MEGA COOL OPERATION

In this operation, the air conditioner fan works at extra high speed with a setting temperature of 59°F.

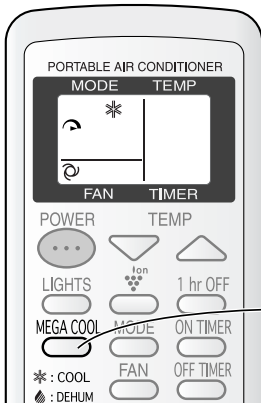

## 1 Press the MEGA COOL button during cooling mode.

- The remote control will display "  ".
- The temperature display will go off.
- The green MEGA COOL lamp on the unit will light.

### TO CANCEL

#### Press the MEGA COOL button again.

- MEGA COOL operation is also cancelled when the mode is changed, or when the unit is turned off.
- The green MEGA COOL lamp on the unit will turn off.

### NOTES:

- You cannot set the temperature or fan speed during MEGA COOL operation.
- The fan returns to the HIGH speed setting after the unit has run for 30 minutes in MEGA COOL mode.
- The extra high fan speed may automatically slow down to protect the unit.

# ONE-HOUR OFF TIMER

When the ONE-HOUR OFF TIMER is set, the unit will automatically turn off after one hour.

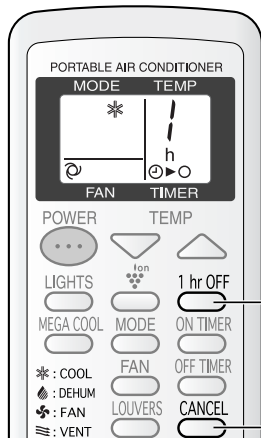

## 1 Press the 1hr OFF button.

- The remote control displays "  h  ".
- The orange TIMER lamp on the unit will light.
- The unit will stop operating after one hour.

### TO CANCEL

#### Press the CANCEL button.

- The orange TIMER lamp on the unit will turn off.

Alternatively, turn the unit off by pressing the POWER button.

- The red OPERATION lamp and the orange TIMER lamp on the unit will turn off.

### NOTES:

- The ONE-HOUR OFF TIMER operation has priority over ON TIMER and OFF TIMER operations.
- If the ONE-HOUR OFF TIMER is set while the unit is not operating, the unit will operate for an hour at the formerly set condition.
- If you wish to operate the unit for another hour before the ONE-HOUR OFF TIMER is activated, press the 1hr OFF TIMER button again during operation.

# TIMER OPERATION

## OFF TIMER

The unit will turn off automatically according to your setting.

Timer duration can be set from a minimum of half an hour (30 minutes) to a maximum of 12 hours.

Up to 9.5 hours, you can set in half-hour (30-minutes) increments and from 10 to 12 hours, in 1-hour increments.

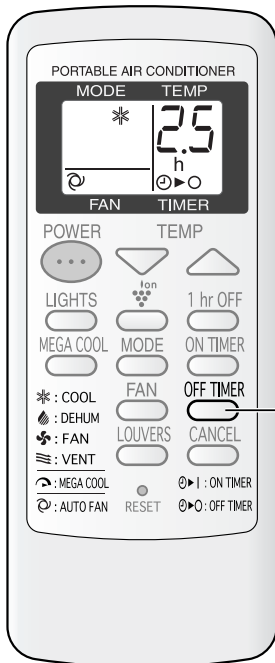

Display shown when you set the unit to turn off 2.5 hours later.

Point the remote control at the signal receiver window on the unit.

### 1 Press the OFF TIMER button and set the time as desired.

- The time setting will change as you press the button as follows.

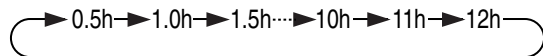

Hold the button down to speed through the settings.

- The orange TIMER lamp on the unit will light.
- The unit will emit a beep when it receives the signal.
- The time setting will count down to show the remaining time.

### TO CANCEL TIMER

Press the CANCEL button.

- The orange TIMER lamp on the unit will turn off.

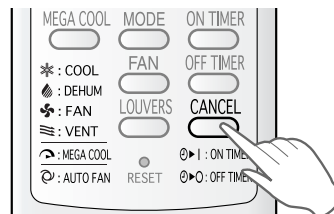

## NOTES ON TIMER SETTING AND OPERATION

- The latest time setting will be memorized and will appear on the remote control display the next time you set the OFF TIMER or ON TIMER.
- The OFF TIMER and ON TIMER can not be set together. Only the most recent TIMER setting will be valid.
- While the ONE-HOUR OFF TIMER is set, the OFF TIMER and ON TIMER settings are unavailable.
- If the ONE-HOUR OFF TIMER is set while the OFF TIMER or ON TIMER is activated, the ON TIMER or OFF TIMER setting will be cancelled.
- If a power failure occurs while the OFF TIMER or ON TIMER is set, the TIMER setting will be cancelled and will not be retrieved even after the power is restored.

# ON TIMER

The unit will turn on automatically according to your setting.

Timer duration can be set from a minimum of half an hour (30 minutes) to a maximum of 12 hours.

Up to 9.5 hours, you can set in half-hour (30-minute) increments and from 10 to 12 hours, in 1-hour increments.

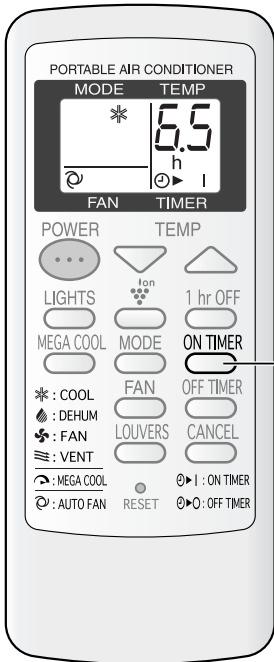

Display shown when you set the unit to turn on 6.5 hours later.

Point the remote control at the signal receiver window on the unit.

## 1 Press the ON TIMER button.

- The time setting will change as you press the button as follows.

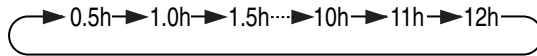

Hold the button down to speed through the settings.

- The orange TIMER lamp on the unit will light.
- The unit will emit a beep when it receives the signal.
- The time setting will count down to show the remaining time.

Select the mode, temperature, fan speed setting and PLASMACLUSTER operation as desired.

- When the temperature is set with the ON TIMER, the temperature will show in the display for 5 seconds and then return to the time display.
- If you do not change the setting, the unit will operate using the most recent setting.

## TO CANCEL TIMER

Press the CANCEL button.

- The orange TIMER lamp on the unit will turn off.

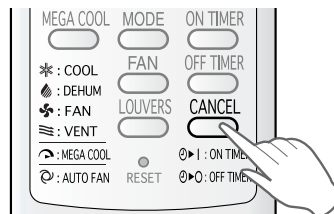

# AUXILIARY MODE

Use this mode when the remote control is not available.

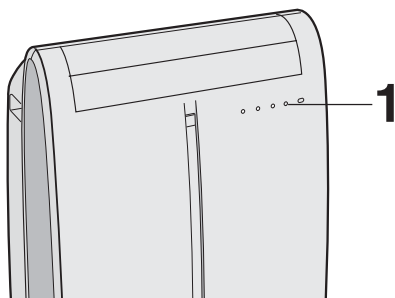

## 1 Press the **AUX.** button on the unit.

- The red OPERATION lamp on the unit will light and the unit will start operating in COOL mode.
- The fan speed is set to AUTO.
- The temperature setting is automatically set according to the room temperature.

### TO TURN OFF

**Press the AUX. button again.**

- The red OPERATION lamp on the unit will turn off.

### NOTES:

- If the AUX. button is pressed during normal operation, the unit will turn off.
- Upon starting AUXILIARY operation, the drainage pump inside the unit runs for about a minute, which may produce an audible gurgling sound.

# DRAINAGE

Prepare for drainage and drain out water within the unit in the following cases.

If the unit stops operating and the **TIMER**, **OPERATION** and **MEGA COOL** lamps are blinking. (This indicates that the water tank inside the unit is full.)

- 1 Make sure to turn the unit off.**
- 2 Turn the drainage nozzle to the OPEN position.**
- 3 Pull the stopcock out from the drainage nozzle.**
  - When the stopcock is removed, a small amount of water may be discharged from the drainage nozzle.
- 4 Insert the hose clamp into a standard commercially available hose (5/8" inner diameter, 7/8" outer diameter) and attach the drain grommet to the hose.**
- 5 Attach the hose to the drainage nozzle, and secure it with the hose clamp.**
  - Prepare for draining, as drain water will come out through the hose during operation.
- 6 Press the AUX. button on the unit twice.**
  - The water will drain out through the drainage hose. Maximum amount of water that may be drained out is approximately 4<sup>1</sup>/<sub>5</sub> pints.
  - The **OPERATION**, **TIMER** and **MEGA COOL** lamps will be blinking.
- 7 When drainage water stops running out from the hose, turn the unit off by pressing AUX. button.**
  - This would take about one minute.
- 8 Remove the hose from the drainage nozzle, and replace the stopcock.**
  - Keep the hose clamp and drain grommet in case of re-used.
- 9 Turn the drainage nozzle to the CLOSE position.**

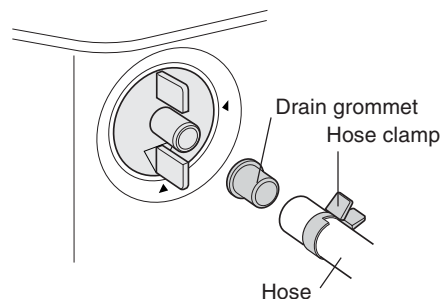
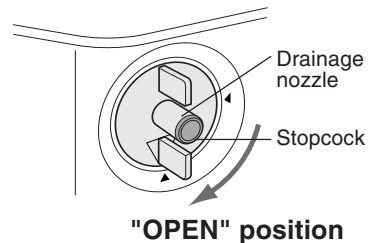

ENGLISH

Whenever the unit is moved (to prevent water within the unit from spilling).  
When the unit is not used for a long time.

- 1 Carry out the above procedures from 1 to 5.**
- 2 Press the AUX. button on the unit.**
  - The water will drain out through the drainage hose. Maximum amount of water that may be drained out is approximately 4<sup>1</sup>/<sub>5</sub> pints.
  - The **OPERATION** lamps will light.
- 3 When drainage water stops running out from the hose, turn the unit off by pressing AUX. button.**
  - This would take about one minute.
- 4 Remove the hose from the drainage nozzle, and replace the stopcock.**
  - Keep the hose clamp and drain grommet in case of re-used.
- 5 Turn the drainage nozzle to the CLOSE position.**
- 6 Remove the stopcock from the drainpipe nozzle, and completely drain any water within the unit.**
  - Always prepare a receptacle to collect the water before draining. Maximum amount of water that may be drained out is approximately 2<sup>2</sup>/<sub>5</sub> pints.
- 7 Replace the stopcock to the drainpipe nozzle.**

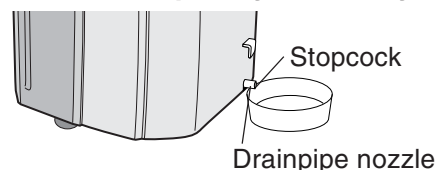

# MAINTENANCE

Be sure to disconnect the power from the wall socket before performing any maintenance.

## CLEANING THE FILTERS

If the filter is clogged with dust, the airflow will be reduced, resulting in poor cooling performance. The filter should be cleaned every two weeks.

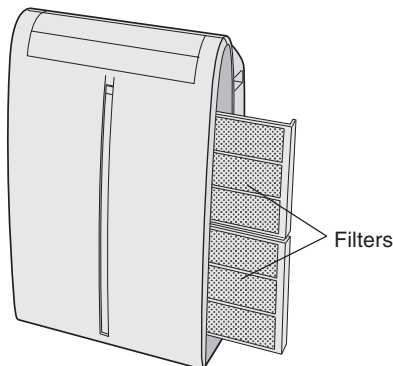

### 1 REMOVE THE FILTERS

- Gently pull the filter handle to the right and slide the filter out of the unit.

### 2 CLEAN THE FILTERS

- Use a vacuum cleaner to remove any dust. If the filters are very dirty, wash them with detergent and rinse carefully with clean water. Dry the filters in the shade before reinstalling them.

### 3 REINSTALL THE FILTERS

- Hold the filter handle and gently push the filter back into place. Never operate the unit without the filter. Doing so may result in serious damage to the unit.

## CLEANING THE UNIT AND THE REMOTE CONTROL

Wipe them with a soft, dry cloth or with a cloth moistened with a mild soap. Carefully remove any residue by wiping with a damp cloth and dry completely. Avoid splashing water onto the unit. Water can dangerously damage the electrical insulation. Never use harsh chemicals or abrasive cleaners on any part of the unit. To avoid damaging the unit, do not use hot water (120°F/50°C or hotter) when cleaning.

## CLEANING THE INSECT GUARD NET

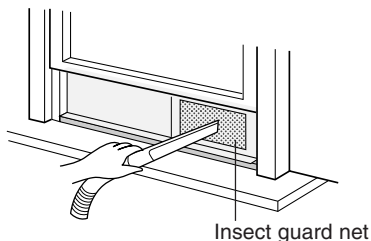

The cooling performance may be reduced or stop completely if the insect guard net becomes clogged with dust.

Periodically remove the window exhaust adapter from the window panel and clean the insect guard net with a vacuum cleaner or suchlike.

## MAINTENANCE AFTER AIR CONDITIONER SEASON

- 1 Perform drainage to drain out water within the unit. (See Page 29 "When the unit is not used for a long time").
- 2 Operate the unit the FAN or VENTILATION mode for about half a day to thoroughly dry inside the unit.
- 3 Clean the filters, then reinstall them.



# BEFORE CALLING FOR SERVICE

If the unit appears to be malfunctioning, check the following points before calling for a service.

## AIR CONDITIONER DOES NOT OPERATE AT ALL

- Is the unit plugged in or is the plug loose?
- Has the fuse blown or is the circuit breaker tripped?
- Did you restart the unit within 3 minutes of a power failure?  
If the power was off for less than 3 minutes when, you restarted the air conditioner, a protective device may cause the compressor to shut off, preventing cooling for about 5 minutes.
- Are the OPERATION, TIMER and MEGA COOL lamps blinking?  
The water tank inside the unit is full. It must be drained. (See page29)
- Check the power plug. (See page18)

## AIR CONDITIONER DOES NOT COOL PROPERLY

- Is it set to FAN, DEHUMIDIFICATION or VENTILATION mode?  
Cooling does not take place in these modes. Change the MODE setting.
- Are the filters clogged with dust?  
Clean and replace the filters.
- Is the cooling coil frozen?  
No air will blow out if the cooling coil is frozen.  
Run the air conditioner in FAN mode with the fan speed set to "HIGH" until all ice dissipates.
- Is the temperature set properly?
- Is the window exposed to direct sunlight?  
Close the curtains or blinds to minimize solar energy heating the room.
- Is the exhaust hose too long?  
For efficient operation, make the hose as short as possible. The exhaust hose must not be twisted or bent.

## SOUNDS

- The unit may seem rather loud for the first 2 to 3 minutes when the unit is turned on. This is the sound of the compressor starting-up and is perfectly normal.
- A soft, swishing noise can be heard immediately after the unit is turned on or off, and also during operation. This is the sound of the refrigerant flowing inside the unit.
- A low buzzing noise is emitted when the unit is generating Plasmacluster ions.
- This air conditioner evaporates water condensed during cooling operation within the unit through the exhaust air outlet. Although water flowing sound may be heard, this is normal.
- An audible gurgling sound may be heard for about a minute upon starting AUXILIARY mode. This is sound of running drainage pump inside the unit.
- **An audible gurgling sound may be heard when the unit is operated on a gently sloping floor. Place the unit on a level floor.**

## TIMER DOES NOT WORK PROPERLY

- If a power failure occurs while the TIMER is set, the TIMER setting will be cancelled and will not be retrieved even after the power is restored. This is normal for this unit.

## THE UNIT FAILS TO REACT TO THE REMOTE CONTROL SIGNAL

- Check the batteries in the remote control. Replace if necessary.
- Try to send the signal again with the remote control pointed directly at the unit's signal receiver window.
- Check whether the remote control batteries are installed with the polarities properly aligned.

## THE DISCHARGED AIR HAS AN ODOR

- Plasmacluster ion generator emit small traces of ozone which may produce an odor. These ozone emissions are below safety levels set by the FDA.

## Free Manuals Download Website

<http://myh66.com>

<http://usermanuals.us>

<http://www.somanuals.com>

<http://www.4manuals.cc>

<http://www.manual-lib.com>

<http://www.404manual.com>

<http://www.luxmanual.com>

<http://aubethermostatmanual.com>

Golf course search by state

<http://golfingnear.com>

Email search by domain

<http://emailbydomain.com>

Auto manuals search

<http://auto.somanuals.com>

TV manuals search

<http://tv.somanuals.com>