

MODEL
AJ-5030

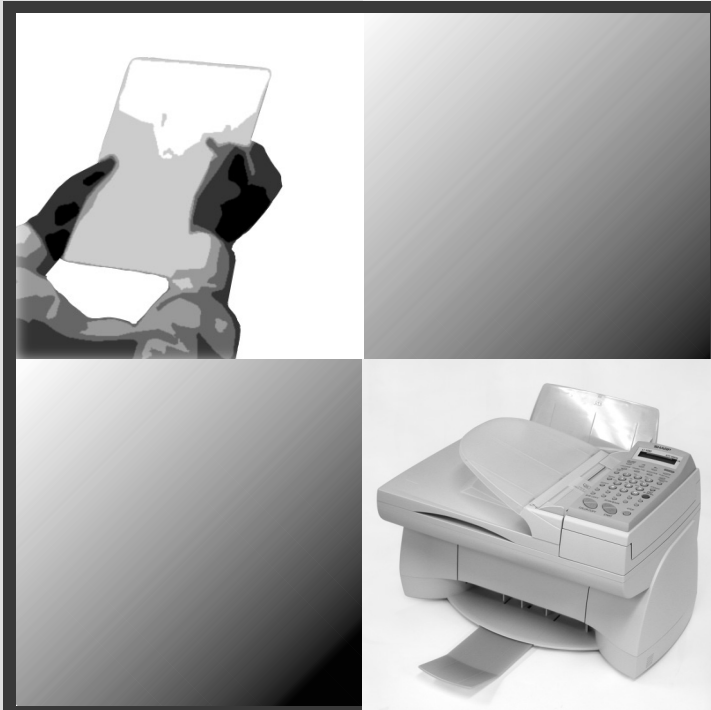

COLOR INKJET ALL-IN-ONE
OPERATION MANUAL

1. Installation
2. Copying
3. Sending Faxes
4. Receiving Faxes
5. Printing
6. Scanning
7. Answering Machine Hookup
8. Printing Lists
9. Maintenance and Troubleshooting

SHARP[®]

WARNING - FCC Regulations state that any unauthorized changes or modifications to this equipment not expressly approved by the manufacturer could void the user's authority to operate this equipment.

Note: This equipment has been tested and found to comply with the limits for a Class B digital device, pursuant to Part 15 of the FCC Rules. These limits are designed to provide reasonable protection against harmful interference in a residential installation. This equipment generates, uses and can radiate radio frequency energy and, if not installed and used in accordance with the instructions, may cause harmful interference to radio communications. However, there is no guarantee that interference will not occur in a particular installation. If this equipment does cause harmful interference to radio or television reception, which can be determined by turning the equipment off and on, the user is encouraged to try to correct the interference by one or more of the following measures:

- Reorient or relocate the receiving antenna.
- Increase the separation between the equipment and the receiver.
- Connect the equipment into an outlet on a circuit different from that to which the receiver is connected.
- Consult the dealer or an experienced radio/TV technician for help.

ABOUT THE TELEPHONE CONSUMER PROTECTION ACT OF 1991

"The Telephone Consumer Protection Act of 1991 makes it unlawful for any person to use a computer or other electronic device to send any message via a telephone facsimile machine unless such message clearly contains in a margin at the top or bottom of each transmitted page or on the first page of the transmission the following information:

- (1) The date and time of transmission.
- (2) Identification of either the business, business entity or individual sending the message.
- (3) Telephone number of either the sending machine, business, business entity or individual.

In order to program this information into your facsimile machine, please refer to the appropriate instructions in the operation manual."



As an ENERGY STAR[®] partner, SHARP has determined that this product meets the ENERGY STAR[®] guidelines for energy efficiency.

Declaration of Conformity

SHARP COLOR MULTIFUNCTION, AJ-5030

This device complies with Part 15 of the FCC rules. Operation is subject to the following two conditions:

- (1) This device may not cause harmful interference, and (2) this device must accept any interference received, including interference that may cause undesired operation.

Responsible Party:

SHARP DOCUMENT NETWORK SYSTEM OF AMERICA
Sharp Plaza, Mahwah, New Jersey 07430-2135 TEL: 1-800-
BE-SHARP

Introduction

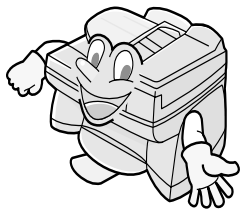

Welcome, and thank you for choosing a Sharp Color Inkjet All-in-One! The features and specifications of your Color Inkjet are shown below.

Print specifications

Printer type	Color thermal inkjet, dual cartridge
Print cartridges	Color cartridge: Sharp AJ-C50C Black cartridge: Sharp AJ-C50B
Print speed	Color: 3.5 ppm Black: 7.5 ppm (600 × 300 dpi)
Resolution	Quick: 600 × 300 dpi Normal: 600 × 600 dpi High: Enhanced 1200 × 1200 dpi
Print media	Plain paper, coated paper, glossy paper, transparencies, iron-on transfers, envelopes

Copy specifications

Copy speed	Color: 3.5 cpm Black: 7.5 cpm (300 × 300 dpi)
Resolution	Draft: 300 × 300 dpi Quality: 600 × 600 dpi
Enlargement/Reduction	25% to 400%
Contrast settings	Dark/Normal/Light

Halftone (grayscale)	256 levels
Copy modes	Color: 4-Color Photo/Graphics/Text Mono: Halftone/Text
Multiple copies	Max. 50 copies per original (black copies only)
Maximum copy size	Platen: Letter (8.5 × 11 in.) Auto document feeder: Legal (8.5 × 14 in.)

Fax specifications

Automatic dialing	Rapid Key Dialing: 10 numbers Speed Dialing: 89 numbers
Modem speed	14,400 bps with automatic fallback to lower speeds.
Transmission time*	Approx. 6 seconds
Memory size*	512 KB (approx. 30 average pages with ECM turned off)
Resolution	Horizontal: 203 pels/inch (8 pels/mm) Vertical: Standard: 98 lines/inch (3.85 lines/mm) Fine /Halftone: 196 lines/inch (7.7 lines/mm) Super fine: 391 lines/inch (15.4 lines/mm)
Halftone (grayscale)	256 levels
Reception modes	AUTO/MANUAL/A.M. (Note: A.M. mode is for connecting an answering machine)

*Based on ITU-T Test Chart #1 at standard resolution, excluding time for protocol signals (i.e., ITU-T phase C time only).

Scan specifications

Resolution	Optical: 600 × 600 dpi Enhanced: 200 × 200 dpi to 9600 × 9600 dpi
Scanmodes	Color: 24 bit Mono: 8-bit grayscale (256 levels)/1-bit/Text
Compatibility	TWAIN Standard
Scan to e-mail	Yes

General specifications

Auto document feeder	10 pages max. (15 to 21 lbs)
Effective scan width	8.2" (208 mm) max.
Effective print width	8.0" (203 mm) max.
Display	2-line LCD display, 16 digits per line
Paper tray capacity (letter-size plain paper)	15 - 21 lbs.: 100 sheets 22 - 24 lbs.: 80 sheets (At room temperature and normal humidity)
Power requirements	120 V AC, 60 Hz
Operating temperature	50 - 95°F (10 - 35°C)
Humidity	Maximum: 80% RH
Power consumption	Idle: 8 W Maximum: 36 W
Dimensions	Width: 18.7" (474 mm) Depth: 14.3" (364 mm) Height: 13.0" (329 mm)
Weight	Approx. 15.4 lbs. (7.0 kg)

As a part of our policy of continuous improvement, SHARP reserves the right to make design and specification changes for product improvement without prior notice. The performance specification figures indicated are nominal values of production units. There may be some deviations from these values in individual units.

Important safety information

- Do not disassemble this machine or attempt any procedures not described in this manual. Refer all servicing to qualified service personnel.
- Do not install or use the machine near water, or when you are wet. For example, do not use the machine near a bath tub, wash bowl, kitchen sink or laundry tub, in a wet basement, or near a swimming pool. Take care not to spill any liquids on the machine.
- Unplug the machine from the power outlet and consult a qualified service representative if any of the following situations occur:
 - Liquid has been spilled into the machine or the machine has been exposed to rain or water.
 - The machine produces odors, smoke, or unusual noises.
 - The power cord is frayed or damaged.
 - The machine has been dropped or the housing damaged.
- Do not allow anything to rest on the power cord, and do not install the machine where people may walk on the power cord.
- This machine must only be connected to a 120 V, 60 Hz, grounded (3-prong) outlet. Connecting it to any other kind of outlet will damage the machine and invalidate the warranty.
- Never insert objects of any kind into slots or openings on the machine. This could create a risk of fire or electric shock. If an object falls into the machine that you cannot remove, unplug the machine and consult a qualified service representative.
- Do not place this machine on an unstable cart, stand or table. The machine could be seriously damaged if it falls.
- Never install telephone wiring during a lightning storm.

- Never install telephone jacks in wet locations unless the jack is specifically designed for wet locations.
- Never touch bare telephone wires or terminals unless the telephone line has been disconnected at the network interface.
- Use caution when installing or modifying telephone lines.
- Avoid using a telephone (other than a cordless type) during an electrical storm. There may be a remote risk of electric shock from lightning.
- Do not use a telephone to report a gas leak in the vicinity of the leak.
- The power outlet must be installed near the equipment and must be easily accessible.

Important:

- This facsimile machine is not designed for use on a line which has call waiting, call forwarding, or certain other special services offered by your telephone company. If you attempt to use the fax machine in conjunction with any of these services, you may experience errors during transmission and reception of facsimile messages.
- This facsimile machine is not compatible with digital telephone systems.

Table of Contents

A Look at the Operation Panel	8
<hr/>	
1. Installation	11
<hr/>	
Unpacking Checklist	11
Setup	12
Loading Printing Paper	20
Installing the Print Cartridges	23
Installing the Sharp Desktop Software	30
Entering Your Name and Fax Number	32
Setting the Date and Time	36
Setting the Reception Mode	39
Volume Adjustment	40
2. Copying	43
<hr/>	
Making a copy	43
Copy Settings	45
Copying on Special Types of Paper	48
Using the Auto Document Feeder	49
3. Sending Faxes	53
<hr/>	
Sending a Fax by Normal Dialing	53
Programming Auto-Dial Numbers	57
Sending a Fax by Automatic Dialing	62
Sending a Fax From the Document Glass	71
Optional Settings for Sending Faxes	73
Broadcasting	77
4. Receiving Faxes	79
<hr/>	
Using AUTO Mode	79
Using MANUAL Mode	81
Optional Reception Settings	82
Substitute Reception to Memory	84
Distinctive Ring (Requires Subscription to Service)	85
5. Printing	88
<hr/>	

Printing a document from an application.	88
Printing on Specialty Papers.	89
Printing on Envelopes or Cards	90
Sharp AJ-5030 Control Panel	91
6. Scanning	92
<hr/>	
Scanning a document	92
Scanning a Document to Your E-mail Program	94
7. Answering Machine Hookup	96
<hr/>	
Connecting an Answering Machine	96
Optional A.M. Mode Settings	99
8. Printing Lists	101
<hr/>	
9. Maintenance and Troubleshooting	106
<hr/>	
Cleaning the Scanning Glasses	106
Improving Print Quality	108
Faxing Problems	112
Messages and Signals	117
Clearing Paper Jams	120
Ordering Parts.	123
FCC Regulatory Information	124
Quick Reference Guide	131
<hr/>	
Guía de referencia rápida	133
<hr/>	
Index	135
<hr/>	

A Look at the Operation Panel

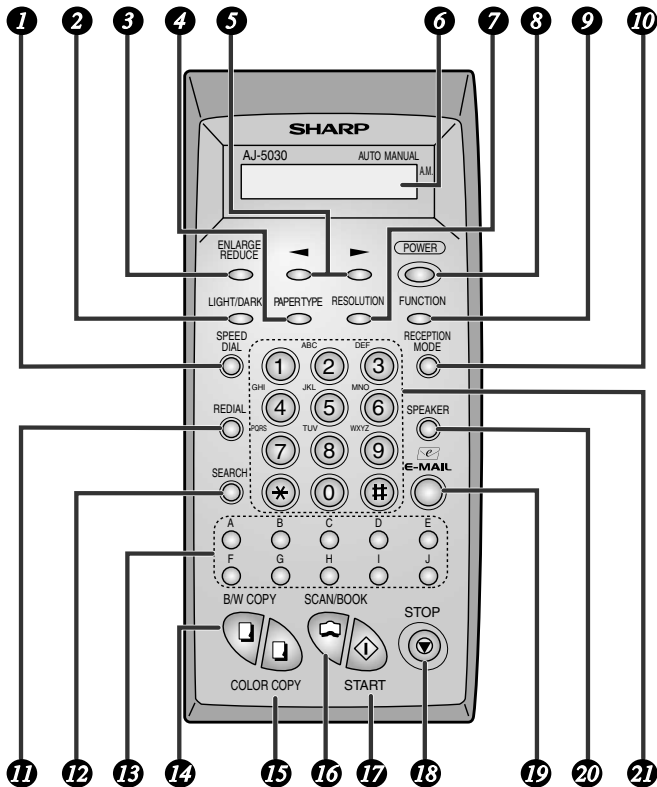

1 SPEED DIAL key

Press this key to dial a fax number using an abbreviated 2-digit Speed Dial number.

2 LIGHT/DARK key

Press this key to select a contrast setting when making a copy or faxing. Three settings are available: DARK, NORMAL, and LIGHT. (The default setting is NORMAL.)

3 ENLARGE/REDUCE key

Press this key to select an enlargement or reduction setting when making a copy.

- 4 PAPER TYPE key**
Press this key to specify what type of paper you are using when making a copy. Select PLAIN, COATED, GLOSSY, or TRANSPARENCY. (The default setting is PLAIN.)
- 5 Arrow keys**
FUNCTION key settings: Press the arrow keys after pressing the **FUNCTION** key to scroll through the **FUNCTION** key settings.
ENLARGE/REDUCE: Press the arrow keys after making a selection with the **ENLARGE/REDUCE** key to increase or decrease the selected setting by 1% (hold down the arrow key for at least one second to change the setting in increments of 5%).
Speaker and ringer volume: Press the left or right arrow keys to adjust the speaker volume after pressing the **SPEAKER** key, or the ringer volume at any other time.
- 6 Display**
This displays messages and prompts to help you operate the Color Inkjet.
- 7 RESOLUTION key**
Press this key to select the resolution for copying or faxing.
- 8 POWER key**
Press this key to turn the display power on or off. (Note: The unit power is turned on or off by plugging in or unplugging the machine.)
- 9 FUNCTION key**
Press this key to select various special functions.
- 10 RECEPTION MODE key**
Press this key to select the mode for receiving faxes (and voice calls if a phone is connected to the same line as the Color Inkjet). The selections are AUTO, MANUAL, and A.M.
- 11 REDIAL key**
Press this key to automatically redial the last number dialed.

- 12 SEARCH key**
Press this key to search through your auto-dial fax numbers or e-mail addresses when sending a fax.
- 13 Rapid Dial Keys**
Press one of these keys to dial a fax number automatically.
- 14 B/W COPY key**
Press this key to make a black and white copy of a document.
- 15 COLOR COPY key**
Press this key to make a color copy of a document.
- 16 SCAN/BOOK key**
Press this key to fax a document from the document glass instead of the auto document feeder.
- 17 START key**
Press this key after dialing to fax a document that you have placed in the auto document feeder.
- 18 STOP key**
Press this key to cancel an operation before it is completed.
- 19 E-MAIL key**
Press this key to scan a document to your e-mail program in your computer. This allows you to send the document as a file attachment to an e-mail message.
- 20 SPEAKER key**
Press this key to listen to the line and fax tones through the speaker when faxing a document.
Note: **This is not a speakerphone.** You cannot use the speaker to talk with the other party.
- 21 Number keys**
Use these keys to dial numbers, and enter numbers and letters when storing auto-dial numbers.

1. Installation

Unpacking Checklist

Before setting up, make sure you have all of the following items.



If any are missing, contact your dealer or retailer.

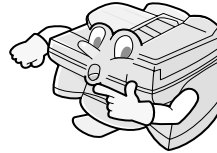

Paper tray



Output tray

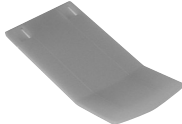

Document tray



Print cartridges (2)



USB cable



Telephone line cable



CD-ROM



Operation manual



Setup Guide



Setup

Points to keep in mind when setting up

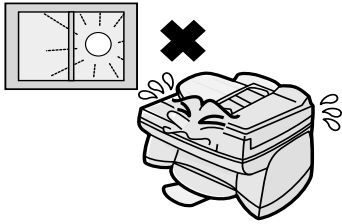

Do not place the machine in direct sunlight.

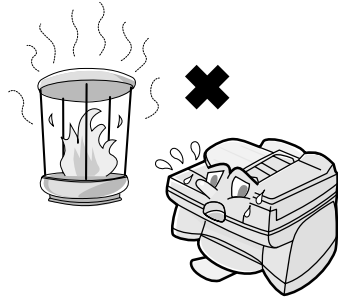

Do not place the machine near heaters or air conditioners.

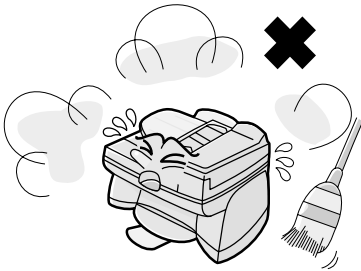

Keep dust away from the machine.

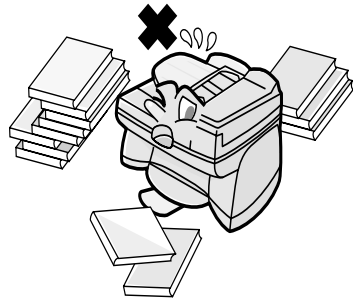

Keep the area around the machine clear.

About condensation

If the machine is moved from a cold to a warm place, it is possible that condensation may form on the scanning glass, preventing proper scanning of documents for transmission. To remove the condensation, turn on the power and wait approximately two hours before using the machine.

Removing the packing tape and stopper

- 1** Open the printer cover ①.

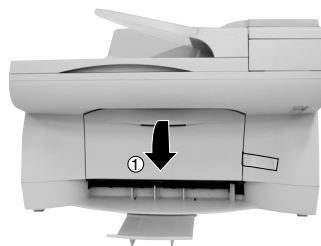

- 2** Remove the tape ②.

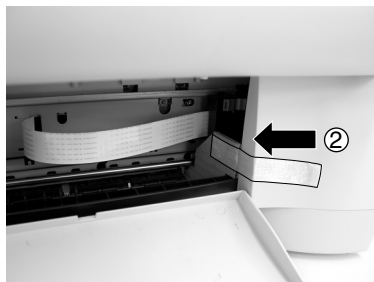

- 3** Push down on the stopper ③ and then pull it back and out of the machine ④.

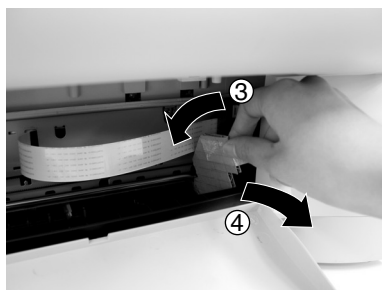

- 4** Close the printer cover.
-

Connecting a printer cable

You can connect the Color Inkjet to your computer using either the provided USB cable, or a parallel cable (not provided).

- ◆ Make sure the power of the Color Inkjet is turned OFF before connecting a cable.
- ◆ Connect only **ONE** printer cable. Do not connect both the USB cable and a parallel cable.

If your computer is running Windows 98 or 2000 and has a USB port, use the provided USB cable.



Otherwise, you will need to purchase an IEEE 1284 compliant parallel cable.

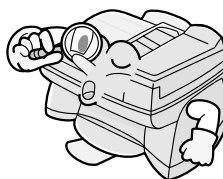

Connecting the USB cable



Connecting a parallel cable

Note: Use only an IEEE 1284 compliant parallel cable that is no longer than 6 feet.

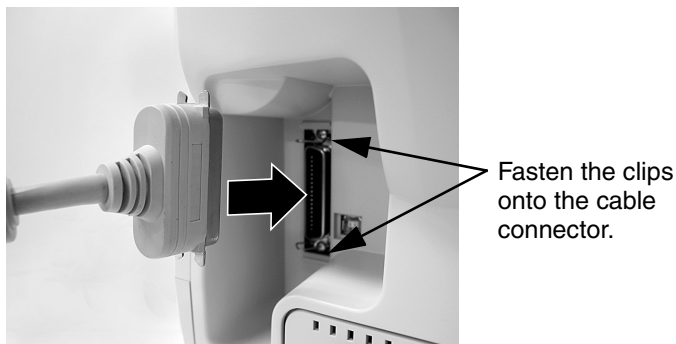

Releasing the scanner

Before turning on the power, push the release down to release the scanner lock.

- ◆ If you ever need to move the Color Inkjet, pull the release back up to lock the scanner before moving (pull the release up after you have turned off the power).



Connecting the power cord

Plug the power cord into a 120 V, 60 Hz, grounded AC (3-prong) outlet.

Caution!

- ◆ Do not plug the power cord into any other kind of outlet. This will damage the machine and is not covered under the warranty.
- ◆ Make sure you have removed the packing tape and stopper and released the scanner before plugging in the power cord. Plugging in the power cord without doing so may damage the machine.

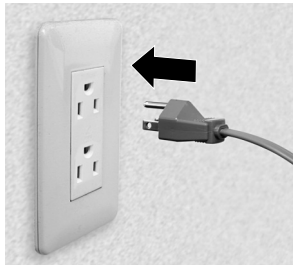

Press the **POWER** switch to turn on the display.
(The main machine power is turned on or off by plugging in or unplugging the power cord.)

Connecting the telephone line cord

Insert one end of the line cord into the jack on the back of the machine marked **TEL. LINE**. Insert the other end into a standard (RJ11C) single-line wall telephone jack.



Be sure to insert the line into the **TEL. LINE** jack. **Do not** insert it into the **TEL. SET** jack.

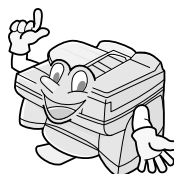

Dial mode: The fax machine is set for tone dialing. If you are on a pulse dial line, you must set the fax machine for pulse dialing. Press the keys on the operation panel as follows:

1 Press these keys:

FUNCTION

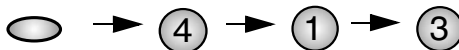

The display will show:

DIAL MODE
1=TONE, 2=PULSE

2 Press **1** to select tone dialing, or **2** to select pulse dialing.

TONE PULSE

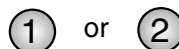

3 Press the **STOP** key to return to the date and time display.

STOP



Note: If your area experiences a high incidence of lightning or power surges, we recommend that you install surge protectors for the power and telephone lines. Surge protectors can be purchased at most telephone specialty stores.

Attach trays

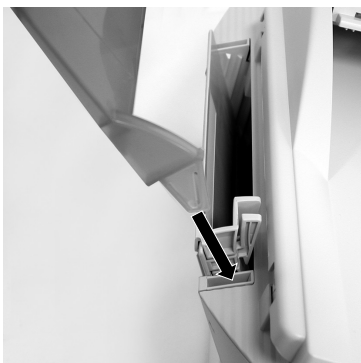

Extension phone (optional)

If desired, you can connect an extension phone to the **TEL. SET** jack on the Color Inkjet.

To connect an answering machine to the Color Inkjet, see page 96.

-
- 1** Remove the seal covering the **TEL. SET** jack.

-
- 2** Connect the extension phone line to the **TEL. SET** jack.

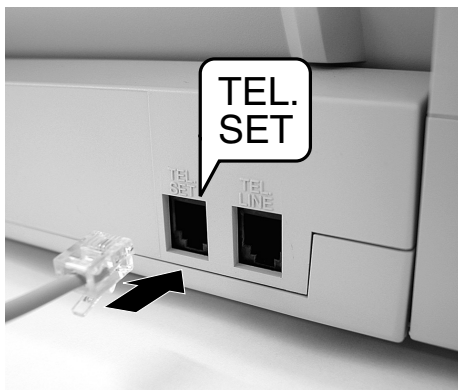

Loading Printing Paper

The maximum number of sheets of paper you can load in the paper tray depends on the weight and type of paper you are loading:

- ◆ Plain letter-size paper, 15 to 21 lbs.: 100 sheets
- ◆ Plain letter-size paper, 22 to 24 lbs.: 80 sheets
- ◆ Plain paper, legal size: 1 sheet
- ◆ Coated and glossy paper/transparencies/envelopes: 10 sheets

Note: The above maximums are for normal temperature and humidity conditions.

1 Insert a stack of paper into the paper tray, *print side up*.

- Align the stack of paper against the right paper guide.

Align the top edge of the stack with the appropriate line (LTR or A4). (Take care not to insert the stack too far into the tray.)

The stack should not be higher than this line. If it is, remove part of the stack.

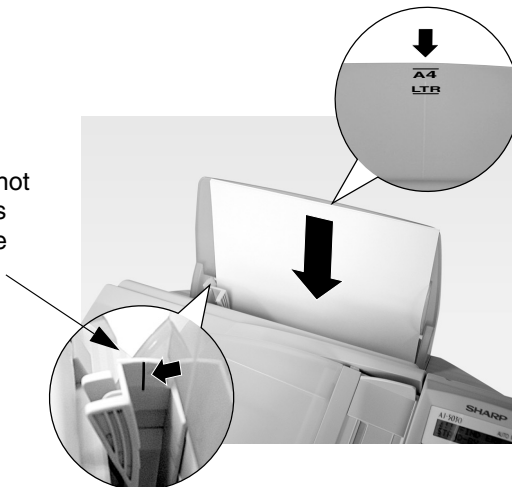

2 Pinch the levers of the paper guide ① together, and slide the guide against the left side of the stack.

- Be sure to slide the paper guide to the correct position. If an envelope or other small-sized paper is loaded without setting the guide correctly and you receive a fax, the fax may be printed on the envelope instead of being received to memory.

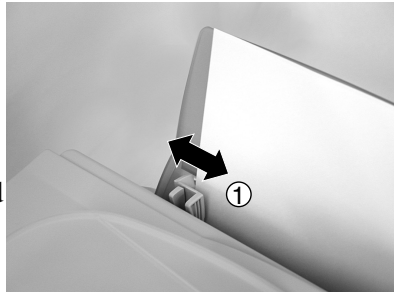

Setting the paper size for faxing and copying

Your Color Inkjet has been preset to print on letter-size paper. If you have loaded legal-size or A4 paper, you must change the paper size setting. Follow the steps below.

Note: The following setting is only for faxing and copying. To select the paper size for printing, use the Sharp AJ-5030 Properties on your computer (to open the Properties, select **Properties**, **Setup**, or **Printer** from the **Print** dialog box of your application).

1 Press the **FUNCTION** key, **5** and then **1**.

The display will show:

PAPER SIZE
1=LETTER, 2=LEGAL



- 2** Press **1** for LETTER, **2** for LEGAL, or **3** for A4 size.

The display will briefly show your selection, and then:

2: COPY CUT-OFF
PRESS START KEY

LETTER: 

LEGAL: 

A4: 

-
- 3** Press the **STOP** key to return to the date and time display.

STOP



Note: If you loaded other than plain paper, you will need to change the paper type setting. For copying, see page 48. For printing, select the paper type in the Sharp AJ-5030 Properties on your computer.

Installing the Print Cartridges

Your Color Inkjet uses a Sharp AJ-C50C color cartridge and an AJ-C50B black cartridge.

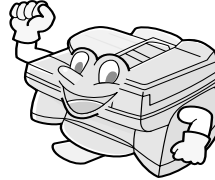

Caution!

Never open the print compartment cover of the Color Inkjet while it is printing.

Note: Make sure the power of the Color Inkjet is turned on and paper is loaded before installing or changing print cartridges.

- 1 Open the printer cover ①.

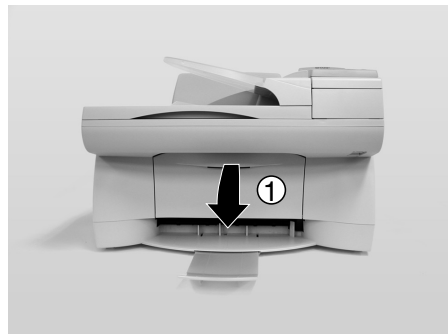

Note:

If you are changing or replacing a cartridge, remove the old cartridge. If you are going to use the old cartridge again, place it in an air-tight container.

- 2** If you are installing a new cartridge or cartridges, remove **only** the sticker and the transparent tape from the bottom of the new cartridge.



- **WARNING!**
DO NOT touch the gold contact area of the cartridge.



- 3** Insert the color and black print cartridges into the print cartridge carrier as shown.

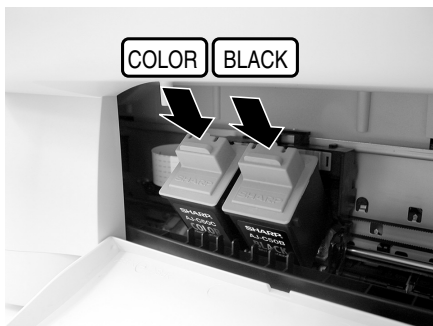

- 4** Push back firmly on the cartridges until they snap securely into place.

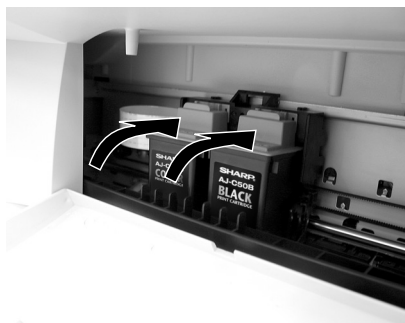

5 Close the print compartment cover.

6 Press the right arrow until the display shows the cartridge(s) that you just installed.

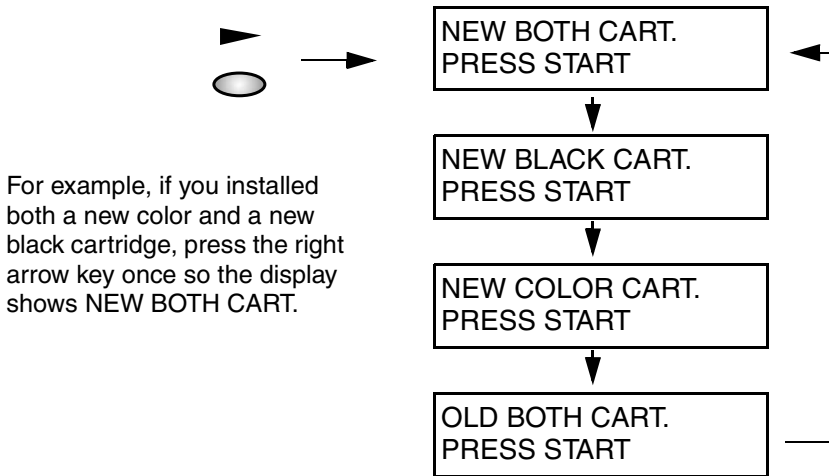

7 Press the **START** key.



- 8** If you selected “OLD BOTH CART.”, this completes the installation procedure.

If you selected of the settings for a new cartridge, you will need to align the cartridges. Press the **START** key to print out an alignment page, and then go directly to Step 3 of the following procedure, *Aligning the print cartridges*.

One or both new cartridges:



START

Aligning the print cartridges

If you installed new print cartridges, you will need to align them.



You may also need to align the print cartridges if print quality is not satisfactory.

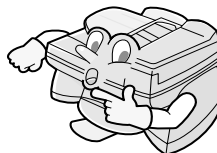

Note: Make sure that paper is loaded before beginning the following procedure.

- 1** Press the **FUNCTION** key, **5**, and then **3**.



The display will show:

ALIGN CART.
PRINT ALIGN PAGE

2 Press the **START** key.

- The Color Inkjet prints an alignment page with four patterns on it.
- After the alignment page is printed, the display will show:



```
A:Horizontal=15
ENTER [00-30]
```

3 In pattern A on the alignment page, locate the line that comes closest to forming a completely straight line.

In this example, 9 comes closest to forming a straight line.

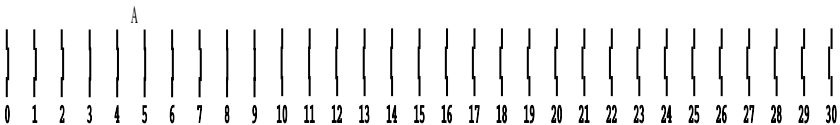
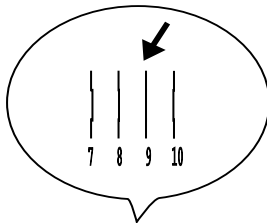

- 4** Press the number keys to enter the number below the straightest line (if the number is less than 10, enter a 0 before the number).

0 9

(Example)

The display will show:

B:Vertical=08
ENTER [00-15]

- 5** Press the number keys to enter the number below the straightest line in Pattern B (if the number is less than 10, enter a 0 before the number).

0 8

(Example)

The display will show:

C:Black Bidi=15
ENTER [00-30]

- 6** Press the number keys to enter the number below the straightest line in Pattern C (if the number is less than 10, enter a 0 before the number).

1 5

(Example)

The display will show:

D:Color Bidi=15
ENTER [00-30]

- 7** Press the number keys to enter the number below the straightest line in Pattern D (if the number is less than 10, enter a 0 before the number).

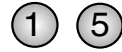

(Example)

The display will show:

4: CLEAN NOZZLES
PRESS START KEY

- 8** Press the **STOP** key to return to the date and time display.

STOP



Printing a test page

Once you have installed and aligned the print cartridges, you can print a test page to make sure that the Color Inkjet is printing correctly. Follow these steps:

- 1** Press the **FUNCTION** key, **5**, and then **5**.

FUNCTION



The display will show:

TEST PRINT
PRESS START KEY

- 2** Press the **START** key.

- The test page prints out.



START

Installing the Sharp Desktop Software

To use your Color Inkjet as a printer and scanner for your computer, you must install the Sharp Desktop software.

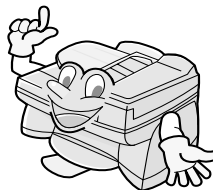

Minimum system requirements

Processor:	Windows [®] 95/98: Pentium 90 MHz or higher Windows NT 4.0: Pentium 133 MHz or higher Windows 2000: Pentium 166 MHz or higher
Operating system:	Windows 95 (OSR2 or later)/98/2000/NT 4.0 (SP3 or later), English version
Physical RAM:	Windows 95/98: 16 MB Windows NT 4.0: 24 MB Windows 2000: 64 MB
Free hard-disk space:	Windows 95/98/2000: 20 MB Windows NT 4.0: 20 MB

- ◆ The Sharp Desktop software cannot be installed by Plug and Play. If the **New Hardware Found** or **Add New Hardware Wizard** window appears when you turn on your computer, click the **Cancel** button to exit the dialog box.
- ◆ If you have other printer or multifunction device software installed in your computer, uninstall that software before installing the Sharp Desktop software. Otherwise, the Sharp Desktop software may not function correctly.

1. Insert the Sharp CD into your computer's CD-ROM drive.
2. The **Selector** window should appear. If the window doesn't appear, follow these steps:
 - a. Click the **Start** button on the Windows taskbar and select **Run...**
 - b. Type **x:\setup** in the **Open** text box, where **x** is the letter of your CD-ROM drive, and then click **OK**.
3. When the **Selector** windows appears, follow the instructions that appear on the screen.
4. When installation is completed, restart your computer.

Online Operation Guide

Detailed instructions for using the Sharp Desktop software can be found in the Online Guide on the CD. To open the guide, follow these steps:

1. Insert the Sharp CD into your CD-ROM drive. (If the **Selector** window appears, click **Cancel** and then **Exit Setup** to close the window.)
2. Click the **Start** button on the Windows taskbar, point to **Programs**, and then point to **Sharp AJ-5030**. Click **Online Guide**.

Entering Your Name and Fax Number

Before you can begin sending faxes, you must enter your name and fax (telephone) number. You also need to set the date and time.



Once you enter this information, it will automatically appear at the top of each fax page you send.



Important!

FCC regulations require that your name, telephone/fax number, and the date and time appear on each fax message you send. Enter your name and fax number here and set the date and time as explained in the following section to have the fax machine include this information automatically at the top of your fax messages.

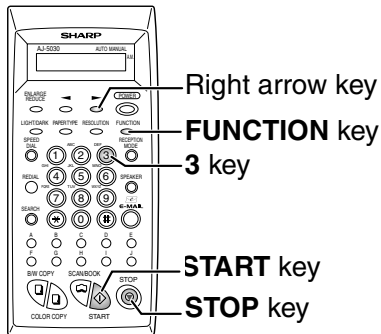

- 1 Press the **FUNCTION** key and then
3.
The display will show:

3: ENTRY MODE
ENTER # (1-4,<,>)

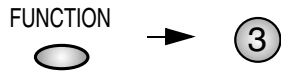

2 Press the **2** key.



The display will show:

OWN NUMBER SET
PRESS START KEY

Note: Instead of pressing the **2** key, you can press the right arrow key twice and then the **START** key.

3 Press the **START** key.

The display will show:

ENTER FAX #



4 Enter your fax/phone number by pressing the number keys.

- To insert a space between digits, press the # key.
- If you make a mistake, press the **SPEED DIAL** key to backspace and clear the mistake.

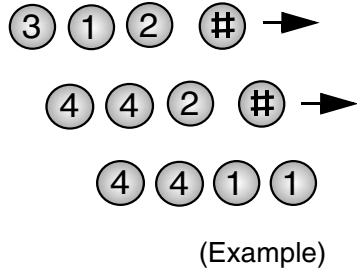

5 Press the **START** key to enter the fax number in memory.

The display will show:

ENTER YOUR NAME



6 Enter your name by pressing number keys for each letter as shown in the chart below. Up to 24 characters can be entered.

Example: SHARP = 77777 444 22 7777   77

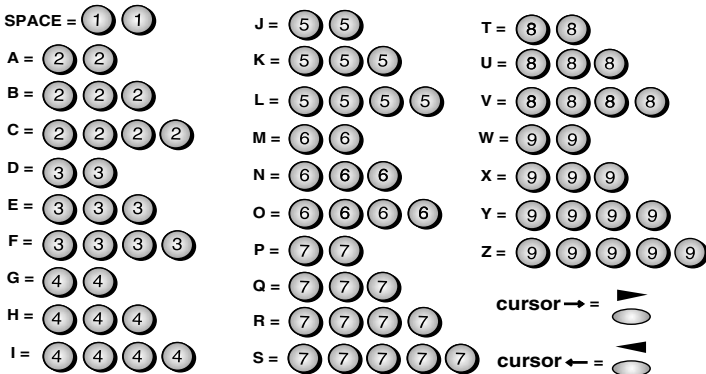

- ◆ To enter two letters in succession that require the same key, press the right arrow key after entering the first letter.
(The arrow keys move the cursor forward and backward.)
- ◆ To clear a mistake, press the **SPEED DIAL** key.
- ◆ To change case, press the **REDIAL** key.
- ◆ To enter one of the following symbols, press the # key or the * key repeatedly:
./! " # \$ % & ' () * + , - . : ; < = > ? @ [] ^ _ ' { | }

Cursor: A dark square mark in the display that indicates where a number or letter will be entered.

7 Press the **START** key.

The display will show:

3: DATE & TIME
PRESS START KEY



START

8 Press the **STOP** key to return to the date and time display.

STOP



Setting the Date and Time

The date and time appear in the display and are printed at the top of every page you fax.

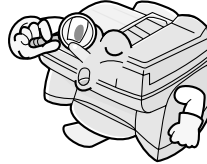

Set the date and time by pressing the keys on the operation panel as shown below.

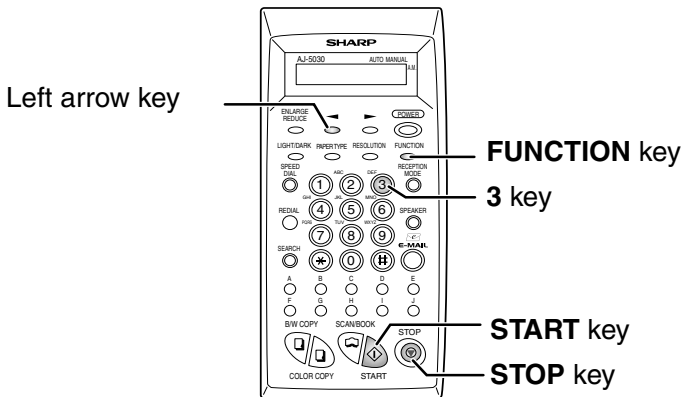

- 1 Press the **FUNCTION** key and then **3**:

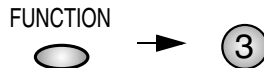

The display will show:

3: ENTRY MODE
ENTER # (1-4,<,>)

2 Press the **3** key.

③

The display will show:

DATE & TIME SET
DATE 01-01-2001

↑
The currently set date
and time appear here.

Note: Instead of pressing the **3** key, you can press the left arrow key twice and then the **START** key.

3 Enter a two-digit number for the month (“01” for January, “02” for February, “12” for December, etc.).

① ②

Example: January

- To correct a mistake, press the **SPEED DIAL** key to move the cursor back to the mistake and then enter the correct number.

4 Enter a two-digit number for the day (“01” to “31”).

③ ⑤

Example: the 5th

5 Enter the year (four digits).

② ① ① ②

Example: 2001

6 Enter a two-digit number for the hour (“01” to “12”) and a two-digit number for the minute (“00” to “59”).

① ② ③ ⑤

Example: 9:25

-
- 7** Press the ***** key to select A.M. or the **#** key to select P.M.

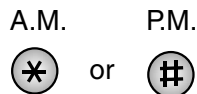

-
- 8** Press the **START** key to start the clock.

The display will show:

4: DAY LIGHT SAVE
PRESS START KEY



-
- 9** Press the **STOP** key to return to the date and time display.



Daylight Saving Time

If desired, you can set the clock to move forward and backward automatically at the beginning and end of Daylight Saving Time. To turn on this function, press the panel keys as follows:

-
- 1** Press these keys:

The display will show:

DAY LIGHT SAVE
1=YES, 2=NO



-
- 2** Press **1** to turn on the Daylight Saving Time function, or **2** to turn it off.

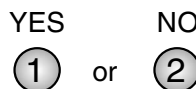

-
- 3** Press the **STOP** key to return to the date and time display.



Setting the Reception Mode

Your Color Inkjet has three modes for receiving incoming faxes:

AUTO mode:

Select this mode when you only want to receive faxes on the line connected to the Color Inkjet. The machine will automatically answer all calls on one ring and receive incoming faxes.

MANUAL mode:

Select this mode when you want to receive both phone calls and faxes on the line connected to the Color Inkjet. **All calls, including faxes, must be answered by picking up an extension phone** connected to the same line.

A.M. mode:

Use this mode only if you have connected an answering machine to the Color Inkjet (see Chapter 7). Select this mode when you go out to receive voice messages in your answering machine and faxes on your Color Inkjet. (“A.M.” is an acronym for “Answering Machine”.)

Setting the reception mode

Press the **RECEPTION MODE** key until the arrow in the display points to the desired mode.

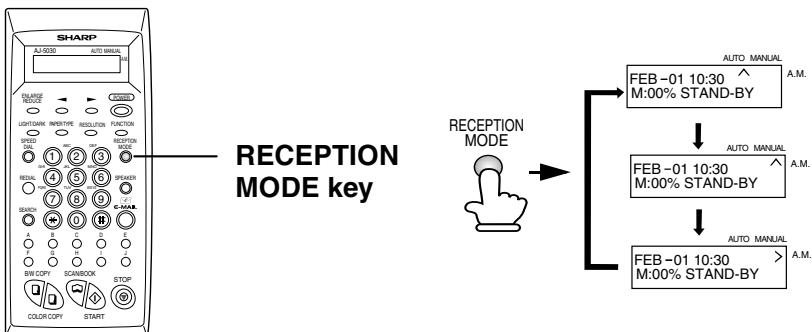

For more information on receiving faxes in AUTO and MANUAL modes, see Chapter 4, *Receiving Faxes* (page 79). For more information on using A.M. mode, see Chapter 7, *Answering Machine Hookup* (page 96).

Volume Adjustment

You can adjust the volume of the speaker and ringer using the left and right arrow keys.

Speaker

- 1** Press the **SPEAKER** key.

SPEAKER



-
- 2** Press the left or right arrow key.

Display:

SPEAKER : HIGH



SPEAKER : MIDDLE



SPEAKER : LOW

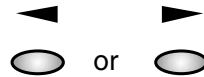

-
- 3** When the display shows the desired volume level, press the **SPEAKER** key to turn off the speaker.

SPEAKER



Ringer

- 1** Press the left or right arrow key.
(Make sure the **SPEAKER** key has not been pressed.)

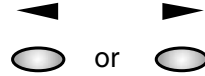

- The ringer will ring once at the selected level, and then the date and time will reappear in the display.

Display:

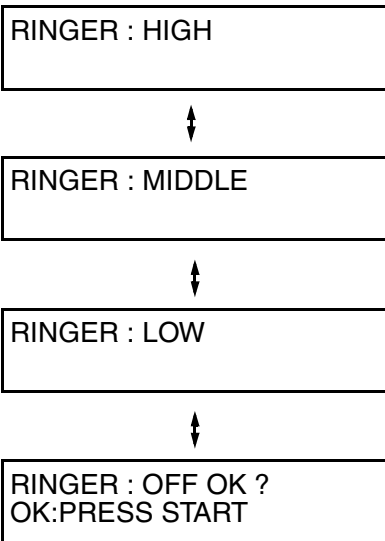

- 2** If you selected RINGER OFF : OK?, press the **START** key.



Beep length

Your fax machine normally signals the end of transmission, reception, or copying with a 3-second beep. If desired, you can change the duration of the beep to 1 second or turn the beep off.

1 Press these keys:

FUNCTION

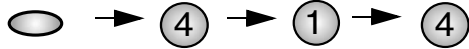

The display will alternately show:

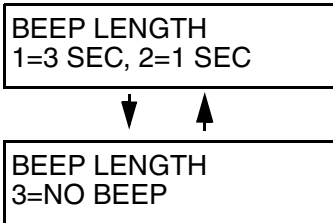

2 Press **1** for 3 seconds, **2** for 1 second, or **3** for no beep.



Example:
No beep

3 Press the **STOP** key to return to the date and time display.

STOP



2. Copying

Making a copy

To make a copy, you can place the original on the document glass, or insert it into the auto document feeder.



The auto document feeder allows you to load up to 10 originals at once.



Caution!

Do not copy onto envelopes, cards, or other paper smaller than A4 or letter size. Copying onto small-sized paper can damage your Color Inkjet.

- 1 Load the original using either the document glass or the auto document feeder:

Using the document glass:

Open the cover of the Color Inkjet, and place the original face down on the glass with the top edge against the document guide.

- ◆ Make sure the center of the original is aligned with the center mark on the document guide, and then close the cover.

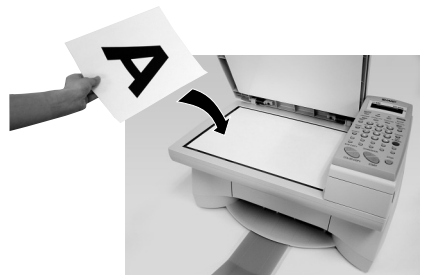

Note: When making a copy of a large original such as a map or newspaper, you can remove the document cover. Otherwise, keep the document cover attached for normal use.

Using the auto document feeder:

Adjust the document guide to the width of your original(s), and then insert the originals (up to 10 pages) face up into the feeder.

- ◆ For detailed information on using the auto document feeder and the types of documents that can be loaded, see pages 50 to 53.

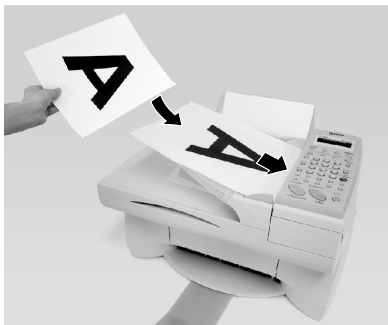

Note: If documents are loaded in both the auto document feeder and on the document glass, the document in the auto document feeder will be used.

2 The default copy settings are as follows. To change a setting, see following section, *Changing Copy Settings*.

- Resolution: Draft
- Enlarge/reduce: 100%
- Number of copies: 1
- Contrast: Normal

3 When you are ready to make the copy, press the **B/W COPY** key for a black and white copy, or the **COLOR COPY** key for a color copy.

B/W COPY



or



COLOR COPY

Copy Settings

You can adjust one or more of the following copy settings anytime before pressing the **B/W COPY** key or **COLOR COPY** key to begin copying.

Resolution

Press the **RESOLUTION** key to select DRAFT, NORMAL, BEST, or H.T. (halftone for photos and illustrations).

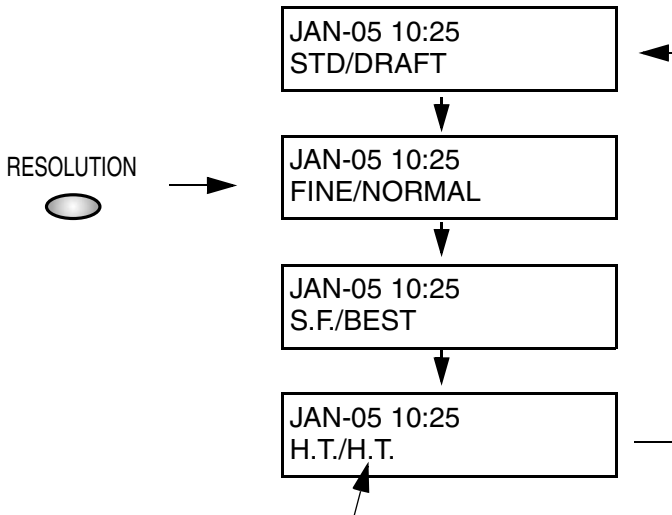

The resolution for copying appears to the right of the slash. (The resolution for faxing appears to the left.)

- ◆ If you have selected PLAIN for the paper type (see page 48), BEST will produce the same result as NORMAL.
- ◆ If you are making a color copy, H.T. (halftone) will produce the same result as NORMAL and BEST.

Enlarge/reduce

There are three ways to select an enlarge/reduce setting:

1. Press the **ENLARGE/REDUCE** key one or more times until the desired percentage appears in the display. The selections are 100%, 129%, 200%, 400%, 25%, 50%, and 78%. When finished, press the **START** key.



2. Press the **ENLARGE/REDUCE** key and then directly enter the desired percentage with the number keys (enter a number from 25 to 400). When finished, press the **START** key.

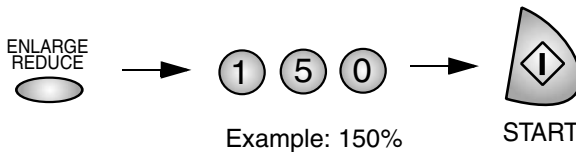

3. Press the **ENLARGE/REDUCE** key and then press the right or left arrow key increase or decrease the percentage in increments of 1%. If you hold down either key for more than one second, the percentage increases or decreases in increments of 5%. When finished, press the **START** key.

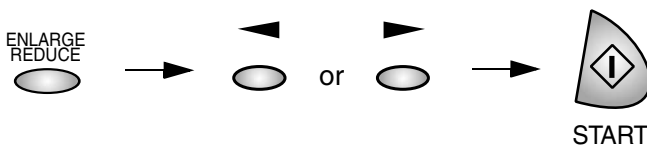

Number of Copies

If you wish to make more than one copy of the original (or of each original if you have loaded multiple originals in the auto document feeder), press the number keys to enter the number of copies.

Note: This setting can only be used for black and white copies.

- ◆ The maximum number is 50.
- ◆ To clear a mistake, press the **STOP** key.

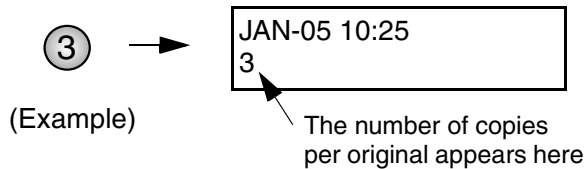

Contrast

Press the **LIGHT/DARK** key one or more times to select DARK for faint originals, NORMAL for normal originals, or LIGHT for originals with a dark background.

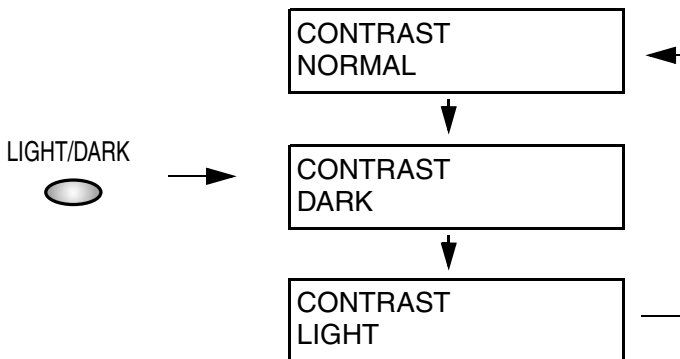

Copying on Special Types of Paper

The Color Inkjet can be used to make copies on coated paper, glossy/ photo paper, and transparency film.



You can load up to 10 sheets of coated paper, glossy paper, or transparency film in the paper tray.

- ◆ Make sure the sheet is loaded **print side up** (for a transparency, make sure the rough side of the transparency is facing up).
- ◆ When copying on transparencies, remove each transparency as it is printed to prevent smearing.

Paper type setting

When using a specialty paper, you must set the paper type before making the copy. Press the **PAPER TYPE** key to select a paper type. (The default setting is PLAIN.)

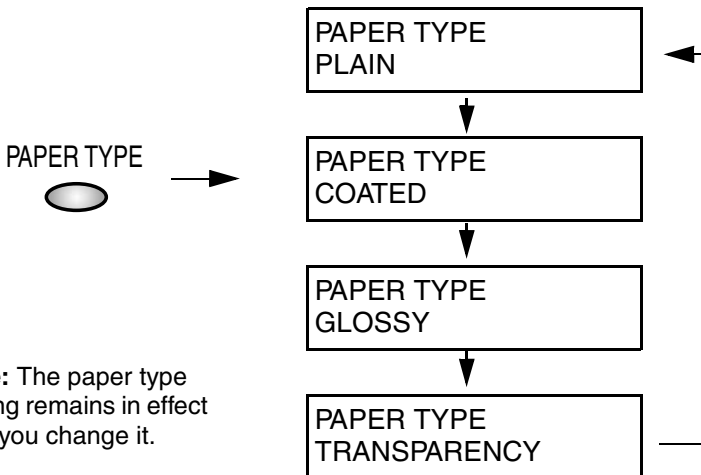

Note: The paper type setting remains in effect until you change it.

Using the Auto Document Feeder

Size and weight

The size and weight of documents that you can load in the document feeder depend on whether you load one page at a time or multiple pages at once.

Loading one page at a time:

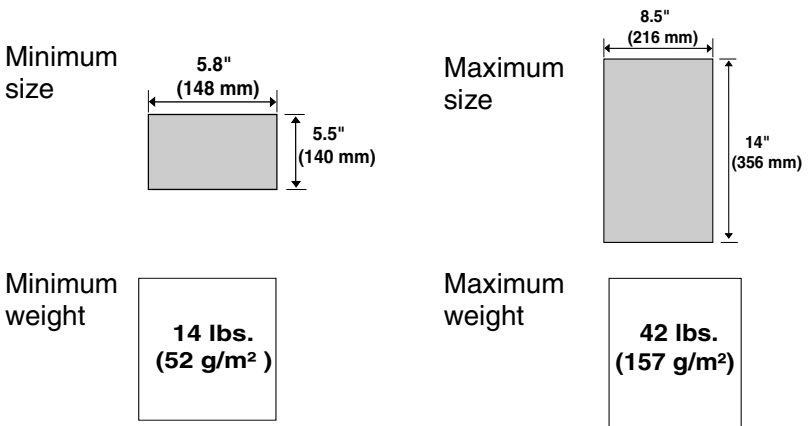

Loading multiple pages (max. 10) at once:

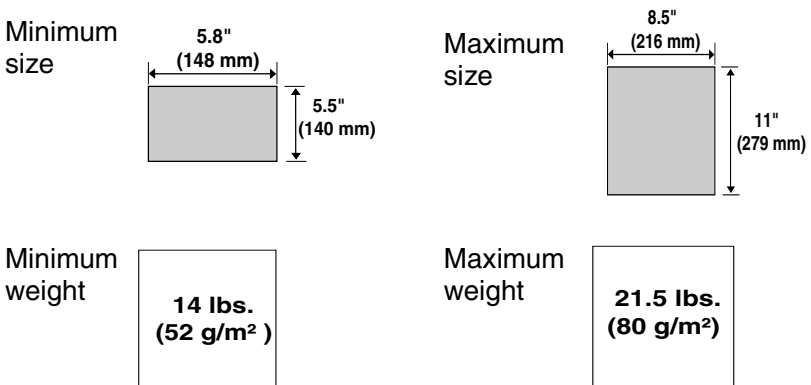

Note: Letters or graphics on the edges of a document will not be scanned.

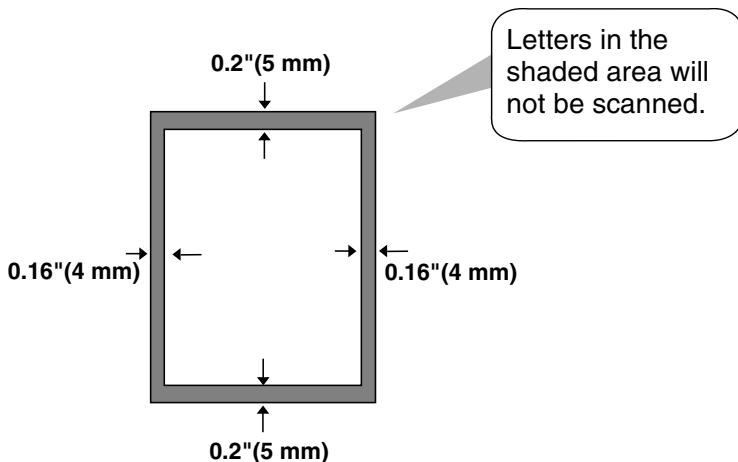

Other restrictions

- ◆ The scanner cannot recognize yellow, greenish yellow, or light blue ink.
- ◆ Ink, glue, and correcting fluid on documents must be dry before they pass through the document feeder.
- ◆ All clips, staples, and pins must be removed from documents before loading in the feeder. If these are not removed, they may damage the machine.
- ◆ Documents which are patched, taped, torn, smaller than the minimum size, carbon backed, easily smudged, or have a slippery coated surface should be faxed from the document glass.

Loading the Document

Up to 10 pages can be placed in the auto document feeder at one time. The pages will automatically feed into the machine starting from the top page.

- ◆ If you need to send or copy more than 10 pages, place the additional pages gently and carefully in the feeder ***under the last page*** while the last page is being scanned. Do not try to force them in, as this may cause double-feeding or jamming.
- ◆ If your document consists of several large or thick pages which must be loaded one at a time, insert each page into the feeder as the previous page is being scanned. Insert gently to prevent double-feeding.

-
- 1** Adjust the document guides to the width of your document.



- 2** Place the document face up and push it gently into the document feeder. The top edge of the document should enter the machine first.

- You can now continue with a copy, fax, or scan operation.

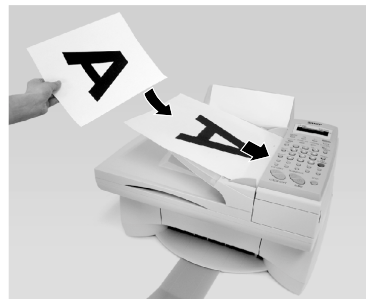

Copy Cut-off

Note: This setting is only for copies made from the auto document feeder. It is not effective when you load the original on the document glass.

When making a copy of a document that is longer than the printing paper, use the copy cut-off setting to select whether the remaining part of the document will be cut off or printed on a second page. The initial setting is YES (cut off the remainder). To change the setting, follow the steps below.

-
- 1** Press these keys:

The display will show:

COPY CUT-OFF
1=YES, 2=NO

FUNCTION



-
- 2** Press **1** to set copy cut-off to YES (the remaining part of the document will not be printed), or **2** to set copy cut-off to NO (the remaining part will be printed on a second page).

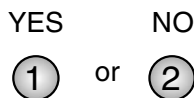

-
- 3** Press the **STOP** key to return to the date and time display.

STOP



3. Sending Faxes

Sending a Fax by Normal Dialing

With Normal Dialing, you press the **SPEAKER** key and then dial by pressing the number keys.

- ◆ Normal Dialing allows you to listen to the line through the speaker to make sure the other fax machine is responding. (Note that the speaker is not a speakerphone; it cannot be used for talking.)
- ◆ If you have connected an extension telephone to the Color Inkjet, you can also pick up the extension phone and dial using the extension phone (do not press the **SPEAKER** key on the machine). If a person answers, you will be able to speak to them through the phone before sending a fax.

Note: If you press the **SPEAKER** key to dial, you will not be able to speak through an extension phone in the event that a person answers.

1 Load the document face up in the auto document feeder (max. 10 pages), or face down on the document glass.

- If you use the document glass, only one page can be sent.

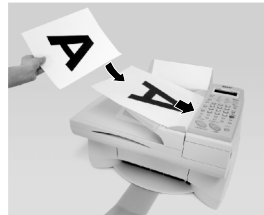

or

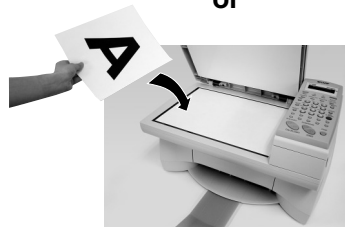

- Set the resolution and/or contrast if desired.

RESOLUTION



LIGHT/DARK



-
- 2** Press the **SPEAKER** key or pick up an extension phone connected to the fax machine. Listen for the dial tone.



or **SPEAKER**

-
- 3** If you pressed the **SPEAKER** key, dial the number of the receiving machine by pressing the number keys on the fax machine.

If you are using an extension phone, dial using the keypad on the extension phone.

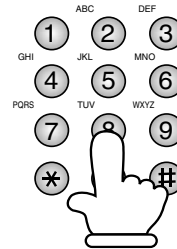

-
- 4** Wait for the connection. When you hear a fax tone, press the **START** key if the document is in the auto document feeder, or the **SCAN/BOOK** key if the document is on the document glass.

- If a person answers and you are using an extension phone, ask them to press their Start key. When you hear the fax tone, press the **START** key if the document is in the auto document feeder, or the **SCAN/BOOK** key if the document is on the document glass.

From auto document feeder:



START

From document glass:



SCAN/BOOK

Using the **REDIAL** key

You can press the **REDIAL** key to redial the last number dialed. To send a document, press the **START** key when you hear the fax tone after the connection is established. Note that the speaker is automatically activated when you press the **REDIAL** key.

Selecting the resolution for faxing

Resolution selections for faxing are as follows:

- | | |
|-------------------|---|
| STANDARD (STD) | Use STANDARD for ordinary documents. This setting gives you the fastest and most economical transmission. |
| FINE | Use FINE for documents containing small letters or fine drawings. |
| SUPER FINE (S.F.) | Use SUPER FINE for documents containing very small letters or very fine drawings. |
| HALF TONE (H.T.) | Use HALF TONE for photographs and illustrations. The original will be reproduced in 64 shades of gray. |

To select a resolution setting, press the **RESOLUTION** key one or more times until the desired setting appears in the display. (Select a resolution setting before dialing.)

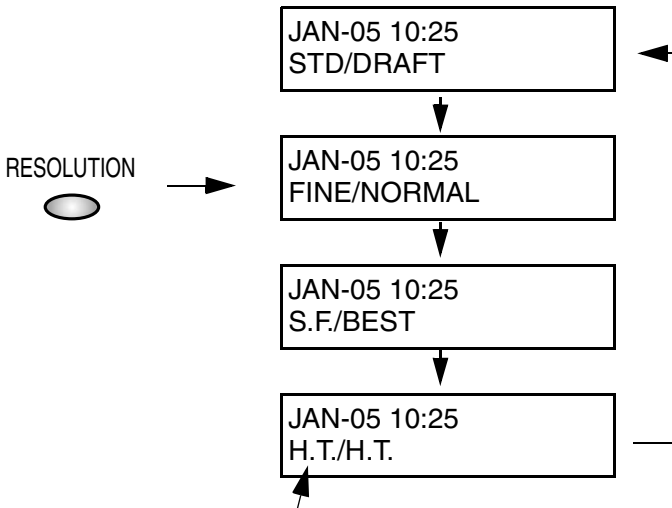

The resolution for faxing appears to the left of the slash. (The resolution for copying appears to the right.)

Changing the default resolution

If desired, you can change the default resolution for faxing documents to FINE. Follow the steps below.

- 1** Press the following sequence of keys:

The display will show:

FUNCTION →  → **4** → **0** → **1**

FINE PRIORITY
1=YES, 2=NO

- 2** Press **1** (YES) to set the default resolution to FINE, or **2** (NO) to set it to STANDARD.

YES NO
1 or **2**

- 3** Press the **STOP** key to return to the date and time display.

STOP

Programming Auto-Dial Numbers

You can dial a fax or telephone number by simply pressing a Rapid Key, or by pressing the **SPEED DIAL** key and entering a two-digit number.

To use a Rapid Key or Speed Dial number, you must first program the full fax number in the Rapid Key or Speed Dial number. It is usually convenient to program your most frequently dialed numbers in Rapid Keys.

- ◆ 10 Rapid Keys and 89 Speed Dial numbers are available.
- ◆ You can also use a Rapid Key or Speed Dial number to send a fax to an e-mail address. To program a Rapid Key or Speed Dial number for e-mail, see *Programming Rapid Key and Speed Dial Numbers* in Chapter 5 of your online operation guide.

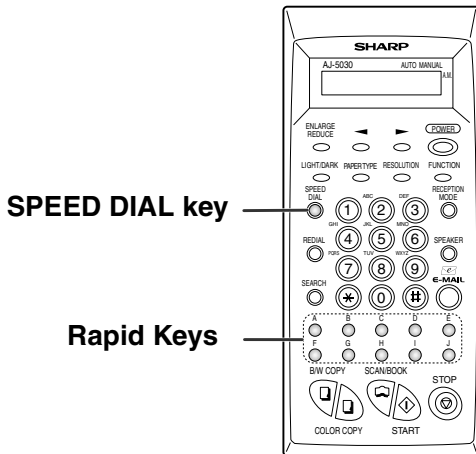

1 Press these keys:

The display will show:

FAX/TEL # MODE
1=SET, 2=CLEAR

FUNCTION



2 Press the **1** key to select SET.

The display will show:

FAX/TEL # SET
SPEED # OR RAPID



3 To store a number in a Rapid Key, press the desired Rapid Key.

To store a Speed Dial number, enter the desired 2-digit number (from **01** to **89**) by pressing the number keys.



Example:
Rapid Key A



Example:
Speed Dial 01

4 Enter the fax or voice number by pressing the number keys. (Note: A space cannot be entered.)

- To clear a mistake, press the **SPEED DIAL** key.
- If a pause is required between any of the digits to access a special service or an outside line, press the **REDIAL** key (two seconds per pause). The pause will appear as a hyphen. Several pauses can be entered in a row.

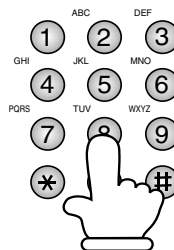



5 Press the **START** key.



START

6 Enter the name of the party by pressing the number keys as shown below. (If you don't want to enter a name, go directly to Step 7.)

SPACE = 1 1	J = 5 5	T = 8 8
A = 2 2	K = 5 5 5	U = 8 8 8
B = 2 2 2	L = 5 5 5 5	V = 8 8 8 8
C = 2 2 2 2	M = 6 6	W = 9 9
D = 3 3	N = 6 6 6	X = 9 9 9
E = 3 3 3	O = 6 6 6 6	Y = 9 9 9 9
F = 3 3 3 3	P = 7 7	Z = 9 9 9 9 9
G = 4 4	Q = 7 7 7	
H = 4 4 4	R = 7 7 7 7	cursor → = 
I = 4 4 4 4	S = 7 7 7 7 7	cursor ← = 

Example: SHARP = 77777 444 22 7777  77



- ◆ To clear a mistake, press the **SPEED DIAL** key.
- ◆ To enter two letters in succession that require the same key, press the right arrow key after entering the first letter.

7 Press the **START** key.



START

- 8** Press **1** if the number programmed is an area code or access code to be used for Chain Dialing (see *Chain Dialing for area and access codes* below). Press **2** (or **START**) if the number is a regular fax number.

ON OFF
 or 

- 9** Return to Step 3 to store another number, or press the **STOP** key to return to the date and time display.

Step 3 or 

Chain Dialing for area and access codes

You can also program an area code or access code in a Rapid Key or Speed Dial number using the above programming procedure. In Step 8, press **1** to set the number as a Chain Dialing number.

After you dial an area code or access code using a Rapid Key or Speed Dial number set for Chain Dialing, the fax machine will wait for you to dial the remainder of the number (you can dial the remainder of the number by pressing a Rapid Key, by pressing the Speed Dial key and entering a Speed Dial number, or by pressing numeric keys). Note that the remainder of the number should **not be set** as a Chain Dial number if programmed in a Rapid Key or Speed Dial number.

- ◆ The maximum number of digits that can be dialed at one time by Chain Dialing is 50.

Making changes

To make changes in a number previously stored, repeat the programming procedure. Select the Rapid Key or Speed Dial number for which you want to make changes in Step 3, and then change the number and/or name when they appear in the display in Steps 4 and 6.

Clearing auto-dial numbers

1 Press these keys:

FUNCTION



The display will show:

FAX/TEL # MODE
1=SET,2=CLEAR

2 Press **2** to select CLEAR.



3 Press the Rapid Key or enter the Speed Dial number (press the number keys) that you want to clear.



(Example)

4 Press the **START** key.



START

5 Return to Step 3 to clear another number, or press the **STOP** key to return to the date and time display.

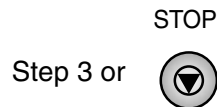

Note: The fax machine uses a lithium battery to keep automatic dialing numbers and other programmed data in memory when the power is turned off. Battery power is consumed primarily when the power is off. With the power kept continuously off, the life of the battery is about 5 years. If the battery dies, have your dealer or retailer replace it. Do not try to replace it yourself.

Sending a Fax by Automatic Dialing

Dual Access

The fax machine features full dual access, which means that you can load a document and dial by automatic dialing even when the fax machine is occupied with another operation. After you dial, your document will be immediately scanned into memory and then transmitted once all previously set operations have been completed.

If more than one document has been scanned into memory for transmission, the documents will be transmitted in the order in which they were scanned.

- ◆ The fax machine can hold approximately 30 pages of average content in memory. Less pages can be held if any pages are scanned using fine or halftone resolution. The maximum number of transmission jobs that can be held at once is 30.
- ◆ The amount of memory currently occupied appears as a percentage (M:00%) in the display.

If the memory becomes full...

If the memory becomes full while a document is being scanned, MEMORY FULL will appear in the display. Press the **START** key or the **STOP** key as follows:

- ◆ Press the **START** key if you want to transmit the pages which have been stored up to that point in memory. The remaining pages will be ejected from the feeder. After transmission, the memory will be cleared and you can transmit the remaining pages. You will also need to transmit the page which was being scanned when the memory filled up.
- ◆ Press the **STOP** key if you want to cancel the entire transmission.

If you do not press the **START** key or the **STOP** key within three minutes, the transmission will be canceled and the pages already scanned cleared from memory. You will need to retransmit all pages of the document.

Rapid Key Dialing

If the number you want to dial has been programmed in a Rapid Key, you can dial it by pressing the Rapid Key.

- 1 Load the document face up in the auto document feeder (max. 10 pages).
 - To send a document from the document glass, see page 71.
 - Set the resolution and/or contrast if desired.

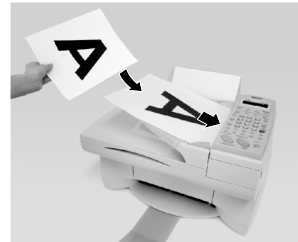

RESOLUTION LIGHT/DARK

- 2 Press the appropriate Rapid Key.
 - The name of the receiving party will appear in the display. If no name was stored, the fax number will appear. (If the name or number is incorrect, press the **STOP** key.)
 - The document is automatically transmitted once the connection is established.



Example:
Rapid Key A

Speed Dialing

If the number you want to dial has been programmed in a Speed Dial number, you can dial it by pressing the **SPEED DIAL** key and then entering the Speed Dial number.

1 Load the document face up in the auto document feeder (max. 10 pages).

- To send a document from the document glass, see page 71.
- Set the resolution and/or contrast if desired.



RESOLUTION



LIGHT/DARK



2 Press the **SPEED DIAL** key and then enter the Speed Dial number by pressing the number keys.

- To enter numbers 1 through 9, first enter 0 and then the number (or enter the single-digit number and then press the **START** key).

SPEED
DIAL



(Example)

3 Check the display. If the name or number shown is correct, press the **START** key. (If not, press the **STOP** key and then repeat Step 2.)



START

Direct Keypad Dialing

You can also enter a full number with the number keys and then press the **START** key to begin dialing. You can use this method to dial a full number when you don't need to speak to the other party before faxing.

- 1 Load the document face up in the auto document feeder (max. 10 pages).
 - To send a document from the document glass, see page 71.
 - Set the resolution and/or contrast if desired.

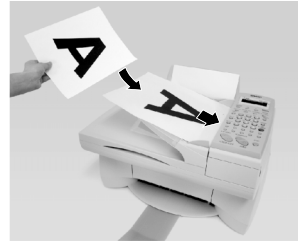

RESOLUTION

LIGHT/DARK



- 2 Enter the number of the receiving machine by pressing the number keys.
 - If a pause is required between any of the digits to access a special service or an outside line, press the **REDIAL** key (two seconds per pause). The pause will appear as a hyphen. Several pauses can be entered in a row.

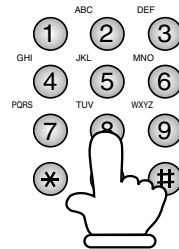

- 3 Check the display. If the number of the receiving machine shown is correct, press the **START** key.
 - If it is not correct, press the **STOP** key to backspace and clear one digit at a time, and then re-enter the correct digit(s).





START

Searching for an auto-dial number

If you don't remember the Rapid Key or Speed Dial number in which you have programmed a particular fax number or e-mail recipient, you can search for the number by following the steps below. Once you have found the number, you can dial and transmit the document by simply pressing the **START** key. (Note: To search for an e-mail recipient, your Color Inkjet must be connected to your computer.)

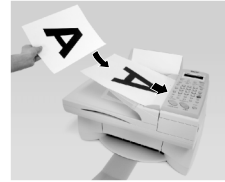
- 1 Load the document face up in the auto document feeder (max. 10 pages).
 - Set the resolution and/or contrast if desired.



RESOLUTION LIGHT/DARK

- 2 Press the **SEARCH** key.

SEARCH

- 3 Press **1** (SEARCH DIAL) to search for a fax number, or **2** to search for an e-mail recipient.

SEARCH DIAL E-MAIL

- 4 If desired, you can enter the first letter of the name programmed in the Speed Dial number (press the number key below the marked letter one or more times until the letter appears in the display) to begin your search from names beginning with that letter. If the name begins with a special character or number, press **1** (only for auto-dial numbers).

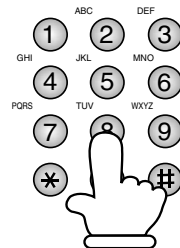

- ◆ If you don't remember the name, go to directly to Step 5.
- ◆ If a name wasn't stored for an auto-dial number, press **0**. This will cause numbers, not names, to appear when you scroll.

5 Press the right arrow key to scroll until the name (or number) appears in the display. (To scroll backwards, press the left arrow key.)



- If no names have been stored that begin with the entered letter, you will scroll from the next name, in alphabetical order, in the list. If no names/numbers have been stored at all, NO DATA will appear.

6 Press the **START** key. The document will be automatically transmitted once the connection is established.



Checking and canceling transmission jobs

To display information on transmission jobs currently waiting in memory to be sent, follow the steps below. You can also cancel a job with this procedure.

1 Press these keys:

FUNCTION



- The display will show **ACTION STATUS** and the number of transmission jobs, and then information on the first job.

2 Press the left or right arrow key to scroll through the list of jobs.

- The display will show the 2-digit memory number assigned to the transmission, the time the transmission was set, and status of the job alternating with the name (or number) of the receiving party.
- To cancel a job, press the **START** key twice while the job appears in the display.

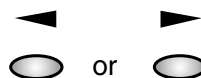

3 When you have finished viewing the list, press the **STOP** key to return to the date and time display.

STOP



Printing out the Status List

You can also print out a list of the transmission jobs currently waiting in memory to be sent. To print out the list, press the following sequence of keys:

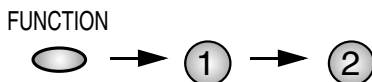

Document transmission (non-memory transmission)

If you wish to use automatic dialing but do not want the document to be transmitted from memory, follow the steps below:

1 Load the document face up in the auto document feeder (max. 10 pages), or face down on the document glass.

- If you use the document glass, only one page can be sent.

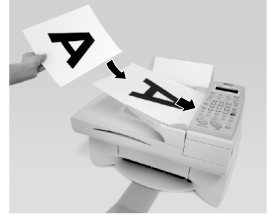

or

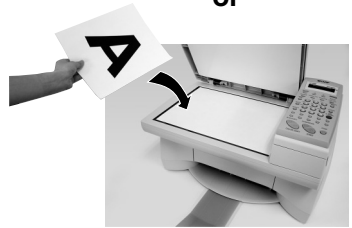

- Set the resolution and/or contrast if desired.

RESOLUTION



LIGHT/DARK



2 Press the **FUNCTION** key and then 7.

The display will show:

FUNCTION



SEP-16 05:30
DOCUMENT TX RDY

3 Dial the receiving machine using one of the following methods:

- Press the **SPEED DIAL** key and enter a 2-digit Speed Dial number.
- Press a Rapid Key.
- Enter a full fax number and then press the **START** key.

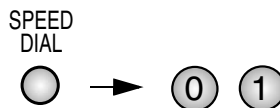

(Example)

4 If the document is loaded in the auto document feeder, press the **START** key.

If document is on the document glass, press the **SCAN/BOOK** key.

From auto document feeder:



START

From document glass:



SCAN/BOOK

Sending a Fax From the Document Glass

You can also send faxes from the document glass. Multiple pages can be sent in a single fax transmission.

Note: When using Rapid Key Dialing, make sure no documents are loaded in the auto document feeder. If documents are loaded in both the auto document feeder and on the document glass, the document in the auto document feeder will be faxed.

1 Open the cover of the Color Inkjet, and place the original face down on the glass with the top edge against the document guide.

- Make sure the center of the original is aligned with the center mark on the document guide, and then close the cover.
- Set the resolution and/or contrast if desired.



RESOLUTION LIGHT/DARK



2 Dial using one of the following methods:

- Press a Rapid Key.
- Press the **SPEED DIAL** key and enter a 2-digit Speed Dial number.
- Press the number keys to enter a full fax number.



(Example)

3 Press the **SCAN/BOOK** key.

- The document on the document glass is scanned. When the Color Inkjet finishes scanning the page, the display will show the following alternating messages.

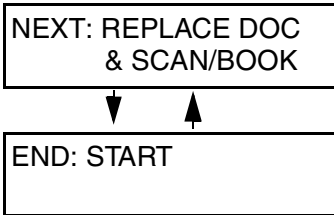

SCAN/BOOK



4 If the page on the document glass is the last page you wish to send, press the **START** key. Transmission begins.

If you have more pages to send, remove the page and place the next page on the document glass. Go back to Step 3. Continue to repeat Steps 3 and 4 until you have scanned all pages.

DONE:



START

MORE PAGES:

SCAN/BOOK



Optional Settings for Sending Faxes

Automatic redialing

If you use automatic dialing (including Direct Keypad Dialing) and the line is busy, the fax machine will automatically redial the number. The fax machine will make up to two redialing attempts at an interval of five minutes.

- ◆ To stop automatic redialing, press the **STOP** key.

Recall Interval for automatic redialing

If desired, you can change the interval at which the fax machine makes automatic redialing attempts.

- 1 Press these keys:

FUNCTION

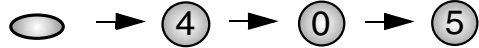

The display will show:

RECALL INTERVAL
ENTER (01-15) 05

- 2 Enter a 2-digit number from **01** to **15** for the number of minutes in the interval.

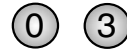

Example:
3 minutes

- 3 Press the **STOP** key to return to the date and time display.

STOP



Recall times for automatic dialing

If desired, you can change the maximum number of automatic redialing attempts made when the line is busy.

- ◆ Under certain conditions (for example if a person answers the call on a telephone), automatic redialing may stop before the set number of redialing attempts are made.

1 Press these keys:

FUNCTION

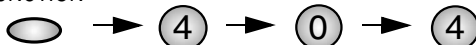

The display will show:

RECALL TIMES
ENTER (00-14) 02

2 Enter a 2-digit number from **00** to **10** for the maximum number of redial attempts.



Example:
5 attempts

3 Press the **STOP** key to return to the date and time display.

STOP



Error Correction Mode

The fax machine is set to automatically correct any distortions in a transmission due to noise on the telephone line before printing at the receiving end. This function is called Error Correction Mode (ECM). ECM is effective for both transmissions and receptions, and is only effective when the other fax machine has ECM as well.

If desired, you can turn ECM off. This will slightly increase the amount of memory available for memory transmission and reception.

- 1** Press these keys:

FUNCTION



The display will show:

ECM MODE
1=YES, 2=NO

- 2** Press **1** to turn on ECM or **2** to turn it off.

YES NO

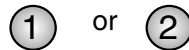

- 3** Press the **STOP** key to return to the date and time display.

STOP



Retransmission times (for memory transmission)

If a line error or power failure occurs during transmission from memory, your fax will automatically redial the number and attempt to complete the transmission. Retransmission will begin from the page that was being transmitted when the error occurred.

Your fax has been set at the factory to make 2 attempts at memory retransmission. If you wish to change the number of attempts, follow these steps:

1 Press these keys:

FUNCTION

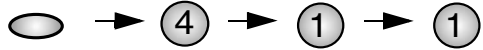

The display will show:

RETRANS TIMES
ENTER (0-9) 2

2 Enter a number from **0** to **9** for the maximum number of retransmission attempts.

5

Example: 5 attempts

3 Press the **STOP** key to return to the date and time display.

STOP



Retransmission interval (for memory transmission)

Your fax has been set at the factory to wait 5 minutes between each memory retransmission attempt. If you wish to change the interval between attempts, follow these steps:

1 Press these keys:

FUNCTION



The display will show:

RETRANS INTERVAL
ENTER (01-15) 05

2 Enter a 2-digit number from **01** to **15** for the interval between retransmission attempts.

0 5

Example: 5 attempts

3 Press the **STOP** key to return to the date and time display.

STOP



Broadcasting

This function allows you to send the same document to as many as 20 different fax locations with just one operation.

- 1 Load the document face up in the auto document feeder (max. 10 pages), or face down on the document glass.

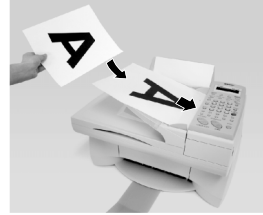

or

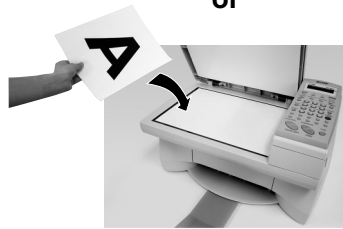

- Set the resolution and/or contrast if desired.

RESOLUTION



LIGHT/DARK



- 2 Press the **FUNCTION** key and then 6.

FUNCTION



The display will show:

6: BROADCAST MODE
ENTER STATION #

3 Dial the receiving machines (maximum of 20) using one or more of the following methods:

- Press one or more Rapid Keys.
- Enter 2-digit Speed Dial numbers, pressing the **SPEED DIAL** key before each 2-digit number.
- Enter full fax numbers, pressing the **START** key after each full number.

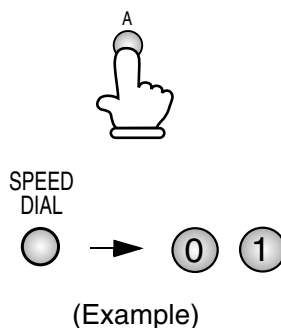

4 If the document is loaded in the auto document feeder, press the **START** key. Transmission begins.

If document is on the document glass, press the **SCAN/BOOK** key. After the document is scanned, press the **START** key if you have no further pages to send. If you have more pages to scan, place the next page on the document glass and then press the **SCAN/BOOK** key again. After the last page is scanned, press the **START** key to begin transmission.

- A Transaction Report is automatically printed out after Broadcasting is completed. Check the "Note" column of the report to see if any of the locations are marked "Busy" or have a communication error code. If so, send the document to those locations again.

From auto document feeder:



From document glass:



4. Receiving Faxes

Using AUTO Mode

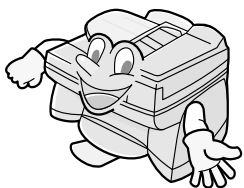

To select AUTO mode, press the **RECEPTION MODE** key until the arrow in the display points to AUTO.

RECEPTION
MODE



AUTO MANUAL

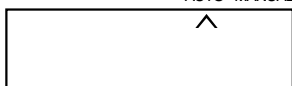

A.M.

When the reception mode is set to AUTO, the fax machine will automatically answer all calls on one ring and receive incoming faxes.

1 ring



Fax reception



- ◆ If you pick up the handset before the machine answers, you can talk to the other party and/or receive a document as explained in *Using MANUAL mode* on page 81.

Changing the number of rings

If desired, you can change the number of rings on which the fax machine answers incoming calls in AUTO mode. Any number from 0 to 9 can be selected.

1 Press these keys.

FUNCTION

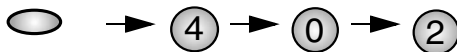

The display will show:

NUMBER OF RINGS
ENTER (0-9) (1)

2 Enter the desired number of rings
(any number from **0** to **9**).

3

- To have the Color Inkjet answer calls without ringing, select **0**.

Example: 3 rings

3 Press the **STOP** key to return to the date and time display.

STOP



Note: If you are using Distinctive Ring, the fax machine will answer calls after two rings regardless of the above setting.

Using MANUAL Mode



To select MANUAL mode, press the **RECEPTION MODE** key until the arrow in the display points to MANUAL.

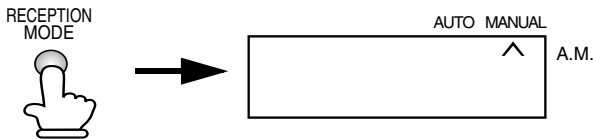

When the reception mode is set to MANUAL, you must answer all calls by picking up an extension phone connected to the same line.

- 1 Answer the extension phone when it rings.



- 2 If you hear a soft fax tone, wait until the Color Inkjet responds (the extension phone will go dead if it is connected to the Color Inkjet, or you will hear pronounced, high-pitched tones if the phone is connected to a separate wall jack), then hang up.



Phone goes dead or pronounced, high-pitched tones



-
- 3** If the Color Inkjet doesn't respond, or if the other party first talks to you and then wants to send a fax, press the **START** key on the Color Inkjet. (Press your **START** key before the person faxing presses their **START** key.) Hang up.

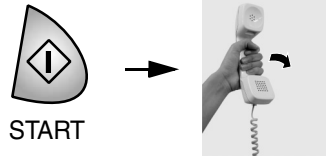

Note: If you have set the Fax Signal Receive setting to NO, press the **START** key on the Color Inkjet to begin reception.

Optional Reception Settings

Fax Signal Receive

Your fax will automatically begin reception if you hear a soft fax tone after answering a call on your fax or an extension phone. If you use a computer fax modem to send documents on the same line, you must turn this function off in order to prevent your fax from mistakenly attempting to receive documents from the computer fax modem. Follow the steps below to change the setting.

-
- 1** Press these keys:

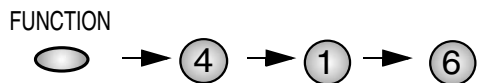

The display will show:

FAX SIGNAL RX
1=YES, 2=NO

-
- 2** Press **1** to turn on the function, or **2** to turn it off.

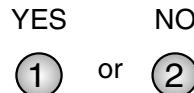

- 3** Press the **STOP** key to return to the date and time display.

STOP



Reception Ratio

The fax has been set at the factory to automatically reduce the size of received documents to fit the size of the printing paper. This ensures that data on the edges of the document are not cut off. If desired, you can turn this function off and have received documents printed at full size.

- ◆ If a document is too long to fit on the printing paper, the remainder will be printed on a second page. In this case, the cut-off point may occur in the middle of a line.
- ◆ Automatic reduction may not be possible if the received document is too large, contains too many fine graphics or images, or is sent at high resolution. In this case, the remainder of the document will be printed on a second page.

- 1** Press these keys:

FUNCTION



The display will show:

RECEPTION RATIO
 1=AUTO, 2=100%

- 2** Press **1** to turn on automatic reduction, or **2** to turn it off.

AUTO 100%

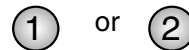

- 3** Press the **STOP** key to return to the date and time display.

STOP



Substitute Reception to Memory

In situations where printing is not possible, such as when your fax runs out of paper, the black print cartridge needs replacement, or the paper jams, incoming faxes will be received to memory.

When you have received a document in memory, FAX RX IN MEMORY will appear in the display, alternating with OUT OF PAPER, INK EMPTY, or PAPER JAM. When you add paper, replace the print cartridge, or clear the jam, the stored documents will automatically print out.

- ◆ If you received documents in memory because the fax ran out of paper, be sure to add paper which is the same size as the paper previously used. If not, the document print-out size may not match the size of the printing paper.

Caution!

- ◆ When documents are stored in memory, do not turn the power off. This will erase all of the contents.
- ◆ If documents received in memory are lost due to a power failure or other interruption in the power supply, a CLEAR REPORT will be printed out when the power is restored. This gives information about the receptions lost, including the fax numbers of the transmitting machines if they are available.

Distinctive Ring (Requires Subscription to Service)

Important:

- ◆ **To use distinctive ring, you must subscribe to a distinctive ring service from your local phone company.**
- ◆ Your fax machine may not be compatible with some distinctive ring services.

Distinctive ring is a service offered by some local telephone companies whereby they assign an additional second number to your regular single line. The second number rings differently from your normal number.

If you subscribe to a distinctive ring service, you can set the fax machine to automatically answer when your second number is called. This allows you to use the second number as an exclusive fax number.

To have your fax automatically answer when your second number is called, follow the steps below:

1 Press these keys:

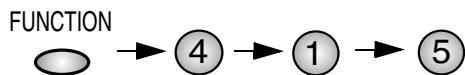

The display will show:

DISTINCTIVE RING
1:RING PATTERN 1

The ring pattern selections alternately appear here.

2 Press a number from **1** to **3** to select the ring pattern below that matches your second number's ring pattern. Or, press **4** to have your fax automatically answer your normal telephone number. Press **5** to turn off the distinctive ring function.

- | | | |
|----------|----------------|---|
| 1 | RING PATTERN 1 | Two short rings |
| 2 | RING PATTERN 2 | One short, one long, and one short ring |
| 3 | RING PATTERN 3 | Two short rings and one long ring |
| 4 | STANDARD RING | Your standard (normal) ring pattern |
| 5 | OFF SETTING | Turn distinctive ring off |

The display will briefly show your selection, and then:

16: FAX SIGNAL RX
PRESS START KEY

4 Press the **STOP** key to return to the date and time display.

STOP



5 Set the reception mode to AUTO.

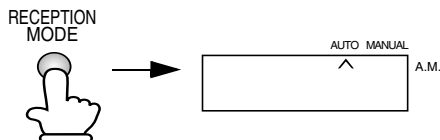

Distinctive Ring (Requires Subscription to Service)

- ◆ When using distinctive ring, you must set the reception mode of your fax machine to AUTO. When your designated fax number is dialed, your fax will automatically answer and begin reception after two rings. Note that other devices on the same line will also ring until your fax answers. If one of your other numbers is dialed, the fax will ring; however, it will not answer.

5. Printing

Printing a document from an application

1. When you are ready to print a document from an application on your computer, select **Print** from the **File** menu.

The **Print** dialog box appears.

2. If you need to select a special type or size of paper, or adjust any of the other print settings, select **Properties**, **Setup**, or **Printer** from the **Print** dialog box (the name of the button varies depending on the application).

The **Sharp AJ-5030 Properties** appear. Adjust the settings as desired, and then click **OK**. (For information on the settings, refer to your Online Guide or Help.)

Note: Do not use the keys on the Color Inkjet unit to adjust print settings. The Color Inkjet keys are only for copying and faxing.

4. Select the print range and adjust any other settings as desired in the **Print** dialog box.
5. When you are ready to begin printing, click **Print** or **OK** in the Print dialog box.

Note: When you adjust the print settings as explained above in Step 2, your changes will only remain in effect while you are using the application. If you wish to make permanent changes, open the Printers folder (click the **Start** button, point to **Settings**, and select **Printers**), right-click on the Sharp AJ-5030 icon, and select **Properties** from the sidebar menu.



To avoid printer jams, be sure to frequently remove printed pages from the output tray. Paper jams can be caused by too much paper in the output tray.

Printing on Specialty Papers

The Color Inkjet can print on the following special types of paper:

- ◆ Coated paper
- ◆ Glossy/photo paper
- ◆ Transparency film
- ◆ Iron-on transfers
- ◆ Greeting cards

You can load up to 10 sheets of coated paper, glossy paper, or transparency film in the paper tray.



Iron-on transfers and greeting cards must be loaded one sheet at a time in the paper tray.

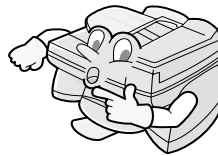

- ◆ Make sure the sheet is loaded **print side up** (for a transparency, make sure the rough side of the transparency is facing up). The sheet should be aligned against the right paper guide.
- ◆ Be sure to select the paper size and paper type in the Sharp AJ-5030 Properties before printing on the paper (select **Properties**, **Setup**, or **Printer** from the **Print** dialog box).
- ◆ When printing on transparencies, remove each transparency as it is printed to prevent smearing.

Printing on Envelopes or Cards

To print on envelopes and cards, you can use the manual card feeder on the back of the machine. Insert the envelope or card into the manual feeder with the print side up. For an envelope, the stamp position should be in the upper right corner.

- ◆ Only one envelope or card can be inserted at a time in the manual feeder.
- ◆ Be sure to select the correct envelope or card size and paper type in the **Paper** tab of the Sharp AJ-5030 Properties before printing. (Select **Properties**, **Setup**, or **Printer** from the **Print** dialog box to open the Sharp AJ-5030 Properties.)

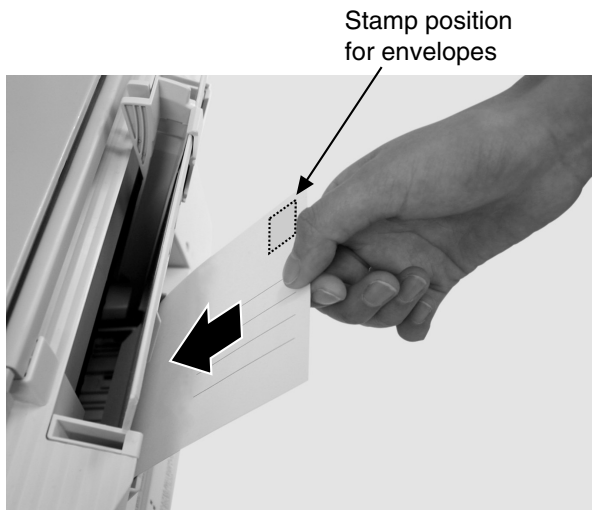

Note: For cards or envelopes that cannot be inserted in the manual feeder, use the paper tray. Remove any paper that is in the tray, and then insert the envelope or card print side up against the right paper guide. Pinch the left paper guide and slide it against the left side of the envelope or card.

Sharp AJ-5030 Control Panel

The Sharp AJ-5030 Control Panel allows you to monitor the status of your print jobs, and also lets you change and align print cartridges from your computer instead of using the panel keys on the Color Inkjet unit.

To open the Control Panel, click **Start** on the Windows taskbar, point to **Programs** and then **Sharp AJ-5030**, and then click on **Sharp AJ-5030 Control Panel**.

- ◆ For information on using the Control Panel, see your Online Guide or Help.

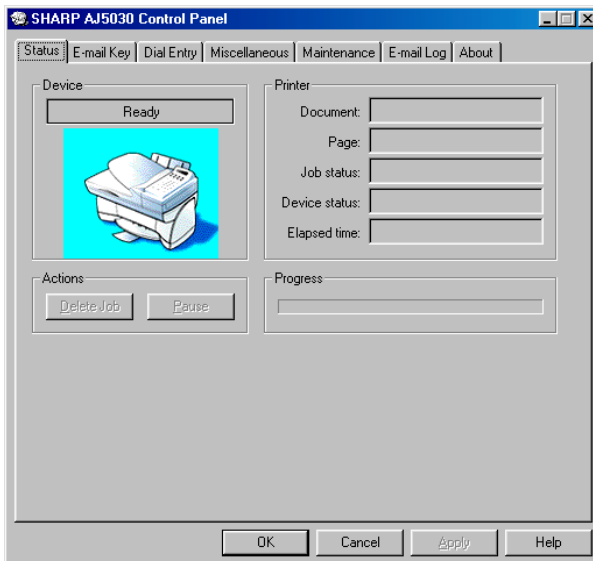

6. Scanning

Scanning a document

You can scan a document into the Sharp AJ5030 Desktop software.



You can also scan a document into any other software program that is Twain-compatible.



Scanning a document into the Sharp Desktop

1 Start the Sharp AJ5030 Desktop software in your computer.

2 Load the document you wish to scan in the auto document feeder or on the document glass:

- **Auto Document Feeder:** Adjust the document guides to the width of the document. Insert the document face up into the feeder.
- **Document glass:** Place the original face down on the glass with the top edge against the document guide. Make sure the center of the original is aligned with the center mark on the document guide.

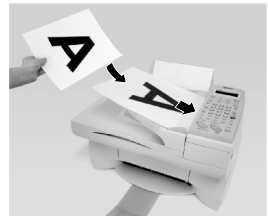

or

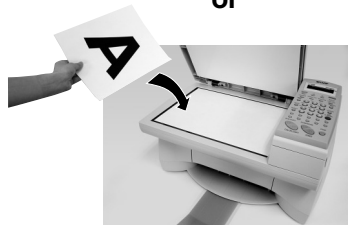

Important:

Make sure the glass is clean. Any dirt, fingerprints, hair, or other debris may affect the quality of the scanned image.

Note: If documents are loaded in both the auto document feeder and on the document glass, the document in the auto document feeder will be used.

-
- 3** Open the Scan dialog box by clicking on the **Acquire Image** button in the Sharp Desktop toolbar, or by selecting **Acquire Image** from the **File** menu of the Sharp Desktop.

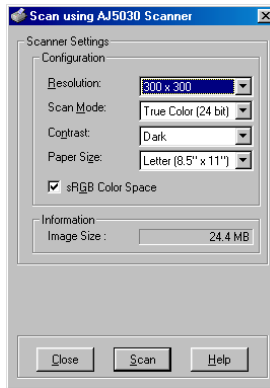

-
- 4** Adjust any of the scan settings in the Scan dialog box as desired.
- For information on adjusting the scan settings, see the Online Guide or Help.

-
- 5** When you are ready to begin the scan, click the **Scan** button in the Scan dialog box.

-
- 6** When the scan is completed, the image will appear in the Sharp Desktop. You can now use the tools in the Sharp Desktop to edit the image or save it to disk. For further information, see online Help.

Scanning a Document to Your E-mail Program

You can use the **E-MAIL** key to scan a document directly into your e-mail program to send as a file attachment.

Setting up the E-MAIL key

Before you can use the **E-MAIL** key, you must specify the e-mail program to use in the Sharp AJ-5030 Control Program.

To open the Control Program, click on the **Start** button on your Windows taskbar, point to **Programs** and then **Sharp AJ5030**, and then click on **Sharp AJ-5030 Control Program**. In the Control Program, select the **E-mail Key** tab. Under **E-mail Setting**, select the desired e-mail application from the drop-down list.

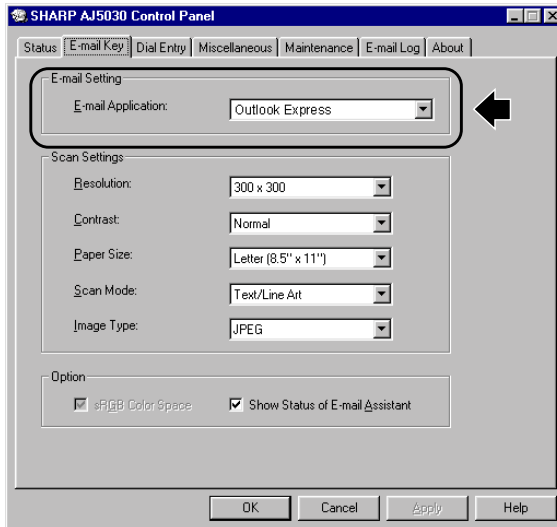

Scanning a document into your e-mail program

1 Load the document you wish to scan in the auto document feeder or on the document glass:

- **Auto Document Feeder:** Adjust the document guides to the width of the document. Insert the document face up into the feeder.
- **Document glass:** Place the original face down on the glass with the top edge against the document guide. Make sure the center of the original is aligned with the center mark on the document guide.

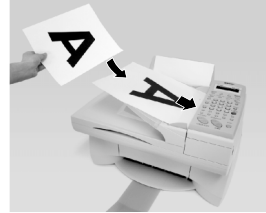

or

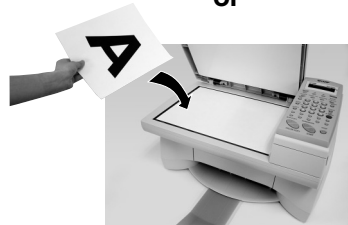

2 If desired, adjust the resolution with the **RESOLUTION** key and/or the contrast with the **LIGHT/DARK** key, or adjust the **Scan Settings** in the E-Mail Key tab of the Control Panel.

RESOLUTION



LIGHT/DARK



3 Press the **E-MAIL** key.

- Your specified e-mail program automatically starts. A new message is opened with the document as a file attachment. You can now select a recipient and enter a subject and/or message.



7. Answering Machine Hookup

Connecting an Answering Machine

If desired, you can connect an answering machine to your fax machine's **TEL. SET** jack. This will allow you to receive both voice messages and faxes when you are out.

- 1 Remove the seal covering the **TEL. SET** jack.
-

- 2 Connect the answering machine's telephone line jack to the **TEL. SET** jack.
 - If desired, you can connect an extension phone to your answering machine's extension phone jack.

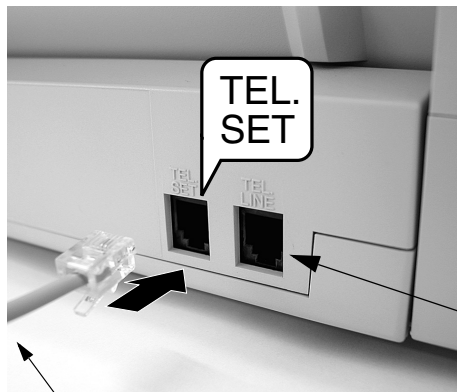

To answering machine's telephone line jack.

Connect the **TEL. LINE** jack to the wall jack.

Changing the outgoing message

The outgoing message (OGM) of your answering machine should be changed to inform callers who want to send a fax to press their Start key. For example, your message might go as follows:

"Hello. You've reached the ABC company. No one is available to take your call right now. Please leave a message after the beep or press your facsimile Start key to send a fax. Thank you for calling."

- ◆ Try to keep the length of the message under 10 seconds. If it is too long, you may have difficulty receiving faxes sent by automatic dialing.
- ◆ If your outgoing message must be longer than 10 seconds, leave a pause of about four seconds at the beginning of the message. This will give your fax a chance to detect fax tones sent when automatic dialing is used.

Activating the answering machine connection

Before you go out, activate the answering machine connection as follows:

- 1** Set the reception mode to A.M.

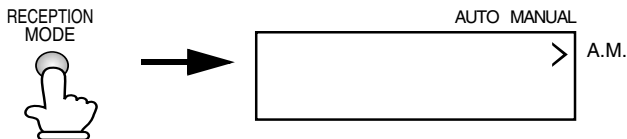

2 Set your answering machine to auto answer.

- Your answering machine must be set to answer on a maximum of two rings. If not, you may not be able to receive faxes sent by automatic dialing.
- If your answering machine has a toll saver function, make sure that it will answer by the fourth ring.

How the connection operates

While you are out, all of your incoming calls will be answered by your answering machine and its outgoing message will play. Voice callers can leave a message. During this time, your fax will quietly monitor the line. If your fax detects a fax tone or a duration of silence greater than four seconds, it will take over the line and begin reception.

When you return and turn off your answering machine, be sure to change the reception mode back to **AUTO** or **MANUAL**!



Optional A.M. Mode Settings

If necessary, you can use the following settings to improve the response of the answering machine hookup to incoming calls.

Quiet Detect Time

The fax machine is set to take over the line and begin reception if it detects 4 seconds of silence after the answering machine answers. If needed, you can change this setting to any number of seconds from 1 to 10.

- ◆ We recommend that you do not set Quiet Detect Time under 3 seconds.
- ◆ If the fax machine is interrupting callers before they can leave a message, try a longer Quiet Detect Time setting. If your outgoing message includes a period of silence, make sure that the setting is longer than that period of silence, or re-record your outgoing message to shorten the silence.

Note:

Quiet Detect Time can be turned off by entering "00" for the time. Note, however, that the fax machine may not be able to receive manually-sent faxes from some older fax machines.

1 Press these keys:

FUNCTION

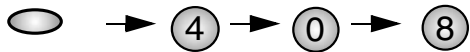

The display will show:

QUIET DETECT TM.
ENTER (00-10) 04

2 Enter a number from **01** to **10**, or enter **00** to turn off the function.



(Example)

-
- 3** Press the **STOP** key to return to the date and time display.

STOP



Fax when Answering machine Fails

When this function is turned on, your fax will answer the call after 5 rings if the answering machine for some reason fails to answer before that time. This ensures that you will receive fax messages even if the answering machine's tape fills up or the answering machine is not turned on.

This function has been turned off at the factory. If you want to turn it on, follow the steps below:

Note:

When this function is turned on, make sure that the answering machine is set to answer on 4 rings or less. If it isn't, the fax will always answer first, preventing callers from leaving voice messages.

-
- 1** Press these keys:

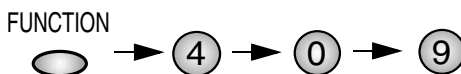

The display will show:

TAD FAILS
1=YES, 2=NO

-
- 2** Press **1** to turn on the function, or **2** to turn it off.

YES



or

NO



-
- 3** Press the **STOP** key to return to the date and time display.

STOP



8. Printing Lists

You can print lists showing settings and information entered in the fax machine. You can also print out reports on recent activity and individual operations after they are completed. The lists and reports are described on the following pages.

To print a list, follow the steps below.

- 1 Press the **FUNCTION** key and then 2.

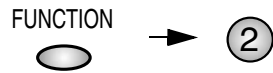

The display will show:

2: LISTING MODE
ENTER # (1-5,<,>)

- 2 Press the left or right arrow key until the desired list appears in the display.

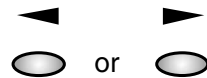

- 3 Press the **START** key to print the list.



Activity Report

This report shows information on your most recently performed send and receive operations (a combined maximum of 30 operations can appear). The report is divided into two parts: the **TRANSMISSIONS ACTIVITY REPORT**, which shows information on transmissions, and the **RECEPTIONS ACTIVITY REPORT**, which shows information on receptions.

- ◆ All information is erased after a report is printed out. If automatic print-out is turned off and the report is not printed manually for 30 operations, the information on the oldest operation will be overwritten each time a new operation is performed.

Explanation of headings

**SENDER/
RECEIVER** The name or fax number of the other machine involved in the transaction. If that machine does not have an ID function, the communication mode will appear (for example, "G3").

START The time at which transmission/reception started.

TX/RX TIME Total time taken for transmission/reception.

PAGES Number of pages transmitted/received.

NOTE (One of the following notes will appear under **NOTE** in the report to indicate whether the transaction was successful, and if not, the reason for the failure.)

OK - Transmission/reception was successful.

P.FAIL - A power failure prevented the transaction.

JAM - The printing paper or document jammed, preventing the transaction.

BUSY - The fax was not sent because the line was busy.

COM.E-0 to COM.E-14 - A telephone line error prevented the transaction. See *Line Error* on page 112.

CANCEL - The transaction was cancelled because the **STOP** key was pressed, no document was in the feeder, or the other machine requested transmission using a function which your fax machine does not have. If you were attempting to fax, make sure a document is in the feeder. If you were receiving, contact the faxing party to see how they are trying to send to you.

If desired, you can set the Activity Report to automatically print out whenever information on 30 operations has accumulated. (A report can still be printed on demand at any time.) Follow the steps below:

1 Press these keys:

FUNCTION

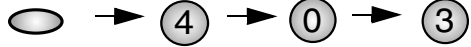

The display will show:

AUTO PRINT OUT
1=YES, 2=NO

2 Press **1** to turn on automatic print-out, or **2** to turn it off.

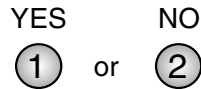

3 Press the **STOP** key to return to the date and time display.

STOP



Telephone Number List

This list shows the fax numbers that have been programmed into auto dial numbers.

TELEPHONE NUMBER LIST			
			JAN-30-2001 TUE 08:18 AM
RAPID #	SPEED #	NAME	TELEPHONE #
			CHAIN DIAL
A		Ever Green	147-789-5878
B		K Shop	589-789-4587
S01		John Canvas	E-MAIL STORED
S02		J Mart	487-885-7845

Option Setting List

This list shows the current selections for the option settings (the settings accessed by pressing the **FUNCTION** key and then **4**). The list also shows your name and fax/telephone number as entered in the machine, and a sample of the header printed at the top of every page you transmit (**HEADER PRINT**).

OPTIONS SETTING LIST		
FOR: ABC CORP.		JAN-09-2000 SAT 00:30 AM
523-456-0854		
NO.	ITEM	SETTING
01	FINE PRIORITY	NO
02	NUMBER OF RINGS	2 RINGS
03	AUTO PRINT OUT	NO
04	RECALL TIMES	2 TIMES
05	RECALL INTERVAL	5 MINUTES
06	TRANSACTION PRINT SELECT	ERROR ONLY
07	ECH MODE	NO
08	QUIET DETECT TIME	4 TIMES
09	TAD FAILS	NO
10	RECEPTION RATIO	AUTO
11	RETRANSMISSION TIME	2 TIMES
12	RETRANSMISSION INTERVAL	5 MINUTES
13	DIAL MODE	TO NE
14	EEPROM LENGTH	3 SECONDS
15	DISTINCTIVE RINGING	3 SECONDS
16	FAX SIGNAL RECEIVE	YES
17	DAY LIGHT SAVING TIME	NO

Print Setup List

This list shows the current status of the printing settings accessed by pressing the **FUNCTION** key and the **5** key.

Help List

This list provides a quick reference guide to the operation of your Color Inkjet.

Transaction Report

This report is printed out automatically after an operation is completed to allow you to check the result. Your fax machine is set at the factory to print out the report only when an error occurs.

- ◆ The same headings appear in the Transaction Report as in the Activity Report. See page 102 for an explanation of the headings.
- ◆ The Transaction report cannot be printed on demand.

If desired, you can change the conditions under which a report is printed out. Follow the steps below.

1 Press these keys:

FUNCTION

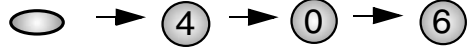

The display will show:



The selections alternately appear here.

2 Press a number from **1** to **5** to select the condition for printing.

- 1** ALWAYS PRINT A report will be printed after each transmission, reception, or error.
- 2** ERR/MEM A report will be printed after an error or memory operation.
- 3** SEND ONLY A report will be printed after each transmission.
- 4** NEVER PRINT A report will never be printed.
- 5** ERROR ONLY A report will be printed only when an error occurs.

3 Press the **STOP** key to return to the date and time display.

STOP



9. Maintenance and Troubleshooting

Cleaning the Scanning Glasses

Any dirt, fingerprints, or other small debris on the scanning glasses will degrade the quality of copies and scanned images, and increase scanning time. Clean the document glass and the scanning glass in the auto document feeder regularly as follows.

Cleaning the scanning glass in the auto document feeder

- 1 Open the operation panel (grasp ① and pull up).



- 2 Wipe the rollers ①.

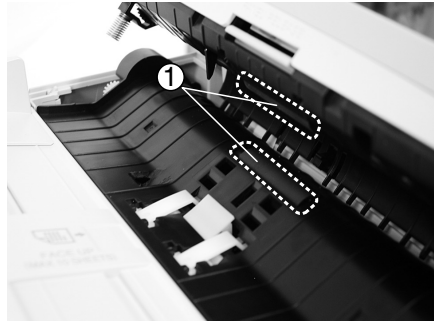

- 3** Lift the document glass cover and then rotate the black roller unit back until it locks into place. Wipe the document rollers ② and scanning glass ③. If needed, moisten the cloth with isopropyl alcohol or denatured alcohol.
- Make sure that all dirt and stains (such as correcting fluid) are removed, as dirt and stains will cause vertical lines on transmitted images and copies.

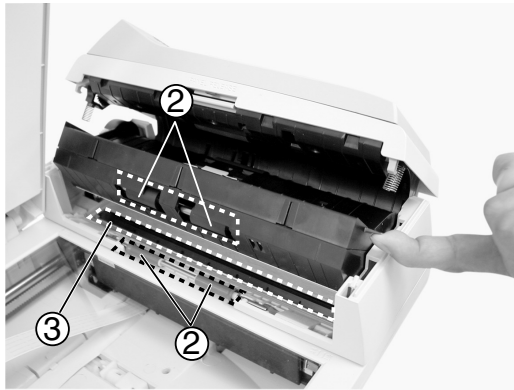

Cleaning the document glass

Clean the document glass by wiping it with a soft, dry cloth (be sure not to use a cloth that will scratch the glass). If needed, moisten the cloth with isopropyl alcohol or denatured alcohol.



Cleaning the housing

Wipe the surface and external parts of the machine with a soft cloth.

Caution!

Do not use solvents such as benzene or thinner. Solvents may damage or discolor the machine.

Improving Print Quality

If print quality is not satisfactory, first try aligning the print cartridges as explained on page 26. If the print quality is still not satisfactory after aligning the print cartridges, clean the cartridges as follows:

1 Press these keys:

FUNCTION



The display will show:

CLEAN NOZZLES
PRESS START KEY

2 Press the **START** key.

- The Color Inkjet prints out a nozzle test pattern similar to the one shown below.



START

3 Compare the diagonal line above the printed bars to the diagonal line below the printed bars.

- Look for a break in the diagonal line above the bars. A break indicates clogged nozzles.

Breaks in the diagonal line at the top of the page indicate clogged nozzles.

Cyan, magenta, yellow and black purge lines (shown here in black and white) print when ink is forced through the print nozzles to unclog them. If any of these colors do not print, you may need to replace your print cartridge.

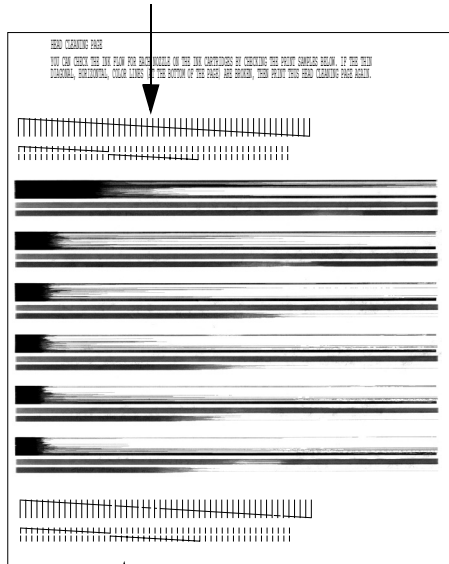

Unbroken lines at the bottom of the page indicate the nozzles were cleaned.

4 If the bottom diagonal line still has breaks, repeat Steps 1 and 2 to run the nozzle test again. Run the test a third time if necessary.

- If the print quality is satisfactory after running the nozzle test three times, the nozzles are clean.
- If the print quality is still not satisfactory after running the test a third time, continue with Step 5.

- 5** Open the print compartment cover of the Color Inkjet, and remove and reinstall the print cartridge.
-
- 6** Repeat the nozzle test. If the lines are still broken, wipe the nozzles as explained in the following section.

Wiping the print nozzles and contacts

If you have cleaned the print nozzles as explained in the previous section at least three times and print quality is still not satisfactory, try wiping the print nozzles and contacts.

- 1** Open the print compartment cover and remove the cartridges from the Color Inkjet.
-
- 2** Dampen a clean cloth with water, and gently wipe the nozzles and the gold-colored area around the nozzles.
 - To dissolve dried ink, hold the damp cloth against the nozzles for about three seconds. Gently blot and wipe dry.
 - When finished, allow the gold-colored area to dry.

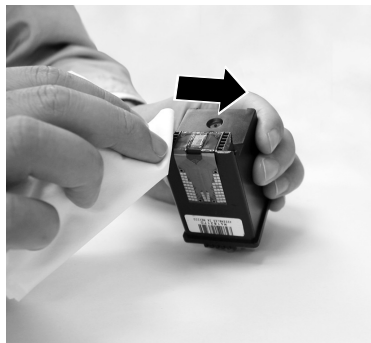

3 Dampen another section of clean cloth with water, and gently wipe the contacts and the gold-colored area around the contacts.

- When cleaning the color print cartridge, wipe the contacts in one direction.
- To dissolve dried ink, hold the damp cloth against the contacts for about three seconds. Gently blot and wipe dry.
- When finished, allow the gold-colored area to dry.



4 Reinstall the print cartridge and repeat the nozzle test as explained in the previous section.

Cleaning the print cartridge carrier

A dirty print cartridge carrier may cause smudges on your printed pages. To clean the print cartridge carrier, open the print compartment cover, remove the print cartridges, and wipe the carrier ① with a damp cloth.

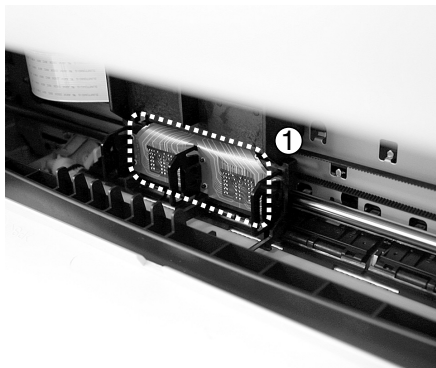

Faxing Problems

If you have any problems faxing, first refer to the following troubleshooting guide. If you cannot solve the problem, call Sharp's Customer Assistance Center at 1-800-BE SHARP.

Line error

Problem	Solution
<p>LINE ERROR appears in the display.</p>	<p>A line error occurs when your fax cannot communicate correctly with the other fax machine. The error is usually due to a problem on the phone line.</p> <p>Try the transaction again. If the error persists, check the following:</p> <ul style="list-style-type: none"> • Check the connection. The cord from the TEL. LINE jack to the wall jack should be no longer than six feet. • Make sure there are no modem devices sharing the same telephone line. • Check with the other party to make sure their fax machine is functioning properly. • Have your telephone line checked for line noise. • Try connecting the fax machine to a different telephone line. • If the problem still occurs, your fax machine may need service.

Dialing and transmission problems

Problem	Solution
No dial tone when you press the SPEAKER key.	<ul style="list-style-type: none"> • Make sure the line cord is connected to the TEL. LINE jack and a wall jack.
Dialing is not possible.	<ul style="list-style-type: none"> • Make sure the power cord is properly plugged into a power outlet. • Make sure that the telephone line is properly connected to both the TEL. LINE jack and the wall jack. • Make sure that the fax machine is set to the correct dialing mode for your telephone line. See <i>Connecting the telephone line cord</i> on page 17.
The power is on, but no transmission takes place.	<ul style="list-style-type: none"> • Make sure that the receiving machine has paper. • Make sure that the telephone line cord is plugged into the TEL. LINE jack, and not the TEL. SET jack. • If the receiving machine is in manual mode with no attendant, reception will not be possible. • Check the display for error messages. • Press the SPEAKER key and check for a dial tone.
Nothing is printed at the receiving end.	<ul style="list-style-type: none"> • Make sure that the document for transmission is placed face up in the auto document feeder, or face down on the document glass.
A distorted image is received at the other end.	<ul style="list-style-type: none"> • Noise on the telephone line may cause distortion. Try sending the document again. • Make a copy of the document on your machine. If the copy is also distorted, your machine may need service.

Reception and copying problems

Problem	Solution
<p>The machine doesn't receive documents automatically.</p>	<ul style="list-style-type: none"> • Make sure that the reception mode is set to AUTO. If you subscribe to a distinctive ring service, make sure that the Distinctive Ring function is set to the correct ring pattern. If you do not subscribe to a distinctive ring service, make sure that Distinctive Ring is set to OFF SETTING. (See <i>Distinctive Ring</i> on page 85.)
<p>The power is on, but no reception takes place.</p>	<ul style="list-style-type: none"> • Make sure that the telephone line cord is plugged into the TEL. LINE jack, and not the TEL. SET jack.
<p>The printing paper comes out blank when you try to receive a document.</p>	<ul style="list-style-type: none"> • Make sure that the document is loaded properly in the feeder of the transmitting machine. Make a copy or print a report to confirm the printing ability of your machine.
<p>The received document is faint.</p>	<ul style="list-style-type: none"> • Ask the other party to send higher contrast documents. If the contrast is still too low, your machine may need service. Make a copy or print a report to check your machine's printing ability.
<p>Received images are distorted.</p>	<ul style="list-style-type: none"> • Noise on the telephone line may cause distortion. Have the other party try sending the document again. • Make a copy or print a report on your machine. If the copy or report is also distorted, your machine may need service.
<p>The quality of copies is poor and/or spots appear.</p>	<ul style="list-style-type: none"> • Any dirt or material on the scanning glass will cause spots to appear on copies and transmitted faxes. Clean the scanning glass as explained on page 106.

Answering machine connection

Problem	Solution
<p>The answering machine connection does not operate properly.</p>	<ul style="list-style-type: none"> • Make sure your machine's reception mode is set to A.M. • Make sure your machine's TEL. LINE jack is connected to the wall jack. Make sure your machine's TEL. SET jack is connected to your answering machine's telephone line jack (not the answering machine's extension phone jack). • Make sure your answering machine's outgoing message is under 10 seconds. • Make sure that the Quiet Detect Time setting is set to three or four seconds (see page 99). • Make sure that the Distinctive Ring function is set to OFF SETTING (see page 85). • If you have checked all of the above and the hookup still doesn't operate properly, call the Customer Assistance Center.

General problems

Problem	Solution
Nothing appears in the display.	<ul style="list-style-type: none">• Make sure the power cord is properly plugged into a power outlet. Press the POWER key to turn on the power.• Connect another electrical appliance to the outlet to see if it has power.
The machine does not respond when you press any of its keys.	<ul style="list-style-type: none">• If a beep sound is not made when you press the keys, unplug the power cord and then plug it in again several seconds later.
Automatic document feeding does not work for transmission or copying.	<ul style="list-style-type: none">• Check the size and weight of the document (see <i>Using the Auto Document Feeder</i> on page 49).

Messages and Signals

Display messages

CHECK PAPER SIZE	The paper size setting is incorrect. Change the paper size setting as explained on page 21.
COVER OPEN	The print compartment cover is open. Close the cover.
DOCUMENT JAMMED	The original document is jammed. See the following section, <i>Clearing Paper Jams</i> .
FAX RX IN MEMORY	A fax has been received in memory because the black print cartridge is out of ink, you have run out of printing paper, or the paper is jammed. The fax will print out automatically when the problem is fixed.
FUNCTION MODE	The FUNCTION key has been pressed.
INK EMPTY	One of the print cartridges is out of ink. Replace the cartridge as explained on page 23.
INK NEAR EMPTY	One of the print cartridges is low on ink.
LINE ERROR	Transmission or reception was not successful. Press the STOP key to clear the message and then try again. If the error persists, see <i>Line Error</i> on page 112.
LINE IS IN USE	An extension phone connected to the machine is being used. Do not attempt transmission at this time, as this will interrupt the conversation on the extension phone.

Messages and Signals

MEMORY IS FULL	The memory is full. This may occur during fax reception if too much data is received before the pages can be printed out. If faxes have been received to memory because printing is not possible (an additional message will indicate the problem), resolve the problem so that printing can continue (see <i>Substitute Reception to Memory</i> on page 84). If you are attempting to transmit from memory, see <i>If the memory becomes full</i> on page 62.
MEMORY PRINTING	The machine is preparing to or printing out a document from memory.
NO DATA	This appears if you attempt to search for an automatic dialing number when none have been stored.
NO # STORED	You have tried to dial or clear a Rapid Key or Speed Dial number that hasn't been programmed (a full number hasn't been assigned to it).
ON HOOK DIAL	The SPEAKER key has been pressed and the machine is waiting for you to dial.
OUT OF PAPER	You are out of printing paper. Load paper as explained in <i>Loading Printing Paper</i> on page 20.
PAPER JAMMED	The printing paper is jammed. See the following section, <i>Clearing Paper Jams</i> .
TOTAL PAGE(S) 01	Number of pages transmitted, received, or copied.

Audible signals

Continuous tone	3 seconds	Indicates the end of transmission, reception, or copying.
Intermittent tone (3 beeps)	5 seconds (1 second on, 1 second off)	Indicates incomplete transmission, reception, or copying.
Rapid intermittent tone	35 seconds (0.7 seconds on, 0.3 seconds off)	Indicates that an extension phone connected to the machine is off hook.

Clearing Paper Jams

Clearing a jammed document

If the original document doesn't feed properly during transmission or copying, or DOCUMENT JAMMED appears in the display, first try pressing the **START** key. If the document doesn't feed out, open the operation panel and remove it.

Important:

Do not try to remove a document without opening the operation panel. This may damage the feeder mechanism.

- 1** If the jammed document protrudes from the feeder, grasp ① and pull up to open the operation panel.



- 2** Remove the document.



- 3** If the document doesn't protrude from the feeder, open the document glass cover and then rotate the black roller unit back. Gently pull the jammed document out of the document exit.



Clearing jammed printing paper

- 1** If the jammed paper protrudes from the paper tray, gently pull it out.



-
- 2** If the jammed paper does not protrude from the paper tray, open the print compartment cover and gently pull the jammed paper out.



-
- 3** If you cannot reach the jammed paper, or if it is an envelope or other small paper, pull it out through the hole in the rear of the machine.

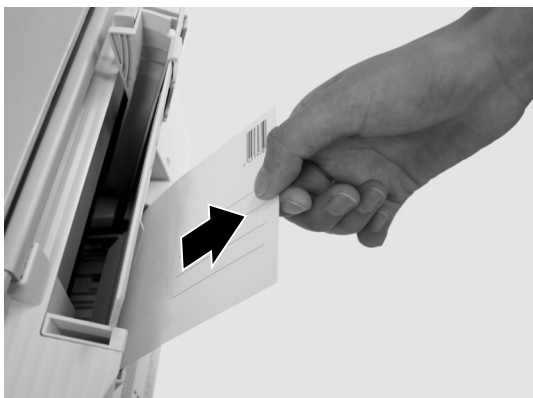

Ordering Parts

To order parts, contact the parts distribution center located nearest you. When ordering a part, use the part order number shown below.

Operation manual	TINSE4181XHTZ
Setup Guide	TCADZ3109XHZZ
Telephone line cord	QCNW-290ASCZZ
Paper tray	LPLTP3117XHSA
Output tray	LPLTP3116XHSA
Document tray	PHOP-2110XHSA
CD-ROM	UDSKA2033XHZZ
USB cable	QCNWG427AXHZZ

Part distribution centers

Tritronics, Inc. 1306 Continental Drive Abingdon, MD 21009	Tel: 1-800-638-3328 Fax: 1-800-888-FAXD
--	--

Tritronics, Inc. 1015 NW 52nd Street Ft. Lauderdale, FL 33309	Tel: 1-800-365-8030 Fax: 1-800-999-FAXD
---	--

Fox International, Ltd. 23600 Aurora Road Bedford Heights, OH 44146	Tel: 1-800-321-6993 Fax: 1-800-445-7991
---	--

Andrews Electronics 25158 Avenue Stanford Santa Clarita, CA 91355	Tel: 1-800-274-4666 Fax: 1-805-295-5126
---	--

Sharp Accessories and Supply Center 2130 Townline Road Peoria, IL 61615	Tel: 1-800-642-2122
--	---------------------

FCC Regulatory Information

This equipment complies with FCC rules, Part 68. On this equipment is a label that contains, among other information, the FCC Registration Number and Ringer Equivalence Number (REN) for this equipment. If requested, this information must be provided to your telephone company.

An FCC compliant telephone cord and modular plug is provided with this equipment. This equipment is designed to be connected to the telephone network or premises wiring using a compatible modular jack which is Part 68 compliant. This equipment connects to the telephone network through a standard USOC RJ-11C network interface jack.

The REN is used to determine the quantity of devices which may be connected to your telephone line and still have all of those devices ring when your number is called. Too many devices on one line may result in the devices not ringing in response to an incoming call. In most, but not all, areas as the sum of the RENs of all devices should not exceed five (5.0). To be certain of the number of devices that may be connected to your line, as determined by the total REN, contact your local telephone company.

If this equipment causes harm to the telephone network, your telephone company may disconnect your service temporarily. If possible, they will notify you in advance. If advance notice is not practical, you will be notified as soon as possible. You will also be advised of your right to file a complaint with the FCC.

Your telephone company may make changes in its facilities, equipment, operations, or procedures that could affect the operation of your equipment. If this happens, the telephone company will provide advance notice in order for you to make necessary modifications to maintain uninterrupted service. If the equipment is causing harm to the telephone network, your telephone company may ask you to disconnect the equipment until the problem resolved.

If you have any questions or problems which cannot be solved by reading this manual, please contact Sharp's Customer Assistance Center. The number is 1-800-BE SHARP.

This equipment may not be used on coin service provided by the telephone company. Connection to party lines is subject to state tariffs. Contact your state's public utility commission, public service commission, or corporation commission for more information.

This equipment is hearing-aid compatible.

When programming and/or making test calls to emergency numbers:

- ◆ Remain on the line and briefly explain to the dispatcher the reason for the call.
- ◆ Perform such activities in the off-peak hours, such as early morning or late evening.

S H A R P

Date Revised: _____
Date Issued : Sep. 20, 2000

MATERIAL SAFETY DATA SHEET (1/3)

MSDS No. B-1023

Section 1. Product and Company Identification

Product Name : Black Ink-Cartridge AJ-C50B

Supplier Identification : Sharp Corporation
22-22 Nagaike-cho, Abeno-ku, Osaka, Japan

Manufacturer : Lexmark International, Inc.
740 West New Circle Rd. Lexington, Kentucky, USA

Emergency telephone number : 1-859-232-3333

Local suppliers are listed below. Please contact the nearest supplier for additional information.

(Country)	(Name and Telephone Number)
U.S.A.	Sharp Electronics Corporation Telephone number for information: 1-800-237-4277
Canada	Sharp Electronics of Canada Ltd. Telephone number for information : 905-890-2100 Emergency telephone number : 1-800-255-3924

Section 2. Ingredients

<u>Ingredients</u>	<u>CAS No.</u>	<u>Proportion</u>	<u>OSHA PEL</u>	<u>ACGIH TLV</u>	<u>Other</u>
Carbon Black	1333-86-4	1-6	3.5 mg/kg(1)	3.5 mg/kg(1)	-
Water Soluble	(2)	5-10	None	None	None
Organic Solvents					
Water Soluble	NJ TRSN 80100451-5014	4-7	None	None	None
Organic Solvent					
Water Soluble	(2)	3-7	None	None	None
Organic Solvent					
Water	7732-18-5	>60	None	None	None

Notes: (1) Total dust, measured as carbon black.
(2) Trade secret or patented molecule.

Section 3. Hazardous Identification

The following information is based on data obtained from testing of the ink and the characteristics of ink component chemicals.

Primary Routes of Entry : Skin contact, ingestion of ink

Signs and Symptoms of Exposure : Ink stains on skin or mucus membranes (mouth, eyes & nose) may cause discomfort.

Medical Conditions Aggravated by Exposure : None known at intended levels of use.

POTENTIAL HEALTH EFFECTS :

- Inhalation :** Short Term Exposure - If ink mist is inhaled, respiratory tract irritation may occur. Exposure not probable with intended use.
Long Term Exposure - No adverse chronic effects known. Exposure not probable with intended use.
- Skin Contact :** Short Term Exposure - The ink may be slightly irritating to skin. Exposure not probable with intended use.
Long Term Exposure - No adverse chronic effects known. Exposure not probable with intended use.
- Eye Contact :** Short Term Exposure - Ink may be slightly irritating to the eye. Exposure not probable with intended use.
Long Term Exposure - No adverse chronic effects known. Exposure is not probable with intended use.
- Ingestion :** Short Term Exposure - Ink has low oral toxicity. Exposure not probable with intended use.
Long Term Exposure - Chronic toxicological testing of the ink formulation has not been completed. Based on component characteristics, liver, kidney, and CNS effects may be possible if large quantities of ink are ingested. Exposure not probable with intended use.

S H A R P

Date Revised: _____

Date Issued : Sep. 20. 2000

MATERIAL SAFETY DATA SHEET (2/3)

MSDS No. B-1023

Section 4. First-Aid Measures

Inhalation : Remove to fresh air. Seek medical attention if breathing becomes difficult.

Skin Contact : Remove contaminated clothing. Flush affected area with water. Seek medical attention if irritation develops and persists.

Eye Contact : Flush immediately with plenty of water. Remove contact lenses and continue flushing for at least 15 minutes. Seek medical attention if irritation develops and persists.

Ingestion : Immediately rinse mouth out with plenty of water. If within 30 minutes after ingestion, give victim a small glass of water or milk (NEVER give anything by mouth to an unconscious person). Contact physician or poison center. Do not induce vomiting unless instructed to do so by a physician or poison center.

Section 5. Fire-Fighting Measures

Flash Point : Not applicable

Autoignition : Not applicable

Flammability Limits (%) : Not applicable

Extinguishing Media : Water, foam, carbon dioxide or dry chemical.

Firefighting : Fire may produce small amounts of hazardous decomposition products such as carbon dioxide, carbon monoxide, and unidentified organics. NIOSH approved self contained breathing apparatus may be required if a large number of cartridges is involved.

Fire and Explosion Hazard : No unusual fire or explosion hazards are known for this product.

Hazardous Combustion Products : Oxides of carbon, organic acids, low molecular weight organics.

Section 6. Accidental Release Measures

The volume of liquid in a cartridge is minimal. Absorb small ink spills with cloth or paper towels or other suitable material. Place in a container for disposal. For large spills, involving a large number of cartridges, dike around spill with absorbent material. Transfer contaminated diking material to separate, suitable containers for recovery or disposal. Ventilate area and wash spill site after material pickup is complete. Unless specifically permitted, keep waste out of sewers, watershed and waterways. See Section 13 for information on the disposal of recovered material.

Section 7. Handling and Storage

To avoid damage to cartridge and accidental contact with ink - KEEP OUT OF REACH OF SMALL CHILDREN. STORE IN A COOL, DRY PLACE.

Section 8. Exposure Control/Personal Protection

Ventilation : None required with intended use. Mechanical room ventilation is recommended.

Eye Protection : None required for intended use in printer.

Protective Clothing : None required for intended use in printer.

Gloves : None required for intended use in printer.

Section 9. Physical and Chemical Properties

Description : Printer cartridge with sealed ink reservoirs. Ink has faint odor.

Melting Point : Not applicable

Freezing Point : Not applicable

Pressurized : No

Boiling Point : Not applicable

pH : Not applicable

Specific Gravity (H20 = 1) : Not applicable

Evaporation Rate : Not applicable

Water Solubility : Ink is water soluble.

% Volatility : Not applicable

Section 10. Stability and Reactivity

Conditions to Avoid : None known

Incompatibilities : None known

Hazardous Decomposition : Oxides of carbon, acid gases, low molecular weight organics

Polymerization : This product will not polymerize.

S H A R P

Date Revised: _____

Date Issued : Sep. 20. 2000

MATERIAL SAFETY DATA SHEET (3/3)

MSDS No. B-1023

Section 11. Toxicological Information

Acute Toxicity : Ink not acutely toxic.

Chronic Toxicity : Not expected to be chronically toxic based on component information, volume, concentration, and intended use. Pure carbon black, a minor component of this ink, has been listed by IARC as group 2B (possible carcinogen). This classification is based on rat "lung particulate overload" studies performed with airborne particulate carbon black. Ink is not listed by IARC, NTP, or OSHA.

Section 12. Ecological Information

No data available

Section 13. Disposal Consideration

This product is not a listed or hazardous waste in accordance with Federal Regulation 40 CFR Part 261. If discarded in its purchased form, this product would not be a hazardous waste either by listing or by characteristic. However, it is the responsibility of the product user to determine at the time of disposal whether a material has been contaminated and should be classified as a hazardous waste. In accordance with RCRA 40 CFR Sections 264.314 and 265.314, the placement of any liquid in landfills is prohibited. Disposal is subject to local, state and federal regulations.

Section 14. Transport Information

This product is not regulated as a hazardous material by the DOT.

Section 15. Regulatory Information

All ingredients are registered under the **Toxic Substances Control Act (TSCA)** or under polymer exemption.

All ingredients are exempt, registered or considered registered (polymers) under **European Inventory of Existing Commercial Chemical Substances (EINECS/ELINCS)**.

All ingredients are exempt, registered or considered registered (polymers) under the **Canadian Domestic Substances List (DSL/NDL)**.

None of the product ingredients are listed as **Emergency Planning and Community Right-to Know Act (EPCRA)- Section 302: Extremely Hazardous Substances (EHS)**.

None of the product components are present above the minimum quantities of listed chemicals in **EPCRA Section 313 Supplier Notification**.

This product contains no known materials at levels which the State of California has found to cause cancer, birth defects or other reproductive harm - **California Proposition 65**.

Section 16. Other Information

IARC(1996): IARC monographs on the Evaluation of the Carcinogenic Risk of Chemicals to Humans, Vol. 65, Printing Process And Printing Inks, Carbon Black and Some Nitro Compounds, Lyon, pp.149-261

H.Muhle, B.Bellmann, O.Creutzenberg, C.Dasenbrock, H.Ernst, R.Kilpper, J.C.MacKenzie, P.Morrow, U.Mohr, S.Takenaka, and R.Mermelstein(1991) Pulmonary Response to Toner upon Chronic Inhalation Exposure in Rats. Fundamental and Applied Toxicology 17, pp.280-299.

This information relates only to the specific material designated as supplied by the manufacturer. This information is supplied to us by the manufacturer and Sharp offers no warranties as to its accuracy and accepts no responsibilities for any typographical errors which may appear on these sheets. It is the responsibility of the user to determine the suitability of this product for each particular use.

S H A R P

Date Revised: _____
Date Issued : Sep. 20, 2000

MATERIAL SAFETY DATA SHEET (1/3)

MSDS No. B-1024

Section 1. Product and Company Identification

Product Name : Color Ink-Cartridge AJ-C50C

Supplier Identification : Sharp Corporation
22-22 Nagaike-cho, Abeno-ku, Osaka, Japan

Manufacturer : Lexmark International, Inc.
740 West New Circle Rd. Lexington, Kentucky, USA

Emergency telephone number : 1-859-232-3333

Local suppliers are listed below. Please contact the nearest supplier for additional information.

(Country)	(Name and Telephone Number)
U.S.A.	Sharp Electronics Corporation Telephone number for information: 1-800-237-4277
Canada	Sharp Electronics of Canada Ltd. Telephone number for information : 905-890-2100

Section 2. Ingredients

Ingredients	CAS No.	Proportion	OSHA PEL	ACGIH TLV	Other
Water Soluble Dyes	(1)	1-8	None	None	None
Water Soluble Organic Solvents	(1)	13-24	None	None	None
Hydroxylated Alkane	(1) (2)	0.5-8	None	None	None
Water	7732-18-5	60-75	None	None	None

Notes: (1) Trade secret or patented molecule.

Dye corresponding to color of ink:

Magenta: New Jersey Trade Secret Registration Number 80100451-5005.

Cyan: New Jersey Trade Secret Registration Number 80100451-5007.

Yellow: New Jersey Trade Secret Registration Number 80100451-5012.

(2) New Jersey Trade Secret Registration Number 80100451-5004.

Section 3. Hazardous Identification

The following information is based on data obtained from the characteristics of ink component chemicals.

Primary Routes of Entry : Skin contact, ingestion of ink

Signs and Symptoms of Exposure : Ink stains on skin or mucus membranes (mouth, eyes & nose) may cause discomfort.

Medical Conditions Aggravated by Exposure : None known at intended levels of use.

POTENTIAL HEALTH EFFECTS :

Inhalation : Short Term Exposure - If ink mist is inhaled, respiratory tract irritation may occur. Exposure not probable with intended use.

Long Term Exposure - No adverse chronic effects known. Exposure not probable with intended use.

Skin Contact : Short Term Exposure - The ink is slightly irritating to skin.

Long Term Exposure - No adverse chronic effects known. Not a dermal sensitiser. Exposure not probable with intended use.

Eye Contact : Short Term Exposure - Ink is moderately irritating to the eye.

Long Term Exposure - No adverse chronic effects known. Exposure is not probable with intended use.

Ingestion : Short Term Exposure - Oral toxicity expected to be low. Exposure not probable with intended use.

Long Term Exposure - No adverse chronic effects known. Exposure not probable with intended use.

Section 4. First-Aid Measures

Inhalation : Remove to fresh air. Seek medical attention if breathing becomes difficult.

Skin Contact : Remove contaminated clothing. Flush affected area with water. Seek medical attention if irritation develops and persists.

Eye Contact : Flush immediately with plenty of water. Remove contact lenses and continue flushing for at least 15 minutes. Seek medical attention if irritation develops and persists.

Ingestion : Immediately rinse mouth out with plenty of water. If within 30 minutes after ingestion, give victim a small glass of water or milk (NEVER give anything by mouth to an unconscious person). Contact physician or poison center. Do not induce vomiting unless instructed to do so by a physician or poison center.

S H A R P

Date Revised: _____

Date Issued : Sep. 20. 2000

MATERIAL SAFETY DATA SHEET (2/3)

MSDS No. B-1024

Section 5. Fire-Fighting Measures

Flash Point : Not applicable

Autoignition : Not applicable

Flammability Limits (%) : Not applicable

Extinguishing Media : Water, foam, carbon dioxide or dry chemical.

Firefighting : Fire may produce small amounts of hazardous decomposition products such as carbon dioxide, carbon monoxide, and unidentified organics. NIOSH approved self contained breathing apparatus may be required if a large number of cartridges is involved.

Fire and Explosion Hazard : No unusual fire or explosion hazards are known for this product.

Hazardous Combustion Products : Oxides of carbon, organic acids, low molecular weight organics.

Section 6. Accidental Release Measures

The volume of liquid in a cartridge is minimal. Absorb small ink spills with cloth or paper towels or other suitable material. Place in a container for disposal. For large spills, involving a large number of cartridges, dike around spill with absorbent material. Transfer contaminated diking material to separate, suitable containers for recovery or disposal. Ventilate area and wash spill site after material pickup is complete. Unless specifically permitted, keep waste out of sewers, watershed and waterways. See Section 13 for information on the disposal of recovered material.

Section 7. Handling and Storage

To avoid damage to cartridge and accidental contact with ink - KEEP OUT OF REACH OF SMALL CHILDREN.

STORE IN A COOL, DRY PLACE.

Section 8. Exposure Control/Personal Protection

Ventilation : None required with intended use. Mechanical room ventilation is recommended.

Eye Protection : None required for intended use in printer.

Protective Clothing : None required for intended use in printer.

Gloves : None required for intended use in printer.

Section 9. Physical and Chemical Properties

Description : Printer cartridge with sealed ink reservoirs. Ink has faint odor.

Melting Point : Not applicable

Freezing Point : Not applicable

Pressurized : No

Boiling Point : Not applicable

pH : Not applicable

Specific Gravity (H2O = 1) : Not applicable

Evaporation Rate : Not applicable

Water Solubility : Ink is water soluble.

% Volatility : Not applicable

Section 10. Stability and Reactivity

Conditions to Avoid : None known

Incompatibilities : None known

Hazardous Decomposition : Oxides of carbon, acid gases, low molecular weight organics

Polymerization : This product will not polymerize.

Section 11. Toxicological Information

Acute Toxicity : Not expected to be acutely toxic; estimated LD50 >5000 mg/kg for ink formulations.

Chronic Toxicity : Not expected to be chronically toxic based on component information, volume, concentration, and intended use.

Section 12. Ecological Information

No data available

S H A R P

Date Revised: _____

Date Issued : Sep. 20. 2000

MATERIAL SAFETY DATA SHEET (3/3)

MSDS No. B-1024

Section 13. Disposal Consideration

This product is not a listed or hazardous waste in accordance with Federal Regulation 40 CFR Part 261. If discarded in its purchased form, this product would not be a hazardous waste either by listing or by characteristic. However, it is the responsibility of the product user to determine at the time of disposal whether a material has been contaminated and should be classified as a hazardous waste. In accordance with RCRA 40 CFR Sections 264.314 and 265.314, the placement of any liquid in landfills is prohibited. Disposal is subject to local, state and federal regulations.

Section 14. Transport Information

This product is not regulated as a hazardous material by the DOT.

Section 15. Regulatory Information

All ingredients are registered under the **Toxic Substances Control Act (TSCA)** or under polymer exemption.

All ingredients are exempt, registered or considered registered (polymers) under **European Inventory of Existing Commercial Chemical Substances (EINECS/ELINCS)**.

All ingredients are exempt, registered or considered registered (polymers) under the **Canadian Domestic Substances List (DSL/NDSL)**.

One ink component contains low concentrations of isopropyl alcohol (CAS# 67-63-0) and methylchloride (CAS# 74-87-3).

These chemicals require export notification under the **Toxic Substances Control Act -TSCA 12(b)**.

None of the product ingredients are listed as **Emergency Planning and Community Right-to Know Act (EPCRA)- Section 302: Extremely Hazardous Substances (EHS)**.

None of the product components are present above the minimum quantities of listed chemicals in **EPCRA Section 313 Supplier Notification**.

This product contains no known materials at levels which the State of California has found to cause cancer, birth defects or other reproductive harm - **California Proposition 65**.

Section 16. Other Information

This information relates only to the specific material designated as supplied by the manufacturer. This information is supplied to us by the manufacturer and Sharp offers no warranties as to its accuracy and accepts no responsibilities for any typographical errors which may appear on these sheets. It is the responsibility of the user to determine the suitability of this product for each particular use.

Quick Reference Guide

Entering Your Name and Number

1. Press: → →

Display shows: OWN NUMBER SET
PRESS START KEY

2. Press:
 START

3. Enter your fax number (max. of 20 digits) by pressing the number keys.

- To insert a space between digits, press the # key.

- To clear a mistake, press the **SPEED DIAL** key.

4. Press:
 START

5. Enter your name by pressing the appropriate number keys as shown below.

- To enter two letters in succession that require the same key, press the right arrow key after entering the first letter.

SPACE =	J =	T =
A =	K =	U =
B =	L =	V =
C =	M =	W =
D =	N =	X =
E =	O =	Y =
F =	P =	Z =
G =	Q =	
H =	R =	cursor → =
I =	S =	cursor ← =

- To change case, press the **REDIAL** key. Press # or * to scroll through symbols and special characters

6. When finished, press: →

Setting the Date and Time

1. Press: → →

Display shows: DATE & TIME SET
DATE 01-01-2001

2. Enter two digits for the month (01 to 12).

3. Enter two digits for the day (01 to 31).

4. Enter four digits for the year (Ex: 2001)

5. Enter two digits for the hour (01 to 12) and two digits for the minute (00 to 59).

6. Press * for A.M. or # for P.M.

7. When finished, press: →

Storing and Clearing Auto Dial Numbers

1. Press: → →

Display shows: FAX/TEL # MODE
1=SET, 2=CLEAR

2. Press **1** to store a number or **2** to clear a number.

3. Press a Rapid Key or enter a 2-digit Speed Dial number (from **01** to **89**). (If you are clearing a number, go to Step 7.)

4. Enter the fax number.

5. Press:
 START

6. Enter the name of the location by pressing number keys. (Refer to the letter entry table in *Entering Your Name and Number*.)

7. Press:
 START

8. Press **1** if the number is an area/access code, or **2** if it is a regular fax number.

9. Press:



Quick Reference Guide

Sending Faxes

Place your document (up to 10 pages) face up in the auto document feeder.



Normal Dialing

1. Lift an extension phone connected to the machine or press:  **SPEAKER**
2. Dial the fax number. 
3. Wait for the reception tone (if a person answers, ask them to press their Start key).

4. Press:  **START**

Rapid Key Dialing

Press the appropriate Rapid Key. Transmission will begin automatically.

Speed Dialing

1. Press:  **SPEED DIAL**
2. Enter the 2-digit Speed Dial number.
3. Press:  **START**

Sending Faxes from the Document Glass

1. Load the document face down on the document glass. 
2. Press the number keys to dial the fax number (or press a Rapid Key, or press the **SPEED DIAL** key and enter a Speed Dial number).

3. Press:  **SCAN/BOOK**
4. After scanning, load the next page and press the **SCAN/BOOK** key again. When all pages have been scanned, press:



Receiving Faxes

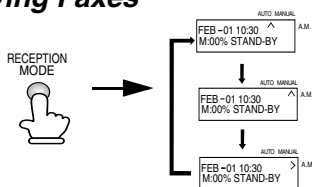

AUTO mode: The machine automatically answers on one ring and receives the incoming document.

MANUAL mode: Answer the call on extension phone connect to the same line. Press the **START** key to begin reception.

A.M. mode: Select this mode when an answering machine is connected to the machine and the answering machine is turned on.

Making Copies

1. Load the document face down on the document glass. 

Or

Insert the face up in the auto document feeder (max 10 pages). 

2. Adjust copy settings as desired:

RESOLUTION



ENLARGE
REDUCE



LIGHT/DARK



PAPER TYPE



Enter number
of copies per
original

3. For a color copy, press:



COLOR COPY
B/W COPY

For a black and white copy, press:



Guía de referencia rápida

Introducción de su nombre y número

1. Pulse: → →
 El visor muestra: OWN NUMBER SET
PRESS START KEY

2. Pulse:
START

3. Introduzca su número de telefax (20 dígitos como máx.) mediante pulsación de las teclas numéricas.

- Pulse la tecla # para introducir un espacio libre.

- To clear a mistake, press the **SPEED DIAL** key.

4. Pulse:
START

5. Introduzca su nombre mediante pulsación de las teclas numéricas adecuadas como se muestra a continuación.

- To enter two letters in succession that require the same key, press the right arrow key after entering the first letter.

SPACE =	J =	T =
A =	K =	U =
B =	L =	V =
C =	M =	W =
D =	N =	X =
E =	O =	Y =
F =	P =	Z =
G =	Q =	
H =	R =	
I =	S =	

cursor → =
 cursor ← =

- Para cambiar de mayúscula a minúscula y viceversa, pulse la tecla **REDIAL** (repetición de llamada). Pulse la tecla # o * para hojear por los símbolos y caracteres especiales.

6. Una vez finalizado pulse: →
START STOP

Ajuste de la fecha y hora

1. Pulse: → →

El visor muestra: DATE & TIME SET
DATE 01-01-2001

2. Introduzca dos dígitos para el mes (01 hasta 12).

3. Introduzca dos dígitos para el día (01 hasta 31).

4. Introduzca cuatro dígitos para el año (Ej.: 2001).

5. Introduzca dos dígitos para la hora (01 hasta 12) y dos dígitos para los minutos (00 hasta 59).

6. Pulse * para A.M. o # para P.M.

7. Una vez finalizado pulse: →
START STOP

Memorización y borrado de números de marcación automática

1. Pulse: → →

El visor muestra: FAX/TEL # MODE
1=SET, 2=CLEAR

2. Pulse **1** para guardar un número o **2** para borrarlo.

3. Pulse Usted una tecla rápida o entre un número de 2 dígitos de discado rápido (entre **01** y **89**), (si Usted está borrando un número, siga con el paso 7.)

4. Enter the fax number.

5. Pulse:
START

6. Introduzca el número del puesto mediante pulsación de las teclas numéricas. (Consulte la tabla para introducción de letras en la *Introducción de su nombre y número*).

7. Pulse:
START

8. Press **1** if the number is an area/access code, or **2** if it is a regular fax number.

9. Pulse:
STOP

Transmisión de mensajes telefax

Place your document (up to 10 pages) face up in the auto document feeder.



Marcación normal

1. Lift an extension phone connected to the machine or press: 
2. Marque el número de telefax.
3. Espere hasta escuchar el tono de recepción (si contestara una persona, pídale pulsar su tecla Start).

4. Pulse: 

Marcación rápida

Press the appropriate Rapid Key. Transmission will begin automatically.



Marcación abreviada

1. Pulse: 
2. Introduzca el número de dos dígitos de marcación abreviada.

3. Pulse: 

Sending Faxes from the Document Glass

1. Load the document face down on the document glass. 
2. Press the number keys to dial the fax number (or press a Rapid Key, or press the **SPEED DIAL** key and enter a Speed Dial number).

3. Pulse: 
4. After scanning, load the next page and press the **SCAN/BOOK** key again. When all pages have been scanned, press: 

Recepción de mensajes telefax

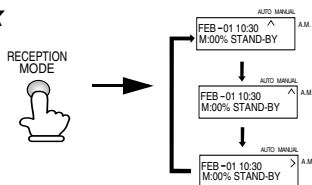

AUTO mode: The machine automatically answers on one ring and receives the incoming document.

MANUAL mode: Answer the call on extension phone connect to the same line. Press the **START** key to begin reception.

A.M. mode: Select this mode when an answering machine is connected to the machine and the answering machine is turned on.

Making Copies

1. Load the document face down on the document glass. 

Or

Insert the face up in the auto document feeder (max 10 pages). 

2. Adjust copy settings as desired:

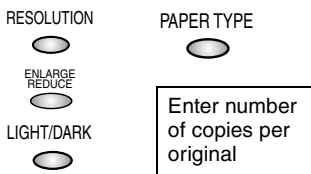

3. For a color copy, press: 

For a black and white copy, press: 

COLOR COPY

B/W COPY

Index

A

- A.M. reception mode, 39, 97
- Activity Report, 101
 - Auto print-out, 103
- Answering machine hookup
 - Activating, 97
 - Connecting, 96
 - Fax reception when TAD fails, 100
 - Quiet Detect Time, 99
 - Troubleshooting, 115
- Audible signals, 119
- Auto document feeder
 - Document guides, 51
 - Document restrictions, 50
 - Document sizes, 49
 - Loading document, 51
 - Maximum scanning size, 50
- AUTO reception mode, 39, 79

B

- Beep length, 42
- Broadcasting, 77

C

- Chain Dialing, 60
- Contrast, 47
- Control Program, 91
- Copies, making, 43-44
- Copies, number of, 47
- Copy cut-off setting, 52
- Copy settings
 - Contrast, 47
 - Default, 44
 - Enlarge/reduce, 46
 - Number of copies, 47
 - Resolution, 45

D

- Date, setting, 36
- Daylight Saving Time, 38
- Dial mode, 17
- Dialing
 - Chain, 60
 - Direct Keypad, 65
 - Normal, 53
 - Rapid Key, 63
 - Speed, 64
- Direct Keypad Dialing, 65
- Display messages, 117
- Distinctive ring, 85
- Document glass, cleaning, 107
- Document glass, faxing from, 71
- Document transmission, 69

E

- ECM (Error Correction Mode), 75
- E-MAIL key, using, 94
- Enlarging a copy, 46
- Envelopes, printing, 90

F

- Fax Signal Receive, 82

H

- Halftone setting, 55
- Help List, 104

J

- Jams, clearing, 120-122

L

- Letters, entering, 34
- Line error, 112
- Loading printing paper, 20

Index

M

- MANUAL reception mode, 39, 81
- Memory
 - Substitute reception to, 84

N

- Normal Dialing, 53
- Number of rings in AUTO reception mode, 80

O

- Option Setting List, 104
- Ordering parts, 123
- Original document support, 18

P

- Paper jams, clearing, 120-122
- Paper size setting, 21
- Paper type setting, 21, 48
- Paper, loading, 20
- Pauses in automatic dialing, 58
- Power cord, 16
- Print cartridge carrier, wiping, 111
- Print cartridges
 - Aligning, 26-29
 - Installing, 23-26
- Print nozzles, cleaning, 108-110
- Print nozzles, wiping, 110
- Print Setup List, 104
- Printer cable, connecting, 14-15
- Printing, 88-91
 - Cards, 90
 - Control Program, 91
 - Envelopes, 90
 - Specialty papers, 89

R

- Rapid Key Dialing, 63
- Recall interval, 73
- Recall times, 74
- Reception mode
 - A.M. mode, 39, 97
 - AUTO mode, 39, 79
 - MANUAL mode, 39, 81
- Reception Ratio setting, 83
- Redialing, 54, 73
- Reducing a copy, 46
- Resolution, 45
- Retransmission interval, 76
- Retransmission times, 75
- Ringer volume, 41

S

- Scanner, releasing and locking, 15
- Scanning, 92-93
- Scanning glass, cleaning, 106
- Search Dial, 66
- Sender's name and number, entering,
 - 32-35
- Software, installing, 30
- Speaker volume, 40
- Speed Dialing, 64
- Status List, 68

T

- TEL. LINE jack, 17
- TEL. SET jack, 19, 96
- Telephone Number List, 103
- Test page, printing, 29
- Time, setting, 36
- Transaction Report, 104
- Transmission jobs, checking, 67

LIMITED WARRANTY

SHARP ELECTRONICS CORPORATION warrants to the first end user purchaser that this Sharp brand product (the "Product"), when shipped in its original container, will be free from defective workmanship and materials, and agrees that it will, at its option, either repair the defect or replace the defective Product or part thereof with a new or remanufactured equivalent at no charge to the purchaser for parts or labor for the period(s) set forth below.

This warranty does not apply to any appearance items of the Product nor to the additional excluded item(s) set forth below nor to any product the exterior of which has been damaged or defaced, which has been subjected to misuse, abnormal service or handling, or which has been altered or modified in design or construction.

In order to enforce the rights under this limited warranty, the purchaser should follow the steps set forth below and provided proof of purchase to the servicer.

To the extent permitted by applicable state law, the warranties set forth herein are in lieu of, and exclusive of, all other warranties, express or implied. Specifically, ALL OTHER WARRANTIES OTHER THAN THOSE SET FORTH ABOVE ARE EXCLUDED. ALL EXPRESS AND IMPLIED WARRANTIES INCLUDING THE WARRANTIES OF MERCHANTABILITY, FITNESS FOR USE, AND FITNESS FOR A PARTICULAR PURPOSE ARE SPECIFICALLY EXCLUDED. If, under applicable state law, implied warranties may not validly be disclaimed or excluded, the duration of such implied warranties is limited to the period(s) from the date of purchase set forth below.

Neither the sales personnel of the seller nor any other person is authorized to make any warranties other than those described above, or to extend the duration of any warranties beyond the time period described above on behalf of Sharp.

The warranties described herein shall be the sole and exclusive warranties granted by Sharp and shall be the sole and exclusive remedy available to the purchaser. Correction of defects, in the manner and for the period of time described herein, shall constitute complete fulfillment of all liabilities and responsibilities of Sharp to the purchaser with respect to the Product, and shall constitute full satisfaction of all claims, whether based on contact, negligence, strict liability or otherwise. In no event shall Sharp be liable, or in any way responsible, for any damages or defects in the Product which were caused by repairs or attempted repairs performed by anyone other than an authorized servicer. Nor shall Sharp be liable or in any way responsible for any incidental or consequential economic or property damage. Some states do not allow limits on warranties or on remedies for breach in certain transactions; in such state the limits herein may not apply.

Your Product:

Warranty Period for this Product:

Additional items excluded

from warranty coverage:

Where to obtain service:

What to do to obtain service:

Personal Facsimile

Ninety (90) days parts and labor from date of purchase.

Any consumable items such as paper supplied with the Product.

At a Sharp Authorized Servicer located in the United States.

To find out the location of the nearest Sharp Authorized Servicer, call Sharp toll free at 1-800-BE-SHARP.

Ship (prepaid) or carry in your Product to a Sharp Authorized Servicer.

Be sure to have proof of purchase available. If you ship or mail the Product, be sure it is packaged carefully.

For product information or customer assistance, please visit <http://www.sharp-usa.com> on the World Wide Web or call **1-800-BE SHARP**.

SHARP DOCUMENT NETWORK SYSTEM OF AMERICA

Sharp Plaza,

Mahwah, New Jersey 07430-2135

SHARP®

SHARP DOCUMENT NETWORK SYSTEM OF AMERICA

Sharp Plaza, Mahwah, New Jersey 07430-2135

SHARP CORPORATION

FOR YOUR RECORDS

Please record the model number and serial number below, for easy reference, in case of loss or theft. These numbers are located on the rear side of the unit. Space is also provided for other relevant information.

Model Number

Serial Number

Date of Purchase

Place of Purchase

PRINTED IN THAILAND

(TINSE4181SCJZ)

Free Manuals Download Website

<http://myh66.com>

<http://usermanuals.us>

<http://www.somanuals.com>

<http://www.4manuals.cc>

<http://www.manual-lib.com>

<http://www.404manual.com>

<http://www.luxmanual.com>

<http://aubethermostatmanual.com>

Golf course search by state

<http://golfingnear.com>

Email search by domain

<http://emailbydomain.com>

Auto manuals search

<http://auto.somanuals.com>

TV manuals search

<http://tv.somanuals.com>