

# SHARP®

DIGITAL MULTIFUNCTIONAL SYSTEM  
MX-M364N/MX-M464N/MX-M564N

## QUICK START GUIDE

## CONTENTS

CAUTIONS	3
PART NAMES	7
TURNING THE POWER ON AND OFF	8
OPERATION MANUALS AND HOW TO USE THEM	9
SPECIFICATIONS	10
TO THE ADMINISTRATOR OF THE MACHINE	14
INFORMATION ON DISPOSAL	15

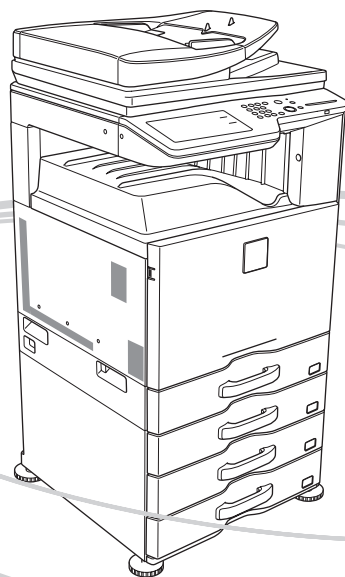

Keep this manual close at hand for reference whenever needed.

## Caution!

For complete electrical disconnection, pull out the main plug.

The socket-outlet shall be installed near the equipment and shall be easily accessible.



Shielded interface cables must be used with this equipment to maintain compliance with EMC regulations.

The equipment should be installed near an accessible socket outlet for easy disconnection.

Each instruction also covers the optional units used with these products.

## Notice for users in the UK

### MAINS PLUG WIRING INSTRUCTIONS

The mains lead of this equipment is already fitted with a mains plug which is either a non-rewireable (moulded) or a rewireable type. Should the fuse need to be replaced, a BSI or ASTA approved fuse to BS1362 marked  or  and of the same rating as the one removed from the plug must be used. Always refit the fuse cover after replacing the fuse on the moulded plug. Never use the plug without the fuse cover fitted. In the unlikely event of the socket outlet in your home not being compatible with the plug supplied either cut-off the moulded plug (if this type is fitted) or remove by undoing the screws if a rewireable plug is fitted and fit an appropriate type observing the wiring code below.

**DANGER:** The fuse should be removed from the cut-off plug and the plug destroyed immediately and disposed of in a safe manner. Under no circumstances should the cut-off plug be inserted elsewhere into a 13A socket outlet as a serious electric shock may occur.

To fit an appropriate plug to the mains lead, follow the instructions below:

**IMPORTANT:** The wires in this mains lead are coloured in accordance with the following code:

**GREEN-AND-YELLOW:**  
**BLUE:**  
**BROWN:**

**Earth**  
**Neutral**  
**Live**

As the colours of the wires in this mains lead may not correspond with coloured markings identifying the terminals in your plug, proceed as follows:

The wire which is coloured **GREEN-AND-YELLOW** must be connected to the terminal in the plug which is marked with the letter **E**, or by the safety earth symbol , or coloured green or greenand-yellow.

The wire which is coloured **BLUE** must be connected to the terminal which is marked with the letter **N** or coloured black.

The wire which is coloured **BROWN** must be connected to the terminal which is marked with the letter **L** or coloured red.

If you have any doubt, consult a qualified electrician.

**WARNING: THIS APPARATUS MUST BE EARTHED.**

## EMC (this machine and peripheral devices)

### ■ Warning:

This is a Class A product. In a domestic environment this product may cause radio interference in which case the user may be required to take adequate measures.

Peripheral devices are described in the [PERIPHERAL DEVICE] in the Operation Guide.

This machine contains the software having modules developed by Independent JPEG Group.

Copyright© 1995-2007 Adobe Macromedia Software LLC. All rights reserved.

## For the users of the fax function

### ■ FAX interface cable and Line cable:

These special accessories must be used with the device.

The declaration of conformity may be consulted at: <http://www.sharp.de/doc/MX-FX11.pdf>

## SOFTWARE LICENCE

The SOFTWARE LICENCE will appear when you install the software from the CD-ROM. By using all or any portion of the software on the CD-ROM or in the machine, you are agreeing to be bound by the terms of the SOFTWARE LICENCE.



- The explanations in this manual assume that you have a working knowledge of your Windows or Macintosh computer.
- For information on your operating system, please refer to your operating system manual or the online Help function.
- The explanations of screens and procedures in this manual are primarily for Windows® 7 in Windows® environments. The screens may vary depending on the version of the operating system.
- This manual contains references to the fax function. However, please note that the fax function is not available in some countries and regions.
- Considerable care has been taken in preparing this manual. If you have any comments or concerns about the manual, please contact your dealer or nearest authorised service representative.
- This product has undergone strict quality control and inspection procedures. In the unlikely event that a defect or other problem is discovered, please contact your dealer or nearest authorised service representative.
- Aside from instances provided for by law, SHARP is not responsible for failures occurring during the use of the product or its options, or failures due to incorrect operation of the product and its options, or other failures, or for any damage that occurs due to use of the product.



Products that have earned the ENERGY STAR® are designed to protect the environment through superior energy efficiency.

The products that meet the ENERGY STAR® guidelines carry the ENERGY STAR® logo.

The products without the logo may not meet the ENERGY STAR® guidelines.

### ■ Warranty

While every effort has been made to make this document as accurate and helpful as possible, SHARP Corporation makes no warranty of any kind with regard to its content. All information included herein is subject to change without notice. SHARP is not responsible for any loss or damages, direct or indirect, arising from or related to the use of this operation manual.

© Copyright SHARP Corporation 2013. All rights reserved. Reproduction, adaptation or translation without prior written permission is prohibited, except as allowed under copyright laws.

# CAUTIONS

## Symbols in this manual

To ensure safe use of the machine, this manual uses various safety symbols. The safety symbols are classified as explained below. Be sure you understand the meaning of the symbols when reading the manual.



**WARNING**  
Indicates a risk of death or serious injury.



**CAUTION**  
Indicates a risk of human injury or property damage.

Meaning of the symbols



**CAUTION!**  
HOT



**PINCH POINT**  
KEEP CLEAR



**PROHIBITED**  
ACTIONS

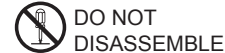

**DO NOT**  
DISASSEMBLE



**MANDATORY**  
ACTIONS

## Power notes

### **WARNING**

-  **Be sure to connect the power cord only to a power outlet that meets the specified voltage and current requirements. Also make certain the outlet is properly grounded. Do not use an extension cord or adapter to connect other devices to the power outlet used by the machine.**  
**Using an improper power supply may cause fire or electrical shock.**

\* For the power supply requirements, see the name plate in the lower left corner of the left side of the machine.

-  **Do not damage or modify the power cord.**  
Placing heavy objects on the power cord, pulling it, or forcibly bending it will damage the cord, resulting in fire or electrical shock.

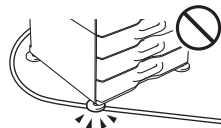

-  **Do not insert or remove the power plug with wet hands.**  
This may cause electrical shock.

### **CAUTION**

-  **When removing the power plug from the outlet, do not pull on the cord.**  
Pulling on the cord may cause damage such as wire exposure and breakage, and may result in fire or electrical shock.

-  **If you will not use the machine for a long time, be sure to remove the power plug from the outlet for safety.**

-  **When moving the machine, switch off the main power and remove the power plug from the outlet before moving.**  
The cord may be damaged, creating a risk of fire or electrical shock.

## Installation notes

### CAUTION

-  **Do not install the machine on an unstable or slanted surface. Install the machine on a surface that can withstand the weight of the machine.**

Risk of injury due to the machine falling or toppling.  
If peripheral devices are to be installed, do not install on an uneven floor, slanted surface, or otherwise unstable surface. Danger of slippage, falling, and toppling. Install the product on a flat, stable surface that can withstand the weight of the product.

-  **Do not install in a location with moisture or dust.**

Risk of fire and electrical shock.  
If dust enters the machine, dirty output and machine failure may result.



-  **Locations that are excessively hot, cold, humid, or dry (near heaters, humidifiers, air conditioners, etc.)**

The paper will become damp and condensation may form inside the machine, causing misfeeds and dirty output.  
 **SPECIFICATIONS** (page 10)  
If the location has an ultrasonic humidifier, use pure water for humidifiers in the humidifier. If tap water is used, minerals and other impurities will be emitted, causing impurities to collect on the inside of the machine and create dirty output.

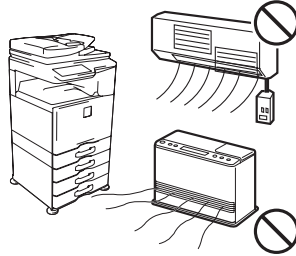

-  **When the machine is installed, the adjusters (4) must be lowered to the floor to secure the machine (prevent it from moving).**

Rotate the adjusters in the locking direction until they are in firm contact with the floor.

**If you find it necessary to reposition the machine due to rearrangement of your office layout or other reason, retract the adjusters from the floor, turn off the power, and then move the machine.**

(After moving the machine, lower the adjusters again to secure the machine.)

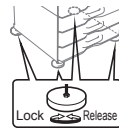

-  **Locations exposed to direct sunlight**

Plastic parts may become deformed and dirty output may result.

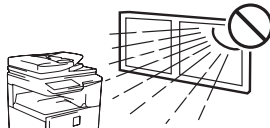

-  **Locations with ammonia gas**

Installing the machine next to a diazo copy machine may cause dirty output.

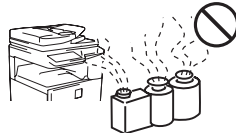

-  **Do not install the machine in a location with poor air circulation.**

A small amount of ozone is created inside the machine during printing. The amount of ozone created is not sufficient to be harmful; however, an unpleasant odor may be noticed during large copy runs, and thus the machine should be installed in a room with a ventilation fan or windows that provide sufficient air circulation. (The odor may occasionally cause headaches.)

\* Install the machine so that people are not directly exposed to exhaust from the machine. If installed near a window, ensure that the machine is not exposed to direct sunlight.

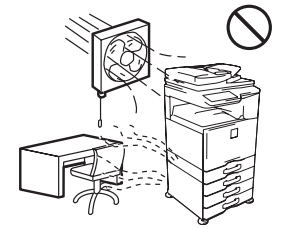

-  **Near a wall**

Be sure to allow the required space around the machine for servicing and proper ventilation. (The machine should be no closer than the distances indicated below from walls. The indicated distances are for the case when a saddle finisher and large capacity paper tray are not installed.)

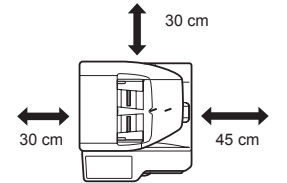

-  **Locations subject to vibration.**

Vibration may cause failure.

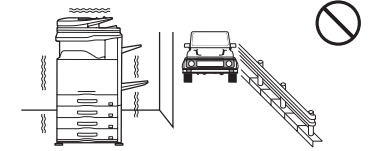

### CAUTION

**The machine includes a built-in hard drive. Do not subject the machine to shock or vibration. In particular, never move the machine while the power is on.**

- The machine should be installed near an accessible power outlet for easy connection.
- Connect the machine to a power outlet which is not used for other electric appliances. If a lighting fixture is connected to the same outlet, the light may flicker.

## About consumables

### CAUTION

-  **Do not throw a toner cartridge into a fire.**

Toner may fly and cause burns.

-  **Store a toner cartridge out of the reach of children.**

# Handling precautions

## WARNING

 **Do not place a container of water or other liquid, or a metal object that might fall inside, on the machine.**  
If the liquid spills or the object falls into the machine, fire or electrical shock may result.



 **Do not remove the machine casing.**  
High-voltage parts inside the machine may cause electrical shock.

 **Do not make any modifications to this machine.**  
Doing so may result in personal injury or damage to the machine.

 **Do not use a flammable spray to clean the machine.**  
If gas from the spray comes in contact with hot electrical components or the fusing unit inside the machine, fire or electrical shock may result.

 **If you notice smoke, a strange odor, or other abnormality, do not use the machine.**  
If used in this condition, fire or electrical shock may result.  
Immediately switch off the main power and remove the power plug from the power outlet.  
Contact your dealer or nearest authorised service representative.



 **If a thunder storm begins, switch off the main power and remove the power plug from the outlet to prevent electrical shock and fire due to lightning.**

 **If a piece of metal or water enters the machine, switch off the main power and remove the power plug from the power outlet.**  
Contact your dealer or nearest authorised service representative. Using the machine in this condition may result in electrical shock or fire.

## CAUTION

 **Do not look directly at the light source.**  
Doing so may damage your eyes.

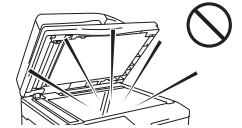

 **Do not block the ventilation ports on the machine. Do not install the machine in a location that will block the ventilation ports.**  
Blocking the ventilation ports will cause heat to build up in the machine, creating a risk of fire.

 **The fusing unit and paper exit area are hot. When removing a misfeed, do not touch the fusing unit and paper exit area. Take care not to burn yourself.**

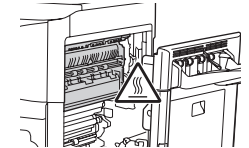

 **When loading paper, removing a misfeed, performing maintenance, closing the front and side covers, and inserting and removing trays, take care that your fingers are not pinched.**

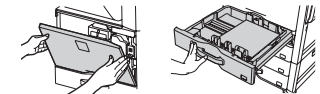

The machine includes the document filing function, which stores document image data on the machine's hard drive. Stored documents can be called up and printed or transmitted as needed. If a hard drive failure occurs, it will no longer be possible to call up the stored document data. To prevent the loss of important documents in the unlikely event of a hard drive failure, keep the originals of important documents or store the original data elsewhere.

With the exception of instances provided for by law, Sharp Corporation bears no responsibility for any damages or loss due to the loss of stored document data.

## Laser information

Wave length	790 nm ± 10 nm
Pulse times	MX-M364N Normal paper mode / Heavy paper mode (P/S = 175 mm/s) = 8.98 µs ± 0.028 µs / 7 mm
	MX-M464N Normal paper mode (P/S = 225 mm/s) = 6.98 µs ± 0.022 µs / 7 mm
	MX-M564N Normal paper mode (P/S = 255 mm/s) = 6.16 µs ± 0.019 µs / 7 mm
	MX-M464N / MX-M564N Heavy paper mode (P/S = 175 mm/s) = 8.98 µs ± 0.028 µs / 7 mm
Output power	Max 1.0 mW (LD1+LD2)

## ■ Caution

Use of controls or adjustments or performance of procedures other than those specified herein may result in hazardous radiation exposure.

This Digital Equipment is CLASS 1 LASER PRODUCT (IEC 60825-1 Edition 2-2007)

## SUPPLIES

Standard supplies for this product that can be replaced by the user include paper, toner cartridges, and staple cartridges for the finisher.

Be sure to use only SHARP-specified products for the toner cartridges, finisher staple cartridge, and transparency film.

**SHARP**

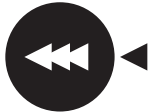

GENUINE SUPPLIES

For best copying results, be sure to use only Sharp Genuine Supplies which are designed, engineered, and tested to maximize the life and performance of Sharp products. Look for the Genuine Supplies label on the toner package.

## Storage of supplies

### ■ Proper storage

1. Store the supplies in a location that is:
  - clean and dry,
  - at a stable temperature,
  - not exposed to direct sunlight.
2. Store paper in the wrapper and lying flat.
3. Paper stored in packages standing up or out of the wrapper may curl or become damp, resulting in paper misfeeds.

### ■ Storing toner cartridges

Store a new toner cartridge box horizontally with the top side up. Do not store a toner cartridge standing on end. If stored standing on end, the toner may not distribute well even after shaking the cartridge vigorously, and will remain inside the cartridge without flowing out.

- Store the toner in a location that is cooler than 40°C (104°F). Storage in a hot location may cause the toner in the cartridge to solidify.
- Please use SHARP-recommended toner cartridges. If toner cartridges other than SHARP-recommended toner cartridges are used, the machine may not attain full quality and performance and there is a risk of damage to the machine.

## ■ Staple cartridge

The finisher and saddle finisher require the following staple cartridge:

MX-SCX1 (for finisher and saddle finisher)

Approx. 5000 per cartridge x 3 cartridges

AR-SC2 (for finisher (large stacker) and saddle stitch finisher (large stacker))

Approx. 5000 per cartridge x 3 cartridges

AR-SC3 (for saddle stitch of saddle stitch finisher and saddle stitch finisher (large stacker))

Approx. 2000 per cartridge x 3 cartridges

## Supply of spare parts and consumables

The supply of spare parts for repair of the machine is guaranteed for at least 7 years following the termination of production. Spare parts are those parts of the machine which may break down within the scope of the ordinary use of the product, whereas those parts which normally exceed the life of the product are not to be considered as spare parts. Consumables too, are available for 7 years following the termination of production.

## SAFETY DATA SHEET

The SDS (Safety Data Sheet) can be viewed at the following URL address:

<http://www.sharp-world.com/corporate/eco/env-info/sds/index.html>

## Noise emission

### Noise emission values

The following shows noise emission values as measured according to ISO7779.

Sound power level  $L_{WA,d}$

	MX-M364N	MX-M464N	MX-M564N
Operating (continuous printing)	7.4 B	7.5 B	7.6 B
Standby mode (Low power level mode)	-	-	-

Sound pressure level  $L_{pA,m}$

		MX-M364N	MX-M464N	MX-M564N
Operating (continuous printing)	Bystander positions	57 dB	58 dB	59 dB
	Standby mode	-	-	-

- Operating: With options MX-DE14, MX-RB22, MX-FN11.
- Standby: "-"=less than background noise.

# PART NAMES

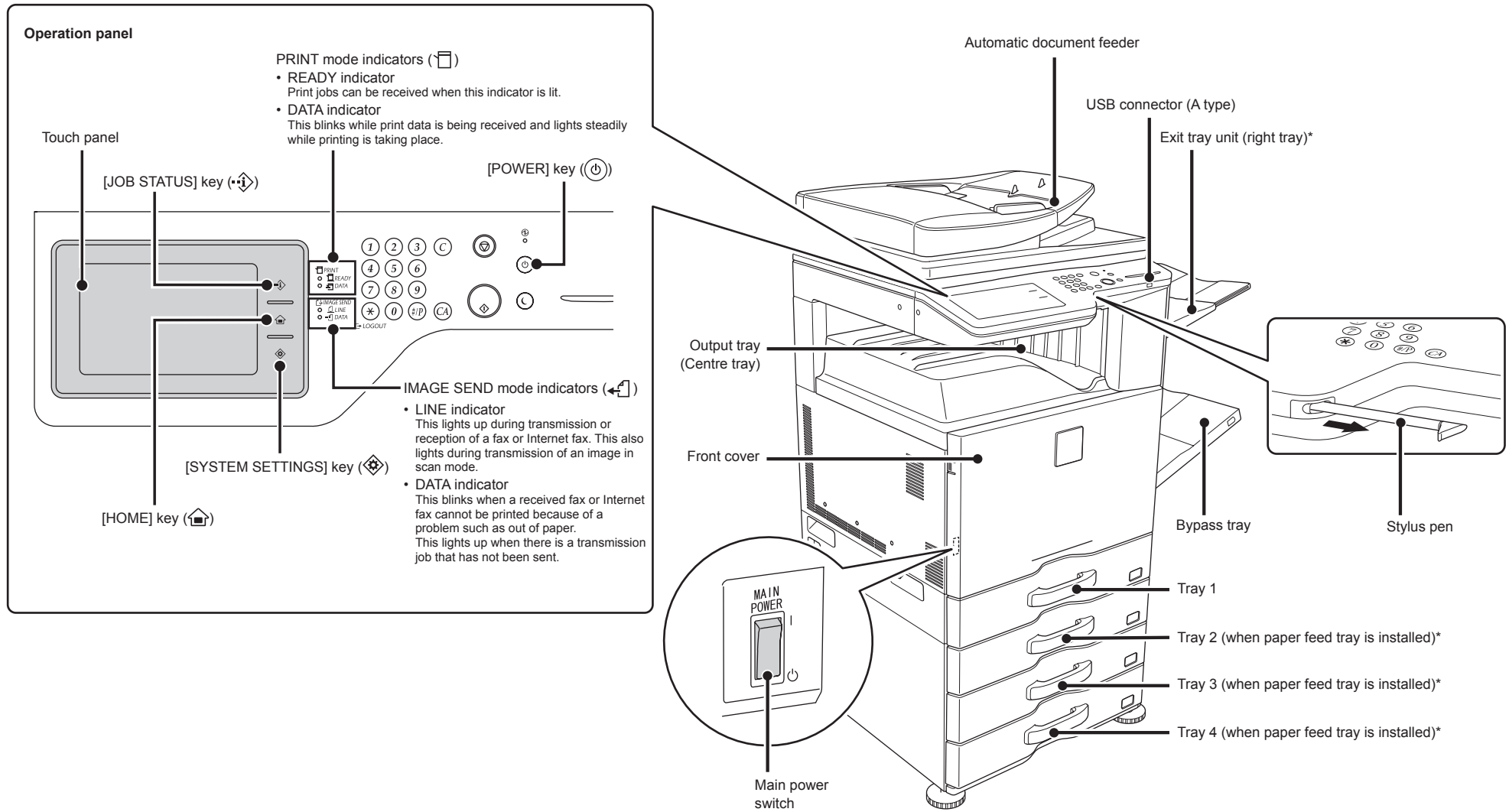

\* Peripheral device.  
For more information, see the operation guide (PDF).

# TURNING THE POWER ON AND OFF

This machine has two power switches. The main power switch is at the bottom left after the front cover is opened. The other power switch is the [POWER] key (⏻) on the operation panel.

## Turning on the power

---

- (1) Switch the main power switch to the “ | ” position.
- (2) Press the [POWER] key (⏻) to turn on the power.

## Turning off the power

---

- (1) Press the [POWER] key (⏻) to turn off the power.
- (2) Switch the main power switch to the “⏻” position.

- If the main power indicator is blinking, press the [POWER] key (⏻) after it becomes steadily lit.
- When turning off the power, make sure that the indicator lights on the operation panel turn off as well.
- In the event of a power failure or other reason that causes the machine to suddenly turn off, turn back on the power of the machine and then proceed to turn off the machine following the correct procedures.  
Switching off the main power switch or removing the power cord from the outlet while any of the indicators are lit or blinking may damage the hard drive and cause data to be lost.
- Switch off both the [POWER] key (⏻) and the main power switch and unplug the power cord if you suspect a machine failure, if there is a bad thunderstorm nearby, or when you are moving the machine.



When using the fax or Internet fax function, always keep the main power switch in the “on” position.

## Restarting the machine

In order for some settings to take effect, the machine must be restarted.

If a message in the touch panel prompts you to restart the machine, press the [POWER] key (⏻) to turn off the power and then press the key again to turn the power back on.



In some states of the machine, pressing the [POWER] key (⏻) to restart will not make the settings take effect. In this case, use the main power switch to switch the power off and then on.

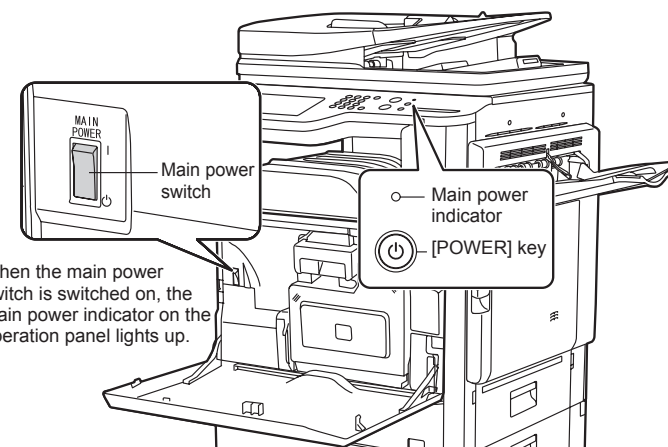



# OPERATION MANUALS AND HOW TO USE THEM

## Operation manuals

The instructions for this manual are separated in the following three sections.

### Before using the machine

#### Start Guide: this manual

This section explains precautions to ensure safe usage, part names and how to switch on/off the power. This section also includes important information for persons that are responsible for the maintenance of this machine.

Read this section before using the machine for the first time.

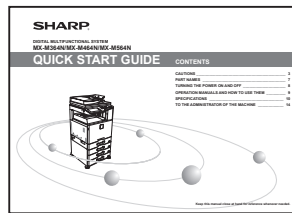

### Printing and faxing from a computer

#### Software Setup Guide (PDF)

This section explains how to install the various drivers needed when using this machine as a printer, network scanner, or fax machine.

Read this section when using this machine from a computer. The Software Setup Guide is on the "Software CD-ROM".

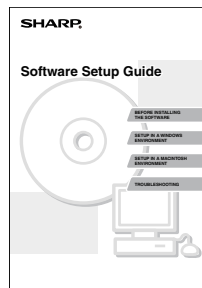

### Directions for use

#### Operation Guide (PDF)

Information on the copier, fax, and other various functions that this machine provides have been compiled into a PDF file called [Operation Guide].

Read the Operation Guide to learn how to use this machine, when you want to know more about its functions, or when you have trouble operating it.

The [Operation Guide] is downloaded from this machine itself.

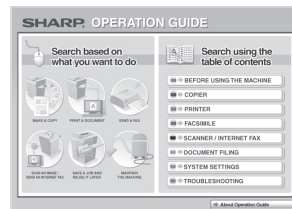

## How to read the Operation Guide

The [Operation Guide] can be downloaded from the machine and viewed on a computer. You can download the [Operation Guide] following the procedures below while the machine is connected to the network.

### 1 Confirm the machine's IP address

First, touch the [SYSTEM SETTINGS] key (⬢) on the operation panel and then touch [List Print (User)] when it appears on the touch panel.

Next, select [NIC Page] from [Printer Test Page] and then touch the [Print] button. Confirm the machine's IP address from the printed list.

### 2 Insert the machine's IP address into the address bar of your web browser to access the machine

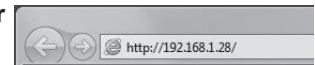

http://machine's IP address/

User verification may be required depending on the machine's settings.

Please check with the machine's administrator to obtain the account information necessary for verification.

### 3 Download the [Operation Guide]

Click [Operation Manual Download] from the page displayed. Next, select a language to download the file in from the [Language] list and then click on the [Download] button.

### 4 Double-click on the downloaded file to display the Operation Guide

To view the manual in PDF format, Acrobat Reader or Adobe Reader of Adobe Systems Incorporated is required. If neither program is installed on your computer, the programs can be downloaded from the following URL: <http://www.adobe.com/>

# SPECIFICATIONS

## Basic Specifications / Copier specifications

Name	MX-M364N/MX-M464N/MX-M564N			
Type	Desktop			
Colour	Monochrome			
Copier system	Laser electrostatic copier			
Scanning resolution	Scan (Document glass): 600 × 600 dpi, 600 × 400 dpi, 600 × 300 dpi			
	Scan (Document Feeder): 600 × 600 dpi, 600 × 400 dpi			
	Print: 600 × 600 dpi, equivalent to 9,600 dpi × 600 dpi			
Gradation	Scan: equivalent to 256 levels / Print: equivalent to 256 levels			
Original paper sizes	Max. A3 (11"×17") / sheets, bound documents			
Copy sizes	A3 wide (12" × 18") to A5R (5-1/2" × 8-1/2"R), Envelopes			
	Tray : A3, B4, A4, A4R, B5, B5R, A5R, 11" × 17", 8-1/2" × 14", 8-1/2" × 13-1/2", 8-1/2" × 13-2/5", 8-1/2" × 13", 8-1/2" × 11", 8-1/2" × 11"R, 7-1/4 × 10-1/2"R, 5-1/2" × 8-1/2"R			
	Multi-bypass tray: A3 wide (12" × 18") to A5R (5-1/2" × 8-1/2"R), Envelopes, Custom			
Paper type	Lost margin (leading edge): 4 mm (11/64") ± 1 mm (± 3/64")			
	Lost margin (trailing edge): 5 mm (13/64") or less			
	Near edge / far edge: total 4 mm (11/64") ± 2 mm (± 6/64") or less			
Warm-up time	Tray: Plain paper, Heavy paper (106 g/m <sup>2</sup> (28 lbs. bond) to 220 g/m <sup>2</sup> (80 lbs. Cover))			
	Multi-bypass tray: Plain paper, Heavy paper, Thin paper, Special paper (Envelopes, Label, Glossy paper, Tab paper, Transparency film)			
First-copy time	12 seconds			
	● This may vary depending on the ambient conditions.			
	MX-M364N	MX-M464N	MX-M564N	
Continuous copying speeds* (when shifter is not in operation)	4.5 seconds	3.9 seconds	3.7 seconds	
	● This may vary depending on the state of the machine.			
	● Portrait feeding of A4 (8-1/2" x 11") sheets.			
Continuous copying speeds* (when shifter is not in operation)	MX-M364N	MX-M464N	MX-M564N	
	A4, B5, 8-1/2" × 11"	36 copies/min.	46 copies/min.	56 copies/min.
	A4R, 8-1/2" × 11"R, B5R, 7-1/4" × 10-1/2"R	25 copies/min.	32 copies/min.	35 copies/min.
Scan speed (copy)	B4, 8-1/2" × 14"	20 copies/min.	26 copies/min.	30 copies/min.
	A3, 11" × 17"	17 copies/min.	22 copies/min.	26 copies/min.
	* Continuous speed for same original source. Output may be temporarily interrupted to stabilize image quality.			

Copy ratios	Same size: 1:1 ± 0.8 %    Enlarge: 115 %, 122 %, 141 %, 200 %, 400 % Reduce: 25 %, 50 %, 70 %, 81 %, 86 %	
	Zoom range: 25 to 400 % (25 - 200 % using RSPF) in 1 % increments, total 376 increments.	
Paper feed / capacity	500 sheets in one tray plus 100-sheet multi-bypass tray ● Using 80 g/m <sup>2</sup> (21 lbs.) weight paper	
Max. paper feed / max. capacity	6,600 sheets in 4 trays (500 × 2 + 1,150 + 850) plus 100-sheet multi-bypass tray plus 3,500 sheets in large capacity tray ● Using 80 g/m <sup>2</sup> (21 lbs.) weight paper	
Continuous copy	Max. 999 copies	
Memory	Standard: 3 GB    HDD: 320 GB	
	● 1 GB = One billion bytes when referring to hard drive capacity. Actual format capacity is less.	
Ambient environment	Operating environment	10 °C (54 °F) to 35 °C (91 °F) (20 % to 85 % RH) 590 - 1,013 hpa
	Standard environment	20 °C (68 °F) to 25 °C (77 °F) (65 ± 5 % RH)
Required power supply	Local voltage ± 10 % (For the power supply requirements, see the name plate in the lower corner of the left side of the machine.) Power consumption Max. 1.84 kW (220-240 V) / 1.44 kW (100-127 V) (including options)	
Dimensions	608 mm (W) × 690 mm (D) × 837 mm (H) (23-15/16" (W) × 27-11/64" (D) × 32-61/64" (H))	
Weight	MX-M364N	MX-M464N / MX-M564N
	Approx. 64 kg (141.1 lbs.)	Approx. 65 kg (143.3 lbs.)
Overall dimensions	With multi-bypass tray extended	922 mm (W) × 690 mm (D) (36-5/16" (W) × 27-11/64" (D))
	With right side exit tray extended	985 mm (W) × 690 mm (D) (38-25/32" (W) × 27-11/64" (D))

## Automatic document feeder

Document feeder types	Reversing Single Pass Feeder (RSPF)	
Original paper sizes	A3 (11" × 17") to A5 (5-1/2" × 8-1/2")	
Original paper types	Paper weight	Thin paper 35 g/m <sup>2</sup> (9 lbs. bond) to 49 g/m <sup>2</sup> (13 lbs. bond) Plain paper 50 g/m <sup>2</sup> (13 lbs. bond) to 128 g/m <sup>2</sup> (34 lbs. bond)
	Two-sided	50 g/m <sup>2</sup> (13 lbs. bond) to 105 g/m <sup>2</sup> (28 lbs. bond)
Paper storage capacity	100 sheets (80 g/m <sup>2</sup> (21 lbs.)) (or maximum stack height of 13 mm (1/2"))	
Scan speed (copy)	56 sheets/minute (600 × 400 dpi) ● When scanning one-sided, A4 (8-1/2" × 11") vertical documents	

## Tray 2 / 3 / 4 / 5

Name	Tray 2 (MX-DE12)*1	Tray 2/3 (MX-DE13)*2	Tray 2/3/4 (MX-DE14)*3	Tray 5 (MX-LC11)*4
Paper sizes	A3 (11" × 17") to A5R (5-1/2" × 8-1/2"R)			A4 (8-1/2" × 11")
Useable paper	60 g/m <sup>2</sup> (16 lbs. bond) to 220 g/m <sup>2</sup> (80 lbs. cover)			60 g/m <sup>2</sup> (16 lbs. bond) to 105 g/m <sup>2</sup> (28 lbs. bond)
Paper capacity	500 sheets	1,000 (500 × 2)	1,500 (500 × 3)	3,500
Dimensions	583 mm (W) × 577 mm (D) × 382 mm (H) (22-61/64" (W) × 22-46/64" (D) × 15-3/64" (H))			376 mm (W) × 523 mm (D) × 575 mm (H) (14-53/64" (W) × 20-19/32" (D) × 22-41/64" (H))
Weight	Approx. 21 kg (46 lbs.)	Approx. 23 kg (51 lbs.)	Approx. 28 kg (62 lbs.)	Approx. 30 kg (66 lbs.)

- \*1: Stand/500 sheet paper drawer (MX-DE12)  
 \*2: Stand/2x500 sheet paper drawer (MX-DE13)  
 \*3: Stand/3x500 sheet paper drawer (MX-DE14)  
 \*4: Large capacity tray (MX-LC11)

## Stand/500&2000 sheet paper drawer (Tray 2 / 3 / 4)

Name	Stand/500&2000 sheet paper drawer (MX-DE20)
Paper sizes	Tray 2: A3 (11" × 17") to A5R (5-1/2" × 8-1/2"R) Tray 3/4: A4 (8-1/2" × 11")
Useable paper	Tray 2: 60 g/m <sup>2</sup> (16 lbs. bond) to 220 g/m <sup>2</sup> (80 lbs. cover) Tray 3/4: 60 g/m <sup>2</sup> (16 lbs. bond) to 105 g/m <sup>2</sup> (28 lbs. bond)
Paper capacity	Tray 2: 500 Tray 3: 1,150 Tray 4: 850
Dimensions	583 mm (W) × 577 mm (D) × 382 mm (H) (22-61/64" (W) × 22-23/32" (D) × 15-3/64" (H))
Weight	Approx. 30 kg (66.2 lbs.)

## Finisher

Name	Finisher (MX-FN17)
Paper sizes	Depends on feeder specifications
Useable paper	55 g/m <sup>2</sup> (13 lbs. bond) to 300 g/m <sup>2</sup> (110 lbs. cover)
Number of trays	1 Tray
Tray capacity (80g/m <sup>2</sup> (21 lbs.))	Non-stapled A3 wide (12" × 18") / A3 (11" × 17") / B4 (8-1/2" × 14"): 250 sheets A4 (8-1/2" × 11") / A4R (8-1/2" × 11"R) / B5 / B5R (7-1/4" × 10-1/2"R) / A5R (5-1/2" × 8-1/2"R): 500 sheets
	Staple function A3 (11" × 17") / B4 (8-1/2" × 14"): 30 units or 250 sheets A4 (8-1/2" × 11") / A4R (8-1/2" × 11"R) / B5: 30 units or 500 sheets ● Offset output is not available for A3 wide (12" × 18") / B5R (7-1/4" × 10-1/2"R) / A5R (5-1/2" × 8-1/2"R).
Max. number of stapled sheets (90g/m <sup>2</sup> (24lbs.))	Max. number of 50 sheets (A4 (8-1/2" × 11"), A4R (8-1/2" × 11"R), B5) Max. number of 30 sheets (A3 (11" × 17"), B4 (8-1/2" × 14"))
Staple position	1 bottom, 1 top, 2 middle

Required power supply	Supplied from this machine
Weight	Approx. 12 kg (26.5 lbs.)
Dimensions	When output paper tray is stored 428 mm (W) × 593 mm (D) × 198mm (H) (16-55/64" (W) × 23-11/32" (D) × 7-51/64" (H))
	When output paper tray is extended 612 mm (W) × 593 mm (D) × 198 mm (H) (24-3/32" (W) × 23-11/32" (D) × 7-51/64" (H))

## Saddle stitch finisher (large stacker)

Name	Saddle Stitch Finisher (large stacker) (MX-FN18)
Paper sizes	Depends on feeder specifications
Useable paper	Paper weight 55 g/m <sup>2</sup> (13 lbs. bond) to 300 g/m <sup>2</sup> (110 lbs. Cover)
No. of trays	2 (Upper tray / Lower tray) + Saddle stitch tray
Tray capacity (80 g/m <sup>2</sup> (21 lbs.))	Upper tray
	Non-stapled A3 wide (12" × 18") / A3 (11" × 17") / B4 (8-1/2" × 14") / A4R (8-1/2" × 11"R) / B5R (7-1/4" × 10-1/2"R): 650 sheets A5R (5-1/2" × 8-1/2"R): A4 (8-1/2" × 11") / B5: 1,550 sheets
	Staple function A4 (8-1/2" × 11") / B5: 100 units or 1,550 sheets A3 (11" × 17") / B4 (8-1/2" × 14") / A4R (8-1/2" × 11"R): 50 units or 650 sheets
	Lower tray
Tray capacity (80 g/m <sup>2</sup> (21 lbs.))	Non-stapled A3 wide (12" × 18") / A3 (11" × 17") / B4 (8-1/2" × 14") / A4R (8-1/2" × 11"R) / B5R (7-1/4" × 10-1/2"R): 650 sheets A4 (8-1/2" × 11") / B5: 2,450 sheets A5R (5-1/2" × 8-1/2"R): 1,700 sheets
	Staple function A4 (8-1/2" × 11") / B5: 100 units or 1,550 sheets A3 (11" × 17") / B4 (8-1/2" × 14") / A4R (8-1/2" × 11"R): 50 units or 650 sheets
Tray capacity (80 g/m <sup>2</sup> (21 lbs.))	Saddle stitch tray 10 units (11 to 15 sheets), 15 units (6 to 10 sheets), 25 units (1 to 5 sheets)
	● Offset output is not available for A3 wide (12" × 18") / B5R (7-1/4" × 10-1/2"R) / A5R (5-1/2" × 8-1/2"R).
Required power supply	Supplied from this machine
Weight	Approx. 73 kg (160.9 lbs.)
Dimensions	When output paper tray is stored 640 mm (W) × 641.5 mm (D) × 1100 mm (H) (24-39/64" (W) × 25-1/4" (D) × 43-19/64" (H))
	When output paper tray is extended 753 mm (W) × 641.5 mm (D) × 1100 mm (H) (29-1/32" (W) × 25-1/4" (D) × 43-19/64" (H))
Max. no. of stapled sheets (90 g/m <sup>2</sup> (24 lbs.))	Max. no. of 50 sheets (A4 (8-1/2" × 11"), B5) Max. no. of 30 sheets (A3 (11" × 17"), B4 (8-1/2" × 14"), A4R (8-1/2" × 11"R))
Staple position	1 bottom, 1 top, 2 middle
Staple method (for saddle stitch)	Centred fold with stapling in 2 centre places
Saddle stitch fold position	Centred fold
Saddle usable sizes	A3 (11" × 17") / B4 (8-1/2" × 14") / A4R (8-1/2" × 11"R) / A3 wide (12" × 18")
Saddle usable paper weight	60 g/m <sup>2</sup> (16 lbs.) to 220 g/m <sup>2</sup> (80 lbs. Cover) Paper weighting 106 g/m <sup>2</sup> (28 lbs.) to 220 g/m <sup>2</sup> (80 lbs. Cover) is only able to be used in cover mode and for single sheet fold.
Max. no. of saddle-stitched sheets	Max. no. of 15 sheets (80 g/m <sup>2</sup> (21 lbs.)):
	14 sheets (80 g/m <sup>2</sup> (21 lbs.)) + 1 sheet (220 g/m <sup>2</sup> (80 lbs. Cover)) Max. no. of 10 sheets (90 g/m <sup>2</sup> (24 lbs.)): 9 sheets (90 g/m <sup>2</sup> (24 lbs.)) + 1 sheet (220 g/m <sup>2</sup> (80 lbs. Cover))

## Saddle stitch finisher

Name	Saddle Stitch Finisher (MX-FN10)	
Paper sizes	Depends on feeder specifications	
Useable paper	Paper weight	55 g/m <sup>2</sup> (13 lbs.) to 300 g/m <sup>2</sup> (110 lbs. Cover)
No. of trays	2 (Upper tray / Lower tray)	
Tray capacity (80 g/m <sup>2</sup> (21 lbs.))	Upper tray	
	Non-stapled	A3 wide (12" × 18") / A3 (11" × 17") / B4 (8-1/2" × 14") / A5R (5-1/2" × 8-1/2"R): 500 sheets A4 (8-1/2" × 11") / A4R (8-1/2" × 11"R) / B5 / B5R (7-1/4" × 10-1/2"R): 1,000 sheets
	Staple function	A3 (11" × 17") / B4 (8-1/2" × 14"): 50 units or 500 sheets A4 (8-1/2" × 11") / A4R (8-1/2" × 11"R) / B5 / B5R: 50 units or 1,000 sheets (For A4 (8-1/2" × 11"), B5, 50 sets only when stapled in a single location on the far side)
	Lower tray	10 units (11 to 15 sheets), 15 units (6 to 10 sheets), 20 units (1 to 5 sheets) ● Offset output is not available for A3 wide (12" × 18") / A5R (5-1/2" × 8-1/2"R).
Required power supply	Supplied from this machine	
Weight	Approx. 40 kg (88.2 lbs.)	
Dimensions	When output paper tray is stored 497 mm (W) × 631 mm (D) × 988 mm (H) (19-9/16" (W) × 24-27/32" (D) × 38-57/64" (H))	
	When output paper tray is extended 656 mm (W) × 631 mm (D) × 988 mm (H) (25-53/64" (W) × 24-27/32" (D) × 38-57/64" (H))	
Max. no. of stapled sheets (90 g/m <sup>2</sup> (24 lbs.))	Max. no. of 50 sheets (A4 (8-1/2" × 11"), A4R (8-1/2" × 11"R), B5, B5R) Max. no. of 25 sheets (A3 (11" × 17"), B4 (8-1/2" × 14"))	
Staple position	1 bottom, 1 top, 2 middle	
Staple method (for saddle stitch)	Centred fold with stapling in 2 centre places	
Saddle stitch fold position	Centred fold	
Saddle usable sizes	A3 (11" × 17") / B4 (8-1/2" × 14") / A4R (8-1/2" × 11"R)	
Saddle usable paper weight	60 g/m <sup>2</sup> (16 lbs.) to 220 g/m <sup>2</sup> (80 lbs. Cover) Paper weighting 106 g/m <sup>2</sup> (28 lbs.) to 220 g/m <sup>2</sup> (80 lbs. Cover) is only able to be used in cover mode and for single sheet fold.	
Max. no. of saddle-stitched sheets	Max. no. of 15 sheets (80 g/m <sup>2</sup> (21 lbs.)):	
	14 sheets (80 g/m <sup>2</sup> (21 lbs.)) + 1 sheet (220 g/m <sup>2</sup> (80 lbs. Cover)) Max. no. of 10 sheets (90 g/m <sup>2</sup> (24 lbs.)): 9 sheets (90 g/m <sup>2</sup> (24 lbs.)) + 1 sheet (220 g/m <sup>2</sup> (80 lbs. Cover))	

## Punch module (for saddle finisher)

Name	Punch module for MX-FN18	Punch module for MX-FN10
	MX-PNX6A, MX-PNX6B, MX-PNX6C, MX-PNX6D	MX-PNX5A, MX-PNX5B, MX-PNX5C, MX-PNX5D
Paper size for punch module	A3 (11" × 17") to A4 (8-1/2" × 11")	
Holes	MX-PNX6A 2 holes, MX-PNX6B 3 holes MX-PNX6C 4 holes, MX-PNX6D 4 holes (wide)	MX-PNX5A 2 holes, MX-PNX5B 3 holes MX-PNX5C 4 holes, MX-PNX5D 4 holes (wide)
Required power supply	Supplied from saddle finisher	
Dimensions	115 mm (W) × 600 mm (D) × 995 mm (H) (4-17/32" (W) × 23-5/8" (D) × 39-11/64" (H))	122 mm (W) × 604 mm (D) × 248 mm (H) (4-13/16" (W) × 23-25/32" (D) × 9-49/64" (H))
Weight	Approx. 8 kg (17.6 lbs.)	Approx. 3.5 kg (7.7 lbs. or less)

## Finisher (large stacker)

Name	Finisher (MX-FN11)	
Paper sizes	Depends on feeder specifications	
Useable paper	Paper weight	55 g/m <sup>2</sup> (13 lbs.) to 300 g/m <sup>2</sup> (110 lbs. Cover)
No. of trays	2 (Upper tray / Lower tray)	
Tray capacity (80g/m <sup>2</sup> (21 lbs. bond))	Upper tray	
	Non-stapled	A3 wide (12" × 18") / A3 (11" × 17") / B4 (8-1/2" × 14") / A4R (8-1/2" × 11"R) / B5R (7-1/4" × 10-1/2"R): 650 sheets A5R (5-1/2" × 8-1/2"R): A4 (8-1/2" × 11") / B5: 1,550 sheets
	Staple function	A4 (8-1/2" × 11") / B5: 100 units or 1,550 sheets A3 (11" × 17") / B4 (8-1/2" × 14") / A4R (8-1/2" × 11"R): 50 units or 650 sheets
	Lower tray	
Non-stapled	A3 wide (12" × 18") / A3 (11" × 17") / B4 (8-1/2" × 14") / A4R (8-1/2" × 11"R) / B5R (7-1/4" × 10-1/2"R): 650 sheets A4 (8-1/2" × 11") / B5: 2,450 sheets A5R (5-1/2" × 8-1/2"R): 1,700 sheets	
	Staple function A4 (8-1/2" × 11") / B5: 100 units or 1,550 sheets A3 (11" × 17") / B4 (8-1/2" × 14") / A4R (8-1/2" × 11"R): 50 units or 650 sheets ● Offset output is not available for A3 wide (12" × 18") / B5R (7-1/4" × 10-1/2"R) / A5R (5-1/2" × 8-1/2"R).	
Required power supply	Supplied from this machine	
Weight	Approx. 45 kg (99 lbs.)	
Dimensions	When output paper tray is stored 515 mm (W) × 645 mm (D) × 1100 mm (H) (20-9/32" (W) × 25-25/64" (D) × 43-19/64" (H))	
	When output paper tray is extended 645 mm (W) × 645 mm (D) × 1100 mm (H) (25-25/64" (W) × 25-25/64" (D) × 43-19/64" (H))	
Max. no. of stapled sheets (90 g/m <sup>2</sup> (24 lbs.))	Max. no. of 50 sheets (A4 (8-1/2" × 11"), B5) Max. no. of 30 sheets (A3 (11" × 17"), B4 (8-1/2" × 14"), A4R (8-1/2" × 11"R))	
Staple position	1 bottom, 1 top, 2 middle	

## Punch module (for finisher)

Name	Punch module for MX-FN17	Punch module for MX-FN11
	MX-PN11A, MX-PN11B, MX-PN11C, MX-PN11D	MX-PNX6A, MX-PNX6B, MX-PNX6C, MX-PNX6D
Paper size for punch module	A3 (11" × 17") to B5R (7-1/4" × 10-1/2"R)	
Holes	MX-PN11A 2 holes, MX-PN11B 3 holes MX-PN11C 4 holes, MX-PN11D 4 holes (wide)	MX-PNX6A 2 holes, MX-PNX6B 3 holes MX-PNX6C 4 holes, MX-PNX6D 4 holes (wide)
Required power supply	Supplied from Finisher	
Dimensions	98 mm (W) × 477 mm (D) × 137 mm (H) (3-55/64" (W) × 18-25/32" (D) × 5-13/32" (H))	115 mm (W) × 600 mm (D) × 995 mm (H) (4-39/64" (W) × 24 (D) × 39-13/16" (H))
Weight	Approx. 3 kg (6.6 lbs.)	Approx. 8 kg (17.6 lbs.)

## Fax Specifications

Name	Facsimile expansion kit (MX-FX11)	
Useable lines	General phone lines (PSTN), automated branch exchange (PBX)	
Connection speed	Super G3: 33.6 kbps, G3: 14.4 kbps	
Coding method	MH, MR, MMR, JBIG	
Connection mode	Super G3 / G3	
Original paper sizes for transmission	A3 (11" × 17") to A5 (5-1/2" × 8-1/2") (Paper with a max. length of 1,000 mm* can be transmitted (one-sided only). * Internet fax (optional) is up to 800 mm (at 600 × 600 dpi).	
Registered paper size	A3 (11" × 17") to A5 (5-1/2" × 8-1/2")	
Transmission time	Approx. 2 seconds * (A4 (8-1/2" × 11") Sharp standard paper, normal characters, Super G3 (JBIG))	
Memory	1GB	
Notes	Touch dial memory	Max. 1,000 entries (Including group dialling for fax, scanner, and Internet fax)
	Group dial	Max. of 500 entries
	Mass transmissions	Max. of 500 recipients

\* Complies with the 33.6 kbps transmission method for Super G3 facsimiles standardized by the International Telecommunications Union (ITU-T). This is the speed for when sending an A4 (8-1/2" × 11") size piece of paper of around 700 characters at standard image quality (8 × 3.85 line/mm) in Hi-speed mode (33.6 kbps). This is the transmission speed for image information only and does not include time for transmission control. The actual time needed for a transmission depends on the content of the text, type of receiving fax machine, and telephone line conditions.

## Network Printer Specifications

Type	Built-in type
Continuous print speed	Same as continuous copy speed
Resolution	Data processing: 600 × 600 dpi Print: 600 × 600 dpi, equivalent to 9600 × 600 dpi
Page description language	Standard: PCL6 emulation Options: PS3 emulation*1, XPS*2
Compatible protocols	TCP/IP (IPv4/IPv6), IPX/SPX, EtherTalk*1
Compatible OS	Windows XP, Windows Server 2003, Windows Vista, Windows Server 2008, Windows 7, Windows 8, Windows Server 2012 Macintosh (Mac OS X 10.4, 10.5, 10.6, 10.7, 10.8)*1
Internal fonts (options)	80 fonts for PCL, 136 fonts for PS3 emulation
Memory	Machine system memory and hard disk.
Interface	10BASE-T/100BASE-TX/1000BASE-T, USB 2.0 (high speed mode)

\*1 When equipped with a PS3 expansion kit (MX-PK11).

\*2 XPS stands for XML Paper Specification. When equipped with the XPS expansion kit (MX-PUX1).

## Network Scanner Specifications

Type	Colour scanner	
Scan resolution (main x vertical)	100 × 100 dpi, 200 × 200 dpi, 300 × 300 dpi, 400 × 400 dpi	
	600 × 600 dpi (push scan) 50 to 9,600 dpi *1 (pull scan)	
Scan speed (A4 (8-1/2" × 11"))	B/W	56 sheets/minute (200 × 200 dpi) (one-sided)
	Colour	56 sheets/minute (200 × 200 dpi) (one-sided)
Interface	● When in standard mode using Sharp standard paper (A4 (8-1/2" × 11") size with 6% coverage) and the auto colour detector is turned off. The speed varies depending on the data volume of the original.	
Compatible protocols	10BASE-T/100BASE-TX/1000BASE-T, USB 2.0 (during USB memory scanning)	
Compatible OS *2	Pull scan (TWAIN)	Windows XP, Windows Server 2003, Windows Vista, Windows Server 2008, Windows 7, Windows 8, Windows Server 2012
Output format	(B/W) TIFF, PDF, PDF/A, encrypted PDF, XPS *3 Compression method: decompression, G3 (MH), G4 (MMR) (Grey scale/colour) TIFF, JPEG, PDF, PDF/A, encrypted PDF, XPS *3 Compression method: JPEG (high, mid, and low compression)	
Driver	TWAIN compliant	

\*1: You must decrease the scan size when increasing the resolution.

\*2: There are cases when a connection cannot be established. Please contact your local dealer for more information.

\*3: XPS is an abbreviation for the XML Paper Specification.

# TO THE ADMINISTRATOR OF THE MACHINE

## System settings password

A password is necessary to change the machine's system settings using administrator authority. System settings can be changed from either the operation panel or using a computer web browser. After setting up the machine, refer to [SYSTEM SETTINGS] in the Operation Guide to set a new password.



The administrator password is interfaced between the operation panel and the website, so passwords changed on the operation panel will be effective when logging in on the website.

## Password for logging in from this machine

The factory default password for the machine is "admin".

## Password for logging in from a computer

There are two accounts that can log in from a web browser: "Administrator" and "User". The factory default passwords for each account are shown on the right side. Signing in as an "Administrator" will allow you to manage all the settings available via web browser.

	Account	Password
User	users	users
Administrator	admin	admin



Please take care not to forget newly set administrator passwords.

## Forwarding all transmitted and received data to the administrator (document administration function)

This function is used to forward all data transmitted and received by the machine to a specified destination (Scan to E-mail address, Scan to FTP destination, Scan to Network Folder destination, or Scan to Desktop destination).

This function can be used by the administrator of the machine to archive all transmitted and received data.

To configure the document administration settings, click [Application Settings] and then [Document Administration Function] in the Web page menu. (Administrator rights are required.)



- The format, exposure, and resolution settings of transmitted and received data remain in effect when the data is forwarded.
- When forwarding is enabled for data sent in fax mode,
  - The [Direct TX] key does not appear in the touch panel.
  - Quick online transmission and dialling using the speaker cannot be used.

## For the users of the fax function

### Important safety instructions

- If any of your telephone equipment is not operating properly, you should immediately remove it from your telephone line, as it may cause harm to the telephone network.
- Never install telephone wiring during a lightning storm.
- Never install telephone socket in wet locations unless the socket is specifically designed for wet locations.
- Never touch uninsulated telephone wires or terminals unless the telephone line has been disconnected at the network interface.
- Use caution when installing or modifying telephone lines.
- Avoid using a telephone (other than a cordless type) during an electrical storm. There may be a remote risk of electric shock from lightning.
- Do not use a telephone to report a gas leak in the vicinity of the leak.
- Do not install or use the machine near water, or when you are wet. Take care not to spill any liquids on the machine.
- Save these instructions.

# INFORMATION ON DISPOSAL

## Information on Disposal for Users (private households)

### ■ In the European Union

Attention: If you want to dispose of this equipment, please do not use the ordinary dust bin! Used electrical and electronic equipment must be treated separately and in accordance with legislation that requires proper treatment, recovery and recycling of used electrical and electronic equipment. Following the implementation by member states, private households within the EU states may return their used electrical and electronic equipment to designated collection facilities free of charge\*. In some countries\* your local retailer may also take back your old product free of charge if you purchase a similar new one.

\*) Please contact your local authority for further details. If your used electrical or electronic equipment has batteries or accumulators, please dispose of these separately beforehand according to local requirements. By disposing of this product correctly you will help ensure that the waste undergoes the necessary treatment, recovery and recycling and thus prevent potential negative effects on the environment and human health which could otherwise arise due to inappropriate waste handling.

### ■ In other Countries outside the EU

If you wish to discard this product, please contact your local authorities and ask for the correct method of disposal. For Switzerland: Used electrical or electronic equipment can be returned free of charge to the dealer, even if you don't purchase a new product. Further collection facilities are listed on the homepage of [www.swico.ch](http://www.swico.ch) or [www.sens.ch](http://www.sens.ch).



Attention: Your product is marked with this symbol. It means that used electrical and electronic products should not be mixed with general household waste. There is a separate collection system for these products.

## Information on Disposal for Business Users

### ■ In the European Union

If the product is used for business purposes and you want to discard it: Please contact your SHARP dealer who will inform you about the take-back of the product. You might be charged for the costs arising from take-back and recycling. Small products (and small amounts) might be taken back by your local collection facilities. For Spain: Please contact the established collection system or your local authority for take-back of your used products.

### ■ In other Countries outside the EU

If you wish to discard of this product, please contact your local authorities and ask for the correct method of disposal.

**SHARP**<sup>®</sup>  
SHARP CORPORATION

PRINTED IN FRANCE  
TINSE5226GHZZ





## Free Manuals Download Website

<http://myh66.com>

<http://usermanuals.us>

<http://www.somanuals.com>

<http://www.4manuals.cc>

<http://www.manual-lib.com>

<http://www.404manual.com>

<http://www.luxmanual.com>

<http://aubethermostatmanual.com>

Golf course search by state

<http://golfingnear.com>

Email search by domain

<http://emailbydomain.com>

Auto manuals search

<http://auto.somanuals.com>

TV manuals search

<http://tv.somanuals.com>