

# SHARP®

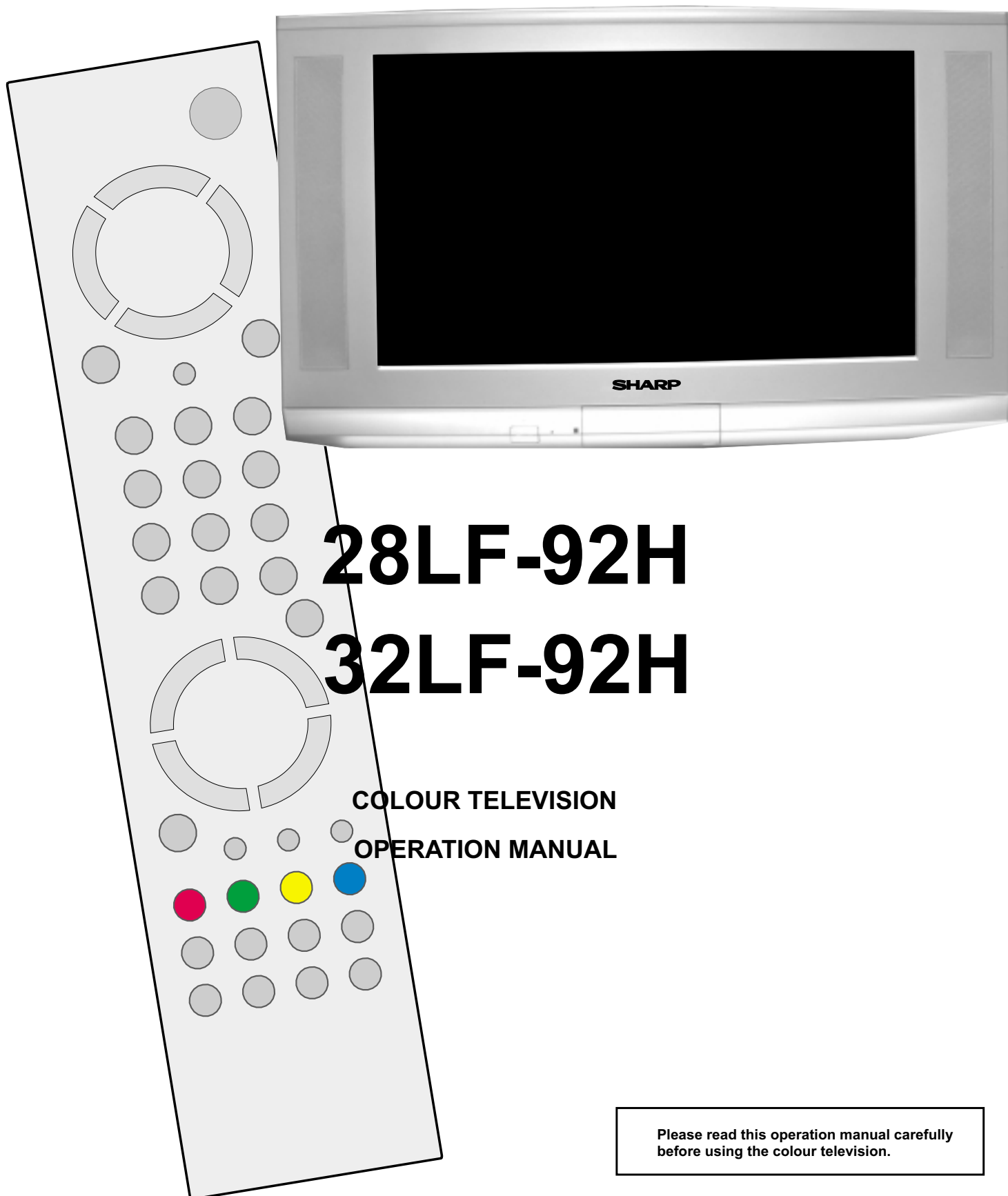

## 28LF-92H

## 32LF-92H

COLOUR TELEVISION  
OPERATION MANUAL

Please read this operation manual carefully  
before using the colour television.

## Contents

<b>Dear SHARP Customer .....</b>	<b>2</b>	<b>Teletext .....</b>	<b>16</b>
<b>Safety Precautions .....</b>	<b>3</b>	To operate Teletext .....	16
<b>Supplied Accessories .....</b>	<b>5</b>	To select a page of Teletext .....	16
<b>Remote Control Buttons .....</b>	<b>6</b>	To Select Index Page .....	16
<b>Control Panel Buttons .....</b>	<b>7</b>	To Select Teletext with a TV Programme .....	16
<b>Antenna Connections .....</b>	<b>7</b>	Searching for a page while watching TV .....	16
<b>Preparation .....</b>	<b>8</b>	To Select Double Height Text .....	16
Features .....	8	To Reveal "concealed" Information .....	16
<b>Before Switching on your TV .....</b>	<b>8</b>	To Stop Automatic Page Change .....	16
Power connection .....	8	To Select a Subcode Page .....	17
Aerial Connections .....	8	Fastext .....	17
How to connect external equipment .....	8	To exit Teletext .....	17
Remote Control Battery Installation .....	8	<b>Connecting external equipment .....</b>	<b>17</b>
<b>Switching the TV ON/OFF .....</b>	<b>8</b>	Via the Euro connector .....	17
To switch the TV on .....	8	RGB mode .....	17
To switch the TV off .....	8	Via the RCA jacks .....	17
<b>Initial Settings .....</b>	<b>9</b>	Via the ANT (aerial) socket .....	17
Operating with the onset buttons .....	9	TV and Video Recoder (VCR) .....	17
Operating with Remote Control .....	9	NTSC Playback .....	17
<b>Menu System .....</b>	<b>9</b>	Copy Facility .....	17
Sound Menu .....	10	To connect to S-VHS input .....	17
Picture Menu .....	11	Connecting Headphones .....	17
Feature Menu .....	13	<b>Connecting external equipment .....</b>	<b>18</b>
INSTALL. (Installation) Menu .....	14	<b>Typical Connections .....</b>	<b>19</b>
Program. (Programming) Menu .....	15	<b>Typical Connections (Continued) .....</b>	<b>20</b>
To start A.P.S (AUTOSTORE) .....	15	<b>Typical Connections (Continued) .....</b>	<b>21</b>
<b>Other Features .....</b>	<b>16</b>	<b>Typical Connections (Continued) .....</b>	<b>22</b>
Sound Mute .....	16	<b>Typical Connections (Continued) .....</b>	<b>23</b>
Stereo / Bilingual .....	16	<b>21-pin Euro-SCART and 21-pin Audio/Video .....</b>	<b>24</b>
Information on Screen .....	16	<b>Troubleshooting .....</b>	<b>25</b>
To Display the Time .....	16	<b>Specifications .....</b>	<b>26</b>
Flash back (↶) .....	16	<b>Important Instructions .....</b>	<b>27</b>

## Dear SHARP Customer

Congratulations! You are now the proud owner of a SHARP Colour Television Receiver. To ensure proper operation, please read this manual carefully. After reading, keep this manual in a safe place for future reference.

### TERMS OF GUARANTEE

Subject to the conditions listed below Sharp Electronics (U.K.) Ltd. (Hereinafter called «the Company») guarantee to provide for the repair of, or at its option replace the Sharp Equipment, or any component thereof, (other than Batteries), which is faulty or below standard, as a result of inferior workmanship or materials.

The conditions of the guarantee are:

1. This guarantee shall only apply to defects or faults which are notified to the Company, or its approved Service Facility within one year from the date of purchase of the equipment.
2. This guarantee covers equipment intended for private domestic use only. This guarantee does not apply to equipment used in the course of a business, trade or profession.
3. This guarantee does not cover any faults or defects caused by accident, misuse, fair wear and tear, neglect, tampering with the equipment, or any attempt at adjustment or repair other than by an approved Service Facility.
4. In the unlikely event of that your equipment should require repair, please contact the dealer or supplier from whom it was purchased.
5. The cost of carriage to and from the Dealer, Supplier or Sharp approved Service Facility shall be borne by the purchaser.
6. No person has any authority to vary the terms or conditions of this guarantee.
7. This guarantee is offered as an additional benefit to the consumer's statutory rights and does not affect rights in any way.

In the unlikely event of this equipment requiring repair during the guarantee period, you will need to provide proof of date of purchase to the repairing company.

Please keep your invoice or receipt, which is supplied at the time of purchase.

## Safety Precautions

This equipment complies with the requirements of Directives 89/336/EEC, 92/31/EEC and 73/23/EEC as amended by 93/68/EEC.

This receiver should only be operated from a **220-240V AC, 50 Hz** outlet. Ensure you select the correct voltage setting for your convenience.

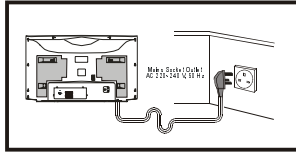

To prevent fire or electrical shock, do not use the TV set in an excessively damp place.



Position the TV set out of direct sunlight and away from heat, as high temperatures can damage the cabinet, CRT, or other electronic parts.

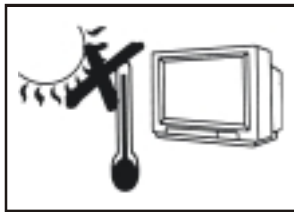

Do not cover ventilation slots with objects such as newspapers, tablecloths, curtains, etc.

Do not cover the ventilation holes at the back of the TV set, this can cause fire or other serious problems. Leave an adequate open space behind the TV set for good ventilation.

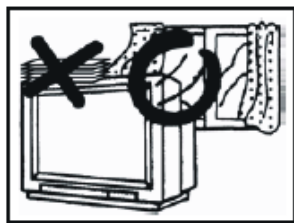

In order to ensure that the television is properly ventilated, leave a space of at least 10 cm around the set.

Do not install this equipment in a confined space such as a bookcase or a built-in cabinet.



Television equipment and cart combination should be moved with care. Quick stops, excessive force, and uneven surfaces may cause the equipment and cart combination to overturn.



To prevent electrical shock, do not subject the AC power cord to damage by bending or twisting it, or by placing heavy items on top of it and do not place the AC power cord under the TV set. If the AC power cord becomes damaged, unplug it from the wall outlet immediately and call your dealer for service.

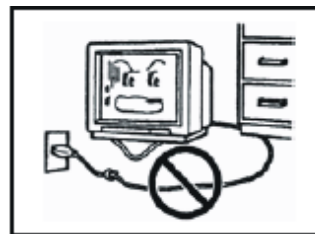

Do not place this television equipment on an unstable cart, stand, or table. The television equipment may fall, causing serious injury to a child or an adult, and serious damage to the equipment.

Use only with a cart or stand recommended by the manufacturer, or sold with the television equipment.

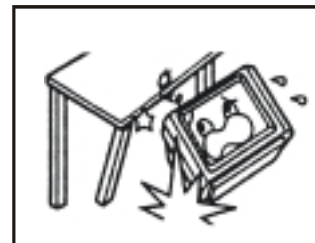

Never remove the back of the cabinet, as there is high voltage in the TV set.

Please call for service.

When replacement parts are required, be sure the service technician has used replacement parts which are specified by the manufacturer or have the same specifications as the original one. Unauthorized substitutions may result in fire, electrical shock, or other hazards.



Unplug the power cord from the wall outlet immediately if the TV set begins to make unusual noises or give off smoke or an odd smell, then call your dealer for service.

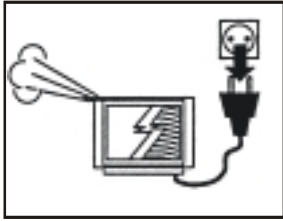

Always disconnect your television from the mains and the aerial cables during thunderstorms.

Even if your television is switched off, it can still be damaged by lightning striking the mains and/or aerial cable.

Do not leave your TV set in Stand-by or operating mode when you leave the house.

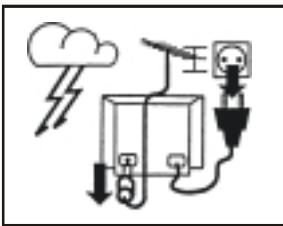

In order to prevent electrical shocks and fires, ensure that the television is not subjected to splashes or spills of water, and avoid inserting objects or pouring any type of liquid into the set.

To prevent fire, never place any type of candle or naked flames on the top or near the TV set.

If an object or liquid enters the set, disconnect the mains supply and contact technical service.

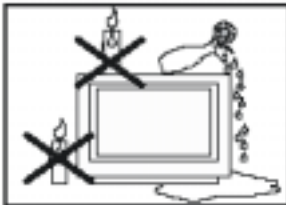

Wall or shelf mounting should follow the manufacturer's instructions, and should use a mounting kit approved by the manufacturer.

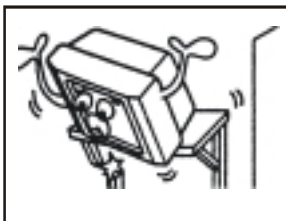

Do place the TV set onto an even stand, table or track which size is bigger than the TV set.

If the TV set is put onto a smaller size or uneven stand, table or track may cause the TV cabinet distort. Do not put or insert anything between TV set and the stand, table or track.



The tube of your TV has a special coating. Do not knock or rub on the tube face with sharp or hard surfaces, otherwise you will damage the coating.

To prevent damaging the surface of the television screen, remove finger prints only with a soft cloth dampened with glass cleaner. Do not use any abrasive cleaners.

Do not use thinner, benzene or other strong chemical cleaners.



#### Warning!

Any intervention contrary to regulations, in particular, any modification of high voltage or a replacement of the picture tube may lead to an increased concentration of x-rays. Any television modified in this way no longer complies with license and must not be operated.

#### Instructions for waste disposal:

Packaging and packaging aids are recyclable and should principally be recycled. Packaging materials, such as foil bag, must be kept away from children. Batteries, including those which are heavy metal-free, should not be disposed of with household waste. Please dispose of used batteries in an environmentally sound manner. Find out about the legal regulations which apply in your area.

**CAUTION:** For environmental and safety reasons, it is recommended that this television set is not left in stand-by mode whilst not in use. Switch it off using the main switch. During periods of absence from home it is also wise to disconnect the set by unplugging the mains plug.

## Supplied Accessories

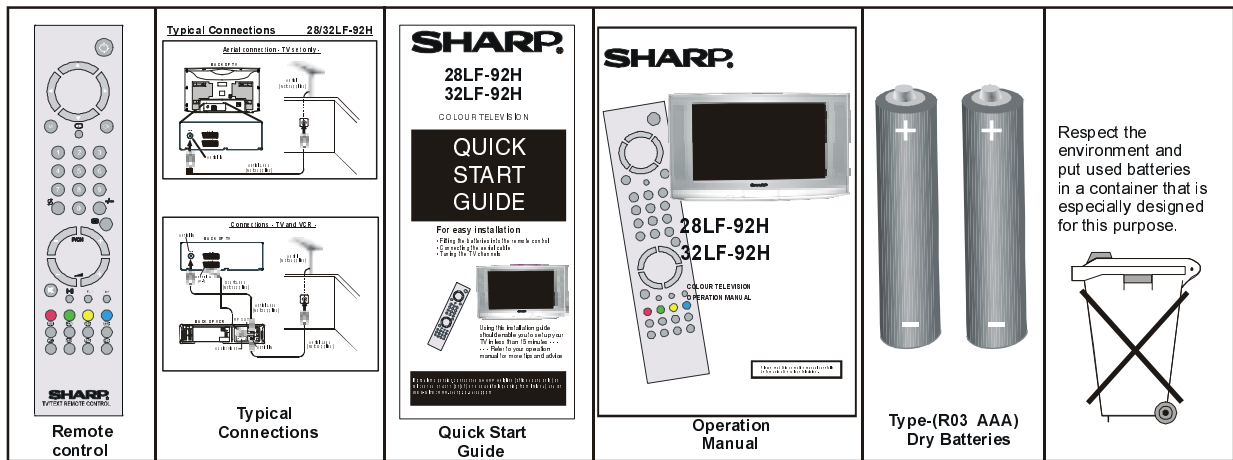

## Remote Control Buttons

- ① = Stand By
- ② = Cursor Up
- ③ = Cursor Right
- ④ = OK
- ⑤ = Info (Program Menu)
- ⑥ **0 - 9** = Direct Program
- ⑦ **-/-** = Double Digit
- ⑧ = Wide mode button
- ⑨ **P/CH+** = Program +
- ⑩ = Volume +
- ⑪ = TV / Quit Menu
- ⑫ = EXT button  
(EXT-1, RGB, EXT-2, F-AV, SVHS)
- ⑬ **Yellow** = Feature Menu
- ⑭ **Blue** = Installation Menu
- ⑮ = Hold
- ⑯ = Update
- ⑰ = Index Page
- ⑱ = Reveal
- ⑲ = Expand
- ⑳ = Mix
- ㉑ = Teletext
- ㉒ = Time
- ㉓ **Red** = Sound Menu
- ㉔ **Green** = Picture Menu
- ㉕ = Mute
- ㉖ **I-II** = Mono/Stereo - Dual I-II
- ㉗ = - Volume
- ㉘ **- P/CH** = -Program
- ㉙ = Flash back button
- ㉚ **M** = Menu
- ㉛ = Cursor Down
- ㉜ = Cursor Left

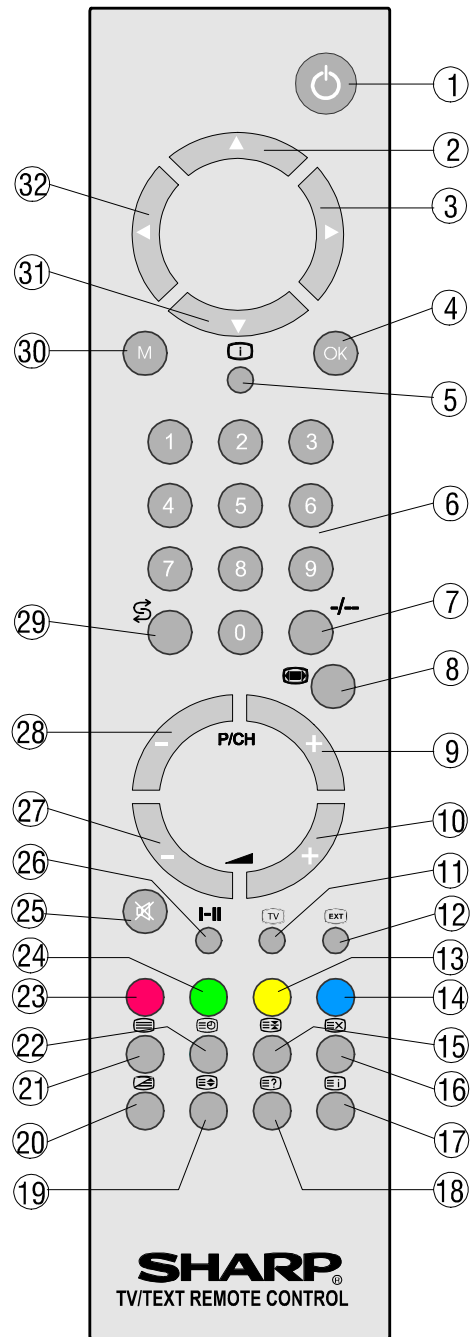

**CAUTION**  
RISK OF ELECTRIC SHOCK



The lightning flash with arrowhead symbol, within an equilateral triangle, is intended to alert the user to the presence of uninsulated "dangerous voltage" within the product's enclosure that may be of sufficient magnitude to constitute a risk of electric shock of persons.

The exclamation point within an equilateral triangle is intended to alert the user to the presence of important operating and maintenance (servicing) instructions in the literature accompanying the appliance.

## Control Panel Buttons

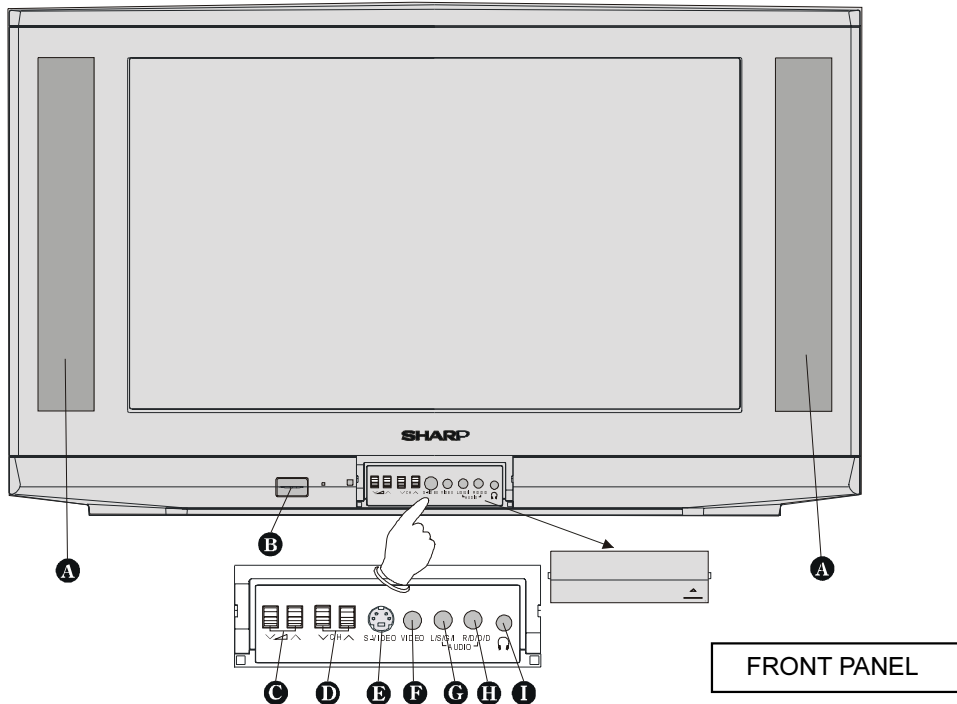

- A** Speakers (left + right)
- B**  $\text{\textcircled{I}}$  = Power On / Off
- C**  $\nabla \blacktriangle$  = Volume -/+
- D**  $\nabla \text{CH} \blacktriangle$  = Program -/+
- E** S-VIDEO

- F** VIDEO
- G** AUDIO L (L/S/G/I) = Audio left
- H** AUDIO R (R/D/D/D) = Audio right
- I**  $\text{\textcircled{H}}$  = Headphone 3,6 mm  $\varnothing$

## Antenna Connections

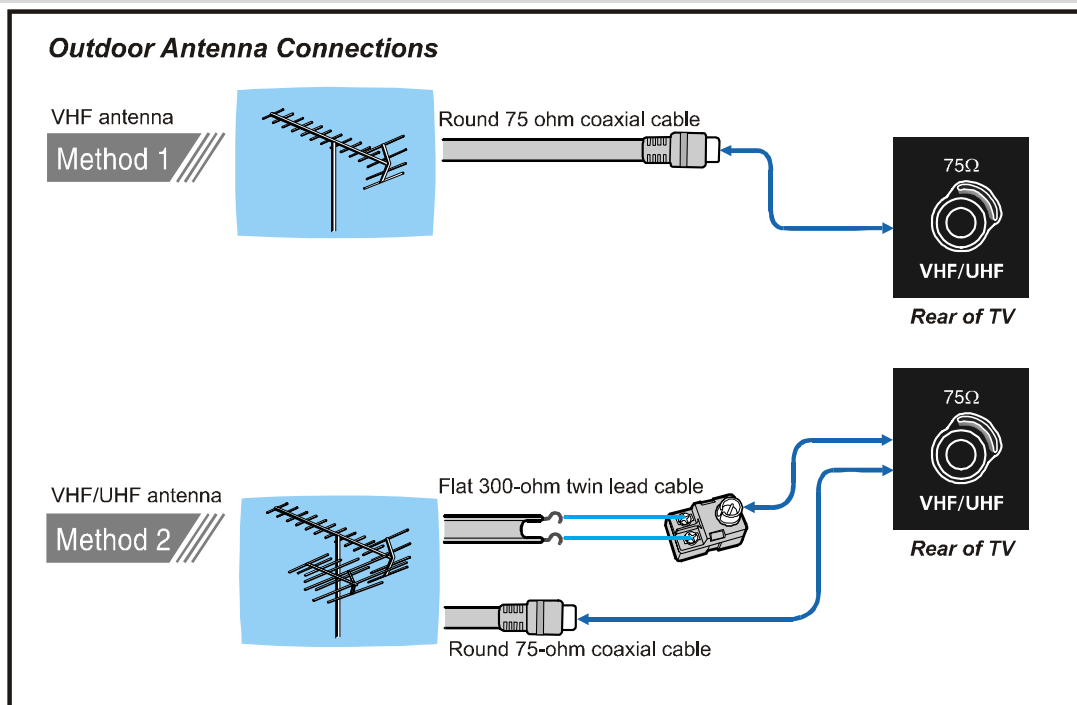



## Preparation

Place TV on a solid surface.

For ventilation, leave a space of at least 10 cm free all around the set. To prevent any fault and unsafe situations, please do not place any objects on top of the set.

**“Use this apparatus in tropical and moderate climates.”**

## Features

- Remote Control Colour Television
- 100 UHF / VHF / Cable channel presets
- Cable Channel Compatible
- Menu Driven functions
- 2 Euro connector Sockets
- Front AV sockets
- Front SVHS connector.
- NICAM Stereo
- Full function teletext (Fastext)
- Headphone socket
- Direct Channel access
- APS (Automatic Programming system) Tuning
- Program custom name feature
- Automatic search tuning
- Sleep Timer
- Child lock
- Blue mute on no video signals
- Audio mute on no video signals
- Auto switch of after 5 mins of no signal
- WSS (wide screen signal decoding)
- NTSC playback

## Before Switching on your TV

### Power connection

**Important:** The TV set is designed to operate on **220 -240V AC, 50 Hz.**

- After unpacking, allow the TV set to reach the ambient room temperature before you connect the set to the mains.

### Aerial Connections

- Connect the aerial plug to the aerial input socket located at the back of the TV.

### How to connect external equipment

See **“Connecting external equipment”** on **page 18.**

- See the instruction manuals provided with the external devices too.

### Remote Control Battery Installation

Before using the TV set for the first time, install the supplied dry batteries in the remote control.

1. With your thumb nail, pull up the slit as indicated by the arrow to remove the battery cover.

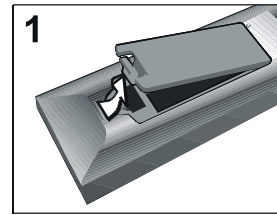

2. Insert two batteries 1.5 V (R03 AAA size). Be sure to match the battery +/- terminals with the +/- marks inside the compartment.

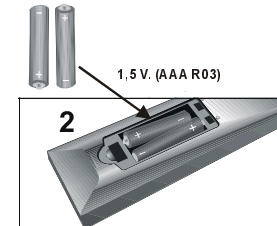

3. Replace the battery cover.

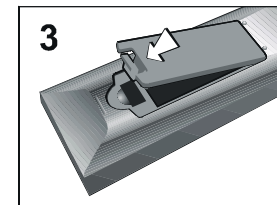

### Notes:

- Remove batteries if weak or if the unit is not in use for long periods.
- Do not mix old and new batteries.
- Incorrect installation of the batteries may damage the remote control.

## Switching the TV ON/OFF

**You can operate your TV either using the remote control handset or directly using the TV onset buttons.**

### To switch the TV on

Your TV will switch on in two steps:

- 1- Press the power button located on the front of the TV. Then the TV switches itself to standby mode and the **RED LED** located below the TV turns on.

- 2- To switch on the TV from stand-by mode either:

Press a digit button on the remote control so that a programme number is selected,

or,

Press Power Button and **“P/CH+”** or **“-P/CH”** buttons on the TV or on the remote control respectively, so the TV will switch on and the **RED** Led will turn **GREEN**.

### To switch the TV off

- Press the stand-by button on the remote control, so the TV will switch to stand-by mode and the **GREEN LED** will become **RED**, or,
- Press the power button located on the front of the TV.

## Initial Settings

The message "PLEASE CHECK ANTENNA CABLE AUTO. PROGRAMMING SYSTEM" will be displayed when you turn on your TV for the first time.

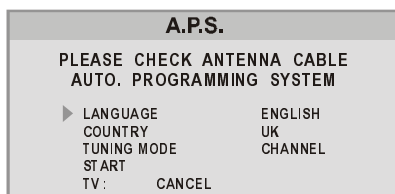

**Note:** If you connect Video Recorder to your TV via antenna input (ANT socket); to tune the VCR channel automatically you must set the VCR in play mode before you start APS.

1- Select **LANGUAGE** with "△" or "▽" button, then press the "◀" or "▶" button to select a menu language.

2- Select **COUNTRY** with "△" or "▽" button, then press the "◀" or "▶" button to select the correct country.

? : OTHER	N : NORWAY
D : GERMANY	SF : FINLAND
A : AUSTRIA	UK : UNITED KINGDOM
CH : SWITZERLAND	NL : NETHERLANDS
I : ITALY	P : PORTUGAL
F : FRANCE	E : SPAIN
B : BELGIUM	TR : TURKEY
DK : DENMARK	EIR : IRELAND
S : SWEDEN	

3- Press the "△" or "▽" buttons to select Tuning Mode. This allows you to choose how you run the APS. If you select Channel Tuning Mode, the APS will run through the channel numbers for your area to locate TV stations. Alternatively if you select Frequency Tuning Mode APS will run through all the frequencies to locate TV stations.

4- Select **START** with "△" or "▽" button, then press the "▶" button to start **A.P.S.**

**A.P.S.**, (Automatic Programming System) automatically programmes the received channels in your TV's programme numbers. During **A.P.S.**, "A.P.S. IS RUNNING PLEASE WAIT" will be displayed. After **A.P.S.** is finalized, the "PROGRAM." menu appears.

To cancel **A.P.S.**, press the "TV" button.

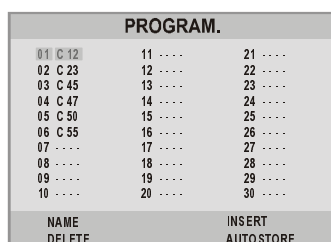
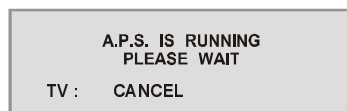

You can delete a channel, insert a channel into a programme number, or re-start **A.P.S.** with the "PROGRAM." menu. For details, see "PROGRAM. (Programming) menu" on page 15.

## Operating with the onset buttons

Volume setting and programme selection can be made using the buttons on the right side of the TV.

### Volume Setting:

• Press "v" button to decrease volume or "v" button to increase volume, so a volume level scale will be displayed on the screen.

### Programme Selecting:

• Press "CH▲" button to select next programme or "vCH" button to select the previous programme.

## Operating with Remote Control

The remote control handset of your TV is designed to control all the functions of the model you selected. The functions will be described in accordance with the menu system of your TV. Functions which you can use out of menu system are described below.

### Volume Setting:

Press "▲+" button to increase volume.

Press "-▲" button to decrease volume.

### Programme Selecting (Previous or next programme):

• Press "-P/CH" button to select the previous programme.  
• Press "P/CH+" button to select the next programme.

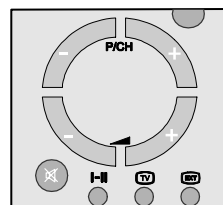

### Programme Selecting (direct access):

Press digit buttons on the remote control handset to select programmes between 0 and 9. TV will switch to the selected program after a short delay.

• For a two digit program number press "-/--" button. Press the first digit and then second digit of the programme channel you want to watch.

## Menu System

Your TV has been designed with a menu system. Display "MENU" (main menu) and enter one of five menus (**SOUND**, **PICTURE**, **FEATURE**, **INSTALL.** and **PROGRAM.**).

1- Press "M" button to display "MENU" (main menu). The menu titles will be displayed in the main menu.

2- Press "△" or "▽" button to select a menu title, then press "◀" or "▶" button to enter the menu.

• To exit a menu, press "TV" button.

• To go to the previous menu, press "M" button.

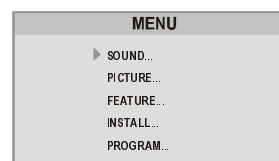

## Sound Menu

### To change sound settings:

- Press “M” button, now you are in main menu. In the main menu, **SOUND** will be the first selected option. Enter the sound menu pressing “◀” or “▶” button.

### Setting Volume:

As you enter the sound menu, Volume will be the first selected option.

- Press “▶” button to increase volume.
- Press “◀” button to decrease volume.

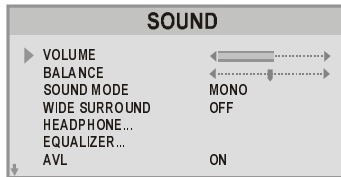

### Setting Balance:

- Using “△” or “▽” button select Balance.
- Press “▶” button to change balance rightward.
- Press “◀” button to change balance leftward.

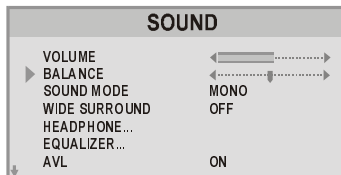

### Selecting Sound Mode

- Using “△” or “▽” button select Mode.
- Press “◀” or “▶” button to change Mode.

You can choose **MONO**, **STEREO** or **DUAL (I-II)** mode, only if the selected channel supports that mode.

You can also change sound mode directly pressing “I-II” button on your remote control.

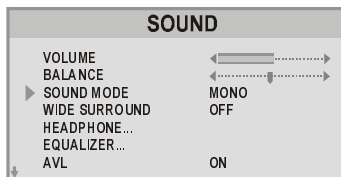

In case of bilingual broadcast (Dual Sound), you can select original or dubbed language using mode option.

### Wide Surround:

The wide surround effect depends on whether the feed is MONO or STEREO.

- If the source feed is MONO, it produces a “Pseudo Stereo” effect.
- If the source feed is STEREO, it produces a “Wide Surround” effect, expanding the stereophonic image.

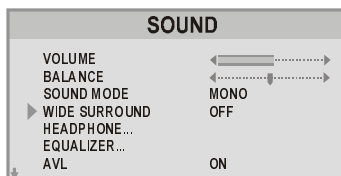

## To Change Headphone Sound Settings:

When you connect headphones you can change the sound settings by entering the headphone menu. To do this, select headphone using “△” or “▽” button then enter headphone menu pressing “◀” or “▶” button.

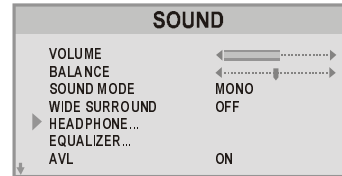

### Setting Headphone Volume:

- As you enter the Headphone sound menu, Volume will be the first selected option.
- Press “▶” button to increase the headphone volume.
- Press “◀” button to decrease the headphone volume.

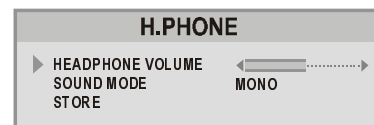

### Setting Headphone Sound Mode:

- Using “△” or “▽” button select Mode.

Pressing “◀” or “▶” button will change the current sound mode. (e.g.: If the current sound mode is stereo, it will be mono or vice versa).

In case of bilingual broadcast, you can select original or dubbed language again using mode menu. So when somebody listens to the original language from the loudspeakers, somebody else can listen to the dubbed language from headphone.

### To Store the Headphone Settings

- Using “△” or “▽” button select Store. Press “◀” or “▶” button to store current headphone volume and sound mode. The stored values will be valid for all the programmes.

### Equalizer

To enter Equalizer sub-menu, select Equalizer using “△” or “▽” button, then enter Equalizer menu pressing “◀” or “▶” button.

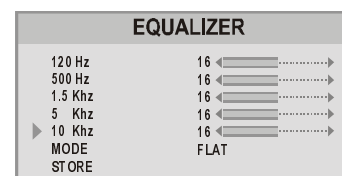
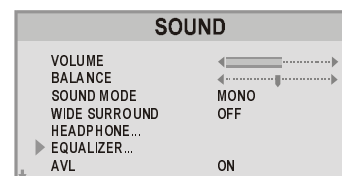

In **Mode** item there are four predefined and one user defined options. These are **Personal**, **Music**, **Speech**, **Jazz** and **Flat**. The predefined options can not be changed by the user. The **Personal** option may be adjusted by the user.

The 5 items below the **Mode** are available to adjust the sound settings in 5 frequency values: 120 Hz, 500 Hz, 1.5 kHz, 5 kHz and 10 kHz. To change the values of 5 frequency options, select one of the options by “△” or “▽” button, and then press “▷” to increase the value, or “◁” to decrease the value.

To store the Equalizer settings, press “◁” or “▷” button on “**Store**” option.

### Setting AVL

Automatic Volume Limiting (AVL) function normalizes sound to obtain fixed output level between programs, having different sound levels. Pressing “◁” or “▷” button will turn **ON** and **OFF** this feature.

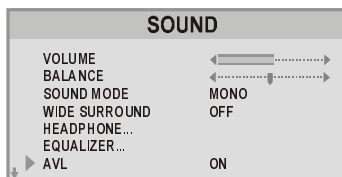

### To Store the Settings

• Press “◁” or “▷” button on “**STORE**” option to store Sound menu settings or press “OK” button.

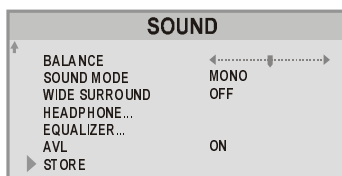

### Auto Store:

Last volume level is stored automatically.

### Picture Menu

#### To change picture settings:

• Press “M” button, now you are in main menu. In the main menu, select **PICTURE** using “△” or “▽” button, then enter the picture menu pressing “◁” or “▷” button.



**Note:** When Picture Mode is not “**MANUAL**”, BRIGHTNESS, CONTRAST and COLOUR options can not be reached by “△” or “▽” buttons.

### Factory Settings:

In the picture menu press the flashback (⏮) button to revert to the original factory settings.

### Setting Brightness:

You can change the Brightness setting only when manual picture mode is selected.

- Using “△” or “▽” button select Brightness.
- Press “▷” button to increase Brightness.

• Press “◁” button to decrease Brightness.

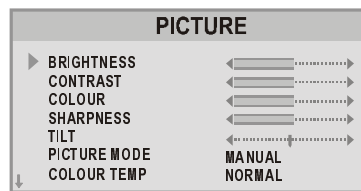

### Setting Contrast:

You can change the Contrast setting only when manual picture mode is selected.

- Using “△” or “▽” button select Contrast.
- Press “▷” button to increase Contrast level.
- Press “◁” button to decrease Contrast level.

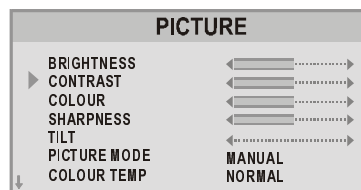

### Setting Colour:

You can change the Colour setting only when manual picture mode is selected.

- Using “△” or “▽” button select Colour.
- Press “▷” button to increase Colour level.
- Press “◁” button to decrease Colour level.

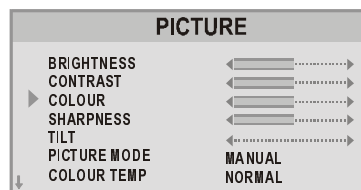

### Setting Sharpness:

- Using “△” or “▽” button select Sharpness.
- Press “▷” button to increase Sharpness level.
- Press “◁” button to decrease Sharpness level.

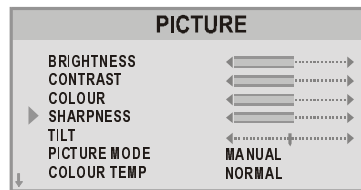

### Setting Tilt

- Using “△” or “▽” button select Tilt.
- Press “▷” button to increase Tilt level.
- Press “◁” button to decrease Tilt level.

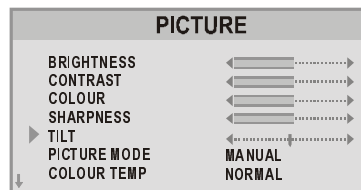

### Setting Hue (In AV mode only) :

- Using “△” or “▽” button select Hue.
- Press “▷” button to increase Hue level.
- Press “◁” button to decrease Hue level.

Hue adjust is functional only when NTSC 3.58/4.43 is applied in AV mode. It does not appear when other colour systems used.

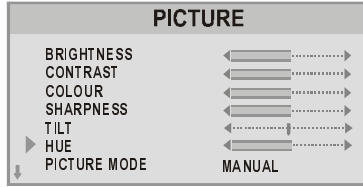

### Picture Mode

This item is used to change the picture mode. By pressing “◁” or “▷” button you may choose one of these options: **BRIGHT, STANDARD, SOFT, MANUAL.**

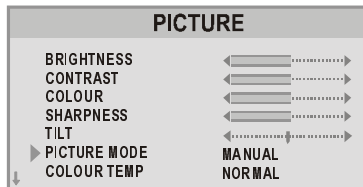

### Colour Temp

- Using “△” or “▽” button select Colour Temp.

This item is used to change the Colour Temperature. By pressing “◁” or “▷” button you may choose one of these options: **COOL, WARM, NORMAL.**

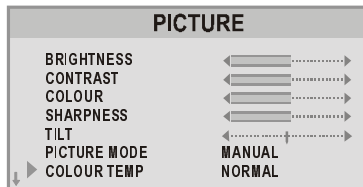



### Wide Mode :

- Using “△” or “▽” button select Wide Mode.

With this item you can select the width of the picture. By pressing “◁” or “▷” button you may choose one of these options : **AUTO, NORMAL, ZOOM 14:9, CINEMA, 16:9ZOOM S** or **FULL.**

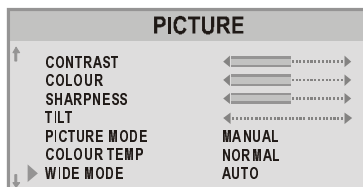
Wide mode can be set by “” wide mode button also.



Each time you press the wide mode button “”, the width of the picture changes as indicated:

AUTO\* → NORMAL → ZOOM 14:9 → CINEMA → 16:9ZOOM S → FULL

When you select ZOOM 14:9 or CINEMA, you can change the vertical scroll by pressing “△” / “▽”.

\* **Auto mode (VPS code):** The VPS signal is sent by some broadcasting stations with information of the original size.

When the TV is in **AUTO** mode and receives the VPS signal, it changes the size automatically as indicated below:

When the TV is receiving **VPS code 16:9** the TV selects **CINEMA** automatically.

When the TV is receiving **VPS code 14:9** the TV selects **ZOOM 14:9** automatically.

When the TV is receiving **VPS code 4:3** the TV selects **NORMAL** automatically.

When the TV does **NOT receive** VPS code the TV selects **FULL** automatically.

**External source:** When you are watching the TV set through the Euro-SCART AV-1 terminal and it receives information of **16:9 format** (through the audio-video control pin) the TV selects **FULL** automatically.

### Wide Mode (Special detail information)

Special detail information about FULL, NORMAL, ZOOM 14:9, CINEMA (16:9) and 16:9ZOOM S.

#### FULL

With Full Mode you adapt the picture 16:9 format while also stretching the centre of view. This is an advantage, for example, when watching sports games where there is no real fixed centre of the picture.

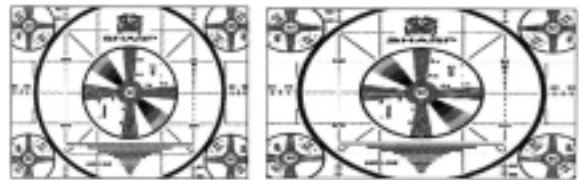

#### NORMAL

You can watch 4:3 programs in 4:3 format by switching to **NORMAL** Mode function.

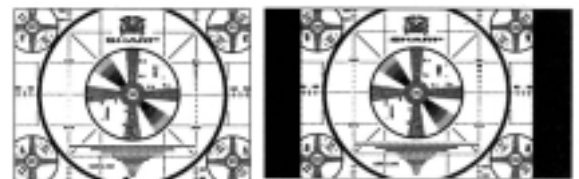

#### ZOOM 14:9

Adapts the 14:9 broadcast cinema movies to the 14:9 Mode.

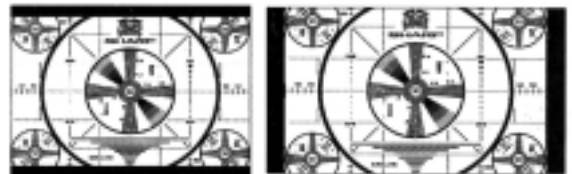

## CINEMA (16:9)

Adapts the 16:9 broadcast cinema movies to the 16:9 Mode, thereby getting rid of the black borders.

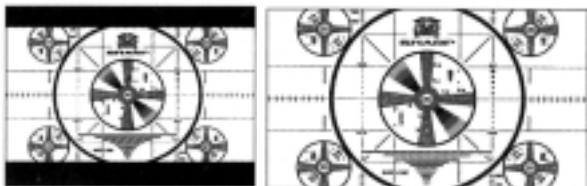

## 16:9ZOOM S

Adapts up to the wide picture (16:9 aspect ratio) with subtitle to the full screen.



### Adjusting the visible area of the picture:

If subtitles or the top (or bottom) of the picture are cut off, you can adjust the visible area of the picture manually.

1. Press Wide mode  button once.

The **WIDE MODE** indicator appears. The **WIDE MODE** will not be changed.

2. While it is displayed, press “ $\Delta$ ” or “ $\nabla$ ” to change the position of the picture.



• You cannot adjust the visible area in **NORMAL** or **FULL** mode.

### To Store the Settings

- Press “ $\leftarrow$ ” or “ $\rightarrow$ ” button on “**STORE**” option to store Picture menu settings or press “OK” button.

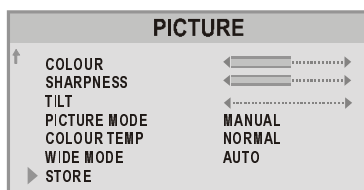

### Auto Store:

Wide mode is stored automatically.

### Feature Menu

- Press “M” button, now you are in main menu. In the main menu, select **FEATURE**, using “ $\Delta$ ” or “ $\nabla$ ” button. Then enter the feature menu pressing “ $\leftarrow$ ” or “ $\rightarrow$ ” button.

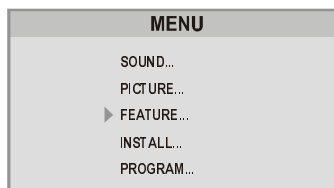

## Sleep Timer

The sleep timer is used to turn the TV off after a defined period. Press “ $\leftarrow$ ” or “ $\rightarrow$ ” button to choose a period of time after selecting this item. The timer can be programmed between Off and 120 minutes in steps of 10 minutes. (**OFF, 010, 020, 030, 040, .....**, 120.)

If sleep timer is activated, at the end of the selected the time, the TV goes automatically to stand-by mode.

FEATURE	
▶ SLEEP TIMER	OFF
CHILD LOCK	OFF
LANGUAGE	ENGLISH
EXT-2 OUTPUT	TV
BLUE BACKGROUND	ON

### Child lock:

You can disable the control panel buttons (except the POWER button) with this item.

Press “ $\leftarrow$ ” or “ $\rightarrow$ ” button to change the setting to On or Off after selecting this item.

When you set this item to On, the TV can be operated only by using the remote control handset.

FEATURE	
SLEEP TIMER	OFF
▶ CHILD LOCK	OFF
LANGUAGE	ENGLISH
EXT-2 OUTPUT	TV
BLUE BACKGROUND	ON

### Language:

Menu Language can be selected by pressing “ $\leftarrow$ ” or “ $\rightarrow$ ” button on **Language** item.

FEATURE	
SLEEP TIMER	OFF
CHILD LOCK	OFF
▶ LANGUAGE	ENGLISH
EXT-2 OUTPUT	TV
BLUE BACKGROUND	ON

### Setting External Source Output

- You can use this menu to select the internal or external source that will be output at **EXT-2** terminal.
- In the “**Feature**” menu select “**EXT-2 Output**” using “ $\Delta$ ” or “ $\nabla$ ” button. Then select the source you want to be output at **EXT.2** pressing “ $\leftarrow$ ” or “ $\rightarrow$ ” button (one of the sources: **TV, EXT-1, F-AV**).

FEATURE	
SLEEP TIMER	OFF
CHILD LOCK	OFF
LANGUAGE	ENGLISH
▶ EXT-2 OUTPUT	TV
BLUE BACKGROUND	ON

### Blue Background During No-Signal

The **Blue Background** feature can be set by “ $\leftarrow$ ” or “ $\rightarrow$ ” button to either **On** or **Off**.

FEATURE	
SLEEP TIMER	OFF
CHILD LOCK	OFF
LANGUAGE	ENGLISH
EXT-2 OUTPUT	TV
▶ BLUE BACKGROUND	ON

## INSTALL. (Installation) Menu

You can store a channel manually, or modify the current settings of a channel (for example, fine-tuning a channel).

You can also change the colour system.

- Press "**M**" button to display the main menu.
- Press " $\Delta$ " or " $\nabla$ " button to select "**INSTALL.**" item. Then " $\triangleleft$ " or " $\triangleright$ " button to display the "**INSTALL.**" menu.

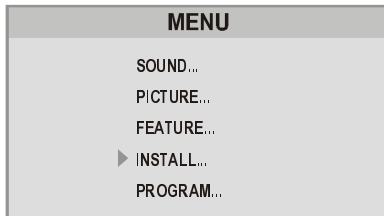

### Note:

- If you want to modify the current settings of a channel, select the channel of which you want to modify the setting. Then display the main menu on screen.
  - In AV mode, you can change only the "**COLOUR SYSTEM**" item.
1. **PROGRAMME** is the first selected item as you enter the **INSTALL.** menu. Press the " $\triangleleft$ " or " $\triangleright$ " button to select the programme number where you want the tuned channel to be stored. (You may also type the programme number using the digit buttons)

### Note:

- Do not use the **PROGRAMME** item when you want to modify the current programme number setting as this may cause other programmes to be changed that are in the existing programme number.
2. Press " $\Delta$ " or " $\nabla$ " button to select Tuning Mode. By pressing " $\triangleleft$ " or " $\triangleright$ " button, you can select the mode in which you want the search to be made, "**Channel Search**" mode or "**Frequency Search**" mode.
    - When you select "**Channel Search**" ("**Channel**" will be displayed in the menu.), the display of the **INSTALL.**(Installation) Menu will be as below:

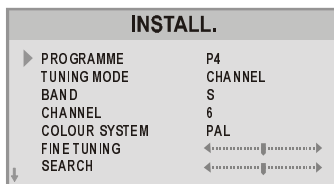

3. Press " $\Delta$ " or " $\nabla$ " button to select **BAND**. Using " $\triangleleft$ " or " $\triangleright$ " button to select the band in which you want to search a channel.
4. Press " $\Delta$ " or " $\nabla$ " button to select **SEARCH**. Press " $\triangleleft$ " or " $\triangleright$ " button to start searching. (Press " $\triangleright$ " button to search forward. Press " $\triangleleft$ " to search backwards.)
  - If the found channel is not the desired one, press " $\triangleleft$ " or " $\triangleright$ " button to start searching again.
  - To stop searching before a channel is found, press the reverse direction button. For example, when the TV is searching forward with " $\triangleright$ " button, press " $\triangleleft$ " button to stop searching.
  - If you know the channel number which you want to find, you can find the channel directly. Follow the step 5 to select the correct standard, then press " $\Delta$ " or " $\nabla$ " to

select **CHANNEL** again, and press " $\triangleleft$ " or " $\triangleright$ " button to select the channel number, or enter the number with the digit buttons.

5. If the picture is not clear or no colour appears, change the colour system to display the picture normally. Press " $\Delta$ " or " $\nabla$ " button to select **COLOUR SYSTEM**, then press " $\triangleleft$ " or " $\triangleright$ " button to choose the correct one.
  - In TV mode: **PAL / SECAM**
  - In AV mode: **AUTO / PAL / SECAM / NTSC 3.58 / NTSC 4.43**
6. If the channel reception is poor, fine-tune the channel. Press " $\Delta$ " or " $\nabla$ " to select **FINE TUNING**, then press " $\triangleleft$ " or " $\triangleright$ " button to fine-tune the channel.
7. After the all settings are completed, store the new channel's setting to the programme number which you selected. Press " $\Delta$ " or " $\nabla$ " to select **STORE**, then press " $\triangleleft$ " or " $\triangleright$ " button to store it.

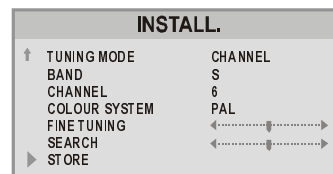

8. When you select "Frequency Search", the display of the Tuning menu will be as below:

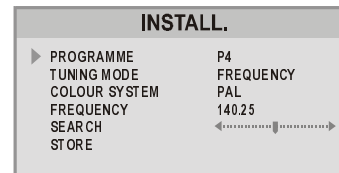

- As "**Frequency Search**" is selected, TV will search according to the channel frequencies.
- With the " $\Delta$ " or " $\nabla$ " button, select **Search**. Search can be made either forward, pressing " $\triangleright$ " button or backwards, pressing " $\triangleleft$ " button.
- The search will be done with steps of 0.25MHz. in each step.
- If the tuned station is not the desired one, you can continue searching pressing " $\triangleleft$ " or " $\triangleright$ " button again.
- When the desired station is tuned, select **STORE** using " $\Delta$ " or " $\nabla$ " button and store it to the programme number you selected pressing " $\triangleleft$ " or " $\triangleright$ " button or press "OK" button.
- Now as you had selected the Frequency Search, the tuning mode of the program is stored as Frequency Search Mode.

### Direct Frequency Access

- If you know the broadcast band and the channel frequency of the station you want to tune, you do not need to make search; select Frequency, using " $\Delta$ " or " $\nabla$ " button in the Frequency Mode Tuning Menu. You can type the first 3 digits of the frequency using the digit buttons, and then you can select the decimal part of the frequency by using " $\triangleleft$ " or " $\triangleright$ " buttons with 250kHz steps. For example if you want to tune the station at frequency 224.25 MHz; first you can directly type 224. The bar at bottom of the menu will show 224.00. Then by increasing or decreasing with 0.25 MHz steps using " $\triangleleft$ " or " $\triangleright$ " buttons, you can select the 224.25MHz. When you type and select the frequency, the corresponding station will be displayed.

- To store the station to the programme number selected, select STORE option using “△” or “▽” button and then press “◀” or “▶” button or press “OK” button.
  - Now as you had selected the Frequency Search, the tuning mode of the program is stored as Frequency Search Mode.
- Note :** Channel Search Tuning Mode uses a channel table. The channels and stations at the table may vary from table to table and from country to country. Each channel has an exact frequency on the table.
- Frequency Search Tuning Mode does not use a channel table and it is slower than Channel Search Tuning Mode.
  - Channel Search Tuning Mode is recommended for the countries which uses standard channel table.
  - Frequency Search Tuning Mode recommended for the countries which uses non-standard channel table.

### Program. (Programming) Menu

You can use the Program. (Programming) menu to delete a channel, to change the programme number of a channel, to give a channel name to a channel, and to start the **A.P.S (AUTOSTORE)** function.

- Press “M” button to display the main menu.
- Press “△” or “▽” button to select “PROGRAM.” item, then “◀” or “▶” button to display the “PROGRAM.” menu.

PROGRAM.		
01 C 12	11 ----	21 ----
02 C 23	12 ----	22 ----
03 C 45	13 ----	23 ----
04 C 47	14 ----	24 ----
05 C 50	15 ----	25 ----
06 C 55	16 ----	26 ----
07 ----	17 ----	27 ----
08 ----	18 ----	28 ----
09 ----	19 ----	29 ----
10 ----	20 ----	30 ----
NAME DELETE	INSERT AUTOSTORE	

#### To choose a channel in the PROGRAM. menu:

- Press “△” / “▽” / “◀” / “▶” button. The programme number that you choose is high-lighted in the **PROGRAM.** menu and you can view the picture of that channel.

#### Caution:

Using the **DELETE** or **INSERT** function it is possible to rewrite the current channel list in the **PROGRAM** menu. This can cause other channels to be changed if they were formerly in locations affected by this function.

#### To give a channel name (NAME):

1. Choose the channel you want to give a channel name.
2. Press the RED button to enter the NAME mode.
3. Press “◀” or “▶” button to choose the position, and press “△” or “▽” button to choose each character of channel name.
4. Press the RED button to store the channel name.
  - To cancel the NAME mode, press the BLUE button.

#### To delete a channel (DELETE):

1. Choose the channel you want to delete.
2. Press the YELLOW button to enter the DELETE mode.
3. Press the YELLOW button to delete it.
  - To cancel this DELETE mode, press the BLUE button.

#### To change the programme number of a channel (INSERT):

1. Choose the channel you want to change the programme number.
2. Press the GREEN button to enter the INSERT mode.
3. Press “△” / “▽” / “◀” / “▶” button to choose new programme number.
4. Press the GREEN button to insert the channel to the chosen programme number.
  - To cancel this INSERT mode, press the BLUE button.

#### To start A.P.S (AUTOSTORE)

**A.P.S.** automatically programmes the received channels in your TV's programme numbers.

1. Press the **BLUE** button to enter the **AUTOSTORE** mode. A warning message appears.

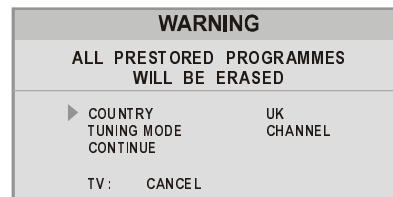

- To cancel the **AUTOSTORE** mode, press the “TV” button.
2. Press “△” or “▽” button to choose the “**COUNTRY**”, then press “◀” or “▶” button the choose country you are now located.
  3. By pressing the up and down buttons, come to the Tuning Mode item and select the mode at which your TV will run the APS.
  4. Press “△” or “▽” button to choose the “**CONTINUE**”, then press “▶” button to start **A.P.S.** The following message appears.

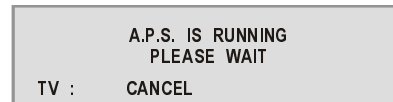

- To cancel the **A.P.S.**, press the “TV” button.
5. After **A.P.S.** is finalized, the **PROGRAM.** menu appears again.



## Other Features

### Sound Mute

To cut off the sound from the TV press "M" button. To restore the sound press the "M" button again or use the "▲ + " or "▼ - " buttons, in this case the volume will start from minimum setting.

### Stereo / Bilingual

- If the TV channel you are watching broadcasts in two languages (e.g. Eurosport), you can select the dubbed or the original language, pressing the "I-II" button.
- When the stereo broadcast is received poorly, you can change from stereo to mono sound so that you can hear the broadcast more clearly and easily.

### Information on Screen

First pressing the "TV" button displays the current status "Programme number", "Station name" and "Sound mode".

### To Display the Time

- While watching a TV programme with Teletext transmission press "E@) button. The current time information, captured from Teletext will be displayed at the upper right corner of the screen.
- If the programme being watched does not have Teletext transmission, no time information will be displayed.
- The time information will disappear after pressing "E@) button again.

### Flash back (S)

This button is used to return to the previous viewed preset. By pressing the "S" button repeatedly it is possible to toggle between two presets.

## Teletext

Teletext is an information system that displays text on your TV screen. Using the Teletext information system you can view a page of information on a subject that is available in the list of contents (index).

No on screen display will be available in text mode.

No contrast, brightness or colour control, but volume control is available in text mode.

### To operate Teletext

- Select a TV station on which Teletext is being transmitted.
- Press (TELETEXT) "E@) button. Usually the list of contents (index) is displayed on the screen.

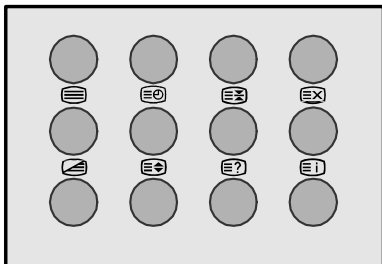

### To select a page of Teletext

- Press the appropriate digit buttons for the required Teletext page number.

The selected page number is displayed at the top left corner of the screen. The Teletext page counter searches until the selected page number is located, so that the desired page is displayed on the screen.

- Press "▲" button to move the Teletext screen forward one page at a time.
- Press "▼" button to move the Teletext screen backward one page at a time.

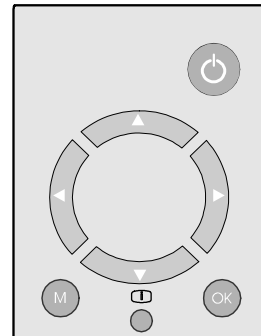

### To Select Index Page

- To select the page number of the index (generally page 100), press "Ei" button.

### To Select Teletext with a TV Programme

- Press "E@) button. The text is now superimposed over the programme on the screen.
- Press "E@) button again to return to the Teletext page.

### Searching for a page while watching TV

- To search for a specific page whilst viewing the TV picture, whilst viewing teletext enter the desired Page number, then press the "E@) button will restore the TV picture. Once the desired page is found the Header of this page will appear on the screen. Press the "E@) button to view the full page.

### To Select Double Height Text

- Press "E@) button for the top half of the information page to be displayed in double height text.
- Press "E@) button again for the bottom half of the information page to be displayed in double height text.
- Press "E@) button once more for the full page of normal height text.

### To Reveal "concealed" Information

- Pressing "E?" button once will reveal answers on a quiz or games page.
- Pressing "E?" button again will conceal the revealed answers.

### To Stop Automatic Page Change

The teletext page you have selected may contain more information than can be displayed on one screen, in such cases the page will update periodically.

- Press “**EXT**” button to stop the automatic page change.
- Press “**EXT**” button again to allow the next page to be displayed.

### To Select a Subcode Page

Subcode pages are subsections of long Teletext pages that can only be displayed on the screen one section at a time.

- Select the required Teletext page.
- Press “**EXT**” button.
- Select the required subcode page number by pressing four digit buttons (e.g. 0001).
- If the selected subcode page is not displayed in a short time, press “**EXT**” button. TV programme will be displayed on the screen.
- Teletext page number will be displayed on the upper left corner of the screen when the selected page is found.
- Press “**EXT**” button to display the selected Teletext page.

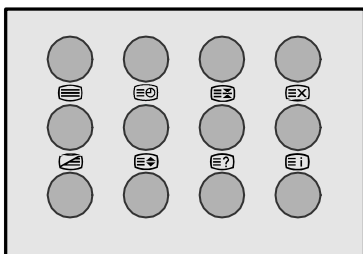

### Fastext

Teletext mode will be selected according to transmission automatically.

Your TV supports the 7 page Teletext system. When the page number of any of the 7 pages in memory is entered, the system will not search for the requested page; instead it will display the page automatically.

- Press “**Δ**” button to move the Teletext screen forward one page at a time.
- Press “**▽**” button to move the Teletext screen backward one page at a time.

### For Fastext

The subject-heading for the information may have a particular colour or can be in a form located in a coloured box.

- Press an appropriate **RED**, **GREEN**, **YELLOW** or **BLUE** button in order to reach the relevant page quickly.

### To exit Teletext

- Press “**TV**” button. The screen will switch to TV mode.

## Connecting external equipment

### Via the Euro connector

Your TV set has two euro connector sockets. If you wish to connect external equipment (e.g. video recorder, decoder, etc.) which have Euro connectors, to your TV, use the **EXT.1 (EXT-1)** or **EXT.2 (EXT-2)** terminals.

If an external device is connected via Euro connector sockets the TV will be switched to AV mode automatically.

### RGB mode

If a piece of equipment outputs **RGB** signals use the **EXT-1** Euro connector as this is **RGB** ready.

### Via the RCA jacks

If you have an equipment (such as a Camcorder) which has the RCA jacks, connect it to the **Front AV (F-AV)** terminal with the video and audio cables.

- If the equipment has the mono audio jack, connect it to the **AUDIO-L** jack.

### Via the ANT (aerial) socket

If your equipment does not have an Euroconnector or RCA jacks, connect it to the TV with an aerial cable. For details, see the manual provided with the equipment.

- To store the test signal that comes from the equipment, see “**INSTALL. Menu**” on **page 14** and store it to the programme number 0. You can watch images from that equipment to select the programme number which you stored the test signal.

### TV and Video Recorder (VCR)

- Connect the Video Recorder to the ANT (antenna input) socket of the TV with the aerial cable.
- Connect the Video Recorder to the **EXT.1** or **EXT.2** terminal with the SCART cable, or connect it to the **Front AV (F-AV)** terminal with the audio and video cables.

### NTSC Playback

Connect a NTSC video recorder to a terminal. Then press “**EXT**” button to select the corresponding AV mode.

**NTSC 3.58/4.43** system is detected automatically in AV mode.

### Copy Facility

You can output the video and audio signals which inputs from **TV** or **EXT.1 (EXT-1)** terminal to the video recorder connected to the **EXT.2 (EXT-2)** terminal.

- To select the output source, see “**Setting External Source Output**” on **page 13**.

### To connect to S-VHS input

Connect your camera or camcorder at the front or back side of your TV.

- Connect your equipment to the TV via S-VHS input and audio inputs of F-AV inputs by using S-VHS cables.

### Connecting Headphones

Use the stereo headphone socket of your TV, to connect headphones.

## Connecting external equipment

### Before connecting anything

- Switch off all equipment.
- Read the manuals provided with the equipments.

### To select an AV mode

Pressing "**EXT**" button on the remote control selects one of AV modes (**EXT-1**, **RGB**, **EXT-2**, **F-AV**, **SVHS**)

- To return to the **TV** mode, repeatedly press "**EXT**" button.

**EXT.1 (EXT-1) terminal:** Euroconnector (21-pin, SCART)

- Video input, Audio L/R inputs and RGB inputs are available.
- TV broadcast outputs (Video and Audio L/R) are available.

**EXT.2 (EXT-2) terminal:** Euroconnector (21-pin, SCART)

- Video input and Audio L/R inputs are available.
- Video and Audio L/R outputs are available. (see "**Setting External Source Output**" on page 13.)

**Front AV (F-AV) terminal:** RCA connectors x 3 and S-VIDEO (Y/C) connector

- Video input and Audio L/R inputs are available.
- S-VIDEO input is available.

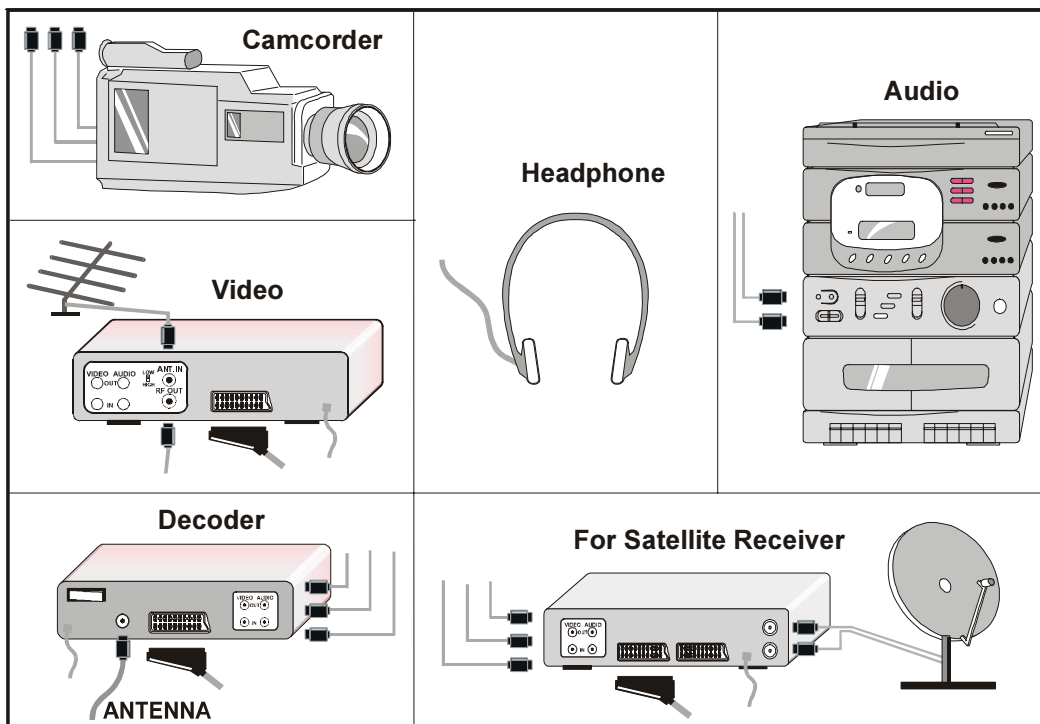
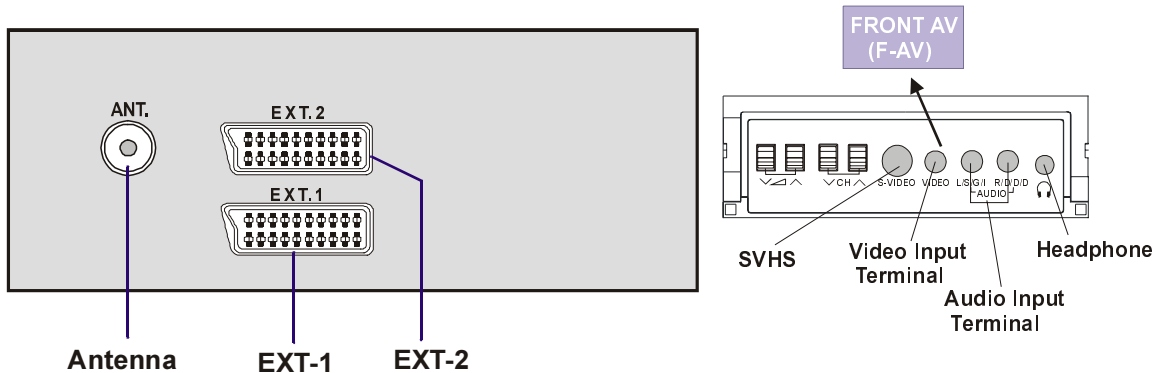

## Typical Connections

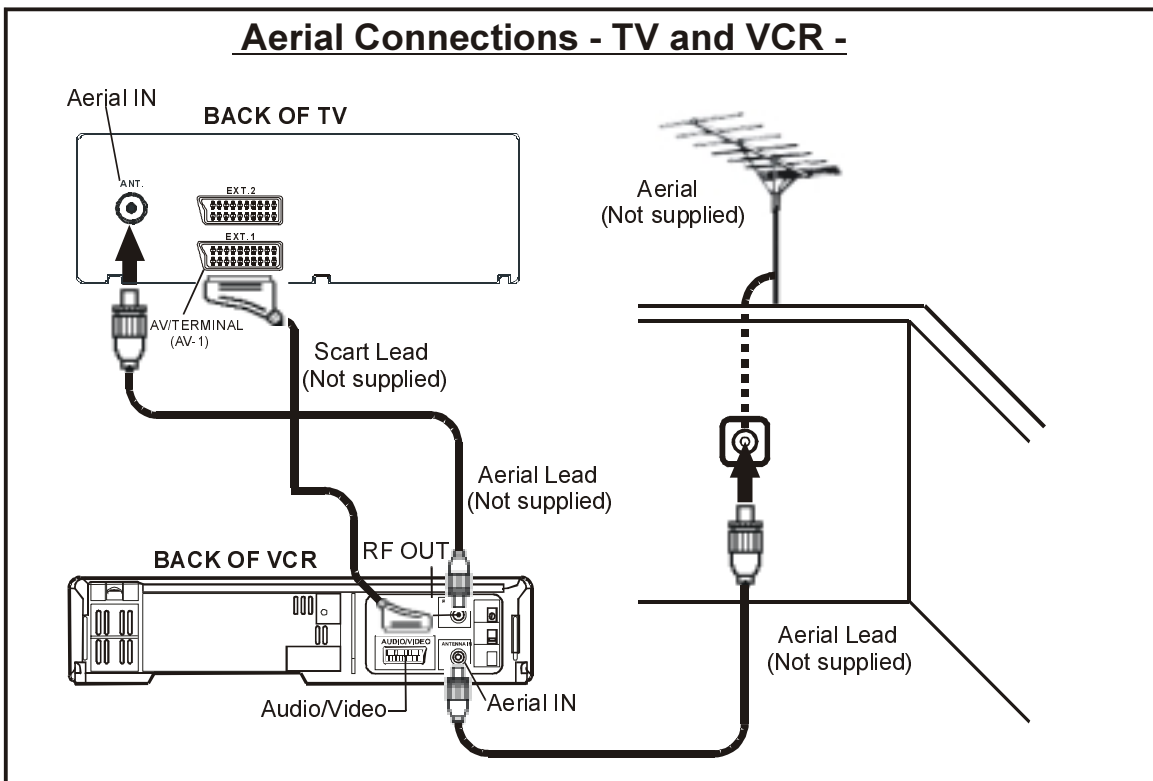
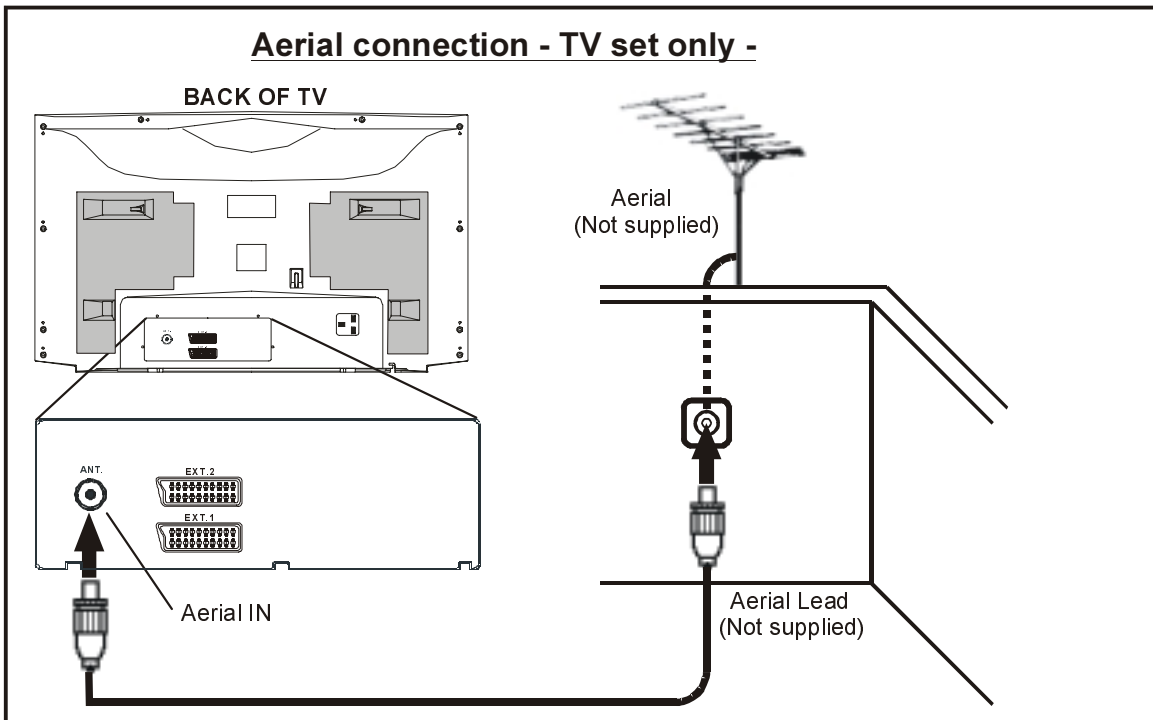

**Note:** For further details, please refer to operation manual of your VCR.

## Typical Connections (Continued)

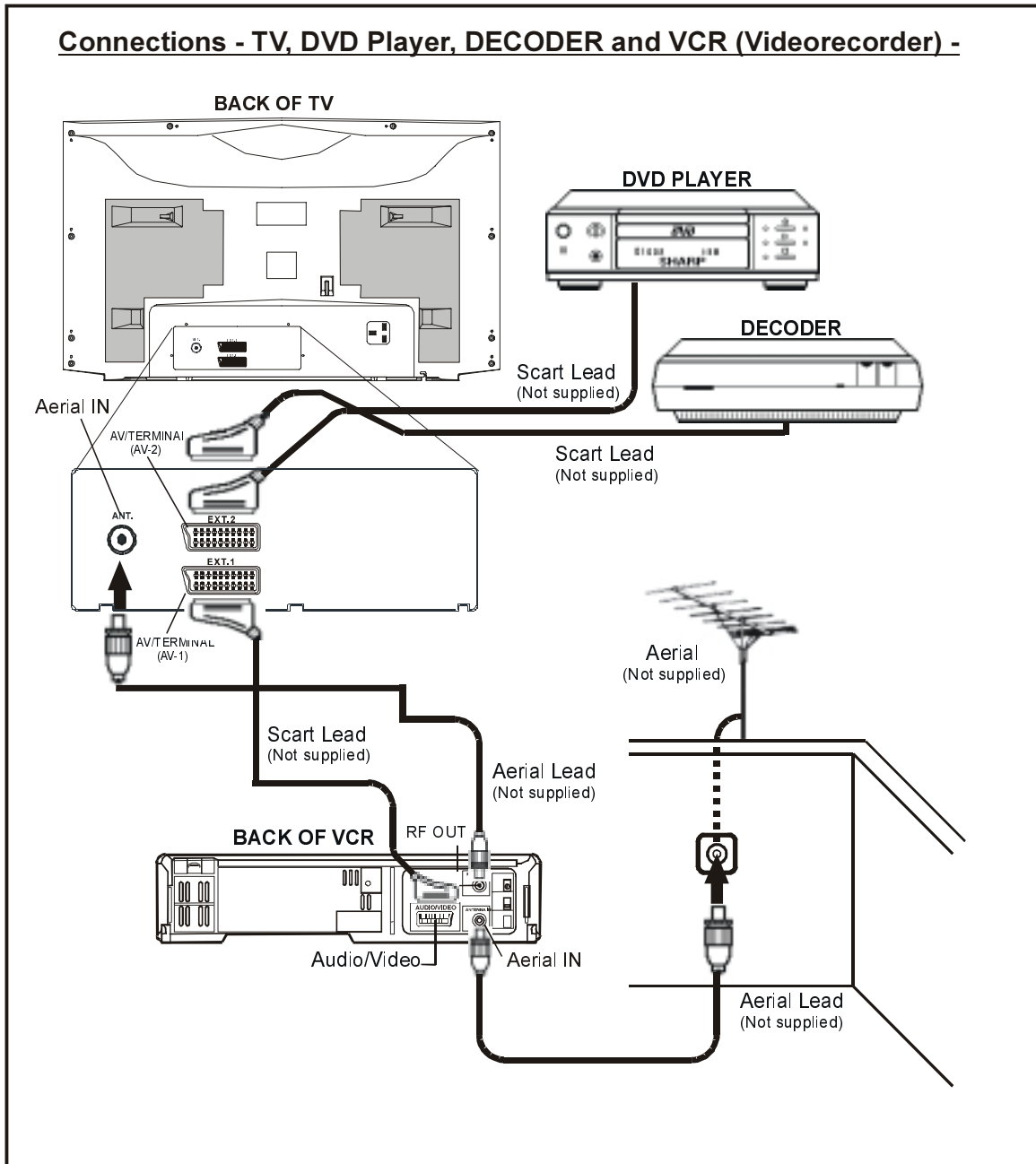

**Note:** For further details, please refer to operation manuals of your DVD Player, DECODER and VCR.

## Typical Connections (Continued)

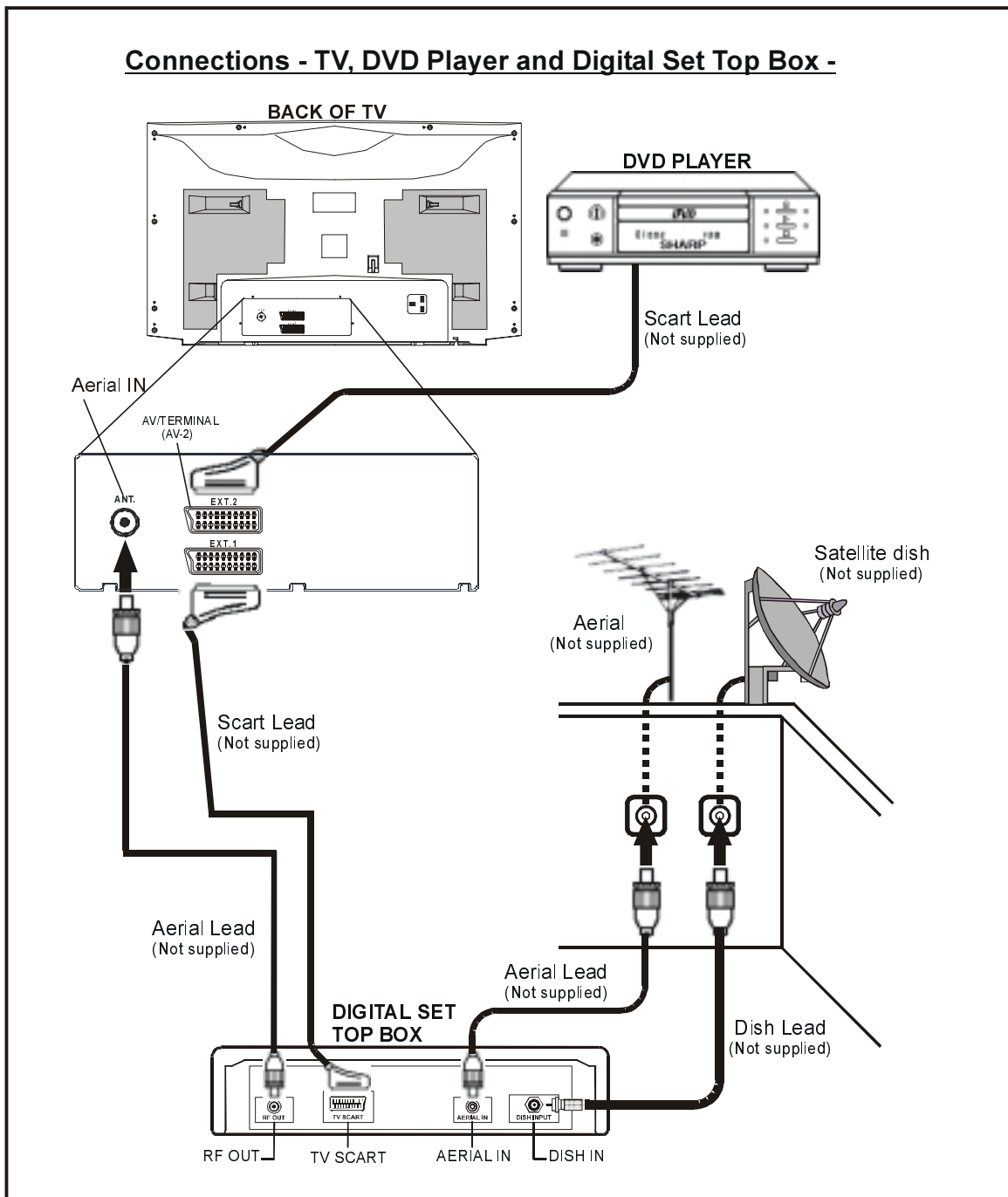

**Note:** For further details, please refer to operation manuals of your DVD Player and Digital Set Top Box.

## Typical Connections (Continued)

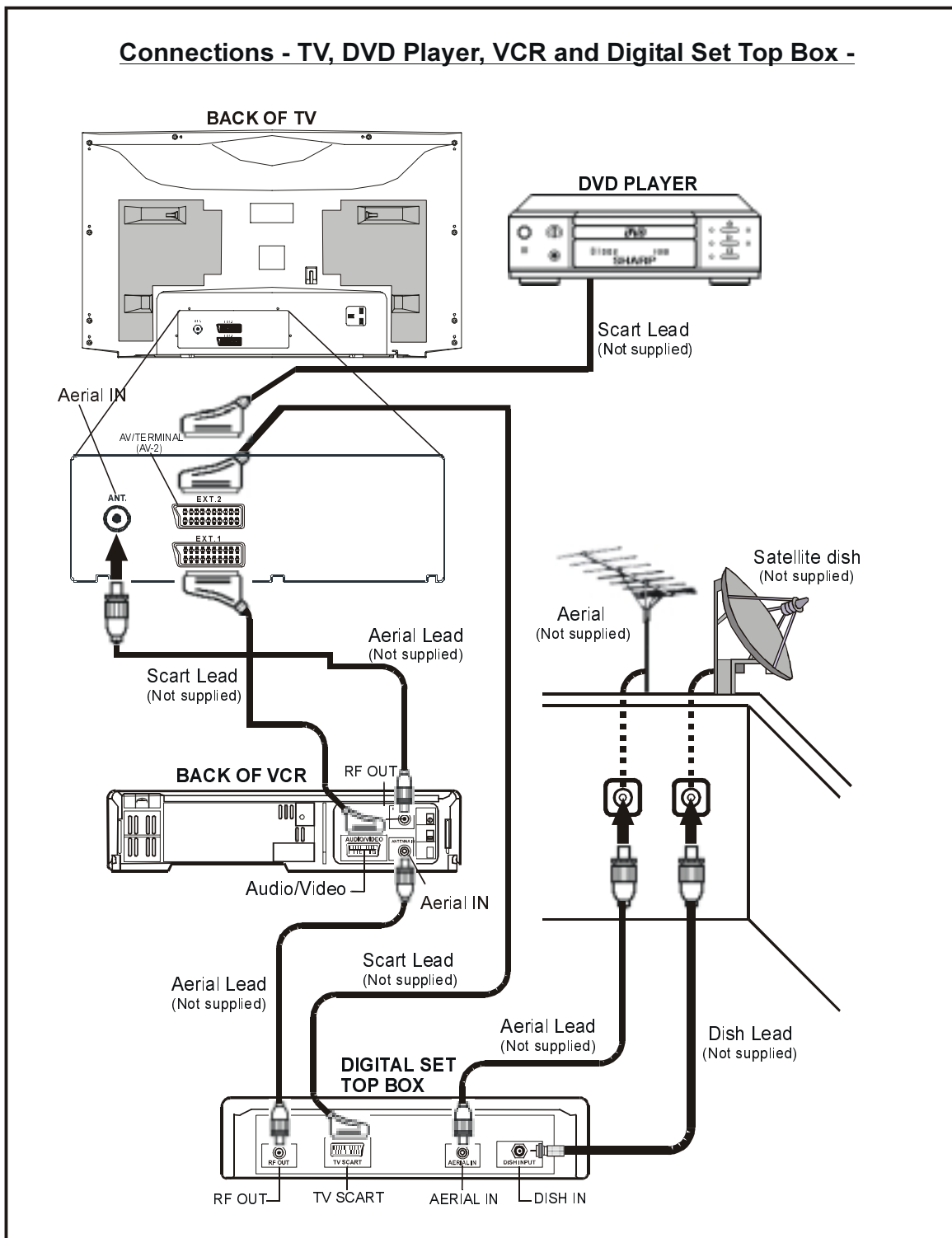

**Note:** For further details, please refer to operation manuals of your DVD Player, VCR and Digital Set Top Box.

## Typical Connections (Continued)

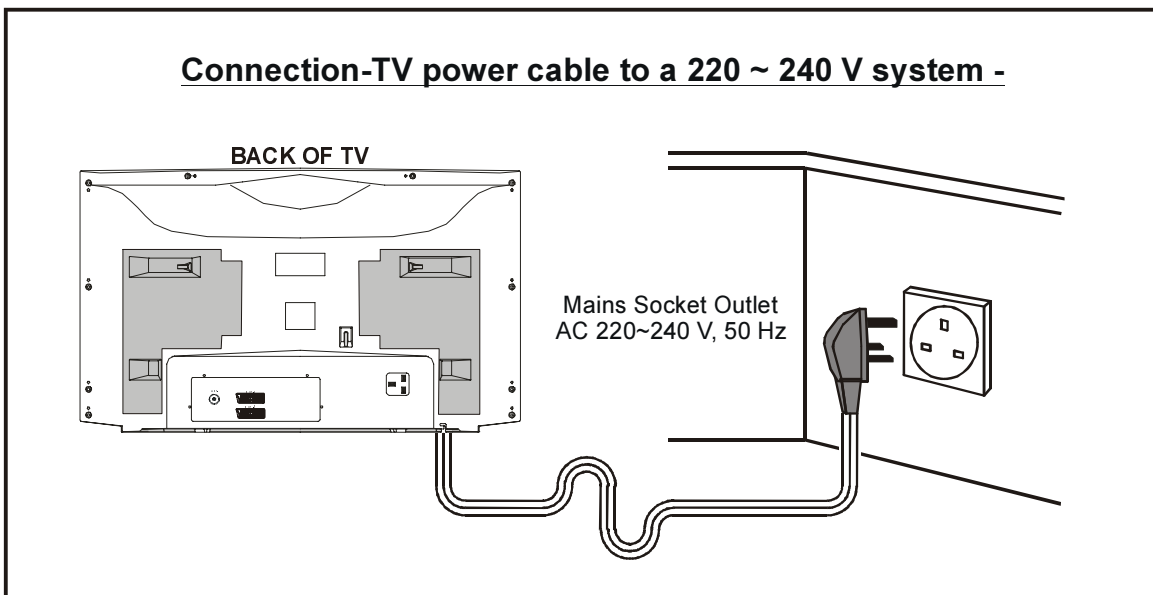
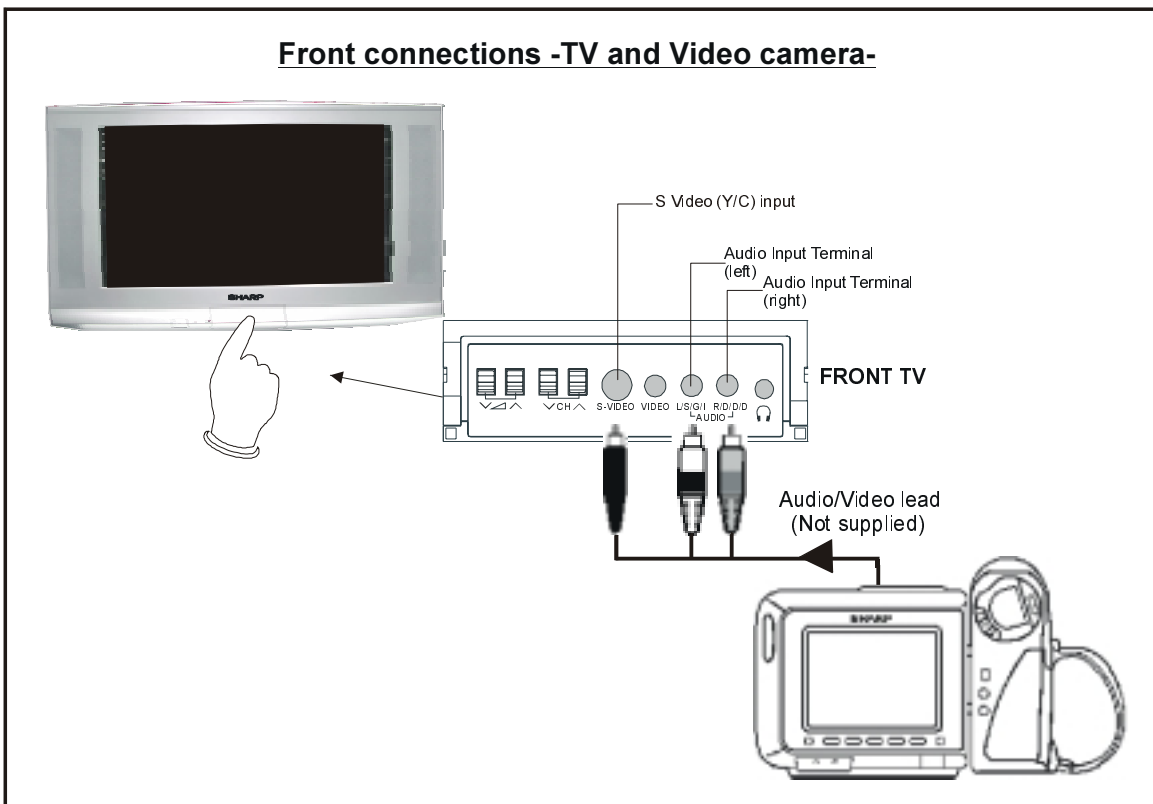

**Note:** For further details, please refer to operation manual of your Video Camera.



## 21-pin Euro-SCART and 21-pin Audio/Video

### REAR TV

#### RF Input

1. Aerial terminal

#### 21-pin In/Out

2. 21-pin Audio/Video (RGB) (AV-1) With PAL/SECAM/NTSC Video Input
3. 21-pin Audio/Video (AV-2) With PAL/SECAM/NTSC Video Input

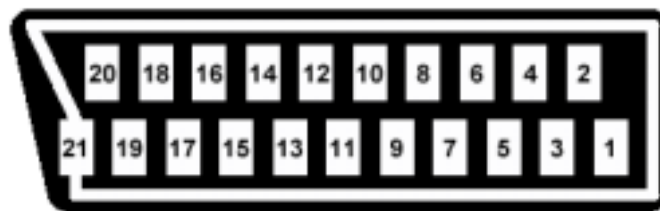
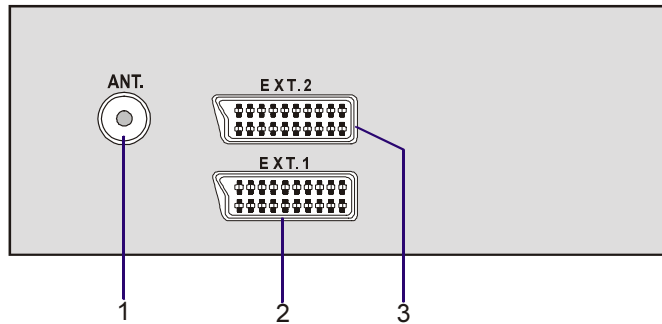

### 21-pin Euro-SCART (AV-1) (EXT.1)

- |                           |                        |                                      |
|---------------------------|------------------------|--------------------------------------|
| 1. Audio right output     | 8. Audio-video control | 15. Red input                        |
| 2. Audio right input      | 9. Earth for green     | 16. Red/Green/Blue control           |
| 3. Audio left output      | 10. Not used           | 17. Earth for video                  |
| 4. Common earth for audio | 11. Green input        | 18. Earth for Red/Green/Blue control |
| 5. Earth for blue         | 12. Not used           | 19. Video output                     |
| 6. Audio left input       | 13. Earth for red      | 20. Video input (PAL/SECAM/NTSC)     |
| 7. Blue input             | 14. Not used           | 21. Plug shield                      |

### 21-pin Audio/Video (AV-2) with Input (EXT.2)







- |                           |                        |                                  |
|---------------------------|------------------------|----------------------------------|
| 1. Audio right output     | 8. Audio-video control | 15. Not used                     |
| 2. Audio right input      | 9. Earth               | 16. Not used                     |
| 3. Audio left output      | 10. Not used           | 17. Earth for video              |
| 4. Common earth for audio | 11. Not used           | 18. Earth                        |
| 5. Earth                  | 12. Not used           | 19. Video output                 |
| 6. Audio left input       | 13. Earth              | 20. Video input (PAL/SECAM/NTSC) |
| 7. Not used               | 14. Not used           | 21. Plug shield                  |

## Troubleshooting

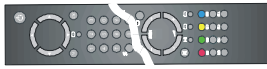
If the fault cannot be corrected by using this guide, remove the mains plug from the wall socket and contact the dealer or supplier from whom it was purchased. Where this is not possible, please visit our web-site at [www.sharp.co.uk/support](http://www.sharp.co.uk/support). Customers without Internet access may telephone **08705 274277** [or **(01) 676 0648** if telephoning from Ireland] during office hours. Certain replacement parts and accessories may be obtained from our Main Parts Distributor, who can be contacted on the following numbers:

Willow Vale Electronics Ltd. **0121 766 5414** and **0161 205 7531**

In the unlikely event of this equipment requiring any repair during the guarantee period, you will need to provide proof of the date of purchase to the repairing company. Please keep your invoice or Receipt, which is supplied at the time of purchasing.

PROBLEMS	POSSIBLE CAUSES / REMEDIES
 <p>Remote control does not work</p>	<p>TV not plugged in Outlet power OFF</p> <p>Main power button of TV not ON</p> <p>Turn OFF using the Main Power button, then turn ON again after a minute</p> <p>Check batteries in the Remote Control</p>
 <p>No colour / Picture weak</p>	<p>Try a new channel to check for possible station trouble</p> <p>Aerial not connected to terminal at the back of the TV set</p> <p>If outside aerial is used, check for broken wires</p> <p>Adjust COLOUR control</p> <p>Try fine tuning to correct</p>
 <p>Poor reception on some channels</p>	<p>Try a new channel to check for possible station trouble</p> <p>Aerial not connected to terminal at the back of the TV set</p> <p>If outside aerial is used, check for broken wires</p> <p>Check for local interference</p>
 <p>Sound OK, poor picture</p>	<p>Try a new channel to check for possible station trouble</p> <p>Aerial not connected to terminal at the back of the TV set</p> <p>If outside aerial is used, check for broken wires</p> <p>Check for local interference</p> <p>Adjust COLOUR control</p> <p>Try fine tuning to correct</p> <p>Check if the Brightness or Contrast setting in the picture setting mode might be all the way to the minus side</p>
 <p>Picture OK, poor sound</p>	<p>Try a new channel to check for possible station trouble</p> <p>Check for local interference</p> <p>Increase the volume / Check Audio levels</p>
 <p>No picture or sound</p>	<p>Try a new channel to check for possible station trouble</p> <p>TV not plugged in Outlet power OFF</p> <p>Main power button of TV not ON</p> <p>Aerial not connected to terminal at the back of the TV set</p> <p>If outside aerial is used, check for broken wires</p> <p>Turn OFF using the Main Power button, then turn ON again after a minute</p> <p>Check if the Brightness or Contrast setting in the picture setting mode might be all the way to the minus side</p> <p>Increase the volume / Check Audio levels</p>

## Specifications

### TV BROADCASTING

PAL I/I'

### RECEIVING CHANNELS

VHF (BAND I/III)

UHF (BAND U)

HYPERBAND

CABLE-TV

### NUMBER OF PRESET CHANNELS

100

### CHANNEL INDICATOR

ON SCREEN DISPLAY

### RF AERIAL INPUT

75 Ohm Unbalanced

### OPERATING VOLTAGE

220-240V AC, 50 Hz.

### POWER CONSUMPTION (W) (28LF-92H)

95 Watt

### POWER CONSUMPTION (W) (32LF-92H)

### Power Consumption at (Stand-by)

< 3 Watts

### Audio Output (RMS):

2x10 W

### AUDIO OUTPUT

Nicam Stereo

### PICTURE TUBE

28" 16:9

32" 16:9

### Safety

CE - MARK

### EMC

CE - MARK

### DIMENSIONS (DxLxH) (mm) (28LF-92H)

DIMENSIONS			
D	L	H	Weight (kg)
507	827	495	39

### DIMENSIONS (DxLxH) (mm) (32LF-92H)

DIMENSIONS			
D	L	H	Weight (kg)
560	930	557	51

### Cleaning The Screen

Your TV is fitted with a „True Flat" picture tube. The surface of the screen is covered with a foil. Under no circumstances may this be damaged.

### To clean

Clean the laminated screen with a soft cotton cloth. Only non-alkaline, thinned soapsuds on a basis of water or alcohol be used to moisten the cloth. Rub the surface gently with the cloth until the surface is completely dry.

### Under no circumstances...

may the screen be wiped with conventional glass cleaning fluid.

may the screen be brought into contact with abrasive materials.

may soiling be removed by polishing or scouring.

**To clean off sticky substances, the cloth can be moistened with acetone.**

**Under no circumstances clean with this acetone cloth the TV-Cabinet.**

## Important Instructions

For your own safety read following instruction carefully before attempting to connect this unit to the mains supply.

### MAINS (AC) OPERATION

The wires in this mains lead are coloured in accordance with the following code :

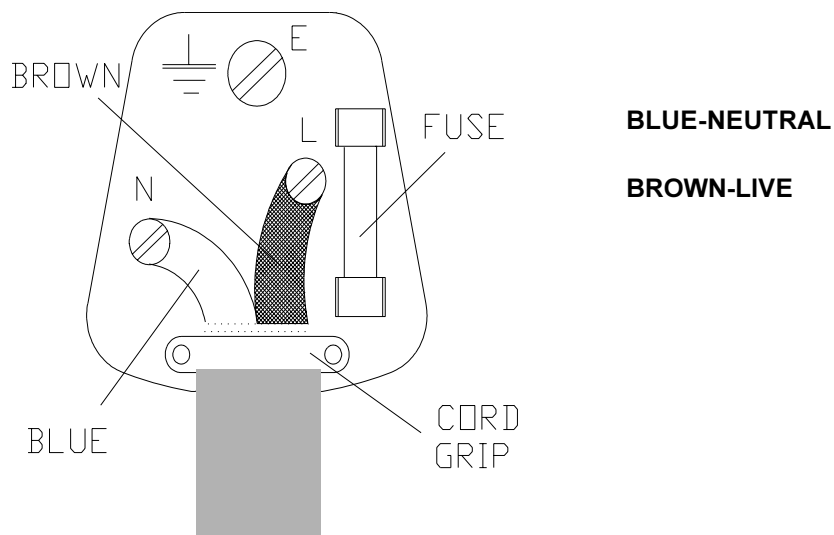

### IMPORTANT

As the colours of the wires in the mains lead of this appliance may not correspond with the coloured markings identifying the terminals in your plug, proceed as follows:

The wire which is coloured blue must be connected to the terminal which is marked with the letter N or coloured black.

The wire which is coloured brown must be connected to the terminal which is marked with the letter L or coloured red.

No connection is to be made to the earth terminal of the plug.

If a 13 Amp (BS 1363) Plug is used a 5 Amp Fuse must be fitted, or if any other type of Plug is used a 5 Amp Fuse must be fitted, either in the Plug or Adaptor, or on the Distribution Board.

### CAUTION

TO PREVENT ELECTRIC SHOCK DISCONNECT FROM THE MAINS BEFORE REMOVING COVER. NO USER SERVICEABLE PARTS INSIDE. REFER SERVICING TO QUALIFIED SERVICE PERSONNEL.

### SAFETY PRECAUTION

THIS EQUIPMENT MUST BE DISCONNECTED FROM THE MAINS WHEN NOT IN USE. DO NOT ALLOW THIS UNIT TO BE EXPOSED TO RAIN OR MOISTURE.

# **SHARP®**

## **SHARP CORPORATION**

### **SHARP ELECTRONICS (U.K.) LTD.**

**Sharp House, Thorp Road, Newton Heath,  
Manchester M40 5BE**

50048416  
12/03



## Free Manuals Download Website

<http://myh66.com>

<http://usermanuals.us>

<http://www.somanuals.com>

<http://www.4manuals.cc>

<http://www.manual-lib.com>

<http://www.404manual.com>

<http://www.luxmanual.com>

<http://aubethermostatmanual.com>

Golf course search by state

<http://golfingnear.com>

Email search by domain

<http://emailbydomain.com>

Auto manuals search

<http://auto.somanuals.com>

TV manuals search

<http://tv.somanuals.com>