

SHARP®

MODEL

FO-175

FO-375

FACSIMILE

OPERATION MANUAL



1. Installation
2. Sending Documents
3. Receiving Documents
4. Making Copies
5. Making Telephone Calls
6. Answering Machine Hookup
7. Special Functions
8. Option Settings
9. Printing Reports and Lists
10. Maintenance
11. Troubleshooting

SHARP

WARRANTY

Facsimile Products

Congratulations on Your Purchase!

This Sharp product is warranted against manufacturing defects for a period of twelve (12) months from the date of original purchase.

In the event of any defect arising in the equipment during the warranty period, such repairs should only be carried out by the Dealer from which the unit was originally purchased or a Service Centre approved by Sharp to service this type of equipment. These repairs would be carried out at no charge to the owner, subject to the conditions specified herein.

The owner is responsible for any transportation and insurance costs if the product has to be returned for repair.

This warranty does not extend to accessories or defects or injuries caused by or resulting from causes not attributable to faulty parts or the manufacture of the product, including but not limited to, defect or injury caused by or resulting from misuse, abuse, neglect, accidental damage, improper voltage, liquid spillage, vermin infestation, software, use of consumables other than those approved by Sharp, or any alterations made to the product which are not authorised by Sharp.

Please retain your sales documentation, as this should be produced to validate a warranty claim.

This warranty is in addition to and in no way limits, varies or excludes any express and implied rights and remedies under any relevant legislation in the country of sale. However, to the extent permitted by such legislation, Sharp excludes any liability for any indirect or consequential damages arising from the purchase or use of the product.

To the extent permitted by law, Sharp excludes all implied warranties and conditions and where the product is one that is not normally required for personal, domestic or household use, Sharp limits its liability to the repair or replacement (at Sharp's option) of materials or workmanship which are found by Sharp to be defective.

For your reference, please enter the particulars of your purchase below and retain, with your purchase documentation.

Model No. _____

Serial No. _____

Date of Purchase _____

Place of Purchase _____

SPform046 (2Sept97)

FOR LOCATION ENQUIRIES WITHIN

AUSTRALIA

REGARDING YOUR LOCAL
SHARP APPROVED SERVICE CENTRE

CALL THE
SHARP SERVICE REFERRAL CENTRE

FREECALL: 1 800 807 820

FACSIMILE: (02) 9672 1210

DURING NORMAL BUSINESS HOURS

SHARP CORPORATION OF AUSTRALIA PTY. LIMITED
A.C.N. 003 039 405

1 Huntingwood Drive, Huntingwood NSW 2148

FOR THE SERVICING OF PRODUCTS

PURCHASED IN

NEW ZEALAND

CONTACT YOUR SELLING DEALER/RETAILER
OR FOR REFERRAL TO A

SERVICE CENTRE,
CALL SHARP CUSTOMER SERVICES

TELEPHONE: **09 634 2059**

FACSIMILE: 09 636 6972

SHARP CORPORATION OF NEW ZEALAND LIMITED

Cnr Mahunga Drive & Hastie Avenue,
Mangere, AUCKLAND

Important Notice: This warranty applies only to products sold in Australia & New Zealand

QUICK REFERENCE GUIDE

INSTALLATION

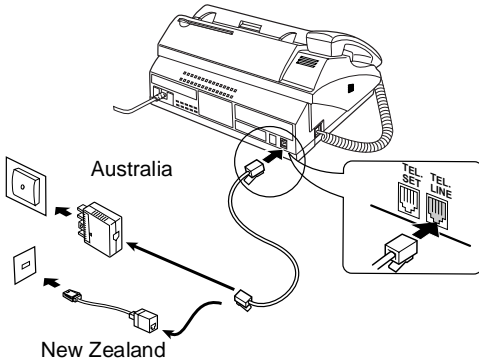

1. Connect the handset as shown.
2. Plug the power cord into an earthed, 230-240 V outlet.
3. Plug one end of the telephone line into the **TEL. LINE** socket on the rear of the fax, and the other end into your telephone wall socket.

Caution: When disconnecting the fax, unplug the telephone line before the power cord.

Connecting an answering machine and/or extension telephone

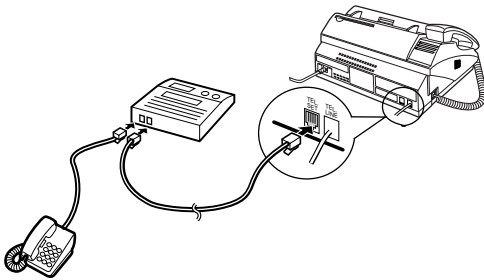

1. Remove the seal covering the **TEL. SET** socket on the rear of the fax. Connect an extension telephone or answering machine to the **TEL. SET** socket.
2. If desired, connect an extension phone to the answering machine.

ENTERING YOUR NAME AND NUMBER

1. Press: **FUNCTION** **3** **#** **#**

Display shows: **OWN NUMBER SET**

2. Press: **START**
3. Enter your fax number (max. of 20 digits) by pressing the number keys.
 - ◆ If you make a mistake, press the **HOLD/SEARCH** key to move the cursor back to the mistake, then enter the correct number or letter.

4. Press: **START**
5. Enter your name by pressing the appropriate number keys as shown below.

◆ To enter two letters in succession that require the same key, press the **SPEAKER** key after entering the first letter.

A = 2 2	J = 5 5	T = 8 8
B = 2 2 2	K = 5 5 5	U = 8 8 8
C = 2 2 2 2	L = 5 5 5 5	V = 8 8 8 8
D = 3 3	M = 6 6	W = 9 9
E = 3 3 3	N = 6 6 6	X = 9 9 9
F = 3 3 3 3	O = 6 6 6 6	Y = 9 9 9 9
G = 4 4	P = 7 7	Z = 9 9 9 9 9
H = 4 4 4	Q = 7 7 7	SPACE = 1 1
I = 4 4 4 4	R = 7 7 7 7	
	S = 7 7 7 7 7	

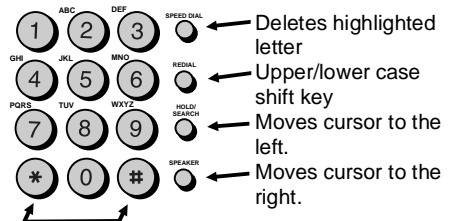

Press either key one or more times to select and enter a symbol.

6. When finished, press: **START** **STOP**

QUICK REFERENCE GUIDE

SETTING THE DATE AND TIME

Press:     

Display shows: DATE & TIME SET

Press the **START** key: 



Enter two digits for the Day (01 through 31).

Enter two digits for the Month (01 through 12).

Enter four digits for the Year (Ex: 1998).

Enter two digits for the Hour (00 through 23).

Enter two digits for the Minute (00 through 59).

When finished, press:  

STORING AND CLEARING NUMBERS FOR AUTO DIALING

1. Press:   

Display shows: FAX/TEL # MODE

2. Press **1** to store a number or **2** to clear a number.

3. Enter a 2-digit Speed Dial number (from 01 to 10 for Rapid Key Dialing, or 11 to 30 for Speed Dialing). (If you are clearing a number, go to Step 7.)

4. Enter the full telephone/fax number.

5. Press: 

6. Enter the name of the location by pressing number keys (max. of 20 characters). (Refer to the letter entry table in *ENTERING YOUR NAME AND NUMBER*.)

7. Press:  

SENDING DOCUMENTS

Place your document (up to 10 pages) face down in the document feeder.

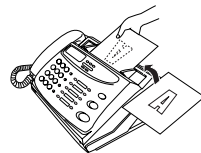

Normal Dialling

1. Lift the handset or press 
2. Dial the fax number.
3. Wait for the reception tone (if a person answers, ask them to press their Start key).

4. Press: 

Rapid Key Dialling

Press the appropriate Rapid Key. Transmission will begin automatically.

Speed Dialling

1. Press: 
2. Enter 2-digit Speed Dial number.
3. Press: 

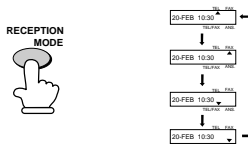

RECEIVING DOCUMENTS

Press: 



FAX mode: The fax automatically answers on two rings and receives the incoming document.

TEL/FAX mode: The fax automatically answers and receives incoming documents. Voice calls are signalled by a special ringing sound.

TEL mode:  → Fax tone → 
→ RECEIVING → 

ANS. mode: Select this mode when you turn on an answering machine connected to the fax.

Introduction

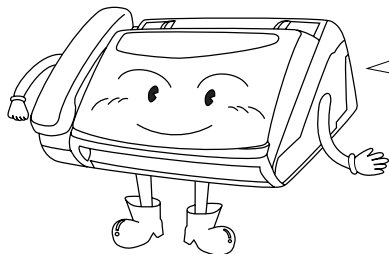

Welcome, and thank you for choosing a Sharp facsimile! The features and specifications of your new Sharp fax are shown below.

Automatic dialling	Rapid Key Dialling: 10 numbers Speed Dialling: 20 numbers
Fax paper	Initial starter roll (included with fax machine): 10 m roll Recommended replacement roll: FO-40PR6 50 m roll
Automatic document feeder	10 sheets max.
Paper cutting method:	FO-175: Tear off by hand FO-375: Automatic cutter
Modem speed	9600 bps with automatic fallback to 7200, 4800, or 2400 bps
Transmission time*	Approx. 15 seconds (Sharp special mode)
Display	16-digit LCD display
Reception modes	FAX, TEL, TEL/FAX, ANS.
Resolution	Horizontal: 8 lines/mm Vertical: Standard: 3.85 lines/mm Fine/Halftone: 7.7 lines/mm Super fine (transmission only): 15.4 lines/mm
Recording system	Thermal recording
Halftone (greyscale)	64 levels

* Based on ITU-T Test Chart #1 at standard resolution in Sharp special mode, excluding time for protocol signals (i.e., ITU-T phase C time only).

Applicable telephone line	Public switched telephone network
Compatibility	ITU-T (CCITT) G3 mode
Configuration	Half-duplex, desktop transceiver
Compression scheme	MH, MR, Sharp
Scanning method	Sheet-feeder CIS (Contact Image Sensor)
Effective printing width	210 mm max.
Input document size	Automatic feeding: Width: 148 to 216 mm Length: 140 to 297 mm Manual feeding: Width: 148 to 216 mm Length: 140 to 600 mm
Effective scanning width	210 mm max.
Contrast control	Automatic/Dark selectable
Copy function	Standard
Telephone function	Standard (Cannot be used for incoming/outgoing if power fails)
Power requirements	230-240 V AC, 50 Hz
Operating temperature	5 to 35°C
Humidity	Maximum: 85 %
Power consumption	Stand-by: 5.1 W Maximum: 120 W
Dimensions	Width: 308 mm Depth: 256 mm Height: 138 mm
Weight	FO-175: Approx. 2.5 kg FO-375: Approx. 2.6 kg

As a part of our policy of continuous improvement, SHARP reserves the right to make design and specification changes for product improvement without prior notice. The performance specification figures indicated are nominal values of production units. There may be some deviations from these values in individual units.

Important safety information

- For your safety, if any of your equipment is not operating properly or should any physical damage occur to the equipment where internal parts may become exposed, the equipment should be immediately disconnected from the phone line and then the power line and returned to a SHARP authorised Service Centre for inspection, repair, or disposal.
- In Australia, installing or modifying telephone lines should only be done by an ACA licensed serviceman. In New Zealand, installing or modifying telephone lines should be done in accordance with Telecom wiring practices.
- Do not disassemble this machine or attempt any procedures not described in this manual. Refer all servicing to qualified service personnel.
- This machine must only be connected to a 230-240 V, 50 Hz, grounded (3-prong) outlet. Connecting it to any other kind of outlet may damage the machine.
- Do not install or use the machine near water, or when you are wet. Take care not to spill any liquids on the machine.
- Unplug the machine from the power outlet and telephone socket and consult a qualified service representative if any of the following situations occur:
 - Liquid has been spilled into the machine or the machine has been exposed to rain or water.
 - The machine produces odors, smoke, or unusual noises.
 - The power cord is frayed or damaged.
 - The machine has been dropped or the housing damaged.
- Do not allow anything to rest on the power cord, and do not install the machine where people may walk on the power cord.
- Never insert objects of any kind into slots or openings on the machine. This could create a risk of fire or electric shock. If an object falls into the machine that you cannot safely remove, unplug the machine and consult a qualified service representative.
- Do not place this machine on an unstable cart, stand or table. The machine could be seriously damaged if it falls.
- Never install telephone wiring during a lightning storm.

- Never install telephone jacks in wet locations unless the jack is specifically designed for wet locations.
- Never touch uninsulated telephone wires or terminals unless the telephone line has been disconnected at the network interface.
- Use caution when installing or modifying telephone lines.
- Avoid using a telephone (other than a cordless type) during an electrical storm. There may be a remote risk of electric shock from lightning.
- Do not use a telephone to report a gas leak in the vicinity of the leak.
- The socket-outlet must be installed near the equipment and must be easily accessible.

Important:

- This facsimile machine is not designed for use on a line which has call waiting, call forwarding, or certain other special services offered by your telephone company. If you attempt to use the fax machine on a telephone line using any of these services, you may experience errors during transmission and reception of facsimile messages.
- This fax machine is not compatible with digital telephone systems.
- This FO-175/375 is designed to operate in Australia and New Zealand only.

WARNING NOTICE:

NO calls can be made to or from this fax during a mains power failure.

WARNING — Australian Communications Authority (ACA) regulations state that no unauthorised changes or modifications to this equipment are permitted.

Note: Complies with ACA and NZ TELECOM standard AS/NZS3548 regarding emission of electromagnetic interference.

These limits are designed to provide reasonable protection against interference in an installation. This equipment generates, uses and can radiate radio frequency energy and, if not installed and used in accordance with the instructions, may cause interference. However, there is no guarantee that interference will not occur in a particular installation.

If this equipment does cause interference to radio or television reception, which can be determined by turning the equipment off and on, the user is encouraged to try to correct the interference by one or more of the following measures:

- Reorient or relocate the receiving antenna.
- Increase the separation between the equipment and the receiver.
- Connect the equipment to an outlet on a different circuit to that which the receiver is connected.
- Consult the dealer or an experienced radio/TV technician for help.

For Australia: The Ringer Equivalence Number (REN) for this equipment is written on the back of the machine.

The sum of all the Ringer Equivalence Numbers (REN's) on your telephone line should not exceed 3 to assure correct service from your telephone company.

Table of Contents

1	Installation	1
	Unpacking Checklist	1
	A Look at the Operation Panel	2
	Connections	4
	Original Document Support	9
	Paper Guide	9
	Loading the Fax Paper	9
	Entering Your Name and Fax Number	13
	Setting the Date and Time	16
	Selecting the Reception Mode	18
	Volume Adjustment	19
2	Sending Documents	21
	Transmittable Documents	21
	Loading the Document	23
	Resolution and Contrast	25
	Sending a Fax by Normal Dialling	27
	Sending a Fax by Automatic Dialling	29
3	Receiving Documents	38
	Using TEL/FAX Mode	38
	Using ANS. Mode	39
	Using FAX Mode	39
	Using TEL Mode	40
4	Making Copies	42
5	Making Telephone Calls	43
6	Answering Machine Connection	45
	Connecting an Answering Machine	45
	Activating the Answering Machine Connection	47

7	Special Functions	48
	Caller ID	48
	Distinctive Ring.	53
	Blocking Reception of Unwanted Faxes.	55
	Polling (Requesting a Fax Transmission)	57
	Timer Operations.	60
8	Option Settings	62
9	Printing Reports and Lists	68
10	Maintenance	72
11	Troubleshooting	74
	Problems and Solutions.	74
	Messages and Signals	79
	Clearing Paper Jams	81
	Index	83

Installation

Unpacking Checklist

Before setting up, make sure you have all of the following items.



If any are missing, contact your dealer or retailer.

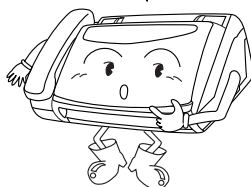

Handset



Handset lead

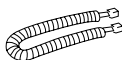

Fax paper (sample roll)

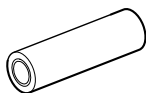

Rod (For FO-175 only)



Paper tray (FO-375 only)



Rapid key labels

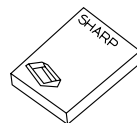

Operation manual



Telephone line cord



Adapter (for Australia)

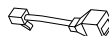

Adapter (for New Zealand)



Business products dealer installation report

A Look at the Operation Panel

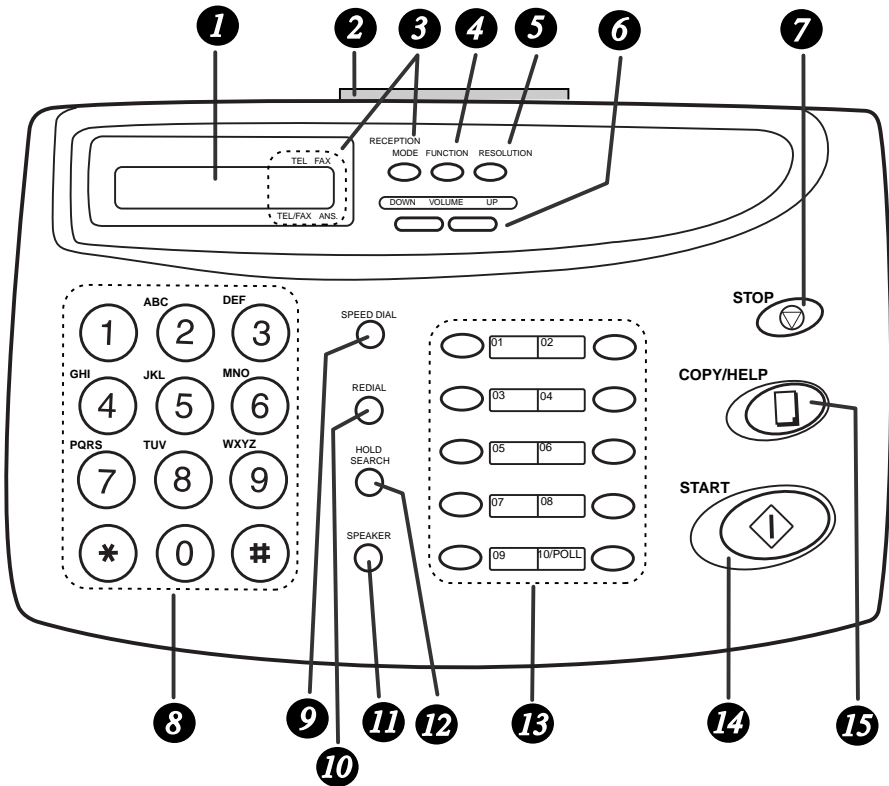

- 1 Display**
This displays messages and prompts during operation and programming.
- 2 PANEL RELEASE**
Pull this release toward you to open the operation panel.
- 3 RECEPTION MODE key**
Press this key to select the reception mode. An arrow in the display will point to the currently selected reception mode.
- 4 FUNCTION key**
Press this key to select various special functions.

- 5 RESOLUTION key**
Press this key to adjust the resolution and contrast before sending or copying a document.
- 6 VOLUME keys**
Press these keys to adjust the volume of the speaker when the **SPEAKER** key has been pressed, or the volume of the ringer at all other times.
- 7 STOP key**
Press this key to stop operations before they are completed.
- 8 Number keys**
Use these keys to dial numbers, and enter numbers and letters during number/name storing procedures.
- 9 SPEED DIAL key**
Press this key to dial a 2-digit Speed Dial number.
- 10 REDIAL key**
Press this key to automatically redial the last number dialed.
- 11 SPEAKER key**
Press this key to hear the line and fax tones through the speaker before sending a document, or dialling a voice number.
Note: **This is not a speakerphone.** You must pick up the handset to talk with the other party.
- 12 HOLD/SEARCH key**
Press this key to search for an automatic dialling number, or, during a phone conversation, press this key to put the other party on hold.
- 13 Rapid Dial Keys**
Press one of these keys to dial a fax or voice number automatically. (Note that you must attach the Rapid Key labels.)
- 14 START key**
Press this key to send or receive a document manually when off hook.
- 15 COPY/HELP key**
When a document is in the feeder, press this key to make a copy. At any other time, press this key to print out the Help List, a quick reference guide to the operation of your fax.

Connections

Points to keep in mind when setting up

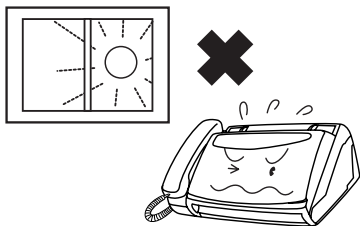

Do not place the machine in direct sunlight.

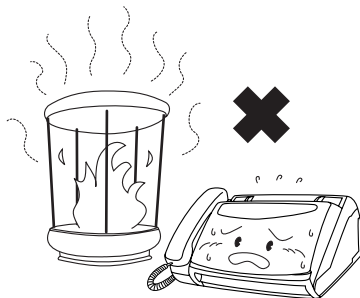

Do not place the machine near heaters or air conditioners.



Keep dust away from the machine.

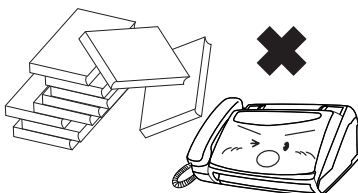

Keep the area around the machine clear.

About condensation

If the machine is moved from a cold to a warm place, it is possible that condensation may form on the scanning glass, preventing proper scanning of documents for transmission. To remove the condensation, turn on the power and wait approximately two hours before using the machine.

Handset

Connect the handset as shown and place it on the handset rest.

- ◆ The ends of the handset lead are identical, so they will go into either socket.

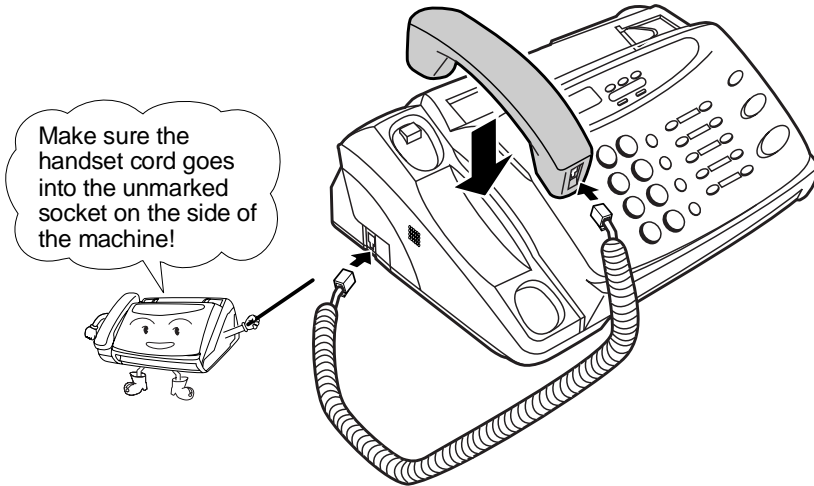

Use the handset to make ordinary phone calls, or to transmit and receive documents manually.

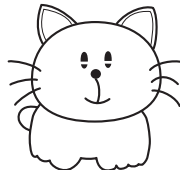

Power lead

Plug the power lead into a 230-240 V, 50 Hz, earthed (3-prong) AC outlet.

- ◆ **Caution:** When disconnecting the fax, unplug the telephone line cord before unplugging the power lead.
- ◆ **Caution:** The mains outlet (socket outlet) should be installed near the equipment and be easily accessible.

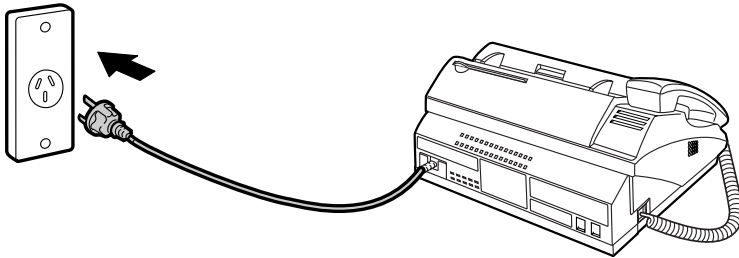

The machine does not have a power on/off switch, so the power is turned on and off by simply plugging or unplugging the power lead.

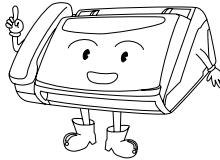

Note: If your area experiences a high incidence of lightning or power surges, we recommend that you install surge protectors for the power and telephone lines. Surge protectors can be purchased at most telephone specialty stores.

Moving your fax and reconnecting

Should it be necessary to move your fax to a new location, first disconnect the telephone line cord before disconnecting the power lead. When reconnecting, it is necessary to connect the power lead before connecting the telephone line cord.

Telephone line cord

Insert one end of the telephone line cord into the adapter. Insert the other end of the line cord into the socket on the back of the fax marked **TEL. LINE**. Plug the adapter into the telephone socket on the wall.

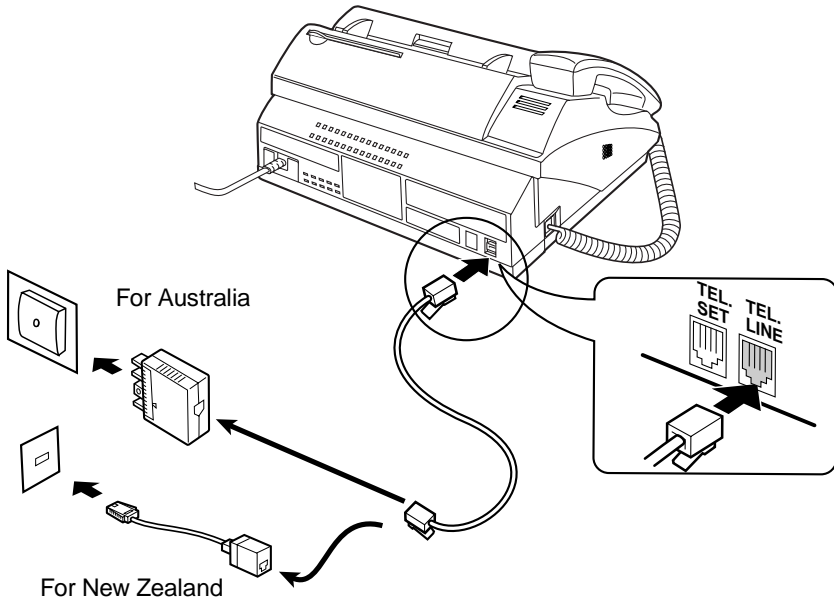

Be sure to insert the telephone line cord into the **TEL. LINE** socket. **Do not** insert it into the **TEL. SET** socket.

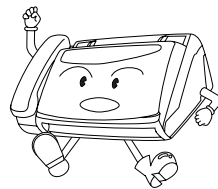

Comments:

- Your fax is set for tone dialling. If you are on a pulse only dial line, you must set the fax for pulse dialling by changing Option Setting 7. This procedure is described in Chapter 8, "Option Settings".
- If you intend to use a computer fax modem on the same phone line, you must reset Option Setting 14 (Fax Signal Receive) to NO in order to prevent transmission and reception errors. This procedure is described in Chapter 8, "Option Settings".

Extension phone (optional)

If desired, you can connect an extension phone to the **TEL. SET** socket on the fax.

- ◆ To connect an answering machine to your fax, see Chapter 6, *Answering Machine Connection*.

-
- 1** Remove the seal covering the **TEL. SET** socket.

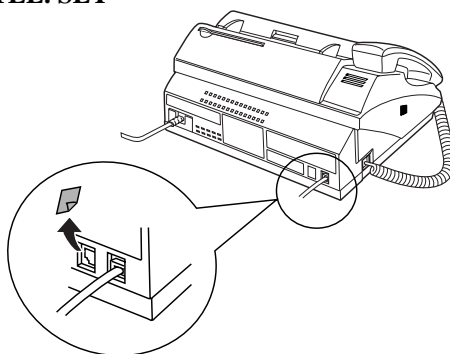

-
- 2** Connect the extension phone line to the **TEL. SET** socket.

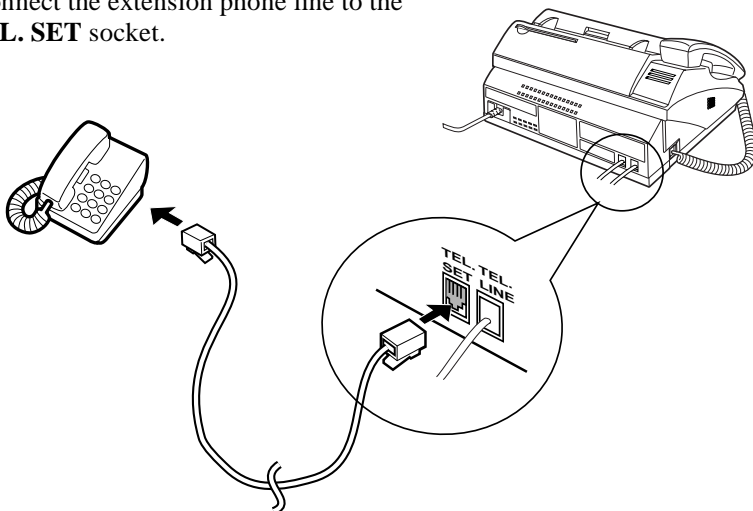

Important: In New Zealand, not all standard telephones and answering machines will respond to incoming ringing when connected to the extension socket of the equipment.

Original Document Support

Rotate the original document support so that it points straight out.

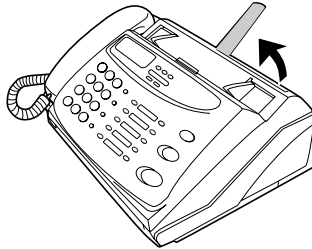

Paper Guide (FO-375 only)

Attach the paper guide by inserting the ends into the holes in the front of the fax as shown.

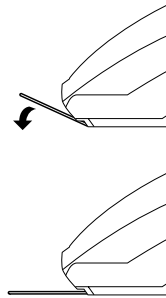
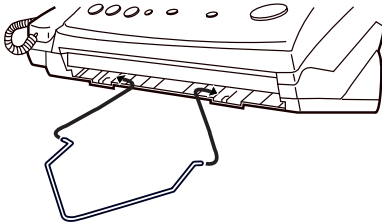

Loading the Fax Paper

Your fax machine prints incoming faxes on a special kind of paper called thermal paper.

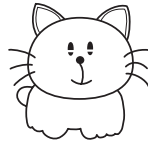

The fax's print head creates text and images by applying heat to the thermal paper.

Note: The power must be on (plug in the power cord) when loading fax paper in the fax machine.

- 1 Pull the release marked **PANEL RELEASE** toward you and open the operation panel.

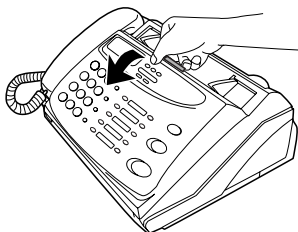

2 Remove the packing paper from the paper compartment.

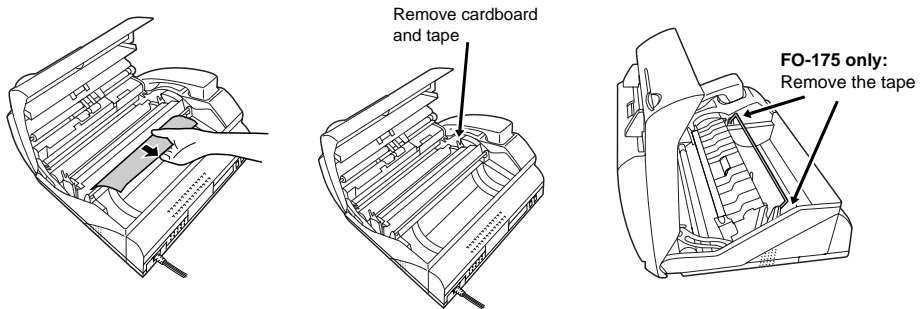

3 FO-175 only: Make sure the ends of the guide wire are inserted in the holes. (If the guide wire is not inserted correctly, out-of-paper detection will not be possible.)

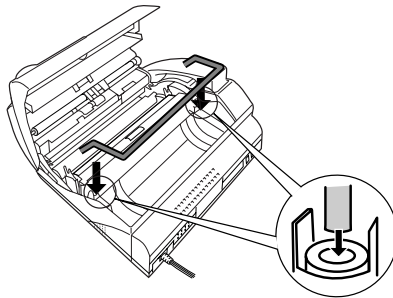

4 Unwrap the roll of fax paper and place it in the compartment.

- **Important:** The roll must be placed so that the leading edge of the paper unrolls as shown. (The paper is only coated on one side for printing. If the roll is placed backwards, the paper will come out blank after printing.)

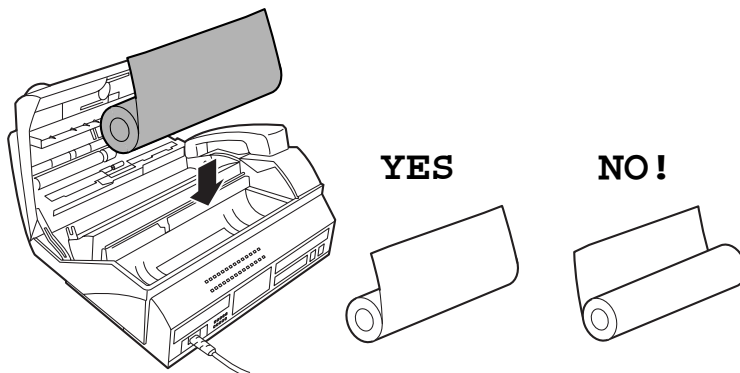

FO-175 only: First insert the spool shaft into the paper roll and then set the spool shaft ends into the slots on each side of the paper compartment.

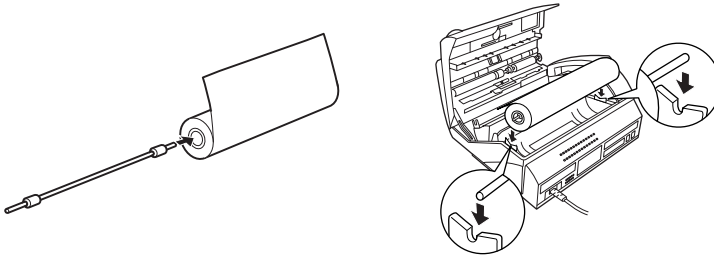

- 5** Insert the leading edge of the paper into the paper inlet. Continue to push the paper through the inlet until it comes out of the opening in the front of the fax.

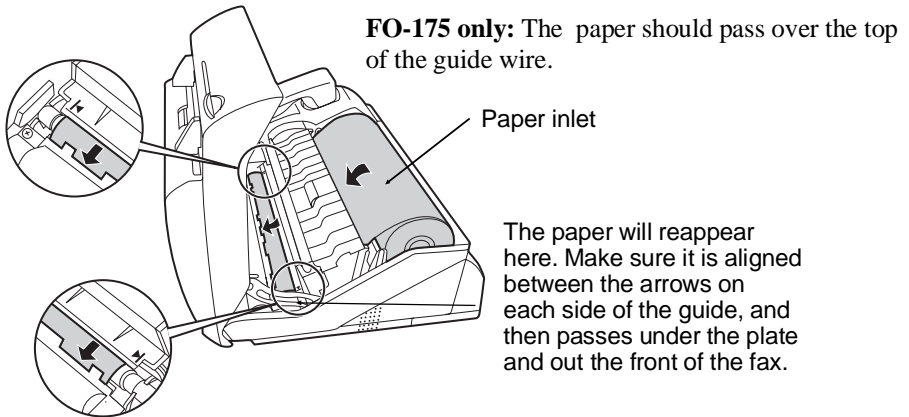

- 6** Close the operation panel, making sure it clicks into place.

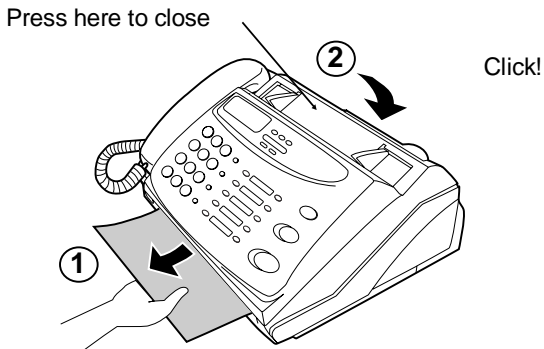

7 FO-175: A short length of the fax paper will feed out. Grasp the paper by the edge and pull upward to tear it off.

FO-375: A short length of the fax paper will feed out and be cut off. (If this doesn't happen, repeat the loading procedure.)

Note: The FO-375 has a built-in anti-curl mechanism that will help to reduce paper curling problems. The anti-curl mechanism is more effective at the beginning of the paper roll and less effective toward the end.

Replacing the fax paper

When the paper runs out, OUT OF PAPER will appear in the display. Reception and copying will no longer be possible. To replace the paper, first take out the old roll, then load the new roll as described above.

To assure a long life for your fax and obtain the best reproduction quality, we recommend that you use the following Sharp fax (thermal) paper which is available from your dealer:

FO-40PR THERMAL PAPER (50 m roll)

- ◆ The use of any other paper may result in poor copy quality and excessive build-up of residue on the head. This is due to the different thermal reactive characteristics of each manufacturer's paper.

Handling fax paper

Do not unpack the paper until you are ready to use it. It may become discoloured if:

- ◆ It is stored at high humidity or high temperature.
- ◆ It is exposed to direct sunlight.
- ◆ It comes in contact with glue, thinner, or a freshly copied blueprint.
- ◆ A rubber eraser or adhesive tape is used on it, or it is scratched.

Entering Your Name and Fax Number

Before you can begin using your fax, you need to enter your name and the telephone number of your fax. You also need to set the date and time.



Once you enter this information, it will automatically appear at the top of each fax page you send.

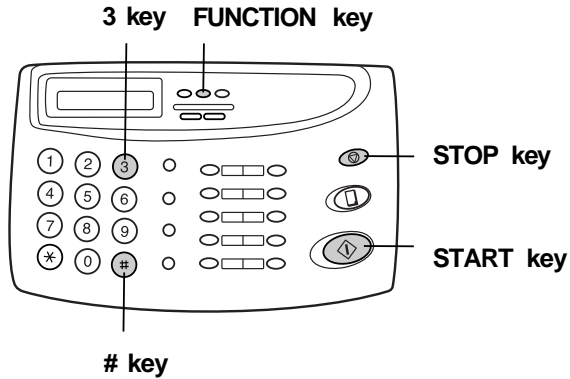
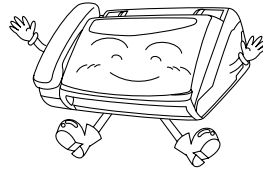

1 Press these keys:



The display will show: ENTRY MODE

2 Press the # key twice:



The display will show: OWN NUMBER SET

Entering Your Name and Fax Number

3 Press the **START** key.



The display will show:

ENTER FAX #

4 Enter your fax number by pressing the number keys. Up to 20 digits can be entered.

- To insert a space between digits, press the # key. To insert a "+", press the * key.
- If you make a mistake, press the **HOLD\SEARCH** key to move the cursor back to the mistake and then enter the correct number. The new number will replace the old number.

Example:



5 Press **START** to enter the fax number in memory.

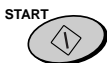

The display will show:

ENTER YOUR NAME

Cursor: A dark square mark in the display that indicates where a number or letter will be entered.

6 Enter your name by pressing the number keys as shown in the chart below. Up to 24 characters can be entered.

- To enter two letters in succession that require the same key, press the **SPEAKER** key after entering the first letter to advance the cursor.

Example: SHARP = 7 7 7 7 7 4 4 4 2 2 7 7 7 7  7 7

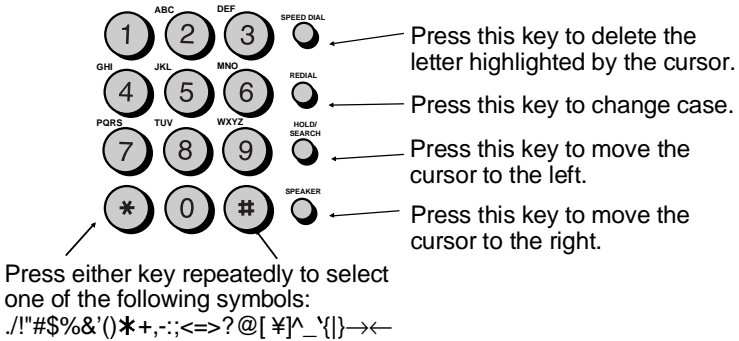
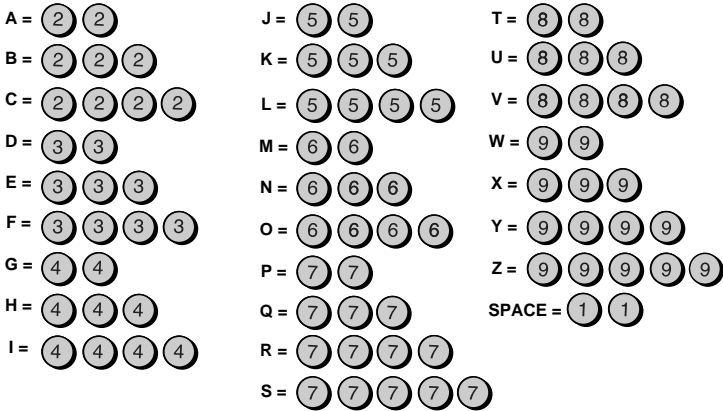

7 Press the **START** key to save your name in memory.



The display will show:

SECURITY SELECT

8 Press the **STOP** key to return to the date and time display.



Setting the Date and Time

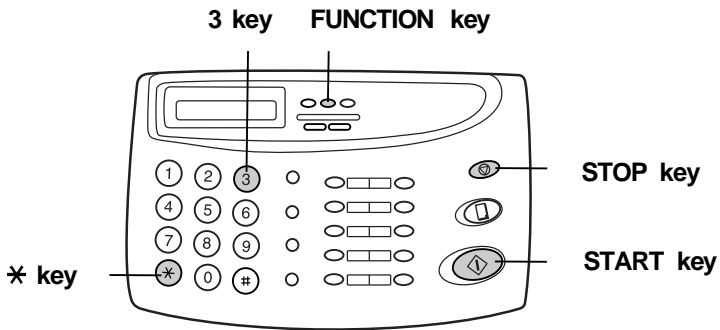
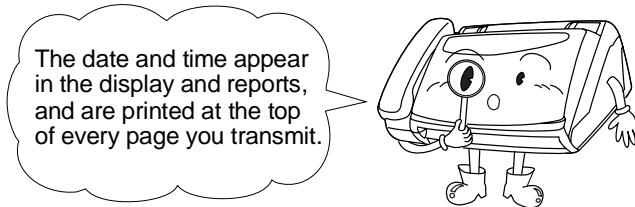

1 Press these keys:

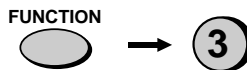

The display will show:



2 Press the * key three times.



The display will show:



3 Press the **START** key.

- The currently set date will appear in the display.



- 4** Enter a two-digit number for the day ("01" to "31").

Example: the 5th



- 5** Enter a two-digit number for the month ("01" for January, "02" for February, "12" for December, etc.).

- To correct a mistake, press the **SPEED DIAL** key to move the cursor back to the mistake, and then enter the correct number.

Example: January



- 6** Enter the year (four digits).

Example: 1998



- 7** Enter a two-digit number for the hour ("00" to "23") and a two-digit number for the minute ("00" to "59").

Example: 9:25



- 8** Press the **START** key to start the clock.



The display will show:

STORE JUNK #

- 9** Press the **STOP** key to return to the date and time display.



Selecting the Reception Mode

Selecting the Reception Mode

Your fax has four modes for receiving incoming calls and faxes:

TEL mode:

This is the most convenient mode for receiving phone calls. You can also receive faxes; however, all calls must first be answered by picking up the fax's handset or an extension phone connected to the same line.

FAX mode:

Select this mode when you only want to receive faxes on your line. The fax will automatically answer all calls and receive incoming faxes.

TEL/FAX mode:

This mode is convenient for receiving both faxes and voice calls. When a call comes in, the fax will detect whether it is a voice call (including manually dialed fax transmissions), or an automatically dialed fax. If it is a voice call, the fax will make a special ringing sound to alert you to answer. If it is an automatically dialed fax transmission, reception will begin automatically.

ANS. mode:

Select this mode when an answering machine is connected as explained in Chapter 6, *Answering Machine Connection*, and you want the answering machine to answer all calls. This allows you to receive both voice messages and faxes while you are out.

Setting the reception mode

Press the **RECEPTION MODE** key until the arrow in the display points to the desired mode.

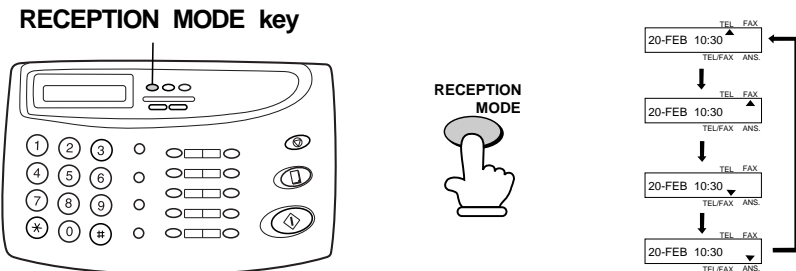

For more information on receiving faxes in TEL, TEL/FAX mode and FAX mode, see Chapter 3, *Receiving Documents*. For more information on using ANS. mode, see Chapter 6.

Volume Adjustment

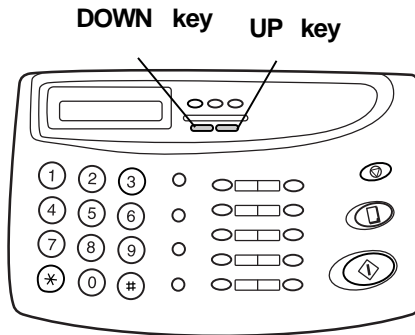
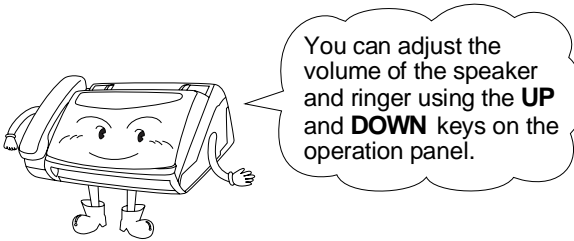

Speaker

- 1** Press the **SPEAKER** key.

SPEAKER



- 2** Press the **UP** or **DOWN** key.

Display:

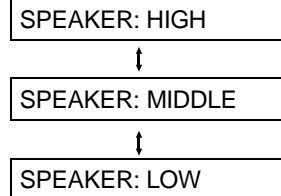
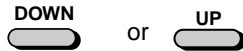

- 3** When the display shows the desired volume level, press the **SPEAKER** key to turn off the speaker.

SPEAKER



Ringer

- 1 Press the **UP** or **DOWN** key. (Make sure the **SPEAKER** key has not been pressed and the handset is not lifted.)
 - The ringer will ring once at the selected level, then the date and time will reappear in the display.

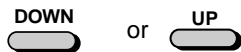

Display:

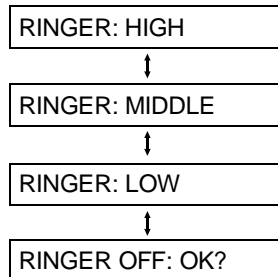

- 2 If you selected RINGER OFF: OK?, press the **START** key.



Silent ring fax detection system

You can also set your fax machine to receive faxes silently, but ring to alert you to a voice call. To do so, set the ringer volume to OFF and set the reception mode to TEL/FAX. When a voice call comes in, a special ringer on the fax will ring. Note that extension telephones will not ring.

Note: During initial ringing before the fax picks up the call, the fax will be silent but extension telephones will ring.

Transmittable Documents

Size and weight

The size and weight of documents that you can load in the document feeder depend on whether you load one page at a time or several pages at once.

Loading one page at a time:

Minimum size

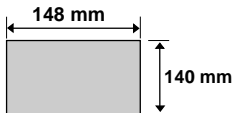

Maximum size

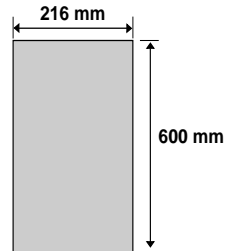

Minimum weight

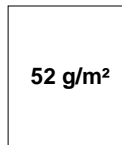

Maximum weight

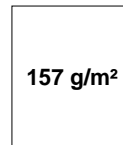

Loading several pages at once:

Minimum size

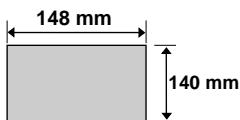

Maximum size

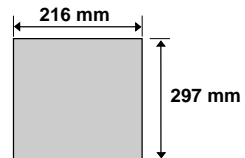

Minimum weight

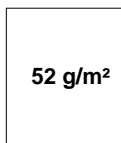

Maximum weight

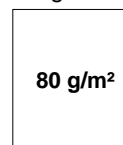

Note: Letters or graphics on the edges of a document will not be scanned.

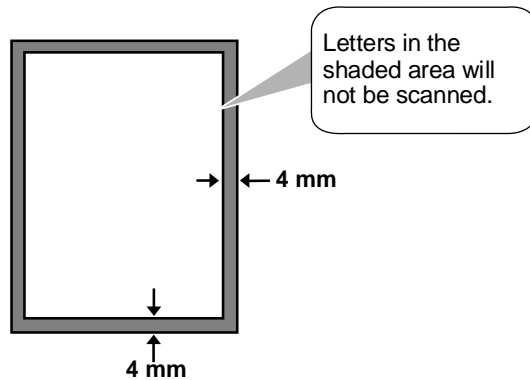

Other restrictions

- ◆ The scanner cannot recognise yellow, greenish yellow, or light blue ink.
- ◆ Ink, glue, and correcting fluid on documents must be dry before they pass through the document feeder.
- ◆ All clips, staples, and pins must be removed from documents before loading in the feeder. If these are not removed, they may damage the machine.
- ◆ Documents which are patched, taped, torn, smaller than the minimum size, carbon backed, or easily smudged should be photocopied, and the copy loaded in the feeder.

Loading the Document

Up to 10 pages can be placed in the feeder at one time. The pages will automatically feed into the machine starting from the bottom page.

- ◆ If you need to send or copy more than 10 pages, place the additional pages gently and carefully in the feeder just before the last page is scanned. Do not try to force them in, as this may cause double-feeding or jamming.
- ◆ If your document consists of several large or thick pages which must be loaded one at a time, insert each page into the feeder as the previous page is being scanned. Insert gently to prevent double-feeding.

- 1** Adjust the document guides to the width of your document.



- 2** Place the document face down and push it gently into the document feeder. The top edge of the document should enter the machine first.

- The feeder will draw the leading edge of the document into the machine. The display will show:

READY TO SEND

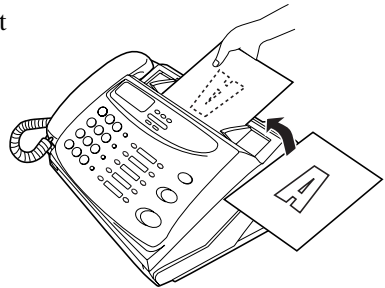

- 3** Adjust the resolution and/or contrast setting (if desired) as explained in the section *Resolution and Contrast*, then dial the receiving machine as explained in *Sending a Fax by Normal Dialling*.

RESOLUTION



Removing a document from the feeder

If you need to remove a document from the feeder, open the operation panel.

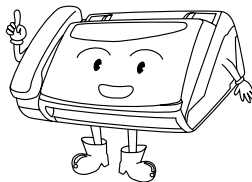

Important:

Do not try to remove a document without opening the operation panel. This may damage the feeder mechanism.

- 1** Pull the release marked **PANEL RELEASE** toward you and open the operation panel.

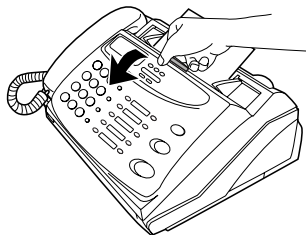

- 2** Remove the document.

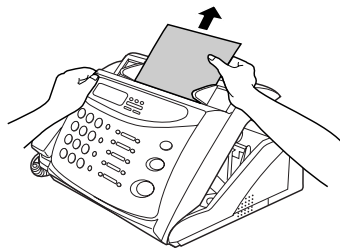

- 3** Close the operation panel, making sure it clicks into place.

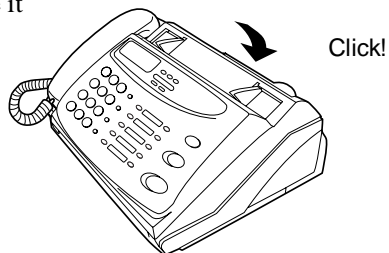

Resolution and Contrast

If desired, you can adjust the resolution and contrast before sending a document.

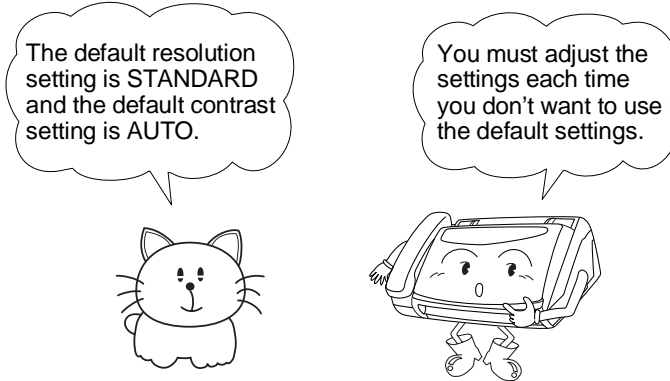

Note: The resolution and contrast settings are only effective for transmitting a document. They are not effective for receiving a document.

Resolution settings

- STANDARD:** Use STANDARD for ordinary documents. This setting gives you the fastest and most economical transmission.
- FINE:** Use FINE for documents containing small letters or fine drawings.
- SUPER FINE:** Use SUPER FINE for documents containing very small letters or very fine drawings.
- HALF TONE:** Use HALF TONE for photographs and illustrations. The original will be reproduced in 64 shades of grey.

Note: In order to transmit in FINE or SUPER FINE resolution, the receiving fax machine must also have that resolution. If it doesn't, your machine will automatically step down to the next best available setting.

Contrast settings

- AUTO** Use AUTO for normal documents.
- DARK** Use DARK for faint documents.

1 Load the document(s).

- The document must be loaded before the resolution and contrast can be adjusted.

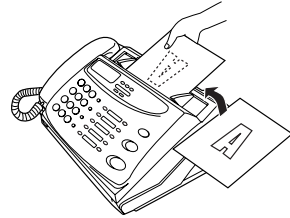

2 Press the **RESOLUTION** key one or more times until the desired resolution and contrast settings appear in the display.

- The first time you move through the list of resolution settings, the contrast setting AUTO will appear next to each resolution setting. The second time you move through the list, the contrast setting DARK will appear.

RESOLUTION



Display:

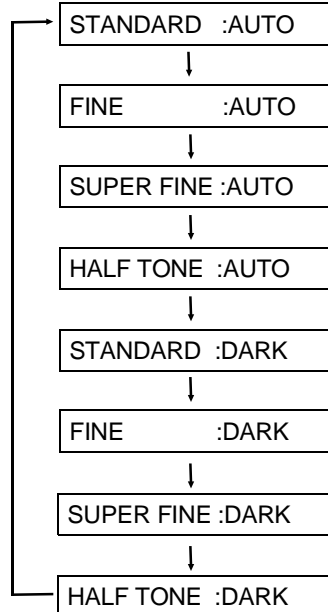

Sending a Fax by Normal Dialling

With Normal Dialling, you pick up the handset (or press the **SPEAKER** key) and dial by pressing the number keys.

- ◆ If a person answers, you can talk with them through the handset before sending the fax. (If you pressed the **SPEAKER** key, you must pick up the handset to talk.)
- ◆ Normal Dialling allows you to listen to the line and make sure the other fax machine is responding.

1 Load the document(s).

The display will show:

READY TO SEND

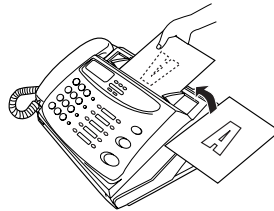

- Set the resolution and/or contrast if desired.



2 Pick up the handset or press the **SPEAKER** key. Listen for the dial tone.

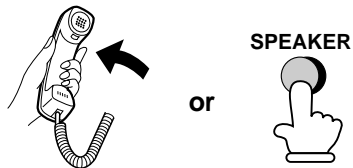

3 Dial the number of the receiving machine by pressing the numeric keys.

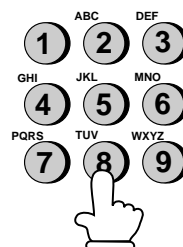

- 4** Wait for the connection. Depending on the setting of the receiving machine, you will either hear a facsimile reception tone or the other person will answer.

- If the other party answers, (lift the handset if the **SPEAKER** key was pressed) ask them to press their **START** key. This causes the receiving machine to issue a reception tone.

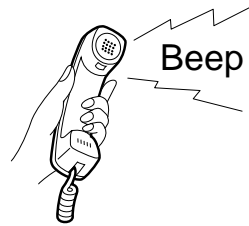

- 5** When you hear the reception tone, press the **START** key. Replace the handset if you used it.

- When transmission is completed, the fax will beep once.



Using the REDIAL key

You can press the **REDIAL** key to redial the last number dialled. To send a document, proceed from Step 4 of Normal Dialling. Note that the speaker will be automatically activated when you press the **REDIAL**.

Facsimile reception tone: This is a pronounced, high-pitched tone that the receiving machine sends to the transmitting machine to indicate that it is ready to receive.



Sending a Fax by Automatic Dialling

You can dial a fax or telephone number by simply pressing a Rapid Key, or by pressing the **SPEED DIAL** key and entering a two-digit number.

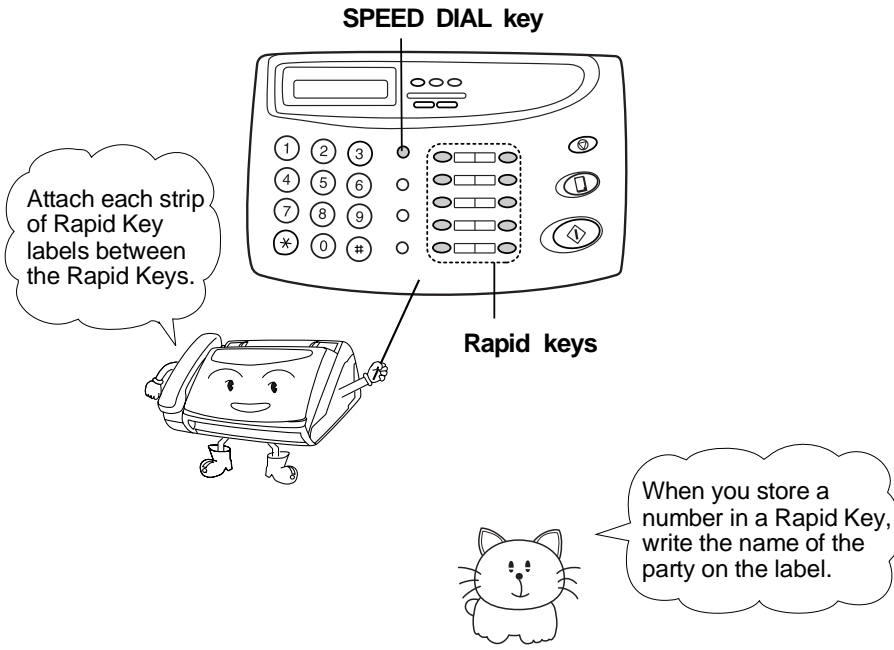
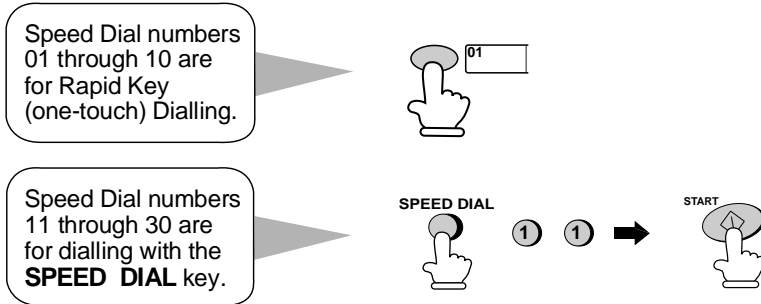
- ◆ To use Automatic Dialling, you must first store the full fax or telephone number in your fax machine.
- ◆ When you store a fax or telephone number, you select a two-digit Speed Dial number for it. 30 Speed Dial numbers are available.



Storing fax and telephone numbers for Automatic Dialling

- 1** Press these keys:   

The display will show:

FAX/TEL. # MODE

- 2** Press **1** to select SET. 

The display will show:

FAX/TEL. # SET

↓ ↑

ENTER SPEED #

- 3** Enter a two-digit Speed Dial number by pressing the number keys (01 to 10 for Rapid Key Dialling, 11 to 30 for Speed Dialling).

  (Example)

- 4** Enter the fax or voice number by pressing the number keys (max. of 32 digits including pauses). (Note: A space cannot be entered.)

- Press the **SPEED DIAL** key to clear a mistake.
- If a pause is required between any of the digits to access a special service or an outside line, press the **REDIAL** key. The pause will appear as a hyphen. Several pauses can be entered in a row.

(Example)





















































































- 5** Press the **START** key.



6 Enter the name of the party by pressing the number keys as shown in the chart below. Up to 10 characters can be entered.

- If you don't want to enter a name, skip this step.
- To enter two letters in succession that require the same key, press the **SPEAKER** key after entering the first letter to advance the cursor.

Example: SHARP = 7 7 7 7 7 4 4 4 2 2 7 7 7 7  7 7

A =  	J =  	T =  
B =   	K =   	U =   
C =    	L =    	V =    
D =  	M =  	W =  
E =   	N =   	X =   
F =    	O =    	Y =    
G =  	P =  	Z =     
H =   	Q =   	SPACE =  
I =    	R =    	
	S =     	

7 Press the **START** key.



8 Return to Step 3 to store another number, or press **STOP** to exit. If the number will be used for Rapid Key Dialling, you can write the name on the appropriate Rapid Key label.

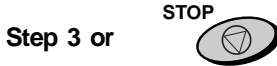

Note: To confirm that Automatic Dialling numbers have been stored correctly, print out the Telephone List. The procedure for doing this is explained in Chapter 9, *Printing Reports and Lists*.

Storing area codes and access codes

You can also store an area code or access code in a Rapid Key or Speed Dial number. To use this number to dial, see *Chain Dialing* in Chapter 5, *Making Telephone Calls*.

Note: An area code or access code stored in a Rapid Key or Speed Dial number can only be used if the handset is lifted or the **SPEAKER** key pressed before dialling.

Clearing numbers

1 Press these keys:

FUNCTION



3



The display will show:

FAX/TEL. # MODE

2 Press **2** to select CLEAR.



3 Enter the Speed Dial number that you want to clear by pressing the number keys.



(Example)

4 Press the **START** key.

START



5 Return to Step 3 to clear another number, or press **STOP** to exit.

Step 3 or

STOP



Making changes

To make changes in a number previously stored, repeat the storing procedure. Select the Speed Dial number for which you want to make changes in Step 3, and then change the number and/or name when they appear in the display (Steps 4 and 6, respectively).

◆ A lithium battery keeps automatic dialling numbers in memory

The machine uses a lithium battery to keep automatic dialling numbers and other programmed data in memory when the power is turned off. Battery power is consumed primarily when the power is off. With the power kept continuously off, the life of the battery is about 5 years. If the battery dies, have your dealer or retailer replace it. Do not try to replace it yourself.

Rapid Key Dialling

If the number you want to dial has been stored for Automatic Dialling as a Speed Dial number from 01 to 10, you can dial it by pressing the corresponding Rapid Key.

1 Load the document(s).

The display will show:

READY TO SEND

- Set the resolution and/or contrast if desired.

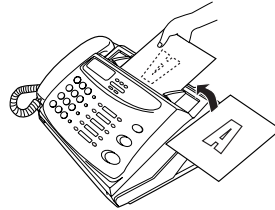

2 Press the Rapid Key corresponding to the desired Speed Dial number.

- The name of the receiving party will appear in the display. If no name was stored, the fax number will appear. (If the name or number is incorrect, press the **STOP** key.)
- The document will be automatically transmitted once the connection is made.

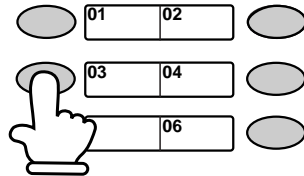

Example: To dial Speed Dial number 03, press Rapid Key 03.

Speed Dialling

Speed Dialling can be used to dial any number that has been stored for Automatic Dialling.

1 Load the document(s).

The display will show:

READY TO SEND

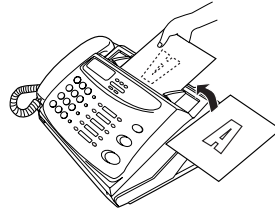

- Set the resolution and/or contrast if desired.



2 Press the **SPEED DIAL** key and then enter the two digits of the Speed Dial number by pressing the number keys.

- To enter numbers 1 through 9, first enter 0 and then the number.

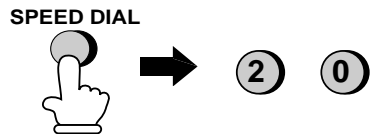

(Example)

3 Check the display. If the name or number shown is correct, press the **START** key. (If not, press the **STOP** key and then repeat Step 2.)

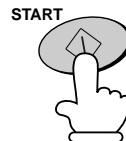

Direct Keypad Dialling

You can also enter a full number with the number keys and then press the **START** key to begin dialling. You can use this method to dial a full number when you don't need to speak to the other party before faxing.

1 Load the document(s).

The display will show:

READY TO SEND

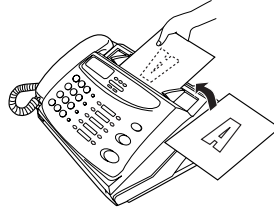

- Set the resolution and/or contrast if desired.

RESOLUTION



2 Enter the number of the receiving machine by pressing the numeric keys.

- If a pause is required between any of the digits to access a special service or an outside line, press the **REDIAL** key. The pause will appear as a hyphen. Several pauses can be entered in a row.

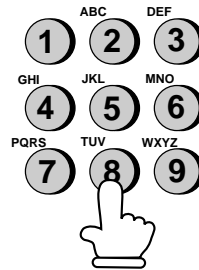

3 Check the display. If the number of the receiving machine shown is correct, press the **START** key.

- If it is not correct, press the **STOP** key to backspace and clear one digit at a time, and then re-enter the correct digit(s).

START



Using the **HOLD\SEARCH** key

If you don't remember the Rapid Key or Speed Dial number in which you have stored a particular fax number, you can search for the number by following the steps below. Once you have found the number, you can dial it and transmit the loaded document by simply pressing the **START** key.

1 Load the document(s).

The display will show:

READY TO SEND

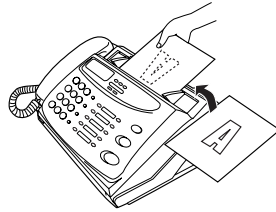

- Set the resolution and/or contrast if desired.

RESOLUTION



2 Press the **HOLD\SEARCH** key and press **1** key.

HOLD
SEARCH



3 Enter the first letter of the stored name by pressing the appropriate number key (the key which corresponds to the required letter) one or more times until the letter appears in the display. If the name begins with a special character or number, press **1**.

- If you don't remember the first letter, go to Step 4 (you will scroll through the list from the beginning).
- If a name wasn't stored for the number, press **0**. This will cause numbers, not names, to appear when you scroll.

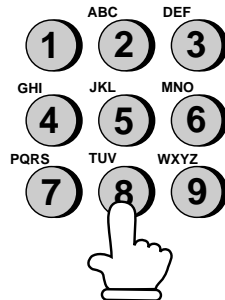

4 Press the # key or the * key to scroll through the names (numbers if you pressed 0). Stop when the desired name appears in the display.

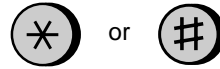

- If no names have been stored that begin with the entered letter, you will scroll from the next name, in alphabetical order, in the list. If no names/numbers have been stored at all, NO DATA will appear.

5 Press the **START** key. The document will be automatically transmitted once the connection is made.

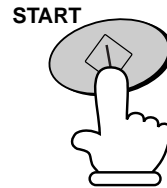

Automatic redialling

If you use automatic dialling (including Direct Keypad Dialling) and the line is busy, the machine will automatically redial the number. Up to 2 redialling attempts will be made at intervals of 5 minutes.

- ◆ To stop automatic redialling, press the **STOP** key.

Receiving Documents

Using TEL/FAX Mode

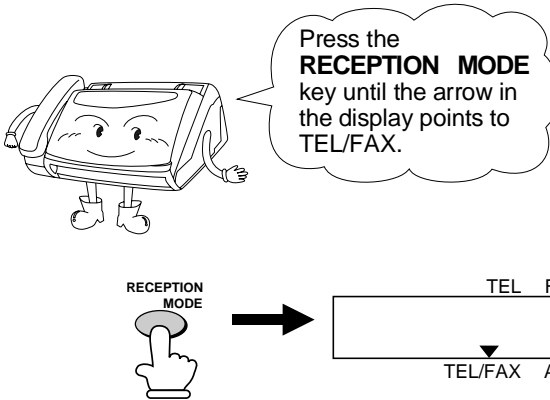

When the reception mode is set to TEL/FAX, your fax automatically answers all calls on 2 rings. After answering, your fax monitors the line for about 5 seconds to see if a fax tone is being sent.

- ◆ If your fax detects a fax tone (this means that the call is an automatically dialled fax), it will automatically begin reception of the incoming document.
- ◆ If your fax doesn't detect a fax tone (this means that the call is a voice call or manually dialled fax), it will make a ringing sound (called pseudo ringing) for 15 seconds to alert you to answer. If you don't answer within this time, your fax will send a fax tone to the other machine to allow the calling party to send a fax manually if they desire.

Comments:

- Only the fax will alert you to voice calls or manually dialled faxes by pseudo ringing. An extension phone connected to the same line will not ring after the connection has been made.
- The duration of pseudo ringing can be adjusted with Option Setting 8. See Chapter 8, *Option Settings*.
- You can change the number of rings on which the machine answers calls by changing Option Setting 2. (See Chapter 8, *Option Settings*.)

Using ANS. Mode

In ANS. mode, your fax will automatically receive voice and fax messages.

Using FAX Mode

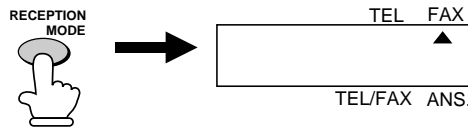
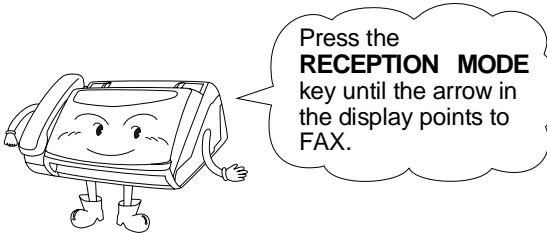

When the reception mode is set to FAX, the machine will automatically answer all calls on 2 rings and receive incoming faxes.

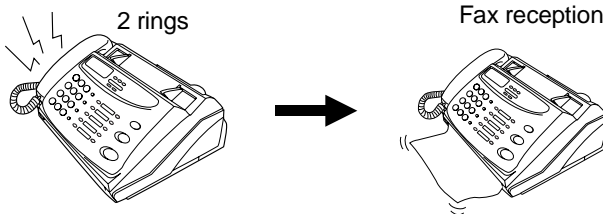

- ◆ You can change the number of rings on which the machine answers calls by changing Option Setting 2. (See Chapter 8, *Option Settings*.)
- ◆ If you pick up the handset before the machine answers, you can talk to the other party and/or receive a document as described in *Using TEL mode*.

Using TEL Mode



Press the **RECEPTION MODE** key until the arrow in the display points to **TEL**.

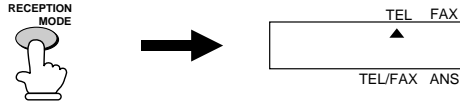

When the reception mode is set to TEL, you must answer all calls using the fax machine's handset or an extension phone connected to the same line.

Answering with the fax's handset

- 1 Pick up the handset when the machine rings.

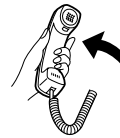

- 2 If you hear a fax tone, wait until the display shows RECEIVING and then replace the handset.

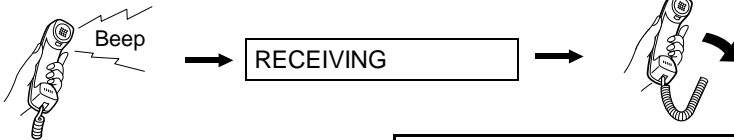

Note: If you have set Option Setting 14 (Fax signal receive) to NO, press the **START** key to begin reception.

- 3 If the other party first talks and then wants to send a fax, press the **START** key after speaking (press your **START** key before the sender presses their Start key).

- Make sure that the display shows RECEIVING, then replace the handset.

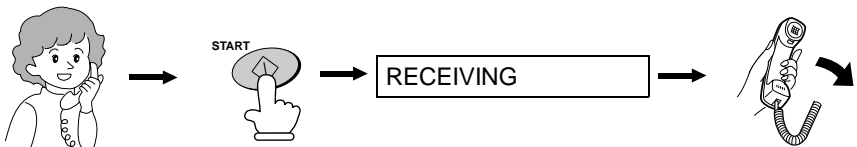

Answering with an extension phone

- 1** Answer the extension phone when it rings.

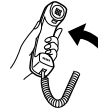

- 2** If you hear a fax tone when you answer an extension phone, wait until your fax answers (the extension phone will go dead), and then hang up.

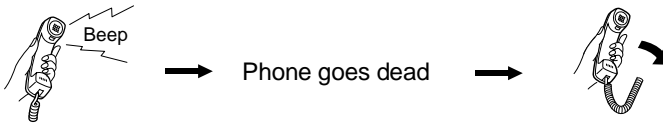

- 3** If the fax doesn't respond, or if the other party first talks to you and then wants to send a fax, press **5**, *****, and ***** on the extension phone (only on a tone dial phone). Hang up.

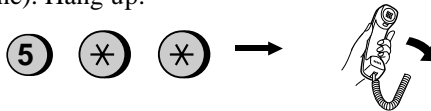

Comments:

- Your fax will not accept the signal to begin reception (**5****) if a document is loaded in its feeder.
- If you have set Option Setting 14 to NO and hear a fax tone when you answer the extension phone, you must press **5**, *****, and ***** if you are on a tone dial phone, or walk over to the fax, pick up the handset, and press the **START** key if you are on a pulse dial only phone.
- In New Zealand, not all standard telephones and answering machines will respond to incoming ringing when connected to the socket of the equipment.

Paper cutting

FO-175: After receiving a document, grasp the paper by the edge and pull upward to tear it off.

FO-375: After receiving a document, your fax will automatically cut each page to a length slightly longer than the original pages.

Making Copies

Your fax can also be used to make copies. You can use this function to make a sample copy of a document before transmitting it to see if the resolution or contrast needs adjustment.

- ◆ The default resolution for copying is FINE.

- 1 Load the document(s) face down.
(Maximum of 10 pages.)

The display will show:

READY TO SEND

- Set the resolution and/or contrast if desired. (The default setting for copying is FINE.)

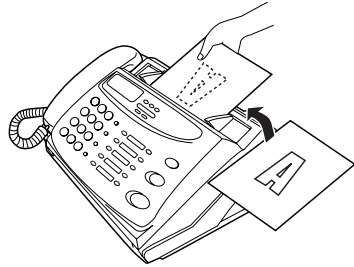

RESOLUTION



- 2 Press the **COPY/HELP** key.

COPY/HELP



Incoming calls during copying

The fax goes into manual reception mode during copying, so if a call comes in at this time, pick up the handset to answer.

To receive a document, press the **START** key after copying is finished. If you want to begin reception immediately, press the **STOP** key to stop copying, and then press the **START** key as soon as the document has fed out and the fax has returned to standby mode.

Making Telephone Calls

Your fax can be used like a regular telephone to make and receive voice calls.

- ◆ To make or receive a phone call, the power must be on.

- 1 Pick up the handset or press the **SPEAKER** key. Listen for the dial tone.

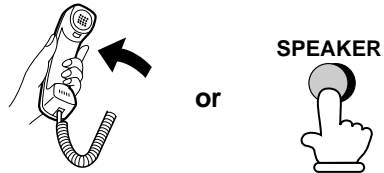

- 2 Dial the number using one of the following methods:

- **Normal Dialling:** Enter the full telephone number with the numeric keys.
- **Rapid Key Dialling:** Press the appropriate Rapid Key.
- **Speed Dialling:** Press the **SPEED DIAL** key, and enter the 2-digit Speed Dial number with the numeric keys.

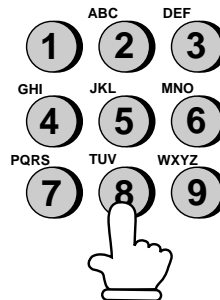

- 3 Speak with the other party when they answer.
 - If you pressed the **SPEAKER** key, pick up the handset to talk.

Comments:

- While the handset of the fax is lifted (off hook), an extension phone connected directly to the fax cannot be used to speak with the other party.
- The fax may interrupt a voice call received on an extension phone if the reception mode is set to ANS and there is a period of silence during the conversation. If you are on a tone dial phone, you can prevent this by pressing any three keys on the phone immediately after you answer. (Note: Do not enter the code to activate fax reception: 5, ✖, ✖.)

Chain Dialling

After lifting the handset, you can dial any combination of Normal Dialling, Rapid Key Dialling and Speed Dialling numbers. For example, if you have stored an area code or an access code for a special service in a Rapid Key, you can press the Rapid Key for that area code or access code, then dial the remainder of the number by pressing a Rapid Key, pressing number keys, or pressing the **SPEED DIAL** key and entering a two-digit Speed Dial number.

Using the **HOLD/SEARCH** key

You can use the **HOLD/SEARCH** key to search for a Rapid Key or Speed Dial number. First search for the number as described in *Using the HOLD/SEARCH key in Sending a Fax by Automatic Dialling* in Chapter 2, then pick up the handset or press the **SPEAKER** key. The number will be dialled automatically (do not press the **START** key).

Redial

The last number called can be redialled by pressing the **REDIAL** key (it is not necessary to pick up the handset or press the **SPEAKER** key). When the other party answers, pick up the handset to talk.

Hold

You can put the other party on hold during a conversation by pressing the **HOLD/SEARCH** key. When this is done, they cannot hear you. You can put the handset back in the cradle without breaking the connection. When you are ready to speak with them again, pick up the handset. If you did not put the handset back in the cradle, press the **HOLD/SEARCH** key again to resume conversation.

Answering Machine Connection

Connecting an Answering Machine

If desired, you can connect an answering machine to your fax machine's **TEL. SET** socket. This will allow you to receive both voice messages and faxes when you are out.

- 1 Remove the seal covering the **TEL. SET** socket.

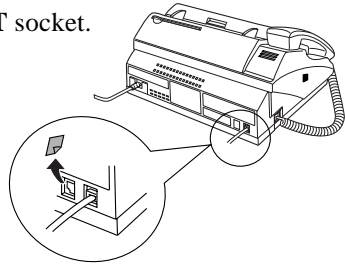

- 2 Connect the answering machine's telephone line socket to the **TEL. SET** socket.

- If desired, you can connect an extension phone to your answering machine's extension phone socket.

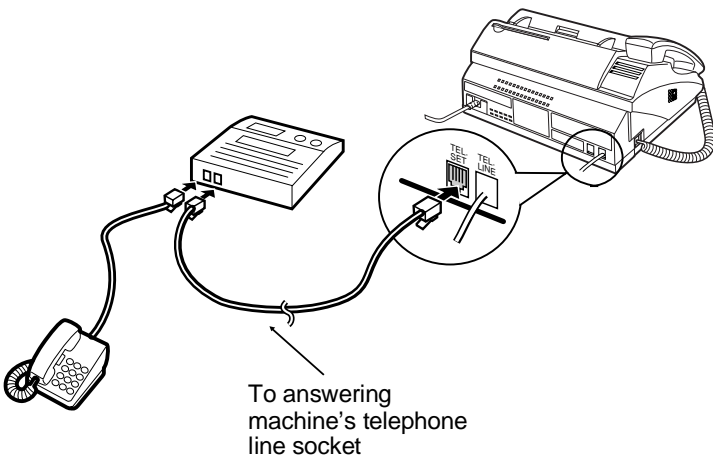

Note: When FaxAbility or Fax Duet (distinctive ring) is used, the answering machine may be connected to any extension of the same line.

Important: In New Zealand, not all standard telephones and answering machines will respond to incoming ringing when connected to the extension socket of the equipment.

Changing the outgoing message

The outgoing message (OGM) of your answering machine should be changed to inform callers who want to send a fax to press their Start key. For example, your message might go as follows:

"Hello. You've reached the ABC company. No one is available to take your call right now. Please leave a message after the beep or press your facsimile Start key to send a fax. Thank you for calling."

Comments:

- It is advisable to keep the length of the message under 10 seconds. If it is too long, you may have difficulty receiving faxes sent by automatic dialling.
- If your outgoing message must be longer than 10 seconds, leave a pause of about four seconds at the beginning of the message. This will give your fax a chance to detect fax tones sent when automatic dialling is used.

Activating the Answering Machine Connection

Before you go out, activate the answering machine connection as follows:

- 1 Set the reception mode to ANS.

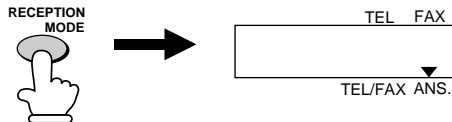

- 2 Set your answering machine to auto answer.

- Your answering machine must be set to answer on a maximum of two rings. If not, you may not be able to receive faxes sent by automatic dialling.
- If your answering machine has a toll saver function, make sure that it will answer by the fourth ring.

How answering machine mode operates

While you are out, all of your incoming calls will be answered by the answering machine and its outgoing message will play. Voice callers can leave a message. During this time, your fax will quietly monitor the line. If your fax detects a fax tone or a duration of silence greater than four seconds, it will take over the line and begin reception.

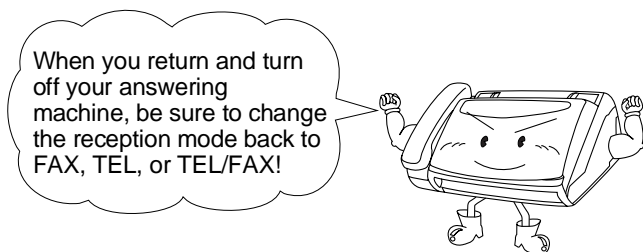

Special Functions

Caller ID

If you subscribe to a caller identification service from your telephone company, you can set your fax to display the name and number of the caller while the fax rings.

Important:

- To use this function, you must subscribe to a caller identification service from your telephone company.
- Your fax may not be compatible with some caller identification services.

1 Press these keys:

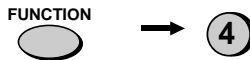

The display will show:

OPTION SETTING

2 Press the * key.



The display will show:

CALLER-ID

3 Press **1** to turn on Caller ID, or **2** to turn it off.

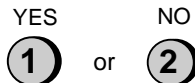

4 Press **1** if you are in Australia or **2** if you are in New Zealand.

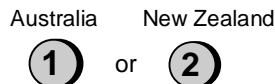

5 Press the **STOP** key to return to the date and time display.



How Caller ID operates

When you receive a call, the name and phone number of the caller will alternately appear in the display, beginning just before the second ring. The information will continue to be displayed until you pick up the handset, or until the fax answers automatically if it is in FAX mode.

Note: Some caller ID services may not provide the name of the caller. In this case, only the phone number will appear.

Display example:

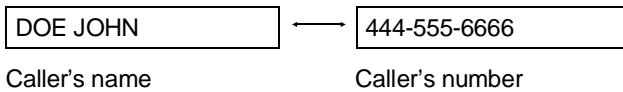

Display messages

One of the following messages will appear while the fax rings if caller information is not available.

- | | |
|------------------------|--|
| NO SERVICE | No caller information was received from your telephone company. Make sure that the telephone company has activated your service. |
| CALLER-ID ERROR | Noise on the telephone line prevented reception of caller information. |
| OUT OF AREA | The call was made from an area which does not have a caller identification service, or the caller's service is not compatible with that of your local phone company. |
| PRIVATE CALL | Caller information was not provided by the telephone company at the caller's request. |

Viewing the Caller ID list

If you subscribe to a Caller ID service and have turned on the Caller ID function, your fax machine will keep information on the most recent 20 unanswered calls and/or unsuccessful faxes you have received. You can view this information, which consists of the name and number of each caller, in the Caller ID List.

Note: For all units installed in New Zealand, the direct use of the displayed number for call back does not operate properly and must not be used. It is necessary to manually enter the verified correct number for the party called. This will often require the addition or deletion of leading digits from the number shown on the display when dialling manually.

- ◆ After you have received 20 unanswered calls, each new call will delete the oldest call.

Follow the steps below to view the Caller ID List in the display. If desired, you can immediately dial a number when it appears.

To print out the list, see Chapter 9, *Printing Reports and Lists*.

-
- 1** Press the keys shown at right. REVIEWING CALLS will appear in the display.

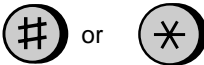
 - 2** Press the # key to scroll through the list from the most recent call, or the * key to scroll through the list from the oldest call.

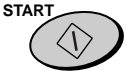
 - 3** If you want to dial one of the numbers in the list, scroll through the list until the number appears in the display.
 - If you want to send a fax, load the document and then press the **START** key.

 - If you want to make a voice call, pick up the handset or press the **SPEAKER** key. Dialing will begin automatically. (If you pressed the **SPEAKER** key, pick up the handset when the other party answers.)

 - 4** Press the **STOP** key when you have finished viewing the list.

To delete calls from the caller list

If you want to delete a single call from the caller list, press the "0" key while the call appears in the display. If you want to delete all calls from the list, hold the "0" key down for at least 3 seconds while you are viewing any number in the list.

Priority Call

If desired, you can set your fax to make a special ringing sound when you receive a call from a designated phone number. This lets you know immediately who is calling without having to look at the display. To use this function, enter the desired phone number by following the steps below (only one phone number can be entered).

- 1** Press the keys shown at right. PRIORITY CALL # will appear in the display.



- 2** Press **1** to enter a number, or **2** to clear a number. (If you pressed **2**, go to Step 4.)

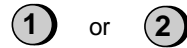

- 3** Enter the phone number by pressing the number keys (the number must be 8 digits long).

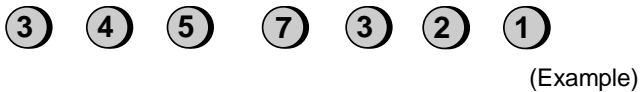

- 4** Press the **START** key and then the **STOP** key.



Blocking voice calls

With Caller ID turned on, you can use the Anti Junk Fax function described in *Blocking Reception of Unwanted Faxes* in this chapter to prevent voice calls as well as fax receptions (the Anti Junk Fax function can normally only prevent faxes).

In this case, when a voice call or a fax transmission comes in from a number you have specified as a "Junk Number", your fax will break the connection as soon as it receives the calling phone number from the caller ID service (before the second ring).

To use this function, set Option Setting 15 to YES as described in Chapter 8, *Option Settings*, and then enter the number in the Anti Junk Number List as explained in *Blocking Reception of Unwanted Faxes* in this chapter.

Distinctive Ring

If you subscribe to a distinctive ring service from your telephone company, you will need to turn on the distinctive ring function. When this is done, your fax machine will signal voice calls by the normal ring pattern, and fax transmissions by a special ring pattern. In the case of a fax transmission, your fax machine will automatically answer the call and receive the fax.

The distinctive ring function is used with the reception mode set to FAX. When your fax number is dialled, your fax machine will signal the call with a special ringing sound, then answer automatically and begin reception after the number of rings set with Option Setting 2 (the factory setting is 2 rings). When your voice number is dialled, the fax machine will signal the call with the normal ringing sound to let you know that you must answer personally.

The factory setting is "NO". If set to "YES", both Australian (Fax Duet) and New Zealand (FaxAbility) Distinctive Ring are supported.

Important:

- The distinctive ring function can only be used if you subscribe to a distinctive ring service from your telephone company. Do not turn on distinctive ring if you are on a normal line, as the fax machine will not operate properly.
- If you turn on distinctive ring, the fax will not operate in TEL/FAX reception mode.

1 Press these keys:



The display will show:

OPTION SETTING

2 Press these keys:



The display will show:

DISTINCTIVE RING

Distinctive Ring

- 3** Press **1** (YES) to turn on distinctive ring, or **2** (NO) to turn it off.

YES
1 or **2**
NO

The display will show:

FAX SIGNAL RX

- 4** Press the **STOP** key.



- 5** Set the reception mode to FAX.

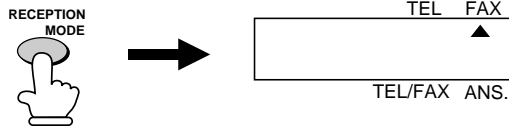

Blocking Reception of Unwanted Faxes

The Anti Junk Fax function allows you to block reception of faxes from parties which you specify. This saves paper by not printing out unwanted "junk" faxes.

To use this function, first turn it on by setting Option Setting 15 to YES as described in Chapter 8, and then enter the fax numbers from which you do not want to receive faxes as shown below.

Comments:

- Up to 5 numbers can be entered in the Anti Junk Number List.
- The Anti Junk function will not operate for a number which has also been stored as a Priority Call number.
- To clear a number from the Anti Junk Number List, you need to know the 1-digit number which identifies it. If you have forgotten this number, print out the Anti Junk Number List as described in Chapter 10.

-
- 1** Press the keys shown at right.
STORE JUNK # will appear in the display.

FUNCTION



-
- 2** Press **1** to store a number in the Anti Junk Number List, or **2** to clear a number from the list.



or



-
- 3** **Storing:** Enter a 1-digit number from 1 to 5. This number identifies the fax/voice number you will store in the next step.



Clearing: Enter the number which identifies the fax/voice number you want to clear, and go to Step 5.

(Example)

Blocking Reception of Unwanted Faxes

- 4** Enter the full number you want to block
(max. of 20 digits).



(Example)

-
- 5** Press the **START** key.



-
- 6** Return to Step 3 to enter (or clear)
another number, or press **STOP** to exit.

Step 3 or



Polling (Requesting a Fax Transmission)

Polling allows you to call another fax machine and have it send a document (previously loaded in its feeder) to your machine without operator assistance. In other words, the receiving fax machine, not the transmitting fax machine, initiates the transmission. You can use your machine to both poll and be polled by others.

To use the polling function, you must first set Rapid Key 10/POLL for use as a polling key. This is done by changing Option Setting 16, as described in Chapter 8, *Option Settings*. (Note that when Rapid Key 10/POLL is set as a polling key, it cannot be used for Rapid Key Dialling.)

Requesting transmission

Note: Rapid Dial Keys cannot be used for polling. To dial a Rapid Dial location, press the **SPEED DIAL** key and then enter the 2-digit number corresponding to the Rapid Key.

1 Dial the fax machine you want to poll using one of the following methods:

- Pick up the handset (or press the **SPEAKER** key) and dial the full number. Wait for the fax answerback tone.
- Press the **SPEED DIAL** key and enter a 2-digit Speed Dial number.
- Enter the full number using the numeric keys.

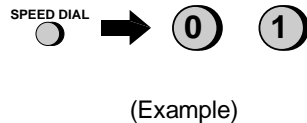

2 Press Rapid Key 10/POLL.

- If you used the handset, replace it when **POLLING** appears in the display. Reception will begin.

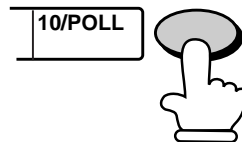

Turnaround polling

After polling a fax machine, you can send a document to that machine on the same connection. Simply place the document to be sent in the feeder and follow the steps described above in "Requesting transmission". When polling is finished, the document will be automatically transmitted.

- ◆ The other fax machine must also have Turnaround Polling capability.
- ◆ Turnaround Polling cannot be performed when a timer transmission operation is set.

Being polled (polling standby)

To let another fax machine poll your machine, simply set the reception mode to FAX, and load the document(s) to be sent.

Transmission will take place when the other fax machine calls your machine and activates polling. Automatic reception is possible whilst your fax is on polling standby.

Polling security

Polling Security allows you to prevent unauthorized polling of your machine. When this function is turned on, polling will only take place when the fax number of the polling fax machine has been entered in your machine's list of permitted fax numbers (called "passcode numbers"). The number of the polling fax must also be correctly programmed into itself for identification.

To use Polling Security, follow the steps below to turn the function on, and then enter permitted numbers as shown on the following page.

1 Press the keys shown at right.
ENTRY MODE will appear in the display.





2 Press the # key three times.
SECURITY SELECT will appear in the display.



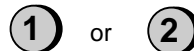

3 Press **1** to turn polling security on, or **2** to turn it off.









- 4** Press the **START** key and then the **STOP** key.
- 
- 



Storing and clearing fax numbers for polling permission







You can store up to 10 fax numbers in your machine's list of permitted numbers.

- 1** Press the keys shown at right. ENTRY MODE will appear in the display.
- 
- 

- 2** Press the # key four times. PASSCODE # MODE will appear in the display.
- 
- 
- 
- 

- 3** Press **1** to store a number, or **2** to clear a number.
- 
- or
- 

- 4** **Storing:** Enter a 2-digit number from 01 to 10. This number identifies the fax number you will store in the next step.
Clearing: Enter the number which identifies the fax number you want to clear, and go to Step 6.
- 
- 
- (Example)

- 5** Enter the fax number (max. of 20 digits).
- 
- 
- 
- 
- 
- 
- 
- (Example)

- 6** Press the **START** key.
- 

- 7** Return to Step 4 to enter (or clear) another number, or press **STOP** to exit. **Step 4** or
- 











Timer Operations

The Timer function allows you to set a transmission and/or polling operation to be performed automatically at a time you specify. One transmission operation and one polling operation can be set at the same time, and the times they will be performed can be specified up to 24 hours in advance.

As an example, you can use this function to take advantage of off-peak telephone rates without having to be there when the operation is performed.

Note: Only a Speed Dial number can be used to dial the receiving machine.

Setting a timer operation

-
- 1** Press the keys shown at right.
TIMER MODE will appear in the display.
- FUNCTION  
-
- 2** Press # to set a transmission operation (SEND MODE), or * to set a polling operation (POLLING MODE).
-  or 
-
- 3** Press 1 to select SET.
- 
-
- 4** Enter the time at which you want the operation to take place in 24-hour format (2 digits for the hour and 2 digits for the minute).
-    
- Example: 9:25
-
- 5** Press the **START** key.
- START 

- 6** Enter the Speed Dial number of the receiving fax machine.
- If this is a polling operation, go to Step 9.

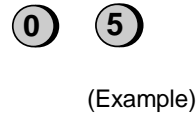

- 7** Press the **START** key.

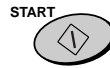

- 8** Adjust the resolution and/or contrast if desired (skip to the next step if you don't want to change settings).



- 9** Press the **START** key and then the **STOP** key. If this is a transmission operation, load the document in the feeder sometime before the specified time of transmission.

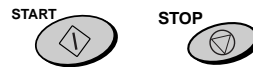

To cancel an operation

If you need to cancel an operation after it has been set, follow the steps below.

- 1** Press the keys shown at right. **TIMER MODE** will appear in the display.



- 2** Press **#** to cancel a transmission operation, or ***** to cancel a polling operation.

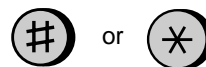

- 3** Press **2** to select **CLEAR**.



- 4** Press the **START** key and then the **STOP** key.



Option Settings

The option settings let you customise your fax to better suit your needs. An initial setting has been made for each option at the factory. You can change a setting by following the steps described for each option below.

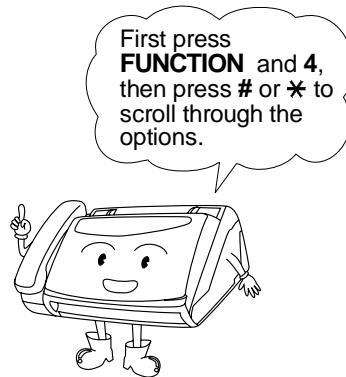
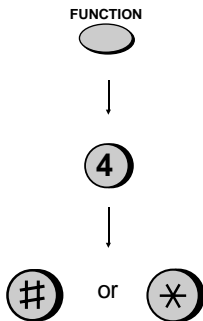

Setting 1: FINE RESOLUTION PRIORITY

This option sets the default resolution (the resolution used if a setting is not made with the **RESOLUTION** key) for transmitting documents. Press **1** (YES) to set the default resolution to FINE, or **2** (NO) to set it to STANDARD.

- Initial setting: 2

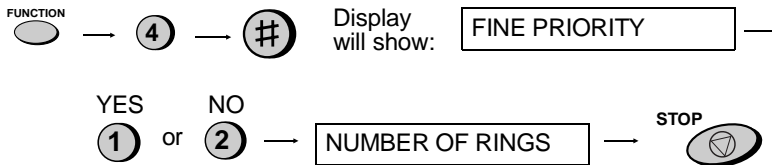

Setting 2: NUMBER OF RINGS TO ANSWER

This sets the number of rings the fax machine waits before answering an incoming call in FAX and TEL/FAX reception modes. Enter any number from 2 to 4.

- Initial setting: 2



Setting 3: 4 RINGS TEL ANSWER

Press **1** (YES) to have the machine answer a call after 4 rings when it is in TEL reception mode. Press **2** (NO) to turn the function off.

- Initial setting: **2**

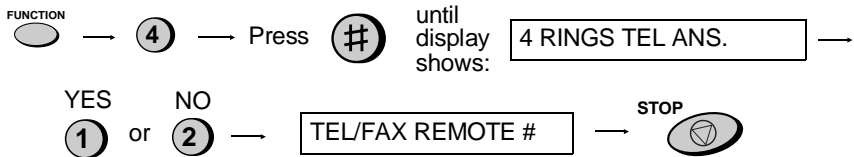
**Setting 4: TEL/FAX REMOTE NUMBER (TRANSFER CODE)**

If you hear a fax tone when you answer a call on a tone dial extension phone connected to the same line as the fax, you can make the fax begin reception by pressing **5**, *****, and ***** on the phone. Use this setting if you want to use a number other than **5** to begin fax reception. You can enter any number from **0** to **9**.

- Initial setting: **5**

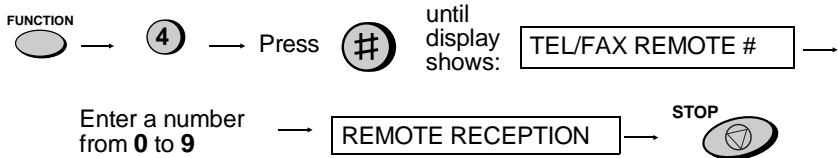
**Setting 5: REMOTE RECEPTION SELECT**

If you don't intend to use the above TEL/FAX REMOTE NUMBER, you can turn detection of the number off. This will ensure that the fax never mistakenly attempts to begin reception if it detects a signal similar to the TEL/FAX REMOTE NUMBER while you are talking on an extension phone. Press **1** to turn detection on, or **2** to turn detection off.

- Initial setting: **1**



Setting 6: TRANSACTION REPORT PRINT SELECT

This sets the condition for printing out a Transaction Report. Enter a number from **1** to **4** as follows:

- 1 (ALWAYS PRINT):** A report will be printed after each transmission, reception, or error.
- 2 (ERR/TMR PRINT):** A report will be printed after an error or a timer operation.
- 3 (SEND ONLY):** A report will be printed only after a transmission.
- 4 (NEVER PRINT):** A report will never be printed.

• Initial setting: **2**

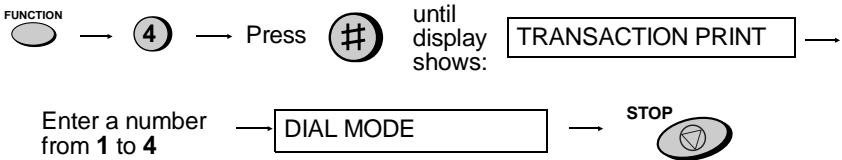

Setting 7: DIAL MODE

This sets the mode of dialling. Press **1** if you are on a tone dial line, or **2** if you are on a pulse dial line.

• Initial setting: **1**



Note: For all units installed in New Zealand, select "1" for tone dialling. The pulse setting "2" will not operate correctly and must not be used.

Setting 8: PSEUDO RINGING DURATION

This sets the duration of pseudo ringing in TEL/FAX reception mode. Press **1** for 15 seconds or **2** for 30 seconds.

• Initial setting: **1**

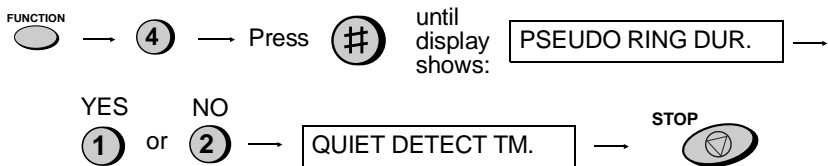

Setting 9: QUIET DETECT TIME

When an answering machine is connected to the fax, the fax will take over the line and begin reception if it detects a certain duration of silence after the answering machine answers a call. This sets the duration of silence (in seconds). Enter a number from **01** to **10**, or enter **00** to turn off the function.

- Initial setting: **04**

**Setting 10: FAX RX A.M. FAILS**

Press **1** (YES) to have the fax answer a call if an answering machine connected to the fax does not answer within 5 rings. Press **2** (NO) to turn the function off.

- Initial setting: **2**

**Setting 11: PAPER SAVE**

This reduces the vertical length of documents received, allowing you to save paper. Enter a number from **1** to **3** as follows ("S" will appear highlighted in the display while Paper Save is turned on and a document is being sent or received):

- 1** (MODE 1): Reduce only the white spaces between lines.
- 2** (MODE 2): Reduce the entire document by 50% (only when standard resolution is used).
- 3** (NO): No Paper Save.

- Initial setting: **3**



Setting 12: TIME SAVE

This reduces the vertical length of documents transmitted by 20%, saving line time and thereby allowing you to reduce telephone costs. Press **1** to turn the function on, or **2** to turn it off. ("T" will appear highlighted in the display while Time Save is turned on and a document is being sent or received):

- Initial setting: **2**

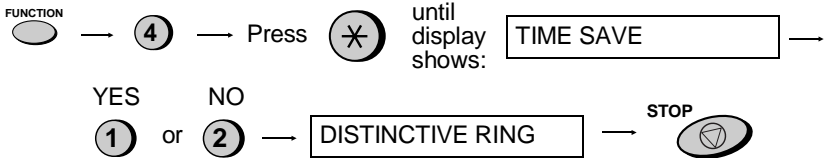

Setting 13: DISTINCTIVE RING

If you subscribe to a distinctive ring service from your telephone company, press **1** to have your fax signal voice calls and fax transmissions by different ring patterns. Press **2** to turn the function off. (This setting is described in more detail in *Distinctive Ring* in Chapter 7.)

- Initial setting: **2**



Setting 14: FAX SIGNAL RECEIVE

Your fax is will automatically begin reception if you hear a high-pitched fax tone after answering a call. If you use a computer fax modem on the same line, you must turn this function off in order to prevent your fax from mistakenly attempting to receive documents sent from the computer fax modem. Press **1** to turn the function on, or **2** to turn it off.

- Initial setting: **1**



Setting 15: JUNK NUMBER CHECK

Press **1** to prevent reception from fax numbers entered in the Anti Junk Number List. Press **2** to allow reception from all numbers.

- Initial setting: **2**

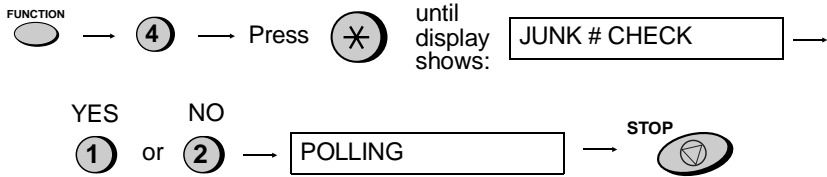
**Setting 16: POLLING**

Press **1** if you want to use Rapid Key 10/POLL as a polling key. Press **2** if you want to use it as a regular Rapid Key.

- Initial setting: **2**

**Setting 17: CALLER ID**

If you subscribe to a caller ID service and want to use the Caller ID function, press **1**. To turn Caller ID off, press **2**. (Caller ID is explained in more detail in *Caller ID* in Chapter 7.)

- Initial setting: **2**

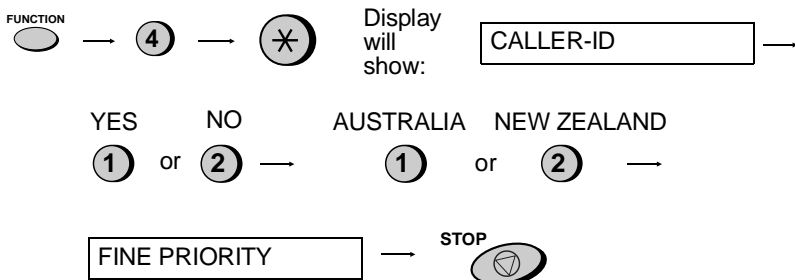

Printing Reports and Lists

You can print out lists showing settings and information entered in the fax. You can also have the fax automatically print out a report on transactions after they are made. The lists and the report are described below.

Printing a list

- 1 Press these keys:



The display will show:

LISTING MODE

- 2 Press the # key or the * key until the desired list appears in the display.

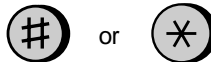

- 3 Press the **START** key.

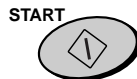

Timer list

This list shows the timer operations which are currently set.

TIMER LIST		25-JAN-1998 10:30
FOR: John Doe Corp.		201 555 1234
<hr/>		
TIMER SEND		
START	09:28	
RECEIVER	ABO TOOL	
RESOLUTION	FINE	:AUTO
<hr/>		
TIMER POLLING		
START	11:30	
SENDER	JACK JONES	
<hr/>		

Telephone Number List

This list shows the fax and voice numbers which have been stored for automatic dialling.

TELEPHONE NUMBER LIST		
FOR: John Doe Corp.		25-JAN-1998 10:30 201 555 1234
SPEED NO.	NAME	TELEPHONE NO.
01	N. Y.	123-785-8340
02	JANE SMITH	258-942-7417
03	ABC TOOL	965-125-0546
04	JACK JONES	532-740-3341

Passcode List

This list shows settings made for polling security, your name and fax/telephone number as entered in the machine, and a sample of the header printed at the top of every page you transmit (**HEADER PRINT**).

PASSCODE LIST	
FOR: John Doe Corp.	25-JAN-1998 10:30 201 555 1234
POLLING MODE	SECURITY OFF
PASSCODE NO.	01 12345678901234567890
	02 9999540885
	03 1111111111
	04
	05
	06
	07
	08
	09
	10
PRIORITY CALL NO.	5558858870
SENDER'S NAME	John Doe Corp.
SENDER'S TELEPHONE NUMBER	201 555 1234
HEADER PRINT	
25-JAN-1998 10:30	John Doe Corp. 201 555 1234 P.01

Option Setting List

This list shows the current status of the option settings.

OPTIONS SETTING LIST		
FOR: FOR: John Doe Corp.		28-MAY-1998 17:14 201 555 1234
NO.	ITEM	SETTING
1	FINE PRIORITY	NO
2	NUMBER OF RINGS IN AUTO ANSWER MODE	2 RINGS
3	4 RINGS TEL ANSWER	NO
4	TEL/FAX REMOTE NO.	(5)**
5	REMOTE RECEPTION	YES
6	TRANSACTION PRINT SELECT	ERROR/TIMER PRINT
7	DIAL MODE	TONE
8	PSEUDO RINGING DURATION	15S
9	QUIET DETECT TIME	04 SECONDS
10	FAX ANSWER WHEN ANS. FAILS	NO
11	PAPER SAVE	NO
12	TIME SAVE	NO
13	DISTINCTIVE RINGING	NO
14	FAX SIGNAL RECEIVE	YES
15	JUNK NO. CHECK	NO
16	POLLING	NO
17	CALLER-ID	NO

Anti Junk Number List

This list shows the numbers that are blocked by the Anti Junk function.

ANTI JUNK NUMBER LIST	
FOR: John Doe Corp. 25-JAN-1998 10:30 201 555 1234	
ANTI JUNK NO. CHECK : NO	
STORED LOCATION	JUNK TEL NO.
1	1234567890
2	11122233344455566677
3	123987093667

Caller ID List

This list shows information about your most recent unanswered calls (maximum of 20 calls). (This list is only available if you are using the Caller ID function.)

CALLER-ID LIST				
AREA CODE: 123			25-JAN-1998 10:30	
FOR: John Doe Corp.			201 555 1234	
NO.	DATE	RX TIME	NAME	TELEPHONE NO. MODE
01	25-JAN	09:38	JONES JENNIFER	111-111-1111 FAX
02	25-JAN	09:48	SMITH SHARON	333-333-3333 FAX
03	25-JAN	09:50	MACDONALD MIKE	222-222-2222 TEL

Transaction Report

This report is printed out automatically after an operation is performed to allow you to check the result. Your fax is set at the factory to print out the report after a timer operation or when an error occurs. If desired, you can change the setting to have it printed out under a variety of other conditions. This is done by changing Option Setting 6 as described in Chapter 8.

- ◆ The Transaction report cannot be printed out manually.

```

XXXXXXXXXXXXXXXXXXXXXXXXXXXXXXXXXXXXXXXXXXXXXXXXXXXXXXXXXXXXXXXXXXXX
X
X                      TRANSACTION REPORT                      X
X
X                      FOR: John Doe Corp.                      X
X                      201 555 1234                            X
X-----X
X   TIMER SEND          (RESERVED TIME 10:30)                  X
X
X   DATE  START  RECEIVER  PAGES  TIME  NOTE                  X
X-----X-----X-----X-----X-----X-----X-----X-----X
X   25-JAN 10:30  JACK JONES  0    XX'XX"  CANCEL              X
X-----X-----X-----X-----X-----X-----X-----X-----X
XXXXXXXXXXXXXXXXXXXXXXXXXXXXXXXXXXXXXXXXXXXXXXXXXXXXXXXXXXXXXXXXXXXX
    
```

Explanation of headings

SENDER/RECEIVER The fax number of the other machine involved in the transaction. In the case of a transmission, the number dialled appears. In the case of a reception, the programmed ID of the sending machine appears. If this machine does not have an ID function, the communication mode will appear (for example, "G3").

PAGES Number of pages transmitted or received.

NOTE **OK** - Transmission/reception was normal.

P.FAIL - A power failure occurred. If you have power and the problem persists, try a different outlet. If necessary, have an electrician check your power lines.

JAM - A problem with the paper or original document occurred. Make sure the paper or document is loaded properly. Make sure the operation panel is shut securely.

NO PAPER - You ran out of paper during reception.

COME-0 to COME-7 - A telephone line error prevented the transaction. See *Line Error in Problems and Solutions* in Chapter 11.

CANCEL - Transmission was cancelled because the **STOP** key was pressed, no document was in the feeder, or the other machine requested transmission using a function which your fax does not have. If you were attempting to fax, make sure a document is in the feeder. If you were receiving, contact the faxing party to see how they are trying to send to you.

Fax print head

Clean the print head frequently to ensure optimum printing performance. To clean the print head, first disconnect the telephone line, then unplug the power lead, open the operation panel (pull the release marked **PANEL RELEASE** toward you), and remove the fax paper.

Wipe the print head with a soft cloth dampened with denatured alcohol.

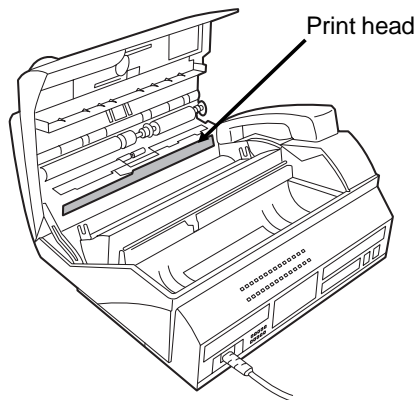
**Caution!**

- Do not use benzene or thinner. Avoid touching the print head with hard objects.
- The print head may be hot if your fax machine has just received a large number of documents. If this is the case, allow the print head to cool prior to cleaning.

Scanning glass and rollers

Clean the scanning glass and rollers frequently to ensure the quality of transmitted images and copies. Open the operation panel (pull the release marked **PANEL RELEASE** toward you), and wipe the scanning glass and rollers with a soft cloth.

- ◆ Make sure that all dirt and stains (such as correcting fluid) are removed, as dirt and stains will cause vertical lines on transmitted images and copies.
- ◆ Adhesive cellophane tape is useful for removal of debris from the rollers.

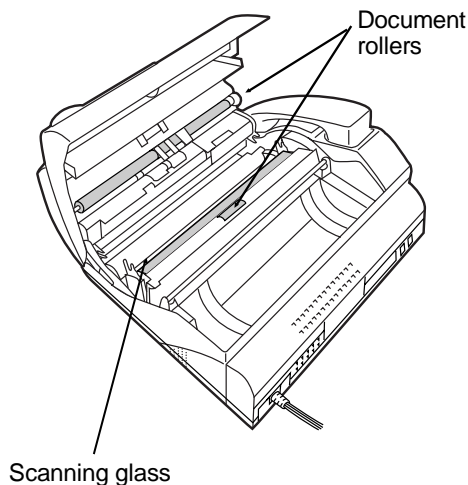

The housing

Wipe the external parts and surface of the machine with a dry cloth.

Caution!

- Do not use benzene or thinner. These solvents may damage or discolour the machine.

Problems and Solutions

If you have any problems with your fax, refer to the following troubleshooting guide.

Answering machine hookup

Problem	Check and remedy
The answering machine hookup does not operate properly.	<ul style="list-style-type: none">• Make sure your fax machine's reception mode is set to ANS.• Make sure your fax machine's TEL. LINE socket is connected to the wall socket. Make sure your fax machine's TEL. SET socket is connected to your answering machine's telephone line socket (not the answering machine's extension phone socket).• Make sure your answering machine's outgoing message is under 10 seconds.• Make sure that Option Setting 9 (Quiet Detect Time) is set to three or four seconds (see Chapter 8).• Make sure that the Distinctive Ring function is set to OFF SETTING (see <i>Distinctive Ring</i> in Chapter 7).

Line error

Problem	Check and remedy
<p>LINE ERROR appears in the display and/or a transaction report is printed out with COM. E-1, 2, 3, 4, 5, 6, or 7 in the NOTE column.</p>	<ul style="list-style-type: none"> • Try the transaction again. If the error persists, check the following: • Check the hookup. The cord from the TEL. LINE jack to the wall jack should be no longer than six feet. • Make sure there are no modem devices sharing the same telephone line. • Check with the other party to make sure their fax machine is functioning properly. • Have your telephone line checked for line noise. • Try connecting your fax to a different telephone line. • If the problem still occurs, your fax machine may need service.

Dialing and transmission problems

Problem	Check and remedy
<p>No dial tone when you pick up the handset or press the SPEAKER key.</p>	<ul style="list-style-type: none"> • Make sure the handset cord is connected to the correct jack. See <i>Handset</i> in <i>Connections</i> in Chapter 1.
<p>Dialing is not possible.</p>	<ul style="list-style-type: none"> • Make sure the power cord is properly plugged into a power outlet. • Make sure that the telephone line is properly connected to both the TEL. LINE jack and the wall jack. • Make sure that the fax is set to the correct dialing mode for your telephone line. See Option Setting 7 in Chapter 8.

Problems and Solutions

<p>The power is on, but no transmission takes place.</p>	<ul style="list-style-type: none"> ● Make sure that the receiving machine has fax paper. ● Make sure that the telephone line cord is plugged into the TEL. LINE jack, and not the TEL. SET jack. ● If the receiving machine is in manual mode with no attendant, reception will not be possible. ● If the receiving machine is not a Sharp model, make sure it is G3 compatible. ● Check the display for error messages.
<p>Nothing is printed at the receiving end.</p>	<ul style="list-style-type: none"> ● Pick up the handset and check for a dial tone. ● Make sure that the document for transmission is placed face down in the feeder. ● Make sure that the fax paper is properly loaded in the receiving machine.
<p>A distorted image is received at the other end.</p>	<ul style="list-style-type: none"> ● Noise on the telephone line may cause distortion. Try sending the document again. ● Make a copy of the document on your fax. If the copy is also distorted, your fax may need servicing.

Reception and copying problems

<p>Problem</p>	<p>Check and remedy</p>
<p>The fax machine doesn't receive documents automatically.</p>	<ul style="list-style-type: none"> ● Make sure that the reception mode is set to FAX. If you subscribe to a distinctive ring service, make sure that the Distinctive Ring function is set to the correct ring pattern. If you do not subscribe to a distinctive ring service, make sure that Distinctive Ring is set to OFF SETTING. (See <i>Distinctive Ring</i> in Chapter 7.)
<p>The power is on, but no reception takes place.</p>	<ul style="list-style-type: none"> ● Make sure that the wall jack is connected to the TEL. LINE jack, and not the TEL. SET jack.
<p>The fax paper does not come out.</p>	<ul style="list-style-type: none"> ● The fax paper may be jammed. See <i>Clearing Paper Jams</i> in this chapter.

<p>The fax paper comes out blank when you try to receive or copy a document.</p>	<ul style="list-style-type: none"> • Make sure that the fax paper is properly loaded in your fax. (If the roll has been loaded backwards, nothing will be printed.) • For reception, make sure that the document for transmission is loaded face down in the feeder of the transmitting machine.
<p>The received document is faint.</p>	<ul style="list-style-type: none"> • Make sure that you are using the recommended fax paper. See <i>Loading the Fax Paper</i> in Chapter 1. • Ask the other party to send higher contrast documents. If the contrast is still too low, your fax may have a problem. Make a copy to check it.
<p>Received images are distorted.</p>	<ul style="list-style-type: none"> • Noise on the telephone line may cause distortion. Have the other party try sending the document again. • The print head may be dirty. See <i>Fax print head</i> in Chapter 10. • Make a copy of another document on your fax. If the copy is also distorted, your fax may need servicing.
<p>Copies are distorted.</p>	<ul style="list-style-type: none"> • Make sure that you are using the recommended fax paper. See <i>Loading the Fax Paper</i> in Chapter 1. • Make sure that the fax paper is properly loaded in your machine. • The print head may be dirty. See <i>Fax print head</i> in Chapter 10.
<p>Reception/copying is interrupted.</p>	<ul style="list-style-type: none"> • If reception or copying has been done continuously for a long time, the print head may have become overheated. Turn off the power and let it cool down.
<p>A received document or copy prints out in strips.</p>	<ul style="list-style-type: none"> • Make sure the operation panel is completely closed (press down on both sides).

General problems

Problem	Check and remedy
Nothing appears in the display.	<ul style="list-style-type: none"> • Make sure the power cord is properly plugged into a power outlet. • Connect another electrical appliance to the outlet to see if it has power.
The fax does not respond when you press any of its keys.	<ul style="list-style-type: none"> • If a beep sound is not made when you press the keys, unplug the power cord and then plug it back in several seconds later.
Automatic document feeding does not work for transmission or copying.	<ul style="list-style-type: none"> • Check the size and weight of the document (see <i>Transmittable documents</i> in Chapter 2).
Voice calls taken on an extension phone are interrupted by the fax.	<ul style="list-style-type: none"> • The fax may interrupt during a voice call if the reception mode is set to ANS. To prevent interruption on a touch-tone extension phone, press any three keys on the extension phone after answering. (Note: Do not enter the code to activate fax reception.)
No reception occurs when polling is attempted.	<ul style="list-style-type: none"> • Make sure you have not run out of fax paper. • Make sure the transmitting machine is in automatic reception mode. • If the transmitting machine has polling security, make sure that your fax number has been entered both in your fax and in the transmitting machine.
Bell Tinkle (New Zealand)	<ul style="list-style-type: none"> • The operation of this equipment on the same line as the telephone or other equipment with audible warning devices or automatic ring detectors will give rise to bell tinkle or noise and may cause false tripping of the ring detector. Should such a problem occur, contact your authorised Sharp Service Centre for information.

Messages and Signals

Display messages

Note: If you have turned on the Caller ID function, see *Caller ID* in Chapter 7 for display messages related to Caller ID.

DOCUMENT JAMMED	The original document is jammed. See the following section, <i>Clearing Paper Jams</i> .
FUNCTION MODE	The FUNCTION key has been pressed.
HOLD	The HOLD/SEARCH key has been pressed to put the other party on hold during a phone conversation. Press the HOLD/SEARCH again to take the other party off hold.
LINE ERROR	Transmission or reception was not successful. Press STOP to clear the message, and then try again. If the error persists, see <i>Line Error</i> in <i>Problems and Solutions</i> in this chapter.
NO DATA	This appears if you attempt to search for an automatic dialling number when none have been stored.
NO # STORED	You have tried to dial or clear a Rapid Key or Speed Dial number that hasn't been programmed (a full number hasn't been assigned to it).
OUT OF PAPER	You have run out of fax paper. Load a new roll of fax paper as explained in <i>Loading the Fax Paper</i> in Chapter 1.
ON HOOK DIAL	The SPEAKER key has been pressed and the fax is waiting for you to dial. (To return to the date and time display, press the SPEAKER key again.)
OVER HEAT	The print head has overheated. Operation may be continued once it cools.

Display Messages

PAPER JAMMED	The fax paper is jammed. See the following section, <i>Clearing Paper Jams</i> . (FO-375 only)
READY TO SEND	A document has been loaded and the fax is waiting for transmission or copying instructions.
RECALLING	This appears if you attempt to send a fax by automatic dialling and the line is busy or the receiving fax machine does not answer. Your fax machine will automatically reattempt the call. (See <i>Automatic Redialling in Sending a Fax by Automatic Dialling</i> in Chapter 2.)
SEARCH DIAL	The HOLD/SEARCH key has been pressed. Press # or * to search for an automatic dialling number, or press STOP to return to the data and time display. (See <i>Using the HOLD/SEARCH key in Sending a Fax by Automatic Dialling</i> in Chapter 2.)
TOTAL PAGE(S) 01	Number of pages transmitted, received, or copied.

Audible signals

Continuous tone	3 seconds	Indicates the end of transmission, reception, or copying.
Intermittent tone (3 beeps)	5 seconds (1 second on, 1 second off)	Indicates incomplete transmission, reception, or copying.
Rapid intermittent tone	35 seconds (0.7 seconds on, 0.3 seconds off)	Indicates that the handset is off hook.

Clearing Paper Jams

Clearing a jammed document

If the original document doesn't feed properly during transmission or copying, or DOCUMENT JAMMED appears in the display, first try pressing the **START** key. If it doesn't feed out, remove it as follows:

Important:

Do not try to remove a document without opening the operation panel. This may damage the feeder mechanism.

- 1 Pull the release marked **PANEL RELEASE** toward you and open the operation panel.

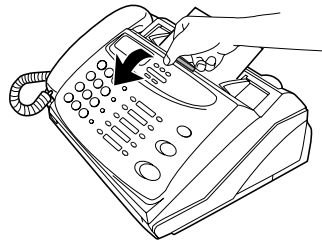

- 2 Remove the document.

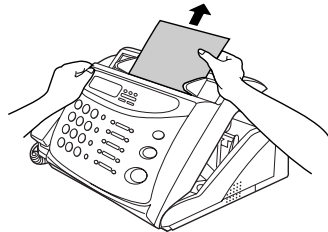

Clearing jammed fax paper

- 1 Pull the release marked **PANEL RELEASE** toward you and open the operation panel.

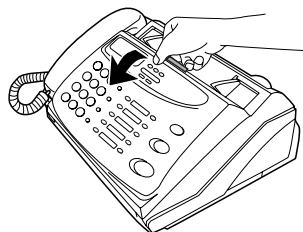

2 Remove the paper roll.

- **FO-375:** If any pieces of paper are stuck in the cutter, remove them with caution.
- **FO-375:** Press the **START** key to reset the cutter.

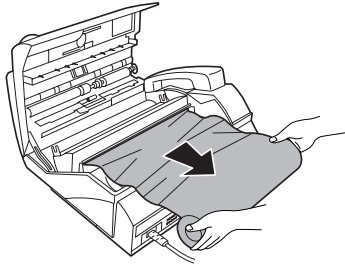

3 Cut off the wrinkled part of the paper.

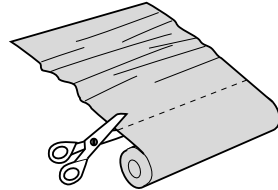

4 Reload the paper.

- Jammed fax paper is often caused by improper loading. Be sure to carefully follow the instructions for paper loading given in *Loading the Fax Paper* in Chapter 1.

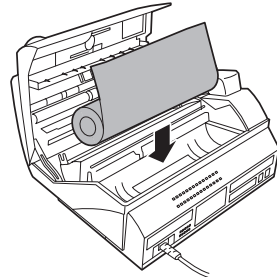

If the display still shows PAPER JAMMED (FO-375 only)

If the display still shows PAPER JAMMED after you press the **START** key in Step 2 above, the cutter is still engaged in the cutting position. To open the cutter, turn the fax up on its rear end and insert any long, rod-like object with a flat or blunt end into the hole marked **CUTTER RESET**. Continue to push the rod in until you feel it move a lever inside the machine.

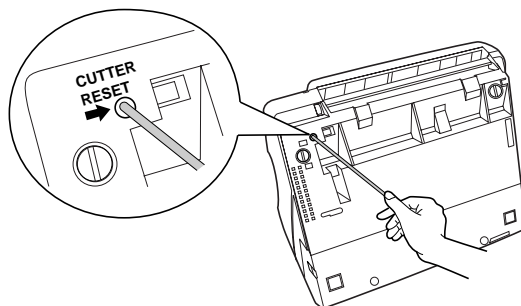

Index

A

- ANS. reception mode, 18, 39, 47
- Answering machine connection
 - Activating, 47
 - Connecting, 45
 - Fax Reception When Ans. Fails, 65
 - Quiet Detect Time, 65
 - Troubleshooting, 74
- Anti junk fax, 55
- Anti Junk Fax (Anti Junk Number), 67
- Anti Junk Number List, 70
- Audible signals, 80
- Automatic dialling, 33
- Automatic dialling, storing numbers, 30

C

- Caller ID, 48
- Caller ID List, 50
- Chain Dialling, 44
- Cleaning, 72 - 73
- Contrast, 25
- Copies, 42
- Copy/Help key, 3, 42

D

- Date, setting, 16
- Dial mode, 64
- Dialling
 - Direct Keypad, 35
 - Normal, 27, 43
 - Rapid Key, 33, 43
 - Search, 36, 44
 - Speed, 34, 43
- Direct Keypad Dialling, 35
- Display, 2
- Display messages, 79
- Distinctive Ring, 53
- Document feeder, 23
- Document guides, 23
- Document restrictions, 22

- Document rollers, 73
- Document sizes, 21
- Document, maximum scanning size, 22
- Down key, 19

E

- Extension telephone
 - Connecting, 8
 - Using, 41

F

- Fax Ability (Distinctive Ring), 53
- Fax Duet (Distinctive Ring), 53
- Fax paper
 - Loading, 9
 - Replacing, 12
- FAX reception mode, 18, 39
- Fax Signal Receive, 66
- Fine Resolution Priority, 62
- Four rings TEL answer, 63
- Function key, 2

H

- Halftone, 25
- Handset, 5
- Hold, 44
- Hold/Search key, 3, 44
- Housing, cleaning, 73

J

- Jams, clearing, 81
- Junk Number Check, 67

L

- Letters, entering, 15
- Line error, 75
- Loading the document, 23

N

Normal Dialling, 27, 43
Number keys, 3
Number of rings in FAX and TEL/FAX reception modes, 62

O

Option Setting List, 70

P

Panel release, 2
Paper jams, clearing, 81
Paper Save setting, 65
Paper, fax, 9
Passcode List, 69
Pauses in automatic dialling, 30, 35
Polling, 57 - 59
Polling key, setting, 67
Print head, cleaning, 72
Priority Call, 51
Pseudo ringing duration, 64

R

Rapid Dial keys, 3
Rapid Key Dialling, 33, 43
Reception mode
 ANS. mode, 18, 39, 47
 FAX mode, 18, 39
 Setting, 18
 TEL mode, 18, 40
 TEL/FAX mode, 18, 38
Reception mode key, 2, 18
Redial key, 3, 28, 44
Redialling, 37, 44
Remote Reception Select, 63
Removing original document, 24
Resolution, 25
Resolution key, 3

Ringing volume, 20
Rollers, cleaning, 73

S

Scanning glass, cleaning, 73
Search Dialling, 36, 44
Sender's name and number, entering, 13
Speaker key, 3, 19, 27, 43
Speaker volume, 19
Speed Dial key, 3, 34, 43
Speed Dialling, 34, 43
Start key, 3
Stop key, 3

T

TEL reception mode, 18, 40
TEL. LINE socket, 7
TEL. SET socket, 8, 45
TEL/FAX reception mode, 18, 38
Tel/Fax Remote Number, 63
Telephone Number List, 69
Telephone, using as, 43
Time Save setting, 66
Time, setting, 16
Timer List, 68
Timer operations, 60
Transaction Report, 71
Transaction Report Print Select, 64

U

Up key, 19

V

Volume keys, 19

SHARP®

SHARP CORPORATION OF AUSTRALIA PTY.LTD.

A.C.N. 003 039 405

1 Huntingwood Drive, Huntingwood, Blacktown, N.S.W., 2148

SHARP CORPORATION OF NEW ZEALAND LIMITED.

**Cnr Mahunga Drive & Hastie Ave. Mangere Bridge, Auckland
New Zealand**

SHARP CORPORATION

Free Manuals Download Website

<http://myh66.com>

<http://usermanuals.us>

<http://www.somanuals.com>

<http://www.4manuals.cc>

<http://www.manual-lib.com>

<http://www.404manual.com>

<http://www.luxmanual.com>

<http://aubethermostatmanual.com>

Golf course search by state

<http://golfingnear.com>

Email search by domain

<http://emailbydomain.com>

Auto manuals search

<http://auto.somanuals.com>

TV manuals search

<http://tv.somanuals.com>