

# SHARP®

MODEL

**FO-4650**  
**FO-4970**

**FACSIMILE**

OPERATION MANUAL



1. Installation
2. Sending Documents
3. Receiving Documents
4. Making Copies
5. Special Functions
6. Option Settings
7. Printing Reports and Lists
8. Maintenance
9. Troubleshooting

**WARNING** - FCC Regulations state that any unauthorized changes or modifications to this equipment not expressly approved by the manufacturer could void the user's authority to operate this equipment.

**Note:** This equipment has been tested and found to comply with the limits for a Class B digital device, pursuant to Part 15 of the FCC Rules. These limits are designed to provide reasonable protection against harmful interference in a residential installation. This equipment generates, uses and can radiate radio frequency energy and, if not installed and used in accordance with the instructions, may cause harmful interference to radio communications. However, there is no guarantee that interference will not occur in a particular installation. If this equipment does cause harmful interference to radio or television reception, which can be determined by turning the equipment off and on, the user is encouraged to try to correct the interference by one or more of the following measures:

- Reorient or relocate the receiving antenna.
- Increase the separation between the equipment and the receiver.
- Connect the equipment into an outlet on a circuit different from that to which the receiver is connected.
- Consult the dealer or an experienced radio/TV technician for help.

#### **ABOUT THE TELEPHONE CONSUMER PROTECTION ACT OF 1991**

"The Telephone Consumer Protection Act of 1991 makes it unlawful for any person to use a computer or other electronic device to send any message via a telephone facsimile machine unless such message clearly contains in a margin at the top or bottom of each transmitted page or on the first page of the transmission the following information:

- (1) The date and time of transmission.
- (2) Identification of either the business, business entity or individual sending the message.
- (3) Telephone number of either the sending machine, business, business entity or individual.

In order to program this information into your facsimile machine, please refer to the appropriate instructions in the operation manual."













As an ENERGY STAR® partner, SHARP has determined that this product meets the ENERGY STAR® guidelines for energy efficiency.

# QUICK REFERENCE GUIDE

*Note: Steps which are optional are enclosed in a dotted frame:*



## Transmitting documents











<b>Normal Dialing</b>	Load document → press <b>SPEAKER</b> →  → Dial (press numeric keys) → Wait for reception tone → 
<b>Direct Keypad Dialing</b>	Load document →  → Dial (press numeric keys) → 
<b>Rapid Key Dialing</b>	Load document →  → Press Rapid Key
<b>Speed Dialing</b>	Load document →  →  → Enter Speed Dial number (press numeric keys, - if less than 3 digits, press <b>START</b> to complete entry) → 
<b>Redialing</b>	Load document →  →  → Wait for reception tone → 

# — GUIA DE CONSULTA RAPIDA —

*Nota: El marco punteado significa que el procedimiento puede ser opcional.*



## Transmisión de documentos

<b>Marcación normal</b>	<p>Colocar el documento → pulse <b>SPEAKER</b> →  → Marque (pulse teclas numéricas)</p> <p>→ Espere el tono recepción → </p>
<b>Marcación directa con el teclado</b>	<p>Colocar el documento →  → Marque (pulse teclas numéricas) → </p>
<b>Marcación con Teclas Rápidas</b>	<p>Colocar el documento →  → Pulse la Tecla Rápida</p>
<b>Marcación Veloz</b>	<p>Colocar el documento →  →  → Introduzca el número de discado r pido (presione las teclas numéricas, si fueran menos de 3 digitos, para completar el procedimiento presione <b>START.</b>)</p> <p>→ </p>
<b>Remarcación</b>	<p>Colocar el documento →  →  → Espere el tono recepción → </p>

---

# Introduction

Welcome, and thank you for choosing a Sharp facsimile machine! The features and specifications of your new Sharp fax machine are shown below.

<b>Automatic dialing</b>	Rapid Key Dialing: 48 numbers Speed Dialing: <b>FO-4650:</b> 75 numbers <b>FO-4970:</b> 100 numbers
<b>Memory size*</b>	<b>FO-4650:</b> 1 MB (approx. 56 pages ) <b>FO-4970:</b> 2 MB (approx. 116 pages)
<b>Modem speed</b>	<b>FO-4650:</b> 14,400 bps (max.) <b>FO-4970:</b> 33,600 bps (max.) Automatic fallback to lower speeds.
<b>Transmission time*</b>	<b>FO-4650:</b> Approx. 6 seconds <b>FO-4970:</b> Approx. 2 seconds
<b>Toner cartridge yield (4% page coverage, letter paper)</b>	<b>Initial starter cartridge</b> (included with fax machine): Approx. 3000 pages <b>Replacement cartridge (FO-47ND):</b> Approx. 6000 pages
<b>Drum cartridge yield</b>	<b>Initial starter cartridge</b> (included with fax machine): 20,000 pages (ave.) <b>Replacement cartridge (FO-47DR):</b> 20,000 pages (ave.)
<b>Resolution</b>	<b>Horizontal:</b> 203 pels/inch (8 pels/mm) <b>Vertical:</b> Standard: 98 lines/inch (3.85 lines/mm) Fine /Halftone: 196 lines/inch (7.7 lines/mm) Super fine: 391 lines/inch (15.4 lines mm)

\*Based on ITU-T Test Chart #1 at standard resolution in Sharp special mode, excluding time for protocol signals (i.e., ITU-T phase C time only).

<b>Automatic document feeder</b>	Letter paper (20 lb): Max. 50 pages Legal paper: Max. 20 pages (Note: 11" x 17" paper must be loaded one page at a time.)
<b>Paper capacity</b>	250 sheets (500-sheet cassette available as option)
<b>Compression scheme</b>	MMR, MR, MH, Sharp (H2) ( <b>FO-4970</b> : Also supports JBIG)
<b>Halftone (grayscale)</b>	64 levels
<b>Applicable telephone line</b>	Public switched telephone network
<b>Compatibility</b>	ITU-T (CCITT) G3 mode
<b>Printing resolution</b>	<b>Horizontal:</b> 406 lines/inch (16 lines/mm) <b>Vertical:</b> 391 lines/inch (15.4 lines/mm)
<b>Input document size</b>	Automatic feeding: Width: 5.8 to 10.1" (148 to 256 mm) Length: 5.0 to 14.3" (128 to 364 mm) Manual feeding: Width: 5.8 to 11.0" (148 to 279 mm) Length: 5.0 to 17.0" (128 to 432 mm)
<b>Effective Scanning width</b>	8.3" (210 mm) max.
<b>Effective Printing width</b>	8.0" (203 mm) max.
<b>Reception modes</b>	Auto/Manual
<b>Instascan speed</b>	30 ppm (letter paper)
<b>Full Dual Access</b>	Yes
<b>Copy function</b>	Single/Multi/Sort (99 copies/page)
<b>Power requirements</b>	120 V AC, 60 Hz
<b>Operating temperature</b>	50 - 86°F (10 - 30°C)
<b>Humidity</b>	20 to 85% RH

<b>Power consumption</b>	Standby: 10 W Maximum: 580 W
<b>Dimensions</b>	Width: 18.1" (460 mm) Depth: 15.2" (385 mm) Height: 10.6" (270 mm)
<b>Weight</b>	Approx. 27.8 lbs. (12.6 kg)

As a part of our policy of continuous improvement, SHARP reserves the right to make design and specification changes for product improvement without prior notice. The performance specification figures indicated are nominal values of production units. There may be some deviations from these values in individual units.

## ***Important safety information***

Be sure to save these instructions!

When using your facsimile equipment, basic safety precautions should always be followed to reduce the risk of fire, electric shock and injury to persons, including the following:

- **CAUTION:** To reduce the risk of fire, use only No. 26 AWG or larger telecommunication line cord.
- Do not disassemble this machine or attempt any procedures not described in this manual. Refer all servicing to qualified service personnel.
- This machine must only be connected to a 120 V, 60 Hz, grounded (3-prong) outlet. Connecting it to any other kind of outlet will damage the machine and invalidate the warranty.
- Do not install or use the machine near water, or when you are wet. For example, do not use the machine near a bath tub, wash bowl, kitchen sink or laundry tub, in a wet basement, or near a swimming pool. Take care not to spill any liquids on the machine.

- Use only the power cord provided with the facsimile machine. Do not use an AC extension cord.
- Unplug the machine from the telephone jack and then the power outlet and consult a qualified service representative if any of the following situations occur:
  - Liquid has been spilled into the machine or the machine has been exposed to rain or water.
  - The machine produces odors, smoke, or unusual noises.
  - The power cord is frayed or damaged.
  - The machine has been dropped or the housing damaged.
- Do not allow anything to rest on the power cord, and do not install the machine where people may walk on the power cord.
- Never insert objects of any kind into slots or openings on the machine. This could create a risk of fire or electric shock. If an object falls into the machine that you cannot safely remove, unplug the machine and consult a qualified service representative.
- Do not place this machine on an unstable cart, stand or table. The machine could be seriously damaged if it falls.
- Avoid using a telephone (other than a cordless type) during an electrical storm. There may be a remote risk of electric shock from lightning.
- Do not use a telephone to report a gas leak in the vicinity of the leak.
- The power outlet must be installed near the equipment and must be easily accessible.

**Important:**

- This facsimile machine is not designed for use on a line which has call waiting, call forwarding, or certain other special services offered by your telephone company. If you attempt to use the fax machine in conjunction with any of these services, you may experience errors during transmission and reception of facsimile messages.
- This machine is not compatible with digital telephone systems.



---

# ***Table of Contents***

<b>QUICK REFERENCE GUIDE</b> .....	<b>1</b>
<b>GUIA DE CONSULTA RAPIDA</b> .....	<b>2</b>
<b>Introduction</b> .....	<b>3</b>
Important safety information .....	5
<b>Table of Contents</b> .....	<b>7</b>
<b>1. Installation</b> .....	<b>9</b>
Unpacking Checklist .....	9
A Look at the Operation Panel .....	10
Connections .....	16
Installing the Print Cartridges .....	20
Loading Printing Paper .....	25
Entering Your Name and Fax Number .....	28
Setting the Date and Time .....	31
Volume Adjustment .....	33
<b>2. Sending Documents</b> .....	<b>35</b>
Transmittable Documents .....	35
Loading the Document .....	37
Adjusting the Resolution and Contrast .....	38
Sending a Fax by Normal Dialing .....	40
Programming Auto-Dial Numbers .....	42
Sending a Fax by Automatic Dialing .....	48
Cover Sheet .....	59
Batch Page Numbering .....	61
<b>3. Receiving Documents</b> .....	<b>63</b>
Using AUTO Reception Mode .....	64
Using MANUAL Reception Mode .....	64
Substitute Reception to Memory .....	65

<b>4. Making Copies</b>	<b>66</b>
<b>5. Special Functions</b>	<b>69</b>
Broadcasting	69
Confidential Operations	74
Relay Request	80
Polling	88
Power Save Mode	96
Timer Operations	102
Batch Transmission	113
Entering and Using Programs	116
Duplex Scanning for Two-sided Documents	131
Print Hold	133
Department Control	135
Blocking Reception of Unwanted Faxes	138
Telephone Billing	140
Distinctive Ring	142
<b>6. Optional Settings</b>	<b>144</b>
<b>7. Printing Lists and Reports</b>	<b>154</b>
<b>8. Maintenance</b>	<b>162</b>
Cleaning the Scanning Glass and Rollers	162
The Housing	163
Replacing the Verification Stamp	163
<b>9. Troubleshooting</b>	<b>165</b>
Problems and Solutions	165
Messages and Signals	169
Clearing Paper Jams	172
FCC Regulatory Information	176
<b>Index</b>	<b>179</b>

# 1. Installation

## Unpacking Checklist

Before setting up, make sure you have all of the following items. If any are missing, contact your dealer.

Power cord

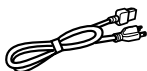

Telephone line cord



Toner cartridge

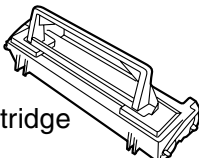

Drum cartridge

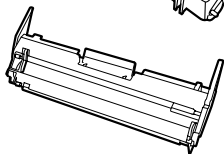

Rapid Key labels

Paper size labels

Document OUT tray

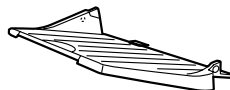

Operation manual

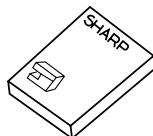

Received document tray



## A Look at the Operation Panel

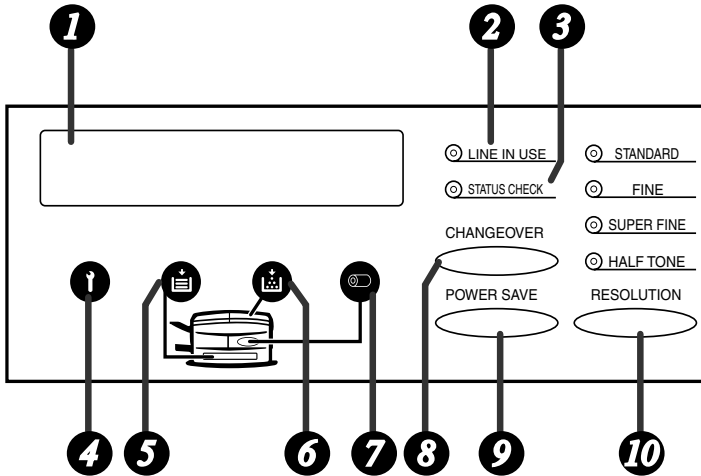

- 1 Display**  
This displays messages and prompts during operation and programming.
- 2 LINE IN USE light**  
This lights when the fax machine is using the telephone line.
- 3 STATUS CHECK light**  
This lights when a paper size error or paper jam occurs, or when the print compartment cover is open. A message will appear in the display to indicate the problem. (The indicator also lights steadily when the received document tray is not properly installed.)
- 4 Service indicator**  
This lights when a problem occurs which must be fixed by a service technician.

- 5 Paper out indicator**

This lights when the fax machine is out of paper. If the machine has a paper cassette, the indicator blinks when one of the paper sources (tray or cassette) is out of paper, and lights steadily when all sources are out of paper.
- 6 Toner cartridge indicator**

This blinks when the toner cartridge nears empty, and lights steadily when the toner cartridge needs replacement.
- 7 Drum cartridge indicator**

This blinks when the drum cartridge needs replacement.
- 8 CHANGEOVER key**

Two types of information appear in the display: prompts related to operations you are performing, and information about how the fax is using the telephone line (transmitting, receiving, etc.). Press this key to switch between the two types of information.
- 9 POWER SAVE key**

Press this key to turn on Power Save Mode, or set the Power Save Mode timer if TIMER has been selected with Option Setting 34 (Power Save Type).
- 10 RESOLUTION key**

Press this key to adjust the resolution before sending or copying a document.

## A Look at the Operation Panel

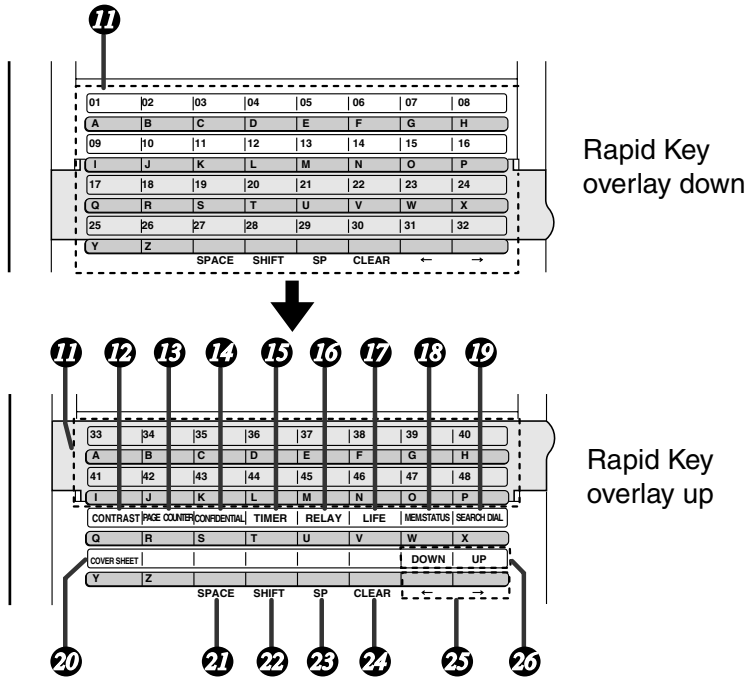

### 11 Rapid Dial Keys

Press one of these keys to dial a fax number automatically. (Note that you must attach the Rapid Key labels.)

### 12 CONTRAST key

Press this key to adjust the contrast before sending or copying a document.

### 13 PAGE COUNTER key

Press this key to include a slash and the total number of pages after each page number on the pages of a transmitted document.

### 14 CONFIDENTIAL key

Press this key to send or print out a confidential document.

### 15 TIMER key

Press this key to set an operation to be performed automatically at a later time.

- 16 RELAY key**  
Press this key to send a document to another Sharp fax machine and have that machine in turn relay the document to one or more end receiving machines.
- 17 LIFE key**  
Press this key, followed by **1**, to check the total number of pages printed by the fax machine.
- 18 MEM. STATUS key**  
Press this key to check the status of documents waiting in memory for transmission.
- 19 SEARCH DIAL key**  
Press this key to search through your auto dial fax numbers by name.
- 20 COVER SHEET key**  
Press this key to include a cover sheet when sending a fax.
- 21 SPACE key**  
Press this key to enter a space when programming a name.
- 22 SHIFT key**  
Press this key to switch between upper and lower case letters when programming a name.
- 23 SP key**  
Press this key to enter a symbol when programming a name.
- 24 CLEAR key**  
Press this key to clear a mistake when programming a name or fax number.
- 25 Arrow keys**  
Press these keys to move the cursor forward or backward when programming a name or fax number.
- 26 UP and DOWN keys**  
Press these keys to adjust the volume of the speaker when the **SPEAKER** key has been pressed, or the volume of the ringer at all other times.

## A Look at the Operation Panel

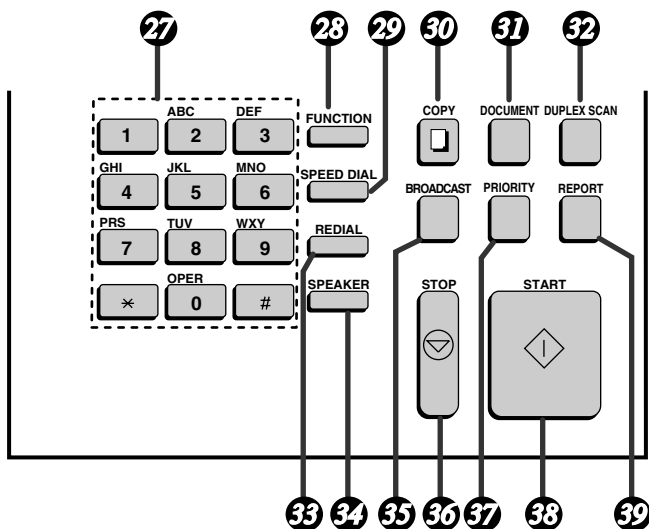

- 27** **Dial keypad (numeric keys)**  
Use these keys to dial and program fax numbers.
- 28** **FUNCTION key**  
Press this key to select various special functions.
- 29** **SPEED DIAL key**  
Press this key to dial a Speed Dial number.
- 30** **COPY key**  
Press this key to make a copy of a document.
- 31** **DOCUMENT key**  
Press this key to transmit a document without reading it first into memory.



- 32 DUPLEX SCAN key**  
Press this key to transmit or copy a two-sided document.
- 33 REDIAL key**  
Press this key to automatically redial the last number dialed.
- 34 SPEAKER key**  
Press this key when transmitting a document by Normal Dialing to listen to the line and verify the response of the receiving fax machine.
- 35 BROADCAST key**  
Press this key to send a document to a group of receiving fax machines.
- 36 STOP key**  
Press this key to cancel an operation before it is completed.
- 37 PRIORITY key**  
Press this key when you need to transmit a document ahead of other documents waiting in memory for transmission.
- 38 START key**  
Press this key to begin transmission when using Speed Dialing, Direct Keypad Dialing, or Normal Dialing.
- 39 REPORT key**  
Press this key to print out a report on the most recently completed transmission or reception.

## Connections

### Points to keep in mind when setting up

- ◆ Do not place the machine in direct sunlight.
- ◆ Do not place the machine near heaters or air conditioners.
- ◆ Keep dust away from the machine.
- ◆ Install the machine on a level surface.

### Connecting the power cord

Connect the female end of the power cord to the fax machine as shown. Insert the male end into a 120 V, 60 Hz, grounded (3-prong) AC outlet.

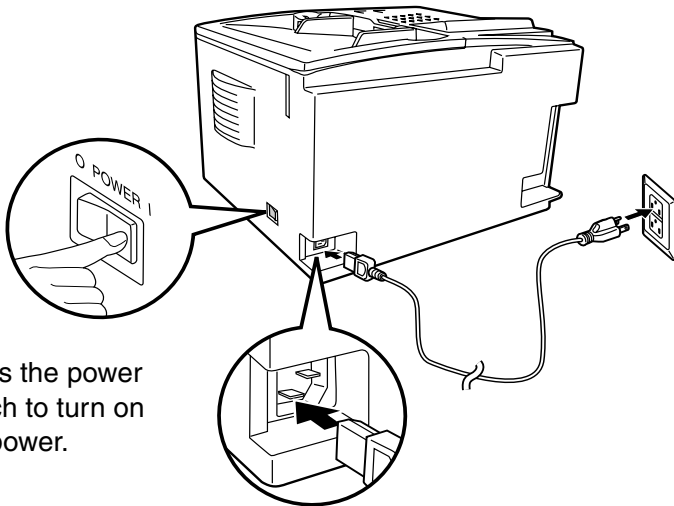

Press the power switch to turn on the power.

**Note:** If your area experiences a high incidence of lightning or power surges, we recommend that you install surge protectors for the power and telephone lines. Surge protectors can be purchased at most telephone specialty stores.

## Connecting the telephone line cord

Insert one end of the line cord into the jack on the back of the machine marked **TEL. LINE**. Insert the other end into a standard (RJ11C) single-line wall telephone jack.

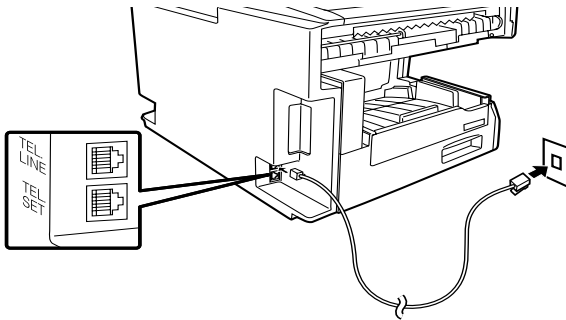

**Note:** The fax machine is set for touch-tone dialing. If you are on a pulse dial (rotary) line, you must set the fax machine for pulse dialing by changing Option Setting 22. This procedure is described in Chapter 6, *Optional Settings*.

## Connecting a telephone (optional)

If desired, you can connect a telephone to the **TEL. SET** jack on the back of the machine.

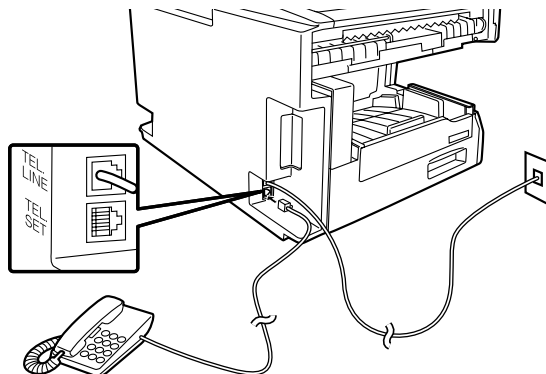

### **Attaching the document OUT tray**

Insert the protrusion on the right side of the machine into the hole in the right side of the document OUT tray as shown, then bend the tray slightly and insert so that the protrusion on the left side of the machine goes into the hole on the left side of the document OUT tray.

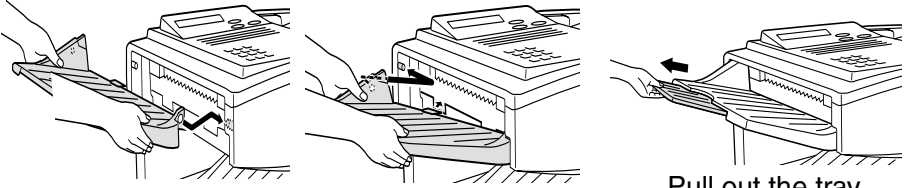

Pull out the tray extension.

Attach the Automatic Document Feeder label to the top of the machine.

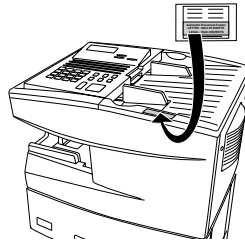

### **Attaching the received document tray**

Slide the received document tray into the machine as shown. When it stops, lift the end slightly and push in so that the tray locks into place.

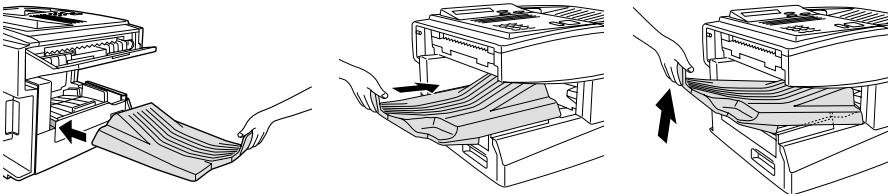

Make sure the left edge of the tray fits into the slot.

#### **Important!**

The received document tray must be attached for the fax machine to operate properly.

### ***Verification Stamp (option)***

**Note:** This function is available as an option. Consult your dealer if you wish to use it.

When transmitting a document, you can have your fax stamp each document page as it is scanned. After scanning, you can check to see if all documents have been stamped to verify that no double feeds occurred. (A double feed is when two pages are fed through the scanner at once, which means that one of the pages is not scanned.)

To use this function, have your dealer install the Verification Stamp option, and then set Option Setting 29 to ON as explained in Chapter 6, *Optional Settings*.

## Installing the Print Cartridges

Follow the steps below to install or replace the toner and drum cartridges.

- ◆ The initial starter toner cartridge included with the fax machine can print approximately 3000 letter-size pages (4% coverage of each page).
- ◆ The replacement toner cartridge (FO-47ND) can print approximately 6000 letter-size pages.
- ◆ The drum cartridge (FO-47DR) can print approximately 20,000 letter-size pages.

---

**1** Press the green release and open the print compartment cover.

- **Caution!**  
The fusing unit inside the print compartment becomes very hot during operation. Be careful not to touch the inside of the compartment.

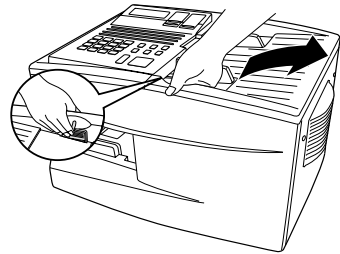

---

**2** If you are replacing the toner cartridge, remove the old cartridge and dispose of it according to local regulations. Go directly to Step 6 if you are only replacing the toner cartridge and not the drum cartridge.

- If you are replacing the drum cartridge but not the toner cartridge, remove the toner cartridge and place it on a sheet of paper.

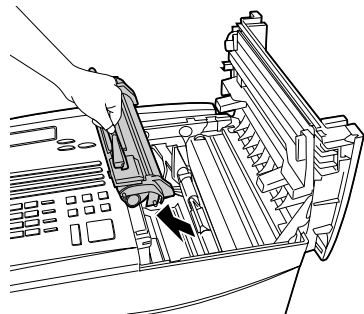

- 3** If you are replacing the drum cartridge, remove the old cartridge and dispose of it according to local regulations.

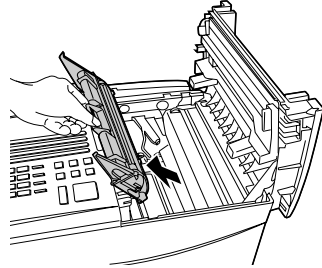

- 4** Remove the new drum cartridge from its packaging.

- **Caution!** Excessive exposure to light will damage the drum cartridge. Install the cartridge promptly after removing it from its packaging.

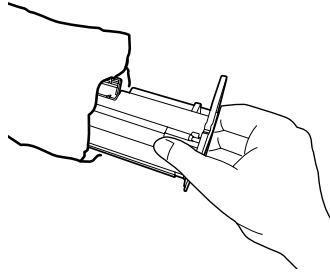

- 5** Insert the drum cartridge into the print compartment, aligning the guides on the cartridge with the grooves on the sides of the compartment.

- Insert the cartridge by aligning the colored "1" labels on the cartridge and the sides of the compartment.
- Make sure the drum cartridge is inserted in as far as it will go.

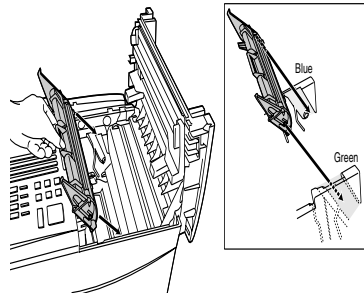

**6** If you are installing a new toner cartridge, remove the new toner cartridge from its packaging. Shake as indicated by the arrows to distribute the toner evenly within the cartridge.

- If the toner is still lumpy after shaking, the gears in the cartridge may make a noticeable sound when the print compartment cover is closed after installing the cartridge. This is normal and does not indicate a problem in the machine.

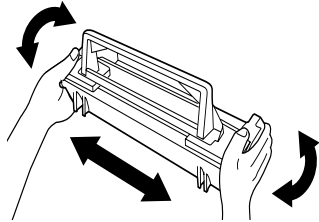
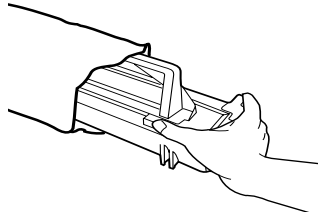

**7** Hold the toner cartridge by the handle and lower it into the print compartment. Make sure that the four pins (two on each side) fit into the grooves on the sides of the compartment.

- Insert the cartridge by aligning the colored “2” labels on the cartridge and the side of the compartment
- Make sure the toner cartridge clicks into place.

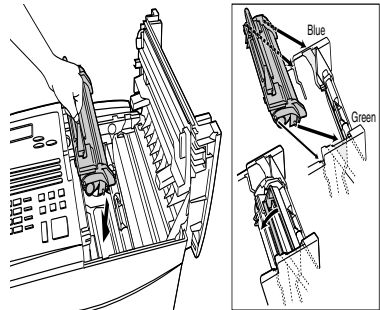



---

**8** Close the print compartment cover.

- Press down on the dot markings at the left edge to make sure the cover is completely closed.

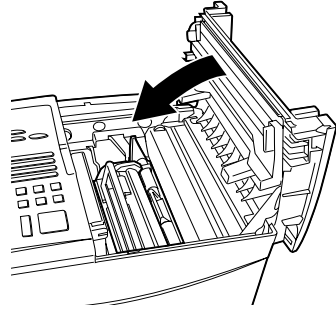

---

**9** Reset the toner counter by pressing the **LIFE** key (flip up the Rapid Key overlay), **2**, and the **START** key.

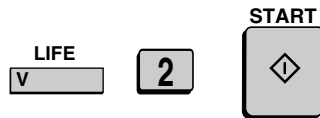

---

**10** Reset the drum counter by pressing the **LIFE** key (flip up the Rapid Key overlay), **3**, and the **START** key.

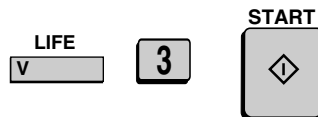

**Note:** The print compartment cover may become noticeably warm if a large number of pages are successively printed. This is normal and does not indicate a problem in the machine.

### ***When to replace the toner cartridge***

When the toner cartridge nears empty (about 100 pages can still be printed), the toner cartridge indicator on the operation panel will blink. When the toner cartridge is empty, the toner cartridge indicator will light steadily and REPLACE TONER will appear in the display. Printing will no longer be possible. Use the following replacement toner cartridge:

**Sharp FO-47ND toner cartridge**

### ***When to replace the drum cartridge***

When the drum cartridge life is over, the drum cartridge indicator on the operation panel will blink and DRUM LIFE OVER will appear in the display. Use the following replacement drum cartridge:

**Sharp FO-47DR drum cartridge**

◆ **Caution!**

Be sure to use only genuine Sharp supplies.

## Loading Printing Paper

You can load up to 250 sheets of letter or legal paper (max. 20 lbs.) in the paper tray. You can load up to 500 sheets of letter paper in the paper cassette.

**Note:** The paper cassette is available as an option. To have the cassette installed, consult your dealer.

**Note:** To use A4 paper in the paper cassette, you must have a service technician adjust the cassette.

### Loading paper in the paper tray

---

- 1 Remove the received document tray.

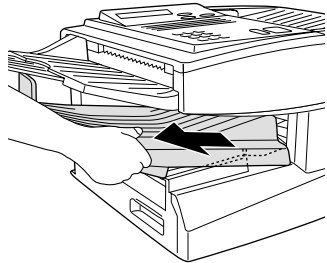

- 2 If you are loading legal paper, grasp the end of the paper tray and pull it out.

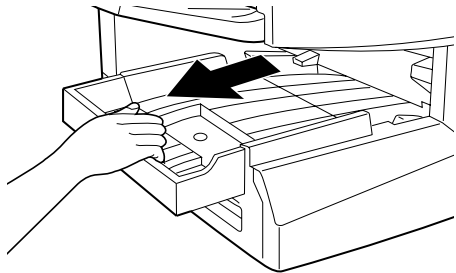

**3** Insert a stack of paper into the tray, print side up.

- If you loaded letter paper, make sure the end of the tray is pushed in. Otherwise a size error will result.

**• Caution!**

This paper tray is designed to accommodate 250 sheets of paper. [See the Red line in the tray.] Loading more than 250 sheets may damage the machine.

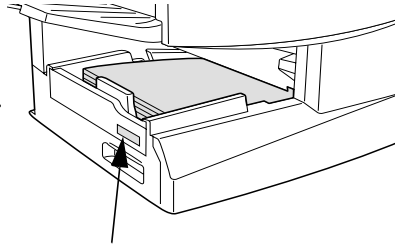

Attach a letter or legal label here to indicate the paper size.

**4** Replace the received document tray.

- The received document tray must be attached for the fax machine to operate properly.

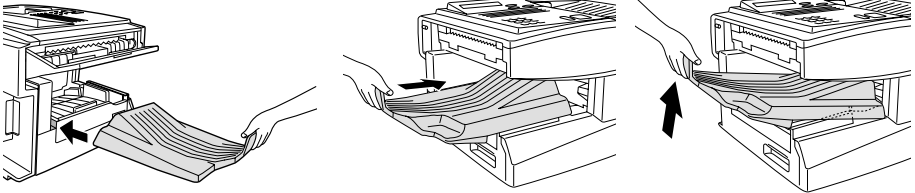

### **Loading paper in the paper cassette (if installed)**

**1** Grasp the hand-hold on the cassette and pull out the cassette until it stops.

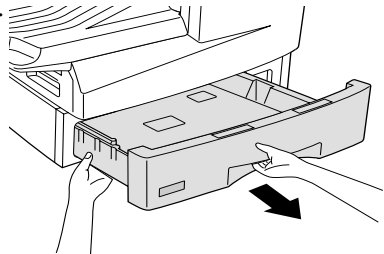

- 
- 2** Push the pressure plate down until it locks into position.

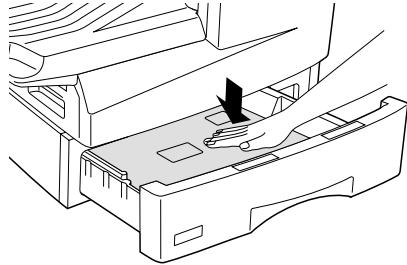

- 
- 3** Place a stack of paper in the cassette, print side up.

- Make sure the stack of paper is not higher than the two tabs on the paper guide and the two metal tabs. If it is, remove some of the paper.

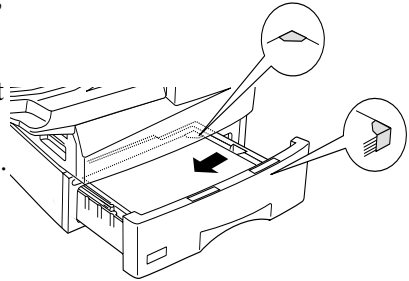

- 
- 4** Push the cassette back into the machine, making sure it clicks into place.

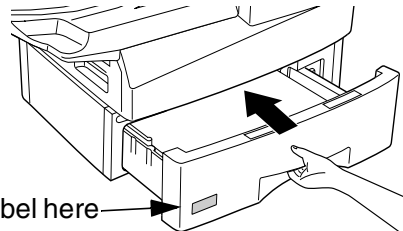

Attach a LETTER label here to indicate the paper size.

Note: We recommend that you do not add paper to the tray or cassette while paper still remains. This may result in double feeds.

## Entering Your Name and Fax Number

Before you can begin using the fax machine, you must program your name and fax number. Once you program this information, it will appear automatically at the top of each fax page you send.

### Important!

The law requires that your name, telephone/fax number, and the date and time appear on each fax message you send. Enter your name and fax number here and set the date and time as explained in the following section to have the fax machine include this information automatically at the top of your fax messages.

**Note:** Make sure the display shows the date and time before beginning a programming operation. If the display shows the telephone line status, press the **CHANGEOVER** key to switch to the date and time.

---

**1** Press these keys:

FUNCTION



The display will show:

3:ENTRY MODE  
ENTER #(1-9,\*,#)

---

**2** Press the **3** key.



The display will show:

3:OWN PASSCODE SET  
ENTER FAX #

**3** Enter your fax number (max. of 20 digits) by pressing the numeric keys.

- To insert a space between digits, press the # key.
- To clear a mistake, press the **STOP** key.



(Example)

**4** Press the **START** key.

The display will show:

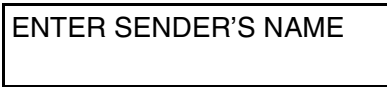

**5** Flip the Rapid Key overlay down (if it is up), and enter your name by pressing the appropriate letter keys as shown below. (Max. of 24 characters.)

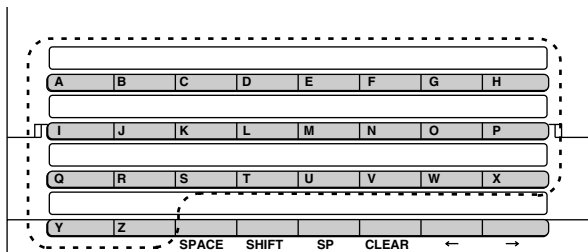

Example: SHARP =

## Entering Your Name and Fax Number

- ◆ Press the **SPACE** key to enter a space. To change case, press the **SHIFT** key.
- ◆ To clear a mistake, press the **CLEAR** key.
- ◆ To enter a number as part of a name, press the appropriate numeric key. To select one of the following special symbols, press the **SP** key one or more times: !"#\$%&'()\*+,-/;<=>?[¥]^\_`{|}~→←@.

---

### 6 Press the **START** key.

The display will show:

4:DATE &TIME SET MODE  
PRESS START KEY



---

### 7 Press the **STOP** key twice to return to the date and time display.

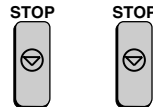



## Setting the Date and Time

The date and time appear in the display, in reports, and at the top of each page you transmit. Set the date and time by pressing the keys on the operation panel as shown below.

**Note:** Make sure the display shows the date and time before beginning a programming operation. If the display shows the telephone line status, press the **CHANGEOVER** key to switch to the date and time.

**1** Press these keys:

FUNCTION



The display will show:

4:DATE&TIME SET MODE  
DATE 06-08-2001

(Note: the currently set date will appear to the right of "DATE")

**2** Enter a two-digit number for the month ("01" for January, "02" for February, "12" for December, etc.).



Example: January

- To correct a mistake, press the **STOP** key to move the cursor back to the mistake and then enter the correct number.

**3** Enter a two-digit number for the day ("01" to "31").



Example: the 5th

**4** Enter the year (four digits).



Example: 2001

## Setting the Date and Time

- 
- 5** Enter a two-digit number for the hour (“01” to “12”) and a two-digit number for the minute (“00” to “59”).



Example: 9:25

- 
- 6** Press the \* key to select A.M. or the # key to select P.M.

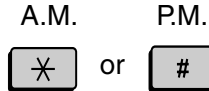

- 
- 7** Press the **START** key to start the clock.



- 
- 8** Press the **STOP** key twice to return to the date and time display.

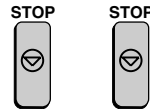

## Daylight Saving Time

If desired, you can set the clock to move forward and backward automatically at the beginning and end of Daylight Saving Time.

- 
- 1** Press these keys:



- 
- 2** Press **1** to turn on the Daylight Saving Time function, or **2** to turn it off.

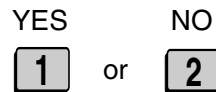

- 
- 3** Press the **STOP** key twice to return to the date and time display.

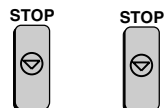

## Volume Adjustment

You can adjust the volume of the speaker and ringer using the **UP** and **DOWN** keys.

### Speaker

- 
- 1** Press the **SPEAKER** key.



- 
- 2** Press the **UP** or **DOWN** key.

Display:

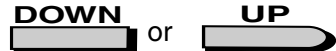

SPEAKER VOLUME  
HIGH



SPEAKER VOLUME  
MIDDLE



SPEAKER VOLUME  
LOW

- 
- 3** When the display shows the desired volume level, press the **SPEAKER** key to turn off the speaker.



## Ringer

---

- 1 Press the **UP** or **DOWN** key. (Make sure the **SPEAKER** key has not been pressed.)

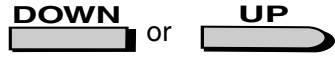

- The ringer will ring once at the selected level, then the date and time will reappear in the display.

Display:

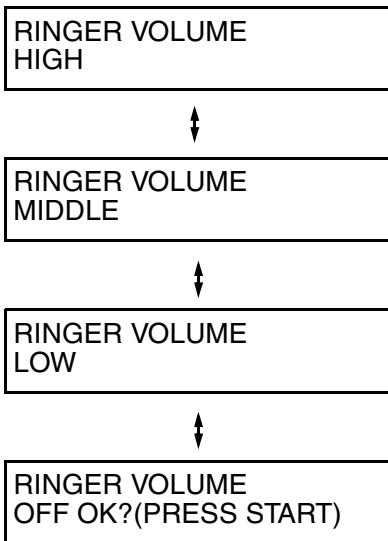

- 2 If you selected RINGER OFF: OK?, press the **START** key.



## 2. Sending Documents

### Transmittable Documents

#### Size and weight

The size and weight of documents that you can load in the document feeder depend on whether you load one page at a time or several pages at once.

#### Loading one page at a time:

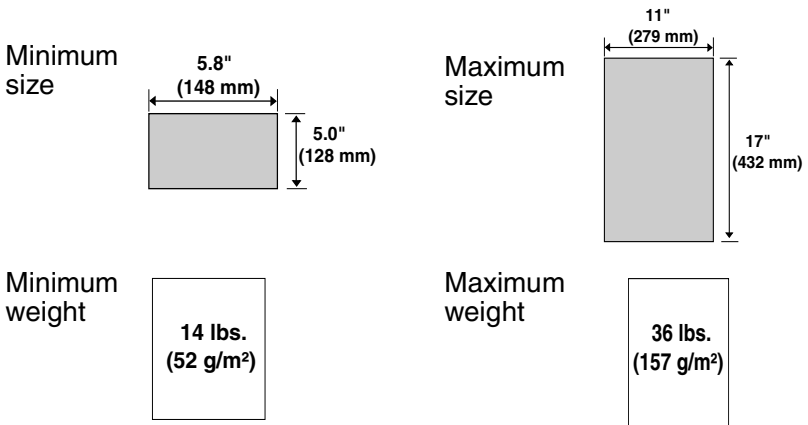

#### Loading multiple pages at once (letter-size: max. 50 pages, legal-size: max. 20 pages):

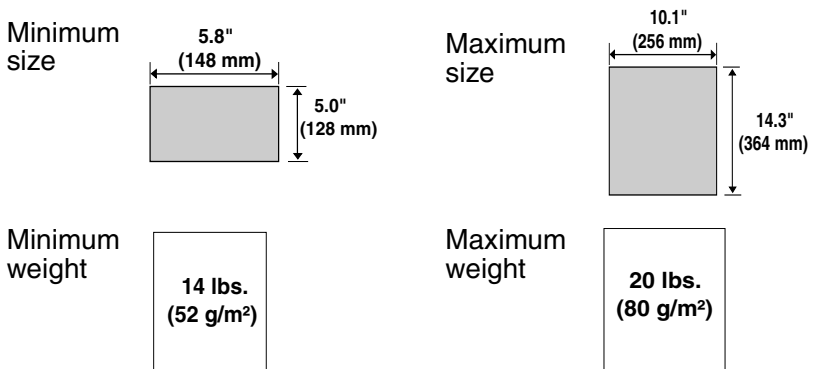

**Note:** 11" x 17" paper must be loaded one page at a time.

### ***Maximum scanning area***

The area of the document that the fax machine can scan is slightly smaller than the actual document size. Any letters or graphics outside this area will not be scanned.

Maximum scanning width: 8.3 inches (210 mm)

Maximum scanning length: The length of the document minus 0.16 inches (4 mm) from the top and bottom of the document.

### ***Other restrictions***

- ◆ The scanner cannot recognize yellow, greenish yellow, or light blue ink.
- ◆ Ink, glue, and correcting fluid on documents must be dry before they pass through the document feeder.
- ◆ All clips, staples, and pins must be removed from documents before loading in the feeder. If these are not removed, they may damage the machine.
- ◆ Documents which are patched, taped, torn, smaller than the minimum size, carbon backed, easily smudged, or have a slippery coated surface should be photocopied, and the copy loaded in the feeder.

## Loading the Document

Up to 50 letter-sized pages (20 legal-sized pages) can be placed in the feeder at one time. The pages will automatically feed into the machine starting from the bottom page.

- ◆ If you need to send or copy more than 50 pages, place the additional pages gently and carefully in the feeder just before the last page is scanned. Do not try to force them in, as this may cause double-feeding or jamming.
- ◆ If your document consists of several large or thick pages which must be loaded one at a time, insert each page into the feeder as the previous page is being scanned. Insert gently to prevent double-feeding.

- 
- 1** Adjust the document guides to the width of your document.

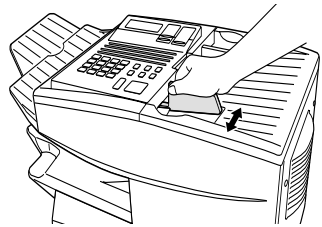

- 
- 2** Place the document face down and push it gently into the document feeder. The top edge of the document should enter the machine first.

- The feeder will draw the leading edge of the document into the machine. SEND READY will appear in the display.

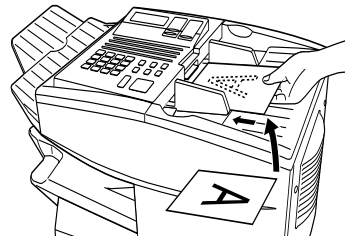

**Note:** When inserting a large number of pages in the feeder, slant the front end of the stack so that the bottom pages enter first.

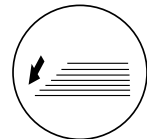

- 3** Adjust the resolution and/or contrast settings (if desired) and then dial the receiving machine as explained in the following sections.

### ***Adjusting the Resolution and Contrast***

If desired, you can adjust the resolution and contrast before sending a document.

#### ***Resolution***

The fax machine has four resolution settings:

STANDARD	Use STANDARD for ordinary documents. This setting gives you the fastest and most economical transmission.
FINE	Use FINE for documents containing small letters or fine drawings.
SUPER FINE	Use SUPER FINE for documents containing very small letters or very fine drawings.
HALF TONE	Use HALF TONE for photographs and illustrations. The original will be reproduced in 64 shades of gray.

The default resolution setting is STANDARD. If you don't adjust the resolution before sending a document, the fax machine will automatically use STANDARD resolution.

- ◆ In order to transmit in FINE or SUPER FINE resolution, the receiving fax machine must also have that resolution. If it doesn't, the next best available setting will be used.
- ◆ The resolution settings are only effective for transmitting and copying a document. They are not effective for receiving a document.



To adjust the resolution setting, press the **RESOLUTION** key one or more times until the indicator light next to the desired setting comes on.

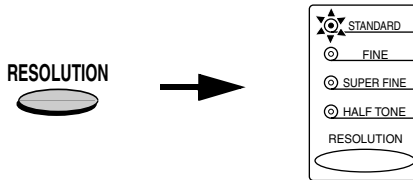

### Contrast

The fax machine has three contrast settings:

- AUTO Use AUTO for normal documents.
- DARK Use DARK for faint documents.
- LIGHT Use LIGHT for documents with a dark background.

The default setting is AUTO.

To adjust the contrast, flip up the Rapid Key overlay (if necessary) and press the **CONTRAST** key until the desired setting appears in the display.

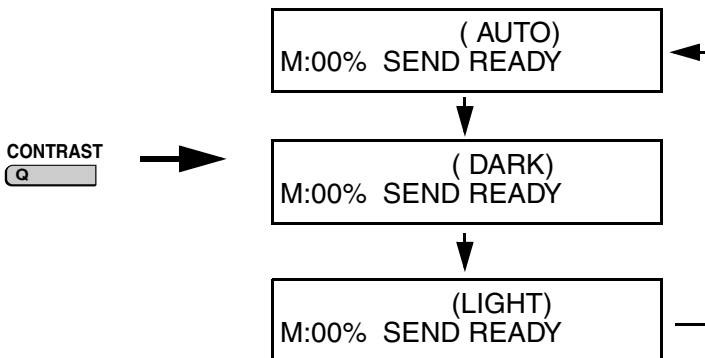

## ***Sending a Fax by Normal Dialing***

With Normal Dialing, you press the **SPEAKER** key and then dial by pressing the numeric keys.

- ◆ Normal Dialing allows you to listen to the line through the speaker to make sure the other fax machine is responding. (Note that the speaker is not a speakerphone; it cannot be used for talking.)
- ◆ If you have connected an extension telephone to the fax machine, you can also pick up the extension phone and dial using the extension phone (do not press the **SPEAKER** key on the fax machine). If a person answers, you will be able to speak to them through the phone before sending a fax.

**Note:** If you press the **SPEAKER** key to dial, you will not be able to speak using an extension phone connected to the fax machine in the event that a person answers.

---

**1** Load the document(s). (Note: If desired, you can load the document after dialing in Step 3, below.)

- SEND READY will appear in the display.
- Set the resolution and/or contrast if desired.

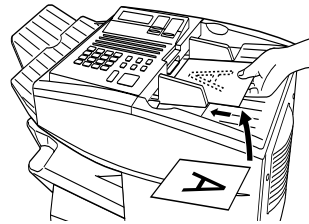

RESOLUTION



CONTRAST



---

**2** Press the **SPEAKER** key or pick up an extension phone connected to the fax machine. Listen for the dial tone.



- 3** If you pressed the **SPEAKER** key, dial the number of the receiving machine by pressing the numeric keys on the fax machine.



(Example)

If you are using an extension phone, dial using the keypad on the extension phone.

- If Option Setting 26 (TEL. BILLING CODE) has been set to ON and BILLING CODE DIAL has been set to AFTER, press the **REDIAL** key after dialing.

- 4** Wait for the connection. When you hear a fax tone, press the **START** key on the fax machine.



- If a person answers and you are using an extension phone, ask them to press their Start key. When you hear the fax tone, press the **START** key on your fax machine.

### **Using the REDIAL key**

You can press the **REDIAL** key to redial the last number dialed. To send a document, press the **START** key when you hear the fax tone after the connection is made. Note that the speaker is automatically activated when you press the **REDIAL** key.

## Programming Auto-Dial Numbers

You can dial a fax number by simply pressing a Rapid Key, or by pressing the **SPEED DIAL** key and entering an abbreviated Speed Dial number.

To use a Rapid Key or Speed Dial number, you must first program the full fax number in the Rapid Key or Speed Dial number. It is usually convenient to program your most frequently dialed numbers in Rapid Keys.

- ◆ Forty-eight Rapid Keys are available. Rapid Dial Keys also allow you to program a backup fax number, which is automatically dialed if the first fax number is busy.
- ◆ Seventy-five Speed Dial numbers are available on the FO-4650, and one hundred Speed Dial numbers are available on the FO-4970.

---

**1** Press these keys:

**FUNCTION**

**3**

The display will show:

3:ENTRY MODE  
ENTER #(1-9,\*,#)

---

**2** Press the **1** key.

**1**

The display will show:

1:FAX/TEL. # MODE  
1=SET, 2=CLEAR

---

**3** Press the **1** key to select SET.

**1**

- 4** To program a Rapid Key number, press a Rapid Key (to select Rapid Keys 33 through 48, flip up the Rapid Key overlay).

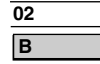

Example: Rapid Key 02

To program a Speed Dial number, press the **SPEED DIAL** key and then enter a number from “1” to “75” on the FO-4650, or “1” to “100” on the FO-4970. (If you enter less than two digits on the FO-4650, or three digits on the FO-4970, press the **START** key to complete the entry.)

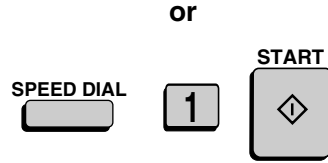

Speed Dial 1

- 5** Enter the fax number by pressing the numeric keys (max. of 34 digits including pauses).



(Example)

- To clear a mistake, press the **CLEAR** key.
- If a pause is required between any of the digits to access a special service or an outside line, press the **REDIAL** key (two seconds per pause). The pause will appear as a hyphen. Several pauses can be entered in a row.

- 6** Press the **START** key.



---

**7** Enter the name of the party by pressing the letter entry keys (max. of 20 characters). (Make sure the Rapid Key overlay is flipped down.)



Example: SHARP

- If you don't want to enter a name, go directly to Step 8.

---

**8** Press the **START** key.



---

**9** Press **1** if the number programmed is an area code or access code to be used for Chain Dialing (see *Chain Dialing* at the end of this procedure). Press **2** (or **START**) if the number is a regular fax number.

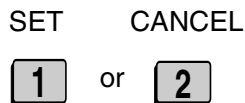

- If you pressed **1** or are programming a Speed Dial number, go to Step 14. (Note: A backup fax number cannot be entered in a Rapid Key used for Chain Dialing.)

---

**10** Enter a backup fax number to be dialed if the first number is busy. (If you don't want to enter a backup number, go directly to Step 13.)



(Example)

---

**11** Press the **START** key.



- 12** Enter a name for the backup fax number. (If you don't want to enter a name, go directly to Step 13.)



Example: SHARP2

- 13** Press the **START** key.



- 14** Return to Step 4 to program another number, or press the **STOP** key repeatedly to return to the date and time display.

Step 4 or



- If you programmed a Rapid Key number, you can write the name of the party on the label above the Rapid Key.

### **Chain Dialing for area and access codes**

You can also program an area code or access code in a Rapid Key or Speed Dial number using the above programming procedure. In Step 9, press **1** to set the number as a Chain Dialing number.

After you dial an area code or access code using a Rapid Key or Speed Dial number set for Chain Dialing, the fax machine will wait for you to dial the remainder of the number (you can dial the remainder of the number by pressing a Rapid Key, by pressing the Speed Dial key and entering a Speed Dial number, or by pressing numeric keys). Note that the remainder of the number should **not be set** as a Chain Dial number if programmed in a Rapid Key or Speed Dial number.

- ◆ The maximum number of digits that can be dialed at one time by Chain Dialing is 50.

### Clearing auto-dial numbers

**Note:** You cannot clear a number if it is used in a program or timer operation, if it is used to specify the relay fax machine in a relay group, or if it is included in a Group Key. First clear the number from the operation or group, then perform the following clearing procedure. To check where the number is used, print out the Program/Group List, the Timer List, and/or the Relay Group List as explained in Chapter 7.

**1** Press these keys:

The display will show:

1:FAX/TEL. # MODE  
1=SET, 2=CLEAR

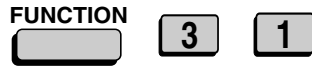

**2** Press **2** to select CLEAR.



**3** To clear a Rapid Key, press the Rapid Key.

To clear a Speed Dial number, press the **SPEED DIAL** key and then enter the number with the numeric keys. (If you enter less than 2 digits on the FO-4650, or 3 digits on the FO-4970, press the **START** key to complete the entry.)

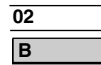

Example: Rapid Key 02

**4** Press the **START** key.





- 
- 5** Return to Step 3 to clear another number, or press the **STOP** key repeatedly to return to the date and time display.

Step 3 or

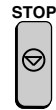

### ***Making changes***

To make changes in a number previously stored, repeat the programming procedure. Select the Rapid Key or Speed Dial number for which you want to make changes in Step 4, and then change the number(s) and/or name(s) when they appear in the display (Steps 5, 7, 10 and 12).

## ***Sending a Fax by Automatic Dialing***

### ***Dual Access***

The fax machine features full dual access, which means that you can load a document and dial by automatic dialing even when the fax machine is occupied with another operation. After you dial, your document will be immediately scanned into memory and then transmitted once all previously set operations have been completed.

If more than one document has been scanned into memory for transmission, the documents will be transmitted in the order in which they were scanned. If you have an urgent transmission and do not want to wait until previously scanned documents are transmitted, you can press the **PRIORITY** key after loading your document. Your document will be transmitted immediately after the current document has completed transmission.

If you don't want the document to be transmitted from memory, you can press the **DOCUMENT** key after loading the document. In this case, the document will not be scanned until all previously set operations are completed and the connection to the receiving party is established. (To transmit the document ahead of any documents waiting in memory for transmission, press the **PRIORITY** key.)

- ◆ The FO-4650 can hold approximately 56 pages of average content in memory. The FO-4970 can hold approximately 116 pages. Less pages can be held if any were scanned using fine or halftone resolution.
- ◆ The amount of memory currently occupied appears as a percentage ("M:00%") in the display.

***If the memory becomes full...***

If the memory becomes full while a document is being scanned, MEMORY FULL will appear in the display. If Option Setting 23 (Quick On-line) is set to YES, scanning will automatically resume when memory becomes free again as pages are transmitted. (Note: Quick On-Line is initially set to YES at the factory. To change the setting, see Chapter 6, *Optional Settings*.)

If Quick On-Line is set to NO, MEMORY FULL ERROR will appear in the display. Press the **START** key or the **STOP** key as follows:

- ◆ Press the **START** key if you want to transmit the pages which have been stored up to that point in memory. The remaining pages will be ejected from the feeder. After transmission, the memory will be cleared and you can transmit the remaining pages. You will also need to transmit the page which was being scanned when the memory filled up.
- ◆ Press the **STOP** key if you want to cancel the entire transmission.

If you do not press the **START** key or the **STOP** key within one minute, the transmission will be canceled and the pages already scanned cleared from memory. You will need to retransmit all pages of the document.

## Rapid Key Dialing

If the number you want to dial has been programmed in a Rapid Key, you can dial it by pressing the Rapid Key.

### 1 Load the document(s).

SEND READY will appear in the display.

- Set the resolution and/or contrast if desired.
- To send the document ahead of other documents waiting for transmission, press the **PRIORITY** key.
- To send the document directly from the feeder (not through memory), press the **DOCUMENT** key.

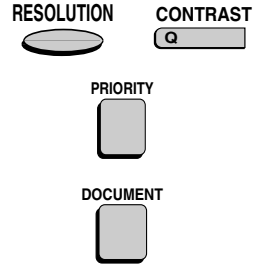

### 2 Press the appropriate Rapid Key.

- The name of the receiving party will appear in the display. If no name was stored, the fax number will appear. (If the name or number is incorrect, press the **STOP** key.)
- The document will be automatically transmitted once the connection is established.

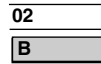

Example: Rapid Key 02

## Speed Dialing

If the number you want to dial has been programmed in a Speed Dial number, you can dial it by pressing the **SPEED DIAL** key and then entering the Speed Dial number.

### 1 Load the document(s).

SEND READY will appear in the display.

- Set the resolution and/or contrast if desired.
- To send the document ahead of other documents waiting for transmission, press the **PRIORITY** key.
- To send the document directly from the feeder (not through memory), press the **DOCUMENT** key.

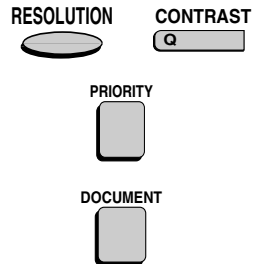
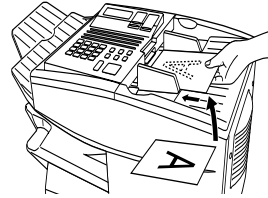

### 2 Press the **SPEED DIAL** key and then enter the Speed Dial number by pressing the numeric keys.

- If you enter less than 2 digits for the Speed Dial number on the FO-4650, or 3 digits on the FO-4970, press the **START** key to complete the entry.



Example: Speed Dial 1

- 
- 3** Check the display. If the name or number shown is correct, press the **START** key. (If not, press the **STOP** key and then repeat Step 2.)



### **Direct Keypad Dialing**

You can also enter a full number with the number keys and then press the **START** key to begin dialing.

- 
- 1** Load the document(s). (Note: If desired, you can load the document after dialing in Step 2, below.)

SEND READY will appear in the display.

- Set the resolution and/or contrast if desired.
- To send the document ahead of other documents waiting for transmission, press the **PRIORITY** key.
- To send the document directly from the feeder (not through memory), press the **DOCUMENT** key.



RESOLUTION



CONTRAST



PRIORITY



DOCUMENT



- 2** Enter the number of the receiving machine by pressing the numeric keys.



(Example)

- If a pause is required between any of the digits to access a special service or an outside line, press the **REDIAL** key (two seconds per pause). The pause will appear as a hyphen. Several pauses can be entered in a row.

- 3** Check the display. If the number of the receiving machine shown is correct, press the **START** key.



- If it is not correct, press the **STOP** key to backspace and clear one digit at a time, and then re-enter the correct digit(s).

### **Searching for an auto-dial number**

If you don't remember the Rapid Key or Speed Dial number in which you have programmed a particular fax number, you can search for the number by following the steps below. Once you have found the number, you can dial it and transmit the loaded document by simply pressing the **START** key.

**Note:** Only names programmed for auto-dial numbers will appear when you search; the full numbers themselves will not appear. You cannot search for a number if a name has not been associated with it.

---

**1** Load the document(s).

SEND READY will appear in the display.

- Set the resolution and/or contrast if desired.



RESOLUTION



CONTRAST



---

**2** Press the **SEARCH DIAL** key (flip up the Rapid Key overlay).

SEARCH DIAL



---

**3** Enter the first letter of the stored name by pressing the appropriate letter entry key.



- If you don't remember the first letter, go to Step 4 (you will scroll through the list from the beginning).

Example: A

---

**4** Press either arrow key to scroll through the names. Stop when the desired name appears in the display.

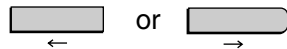

- If no numbers have been stored under the entered letter or you have reached the end of the list, NOT FOUND will appear.



- 5** Press the **START** key. The document will be automatically transmitted once the connection is established.



### ***Chain Dialing***

An auto-dial number set for Chain Dialing can be combined with another auto-dial number or digits entered manually with the numeric keys to dial one phone number up to 50 digits long. The following are some examples of how this can be done:

- ◆ Press appropriate Rapid Keys in the proper order. For example, press Rapid Key 01 (set for Chain Dialing), then Rapid Key 02 (not set for Chain Dialing).
- ◆ Press a Rapid Key (set for Chain Dialing) and then manually enter a number by pressing appropriate numeric keys. Press the **START** key after the final numeric key to begin transmission.

### ***Checking the telephone line status***

The display normally shows the date and time and prompts related to operations you are performing. To check and see what number the fax machine is currently calling or transmitting to, or what number the fax machine is currently receiving a document from (if this information is available), press the **CHANGEOVER** key. Information on the current call will appear in the display. To switch back to the date and time display, press the **CHANGEOVER** key again.

### ***To cancel a fax transmission or reception***

To cancel a fax transmission or reception which is currently in progress, press the **CHANGEOVER** key so that the status of the transmission or reception appears in the display, and then press the **STOP** key.

### ***Automatic redialing***

If you use automatic dialing (including Direct Keypad Dialing) and the line is busy, the fax machine will automatically redial the number. The fax machine is set at the factory to make 2 redialing attempts at intervals of 5 minutes.

To stop automatic redialing, press the **CHANGEOVER** key to show the telephone line status in the display (make sure that **RECALL MODE** appears on the top line of the display and the number of the receiving party appears on the bottom line to the right), and then press the **STOP** key.

If desired, you can change the number of redial attempts with Option Setting 6, and the interval at which redialing takes place with Option Setting 7. See Chapter 6, *Optional Settings*.

- ◆ Under certain conditions (for example if a person answers the call on a telephone), automatic redialing may stop before the set number of redialing attempts are made.

### ***Memory Retransmission***

If a line error occurs during any type of memory transmission, your fax will automatically redial the number and attempt to complete the transmission. Retransmission will begin from the page which was being transmitted when the error occurred.

The fax machine has been set at the factory to make 10 attempts at retransmission, with each attempt made immediately after the previous attempt. If desired, you can change the number of attempts by changing Option Setting 17, and have the fax wait a selected number of minutes between each attempt by changing Option Setting 18. See Chapter 6, *Optional Settings*.

- ◆ To stop retransmission, press the **CHANGEOVER** key to show the telephone line status in the display (make sure that **RETRY MODE** appears on the top line of the display and the number of the receiving party appears on the bottom line to the right), and then press the **STOP** key.

- ◆ The numbering of pages retransmitted will begin from "1" again.
- ◆ If an error or power failure occurs during transmission of a cover sheet, retransmission will not take place.

### Checking documents in memory

To display information on documents that are waiting in memory for transmission, follow the steps below. You can also cancel a transmission with this procedure.

- 1** Press the **MEM. STATUS** key (flip up the Rapid Key overlay) and then **2**.

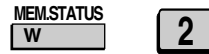

TX STATUS will appear in the display.

- 2** Press the **#** key or the **\*** key to scroll through the list of transmissions. The name (or number) of each receiving party will appear in the display, together with the 3-digit memory number assigned to the transmission. To cancel a transmission, press the **CLEAR** key and then the **START** key while the transmission appears in the display.

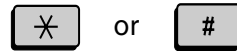

- 3** When you have finished checking the list, press the **STOP** key twice to return to the date and time display.

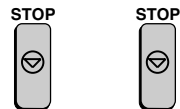

**Note:** To print out a list of the documents waiting in memory for transmission, press the **MEM. STATUS** key and then the **5** key.

### **To cancel a memory transmission**

If you know the memory number assigned to a memory transmission, you can cancel it with the following procedure. (If you don't know the memory number, use the preceding procedure.)

- 
- 1** Press the **MEM. STATUS** key (flip up the Rapid Key overlay) and then **4**.



The display will show:



- 
- 2** Enter the 3-digit memory number assigned to the transmission you want to cancel.



(Example)

- 
- 3** Press the **START** key to cancel the transmission.



## Cover Sheet

You can have the fax machine generate a cover sheet and send it as the last page of your fax transmission. The cover sheet includes the date and time, the receiver's name and number if a Rapid Key or Speed Dial number is used, the sender's name and number, and the total number of pages.

- ◆ Your name and number must be programmed in order for them to appear on the cover sheet. (See *Entering Your Name and Fax Number* in Chapter 1.)
- ◆ To have the recipient's name appear, you must dial using a Rapid Key or Speed Dial number with the name programmed.
- ◆ Cover Sheet cannot be selected when you use the Relay Request function.

AUTOMATIC COVER SHEET	
DATE:	AUG-08-2000 THU 11:48 AM
TO:	N. T. BANK
FAX #:	4525558865
FROM:	John Doe Corp.
FAX #:	2015551254
02 PAGES WERE SENT (INCLUDING THIS COVER PAGE)	

(Example)

### 1 Load the document(s).

SEND READY will appear in the display.



**2** Press the **COVER SHEET** key.

- The display will briefly show **COVER SHEET MODE ENTERED** and then revert to **SEND READY**.
- To cancel the cover sheet selection, press the **STOP** key.



---

**3** Dial the receiving party and transmit the fax.

If desired, you can set your fax to automatically send a cover sheet with every transmission (you do not have to press the **COVER SHEET** key each time). This is accomplished by setting Option Setting 10 (Auto Cover Sheet) to YES as explained in Chapter 6, *Optional Settings*.

## Batch Page Numbering

You can change the page numbering of the transmitted document from simple numbering ("P.01", "P.02", etc.) to batch numbering, which means that a slash and the total number of pages being sent are added after each page number (for example, "P. 01/05", "P.02/05", etc.). This allows the receiver to check for missing pages.

### 1 Load the document(s).

SEND READY will appear in the display.



### 2 Press the **PAGE COUNTER** key.

The display will show:

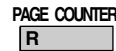

ENTER # OF PAGE(S)  
ENTER # (01-99)

### 3 Enter the total number of pages ("01" to "99") by pressing the numeric keys.



Example: 8 pages

- If you are sending a cover sheet, do not include it in the total number of pages (the number will be adjusted automatically).

- 4** Dial the receiving machine and transmit the document.

### **Comments:**

- ◆ If you need to cancel a batch number entry, remove the document from the feeder or press the **STOP** key.
- ◆ If the number of pages actually transmitted does not coincide with the batch number entered, the alarm will sound and **PAGE COUNT ERROR** will appear in the display. **PAGE E.** will also appear in the **NOTE** column of the Transaction Report if printed.



---

## 3. Receiving Documents

The fax machine has two modes for receiving calls:

**AUTO** mode:

Select this mode when you only want to receive faxes on the line connected to the fax machine. The fax machine will answer all calls automatically and receive incoming faxes.

**MANUAL** mode:

Select this mode when you have an extension phone connected to the same line as the fax machine and you want to receive both faxes and voice calls. **All calls, including faxes, must be answered by picking up the extension phone.**

### Setting the reception mode

---

**1** Press these keys:

The display will show:

1:RECEIVE MODE  
1=AUTO, 2=MANUAL

FUNCTION



---

**2** Press the **1** key to select AUTO, or the **2** key to select MANUAL.

AUTO

MANUAL



or



## Using AUTO Reception Mode

In AUTO reception mode, the fax machine automatically answers all calls on one ring and receives incoming faxes.

- ◆ You can change the number of rings on which the machine answers calls by changing Option Setting 2. (See Chapter 6, *Optional Settings*.)
- ◆ If you pick up an extension phone before the fax machine answers, you can talk to the other party and/or receive a fax as explained below in *Using MANUAL Reception Mode*.

## Using MANUAL Reception Mode

---

- 1** When the fax machine rings, answer the call on an extension phone connected to the same line.

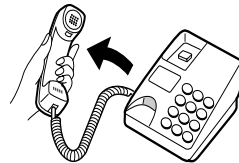

- 2** If you hear a fax tone, press the **START** key on the fax machine.

- If the other party first speaks with you, press the **START** key after speaking. (Press your **START** key before the sender presses their Start key.)



- 3** When RECEIVING appears in the display, hang up.

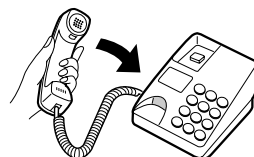

## Substitute Reception to Memory

If the fax machine runs out of paper, toner, or the paper jams, incoming documents will be automatically stored in memory.

When you have received a document in memory, FAX RCVD IN MEMORY will appear in the display, alternating with NO PAPER, REPLACE TONER, or PAPER JAM. When you add paper, replace the toner cartridge, or clear the jam, the stored documents will automatically print out.

You can display information on the documents received to memory by following these steps:

- 1 Press the **MEM. STATUS** key (flip up the Rapid Key overlay) and the **3** key.

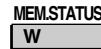

RX STATUS will appear in the display.

- 2 Press the **#** key or the **\*** key to scroll through the list of received documents. The name (or number) of the sender of each document will successively appear in the display.



or



- 3 When you have finished checking the list, press the **STOP** key twice to return to the date and time display.

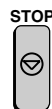

---

## 4. Making Copies

Your fax machine can also be used to make copies. Single and multiple copies (up to 99 per original) can be made, enabling the fax machine to double as an office copier.

- ◆ You can perform all steps of a copy operation even when the fax machine is busy printing other copy jobs, or when it is printing a received document after the line has been disconnected. Your copy job will be automatically stored in memory and then printed when all previous printing jobs are completed.
- ◆ The default resolution for copying is FINE. If desired, you can change the default resolution to SUPER FINE by changing Option Setting 32 (see Chapter 6, *Optional Settings*).

---

### 1 Load the document.

- SEND READY will appear in the display.
- If desired, adjust the resolution and/or contrast.

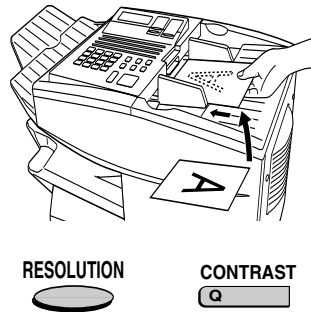

---

### 2 Press the COPY key.

The display will show:

COPY MODE	
ENTER #(01-99)	01



- If you are only making a single copy of the original (or of each original), press the **START** key. Copying will begin.

**3** Enter the desired number of copies per original with the numeric keys.



- If the desired number of copies is from 1 to 9, enter “0” first.
- The display will show:

MULTI/SORT COPY MODE  
1=MULTI, 2=SORT

Example: Three copies per original

**4** Press **1** (MULTI) if you do not want the copies sorted, or **2** (SORT) if you want the copies sorted.

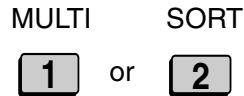

- Copying will begin.

Example of three copies each of three originals

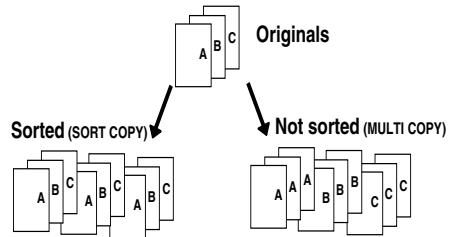

### Checking copy jobs in memory

You can display the status of copy jobs in memory by following the steps below. You can also cancel copy jobs with this procedure.

- 
- 1** Press the **MEM. STATUS** key (flip up the Rapid Key overlay) and then the **1** key.

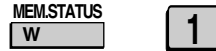

COPY STATUS will appear in the display.

- 
- 2** Press the **#** key or the **\*** key to scroll through the list of copy jobs. The time the original was scanned into memory will appear in the display, together with the 3-digit memory number assigned to the job. To cancel a copy job, press the **CLEAR** key and then the **START** key while the copy job appears in the display.

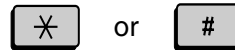

- 
- 3** When you have finished checking the list, press the **STOP** key twice to return to the date and time display.



---

# 5. Special Functions

## Broadcasting

The Broadcasting function allows you to send the same document to multiple locations with just one operation. First load the document, then enter the numbers of the receiving machines. The document will be automatically transmitted to each location.

---

### 1 Load the document (s).

- SEND READY will appear in the display.



---

### 2 Press the **BROADCAST** key.

The display will show:

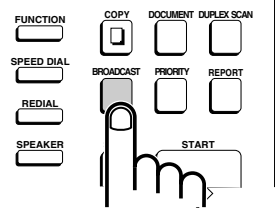

---

### 3 Dial the receiving machines using one or more of the following methods:

- Press one or more Rapid Keys.
- Enter one or more Speed Dial numbers, pressing the **SPEED DIAL** key before each number. (If you enter less than 2 digits for a number on the FO-4650, or 3 digits on the FO-4970, press the **START** key to complete the entry.)

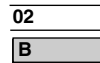

(Example)

- Enter one or more full fax numbers (max. of 20) with the numeric keys, pressing the **START** key after each full number.
- Press one or more Group Keys. (See *Storing numbers in Group Keys* at the end of this section.)

---

**4** Press the **START** key.

The display will show:

BROADCAST MODE  
SELECT THE MODE



- If desired, adjust the resolution and/or contrast.



---

**5** Press the **START** key twice.  
Transmission will begin.

- A Transaction Report is automatically printed out after Broadcasting is completed. Check the "Note" column of the report to see if any of the locations are marked "Busy" or have a communication error code. If so, send the document to those locations again.





## Broadcasting using a Group Key

If the fax machines to which you want to broadcast have all been programmed into one Group Key (see *Storing numbers in Group Keys* which follows), you can perform the broadcasting operation using the following simplified procedure:

### 1 Load the document(s).

- SEND READY will appear in the display.
- If desired, adjust the resolution and/or contrast.

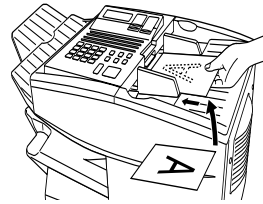

RESOLUTION



CONTRAST



### 2 Press the appropriate Group Key. Transmission will begin.

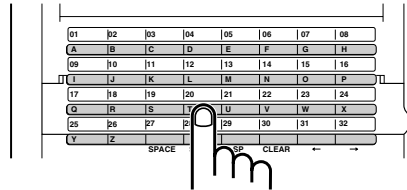

(Example)

### Storing numbers in Group Keys

Group Keys allow you to dial a group of fax numbers by simply pressing the appropriate Group Key once. To store a group of numbers in a Group Key, follow the steps below.

- ◆ Any Rapid Key that is not already programmed as a Rapid Key or a Program Key can be used as a Group Key.
- ◆ Up to 122 numbers can be stored in one Group Key on the FO-4650, or 147 numbers on the FO-4970.
- ◆ Only Rapid Key and Speed Dial numbers (excluding numbers set for Chain Dialing) can be stored in a Group Key. Full numbers cannot be stored.

**1** Press these keys.

The display will show:

2:GROUP ENTRY MODE  
1=SET, 2=CLEAR



**2** Press **1** (SET) to program a Group Key, or **2** (CLEAR) to clear a Group Key.

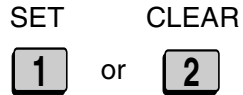

**3** Press any Rapid Key not already programmed to select it as a Group Key.

If you are clearing a Group Key, press it and go to Step 5.

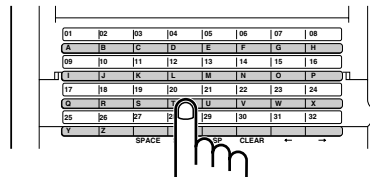

(Example)

**4** Enter fax numbers using one or both of the following methods:

- Press one or more Rapid Keys.
- Enter one or more Speed Dial numbers with the numeric keys, pressing **SPEED DIAL** before each number (if you enter less than 2 digits for a number on the FO-4650, or 3 digits on the FO-4970, press **START** to complete the entry).

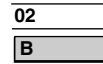

(Example)

**5** Press the **START** key.



**6** Return to Step 3 to program another Group Key, or press the **STOP** key repeatedly until you return to the date and time display.

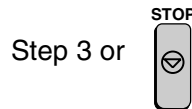

### **Editing a group**

If necessary, you can add numbers to or delete numbers from a group by repeating the programming procedure for the Group Key. Press **1** for SET in Step 2 and select the Group Key in Step 3. Add or delete numbers in Step 4. To add a number, press a Rapid Key or enter a Speed Dial number. To delete a number, move the cursor to the number with the **UP** or **DOWN** key and then press the **CLEAR** key.

## Confidential Operations

The Confidential function can be used to transmit and receive confidential documents.

### Confidential transmission

When you send a document using the Confidential function, the receiving machine holds it in memory instead of immediately printing it out. When the receiving party enters the correct passcode, the document is printed out.

- ◆ Confidential transmission is only possible when the receiving machine is a Sharp model with confidential reception capability.
- ◆ To use this function, your name and fax number (OWN PASS-CODE) must be entered in your fax machine as explained in Chapter 1.
- ◆ Some fax machines have multiple mailboxes for receiving confidential faxes. If you are sending to a machine with multiple confidential mailboxes, contact the receiving party in advance for the appropriate mailbox number.

---

#### 1 Load the document (s).

- SEND READY will appear in the display.
- Set the resolution and/or contrast if desired.



RESOLUTION



CONTRAST



---

#### 2 Press the **CONFIDENTIAL** key and then **1**.

The display will show:



1:CONF. TX  
ENTER BOX # OR START

- 3** If the receiving machine has multiple confidential mailboxes, enter the appropriate mailbox number with the numeric keys (this step is required for machines with multiple mailboxes).



(Example)

If the receiving machine doesn't have multiple mailboxes, go directly to Step 4.

- 4** Press the **START** key.



- 5** Dial the receiving machine using one of the following methods:

- Press a Rapid Key.
- Press the **SPEED DIAL** key and enter a Speed Dial number (if you enter less than 2 digits on the FO-4650, or 3 digits on the FO-4970, press the **START** key to complete the entry). Check the name or number that appears, and then press the **START** key.
- Enter a full telephone number with the numeric keys, and press the **START** key.

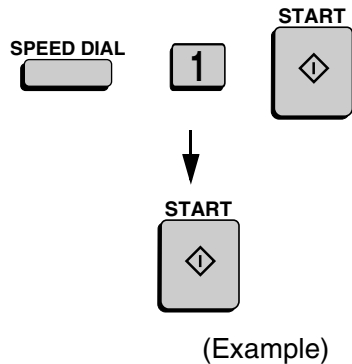

Transmission will take place once the connection is established.

### **Confidential reception**

When another fax machine sends you a document by confidential transmission, your fax machine holds it in memory instead of immediately printing it out. The document cannot be printed out until you enter the correct passcode.

Your fax has 10 "mailboxes" in which confidential documents can be received. Each mailbox has its own passcode, allowing up to 10 different people or groups to each receive their own confidential documents. The mailboxes are identified by 2-digit numbers.

### **Programming the confidential passcode**

To receive a confidential document, you must first program a 2-digit mailbox number and a 4-digit passcode.

**Note:** Be sure to inform the transmitting party of your 2-digit mailbox number in advance. The transmitting party will need this number to send you confidential faxes.

- 
- 1** Press the **CONFIDENTIAL** Key and then **3**.

CONFIDENTIAL  
S

3

The display will show:

3:CONF. CODE SET  
ENTER BOX # (00-99)

- 
- 2** Enter a 2-digit number (from "00" to "99") by pressing the numeric keys. This number identifies the mailbox.

0

1

(Example)

- 3** Enter the 4-digit passcode with the numeric keys.



(Example)

- 4** Press the **START** key.



- 5** Enter a name for the mailbox by pressing the letter entry keys (make sure the Rapid Key overlay is down).



Example: SHARP

- 6** Press the **START** key.



**Note:** After entering the passcode, your fax will print it out for your records. If you forget the passcode and have kept no record, contact your Sharp dealer.

### ***Clearing the passcode***

- 1** Press the **CONFIDENTIAL** Key and then **4**.



The display will show:

4:CONF. CODE CLEAR  
ENTER BOX # (00-99)

- 
- 2** Enter the 2-digit number that identifies the mailbox you want to clear.



(Example)

- 
- 3** Enter the 4-digit passcode of the mailbox with the numeric keys.



(Example)

- 
- 4** Press the **START** key.



### ***Printing out received documents***

When you have received a confidential document, RCVD CONF. FAX will appear in the display. Print out the Confidential Reception List as explained in Chapter 7 to see which mailbox has received the document, and then follow the steps below to print out the document.

- 
- 1** Press these keys:



The display will show:

2:CONF. DATA PRINT  
ENTER BOX # (00-99)

- 
- 2** Enter your mailbox number.



(Example)



---

**3** Enter your confidential passcode.



(Example)

---

**4** Press the **START** key.

- Printing will begin. After printing, the document will be erased from memory.



## ***Relay Request***

Relay Request allows you to send a document to another fax machine and have that fax machine in turn broadcast the document to a group of other fax machines. This function is useful when the relay fax machine is closer to the end fax machines than your fax machine, as it reduces telephone line costs.

### **Important:**

Relay Request can only be used if the intermediate relay machine is a Sharp machine having the Relay Broadcast function.

### ***Storing a relay group***

To make a relay request, you must first store a relay group. This consists of the fax number of the intermediate relay machine and the fax numbers of the end receiving machines. Up to 10 different relay groups can be stored.

- ◆ Fax numbers of the end receiving machines can be entered as Rapid Key numbers, Speed Dial numbers, and/or Group Key numbers if they have been programmed as such **in the relay machine** (not in your fax machine). Check with the operator of the relay machine for these numbers.
- ◆ The total number of end receiving machines which can be entered varies with the model used as the intermediate relay machine. Check with the operator of the relay machine to find out how many receiving machines can be entered.
- ◆ A maximum of 400 digit spaces are available in your fax machine's memory for storing the numbers of end receiving machines. The number of spaces occupied by each number depends on what kind of number it is:

Rapid Key number	4 spaces
Speed Dial number	2 spaces
Group Key number	4 spaces (for one group)
Full number	Number of digits in number (max. of 30 per number)

- ◆ Only 2-digit Speed Dial numbers for end receiving machines can be entered in the relay group. If the receiving machine has 3-digit Speed Dial numbers that you want to enter, ask the operator of the relay machine to store them in a Group Key, and then enter the Group Key in the relay group.

**1** Press the **RELAY** key and then **2**.



The display will show:

2:RELAY GROUP SET  
ENTER #(01-10)

**2** Enter a 2-digit number from “01” to “10”. This number identifies the relay group.



(Example)

**3** Press the **START** key.



---

**4** Enter the fax number of the relay machine using one of the following methods:

- Press a Rapid Key.
- Press the **SPEED DIAL** key and enter a Speed Dial number (if you enter less than 2 digits on the FO-4650, or 3 digits on the FO-4970, press the **START** key to complete the entry).
- Enter the full fax number with the numeric keys.

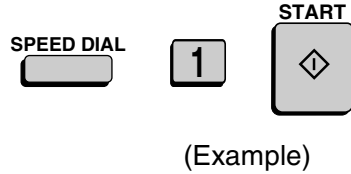

---

**5** Press the **START** key.



---

**6** Press numeric keys (not Rapid Keys) to enter Rapid Key numbers for the end receiving machines that are programmed in the relay machine.



If you don't want to enter Rapid Key numbers, go directly to Step 7.

Example: Rapid Keys 01 and 33

---

**7** Press the **START** key.



- 8** Press numeric keys to enter Speed Dial numbers (2-digit numbers only) for the end receiving machines that are programmed in the relay machine.



Example: Speed Dial numbers 10 and 23

If you don't want to enter Speed Dial numbers, go directly to Step 9.

- 9** Press the **START** key.



- 10** Press numeric keys (not Group Keys) to enter Group Key numbers for end receiving machines that are programmed in the relay machine.



Example: Group Key 30

If you don't want to enter Group Key numbers, go directly to Step 11.

- 11** Press the **START** key.



- 12** Enter full fax numbers of the end receiving machines, pressing the **START** key after each fax number. Include the area code if the number is outside the local dialing area of the relay machine.



(Example)

- 13** When finished, press the **START** key.



- 
- 14** Return to Step 2 to enter another relay group, or press **STOP** repeatedly to return to the date and time display.

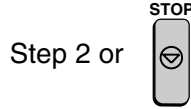

### Clearing a relay group

To clear a relay group, you need to know the 2-digit number that identifies it. You can check the number by printing out the Relay Group List as explained in Chapter 7.

- 
- 1** Press the **RELAY** key and then **3**.

The display will show:

3:RELAY GROUP CLEAR  
ENTER # (01-10)



- 
- 2** Enter the 2-digit number that identifies the group you want to clear.

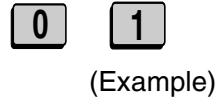

- 
- 3** Press the **START** key.



- 
- 4** Return to Step 2 to clear another relay group, or press **STOP** repeatedly to return to the date and time display.

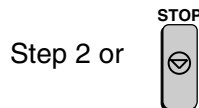

## Requesting a relay transmission

### Important:

To request a relay transmission, your fax number must be entered into the Relay Passcode List of the relay fax machine by the operator of that fax machine. (Your number must also be entered in your fax machine as explained in *Entering Your Name and Fax Number* in Chapter 1.)

### 1 Load the document(s).

SEND READY will appear in the display.

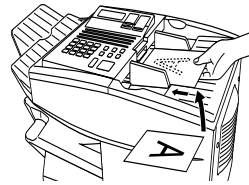

### 2 Press the **RELAY** key and then the **1** key.

1:RELAY TX  
 ENTER # (01-10)



### 3 Enter the 2-digit number of the relay group by pressing the numeric keys.



(Example)

### 4 Press the **START** key.

- Adjust the resolution and contrast if desired.

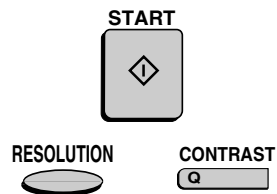

### 5 Press the **START** key.



- 
- 6** Press the **START** key to send the document through memory, or the **DOCUMENT** key to send the document directly from the feeder.

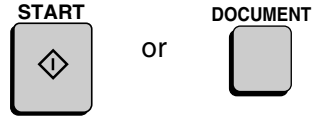

### **Relay Broadcast**

The fax machine can also act as a relay station. It will receive a document from a fax machine requesting a relay transmission, and automatically broadcast it to the stations that the requesting machine specifies.

To enable a fax machine to request a relay transmission, you must first enter its fax number in the Relay Passcode List. Follow the steps below to enter or clear a fax number.

- ◆ When your fax receives a relay request from another fax machine, RCVD RELAY REQUEST will appear in the display.
- ◆ If the telephone billing function is turned on, the fax machine cannot act as a relay station.
- ◆ To clear a fax number from the Relay Passcode List, you need to know the 2-digit number which identifies it. You can check this number by printing out the Passcode List (see Chapter 7).

- 
- 1** Press these keys:

The display will show:



4:RELAY PASSCODE  
1=SET, 2=CLEAR



- 
- 2** Press **1** to enter a number, or **2** to clear a number.

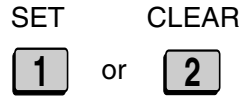

- 
- 3** **Entering:** Enter a 2-digit number ("01" to "10"). This identifies the fax number you will enter in the next step.



(Example)

**Clearing:** Enter the 2-digit number that identifies the fax number you want to clear, and go to Step 5.

- 
- 4** Enter the fax number of the machine to be added to the list (max. 20 digits).



(Example)

- 
- 5** Press the **START** key.



- 
- 6** Return to Step 3 to enter or clear another number, or press the **STOP** key repeatedly to return to the date and time display.

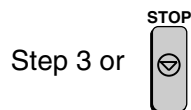

## Polling

Polling allows you to call another fax machine and have it send a document to your machine without operator assistance. In other words, the receiving fax machine, not the transmitting fax machine, initiates the transmission. You can use your fax machine to both poll and be polled by others.

### Polling others

To poll another fax machine, follow the steps below.

- ◆ If desired, you can dial more than one fax number to receive documents consecutively from a group of fax machines (this is called "Serial Polling").

- 
- 1** Press the **FUNCTION** key and **8**.



The display will show:

8:SERIAL POLL. MODE  
ENTER STATION #

- 
- 2** Dial the number(s) of the fax machine(s) you want to poll using one (or more) of the following methods:

- Press one or more Rapid Keys.
- Enter one or more Speed Dial numbers, pressing the **SPEED DIAL** key before each number. (If you enter less than 2 digits on the FO-4650, or 3 digits on the FO-4970, press the **START** key to complete the entry.)



(Example)

- Press one or more Group Keys.

- Enter one or more full fax numbers with the numeric keys, pressing the **START** key after each full number.

- 
- 3** Press the **START** key. Reception will begin.



### ***Serial Polling using a Group Key***

If the fax machines you want to poll have all been programmed into one Group Key, you can poll them by simply pressing that Group Key. (The procedure for programming Group Keys is explained in *Broadcasting* in this chapter.)

- ◆ Make sure no documents are in the feeder before you press the Group Key.

### ***Being polled (Memory polling)***

To let another fax machine poll your fax machine, you must first store the document(s) in memory using the following procedure.

Transmission will take place when the other fax machine calls your fax machine and activates polling. You can choose whether to allow polling only once, or an unlimited number of times. In the latter case, your fax machine can be used as an electronic "bulletin board".

- ◆ Multiple documents can be stored for memory polling. To add a document to others already stored, simply repeating the storing procedure (note that if Department Control is activated, documents cannot be added by a department other than that which stored the first document). When polling is initiated, the polling machine will receive all documents stored.
- ◆ If you allow polling only once, the document(s) will be automatically cleared from memory after polling. If you allow polling an unlimited number of times, the document will remain in memory until you clear it as explained in the following section, *Clearing a document*.

**1** Load the document.

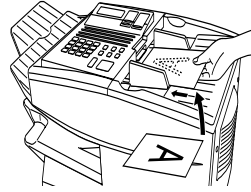

**2** Set the reception mode to AUTO (press the **FUNCTION** key, **1** and **1**).



**3** Press these keys:



The display will show:

9:MEMORY POLL MODE  
ENTER #(1-2,\*,#)

**4** Press **1** to select SET.



- If another document has already been stored, press **1** to select APPEND, and go to Step 6.

**5** Press **1** to allow polling only once, or **2** to allow polling an unlimited number of times.

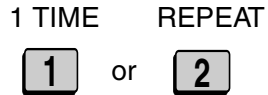

**6** Adjust the resolution and or contrast if desired, and then press the **START** key.



**7** Press the **START** key.



- The document will be scanned into memory, and your fax will go on polling standby.

## Clearing a document

To clear a memory poll document (or documents) from memory, follow the steps below:

**1** Press these keys:

FUNCTION



The display will show:

9:MEMORY POLL MODE  
ENTER #(1-2,\*,#)

**2** Press **2** to select CLEAR.



**3** Press **START** to clear the documents.

START



## Polling Security

Polling Security allows you to prevent unauthorized polling of your fax. When this function is activated, polling will only take place when one of the following conditions is met:

- ◆ The fax number of the polling fax machine has been stored in your fax's list of permitted fax numbers (called "passcode numbers"). The polling fax must also have its fax number programmed in itself, as described in *Entering Your Name and Fax Number* in Chapter 1.
- ◆ A System number has been programmed in the polling fax machine which matches your fax's System number or one of your ID numbers.
- ◆ An ID number has been programmed in the polling fax machine which matches your fax's System number.

System and ID numbers are 4-digit numbers which provide you with an alternate means of giving and receiving polling permission when you don't want to use fax numbers. The steps for programming these numbers are described in the following pages.

**Note:** System and ID numbers can only be used if the other fax machine is also a Sharp machine.

### Turning Polling Security on and off

Polling Security is turned on or off with Option Setting 8. This procedure is explained in Chapter 6, *Optional Settings*.

### Storing and clearing fax numbers for polling permission

You can store up to 10 fax numbers in your fax's list of permitted numbers.

---

**1** Press these keys:



The display will show:



---

**2** Press **1** to set a number, or **2** to clear a number..

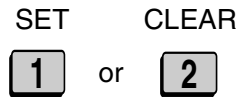

---

**3 Storing:** Enter a 2-digit number (from 01 to 10). This number identifies the fax number you will enter in the next step.



(Example)

**Clearing:** Enter the 2-digit number which identifies the fax number you want to clear, and go to Step 5.

- 4** Enter the fax number (max. 20 digits) by pressing the numeric keys.



(Example)

- 5** Press the **START** key.



- 6** Return to Step 3 to enter (or clear) another number, or press **STOP** repeatedly to return to the date and time display.

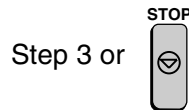

### Programming and clearing a System number

One 4-digit System number can be programmed in your fax machine for giving and receiving polling permission. Polling will take place if your System number matches the other fax machine's System number or one of its ID numbers.

- 1** Press these keys:

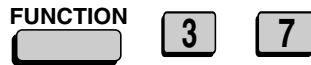

The display will show:

7:SYSTEM # MODE  
1=SET, 2=CLEAR

- 2** Press **1** to program the System number, or **2** to clear it.

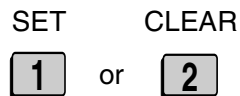

- If you pressed **2**, go to Step 4.

- 
- 3** Enter the number (4 digits) with the numeric keys.



(Example)

- 
- 4** Press the **START** key.



- 
- 5** Press the **STOP** key repeatedly to return to the date and time display.



### **Storing and clearing ID numbers for polling permission**

Up to five 4-digit ID numbers can be programmed in your fax machine for giving and receiving polling permission. Polling will take place if one of your ID numbers matches the other fax machine's System number.

- 
- 1** Press these keys:



The display will show:

6:ID # MODE  
1=SET, 2=CLEAR

- 
- 2** Press **1** to program an ID number, or **2** to clear an ID number.

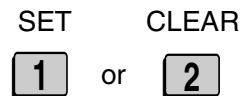



**3 Storing:** Enter a number from 1 to 5.

This number identifies the ID number you will enter in the next step.



(Example)

**Clearing:** Enter the number which identifies the ID number you want to clear, and go to Step 5.

**4** Enter the ID number (4 digits) by pressing the numeric keys.

(Example)

**5** Press the **START** key.**6** Return to Step 3 to enter (or clear) another number, or press **STOP** repeatedly to return to the date and time display.

Step 3 or



## **Power Save Mode**

Power Save Mode allows you to conserve power by turning off the laser printer heater in the fax machine. While Power Save Mode is on, the laser printer heater remains off and incoming faxes are received to memory. When Power Save Mode is turned off, the printer heater turns on and the faxes received to memory are printed out.

- ◆ Power Save Mode can be turned on and off manually by pressing the **POWER SAVE** key.
- ◆ If desired, you can also set Power Save Mode to turn on and off automatically at specified times of the day, on specified days of the week, and on specified dates during the year.

**Note:** If the memory becomes full while Power Save Mode is on, the fax machine will automatically turn on the laser printer, print the faxes received to memory, and then return to Power Save Mode.

**Note:** Power Save Mode cannot be turned on when the Print Hold function is on.

### **Selecting the Power Save Type**

Before turning on Power Save Mode, you will need to select the method by which it is turned on and off. There are two selections: REAL TIME, which means that you turn Power Save Mode on and off by simply pressing the **POWER SAVE** key, and TIMER, which means that Power Save Mode turns on and off automatically at preset times.

- ◆ The initial setting is REAL TIME.

---

**1** Press these keys:

**FUNCTION**



The display will show:

4:OPTIONAL SETTING  
ENTER #(01-34,\*,#)

- 2** Enter **34** by pressing the numeric keys.



The display will show:

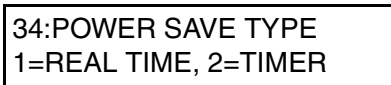

Note: Power Save Type cannot be selected if Power Save Mode is on. To turn off Power Save Mode, simply press the Power Save key once.

- 3** Press **1** to select REAL TIME, or **2** to select TIMER.

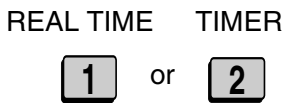

- 4** Press the **STOP** key twice to return to the date and time display.

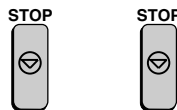

**Turning on Power Save Mode when REAL TIME is selected**

To turn on Power Save Mode when REAL TIME is selected, simply press the **POWER SAVE** key. POWER SAVE MODE will appear in the display.

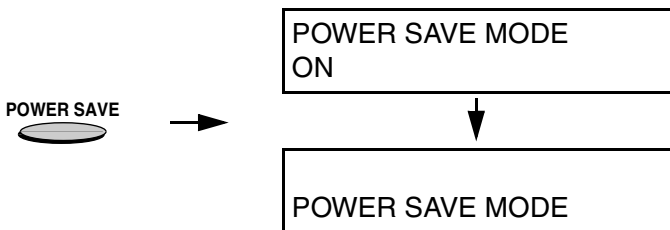

To turn off Power Save Mode, press the **POWER SAVE** key once again. POWER SAVE MODE OFF will appear briefly, followed by the normal date and time display.

### Turning on Power Save Mode when **TIMER** is selected

When **TIMER** is selected, Power Save Mode turns on and off automatically at the times you specify. Follow the steps below to set the on and off times.

---

**1** Press the **POWER SAVE** key.



The display will show:

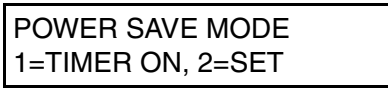

---

**2** Press **2** to select SET.



- **Note:** If you have already entered the timer settings and simply wish to turn on the timer, press **1** (**TIMER ON**).

---

**3** Enter the time you want Power Save Mode to turn on every day (**START TIME**). Enter two digits for the hour (01 to 12) and two digits for the minute (00 to 59). When finished, enter \* for A.M. or # for P.M.



Example: 5:00 P.M.

- 4** Enter the time you want Power Save Mode to turn off every day (END TIME). Enter two digits for the hour (01 to 12) and two digits for the minute (00 to 59). When finished, enter \* for A.M. or # for P.M.



Example: 8:00 A.M.

- 5** Press the **START** key.

**Note:** The above daily time settings will be in effect every day and are required. The following WEEKEND and PERIOD settings are optional, and are used to set additional weekly and yearly time periods that Power Save Mode will turn on.



The display will show:

WEEKEND SETTING  
1=YES, 2=NO

- 6** Press **1** if you want to set a day or days of the week (such as the weekend) that you want Power Save Mode to turn on. If not, press **2** and go to Step 8.

YES                      NO  
    or

---

**7** Enter a 1-digit number for the day each week you want Power Save Mode to turn on, and a 1-digit number for the day after which you want it to turn off:

- 0: Sunday
- 1: Monday
- 2: Tuesday
- 3: Wednesday
- 4: Thursday
- 5: Friday
- 6: Saturday



Example: Power Save Mode will turn on from Saturday through Sunday

---

**8** Press the **START** key.

The display will show:

PERIOD SETTING  
1=YES, 2=NO



---

**9** Press **1** if you want to set a period during the year (such as an extended holiday) that Power Save Mode will turn on. If not, press **2** and go to Step 12.

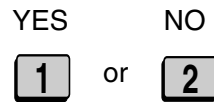

---

**10** Enter the starting day of the period you want Power Save Mode to be on. Enter a 2-digit number for the month (01 to 12), and a 2-digit number for the day (01 to 31).



Example:  
December 24th

- 11** Enter the ending day of the period you want Power Save Mode to be on. Enter a 2-digit number for the month (01 to 12), and a 2-digit number for the day (01 to 31).



Example:  
January 1st

- 12** Press the **START** key.

The display will show:

TIMER ON?  
1=YES, 2=NO



- 13** Press **1** if you want to activate the timer immediately, or **2** if you want to activate the timer at a later time.

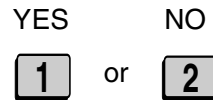

- The timer settings will not take effect until you activate the timer. If you select **2** (NO), you can activate the timer at a later time by pressing the **POWER SAVE** key and then **1** to select **TIMER ON**.

## Timer Operations

The Timer function allows you to set up an operation to be performed automatically at a specified time. Up to 48 operations can be set at any one time, and the time of each can be set up to a week in advance.

You can use this function to take advantage of lower off-peak rates without having to be there when the operation is performed.

**Note:** The **DOCUMENT** key cannot be used for a timer transmission.

### Initial procedure

To set a timer operation, first perform the following procedure. After you have completed this procedure, go to the procedure for the specific operation you want to set (see the following pages).

- 
- 1** Press the **TIMER** key.



The display will show:

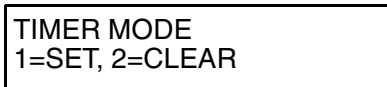

- 
- 2** Press **1** to select SET.



- 
- 3** Press the **\*** key or the **#** key until the desired operation appears in the display.

Transmission (SEND MODE)  
Confidential transmission  
Polling  
Serial Polling  
Broadcasting  
Relay Request





**4** Press the **START** key.



**5** Enter a two-digit number for the hour (“01” to “12”) and a two-digit number for the minute (“00” to “59”).



Example: 9:25

**6** Press the **\*** key to select A.M. or the **#** key to select P.M.

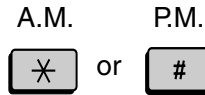

**7** Enter a 1-digit number for the day of the operation (skip this step if the operation will be performed within the next 24 hours):

- 0: Sunday
- 1: Monday
- 2: Tuesday
- 3: Wednesday
- 4: Thursday
- 5: Friday
- 6: Saturday



Example: Monday

**8** Press the **START** key and go to the specific procedure for your operation (see the following pages).



## Transmission

(Continued from *Initial procedure.*)

---

**9** Dial the receiving machine using one of the following methods:

- Press a Rapid Key.
- Press the **SPEED DIAL** key and enter a Speed Dial number (if you enter less than 2 digits on the FO-4650, or 3 digits on the FO-4970, press the **START** key to complete the entry).
- Enter a full fax number with the numeric keys.



(Example)

---

**10** Press the **START** key.



---

**11** Adjust the resolution and or contrast if desired, and then press the **START** key.



**12** Load the document and then press the **START** key.

- The document will be scanned into memory.

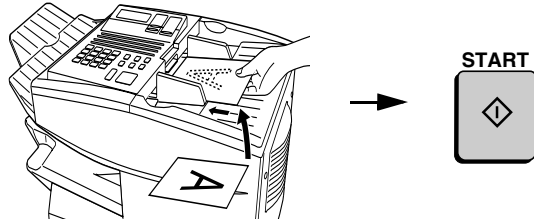

### **Confidential transmission**

(Continued from *Initial procedure.*)

**9** Enter the mailbox number (2 digits).  
(Go directly to Step 10 if the receiving machine does not have mailboxes.)



(Example)

**10** Press the **START** key.



---

**11** Dial the receiving machine using one of the following methods:

- Press a Rapid Key.
- Press the **SPEED DIAL** key and enter a Speed Dial number (if you enter less than 2 digits on the FO-4650, or 3 digits on the FO-4970, press the **START** key to complete the entry).
- Enter a full fax number with the numeric keys.

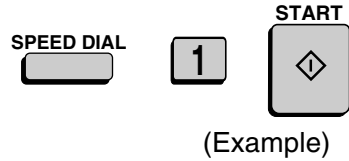

---

**12** Press the **START** key.



---

**13** Adjust the resolution and or contrast if desired, and then press the **START** key.

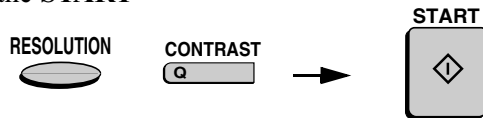

---

**14** Load the document and then press the **START** key.

- The document will be scanned into memory.

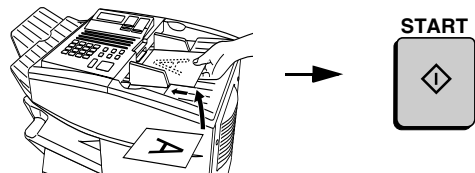

## Polling

(Continued from *Initial procedure.*)

**9** Dial the machine to be polled using one of the following methods:

- Press a Rapid Key.
- Press the **SPEED DIAL** key and enter a Speed Dial number (if you enter less than 2 digits on the FO-4650, or 3 digits on the FO-4970, press the **START** key to complete the entry).
- Enter a full fax number with the numeric keys.

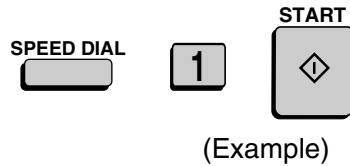

**10** Press the **START** key.



## Serial Polling

(Continued from *Initial procedure.*)

---

**9** Dial the machines to be polled using one or more of the following methods:

- Press one or more Rapid Keys.
- Enter one or more Speed Dial numbers, pressing the **SPEED DIAL** key before each number. (If you enter less than 2 digits on the FO-4650, or 3 digits on the FO-4970, press the **START** key to complete the entry.)

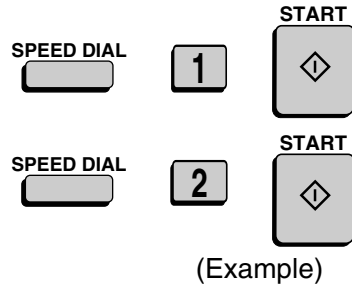

- Enter one or more full fax numbers with the numeric keys, pressing the **START** key after each full number.
- Press one or more Group Keys.

---

**10** Press the **START** key.



## Broadcasting

(Continued from *Initial procedure.*)

**9** Dial the receiving machines using one or more of the following methods:

- Press one or more Rapid Keys.
- Enter one or more Speed Dial numbers, pressing the **SPEED DIAL** key before each number. (If you enter less than 2 digits on the FO-4650, or 3 digits on the FO-4970, press the **START** key to complete the entry.)
- Enter one or more full fax numbers with the numeric keys, pressing the **START** key after each full number.
- Press one or more Group Keys.

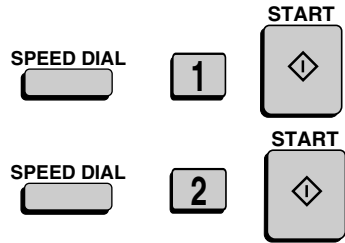

(Example)

**10** Press the **START** key.



**11** Adjust the resolution and or contrast if desired, and then press the **START** key.



**12** Load the document and then press the **START** key.

- The document will be scanned into memory.

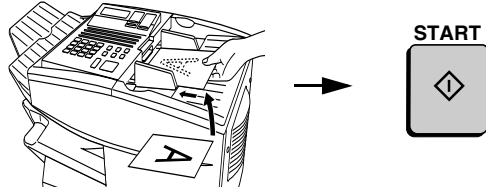

### **Relay Request**

(Continued from *Initial procedure.*)

---

**9** Enter the 2-digit relay group number by pressing the numeric keys.



(Example)

---

**10** Press the **START** key.



**11** Adjust the resolution and or contrast if desired, and then press the **START** key.

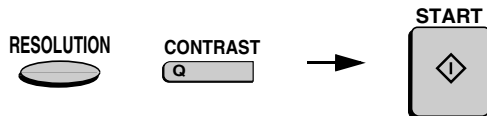



**12** Load the document and then press the **START** key.

- The document will be scanned into memory.

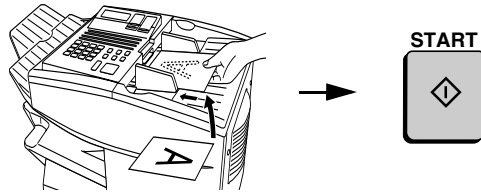

### **Canceling a timer operation**

If you need to cancel a timer operation before it is performed, follow the steps below.

- ◆ You will need to know the number assigned to the operation in order to cancel it. If you don't remember the number (it appears in the display when you set the operation), print out the Timer List. (See Chapter 7, *Printing Out Reports and Lists*.)

**1** Press the **TIMER** key and then **2**.

The display will show:



2:TIMER COMM. CLEAR  
ENTER #(01-48)

**2** Enter the 2-digit number assigned to the operation.



(Example)

**3** Press the **START** key.



**4** Press the **STOP** key repeatedly until you return to the date and time display.

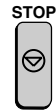

## ***Batch Transmission***

Batch transmission allows you to store a number of documents in memory for automatic transmission to one location at a set time. If you often send documents to a particular location, this function helps reduce telephone line costs by allowing you to conveniently send multiple documents on one connection.

**Note:** If the telephone billing function is turned on, the batch transmission function cannot be used.

### ***Programming a Batch Key***

To perform a batch transmission, you must first program the number of the receiving machine and the time of transmission into a Batch Key. Any Rapid Key which has not already been programmed can be used as a Batch Key.

If you specify a day-of-the-week in your program, the transmission will be performed every week on that day. If you do not specify a day-of-the-week, the transmission will be performed every day.

To program a Batch Key, follow the procedure for entering programs explained in *Entering and Using Programs* in this chapter. In Step 10 of the initial procedure, select “Batch transmission”.

### ***Clearing a Batch Key***

To clear a Batch Key, follow the procedure explained in *Clearing a Program Key* in *Entering and Using Programs* in this chapter.

### ***Storing documents for transmission***

Up to 56 jobs (a job can consist of multiple pages) can be held in memory for batch transmissions at any one time, regardless of the number of Batch Keys used. When you store a document, it is given a message number to distinguish it from other documents sent in the same batch.

- ◆ If no documents have been stored under a Batch Key when the time for transmission arrives, transmission will not take place.

---

## 1 Load the document (s).

- SEND READY will appear in the display.



---

## 2 Press the appropriate Batch Key.

- After scanning, the message number assigned to your document will appear in the display.

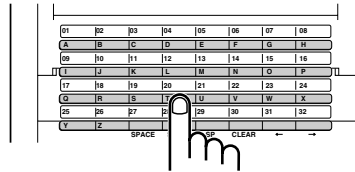

(Example)

---

## 3 Press the **STOP** key.

- The document will be transmitted at the designated time along with any other jobs stored under the same key. After transmission, all jobs in the batch will be cleared from memory.



### Canceling a document stored for batch transmission

If necessary, you can cancel a document stored for a batch transmission before transmission takes place. To do so, you will need to know the message number assigned to the document.

- ◆ If you don't remember the message number, print out the Batch Transmission List (see *Batch Transmission List* in Chapter 7).

**1** Press the Batch Key in which the document you want to clear has been stored.

- Make sure no documents are in the feeder.

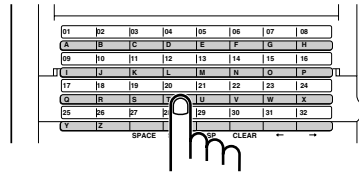

(Example)

**2** Enter the 3-digit message number assigned to the document.



(Example)

**3** Press the **START** key.



## Entering and Using Programs

If you frequently perform the same operation involving the same party, you can program all the steps of the operation into one Program Key. This allows you to perform the operation by simply pressing that key.

- ◆ Any Rapid Key which is not already programmed as a Rapid Key or a Group Key can be used as a Program Key.
- ◆ You can also include a timer setting in the program to have the operation performed automatically at a selected time.
- ◆ To clear a mistake, press the **STOP** key.

### Initial procedure

To program a Program Key, first perform the following procedure. After you have completed this procedure, go to the procedure for the specific operation you want to program (see the following pages).

---

**1** Press these keys:



The display will show:

1:PROGRAM ENTRY MODE  
1=SET, 2=CLEAR

---

**2** Press **1** to select SET.



---

**3** Select a Program Key by pressing any Rapid Key that has not yet been programmed.

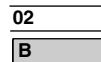

(Example)

- 4** Enter a name for the program by pressing the letter entry keys. (If you don't want to enter a name, go directly to Step 5.)



Example: SHARP

- 5** Press the **START** key.



- 6** If you want to include a timer setting, enter a two-digit number for the hour ("01" to "12") and a two-digit number for the minute ("00" to "59"). (If not, go directly to Step 9.)



Example: 9:25

- 7** Press the **\*** key to select A.M. or the **#** key to select P.M.

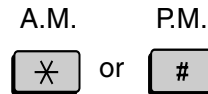

- 8** Enter a 1-digit number for the day of the operation (skip this step if the operation will be performed within the next 24 hours):



- 0: Sunday
- 1: Monday
- 2: Tuesday
- 3: Wednesday
- 4: Thursday
- 5: Friday
- 6: Saturday

Example: Monday

**9** Press the **START** key.



---

**10** Press the **\*** key or the **#** key until the desired operation appears in the display.

- Transmission (SEND MODE)
- Confidential transmission
- Polling
- Serial Polling
- Broadcasting
- Relay Request
- Batch transmission (this will only appear if a timer setting was made)
- Memory Polling (this will not appear if a timer setting was made)



---

**11** Press the **START** key and go to the specific procedure for your operation (see the following pages).





## Transmission

(Continued from *Initial procedure.*)

**12** Dial the receiving machine using one of the following methods:

- Press a Rapid Key.
- Press the **SPEED DIAL** key and enter a Speed Dial number (if you enter less than 2 digits on the FO-4650, or 3 digits on the FO-4970, press the **START** key to complete the entry).
- Enter a full fax number with the numeric keys.



(Example)

**13** Press the **START** key.



**14** Adjust the resolution and or contrast if desired, and then press the **START** key.



- 15** If you want the document to be sent through memory, press the **START** key.

If you want the document to be sent directly from the feeder, press the **DOCUMENT** key. (This is not possible if you included a timer setting.)

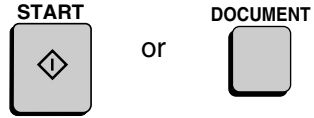

- 
- 16** Press the **STOP** key repeatedly until you return to the date and time display.



### **Confidential transmission**

(Continued from *Initial procedure.*)

---

- 12** Enter the mailbox number (2 digits). (Go directly to Step 13 if the receiving machine does not have mailboxes.)

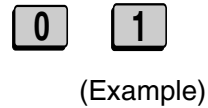

- 
- 13** Press the **START** key.



**14** Dial the receiving machine using one of the following methods:

- Press a Rapid Key.
- Press the **SPEED DIAL** key and enter a Speed Dial number (if you enter less than 2 digits on the FO-4650, or 3 digits on the FO-4970, press the **START** key to complete the entry).
- Enter a full fax number with the numeric keys.



(Example)

**15** Press the **START** key.



**16** Adjust the resolution and or contrast if desired, and then press the **START** key.

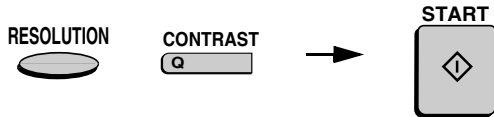

**17** If you want the document to be sent through memory, press the **START** key.

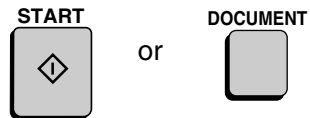

If you want the document to be sent directly from the feeder, press the **DOCUMENT** key. (This is not possible if you included a timer setting.)

- 18** Press the **STOP** key repeatedly until you return to the date and time display.



**Polling**

(Continued from *Initial procedure.*)

---

- 12** Dial the machine to be polled using one of the following methods:

- Press a Rapid Key.
- Press the **SPEED DIAL** key and enter a Speed Dial number (if you enter less than 2 digits on the FO-4650, or 3 digits on the FO-4970, press the **START** key to complete the entry).
- Enter a full fax number with the numeric keys.

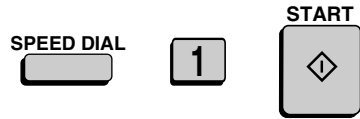

(Example)

- 13** Press the **START** key.



- 14** Press the **STOP** key repeatedly until you return to the date and time display.



## Serial Polling

(Continued from *Initial procedure.*)

**12** Dial the machines to be polled using one or more of the following methods:

- Press one or more Rapid Keys.
- Enter one or more Speed Dial numbers, pressing the **SPEED DIAL** key before each number. (If you enter less than 2 digits on the FO-4650, or 3 digits on the FO-4970, press the **START** key to complete the entry.)

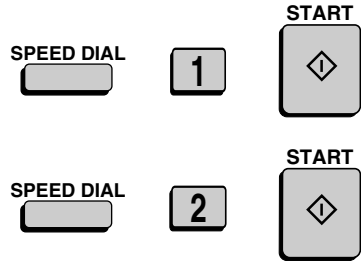

(Example)

- Enter one or more full fax numbers with the numeric keys, pressing the **START** key after each full number.
- Press one or more Group Keys.

**13** Press the **START** key.



**14** Press the **STOP** key repeatedly until you return to the date and time display.



### Broadcasting

(Continued from *Initial procedure.*)

**12** Dial the receiving machines using one or more of the following methods:

- Press one or more Rapid Keys.
- Enter one or more Speed Dial numbers, pressing the **SPEED DIAL** key before each number. (If you enter less than 2 digits on the FO-4650, or 3 digits on the FO-4970, press the **START** key to complete the entry.)
- Enter one or more full fax numbers with the numeric keys, pressing the **START** key after each full number.
- Press one or more Group Keys.

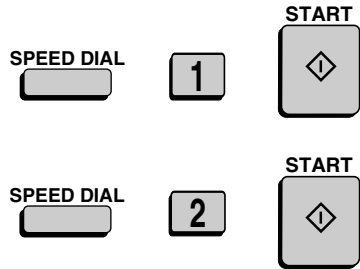

(Example)

**13** Press the **START** key.



**14** Adjust the resolution and or contrast if desired, and then press the **START** key.



**15** Press the **START** key



**16** Press the **STOP** key repeatedly until you return to the date and time display.



### Relay Request

(Continued from *Initial procedure*.)

**12** Enter the 2-digit relay group number by pressing the numeric keys.

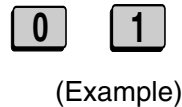

**13** Press the **START** key.



**14** Adjust the resolution and or contrast if desired, and then press the **START** key.

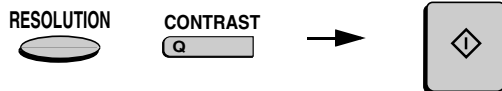

- 
- 15** If you want the document to be sent through memory, press the **START** key.

If you want the document to be sent directly from the feeder, press the **DOCUMENT** key. (This is not possible if you included a timer setting.)

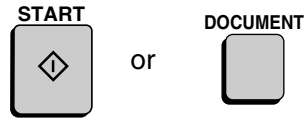

- 
- 16** Press the **STOP** key repeatedly until you return to the date and time display.



### **Batch transmission**

(Continued from *Initial procedure*.)

- 
- 12** Dial the receiving machine using one of the following methods:

- Press a Rapid Key.
- Press the **SPEED DIAL** key and enter a Speed Dial number (if you enter less than 2 digits on the FO-4650, or 3 digits on the FO-4970, press the **START** key to complete the entry).
- Enter a full fax number with the numeric keys.

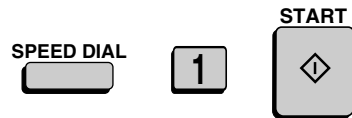

(Example)



**13** Press the **START** key.



**14** Adjust the resolution and or contrast if desired, and then press the **START** key.

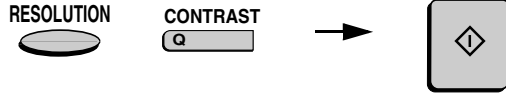

**15** Press the **START** key



**16** Press the **STOP** key repeatedly to return to the date and time display.



**Being Polled (Memory polling)**

(Continued from *Initial procedure.*)

**12** Press **1** to allow polling only once, or **2** to allow polling an unlimited number of times.

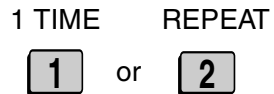

**13** Press the **START** key.



- 
- 14** Adjust the resolution and or contrast if desired, and then press the **START** key.

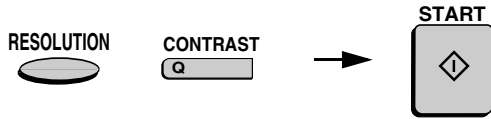

- 
- 15** Press the **START** key



- 
- 16** Press the **STOP** key repeatedly until you return to the date and time display.



### ***Clearing a Program Key***

To clear a Program Key, follow these steps:

- 
- 1** Press these keys:



The display will show:

1:PROGRAM ENTRY MODE  
1=SET, 2=CLEAR

- 
- 2** Press **2** to select CLEAR.



- 
- 3** Press the Program Key you want to clear.

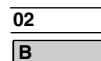

(Example)

**4** Press the **START** key.



**5** Press the **STOP** key repeatedly until you return to the date and time display.



### Using a Program Key

Follow the steps below to perform a programmed operation.

**1** If this is a transmission or memory polling operation, load the document.

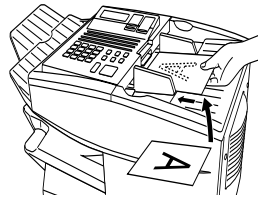

**2** Press the appropriate Program Key.



(Example)

### ***Canceling a programmed timer operation***

If a Program Key has been pressed for a timer operation and you need to cancel the operation before it is performed, follow the steps below.

**Note:** This procedure will not work for a document stored for a batch transmission. To cancel a batch transmission operation, see *Canceling a document stored for batch transmission in Batch Transmission* in this chapter.

- 
- 1** Press the Program Key.

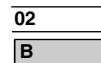

(Example)

- 
- 2** Press the **START** key.



## Duplex Scanning for Two-sided Documents

To transmit or copy documents which have printing or graphics on both sides of the page or pages, use Duplex Scanning. With this function, you simply feed the document (all pages) through the machine once, turn the stack of pages over, and feed it through again.

- ◆ The machine will automatically sort the pages into the correct order (front of 1st page, back of 1st page, front of 2nd page, back of 2nd page, etc.).
- ◆ Duplex Scanning can be used for copying (single copies and sorted multiple copies only) and any type of transmission from memory.
- ◆ Note that any blank sides must be included when scanning the pages (if the number of pages is not equal each time the machine scans the stack, an error will result). The blank sides will not, however, be printed out.

### 1 Load the document (s).

- Make sure the page(s) are front face down, with the first page on the bottom.
- SEND READY will appear in the display.



### 2 Press the **DUPLEX SCAN** key and then the **START** key.

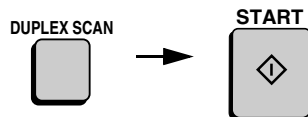

**3** Perform all steps of the desired copy or memory transmission.

---

**4** When all pages of the document have been scanned, turn the stack over (do not change the page order) and load it again.

---

**5** Press the **START** key.



## Print Hold

If desired, you can have the fax hold all received documents in memory instead of immediately printing them out. When you enter the correct Print Hold code, the documents will print out.

### Programming the Print Hold code

To use Print Hold, you must first program a 4-digit Print Hold code. Follow the steps below to program or clear the code.

- 1** Press these keys:



The display will show:

6:PRINT HOLD  
ENTER #(1-3,\*,#)

- 2** Press **2** key to program the Print Hold code, or **3** to clear the Print Hold code. (Note: To clear the code, Option Setting 30 must be set to NO.)

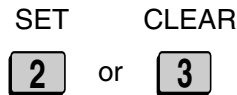

- 3** Enter the 4-digit Print Hold code by pressing the numeric keys.



(Example)

- 4** Press the **START** key.



**Note:** After entering the passcode, your fax will print it out for your records. If you forget the passcode and have kept no record, contact your Sharp dealer.

### Turning on Print Hold

To turn on the Print Hold function, set Option Setting 30 to YES. This procedure is explained in Chapter 6, *Optional Settings*.

**Note:** The Print Hold function cannot be turned on when Power Save Mode is on.

### Printing out received documents

When the Print Hold function is turned on and you have received documents in memory, RCVD PRINT HOLD FAX will appear in the display. Follow the steps below to print out the documents:

- 
- 1** Press these keys:



The display will show:

1:HOLD DATA PRINT  
ENTER PASSCODE #

- 
- 2** Enter the 4-digit Print Hold code by pressing the numeric keys.



(Example)

- 
- 3** Press the **START** key.





## Department Control

Department Control is used to limit use of the fax machine to authorized users. When it is activated, a department code must be entered before an operation can be performed.

- ◆ Department Control can only be activated by your Sharp dealer. If you want to use this function, contact your dealer.
- ◆ Department Control allows you to track the number of pages transmitted as well as the transmission time for each authorized department or person. See *Department Usage List* in Chapter 7.

### Entering Department Codes

Up to 30 different Department Codes can be entered to allow access to the fax machine. Transmitted pages and transmission time will be kept track of separately for each code. After you enter a code, inform the appropriate group or individual.

- ◆ A name must be entered for each code. Only the name, not the code, will appear on the Department Usage List.
- ◆ Be sure to keep a record of each code and name. If you misplace the record, contact your dealer.

---

**1** Press these keys:

FUNCTION



The display will show:

9:DEPT. CODE MODE  
1=SET, 2=CLEAR

---

**2** Press **1** to program a Department Code, or **2** to clear a Department Code.

SET



or

CLEAR



**3 Entering:** Enter a 2-digit number from “01” to “30” with the numeric keys. This number identifies the Department Code that you will enter in the next step.

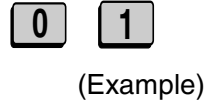

**Clearing:** Enter the 2-digit number that identifies the Department Code you want to clear.

**Note:** It is not possible to clear the Department Code that you currently used to access the fax machine. It is also not possible clear a Department Code if only one code is programmed.

---

**4 Entering:** Enter a Department Code (4 digits or the number of digits set by Option Setting 27).

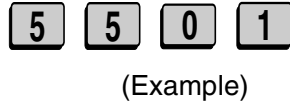

**Clearing:** Enter the Department Code you want to clear, and go to Step 7.

---

**5** Press the **START** key.



**6** Enter a name for the Department Code.



(Example)

---

**7** Press the **START** key.



- 8** Return to Step 3 to enter (or clear) another Department Code, or press the **STOP** key one or more times until you return to the date and time display.

Step 3 or



### ***Accessing the machine***

When Department Control is activated, you must enter your Department Code before performing an operation.

**Note:** You do not have to enter a Department Code to receive faxes manually (by picking up an extension phone connected to the same line and pressing the **START** key on the fax machine).

Enter your Department Code by pressing the numeric keys, and then perform the desired operation.



(Example)

- If you do not begin the operation within one minute after entering the code, the fax will return to controlled access mode.

## ***Blocking Reception of Unwanted Faxes***

The Anti Junk Fax function allows you to block reception of faxes from parties which you specify. This saves paper by not printing out unwanted "junk" faxes.

To use this function, first turn it on by setting Option Setting 20 (Anti-Junk Fax) to YES as explained in Chapter 6, and then enter the fax numbers from which you do not want to receive faxes as shown below.

- ◆ Up to 50 numbers can be entered in the Anti Junk Number List.
- ◆ To clear a number from the Anti Junk Number List, you need to know the 2-digit number which identifies it. If you have forgotten this number, print out the Anti Junk Number List as explained in Chapter 7.

---

**1** Press these keys:



The display will show:

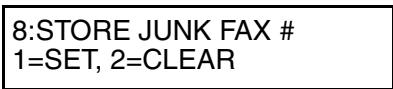

---

**2** Press **1** to enter a number in the Anti Junk Number List, or **2** to clear a number from the list.

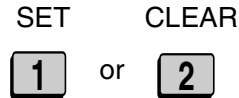

- 3 Entering:** Enter a 2-digit number from “01” to “50” with the numeric keys. This number identifies the fax number that you will enter in the next step.

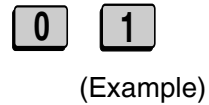

**Clearing:** Enter the 2-digit number that identifies the fax number you want to clear, and go to Step 5.

- 4** Enter the fax number.



- 5** Press the **START** key.



- 6** Return to Step 3 to enter (or clear) another fax number, or press the **STOP** key repeatedly to return to the date and time display.

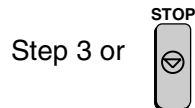

## ***Telephone Billing***

If you are on a PBX, you can have the fax machine send a code to the PBX that identifies the sender for billing purposes each time a fax is sent. Telephone billing is possible in two ways: using Department Control and by direct billing code entry.

### ***Using Department Control***

If you are using the Department Control function, you can use Department Codes for telephone billing. In this case, the fax machine will automatically send the Department Code that a department member enters to access the fax machine to the PBX. The PBX can then use the Department Code to bill the call to that department.

To use Department Control for telephone billing, program a Department Code for each group that will use the fax machine (see *Department Control* in this chapter), and then have your dealer activate Department Control. After this, set Option Setting 26 (Telephone Billing Code) to ON as explained in Chapter 6, *Optional Settings*.

### ***Direct billing code entry***

If you don't want to use Department Control for telephone billing, you can have users enter an assigned billing code (any number up 9 digits long) each time they use the fax machine. The fax machine will automatically send this code to the PBX for billing purposes. To use this function, have your dealer activate the function and then set Option Setting 26 (Telephone Billing Code) to ON as explained in Chapter 6, *Optional Settings*.

**Note:** The billing code should be assigned by your PBX administrator. Billing codes are not programmed into the fax machine.

Users should enter their billing code as follows when performing an operation on the fax machine. The code need only be entered when calling outside of the PBX.

**1** Load the document (s).

- If you are using Normal Dialing, press the **SPEAKER** key or pick up an extension phone connected to the same line.
- **SEND READY** will appear in the display.

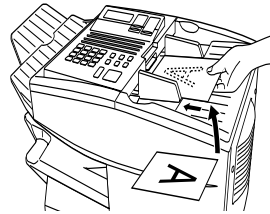

**2** Enter the code to access an outside line (max. of 3 digits).



(Example)

**3** Flip down the Rapid Key overlay and press the **Z** key, enter the billing code (max. of 9 digits), and then press the **Z** key again.



(Example)

- Note: The code will appear as asterisks in the display and will not appear in the Activity List or Transaction Report.

**4** Adjust the resolution and/or contrast if desired.



**5** Dial the other party by the desired method and transmit the document.

## ***Distinctive Ring***

### **Important:**

- ◆ To use distinctive ring, you must subscribe to a distinctive ring service from your local phone company.
- ◆ Your fax machine may not be compatible with some distinctive ring services.

Distinctive ring is a service offered by some local telephone companies whereby they assign an additional second number to your regular single line. The second number rings differently from your normal number.

If you subscribe to a distinctive ring service, you can set the fax machine to automatically answer when your second number is called. This allows you to use the second number as an exclusive fax number.

To have your fax automatically answer when your second number is called, follow the steps below:

---

**1** Press these keys:



The display will show:

4:OPTIONAL SETTING  
ENTER #(01-34,\*,#)

---

**2** Enter the number **28** by pressing the numeric keys.





- 
- 3** Press a number from **1** to **3** to select the ring pattern below that matches your second number's ring pattern. Or, press **4** to have your fax automatically answer your normal telephone number. Press **5** to turn off the distinctive ring function.

<b>1</b>	RING PATTERN 1	Two short rings
<b>2</b>	RING PATTERN 2	One short, one long, and one short ring
<b>3</b>	RING PATTERN 3	Two short rings and one long ring
<b>4</b>	STANDARD RING	Your standard (normal) ring pattern
<b>5</b>	OFF SETTING	Turn distinctive ring off

- 
- 4** Press the **STOP** key repeatedly to return to the date and time display.



---

## 6. Optional Settings

The option settings let you customize the fax machine to better suit your needs.

An initial setting has been made for each option at the factory. To change a setting, follow the steps below to access the option, and then change the setting as explained in the option setting list that follows.

---

- 1** Press the **FUNCTION** key and **4**.

The display will show:

4:OPTIONAL SETTING  
ENTER #(01-34,\*,#)

FUNCTION



- 
- 2** Press the numeric keys to enter the 2-digit number (“01” to “34”) of the option setting you want to set.



Or

Example:  
Option Setting 1

Press **\*** or **#** to scroll through the option settings. When the desired option setting appears, press the **START** key.

---

- 3** Enter a selection for the option setting by pressing the numeric keys. See the list that follows for an explanation of each of the option settings.

- 4** After entering a selection, the subsequent option setting will appear in the display. To return to the date and time display, press the **STOP** key twice.



## Option Settings

### Setting 01: FINE RESOLUTION PRIORITY

This option sets the default resolution (the resolution used if a setting is not made with the **RESOLUTION** key) for transmitting documents. Press **1** (YES) to set the default resolution to FINE, or **2** (NO) to set it to STANDARD.

- ◆ Initial setting: 2

### Setting 02: NUMBER OF RINGS AUTO RECEPTION

This sets the number of rings the fax machine waits before answering an incoming call in AUTO receive mode. Enter a number from **0** to **9** (if **0** is entered the fax machine will answer without ringing).

- ◆ Initial setting: 1

### Setting 03: NUMBER OF RINGS MANUAL RECEPTION

You can also have the fax machine automatically answer a call after a certain number of rings in MANUAL reception mode. To turn on this function, enter the desired number of rings (any number from **1** to **9**). To turn off the function, enter **0**.

- ◆ Initial setting: 0 (off)

**Setting 04: AUTO LISTING**

Press **1** (YES) to have the fax machine automatically print an Activity Report once every 30 send/receive operations. (The report can still be printed on demand at any time.) Press **2** (NO) to turn the function off.

◆ Initial setting: 2

**Setting 05: TRANSACTION REPORT PRINT SELECTION**

This sets the condition for printing out a Transaction Report. Enter a number from **1** to **5** as follows:

- |                                |   |
|--------------------------------|---|
| <b>1</b> (ERROR/TIMER MEMORY): | A report will be printed after an error, timer operation, or memory operation |
| <b>2</b> (SEND ONLY)           | A report will be printed only after a transmission                            |
| <b>3</b> (ALWAYS PRINTS)       | A report will be printed after each transmission, reception, or error         |
| <b>4</b> (NEVER PRINTS)        | A report will never be printed.   |
| <b>5</b> (ERROR ONLY)          | A report will be printed only after an error occurs                           |

◆ Initial setting: 5

**Setting 06: RECALL TIMES**

This sets the maximum number of times your fax will automatically redial if the line is busy. Enter any number from **00** to **14**.

◆ Initial setting: 02

**Setting 07: RECALL INTERVAL**

This sets the amount of time your fax will wait between automatic redials when the line is busy. Enter **01** for 1 minute, **02** for 2 minutes, etc., up to a maximum of 15 minutes.

◆ Initial setting: 05

**Setting 08: SECURITY SELECTION**

Press **1** (ON) to turn polling security on, or **2** (OFF) to turn it off.

◆ Initial setting: 1

**Setting 09: ERROR CORRECTION MODE (ECM)**

Press **1** (YES) to have any distortions in a transmission due to noise on the telephone line corrected before print-out at the receiving end. This is only effective when the other machine has ECM as well. Press **2** (NO) to turn the function off.

**Note for FO-4970:** If the transmission or reception is taking place in Super G3 mode, ECM will operate regardless of the ECM setting.

◆ Initial setting: 1

**Setting 10: AUTO COVER SHEET**

Press **1** (YES) to have the fax automatically generate a cover sheet and send it as the last page of each transmission. Press **2** (NO) to turn the function off.

◆ Initial setting: 2

**Note:** In North America, Setting 11 is not used.

**Setting 12: COPY SCANNING**

This setting is used to reduce copies slightly before printing to ensure that data on the edges are not cut off. Press **1** (AUTO) for automatic reduction, or **2** (100%) for no reduction.

◆ Initial setting: 2

**Setting 13: COPY CUT-OFF**

This setting determines how the fax machine will copy documents that are longer than the printing paper. Press **1** (CONTINUE) to have the remainder of the document printed on a second page, or **2** (CUT-OFF) to cut off (not print) the remainder.

◆ Initial setting: 2

### **Setting 14: RECEIVE REDUCE**

This setting is used to reduce received documents slightly before printing to ensure that data on the edges are not cut off. Press **1** (AUTO) for automatic reduction, or **2** (100%) for no reduction.

◆ Initial setting: 1

### **Setting 15: IMAGE MEMORY PRINT**

Press **1** (YES) to include a copy of part of the first page of the transmitted document on the Transaction Report. Press **2** (NO) to turn the function off. This setting is only effective when transmitting from memory.

◆ Initial setting: 1

### **Setting 16: CASSETTE SELECTION**

Press **1** if you want the fax machine to automatically select the printing paper source (tray or cassette) according to the size of each page received or copied. (If a document consists of multiple pages of different sizes, each page will be printed on the paper that best matches its size.)

Press **2** if you want the fax machine to automatically select the printing paper source (tray or cassette) according to the size of the first page of the document received or copied. (If the document consists of multiple pages of different sizes, all pages will be printed on the same size of paper based on the size of the first page.)

Press **3** if you want to set a fixed order of priority for the paper sources. When the 1ST PRIORITY setting appears, press **1** to have paper always drawn from the tray regardless of the size of the received or copied document, or **2** to have paper always drawn from the cassette. When the 2ND PRIORITY setting appears, press **1** to have paper drawn from the other source in the event that the “1st priority” source runs out of paper, or **2** (NONE) to have the incoming fax received to memory.

**Note:** This setting will only appear if your dealer has installed the paper cassette option and Option Setting 33 (Seperate Mode) is turned off.

◆ Initial setting: 1

### **Setting 17: RETRANSMISSION TIMES**

This sets the number of times the fax will reattempt a memory transmission which has been interrupted by a line error or power failure. Enter any 2-digit number from **01** to **14**, or enter **00** to turn off the function.

◆ Initial setting: 10

### **Setting 18: RETRANSMISSION INTERVAL**

You can select the number of minutes the fax waits between each memory retransmission attempt. Enter **01** for 1 minute, **02** for 2 minutes, etc., up to a maximum of 15 minutes. If you do not want the fax to wait between attempts, enter **00**.

◆ Initial setting: 02

### **Setting 19: HEATER MODE**

To conserve power, you can turn off the laser printer heater in your fax machine. When this is done, the heater will turn on automatically when you receive a document (there will be a slight delay before printing while the heater warms up) and turn off when printing is completed. Press **2** to turn off the heater, or **1** to keep it on.

◆ Initial setting: 2

### **Setting 20: ANTI-JUNK FAX**

Press **1** to block reception from fax numbers entered in the Anti Junk Fax List. Press **2** to allow reception from all numbers.

◆ Initial setting: 2

### **Setting 21: ALARM VOLUME**

This sets the volume of the beep sound that alerts you to error conditions and informs you that operations have been completed. Press **1** for HIGH, **2** for LOW, or **3** for OFF.

- ◆ Initial setting: 2

### **Setting 22: DIAL MODE**

This sets the dial mode. Press **1** if you are on a touch-tone line, or **2** if you are on a pulse dial (rotary) line.

- ◆ Initial setting: 1

### **Setting 23: QUICK ON-LINE**

When you transmit a multi-page document, this setting determines whether the fax machine will dial the receiving party and begin transmitting while scanning is still in progress, or wait until all pages have been scanned before dialing. Press **1** to have the fax machine dial and begin transmission while scanning is still in progress, or **2** to have the fax machine wait until all pages have been scanned.

- ◆ Initial setting: 1

### **Setting 24: MULTI TTI**

If you are using Department Control, you can press **1** to have the department name (the name associated with the department code entered by an operator to access the fax) appear at the top of each transmitted document. This will appear in place of the name entered in *Entering Your Name and Fax Number* in Chapter 1. Press **2** to turn Multi TTI off (the sender's name entered in Chapter 1 will appear).

- ◆ Initial setting: 2

### **Setting 25: BEEP LENGTH**

This sets the duration of the beep that signals the end of transmission, reception, or copying. Press **1** for 3 seconds, **2** for 1 second, or **3** for no beep.

- ◆ Initial setting: 1



**Setting 26: TELEPHONE BILLING CODE**

This setting allows you to use Department Codes or direct billing codes for telephone billing on a PBX. (Your dealer must first activate Department Control or direct billing code entry.) Press **1** to turn telephone billing on, or **2** to turn it off.

◆ Initial setting: 2

If you pressed **1**, the BILLING CODE DIAL selection will subsequently appear. Press **1** if your PBX must receive the billing code before dialing a telephone number, or **2** if it must receive the billing code after dialling a telephone number. (Refer to your PBX manual or consult your PBX administrator for this information.)

**Note:** If you select AFTER for the BILLING CODE DIAL selection, you must press the **REDIAL** key after dialing if you use the **SPEAKER** key.

**Setting 27: DEPARTMENT CODE DIGITS**

Use this setting if you are using Telephone Billing and need to change the number of digits of Department Codes to accord with your PBX's telephone billing system. Enter any number from **3** to **9**.

◆ Initial setting: 4

**Setting 28: DISTINCTIVE RING**

This sets the ring pattern to which your fax will answer if you subscribe to a distinctive ring service. Enter a number from 1 to 5 to select a pattern. See *Distinctive Ring* in Chapter 5 for more details.

◆ Initial setting: 5

### **Setting 29: VERIFICATION STAMP**

Press **1** if you want the fax machine to stamp each original document page as it is scanned. After scanning, you can check to see if all pages have been stamped to verify that no double feeds occurred. Press **2** to turn the function off.

**Note:** To use this function, your dealer must install the Verification Stamp option.

- ◆ Initial setting: 2

### **Setting 30: PRINT HOLD**

Press **1** if you want the fax machine to hold received documents in memory instead of immediately printing them out (note that you must first enter a Print Hold passcode as explained in *Print Hold* in Chapter 5). To turn off the Print Hold function, press **2**, enter the 4-digit Print Hold passcode, and then press **START**.

- ◆ Initial setting: 2

**Setting 31:** Not used.

### **Setting 32: COPY RESOLUTION**

Use this setting to select the default copying resolution (the resolution used for copying if a setting is not made with the **RESOLUTION** key). Press **1** (S-FINE) to set the default resolution to SUPER FINE, or **2** to set it to FINE.

- ◆ Initial setting: 2

**Setting 33: SEPARATE MODE**

If desired, you can have the fax draw a sheet of paper from the paper tray after each fax reception. By loading colored (or large) paper in the paper tray, each colored sheet drawn will act as a separator that makes it easy to distinguish where one multi-page document ends and another begins. A Transaction Report printed after a reception will also be printed from the paper tray to act as a separator sheet. Press **1** to turn on this function (be sure to load appropriate paper in the paper tray), or **2** to turn it off. (Note that this function will not operate for copy jobs and print jobs from a computer. Also, the function will turn off automatically if the paper tray runs out of paper.)

**Note:** This setting will only appear if your dealer has installed the paper cassette option.

◆ Initial setting: 2

**Note:** If you turn off the Separate Mode setting, Option Setting 16 will subsequently appear in the display to allow you make an appropriate setting for cassette selection. If you don't make a selection, 1:AUTO SELECTION will be automatically selected.

**Setting 34: POWER SAVE TYPE**

This option sets the method for turning on Power Save Mode. Press **1** to select REAL TIME (turn Power Save Mode on and off by pressing the **POWER SAVE** key), or **2** to select TIMER (automatic on and off at preset times). For more detailed information, see *Power Save Mode* in Chapter 5.

◆ Initial setting: 1

---

## 7. Printing Lists and Reports

You can print lists showing settings and information entered in the fax machine. You can also print out reports on recent activity and individual operations after they are completed. The lists and reports are described on the following pages.

To print a list, follow the steps below.

---

### 1 Press the **FUNCTION** key and **2**.

The display will show:

2:LISTING MODE  
ENTER #(01-11,\*,#)



---

### 2 Press the numeric keys to enter the 2-digit number (“01” to “11”) of the list you want to print.

Or

Press **\*** or **#** to scroll through the lists. When the desired list appears, press the **START** key.



Example:  
Activity Report

### **Activity Report (List 01)**

This report shows information on your most recently performed send and receive operations (a combined maximum of 30 operations can appear). The report is divided into two parts: the **SEND REPORT**, which shows information on transmissions, and the **RECEIVE REPORT**, which shows information on receptions.

- ◆ If Option Setting 4 (Auto Listing) is set to YES, a report will be automatically printed out whenever information on 30 operations has accumulated. (A report can still be printed on demand at any time.)
- ◆ All information is erased after a report is printed out. If automatic print-out is turned off and the report is not printed manually for 30 operations, the information on the oldest operation will be overwritten each time a new operation is performed.

```

*****
x                                                                 P. 01 x
x                               SEND REPORT                               x
x                               MAY-25-2000 TUE 05:16 PM                 x
x                               201 555 1234                             x
x  FOR: John Doe Corp.                                     x
x-----x-----x-----x-----x-----x-----x-----x-----x
x # DATE  START  RECEIVER      TX TIME  PAGES TYPE      NOTE      M# DP  x
x 01 MAY-21 08:23 PM AL          **' **"    0 SEND    P. FAIL   001    x
x-----x-----x-----x-----x-----x-----x-----x-----x
x                               TOTAL:      0"      0                               x
x                               GRAND TOTAL TIME:      OS PAGES:      0       x
x-----x-----x-----x-----x-----x-----x-----x-----x
*****

```

## Explanation of headings

- SENDER/RECEIVER** The name or fax number of the other machine involved in the transaction.
- START** The time at which transmission/reception started.
- TX/RX TIME** Total time taken for transmission/reception.
- PAGES** Number of pages transmitted/received.
- TYPE**
- CONF. TX** - A confidential operation was performed.
  - RELAY TX** - A relay operation was performed.
  - (T)** - A timer operation was performed.
  - (D)** - The document was sent directly from the feeder, not from memory.

**NOTE** (One of the following notes will appear under **NOTE** in the report to indicate whether the transaction was successful, and if not, the reason for the failure.)

**OK** - Transmission/reception was successful.

**P.FAIL** - A power failure prevented the transaction.

**JAM** - The printing paper or document jammed, preventing the transaction.

**BUSY** - The fax was not sent because the line was busy.

**COM.E-0 to COM.E-31** - A telephone line error prevented the transaction. See *Line Error in Problems and Solutions* in Chapter 9.

**CANCEL** - The transaction was cancelled because the **STOP** key was pressed, no document was in the feeder, or the other machine requested transmission using a function which your fax machine does not have.

**CANCEL 3** - (Used for confidential transmission only)  
A confidential transmission was cancelled because the receiving machine does not have a confidential function, a confidential passcode is not programmed in the receiving machine, its memory is full, or it is not a Sharp model.

**CANCEL 4** - (Used for confidential transmission only)  
A confidential transmission was cancelled because an incorrect mailbox number was entered for a fax machine with confidential mailboxes, or the other machine's memory is full.

**CANCEL 5** - (Used for relay request only)  
A relay request was not successful because the machine to which the request was made has no relay function, it is not a Sharp model, or its memory was full.

**CANCEL 6** - (Used for relay request only)  
A relay request was not successful because your machine's fax number has not been entered into the relay machine's list of permitted numbers, an automatic dialing number not stored in the relay machine was specified, or your fax number has not been entered in your machine as explained in Chapter 1.

### Timer List (List 02)

This list shows the timer operations that are currently set.

```

XXXXXXXXXXXXXXXXXXXXXXXXXXXXXXXXXXXXXXXXXXXXXXXXXXXXXXXXXXXXXXXXXXXXXXXXXXXX
X                                     P.01 X
X                                     TIMER LIST X
X                                     MAY-25-2000 TUE 05:20 PM X
X FOR: John Doe Corp.                201 555 1234 X
X-----X
X TIMER X
X # RESERVED TIME TYPE                RESOLUTION BOX REMOTE STATION ID # DP X
X 01 11:00 PM TUE SEND                STANDARD FAX #: R01 X
X-----X
XXXXXXXXXXXXXXXXXXXXXXXXXXXXXXXXXXXXXXXXXXXXXXXXXXXXXXXXXXXXXXXXXXXXXXXXXXXX
    
```

### Telephone Number List (List 03)

This list shows the fax numbers that have been programmed for automatic dialing.

```

XXXXXXXXXXXXXXXXXXXXXXXXXXXXXXXXXXXXXXXXXXXXXXXXXXXXXXXXXXXXXXXXXXXXXXXXXXXX
X                                     P.01 X
X                                     TELEPHONE NUMBER LIST X
X                                     MAY-25-2000 TUE 05:21 PM X
X FOR: John Doe Corp.                201 555 1234 X
X-----X
X RAPID/ NAME X
X SPEED # *SECONDARY # TELEPHONE # CHAIN DIAL X
X-----X
X R01 N. Y. FAX 123-785-8304 X
X *N. Y. (2) 123-785-8885 X
X R02 JACK SMITH FAX 123-563-8482 X
X R03 ABC CORP. FAX 230-347-6385 X
X R04 M. SOFT FAX 852-983-9988 X
X R05 W. HART FAX 896-983-8521 X
X-----X
XXXXXXXXXXXXXXXXXXXXXXXXXXXXXXXXXXXXXXXXXXXXXXXXXXXXXXXXXXXXXXXXXXXXXXXXXXXX
    
```

### Relay Group List (List 04)

This list shows the relay groups that have been programmed.

```

XXXXXXXXXXXXXXXXXXXXXXXXXXXXXXXXXXXXXXXXXXXXXXXXXXXXXXXXXXXXXXXXXXXXXXXXXXXX
X                                     P.01 X
X                                     RELAY GROUP LIST X
X                                     MAY-26-2000 WED 05:50 PM X
X FOR: John Doe Corp.                201 555 1234 X
X-----X
X # RELAY STATION # RECEIVE STATION(S) X
X-----X
X 01 R01 RAPID #: 01,02,03 X
X SPEED #: 01,02,03 X
X-----X
XXXXXXXXXXXXXXXXXXXXXXXXXXXXXXXXXXXXXXXXXXXXXXXXXXXXXXXXXXXXXXXXXXXXXXXXXXXX
    
```

### Passcode List (List 05)

This list shows settings made for polling security, your name and fax number as programmed in the fax machine, a sample of the header printed at the top of every page you transmit (HEADER PRINT), and the numbers entered in the relay passcode list.

```

*****
|
|
|          PASSCODE LIST                      MAY-28-2000 WED 05:52 PM
|
|  FOR: John Doe Corp.          201 555 1234
|-----|
|          SYSTEM #
|          ID #
|          1
|          2
|          3
|          4
|          5
|
|          PASSCODE #
|          01
|          02
|          03
|          04
|          05
|          06
|          07
|          08
|          09
|          10
|
|          RELAY PASSCODE #
|          01
|          02
|          03
|          04
|          05
|          06
|          07
|          08
|          09
|          10
|-----|
|          SENDER'S NAME          John Doe Corp.
|          SENDER'S PASSCODE      201 555 1234
|
|          HEADER PRINT
|  MAY-28-2000 WED 05:52 PM John Doe Corp.          FAX NO. 201 555 1234          P. 01
|-----|
*****

```

### Optional Setting List (List 06)

This list shows the current status of the option settings.

```

*****
|
|
|          OPTIONAL SETTING LIST              JUN-07-2000 MON 04:37 PM
|
|  FOR:
|-----|
|  SM #          ITEM                      SETTING
|-----|
|  01          FINE PRIORITY                NO
|  02          # OF RINGS AUTO RX           1 RING
|  03          # OF RINGS MANUAL RX         0 RINGS
|  04          AUTO LISTENING                NO
|  05          PRINT SELECTION              ERROR ONLY
|  06          RECALL TIMES                  2 TIMES
|  07          RECALL INTERVAL              5 MINUTES
|  08          SECURITY SELECTION            SECURITY ON
|  09          ECHO                          YES
|  10          AUTO COVER SHEET             NO
|  11          NO TONER                       NO
|  12          COPY SCANNING                 REDUCE 100%
|  13          COPY CUT-OFF                  CUT-OFF
|  14          RECEIVE REDUCE                REDUCE AUTO
|  15          IMAGE MEMORY PRINT            YES
|  16          CASSETTE SELECTION            AUTO SELECTION
|  17          RETRANSMISSION TIMES          10 TIMES
|  18          RETRANSMISSION INTERVAL      2 MINUTES
|  19          BEATER MODE                    ALWAYS OFF
|  20          ANTI-JUNK FAX FUNCTION        OFF
|  21          RING VOLUME                    LOW
|  22          DIAL MODE                       TONE
|  23          DIAL ON-LINE                   ON
|  24          MULTI TIT                       OFF
|  25          BEEP LENGTH                    3 SECONDS
|  26          BEEP BLANK CODE                OFF
|  27          DEF1 CODE DIGITS                4 DIGITS
|  28          DISTINCTIVE RING              OFF SETTING
|  29          VERIFICATION STRAP            OFF
|  30          PRINT HOLD                      NO
|  31          NO FUNCTION                      FINE
|  32          SEPARATE MODE                    NO
|  33          POWER SAVE TYPE                 TIMER
|-----|
*****

```



### Program and Group List (List 07)

The top part of this list shows the programs that have been entered. The bottom part shows the fax numbers that have been programmed into Group Keys.

```

XXXXXXXXXXXXXXXXXXXXXXXXXXXXXXXXXXXXXXXXXXXXXXXXXXXXXXXXXXXXXXXXXXXXXXXXXXXX
X                                                                 P.01 X
X          PROGRAM / GROUP LIST          MAY-26-2000 WED 05:57 PM X
X FOR: John Doe Corp.          201 555 1234 X
X PROGRAM X
X # RESERVED TIME NAME/TYPE          RESOLUTION BOX # REMOTE STATION ID # X
X P08 11:00 PM          P-POLLING X
X          POLLING          ( T )          R01 X
X X
X          GROUP X
X #          REMOTE STATION ID # X
X G09          R01 ,R02 ,R03 ,R04 ,R05 X
X X
XXXXXXXXXXXXXXXXXXXXXXXXXXXXXXXXXXXXXXXXXXXXXXXXXXXXXXXXXXXXXXXXXXXXXXXXXXXX
    
```

### Batch Transmission List (List 08)

The Batch Transmission List shows the documents that are currently stored for batch transmission.

```

XXXXXXXXXXXXXXXXXXXXXXXXXXXXXXXXXXXXXXXXXXXXXXXXXXXXXXXXXXXXXXXXXXXXXXXXXXXX
X                                                                 P.01 X
X          BATCH TX LIST          MAY-26-2000 WED 08:01 PM X
X FOR: John Doe Corp.          201 555 1234 X
X # RESERVED TIME NAME          PAGES REMOTE STATION ID #          M#          DP X
X P10 11:00 PM WED BATCH-1          1 FAX #: R01          MSG001 X
X X
XXXXXXXXXXXXXXXXXXXXXXXXXXXXXXXXXXXXXXXXXXXXXXXXXXXXXXXXXXXXXXXXXXXXXXXXXXXX
    
```

### Department Usage List (List 09)

This list shows total transmission time and pages transmitted (including polling time and pages polled) for each department during the period indicated on the list. The information is only available if Department Control has been activated. The bottom part of the list shows information about relay broadcast operations performed on the request of other fax machines.

- ◆ Each time you print out the report, the data is cleared and a new period begins.

```

*****
*                                     DEPARTMENT USAGE LIST                                     *
*                                     MAY-20-2000 04:08:00 PM                                     *
* FROM: John Doe.          TO: 555 1234          *
* FROM-TO: 2000 TO 2000-2000 *
*-----*-----*-----*-----*
* #   DEPARTMENT NAME          TOTA: TIME          TOTAL PAGES          *
*-----*-----*-----*-----*
* 00 *
* 01 *
* 02 *
* 03 *
* 04 *
* 05 *
* 06 *
* 07 *
* 08 *
* 09 *
* 10 *
*-----*-----*-----*
* 11 *
* 12 *
* 13 *
* 14 *
* 15 *
* 16 *
* 17 *
* 18 *
* 19 *
* 20 *
*-----*-----*-----*
* 21 *
* 22 *
* 23 *
* 24 *
* 25 *
* 26 *
* 27 *
* 28 *
* 29 *
* 30 *
*-----*-----*-----*
* GRAND TOTAL:          00          PAGES:  0          *
*-----*-----*-----*
* RELAY BROADCAST *
*-----*-----*-----*
* #   RELAY PASSCODE #          TOTA: TIME          TOTAL PAGES          *
*-----*-----*-----*
* 01 *
* 02 *
* 03 *
* 04 *
* 05 *
* 06 *
* 07 *
* 08 *
* 09 *
* 10 *
*-----*-----*-----*
* GRAND TOTAL:          00          PAGES:  0          *
*****

```

### Confidential Reception List (List 10)

This list shows which mailboxes have received confidential documents and the total number of pages received. Print this list out whenever RCVD CONFIDENTIAL RX appears in the display.

```

*****
*                                     CONFIDENTIAL RECEPTION LIST                                     *
*                                     MAY-25-2000 TUE 05:21 PM                                     *
*                                     P. 01 *
*-----*-----*-----*
* BOX #   BOX NAME          TOTAL PAGES          *
*-----*-----*-----*
* 00      ABCD              1 *
*-----*-----*-----*
* TOTAL          1 *
*-----*-----*-----*
*****

```



---

## 8. Maintenance

### Cleaning the Scanning Glass and Rollers

Clean the reading glass and rollers frequently to ensure the quality of your transmitted images and copies.

---

- 1 Open the operation panel.
  - Squeeze the release marked **PANEL RELEASE** and pull up.



- 2 Wipe the scanning glass, white backplate, and rollers with a soft cloth.
  - Make sure that all dirt and stains (such as correcting fluid) are removed, as dirt will cause vertical lines on transmitted images and copies. (If necessary, wipe with denatured alcohol.)

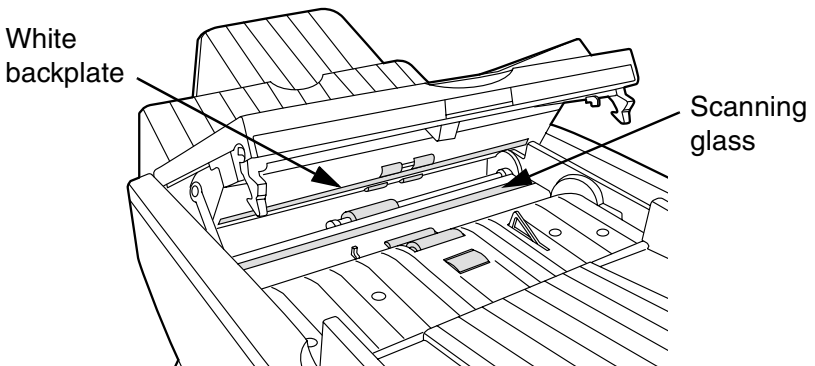

## The Housing

Wipe the external parts and surface of the machine with a dry cloth.

### Caution!

Do not use benzene or thinner. These solvents may damage or discolor the machine.

## Replacing the Verification Stamp

If you are using the Verification Stamp function, you will need to replace the ink cartridge in the stamp unit when it runs out of ink (when the stamped mark on original documents becomes faint). A new ink cartridge can be obtained from your dealer.

- 
- 1 Remove the original document OUT tray.

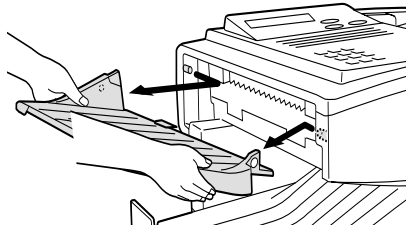

- 
- 2 Press down on the protruding tab of the green ink cartridge and pull the cartridge out with your fingers.

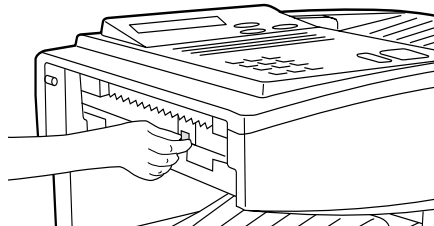

- 3** Insert the new ink cartridge into the machine (make sure that the tab is facing out).

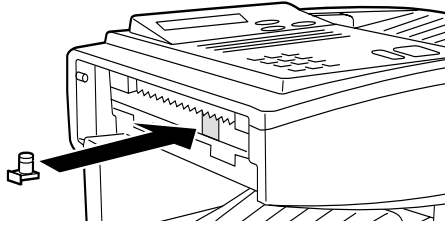

- 4** Replace the original document OUT tray.

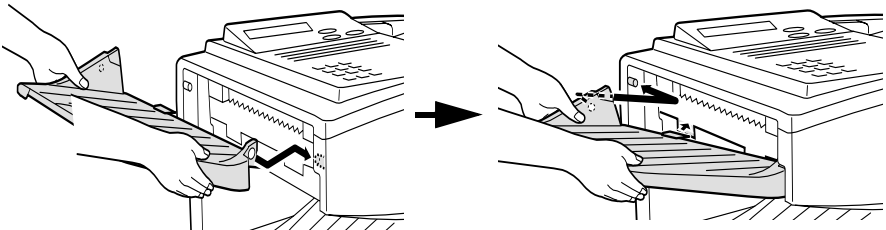

---

# 9. Troubleshooting

## Problems and Solutions

### Line error

Problem	Solution
<p>LINE ERROR appears in the display, and/or a transaction report is printed out with <b>COM. E-</b> and a number from <b>0</b> to <b>31</b> in the <b>NOTE</b> column.</p>	<p>Try the transaction again. If the error persists, check the following:</p> <ul style="list-style-type: none"><li>• Check the hookup. The cord from the <b>TEL. LINE</b> jack to the wall jack should be no longer than six feet.</li><li>• Make sure there are no modem devices sharing the same telephone line.</li><li>• Check with the other party to make sure their fax machine is functioning properly.</li><li>• Have your telephone line checked for line noise.</li><li>• Try connecting the fax machine to a different telephone line.</li><li>• If the problem still occurs, your fax machine may need service.</li></ul>

**Dialing and transmission problems**

<b>Problem</b>	<b>Solution</b>
Dialing is not possible.	<ul style="list-style-type: none"><li>• Make sure the power cord is properly plugged into a power outlet.</li><li>• Make sure that the telephone line is properly connected to both the <b>TEL. LINE</b> jack and the wall jack.</li><li>• Make sure that the fax machine is set to the correct dialing mode for your telephone line. See Option Setting 22 in Chapter 6.</li></ul>
The power is on, but no transmission takes place.	<ul style="list-style-type: none"><li>• Make sure that the receiving machine has paper.</li><li>• Make sure that the telephone line cord is plugged into the <b>TEL. LINE</b> jack, and not the <b>TEL. SET</b> jack.</li><li>• If the receiving machine is in manual mode with no attendant, reception will not be possible.</li><li>• If the receiving machine is not a Sharp model, make sure it is G3 compatible.</li><li>• Check the display for error messages.</li><li>• Press the <b>SPEAKER</b> key and check for a dial tone.</li></ul>
Nothing is printed at the receiving end.	<ul style="list-style-type: none"><li>• Make sure that the document for transmission is placed face down in the feeder.</li></ul>
A distorted image is received at the other end.	<ul style="list-style-type: none"><li>• If ECM mode (Option Setting 9) is turned off, noise on the telephone line may cause distortion. Try sending the document again.</li><li>• Make a copy of the document on your fax machine. If the copy is also distorted, your fax machine may need service.</li></ul>



**Reception and copying problems**

<b>Problem</b>	<b>Solution</b>
The fax machine doesn't receive documents automatically.	<ul style="list-style-type: none"> <li>• Make sure that the reception mode is set to AUTO. If you subscribe to a distinctive ring service, make sure that the Distinctive Ring function is set to the correct ring pattern. If you do not subscribe to a distinctive ring service, make sure that Distinctive Ring is set to OFF SETTING. (See Distinctive Ring in Chapter 5.)</li> </ul>
The power is on, but no reception takes place.	<ul style="list-style-type: none"> <li>• Make sure that the wall jack is connected to the <b>TEL. LINE</b> jack, and not the <b>TEL. SET</b> jack.</li> </ul>
The printing paper comes out blank when you try to receive a document.	<ul style="list-style-type: none"> <li>• Make sure that the document is loaded properly in the feeder of the transmitting machine. Make a copy or print a report to confirm the printing ability of your machine.</li> </ul>
The received document is faint.	<ul style="list-style-type: none"> <li>• Ask the other party to send higher contrast documents. If the contrast is still too low, your fax machine may need service. Make a copy or print a report to check your machine's printing ability.</li> <li>• The toner cartridge may need replacement.</li> </ul>
Received images are distorted.	<ul style="list-style-type: none"> <li>• If ECM mode (Option Setting 9) is turned off, noise on the telephone line may cause distortion. Have the other party try sending the document again.</li> <li>• If the other machine has ECM mode, make sure this feature is turned on in both fax machines (see Option Setting 9).</li> <li>• Make a copy or print a report on your fax machine. If the copy or report is also distorted, your fax machine may need service.</li> <li>• The drum cartridge may be damaged. Try a new drum cartridge.</li> </ul>

<p>The quality of copies is poor and/or black spots appear.</p>	<ul style="list-style-type: none"> <li>Any dirt or material on the scanning glass will cause spots to appear on copies and transmitted faxes. Clean the scanning glass as explained in Chapter 8.</li> </ul>
<p>Dots appear at regular intervals on received documents and copies.</p>	<ul style="list-style-type: none"> <li>The drum cartridge may be damaged. Replace the drum cartridge.</li> </ul>

### **General problems**

<b>Problem</b>	<b>Solution</b>
<p>Nothing appears in the display.</p>	<ul style="list-style-type: none"> <li>Make sure the power cord is properly plugged into a power outlet and the power switch is turned on.</li> <li>Connect another electrical appliance to the outlet to see if it has power.</li> </ul>
<p>The machine does not respond when you press any of its keys.</p>	<ul style="list-style-type: none"> <li>If a beep sound is not made when you press the keys, turn off the power switch and then turn it on again several seconds later.</li> </ul>
<p>Automatic document feeding does not work for transmission or copying.</p>	<ul style="list-style-type: none"> <li>Check the size and weight of the document (see <i>Transmittable Documents</i> in Chapter 2).</li> </ul>
<p>No reception occurs when polling is attempted.</p>	<ul style="list-style-type: none"> <li>Make sure you have not run out of paper.</li> <li>Make sure the transmitting machine is in automatic reception mode.</li> <li>If the transmitting machine has polling security, make sure that your fax number has been entered both in your machine and in the transmitting machine.</li> </ul>

## Messages and Signals

### Display messages

CHECK TRAY/CASSETTE	This indicates that a paper jam has occurred in the tray or cassette, or that the cassette is not installed properly.
CONF REFUSED	A confidential transmission has been denied because you entered an incorrect mailbox number for a machine with mailboxes.
CONF. RX ERROR	Confidential reception was cancelled because the mailbox number specified by the transmitting machine is not programmed in your fax machine.
CHECK COVER OR DRUM	The operation panel is open or the drum cartridge has not been installed. Close the cover or install the drum cartridge.
DRUM LIFE OVER	The drum cartridge must be replaced.
FAX RCVD IN MEMORY	A fax has been received in memory because the toner cartridge needs replacement, you have run out of printing paper, or the paper is jammed. The fax will automatically print out when the problem is fixed.
FUNCTION MODE	The <b>FUNCTION</b> key has been pressed.
LINE ERROR	Transmission or reception was not successful. Press <b>STOP</b> to clear the message and then try again. If the error persists, see <i>Line Error</i> in <i>Problems and Solutions</i> in this chapter.
MEMORY FULL ERROR	An internal memory error occurred. You may need to resend one or more pages of the document being transmitted when the error occurred.
MEMORY FULL ERROR START=OK,STOP=CANCEL	The memory is full (this message appears when Option Setting 23, Quick On-line, is set to NO). Press the <b>START</b> key to send only the pages already scanned, or the <b>STOP</b> key to cancel the entire transmission.

## Messages and Signals

NO CONF. FUNC	Confidential transmission was cancelled because the receiving machine does not have a confidential function, a confidential passcode is not programmed in it, its memory is full, or it is not a Sharp model.
NO PAPER	This message will be followed by one of the paper sources in parentheses, and informs you that the paper source is out of paper. If no paper source is indicated, both paper sources are out of paper.
NO RELAY FUNC	A relay request has been denied because the other machine does not have a relay broadcast function, its memory is full, or it is not a Sharp machine.
ONHOOK DIAL MODE	The <b>SPEAKER</b> key has been pressed and the fax machine is waiting for you to dial.
PAPER JAM	The printing paper is jammed. See the following section, <i>Clearing Paper Jams</i> .
POWER SAVE MODE	Power Save Mode is on. See <i>Power Save Mode</i> in Chapter 5.
RCVD CONF. FAX	A confidential fax has been received in memory. Print the fax as explained in <i>Confidential Operations</i> in Chapter 5.
RCVD PRINT HOLD FAX	The Print Hold function has been turned on and you have received one or more faxes in memory. Print out the faxes as explained in <i>Print Hold</i> in Chapter 5.
RCVD RELAY REQUEST	Your fax machine has received a Relay Broadcast request and is transmitting the requested document to the end receiving machines. See <i>Relay Broadcast</i> in <i>Relay Request</i> in Chapter 5.

RELAY REFUSED	A relay request has been denied because your fax number has not been entered in the relay machine's list of permitted numbers, an auto dial number not programmed in the relay machine was specified, or your fax number has not been programmed in your machine.
REMOVE ORIGINAL(S)	The original document is jammed. See the following section, <i>Clearing Paper Jams</i> .
SIZE ERROR	This message will be followed by one of the paper sources in parentheses, and informs you that the paper loaded in that source is not all the same size.
REPLACE TONER	The toner cartridge must be replaced.
RX DOCUMENT TRAY OFF	The received document tray is not attached. Attach it as explained in <i>Connections</i> in Chapter 1 (the tray must be attached for the fax machine to operate properly.)
WAITING<MEMORY FULL>	The memory has become full and scanning has stopped during scanning of a multi-page document. Scanning will automatically resume when sufficient memory becomes free (for example, after several pages are transmitted).

### **Audible signals**

Continuous tone	3 seconds	Indicates the end of transmission, reception, or copying.
Intermittent tone (3 beeps)	5 seconds (1 second on, 1 second off)	Indicates incomplete transmission, reception, or copying.
Rapid intermittent tone	35 seconds (0.7 seconds on, 0.3 seconds off)	Indicates that an extension phone connected to the fax is off hook.

## Clearing Paper Jams

### Clearing a jammed document

If the original document doesn't feed properly during transmission or copying, or REMOVE ORIGINAL(S) appears in the display, first try pressing the **START** key. If the document doesn't feed out, open the operation panel and remove it.

#### **Important:**

Do not try to remove a document without opening the operation panel. This may damage the feeder mechanism.

---

#### **1** Open the operation panel.

- Squeeze the release marked **PANEL RELEASE** and pull up.

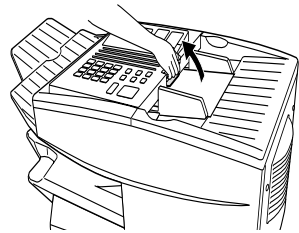

---

#### **2** Remove the document.

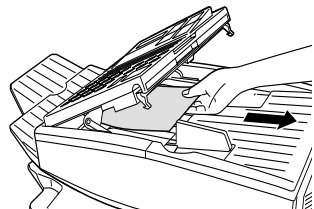

---

#### **3** Close the operation panel, making sure it clicks into place.

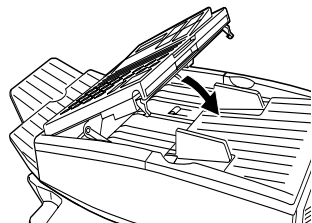

## Clearing jammed printing paper

If the printing paper jams, PAPER JAM will appear in the display. Follow the steps below to clear the jam.

- 1 Press the green release and open the print compartment cover.

- **Caution!**

The fusing unit inside the print compartment becomes very hot during operation. Be careful not to touch the inside of the compartment.

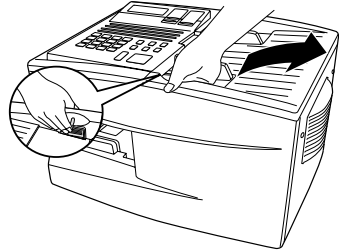

- 2 If the jammed paper is visible in the print compartment, pull it out.

- Make sure no torn pieces of paper remain in the print compartment and rollers.

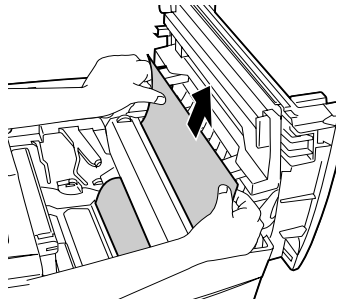

or

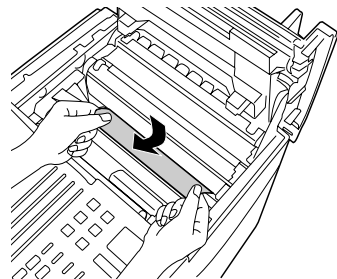

- 
- 3** If the jammed paper isn't visible, remove the toner cartridge and then the drum cartridge.

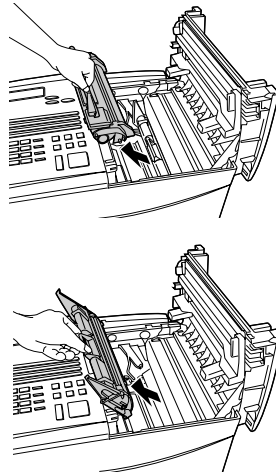

- 
- 4** Open the black cover (hinged on the left) at the bottom of the compartment. If jammed paper is visible, remove it.

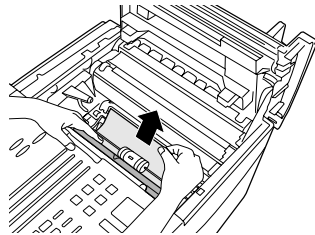

- 
- 5** Close the black cover. Reinsert the drum cartridge and then the toner cartridge.

- Insert the drum cartridge and toner cartridge by aligning the colored numbers on the cartridges with their corresponding colored numbers on the sides of the print compartment.
- When finished, close the print compartment cover.

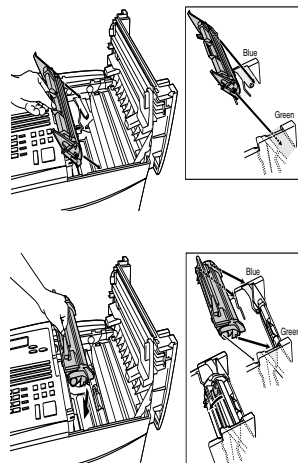



- 
- 6** If you have a paper cassette and the display still indicates that paper is jammed, open the cassette and remove the jammed paper.

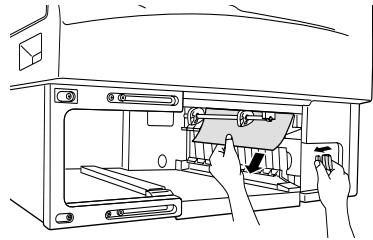
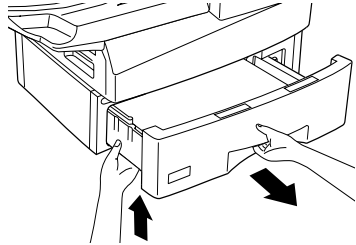

- 
- 7** Replace the paper cassette.

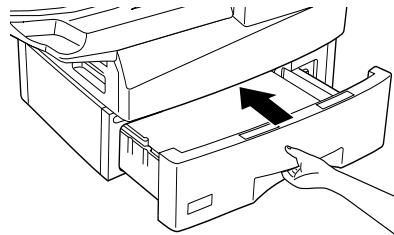

## ***FCC Regulatory Information***

This equipment complies with FCC rules, Part 68. On this equipment is a label that contains, among other information, the FCC Registration Number and Ringer Equivalence Number (REN) for this equipment. If requested, this information must be provided to your telephone company.

An FCC compliant telephone cord and modular plug is provided with this equipment. This equipment is designed to be connected to the telephone network or premises wiring using a compatible modular jack which is Part 68 compliant. This equipment connects to the telephone network through a standard USOC RJ-11C network interface jack.

The REN is used to determine the quantity of devices which may be connected to your telephone line and still have all of those devices ring when your number is called. Too many devices on one line may result in the devices not ringing in response to an incoming call. In most, but not all, areas as the sum of the RENs of all devices should not exceed five (5.0). To be certain of the number of devices that may be connected to your line, as determined by the total REN, contact your local telephone company.

If this equipment causes harm to the telephone network, your telephone company may disconnect your service temporarily. If possible, they will notify you in advance. If advance notice is not practical, you will be notified as soon as possible. You will also be advised of your right to file a complaint with the FCC.

Your telephone company may make changes in its facilities, equipment, operations, or procedures that could affect the operation of your equipment. If this happens, the telephone company will provide advance notice in order for you to make necessary modifications to maintain uninterrupted service. If the equipment is causing harm to the telephone network, your telephone company may ask you to disconnect the equipment until the problem resolved.

If you have any questions or problems which cannot be solved by reading this manual, please contact Sharp Electronics Corporation at Sharp Plaza, Mahwah, NJ 07430-2135. The customer number is 800-237-4277.

This equipment may not be used on coin service provided by the telephone company. Connection to party lines is subject to state tariffs. Contact your state's public utility commission, public service commission, or corporation commission for more information.

When programming and/or making test calls to emergency numbers:

- ◆ Remain on the line and briefly explain to the dispatcher the reason for the call.
- ◆ Perform such activities in the off-peak hours, such as early morning or late evening.

# S H A R P

Date Revised:  
Date Issued : May. 28, 1999

## MATERIAL SAFETY DATA SHEET (1/2)

MSDS No. B-1020

### Section 1. Product Identification

Product: FO-47ND / DUNT-455BSCZZ (Toner Cartridge)

### Section 2. Supplier's Name and Address

Sharp Corporation  
22-22 Nagaïke-cho, Abeno-ku, Osaka, Japan  
Local suppliers are listed below. Please contact the nearest supplier for additional information.

(Country)	(Name and Telephone Number)
U.S.A.	Sharp Electronics Corporation Telephone number for information: 1-800-237-4277 Emergency telephone number : 1-800-255-3924
Canada	Sharp Electronics of Canada Ltd. Telephone number for information: 905-890-2100 Emergency telephone number : 1-800-255-3924

### Section 3. Ingredients

Ingredients	CAS No.	Proportion	OSHA PEL	ACGIH TLV	Other Limits
Polyester resin (NJ TSRN 361615-5042-P)		>90%	Not listed	Not listed	None
Carbon black	1333-86-4	1 - 5%	3.5 mg/m <sup>3</sup>	3.5 mg/m <sup>3</sup>	TWA(Austl) : 3 mg/m <sup>3</sup>
Polyolefin wax	9003-07-0	1 - 5%	Not listed	Not listed	None
Polyolefin wax	25722-45-6	(TOTAL OF BOTH)	Not listed	Not listed	None
Organic pigment (NJ TSRN 361615-5025-P)		1 - 5%	Not listed	Not listed	None

### Section 4. Hazardous Identification (Emergency Overview)

Toner is a fine, black powder possessing no immediate hazard. There are no anticipated carcinogenic effects from exposure based on animal tests performed using toner. When used as intended according to instructions, studies do not indicate any symptoms of fibrosis will occur.

### Section 5. Health Hazard Data

Route(s) of Entry :	Inhalation?	Skin?	Ingestion?
	Yes	Yes(Eye contact)	Yes
<b>Health Hazard :</b>			
<u>Inhalation</u> , LC50(g/m <sup>3</sup> /4h) :	>0.74(Rats)* (This was the highest attainable concentration.)		
<u>Ingestion</u> (oral), LD50(mg/kg) :	>5000 (Rats) *		
<u>Dermal</u> , LD50 (mg/kg) :	>2000 (Rats) *		
<u>Eye irritation</u> :	Not an irritant (rabbits) *		
<u>Skin irritation</u> :	Not an irritant (rabbits) *		
<u>Skin sensitizer</u> :	No data available		
<u>Mutagenicity</u> :	Negative * (AMES test)		
	(* = Based on data for other products with similar ingredients)		

**Carcinogenicity :** In 1996 the IARC reevaluated carbon black as a Group 2B carcinogen (possible human carcinogen). This classification is given to chemicals for which there is inadequate humanevidence, but sufficient animal evidence on which to base an opinion of carcinogenicity. Theclassification is based upon the development of lung tumors in rats receiving chronic inhalationexposures to free carbon black at levels that induce particle overload of the lung. Studiesperformed in animal models other than rats did not show any association between carbon black and lung tumors. Moreover, a two-year cancer bioassay using a typical toner preparation containing carbon black demonstrated no association between toner exposure and tumor development in rats.

**Chronic Effect :** Prolonged inhalation of excessive dust may cause lung damage. It is attributed to "lung overloading", a generic response to excessive amounts of any dust retained in the lungs for a prolonged interval. Use of this product as intended does result in inhalation of excessive dust. In a study in rats by chronic inhalation exposure to a typical toner, a mild to moderate degree of lung fibrosis was observed in 92% of rats in the high concentration (16mg/m<sup>3</sup>) exposure group, and a minimal to mild degree of fibrosis was noted in 22% of the animals in the middle (4mg/m<sup>3</sup>) exposure group. But no pulmonary change was reported in the lowest (1mg/m<sup>3</sup>) exposure group, the most relevant level to potential human exposures.

# S H A R P

Date Revised:  
Date Issued : May. 28. 1999

## MATERIAL SAFETY DATA SHEET (2/2)

MSDS No. B-1020

**Signs and Symptoms of Exposure** : No symptoms expected with intended use.

**Medical Conditions Generally Aggravated by Exposure** : None

**Emergency and First Aid Procedures** :

**Inhalation** - - - If symptoms are experienced, remove source of contamination or move victim to fresh air and obtain medical advice.

**Ingestion** - - - If irritation or discomfort occurs, obtain medical attention immediately.

**Skin** - - - - - Flush with gently flowing water (preferably lukewarm) and soap for 15 minutes or until particle is removed. If irritation does occur, obtain medical advice.

**Eye** - - - - - Do not allow victim to rub eye(s). Flush with gently flowing water (preferably lukewarm) for 15 minutes or until particle is removed. Have victim look right and left, and, then up and down. If irritation does occur, obtain medical attention. DO NOT attempt to manually remove anything stuck to the eye(s).

### Section 6. Physical Chemical Characteristics

<b>Boiling Point</b>	: Not applicable	<b>Odor</b>	: Faint odor
<b>Melting Point</b>	: No data available	<b>Specific Gravity</b>	: 1.2
<b>Vapor Pressure</b>	: Not applicable	<b>Solubility in Water</b>	: Negligible
<b>Vapor Density</b>	: Not applicable	<b>PH</b>	: Not applicable
<b>Evaporation Rate</b>	: Not applicable	<b>Viscosity</b>	: Not applicable
<b>Appearance</b>	: Powder	<b>Color</b>	: Black

### Section 7. Fire and Explosion Data

<b>Flash Point (Method Used)</b>	: Not applicable
<b>Ignition Temperature</b>	: 450°C * (* = Based on data for other products with similar ingredients)
<b>Flammable Limits</b>	: (LEL):No data available(UEL): No data available
<b>Extinguishing Media</b>	: CO <sub>2</sub> , water spray, foam and dry chemical
<b>Special Fire Fighting Procedure</b>	: None
<b>Unusual Fire and Explosion Hazard</b>	: If dispersed in air, like most finely divided organic powders, may form an explosive mixture.
<b>Sensitivity to Mechanical Impact</b>	: No data available
<b>Sensitivity to Static Charge</b>	: No data available

### Section 8. Reactivity Data

<b>Stability</b>	: Stable
<b>Incompatibility (Material to Avoid)</b>	: Oxidizing materials
<b>Hazardous Decomposition</b>	: CO, CO <sub>2</sub>
<b>Hazardous Polymerization</b>	: No data available

### Section 9. Precautions for Safe Handling and Use

**Personal Protection Information (Respiratory, Eye Protection and Protective Glove)** : None required with intended use.

**Engineering Control / Ventilation** : None required with intended use.

**Work / Hygienic Practice** : Wash hands after handling. Try not to disperse the particles.

**Steps to be taken in case of Spill or Leak** : Wipe off with paper or cloth. DO NOT use vacuum cleaner. If a large amount is released. It may create a dust explosion as would most finely divided organic powders.

**Waste Disposal Method** : Waste material may be disposed under conditions which meet all federal, state and local environmental regulations.

### Section 10. Regulatory Information

<b>NFPA Rating (U.S.A.)</b>	: Health : 1 Flammability : 1 Reactivity : 0
<b>WHMIS Legislation (Canada)</b>	: Not applicable
<b>Transport Information</b>	: None
<b>UN No.</b>	: None

### Section 11. Other Information

References : IARC(1996), IARC Monographs on the Evaluation of the Carcinogenic Risk of Chemicals to Humans, Vol. 65, Printing Process and Printing Inks, Carbon Black and Some Nitro Compounds, Lyon, pp-149-261

H. Muhle, B. Bellmann, O. Creutzenberg, C. Dasenbrock, H. Ernst, R. Kilpper, J. C. Mackenzie, P. Morrow, U. Mohr, S.Takenaka, and R. Mermelstein (1991) Pulmonary Response to Toner upon Chronic Inhalation Exposure in Rats. Fundamental and Applied Toxicology 17, pp. 280-299

---

# Index

## A

Activity Report, 154  
    Auto Listing, 146  
Alarm volume, 150  
Anti Junk Fax, 138, 149  
Anti Junk Number List, 161  
Audible signals, 171  
Auto Cover Sheet, 147  
Auto reception mode, 63, 64  
Auto-dial numbers, programming, 42

## B

Batch page numbering, 61  
Batch transmission, 113 - 115  
Batch Transmission List, 159  
Beep length, 150  
Broadcasting, 69 - 71

## C

Canceling a fax, 55, 58  
Cassette Selection, 148  
Chain Dialing, 45, 55  
Changeover key, 55  
Confidential operations, 74 - 79  
Confidential Reception List, 160  
Contrast, 39  
Contrast key, 39  
Copies, making, 66  
Copy Cut-off, 147  
Copy resolution, 152  
Copying Scanning, 147  
Cover Sheet, 59  
    Auto Cover Sheet, 147

## D

Date, setting, 31  
Daylight Saving Time, 32

Department Code Digits, 151  
Department Control, 135 - 137  
Department Usage List, 160  
Dial mode, 150

## Dialing

    Chain, 45, 55  
    Direct Keypad, 52  
    Normal, 40  
    Rapid Key, 50  
    Speed, 51

Direct Keypad Dialing, 52

Distinctive ring, 142  
Document feeder, 37  
Document guides, 37  
Document key, 48  
Document restrictions, 36  
Document sizes, 35  
Document, maximum scanning area, 36  
Drum cartridge  
    Installing and replacing, 20 - 24  
Drum cartridge indicator, 24  
Duplex Scanning, 131

## E

Error Correction Mode (ECM), 147

## F

Fine Resolution Priority, 145

## G

Group Keys, 72 - 73

## H

Halftone setting, 38  
Heater mode, 149  
Housing, cleaning, 163

## Index

### I

Image Memory Print, 148

### J

Jams, clearing, 172 - 175

### L

Letters, entering, 29

Line error, 165

LINE IN USE light, 10

Loading the document, 37

### M

Manual reception mode, 63, 64

Memory

    Checking documents in, 57, 65

    Sending faxes from, 48

    Substitute reception to, 65

Memory retransmission, 56

Multi TTI, 150

### N

Normal Dialing, 40

Number of rings in AUTO reception, 145

Number of rings in manual reception,  
145

### O

Optional Setting List, 158

### P

Page Counter key, 61

Page numbering, batch, 61

Paper jams, clearing, 172 - 175

Paper, loading, 25

Passcode List, 158

Pauses in automatic dialing, 43

Polling, 88 - 95

    Security Selection, 147

Power Save Mode, 96 - 101

Print Hold, 133 - 134, 152

Priority key, 48

Program and Group List, 159

Programs, 116 - 130

### Q

Quick On-line, 150

### R

Rapid Key Dialing, 50

Recall Interval, 146

Recall Times, 146

Receive Reduce, 148

Reception mode

    Auto, 63, 64

    Manual, 63, 64

    Setting, 63

Redial key, 41

Redialing, 41, 56

Relay Broadcast, 86

Relay Group List, 157

Relay Request, 80 - 85

Resolution, 38

Resolution key, 39

Retransmission interval, 149

Retransmission times, 149

Ringer volume, 34

### S

Scanning glass, cleaning, 162

Search Dial, 53

Seperate Mode, 153

Speaker volume, 33

Speed Dialing, 51

STATUS CHECK light, 10

### T

TEL. LINE jack, 17

TEL. SET jack, 17

- Telephone
    - Connecting, 17
  - Telephone billing, 140
  - Telephone Billing Code, 151
  - Telephone line cord, 17
  - Telephone line status, checking, 55
  - Telephone Number List, 157
  - Time, setting, 31
  - Timer, 102
  - Timer List, 157
  - Toner cartridge
    - Installing and replacing, 20 - 24
  - Toner cartridge indicator, 24
  - Transaction Report, 161
    - Print Selection, 146
- V**
- Verification Stamp, 19, 152
    - Replacing, 163

## Index





## Index

## NOTICE

BE SURE TO ASK YOUR AUTHORIZED SHARP DEALER ABOUT THE WARRANTY THAT YOUR SELLING DEALER EXTENDS TO YOU. In order to assure you, the end-user, of warranty protection, Sharp extends a limited warranty to each of its authorized dealers and, in turn, requires each of its authorized dealers to extend its own warranty to you on terms that are no less favorable than those given to the dealer by Sharp. You should be aware, however, that Sharp does not itself extend any warranties, either express or implied, directly to you, the end-user, and no one is authorized to make any representations or warranties on behalf of Sharp. Specifically, SHARP DOES NOT EXTEND TO YOU, THE END-USER, ANY EXPRESS WARRANTY OR ANY IMPLIED WARRANTY OF MERCHANTABILITY, FITNESS FOR USE OR FITNESS FOR ANY PARTICULAR PURPOSE IN CONNECTION WITH THE HARDWARE, SOFTWARE OR FIRMWARE EMBODIED IN, OR USED IN CONJUNCTION WITH THIS PRODUCT. Sharp is not responsible for any damages or loss, either direct, incidental or consequential, which you, the end-user, may experience as a result of your purchase or use of the hardware, software or firmware embodied in or used in conjunction with this Product. Your sole remedy, in the event that you encounter any difficulties with the Product, is against the authorized dealer from which you purchased the Product. In the event that this authorized dealer does not honor its warranty commitments, please contact the Vice President, Sharp Document Network System of America, Business Product Group, Sharp Plaza, Mahwah, NJ 07430-2135, so that Sharp can try to help assure complete satisfaction of all the warranty rights to which you are entitled from the authorized dealer.

# SHARP®

## SHARP DOCUMENT NETWORK SYSTEM OF AMERICA

Sharp Plaza, Mahwah, New Jersey 07430-2135

### SHARP CORPORATION

#### FOR YOUR RECORDS

Please record the model number and serial number below, for easy reference, in case of loss or theft. These numbers are located on the rear side of the unit. Space is also provided for other relevant information.

Model Number \_\_\_\_\_

Serial Number \_\_\_\_\_

Date of Purchase \_\_\_\_\_

Place of Purchase \_\_\_\_\_

PRINTED IN THAILAND

(TINSE4211XHTZ)

## Free Manuals Download Website

<http://myh66.com>

<http://usermanuals.us>

<http://www.somanuals.com>

<http://www.4manuals.cc>

<http://www.manual-lib.com>

<http://www.404manual.com>

<http://www.luxmanual.com>

<http://aubethermostatmanual.com>

Golf course search by state

<http://golfingnear.com>

Email search by domain

<http://emailbydomain.com>

Auto manuals search

<http://auto.somanuals.com>

TV manuals search

<http://tv.somanuals.com>