

# SHARP

**ENGLISH**Please refer to  
pages E-1 to E-32.**ESPAÑOL**Consulte las  
páginas S-1 a S-32.

## 1-BIT DIGITAL HOME THEATER SISTEMA 1-BIT PARA HOME THEATER

MODEL  
MODELO

# SD-AT1000W

OPERATION MANUAL  
MANUAL DE MANEJO

# ENGLISH

## Introduction

Thank you for purchasing this SHARP product. To obtain the best performance from this product, please read this manual carefully. It will guide you in operating your SHARP product.

- SD-AT1000W 1-Bit Digital Home Theater consisting of SD-AT1000W (main unit), CP-AT1000WF (front speakers), CP-AT1000WC (centre speaker), CP-AT1000WR (surround speakers) and CP-AT1000WSW (subwoofer).

## Special notes

### WARNING

- When the ON/STAND-BY button is set at STAND-BY position, mains voltage is still present inside the unit. When the ON/STAND-BY button is set at STAND-BY position, the unit may be brought into operation by the timer mode or remote control.
- This unit contains no user serviceable parts. Never remove covers unless qualified to do so. This unit contains dangerous voltages, always remove mains plug from the socket before any service operation and when not in use for a long period.
- To prevent fire or shock hazard, do not expose this appliance to dripping or splashing. No objects filled with liquids, such as vases, should be placed on the apparatus.

Manufactured under license from Digital Theater Systems, Inc. US Pat. No. 5,451,942, 5,956,674, 5,974,380, 5,978,762 and other world-wide patents issued and pending. "DTS" and "DTS Digital Surround" are registered trademarks of Digital Theater Systems, Inc. Copyright 1996, 2000 Digital Theater Systems, Inc. All Rights Reserved.

Manufactured under license from Dolby Laboratories. "Dolby", "Pro Logic" and the double-D symbol are trademarks of Dolby Laboratories.

## Contents

	Page
<b>■ General Information</b>	
Accessories .....	2
Precautions .....	2
Controls and indicators .....	3 - 8
<b>■ System connections</b>	
Speaker connection .....	9, 10
Aerial connection .....	10
Audio connections to DVD players, VCRs, TVs, etc. ....	11, 12
Connecting the AC power lead .....	13
<b>■ Preparation for Use</b>	
Setting the AM/FM interval .....	14
System installation .....	15
Remote control .....	16
General control .....	17
Setting the clock .....	18
<b>■ Basic Operation</b>	
Listening to the radio .....	19, 20
Listening to the playback sound from DVD players, VCRs, etc. ....	21
Enjoying various sounds .....	22 - 24
<b>■ Advanced Features</b>	
Adjusting speaker delay/speaker level .....	25, 26
Timer and sleep operation .....	27 - 29
<b>■ References</b>	
Troubleshooting chart .....	30, 31
Maintenance .....	31
Error indicators and warnings .....	31
Optional accessory .....	31
Specifications .....	32

# Accessories

Please confirm that the following accessories are included.

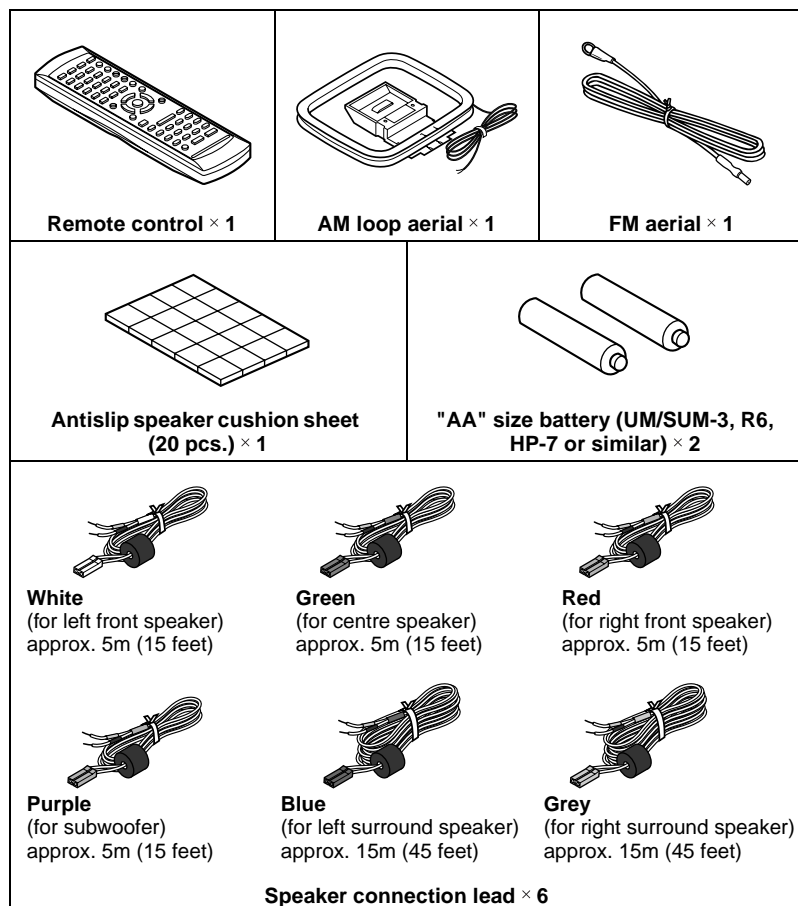

## Note:

Only the above accessories are included.

# Precautions

SD-AT1000W

ENGLISH

1

## General

- Please ensure that the equipment is positioned in a well ventilated area and that there is at least 10 cm (4") of free space along the sides and back. There must also be a minimum of 15 cm (6") of free space on the top of the unit.

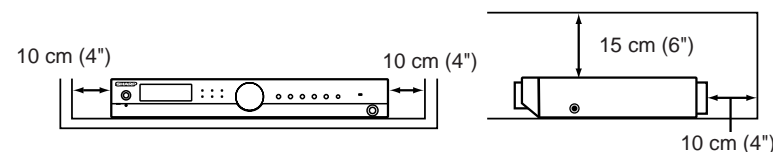

- Use the unit on a firm, level surface free from vibration.
- Keep the unit away from direct sunlight, strong magnetic fields, excessive dust, humidity and electronic/electrical equipment (home computers, facsimiles, etc.) which generates electrical noise.
- Do not place anything on top of the unit.
- Do not expose the unit to moisture, to temperatures higher than 60°C (140°F) or to extremely low temperatures.
- If the unit does not work properly, unplug and plug it in again. Then turn on the unit.
- In case of an electrical storm, unplug the unit for safety.
- Hold the AC power plug by the head when removing it from the wall socket, as pulling the lead can damage internal wires.
- **Do not remove the outer cover, as this may result in electric shock. Refer internal service to your local SHARP service facility.**
- The ventilation should not be impeded by covering the ventilation openings with items, such as newspapers, tablecloths, curtains, etc.
- No naked flame sources, such as lighted candles, should be placed on the apparatus.
- Attention should be drawn to the environmental aspects of battery disposal.
- This unit should only be used within the range of 5°C - 35°C (41°F - 95°F).

## Warning:

The voltage used must be the same as that specified by this unit. Using this product with a higher voltage other than that specified is dangerous and may result in a fire or other types of accident, causing damage. SHARP will not be held responsible for any damage resulting from the use of this unit with a voltage other than that specified.

## Volume control

The sound level at a given volume setting depends on speaker efficiency, location, and various other factors. It is advisable to avoid exposure to high volume levels. Do not turn the volume on to full at switch on and listen to music at moderate levels.

# Controls and indicators

ENGLISH

## ■ Main unit (front panel)

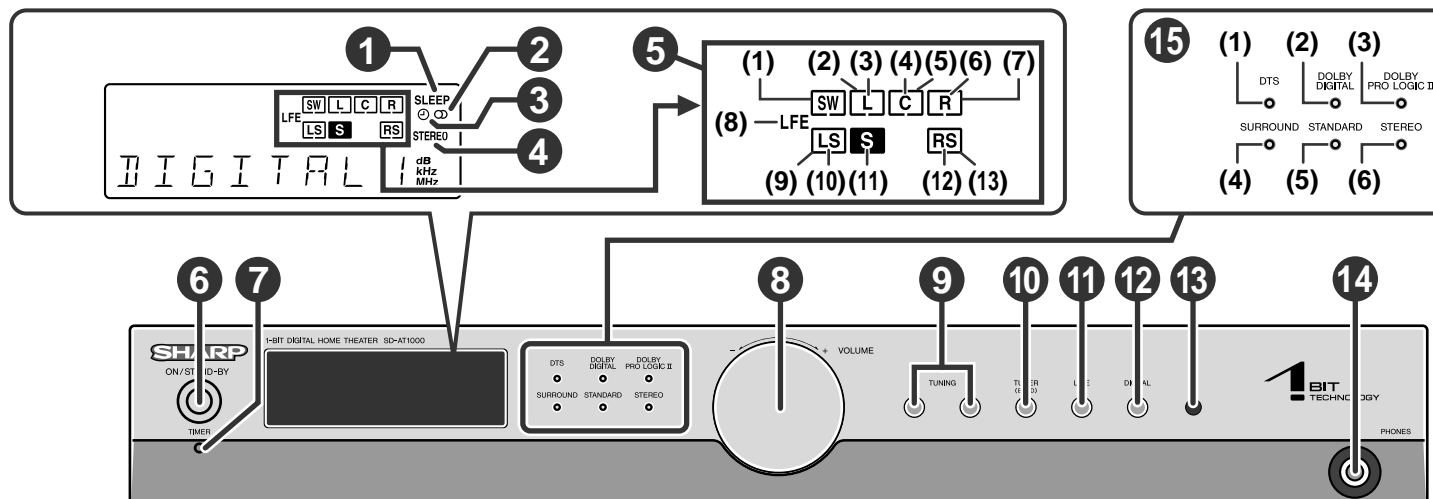

	Reference page
1. Sleep Indicator .....	29
2. FM Stereo Receiving Indicator .....	19
3. Timer Play Indicator .....	27
4. FM Stereo Mode Indicator .....	19
5. Audio Signal Indicators/Speaker Indicators .....	22
(1) Subwoofer Indicator	
(2) Left Front Speaker Indicator	
(3) Front Left Signal Indicator	
(4) Centre Signal Indicator	
(5) Centre Speaker Indicator	
(6) Front Right Signal Indicator	
(7) Right Front Speaker Indicator	
(8) Low Frequency Effect Signal Indicator	
(9) Left Surround Speaker Indicator	
(10) Surround Left Signal Indicator	
(11) Surround Monaural Signal Indicator	
(12) Surround Right Signal Indicator	
(13) Right Surround Speaker Indicator	

	Reference page
6. On/Stand-by Button .....	13
7. Timer Set Indicator .....	28
8. Volume Control .....	17
9. Tuning Up and Down Buttons .....	14, 19
10. Tuner (Band) Button .....	14, 19
11. Line Input Select Button .....	21
12. Digital Input Select Button .....	21
13. Remote Sensor .....	16
14. Headphone Socket .....	17
15. Sound Mode Indicators .....	22, 23, 24
(1) DTS Signal Indicator	
(2) Dolby Digital Signal Indicator	
(3) Dolby Pro Logic II Indicator	
(4) Surround Indicator	
(5) Standard Indicator	
(6) Stereo Indicator	

## ■ Main unit (rear panel)

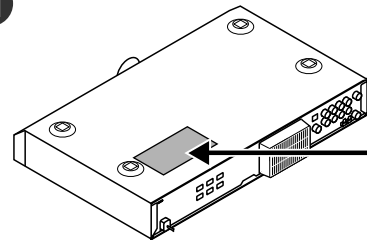
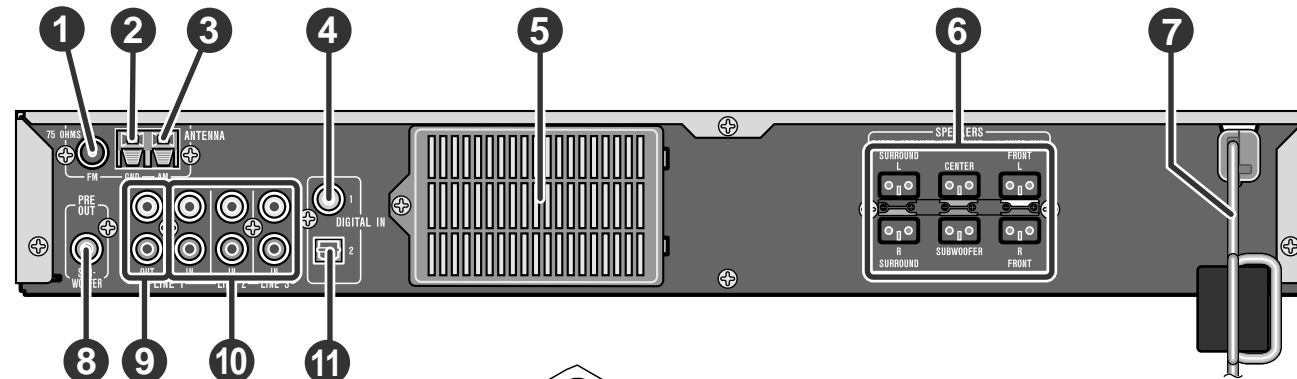

The rating label is located on the bottom of the unit.

	Reference page
1. FM 75 Ohms Aerial Socket .....	10
2. Aerial Earth Terminal .....	10
3. AM Loop Aerial Terminal .....	10
4. Coaxial Digital Audio Input Socket .....	11
5. Cooling Fan .....	4
6. Speaker Terminals .....	9
7. AC Power Lead .....	13
8. Subwoofer Pre Output Socket .....	12
9. Audio Line Output Sockets .....	11
10. Audio Line Input Sockets .....	11, 12
11. Optical Digital Audio Input Socket .....	11

### Cooling fan

This unit is fitted with a cooling fan at the rear for improved cooling. Do not cover the opening in this section with any obstacles.

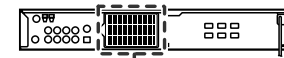

Cooling fan

### Caution:

- The unit will get warm whilst being used. Do not touch the warm areas of the unit for prolonged periods to avoid damage to you.
- This unit is equipped with a special function which protects the amplifier circuit from damages. When it is activated, the sound switch is turned off. In this case, set the unit to the stand-by mode and turn on again.

# Controls and indicators (continued)

ENGLISH

General Information  
- Controls and indicators -

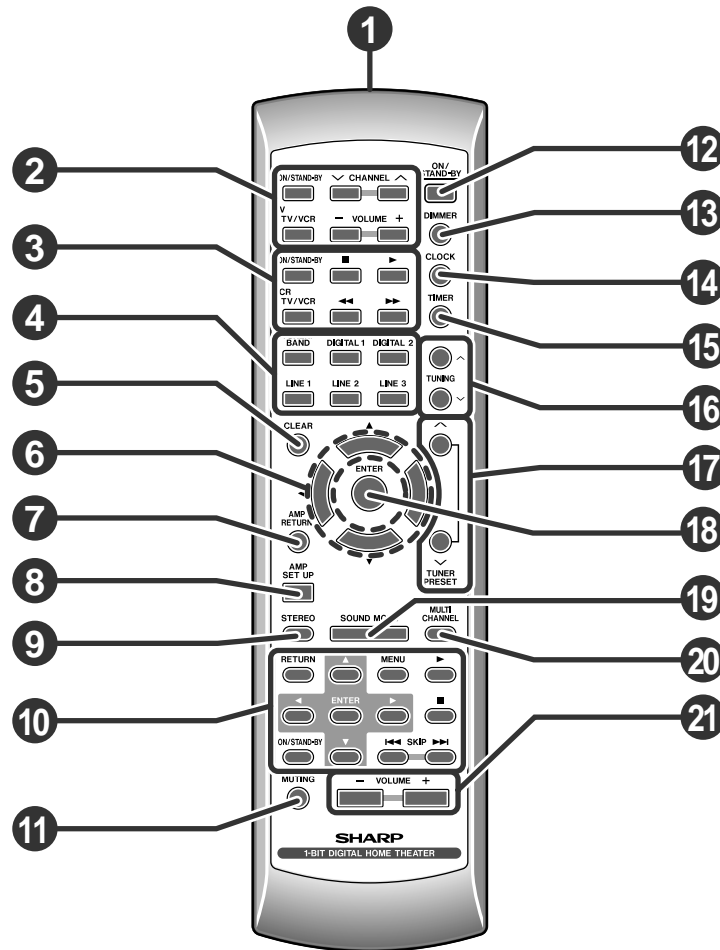

## ■ Remote control

	Reference page
1. Remote Control Transmitter .....	.16
2. TV Operation Buttons .....	.6
3. VCR Operation Buttons .....	.6
4. Input Select Buttons .....	.19, 21
5. Clear Button .....	.20
6. Cursor Buttons .....	.18, 25
7. Amplifier Return Button .....	.25
8. Amplifier Initial Setting Button .....	.25
9. 2-channel Stereo Sounds Select Button .....	.24
10. DVD Operation Buttons .....	.6
11. Muting Button .....	.17
12. On/Stand-by Button .....	.16
13. Dimmer Button .....	.17
14. Clock Button .....	.18
15. Timer Button .....	.27
16. Tuning Up and Down Buttons .....	.14, 19
17. Tuner Preset Up and Down Buttons .....	.20
18. Enter Button .....	.14
19. Sound Mode Select Button .....	.23
20. Multi Channel Select Button .....	.23
21. Volume Up and Down Buttons .....	.17

It is possible to operate some functions of Sharp TVs, VCRs and DVD players with your new SD-AT1000W remote control. However some models may not respond.

### TV Operation Buttons

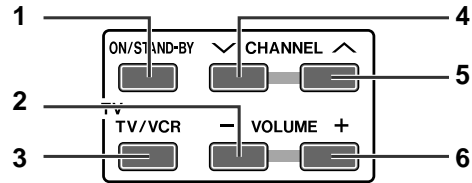

- |   |   |
|---|---|
| <b>1 TV ON/STAND-BY</b><br>Sets the TV power to "ON" or "STAND-BY". | <b>4 TV CHANNEL ▾</b><br>Switches down the TV channels. |
| <b>2 TV VOLUME -</b><br>Turns down the TV volume.                   | <b>5 TV CHANNEL ▲</b><br>Switches up the TV channels.   |
| <b>3 TV TV/VCR</b><br>Switches the input to TV or VCR.              | <b>6 TV VOLUME +</b><br>Turns up the TV volume.         |

### VCR Operation Buttons

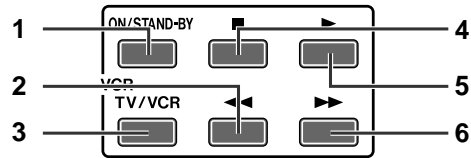

- |   |  |
|---|--|
| <b>1 VCR ON/STAND-BY</b><br>Sets the VCR power to "ON" or "STAND-BY". | <b>4 VCR ■</b><br>Stops the cassette.              |
| <b>2 VCR ◀◀</b><br>Rewinds the cassette quickly.                      | <b>5 VCR ▶▶</b><br>Plays the cassette.             |
| <b>3 VCR TV/VCR</b><br>Switches the input to TV or VCR.               | <b>6 VCR ▶▶▶</b><br>Advances the cassette quickly. |

### DVD Operation Buttons

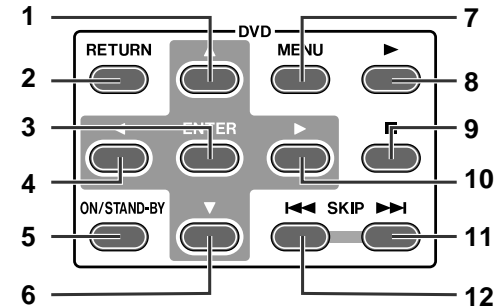

- |   |  |
|---|--|
| <b>1 DVD ▲</b><br>Selects the DVD menu.                               | <b>7 DVD MENU</b><br>Displays the DVD menu.          |
| <b>2 DVD RETURN</b><br>Goes back to the previous screen.              | <b>8 DVD ▶</b><br>Plays back the DVD.                |
| <b>3 DVD ENTER</b><br>Validates the menu.                             | <b>9 DVD ■</b><br>Stops the DVD player.              |
| <b>4 DVD ▾</b><br>Selects the DVD menu.                               | <b>10 DVD ◀</b><br>Selects the DVD menu.             |
| <b>5 DVD ON/STAND-BY</b><br>Sets the DVD power to "ON" or "STAND-BY". | <b>11 DVD SKIP ▶▶</b><br>Skip up the DVD chapters.   |
| <b>6 DVD ▽</b><br>Selects the DVD menu.                               | <b>12 DVD SKIP ◀◀</b><br>Skip down the DVD chapters. |

## Controls and indicators (continued)

ENGLISH

General Information  
- Controls and indicators -

### ■ Front speaker × 2

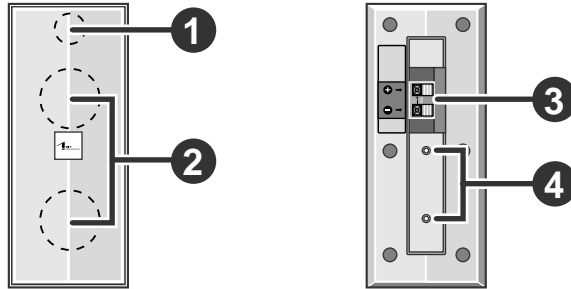

1. Bass Reflex Duct
2. Speakers
3. Speaker Terminals
4. Mounting Holes for Stand or Bracket

### ■ Surround speaker × 2

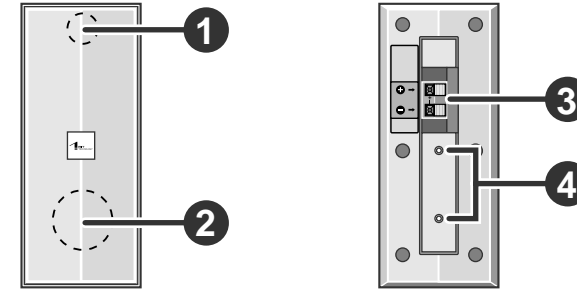

1. Bass Reflex Duct
2. Speaker
3. Speaker Terminals
4. Mounting Holes for Stand or Bracket

### ■ Centre speaker × 1

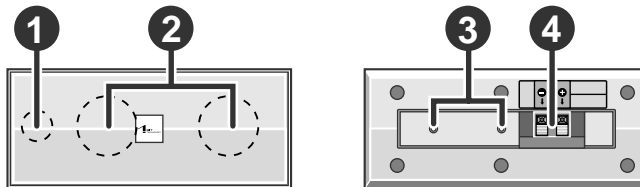

1. Bass Reflex Duct
2. Speakers
3. Mounting Holes for Bracket
4. Speaker Terminals

### ■ Subwoofer × 1

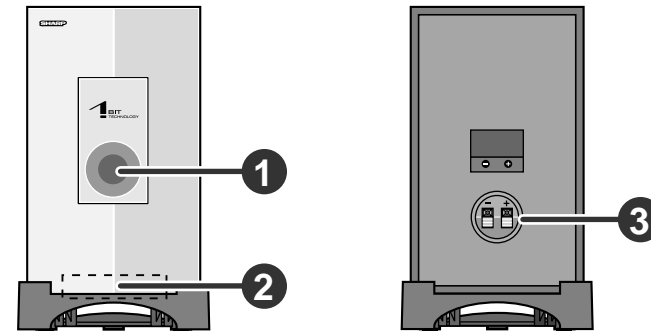

1. Bass Reflex Duct
2. Woofer
3. Speaker Terminals



## ■ Speaker functions

### Front speaker:

Reproduces left and right sound (for the stereo mode) or front surround sound.

### Centre speaker:

Reproduces centre surround sound.

### Surround speaker:

Reproduces rear surround sound.

### Subwoofer:

Reproduces bass sound.

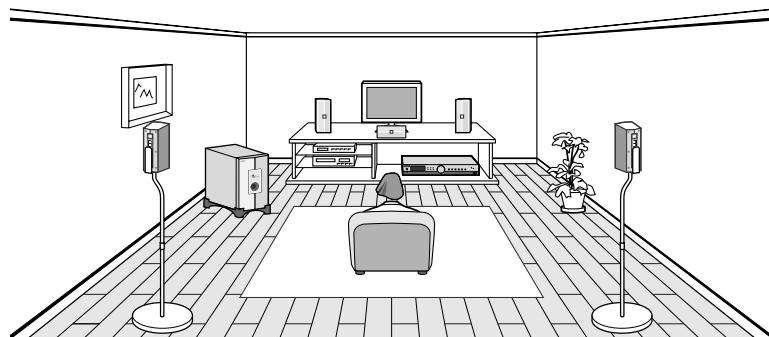

(For speaker installation, refer to page 15.)

### Notes:

- Do not allow any objects to fall into or to be placed in the bass reflex ducts.
- The speakers grilles are not removable.
- Front, centre and subwoofer speakers are magnetically shielded.

## ■ Using antislip speaker cushions

You can install the front, centre or surround speakers either vertically or horizontally. Affix the cushions (supplied) to the bottom of the speakers to prevent them from sliding or falling due to vibration.

(Vertical position)

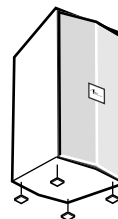

(Horizontal position)

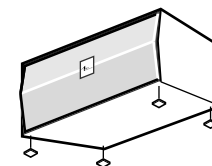

A sheet of speaker cushions (20 pcs.) is supplied with this product. Use 4 cushions per speaker.

## ■ Carrying the subwoofer

When carrying the subwoofer, be careful not to touch the subwoofer located near bottom. It may be damaged. Be sure to hold the unit by its base.

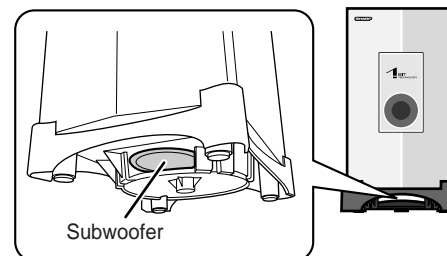

# Speaker connection

ENGLISH

The speaker terminals on the main unit, the tube and plugs of the speaker lead, and speaker labels are distinguished by colours. Connect the speaker and the unit by matching the colours. (For speaker installation, refer to page 15.)

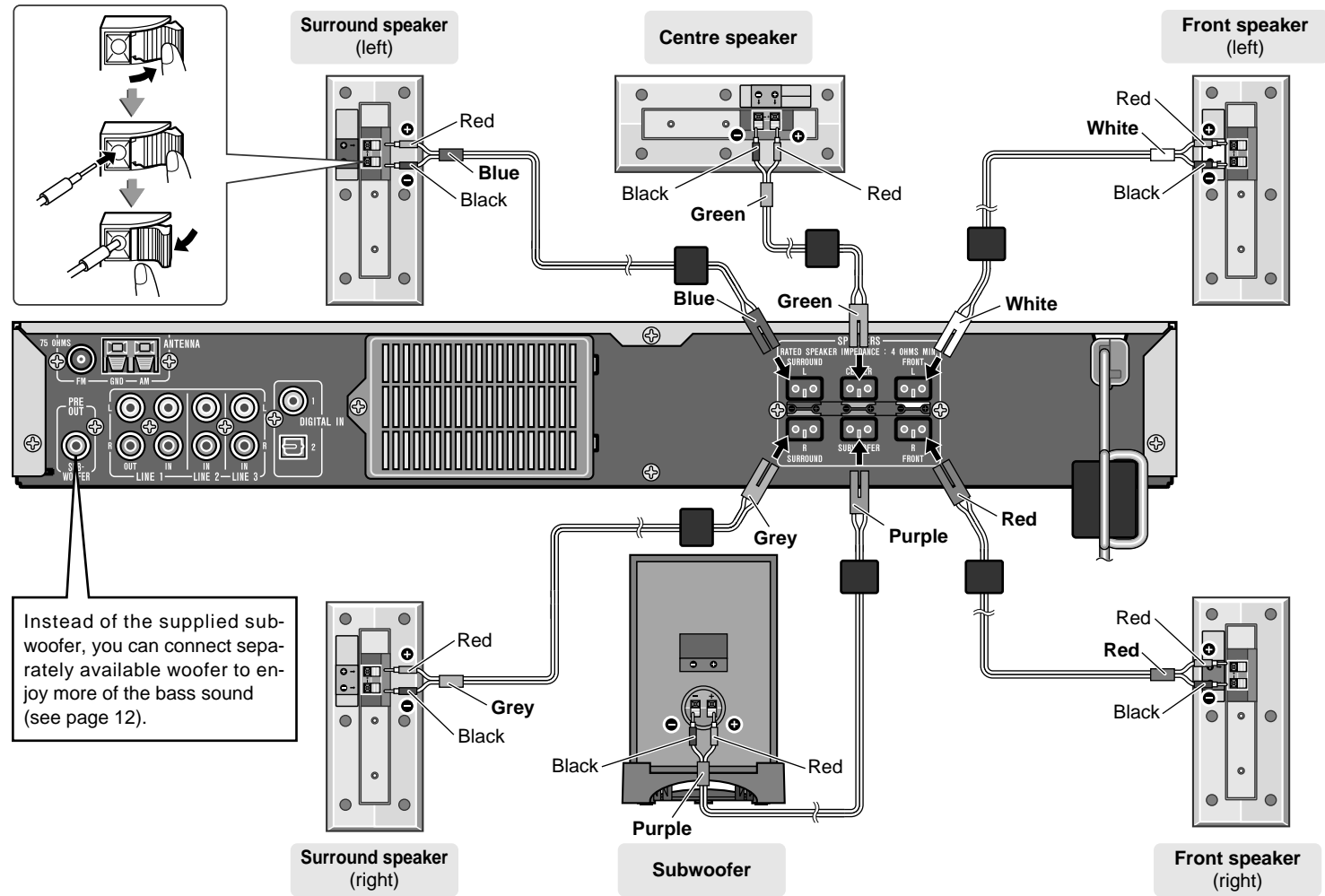

## ■ Connecting speaker wires

**Make sure to leave the AC power lead disconnected when connecting the speakers.**

To prevent accidental short circuit between  $\oplus$  and  $\ominus$  terminals, connect the speaker wires to the speakers first then to the unit.

### 1 Connect the wires to the speakers.

Speaker terminals

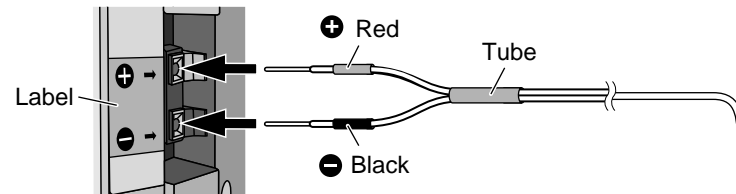

### 2 Connect the other end to the main unit.

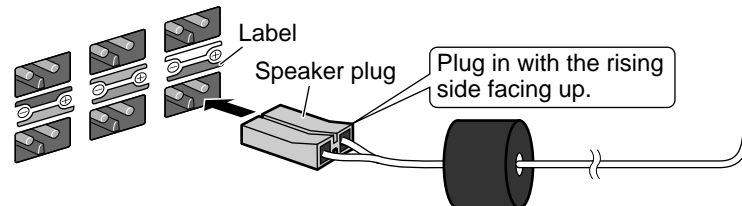

#### Caution:

- The supplied speakers are exclusively for SD-AT1000W. Do not connect them to other equipment, and do not connect other speakers to SD-AT1000W. It may cause malfunction.
- Do not mistake the  $\oplus$  and  $\ominus$ , and right and left terminals of the speaker leads. (The right speaker is placed on the right when you face the unit.)
- Do not let the bare speaker wires touch each other.
- Do not stand or sit on the speakers. You may be injured.
- Insert the speaker plug fully with the rising side facing up.
- Hold the speaker plug when removing it from the main unit. Pulling the lead may cause malfunction to the unit.

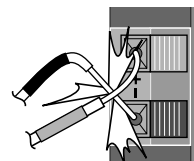

Incorrect

## Aerial connection

SD-AT1000W

ENGLISH

1

#### Supplied FM aerial:

Connect the FM aerial wire to the FM 75 OHMS socket and position the FM aerial wire in the direction where the strongest signal can be received.

#### Supplied AM loop aerial:

Connect the AM loop aerial wire to the AM and GND terminals. Position the AM loop aerial for optimum reception. Place the AM loop aerial on a shelf, etc., or attach it to a stand or a wall with screws (not supplied).

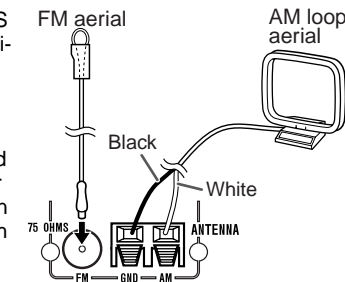

#### Notes:

- Placing the aerial on the unit or near the AC power lead may cause noise pickup. Place the aerial away from the unit for better reception.
- When static is still heard even after adjusting the position of the AM loop aerial, try reversing the wire connections.

#### Installing the AM loop aerial:

< Assembling >

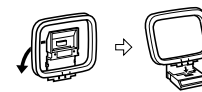

< Attaching to the wall >

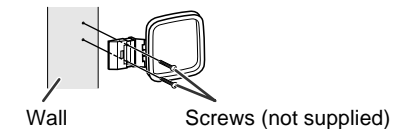

#### External FM or AM aerial:

Use an external FM or AM aerial if you require better reception. Consult your dealer. When using an external AM aerial, be sure to keep the wire of the AM loop aerial connected.

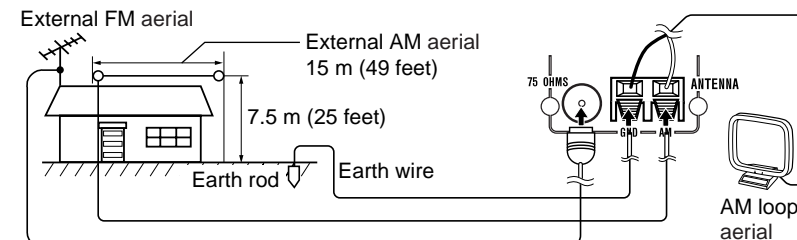

System connections  
- Speaker connection / Aerial connection -

E-10

# Audio connections to DVD players, VCRs, TVs, etc.

ENGLISH

System connections  
- Audio connections to DVD players, VCRs, TVs, etc. -

## ■ Connecting a DVD player (CD player), digital tuner, etc.

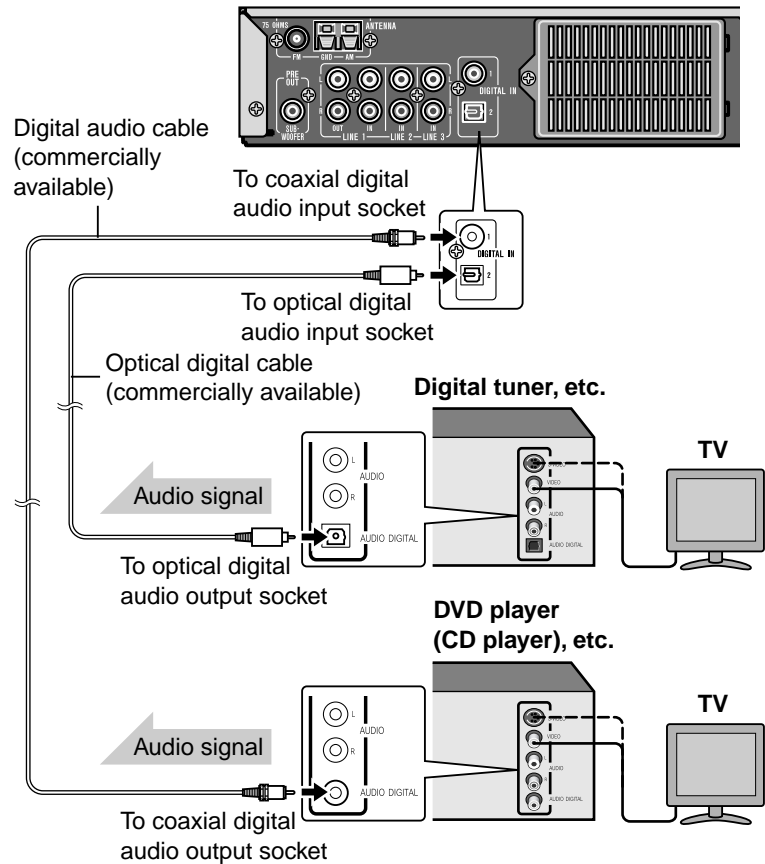

### Notes:

- This unit has DIGITAL IN 1 (coaxial) and DIGITAL IN 2 (optical) sockets for digital input. Select either according to the output socket of your equipment.
- When connecting with an optical digital cable, set the digital output of the digital tuner to PCM. Refer to the operation manual of the digital tuner.

## ■ Connecting a VCR, etc.

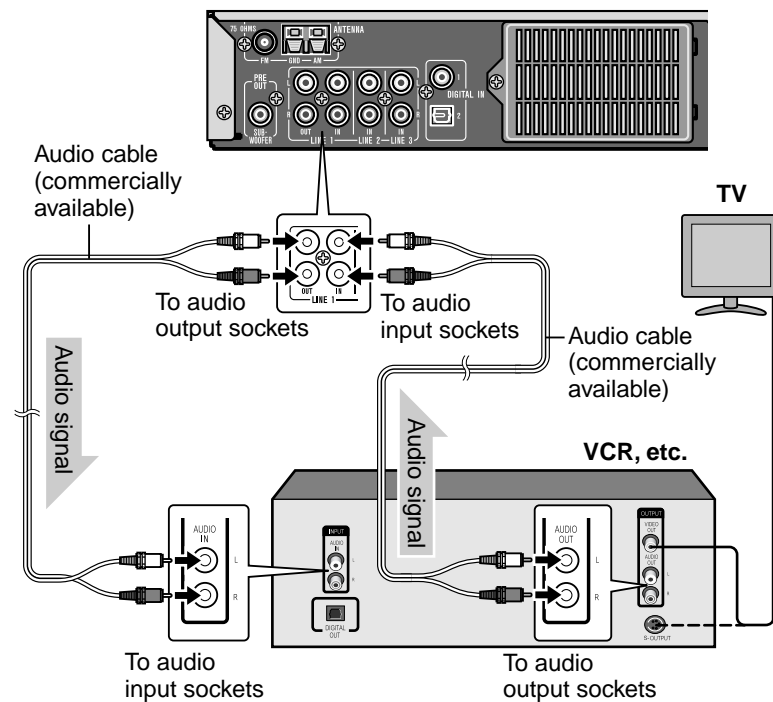

### Notes:

- The LINE 1 OUT sockets emit signals from the LINE 2 IN, LINE 3 IN and the built-in tuner. Signals from the DIGITAL IN and LINE 1 IN are not emitted.
- Connect TV directly to the DVD player, VCR or digital tuner to watch programmes (refer to the operation manual of each equipment).

## ■ Audio connection to TVs or other equipment

You can enjoy surround sound from TVs or other equipment by connecting them to the unit as shown.

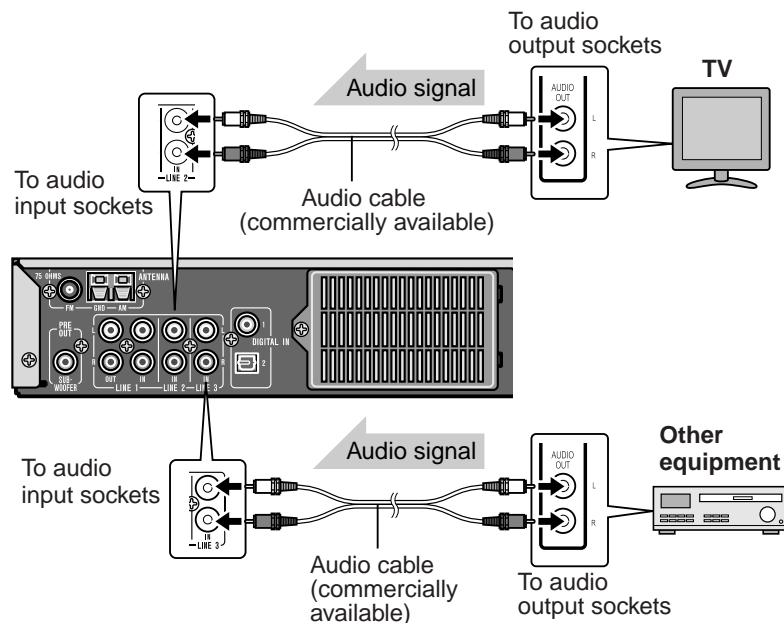

### Caution:

Turn off all other equipment before making this connection.

### Notes:

- Refer to the operation manual of the equipment to be connected.
- Insert the plugs fully to avoid fuzzy pictures or noise.

## ■ Using other subwoofer

For a greater emphasis of bass, a commercially available subwoofer, with a built in amplifier, can be connected to the unit using the SUBWOOFER PRE OUT socket.

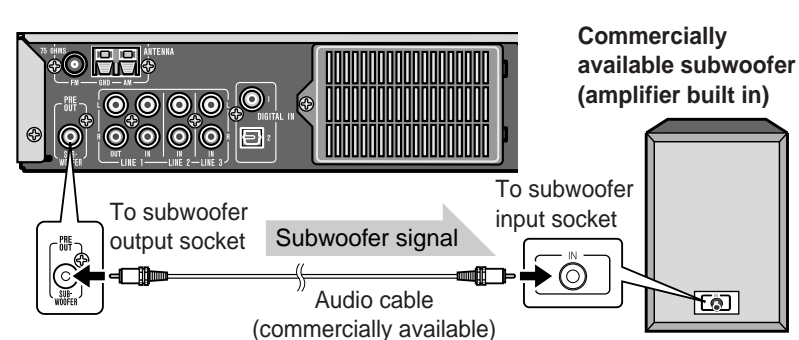

### Notes:

- No sound is heard from the speaker in which an amplifier is not built in.
- When not using the supplied subwoofer, disconnect the speaker wire from the main unit.
- The speaker delay and level settings are applied to the subwoofer connected to the SUBWOOFER PRE OUT socket (see pages 25 and 26).

# Connecting the AC power lead

ENGLISH

After checking all the connections have been made correctly, plug the AC power lead of this unit into the wall socket.

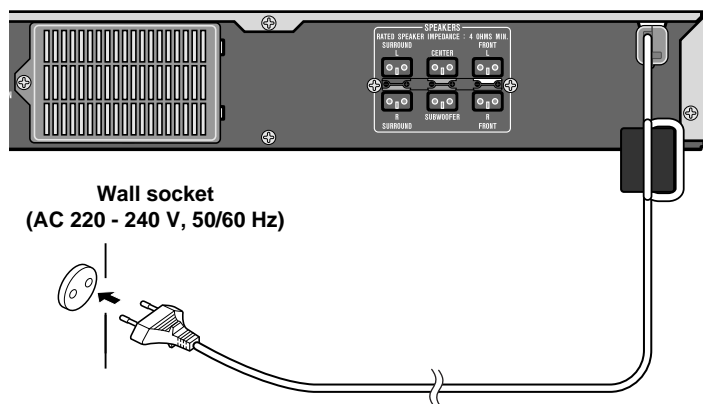

**Note:**

Unplug the AC power lead from the wall socket if the unit will not be in use for a prolonged period of time.

## ■ To turn the power on

ON/STAND-BY

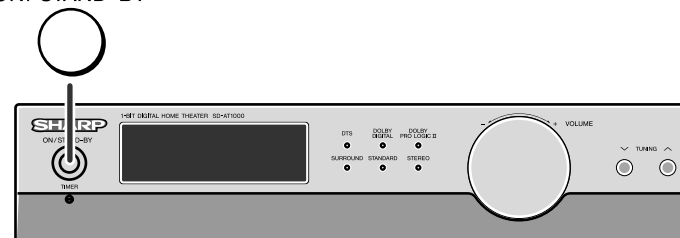

**Press the ON/STAND-BY button.**

If the power does not turn on, check the AC power lead is plugged in properly.

**To set the unit to stand-by mode:**

Press the ON/STAND-BY button again.

# Setting the AM/FM interval

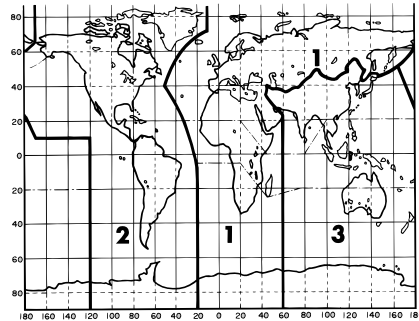
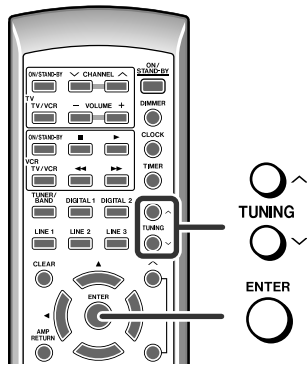
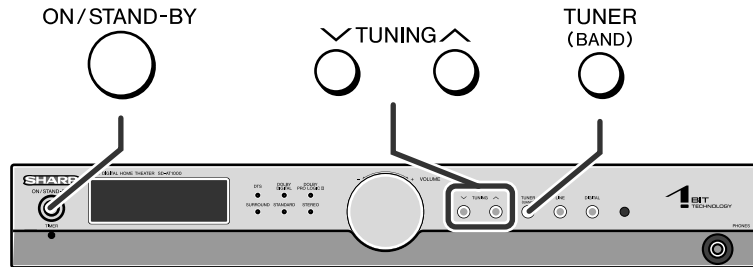

The International Telecommunication Union (ITU) has established that member countries should maintain either a 10 kHz or 9 kHz interval between broadcasting frequencies of AM stations and 100 kHz or 50 kHz for FM stations. The illustration shows the 50/9 kHz zones (regions 1 and 3), and the 100/10 kHz zone (region 2).

This product is not equipped with a span selector. However, it will be adjusted to a 10 kHz AM (100 kHz FM) interval when shipped from the factory. Before using the unit, be sure to set it to the AM/FM tuning interval (span) used in your area.

### To change the AM/FM tuning interval:

- 1 Press the ON/STAND-BY button to enter the stand-by mode.
- 2 Whilst holding down the TUNER (BAND) button, press the ON/STAND-BY button.

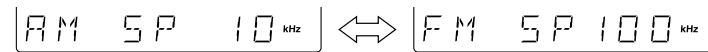

- 3 Within 6 seconds, press the TUNING (∨ or ∧) button to select the interval (span) in your area. The display switches each time you press the button.

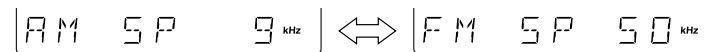
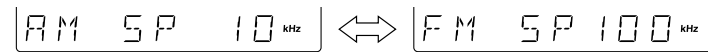

- 4 Within 6 seconds, press the ENTER button on the remote control.
  - The unit will enter the power stand-by mode automatically.

### Note:

The AM/FM tuning interval will not change unless you press the ENTER button within 6 seconds.

### Caution:

- When the unit is left for a few hours after the span has been switched and the AC power lead disconnected, the AM span will be automatically returned to 10 kHz (FM span to 100 kHz). If this happens, set the span again.
- When the span is switched, all the memorised stations will be cancelled.

Preparation for Use  
- Setting the AM/FM interval -

# System installation

ENGLISH

Preparation for Use  
- System installation -

## ■ Placing the speaker system

The best surround effect will be achieved by placing each speaker at the same distance from the listening position.

It is recommended to arrange the speakers as shown below.

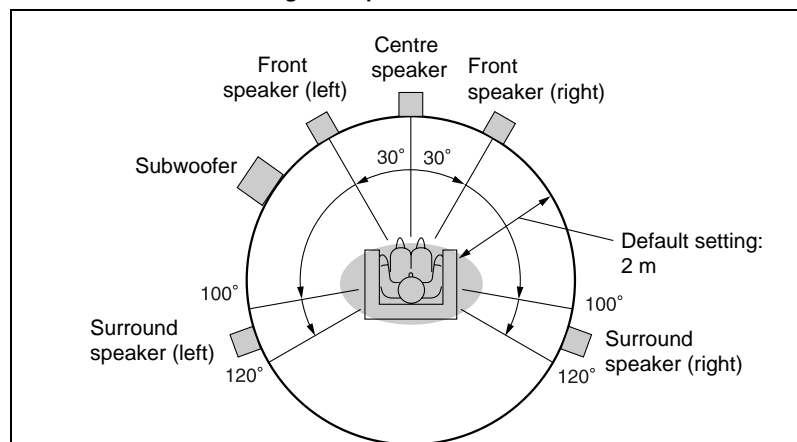

### Note:

The default distance is set to 2 m. If speakers cannot be placed at equal distances, refer to "Speaker delay setting" (see page 25).

### Installation image:

The speaker stands are optionally available (see page 31). Refer to their instructions for assembly.

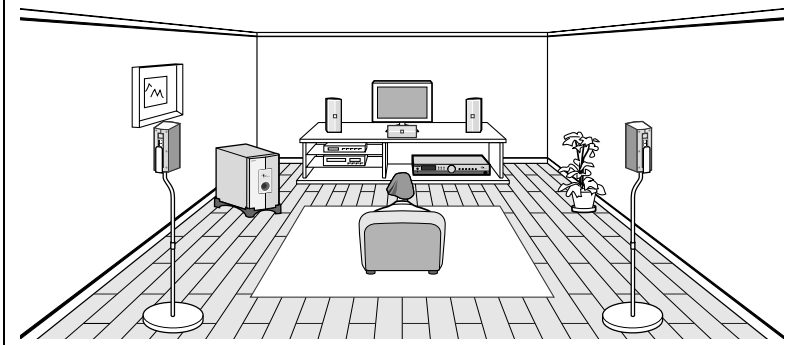

### Notes:

- Place the TV halfway between the front speakers.
- It is recommended that the centre speaker be placed near the television.
- Place the surround speakers at a position just above the height of your ears.
- The subwoofer vibrates whilst reproducing bass. Place it on a stable, sturdy surface.
- The subwoofer reproduces bass. Place it anywhere you like.

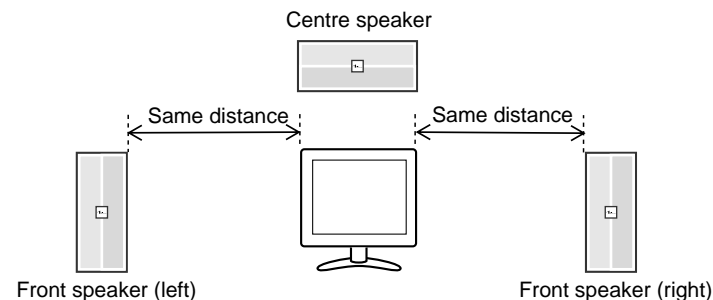

## ■ Magnetically shielded speakers

The front, centre and subwoofer speakers may be placed beside or near the TV as they are magnetically shielded. However, discolouration may occur depending on the TV type.

### If colour variation occurs...

Turn off the TV (from the power switch).  
After 15 - 30 minutes, turn the TV on again.

### If the colour variation is still present...

Move the speakers further away from the TV.  
Refer to the user's manual of the TV for details.

### Note:

The surround speakers are not magnetically shielded.



# Remote control

SD-AT1000W

ENGLISH

1

## ■ Battery installation

- 1 **Open the battery cover.**
- 2 **Insert the batteries according to the direction indicated in the battery compartment.**  
When inserting or removing the batteries, push them towards the ⊖ battery terminals.
- 3 **Close the cover.**

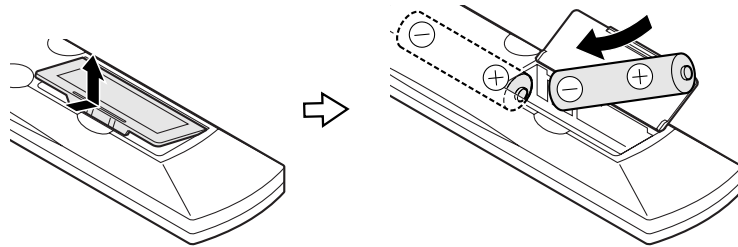

### Precautions for battery use:

- Replace all old batteries with new ones at the same time.
- Do not mix old and new batteries.
- Remove the batteries if the unit is not to be used for long periods of time. This will prevent potential damage due to battery leakage.

### Caution:

- Do not use rechargeable batteries (nickel-cadmium battery, etc.).
- Installing the batteries incorrectly may cause the unit to malfunction.

### Notes concerning use:

- Replace the batteries if the operating distance is reduced or if the operation becomes erratic. Purchase 2 "AA" size batteries (UM/SUM-3, R6, HP-7 or similar).
- Periodically clean the transmitter on the remote control and the sensor on the unit with a soft cloth.
- Exposing the sensor on the unit to strong light may interfere with operation. Change the lighting or the direction of the unit.
- Keep the remote control away from moisture, heat, shock, and vibrations.

## ■ Test of the remote control

Check the remote control after checking all the connections (see pages 9 - 13). Point the remote control directly at the remote sensor on the unit.

**The remote control can be used within the range shown below:**  
Press the ON/STAND-BY button. Does the power turn on? Now, you can enjoy your system.

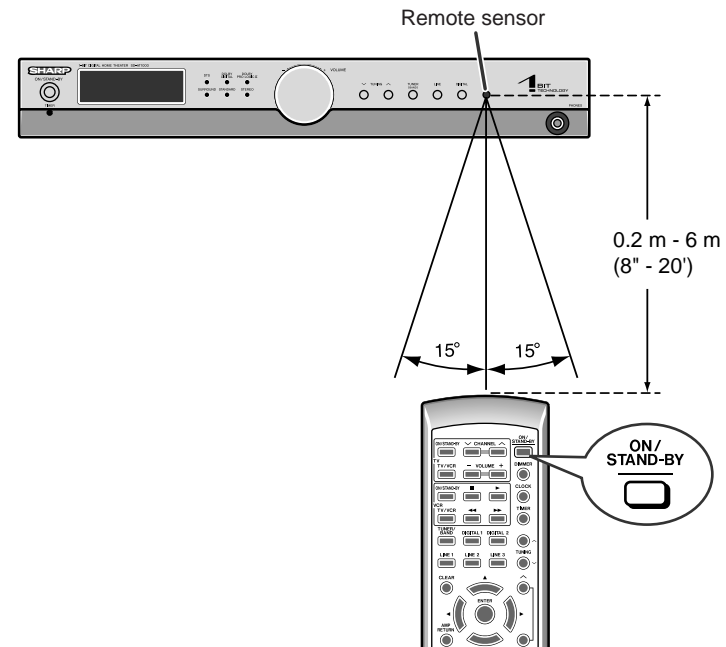

Preparation for Use  
- Remote control -

E-16

# General control

ENGLISH

Preparation for Use  
- General control -

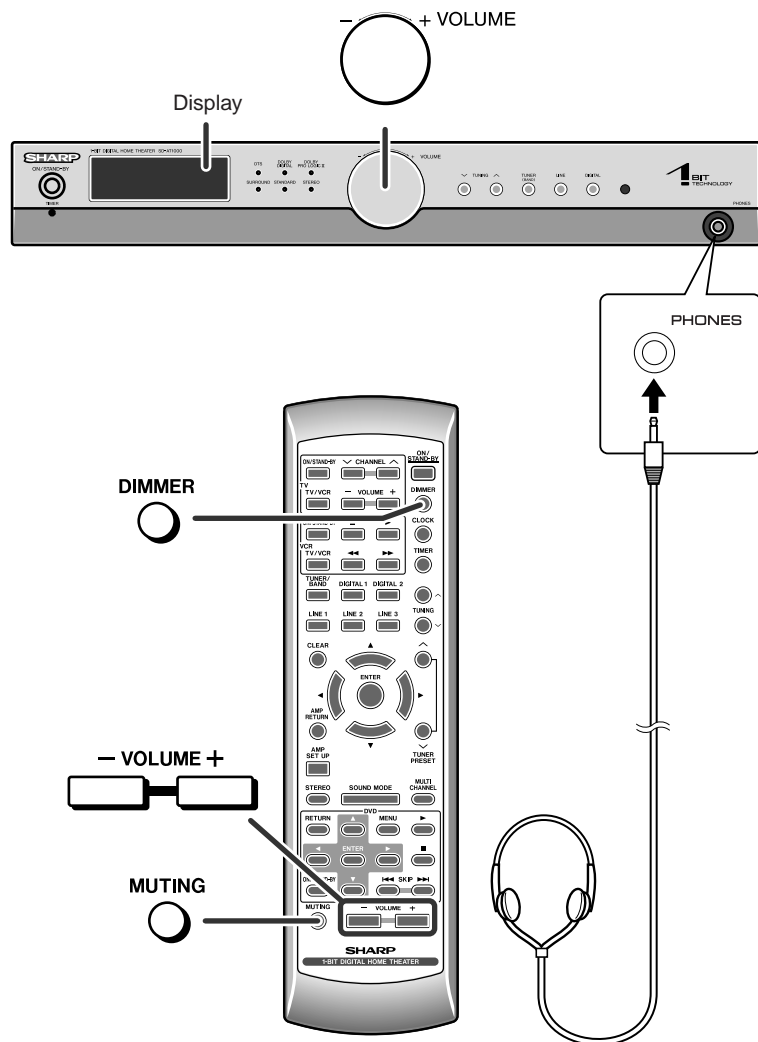

## ■ To change the display brightness (2 levels)

You can switch the display brightness by pressing the DIMMER button.



## ■ Volume control

### Main unit operation:

When the VOLUME control is turned clockwise, the volume will increase. When it is turned anti-clockwise, the volume will decrease.

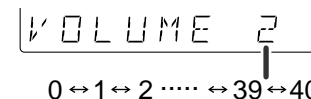

### Remote control operation:

Press the VOLUME + button to increase the volume and the VOLUME - button for decreasing.

## ■ Muting

The volume is muted temporarily when pressing the MUTING button on the remote control. Press again to restore the volume.

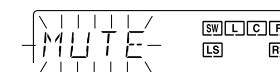

## ■ Headphones

- Before plugging in or unplugging the headphones, reduce the volume.
- Be sure your headphones have a 6.3 mm (1/4") diameter plug and are between 16 ohms and 50 ohms impedance. The recommended impedance is 32 ohms.
- Plugging in the headphones disconnects the speakers automatically. Adjust the volume using the VOLUME control.
- **You cannot use the surround feature with headphones.**
- Do not plug in or unplug headphones whilst recording. The sound may skip.

# Setting the clock

SD-AT1000W

By setting the unit to the correct time, you can use it not only as a clock but also for timer playback.

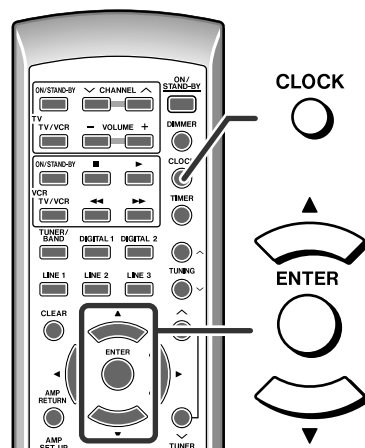

You can set the clock even when the unit is in the stand-by mode. In this example, the clock is set for the 24-hour (0:00) display.

- 1 Press the CLOCK button and within 5 seconds, press the ENTER button.**



- 2 Press the ▲ or ▼ button to select the 24-hour or 12-hour display and then press the ENTER button.**

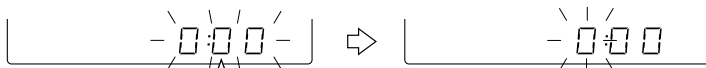

"0:00" → The 24-hour display will appear. (0:00 - 23:59)  
 "12:00 AM" → The 12-hour display will appear. (AM 12:00 - PM 11:59)  
 "AM 0:00" → The 12-hour display will appear. (AM 0:00 - PM 11:59)

Note that this can only be set when the unit is first installed or it has been reset (see page 31).

- 3 Press the ▲ or ▼ button to adjust the hour and then press the ENTER button.**

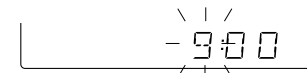

- Press the ▲ or ▼ button once to advance the time by 1 hour. Hold it down to advance continuously.
- When the 12-hour display is selected, "AM" will change automatically to "PM".

- 4 Press the ▲ or ▼ button to adjust the minutes and then press the ENTER button.**



- Press the ▲ or ▼ button once to advance the time by 1 minute. Hold it down to advance continuously.
- The hour will not advance even if minutes advance from "59" to "00".
- The clock starts from "0" second (seconds are not displayed).
- The time disappears after approx. 5 seconds.

### To confirm the time display:

Press the CLOCK button.  
The time display will appear for about 5 seconds.

### Note:

The "ADJUST" or time will flash at the push of the CLOCK button when the AC power supply is restored after a power failure or unplugging the unit. Readjust the clock as follows.

### To readjust the clock:

Perform "Setting the clock" from step 1. If the "ADJUST" is not flashing in step 1, step 2 (for selecting the 24-hour or 12-hour display) will be skipped.

### To change the 24-hour or 12-hour display:

- 1 Clear all the programmed contents. [Refer to "Clearing all the memory (reset)" on page 31 for details.]
- 2 Perform "Setting the clock" from the beginning.

ENGLISH

1

Preparation for Use  
- Setting the clock -

E-18

# Listening to the radio

ENGLISH

Basic Operation  
- Listening to the radio -

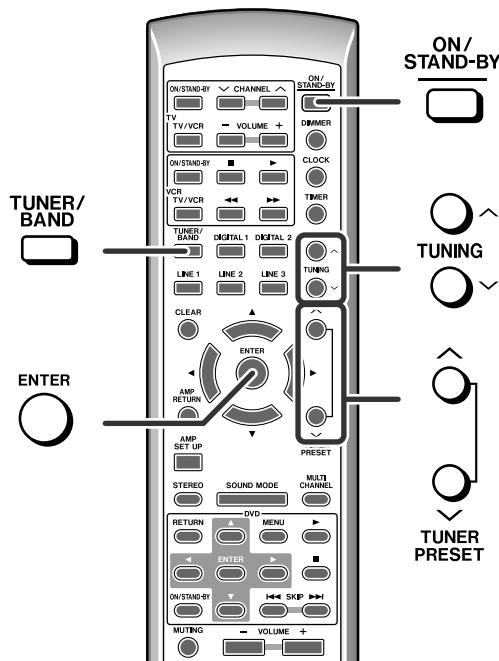
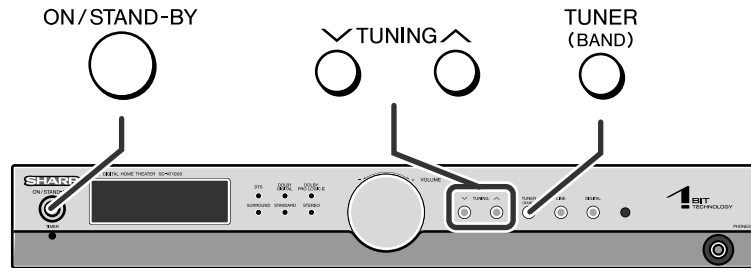

## Manual or Auto tuning

- 1 Press the ON/STAND-BY button to turn the power on.
- 2 Press the TUNER (BAND) button repeatedly to select the desired frequency band.



- 3 Press the TUNING (∨ or ∧) button to tune in to the desired station.

### Manual tuning:

Press the TUNING button as many times as required to tune in to the desired station.

### Auto tuning:

When the TUNING button is pressed for 0.5 seconds or more, scanning will start automatically and the tuner will stop at the first receivable broadcast station.

- When radio interference occurs, auto scan tuning may stop automatically at that point.
- Auto scan tuning will skip weak signal stations.
- To stop the auto tuning, press the TUNING button again.

### To receive an FM stereo transmission:

Press the TUNER (BAND) button to display the "STEREO" indicator.

- "∞" will appear when an FM broadcast is in stereo.

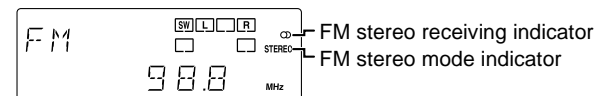

- If the FM reception is weak, press the TUNER (BAND) button to extinguish the "STEREO" indicator. The reception changes to monaural, and the sound becomes clearer.

### After use:

Press the ON/STAND-BY button to enter the power stand-by mode.

## ■ Memorising a station

You can store 40 AM and FM stations in memory and recall them at the push of a button. (Preset tuning)

**1** Perform steps 1 - 3 in "Manual or Auto tuning" on page 19.

**2** Press the ENTER button to enter the preset tuning saving mode.

**3** Within 5 seconds, press the TUNER PRESET (∨ or ∧) button to select the preset channel number.



Store the stations in memory, in order, starting with preset channel 1.

**4** Within 5 seconds, press the ENTER button to store that station in memory.

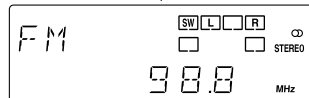
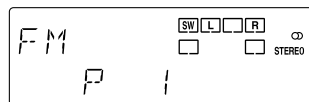

**5** Repeat steps 1 - 4 to set other stations, or to change a preset station.

When a new station is stored in memory, the station previously memorised will be erased.

### Note:

The backup function protects the memorised stations for a few hours should there be a power failure or the AC power lead disconnection.

## ■ To recall a memorised station

**1** Press the TUNER (BAND) button.

**2** Press the TUNER PRESET (∨ or ∧) button to select the desired station.

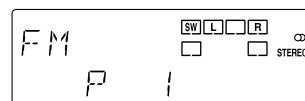

Preset channel

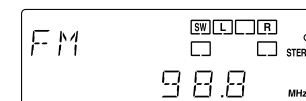

Frequency and frequency band

## ■ To erase all the contents of the preset memory

- 1 Press the ON/STAND-BY button to turn the power on, and press the TUNER/BAND button.
- 2 Hold the CLEAR button down for 3 seconds or more.
- 3 Whilst "CLEAR" is flashing, press the ENTER button.

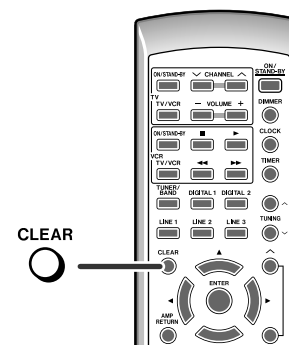
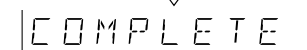
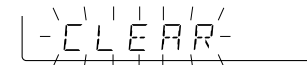

# Listening to the playback sound from DVD players, VCRs, etc.

ENGLISH

**Basic Operation**  
- Listening to the playback sound from DVD players, VCRs, etc. -

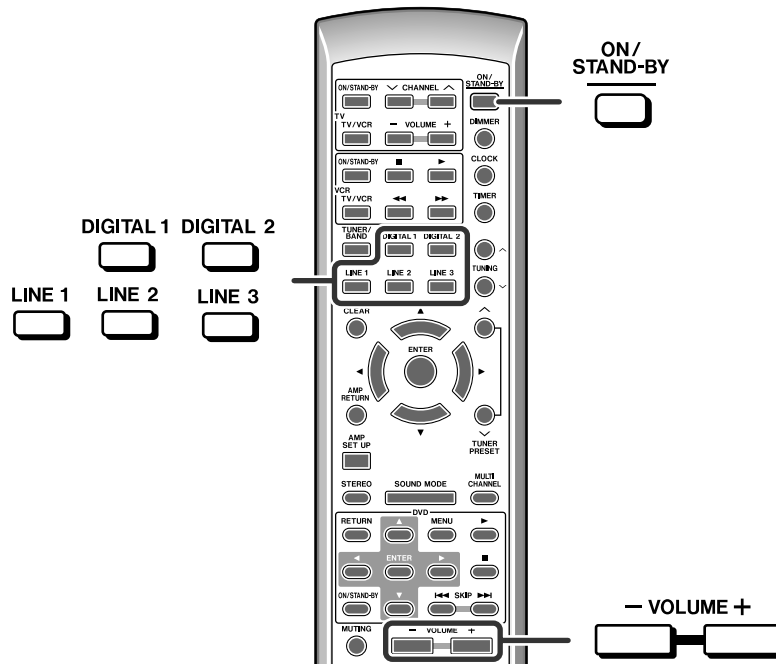
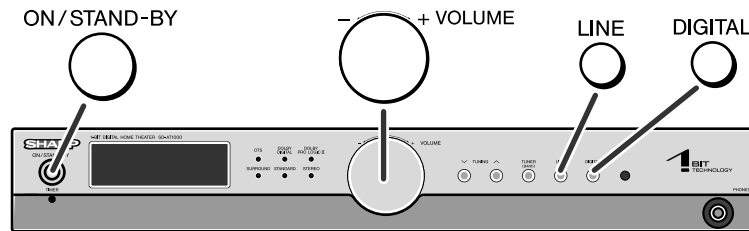

- 1 Turn on the connected equipment.
- 2 Press the ON/STAND-BY button to turn the power on.
- 3 Select the source by pressing the DIGITAL or LINE button repeatedly.

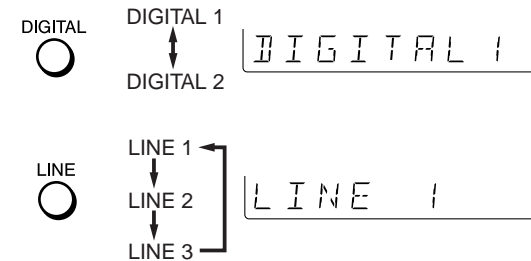

You can select the source directly on the remote control.

- 4 Press the play button of the connected equipment.
- 5 Adjust the volume level with the VOLUME control (see page 17).



### Caution:

The unit gets warm when used for a long time. This is not a malfunction.

### Note:

A safety feature automatically sets the unit to the power stand-by mode if you set the volume level too high. If this happens, lower the volume level.

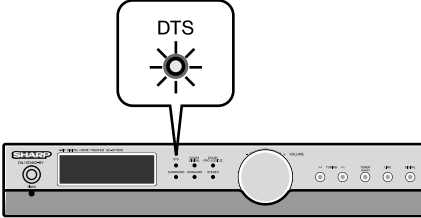
# Enjoying various sounds

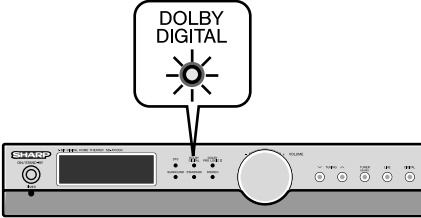
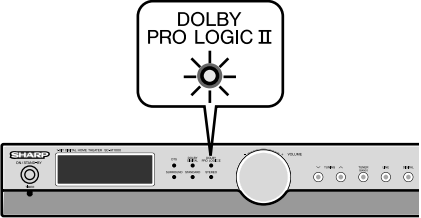
DTS (Digital Theater Systems)	Dolby Digital	Dolby Pro Logic II
 <p><b>Digital input from discs with this trademark</b> One of the digital audio systems for theatrical use. As the sound quality is emphasised, you can enjoy the realistic sound effect in the home theatre system. The DTS indicator will light up when the disc recorded in DTS is played back.</p> 	 <p><b>Digital input from discs with this trademark</b> One of the digital audio systems for theatrical use. You can enjoy the stereophonic effect in the home theatre system. The DOLBY DIGITAL indicator will light up when the disc recorded in DOLBY DIGITAL is played back.</p> 	<p><b>Inputs from stereo-recorded discs, video tapes, etc.</b></p> <p>When playing stereo discs/videos or 2-channel stereo sounds recorded in Dolby Digital, the Dolby Pro Logic II function reproduces the sound in 5.1-channel digital surround sound, ensuring more natural sound effects. When the Dolby Pro Logic II function is activated, the indicator will light up.</p> 

**Audio signal indicators / Speaker indicators:**

The audio signal indicator or speaker indicator lights up according to the input audio source.

- ① Front Left Signal Indicator
- ② Centre Signal Indicator
- ③ Front Right Signal Indicator
- ④ LFE (Low Frequency Effect) Signal Indicator
- ⑤ Surround Left Signal Indicator
- ⑥ Surround Monaural Signal Indicator
- ⑦ Surround Right Signal Indicator

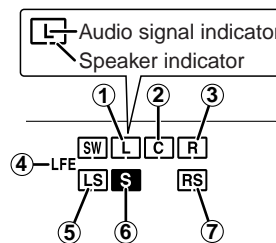

**Caution:**

- When connecting the DVD player to the LINE 1/2/3 IN sockets, the surround sound recorded in Dolby Digital or DTS is not available. (Refer to the operation manual for details on audio output.)
- To record sound with VCR, etc., set the sound mode to "STEREO". If set to "STANDARD" or "SURROUND", the sound will not be recorded.

Refer to the next page for operations

Basic Operation  
- Enjoying various sounds -

## Enjoying various sounds (continued)

ENGLISH

Basic Operation  
- Enjoying various sounds -

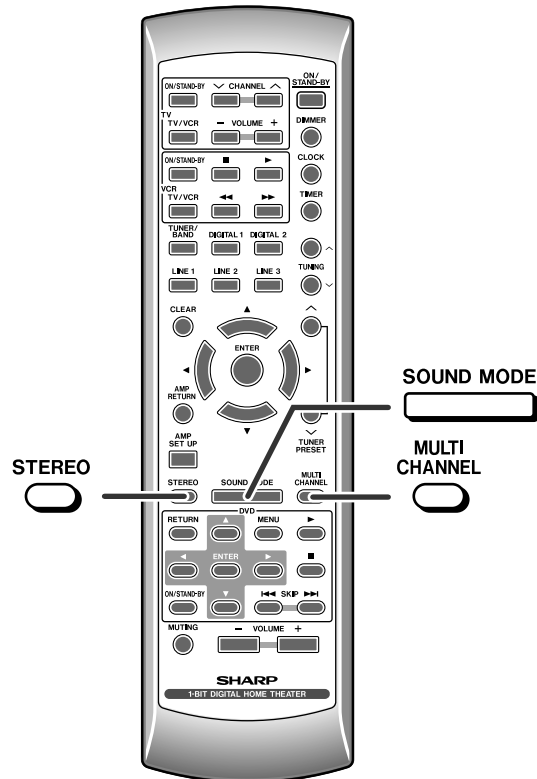

### ■ Listening to sounds with multi-channel (5.1 ch, etc.)

When connecting the DVD player to the DIGITAL IN 1/2 sockets, you can enjoy Dolby Digital or DTS sounds with spacious effects. You can also enjoy spacious effects when listening to 2-channel stereo sounds using Dolby Pro Logic II.

**Whilst the disc is playing, press the MULTI CHANNEL button.**

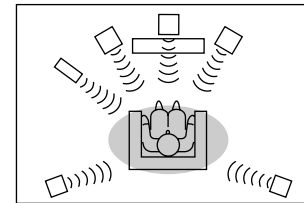

A maximum of 5.1ch surround sound is reproduced to provide three-dimensional effect.

**Dolby Pro Logic II expands 2-channel stereo sound of CDs, etc. to 5.1 ch.**

Surround types can be changed in this mode.



**Press the SOUND MODE button.**

Each press of the button changes the mode.

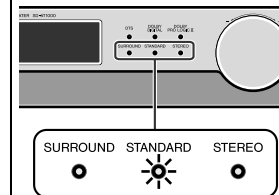

MOVIE

The bass level is increased for powerful sound effect.

STANDARD

You can enjoy the original sound as it is.

MUSIC

You can enjoy lively sound by producing the clear sound.

NIGHT

Soft but powerful sound is achieved even at low volumes.

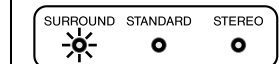

SURROUND

This mode provides an expansive listening area by emitting 2-channel sound.

You cannot select "SURROUND" if the audio source contains DTS or Dolby Digital signals.



## ■ Listening to 2-channel stereo sounds

Whilst the disc is playing, press the **STEREO** button.

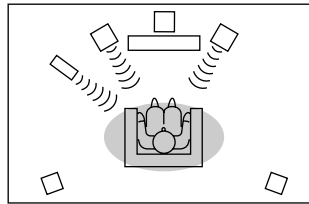

You can enjoy the great acoustic effects of the front speakers and subwoofer.

Bass frequencies can be switched in this mode.



Press the **SOUND MODE** button to turn the "**BASS ON**" or "**BASS OFF**".

Each press of the button changes the mode.

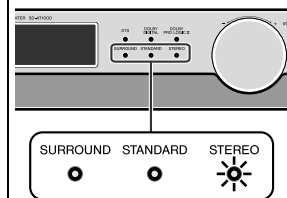

BASS ON

Bass frequencies are emphasised.

BASS OFF

Bass emphasis is cancelled.

### Notes:

- If "STEREO" or "SURROUND" is selected, the "PRO LOGIC II" indicator goes out.
- Some discs are recorded at 96 kHz of sampling frequency. When this type of disc is played, the sound mode is changed to "STEREO" automatically. The sound mode cannot be changed during playback.
- The monaural sound is heard only from the centre speaker in the "STANDARD" or "SURROUND" mode. If played in the "STEREO" mode, the same sound is reproduced from the right and left speakers.
- When switching to AM radio, "STANDARD" or "SURROUND" mode automatically change to "STEREO" and the "STEREO" indicator is lit. However, AM broadcasts cannot be received in stereo.



# Adjusting speaker delay/speaker level

When speakers cannot be placed at equal distances, change speaker settings to enjoy surround effects as if they were equally placed.

## Example:

If the right surround speaker is 3 m away from the listening position, change settings as shown below (adjust the SR).

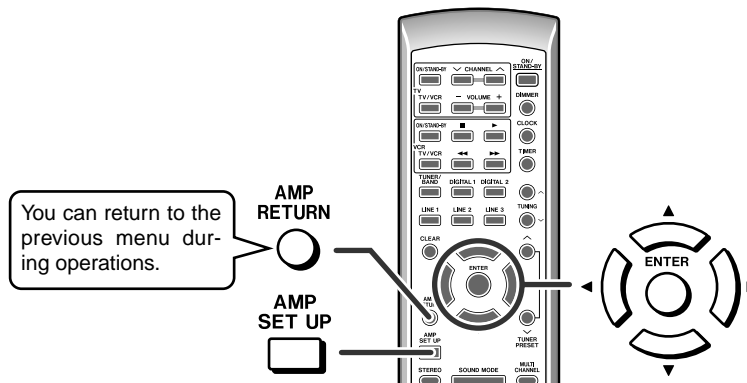
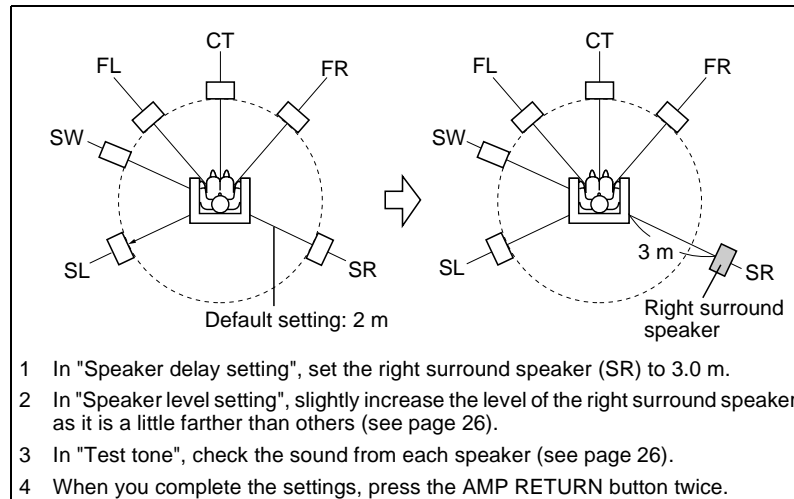

## Step 1. Speaker delay setting

By adjusting speaker delay, differences in speaker distance can be corrected. This offers you the sound quality as if the speakers are installed at the same distance from the listening position.

- 1 Press the AMP SET UP button, and the ◀ or ▶ button to select "SP DELAY". Then press the ENTER button.
- 2 Within 30 seconds, press the ◀ or ▶ button to select the desired speaker.
- 3 Within 30 seconds, press the ▲ or ▼ button to select the distance and press the ENTER button.
 

FL 3.0 M

  - You can change the distance in 0.1 m steps.
  - To set the distance of other speakers, repeat the operation from step 2.

Speaker type		Delay range	Default setting
FL	Front speaker (Left)	0.1 m to 9.0 m	2.0 m
CT	Centre speaker	0.1 m to 9.0 m	2.0 m
FR	Front speaker (Right)	0.1 m to 9.0 m	2.0 m
SR	Surround speaker (Right)	0.1 m to 9.0 m	2.0 m
SL	Surround speaker (Left)	0.1 m to 9.0 m	2.0 m
SW	Subwoofer	0.1 m to 9.0 m	2.0 m

### Note:

You can also adjust the speaker delay of a subwoofer connected to the SUB-WOOFER PRE OUT socket.

## Step 2. Speaker level setting

If sounds from the speakers are uneven, you can equalise them by adjusting the speaker levels.

**1** Press the AMP SET UP button, and the ◀ or ▶ button to select "SP LEVEL". Then press the ENTER button.

**2** Within 10 seconds, press the ◀ or ▶ button to select the desired speaker.

**3** Within 10 seconds, press the ▲ or ▼ button to adjust the level.

FL + 5<sup>dB</sup>

- You can adjust the level at 1 dB intervals.
- To adjust the levels of other speakers, repeat the operation from step 2.

Speaker type		Level range	Default setting
FL	Front speaker (Left)	- 6 dB to + 6 dB	0 dB
CT	Centre speaker	- 6 dB to + 6 dB	0 dB
FR	Front speaker (Right)	- 6 dB to + 6 dB	0 dB
SR	Surround speaker (Right)	- 6 dB to + 6 dB	0 dB
SL	Surround speaker (Left)	- 6 dB to + 6 dB	0 dB
SW	Subwoofer	- 10 dB to + 10 dB	+ 6 dB

### Notes:

- If subwoofer sound is distorted, lower the subwoofer level.
- You can also adjust the speaker level of a subwoofer connected to the SUB-WOOFER PRE OUT socket.

## Step 3. Test tone

After adjustments, check the speaker sound by listening to the test tone. (You can readjust the volume level.)

**1** Press the AMP SET UP button, and the ◀ or ▶ button to select "TONE". Then press the ENTER button.

Speakers emit the test tone for 2 seconds in turn, starting with the front speaker (left).

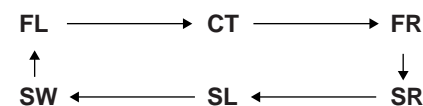

**2** Readjust the speaker levels if not equal.

Whilst the test tone sounds, press the ▲ or ▼ button to adjust the level.

You can select a speaker by pressing the ◀ or ▶ button.



## Step 4. To end the speaker setting

When you complete the settings, press the AMP RETURN button twice.

# Timer and sleep operation

ENGLISH

Advanced Features  
- Timer and sleep operation -

You can use the unit as an alarm clock by setting the timer.

## Before setting timer:

- 1 Set the unit to the correct time (page 18).  
If it is not set, you cannot use the timer function.
- 2 Prepare the sound source for playback.
- 3 Store radio stations (page 20).

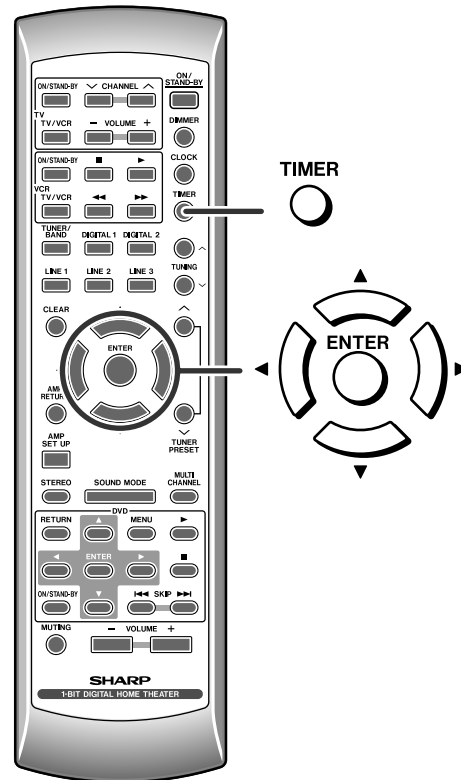

## ■ Setting the timer

- 1 Turn the power on and press the TIMER button.**

Set the unit to the correct time if "TIMER STANDBY" does not appear.

TIMER  
STANDBY

- 2 Within 10 seconds, press the ◀ or ▶ button to select "TIMER SET", and press the ENTER button.**

TIMER  
SET

- 3 Press the ▲ or ▼ button to adjust the hour and then press the ENTER button.**

000

- 4 Press the ▲ or ▼ button to adjust the minutes and then press the ENTER button.**

ON 7:30 → OFF 8:30

The start time is set and the finish time (1 hour later) will be displayed automatically.

- 5 Set the time to finish as in steps 3 and 4 above.**

- 6 Switch input with the ▲ or ▼ button, and then press the ENTER button.**

- When you select the tuner, select a station by pressing the ▲ or ▼ button, and then press the ENTER button.
- If a station has not been programmed, "NO P-SET" will be displayed.

DIGITAL1 ↔ DIGITAL2  
↓ ↓  
TUNER LINE1  
↓ ↓  
LINE3 ↔ LINE2

- 7 Adjust the volume with the ▲ or ▼ button and press the ENTER button.**

Settings are displayed in order and the unit will enter the timer stand-by mode.

### Caution:

This unit cannot set the timer of other equipment. To perform the timer playback using other equipment, you should also set the timer on the equipment separately.

After completing the setting

#### When the timer setting is completed:

The unit is in the timer playback stand-by mode.



#### To check the timer setting:

1 Whilst in the timer playback stand-by mode, press the TIMER button.

TIMER  
CANCEL

2 Within 10 seconds, press the ◀ or ▶ button to select "TIMER CALL", and press the ENTER button.  
The unit returns to the timer playback stand-by mode after the setting contents are displayed in order.

#### When the start time is reached:

Playback starts automatically and the volume increases gradually.  
The unit is operated by the timer.

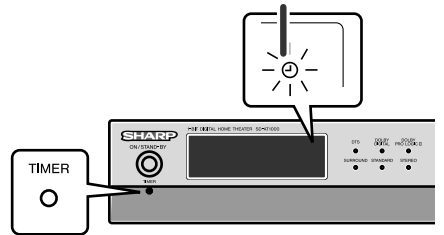

#### Cancelling the timer playback:

Timer playback is cancelled by turning the power on whilst in the timer playback stand-by mode. The same operation can be performed in the following procedure without turning the power on.

- 1 Press the TIMER button.  
"TIMER CANCEL" will appear.
- 2 Within 10 seconds, press the ENTER button.  
Timer playback will be cancelled (the contents of the setting will not be cancelled).

#### When the finish time is reached:

The unit is set to the power stand-by mode automatically.

The timer setting is canceled.

#### Reusing the timer:

##### Using the same setting;

The timer setting will be memorised once it is entered. To reuse the same setting, perform the following operations.

- 1 Turn the power on and press the TIMER button.  
"TIMER STANDBY" will appear. If it does not appear, set the unit to the correct time.
- 2 Within 10 seconds, press the ENTER button.  
After the setting contents are displayed in order, the unit is set to the timer playback stand-by mode.

##### Changing the setting;

Turn the power on, and repeat the operation from step 1 in "Setting the timer" (page 27).

#### Caution:

The contents of the setting will be erased if the unit is unplugged or a power failure occurs. In such cases, set the timer again.



## Timer and sleep operation (continued)

ENGLISH

Advanced Features  
- Timer and sleep operation -

### ■ Setting the sleep timer

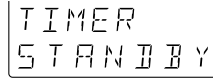
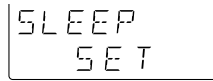
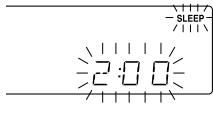
You can set the unit to the power stand-by mode at the specified time.

<b>1 During playback, press the TIMER button.</b>	
<b>2 Within 10 seconds, press the ◀ or ▶ button to select "SLEEP SET", and press the ENTER button.</b>	
<b>3 Press the ▲ or ▼ button to select the time.</b> <b>(Maximum: 2 hours - Minimum: 1 minute)</b> <ul style="list-style-type: none"> <li>● 2 hours - 5 minutes → 5-minute intervals</li> <li>● 5 minutes - 1 minute → 1-minute intervals</li> </ul>	
<b>4 Press the ENTER button.</b> "SLEEP" will appear.	
<b>5 The unit will enter the power stand-by mode automatically after the preset time has elapsed.</b> The volume will be turned down 1 minute before the sleep operation finishes, and then you cannot change the volume.	

#### Caution:

This unit cannot set the sleep timer of other equipment.

To use the sleep timer using other equipment, you should also set the timer on the equipment separately.

#### To confirm the remaining sleep time:

- 1 Whilst "SLEEP" is indicated, press the TIMER button.
- 2 Within 10 seconds, press the ◀ or ▶ button to select "SLEEP".

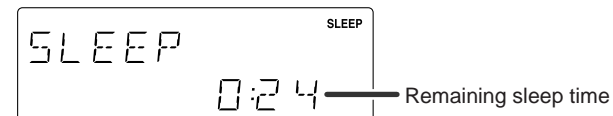

- The remaining sleep time is displayed for about 10 seconds.
- You can change the remaining sleep time whilst it is displayed by pressing the ENTER button (steps 3 - 4).

#### To cancel the sleep operation:

Press the ON/STAND-BY button whilst "SLEEP" is indicated.

To cancel the sleep operation without setting the system to the stand-by mode, proceed as follows.

- 1 Press the TIMER button.
- 2 Within 10 seconds, press the ◀ or ▶ button to select "SLEEP OFF", and press the ENTER button.

### ■ To use timer and sleep operation together

You can fall asleep and wake up to the radio.

<b>1 Set the sleep timer (steps 1 - 4).</b> Sleep operation starts.
<b>2 Set the timer playback.</b> ("Setting the timer" on page 27, steps 1 - 7)

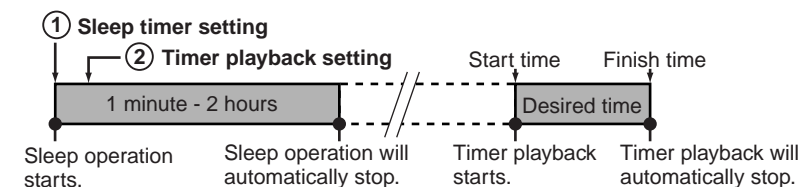

# Troubleshooting chart

SD-AT1000W

ENGLISH

1

Many potential problems can be resolved by the owner without calling a service technician.

If something is wrong with this product, check the following before calling your authorised SHARP dealer or service centre.

## ■ General

Symptom	Possible cause	Reference page
No sound is heard.	<ul style="list-style-type: none"> <li>Is the volume level set to "0"?</li> <li>Are the headphones connected?</li> <li>Are the speaker wires disconnected?</li> </ul>	<p>P. 17</p> <p>P. 17</p> <p>P. 9</p>
The sounds from speakers are not well balanced.	<ul style="list-style-type: none"> <li>Are the speaker leads connected to the wrong channels?</li> <li>Is each speaker placed at the same distance from the listener?</li> <li>Are speakers adjusted to the same level?</li> </ul>	<p>P. 9</p> <p>P. 15</p> <p>P. 26</p>
Noise is heard during playback.	<ul style="list-style-type: none"> <li>Move the unit away from any computers or mobile phones.</li> </ul>	—
When a button is pressed, the unit does not respond.	<ul style="list-style-type: none"> <li>Set this unit to the power stand-by mode and then turn it back on. If the unit still malfunctions, reset it.</li> </ul>	P. 31
Timer playback does not start.	<ul style="list-style-type: none"> <li>Did you remove the plug from the wall socket, or did a power failure occur? Reset the clock and timer.</li> </ul>	P. 18
The display on the unit is dark.	<ul style="list-style-type: none"> <li>Is the display in the dimmer mode?</li> </ul>	P. 17
The power is not turned on.	<ul style="list-style-type: none"> <li>Is the unit unplugged?</li> <li>The protection circuit may be activated. Unplug and plug in the power lead again after 5 minutes or more.</li> </ul>	<p>P. 13</p> <p>P. 31</p>

## ■ Tuner

Symptom	Possible cause	Reference page
The radio makes unusual noises continuously.	<ul style="list-style-type: none"> <li>Is the unit placed near the TV or computer?</li> <li>Is the FM aerial or AM loop aerial placed properly? Move the aerial away from the AC power lead or the unit if located near.</li> </ul>	<p>P. 10</p> <p>P. 10</p>
The preset channel cannot be recalled.	<ul style="list-style-type: none"> <li>Did you remove the plug from the wall socket, or did a power failure occur? Set the channel again.</li> </ul>	P. 20

## ■ Remote control

Symptom	Possible cause	Reference page
The remote control does not operate properly.	<ul style="list-style-type: none"> <li>Is the battery polarity respected?</li> <li>Are the batteries dead?</li> <li>Is the distance or angle incorrect?</li> <li>Are there any obstructions in front of the unit?</li> <li>Is the remote control sensor exposed to strong light (inverter fluorescent light, direct sunlight, etc.)?</li> <li>Is the remote control for other equipment being used simultaneously?</li> </ul>	<p>P. 16</p> <p>—</p> <p>P. 16</p> <p>—</p> <p>P. 16</p> <p>—</p>
The unit cannot be turned on with the remote control.	<ul style="list-style-type: none"> <li>Is the AC power lead of the unit plugged in?</li> <li>Are the batteries inserted?</li> </ul>	<p>P. 13</p> <p>P. 16</p>

References  
- Troubleshooting chart -

E-30

## Troubleshooting chart (continued)

### ■ If trouble occurs

When this product is subjected to strong external interference (mechanical shock, excessive static electricity, abnormal supply voltage due to lightning, etc.) or if it is operated incorrectly, it may malfunction.

#### If such a problem occurs, do the following:

- 1 Set the unit to the stand-by mode and turn the power on again.
- 2 If the unit is not restored in the previous operation, unplug and plug in the unit, and then turn the power on.

#### Note:

If neither operation above restores the unit, clear all the memory by resetting it.

#### Clearing all the memory (reset)

- 1 Unplug the unit.
- 2 Whilst holding down the ON/STAND-BY button, plug in the AC power lead. At this time, the unit will not be turned on.
- 3 Press the ON/STAND-BY button again to turn the power on.

#### Caution:

This operation will erase all data stored in memory and restore various settings to the initial status (default).

#### When the protection circuit is activated:

Occasionally at very high volume levels, the protection circuit may be activated to set the unit to the stand-by mode.

Unplug the unit and, after 5 minutes or more, plug it in again.

Turn down the volume if set too high.

## Maintenance

### ■ Cleaning the cabinet

Periodically wipe the cabinet with a soft cloth and a diluted soap solution, then with a dry cloth.

- Do not use chemicals for cleaning (petrol, paint thinner, etc.). It may damage the cabinet finish.
- Do not apply oil to the inside of the equipment as this may cause malfunctions.

## Error indicators and warnings

When you fail to perform operations properly, the following messages are displayed on the unit.

Display	Meaning
	<ul style="list-style-type: none"> <li>● Place the unit away from noise source or plug the AC power lead to another wall socket. (*)</li> </ul>
	<ul style="list-style-type: none"> <li>● The cooling fan on the back of the main unit does not run due to foreign objects caught in it. Set this unit to the stand-by mode and remove the foreign objects around the fan.</li> </ul>
	<ul style="list-style-type: none"> <li>● The digital audio input socket is not connected properly.</li> <li>● Turn off the unit and check if the cable is properly connected.</li> <li>● Unspecified signal is received and cannot be recognised.</li> </ul>

(\*): Should the same message appear even if the unit is unplugged and plugged in or is set to the stand-by mode and on again, contact your local dealer where you purchased the unit.

## Optional accessory

Use only the specified optional accessory to operate this product properly. For speaker installation, read instructions supplied with stands.

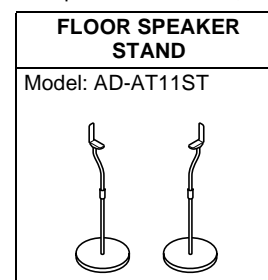

The appearance of optional accessory may differ from the illustration above.



# Specifications

SD-AT1000W

ENGLISH

1

As part of our policy of continuous improvement, SHARP reserves the right to make design and specification changes for product improvement without prior notice. The performance specification figures indicated are nominal values of production units. There may be some deviations from these values in individual units.

## ● Main unit

<b>Power source</b>	AC 220 - 240 V, 50/60 Hz
<b>Power consumption</b>	70 W
<b>Amplification system</b>	2.8224 MHz (64fs) 1-bit switching (remarks: fs = 44.1 kHz)
<b>Output power</b>	Front speakers: RMS: 200 W (100 W + 100 W) (10 % T.H.D., 1 kHz) Centre speaker: RMS: 100 W (10 % T.H.D., 1 kHz) Surround speakers: RMS: 200 W (100 W + 100 W) (10 % T.H.D., 1 kHz) Subwoofer: RMS: 100 W (10 % T.H.D., 100 Hz)
<b>A/D noise shaping</b>	7th-order $\Delta \Sigma$ (delta - sigma) modulation
<b>Frequency range</b>	FM: 88 - 108 MHz AM: 530 - 1,620 kHz
<b>Audio input terminals</b>	Coaxial digital input (DIGITAL 1): RCA type $\times$ 1 Optical digital input (DIGITAL 2): Square type $\times$ 1 Analogue input (LINE 1): RCA type $\times$ 1 pair (L/R) Analogue input (LINE 2): RCA type $\times$ 1 pair (L/R) Analogue input (LINE 3): RCA type $\times$ 1 pair (L/R)
<b>Audio output terminals</b>	Front speakers, Centre speaker, Surround speakers and Subwoofer: 4 ohms Headphones: 16 - 50 ohms (recommended: 32 ohms) Subwoofer Pre Out: 10 k ohms Analogue output (LINE 1): RCA type $\times$ 1 pair (L/R)
<b>Dimensions</b>	Width: 430 mm (16-7/8") Height: 67 mm (2-9/16") Depth: 324 mm (12-3/4")
<b>Weight</b>	4.0 kg (8.8 lbs.)

## ● Front speaker

<b>Type</b>	Full range speaker system (magnetic shield) 8 cm (3-1/8") speaker $\times$ 2
<b>Impedance</b>	4 ohms
<b>Dimensions</b>	Width: 105 mm (4-1/8") Height: 251 mm (9-7/8") Depth: 125 mm (4-7/8")
<b>Weight</b>	1.5 kg (3.3 lbs.)/each

## ● Centre speaker

<b>Type</b>	Full range speaker system (magnetic shield) 8 cm (3-1/8") speaker $\times$ 2
<b>Impedance</b>	4 ohms
<b>Dimensions</b>	Width: 251 mm (9-7/8") Height: 105 mm (4-1/8") Depth: 125 mm (4-7/8")
<b>Weight</b>	1.5 kg (3.3 lbs.)

## ● Surround speaker

<b>Type</b>	Full range speaker system 8 cm (3-1/8") speaker
<b>Impedance</b>	4 ohms
<b>Dimensions</b>	Width: 105 mm (4-1/8") Height: 251 mm (9-7/8") Depth: 125 mm (4-7/8")
<b>Weight</b>	0.9 kg (2.0 lbs.)/each

## ● Subwoofer

<b>Type</b>	16 cm (6-1/4") woofer (magnetic shield)
<b>Impedance</b>	4 ohms
<b>Dimensions</b>	Width: 240 mm (9-1/2") Height: 408 mm (16-1/16") Depth: 306 mm (12")
<b>Weight</b>	6.3 kg (13.9 lbs.)

References - Specifications -

E-32

**MEMO/MEMORÁNDUM**

**MEMO/MEMORÁNDUM**

**SHARP**  
SHARP CORPORATION

TINSZA121AWZZ  
04G R HK ①

## Free Manuals Download Website

<http://myh66.com>

<http://usermanuals.us>

<http://www.somanuals.com>

<http://www.4manuals.cc>

<http://www.manual-lib.com>

<http://www.404manual.com>

<http://www.luxmanual.com>

<http://aubethermostatmanual.com>

Golf course search by state

<http://golfingnear.com>

Email search by domain

<http://emailbydomain.com>

Auto manuals search

<http://auto.somanuals.com>

TV manuals search

<http://tv.somanuals.com>