

SHARP

PORTABLE MINIDISC PLAYER

MODEL

MD-S301

OPERATION MANUAL

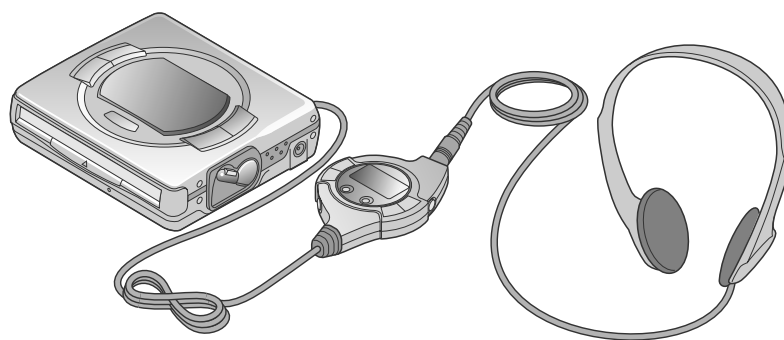

MD-MS200-HYOSHI



INTRODUCTION

Thank you for purchasing this SHARP product.
To obtain the best performance from this product please read this manual carefully.
It will guide you in operating your SHARP product.

CONTENTS

	Page		Page
ACCESSORIES.....	1	CONVENIENT OPERATION	
SPECIAL NOTES.....	2	OF THE UNIT.....	13-15
PRECAUTIONS.....	3-4	USING EXTERNAL UNITS.....	16
NAMES OF CONTROLS AND		WHAT IS A MINIDISC?.....	17
INDICATORS.....	5	TROUBLESHOOTING.....	17-18
POWER SOURCE.....	6-7	ERROR MESSAGES.....	19
PLAYING A MINIDISC.....	8-9	MAINTENANCE.....	20
CONVENIENT PLAYBACK		SPECIFICATIONS.....	20-21
FUNCTIONS.....	10-12	LIMITED WARRANTY.....	Back cover

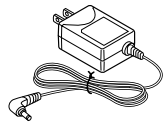
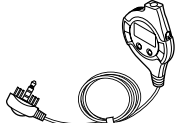
ACCESSORIES

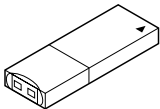
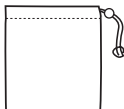
 AC Adaptor x 1 [RADPA3406AFZZ]	 Remote Control Unit x 1 [RRMCW0024AFZZ]	 Stereo Headphones x 1 [RPH6H0168AFZZ]
 Rechargeable lithium-ion Battery (AD-S30BT) [UBATi0060AFSA]	 Carrying Bag x 1 [UBAGC0076AFSA]	

Note:
Parts and equipment mentioned in this operation manual other than those shown above are not included.

US and foreign patents licensed from Dolby laboratories licencing Corporation.

SPECIAL NOTES

Caution - use of controls or adjustments or performance of procedures other than those specified herein may result in hazardous radiation exposure.

- Contains Lithium-Ion Battery. Must be Disposed of properly. Contact Local Environmental Officials for disposal instructions.

FOR YOUR RECORDS

For your assistance in reporting this unit in case of loss or theft, please record below the model number and serial number which are located on the bottom of the unit.

Please retain this information.

Model number _____

Serial number _____

Date of purchase _____

Place of purchase _____

Note:

This equipment has been tested and found to comply with the limits for a Class B digital device, pursuant to Part 15 of the FCC Rules.

These limits are designed to provide reasonable protection against harmful interference in a residential installation.

This equipment generates, uses, and can radiate radio frequency energy and, if not installed and used in accordance with the instructions, may cause harmful interference to radio communications.

However, there is no guarantee that interference will not occur in a particular installation. If this equipment does cause harmful interference to radio or television reception, which can be determined by turning the equipment off and on, the user is encouraged to try to correct the interference by one or more of the following measures:

- Reorient or relocate the receiving antenna.
- Increase the separation between the equipment and receiver.
- Connect the equipment into an outlet on a circuit different from that to which the receiver is connected.
- Consult the dealer or an experienced radio/TV technician for help.

WARNING

FCC Regulations state that any unauthorized changes or modifications to this equipment not expressly approved by the manufacturer could void the user's authority to operate this equipment.

PRECAUTIONS

■ Important

- Do not wear your headphones when you are crossing streets or near traffic.
- Do not use your headphones while driving a motor vehicle, it may create a dangerous traffic hazard and may be illegal. Remember to obey all of the safety rules in your area.
- Do not play the unit at a high volume. Hearing experts advise against extended play at high volume levels.
- If you experience ringing in your ears, reduce the volume or discontinue use.

■ Volume setting

Reduce the volume before starting to play. MiniDiscs, compared to ordinary cassette tapes, have very little noise. If the volume is adjusted according to your usual expectations of noise, you may damage your hearing due to the high volume.

■ Concern for others when listening to MiniDiscs

While listening to music, the sound escaping from your headphones may disturb people around you.

If you are using the unit in particularly crowded places (such as on trains or buses), reduce the volume to avoid annoying people around you.

■ Storing the unit

Avoid using or leaving the unit in the following places.

- Places exposed to direct sunlight for many hours (especially in cars with the doors and windows closed) or near heaters.
(The cabinet may deform, change color or the unit may malfunction).
- Places exposed to water.
- Places exposed to excessive dust.
- Places where temperatures are excessively high or low.
- Places (bathrooms) where the humidity is extremely high.
- Places with strong magnetic fields such as TVs or loudspeakers.
- Places exposed to vibration.
- Places where sand can easily enter the inside of the unit (beaches etc.).
- If the unit is used near radio tuners or TVs, noise and/or picture interference may result. If you experience these problems, move the unit away from such devices.

■ Precautions

To avoid accidental electric shock or other possible problems, observe the precautions listed below.

- Do not disassemble or modify the unit.
- Do not drop or subject the unit to shock.
- Do not use the unit near open flames.
- Do not spill liquid on the unit.
- Do not use an external power supply, other than the 5V DC supplied with this unit, as it may damage it.
- SHARP is not responsible for damage due to improper use. Refer all servicing to a SHARP authorized service center.

■ Notes about the rechargeable battery

- A rechargeable lithium-ion battery is the only kind that can be used. Even if the battery supplied with the unit is not used, you should charge it at least once every three months because of the special quality of this battery.
- The rechargeable battery can be charged approximately 300 times.
- Do not use any battery other than that specified. Use of other batteries may cause malfunctions.
- When the operating time is reduced to about half the normal amount of time, even after a full charge is performed, replace the battery with a new one.
- When charging or when using the rechargeable battery, use it within an ambient temperature range of 41°F - 95°F (5°C - 35°C).
- If the rechargeable battery is used in a cold environment, the operating time will decrease.

Since the rechargeable battery is vulnerable to damage, please note the following.

- Do not carry the battery in your pocket or in a bag together with metal objects (keys, coins, jewelry, etc.). The battery may short out and generate significant amounts of heat.
- Do not short-circuit the terminals as they will become very hot and will damage the battery.
- Do not dip the battery in water, do not dispose of it in a fire, and do not take it apart.

To avoid damaging the battery and shortening its service life, please note the following.

- Do not drop or subject the battery to shock.
- Do not insert objects (metal etc.) into the battery compartment of this product or into the rechargeable battery. Do not get the terminals dirty. If the rechargeable terminals are dirty, the operating time may be shortened or it may not be possible to charge the battery.

NAMES OF CONTROLS AND INDICATORS

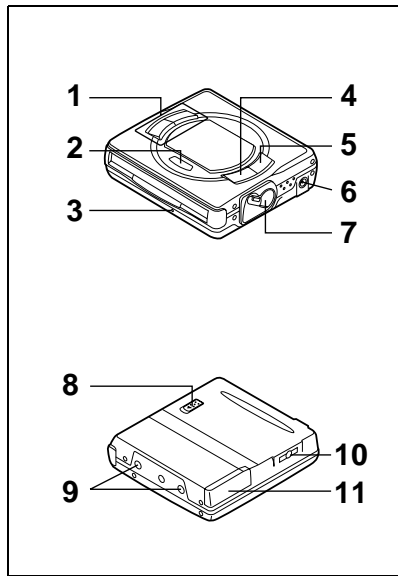

■ Main unit

1. Volume Buttons: +, -
 2. Stop/Power Off/Charge Button: ■:OFF
 3. Power Indicator
 4. Fast Reverse Button: |◀◀
 5. Play/Fast Forward Button: ▶▶|
 6. 5V DC Input Jack
 7. Eject Lever
-
8. Hold Switch
 9. Battery Case Connection Terminals
 10. Headphones Jack
 11. Rechargeable Lithium-Ion Battery Compartment

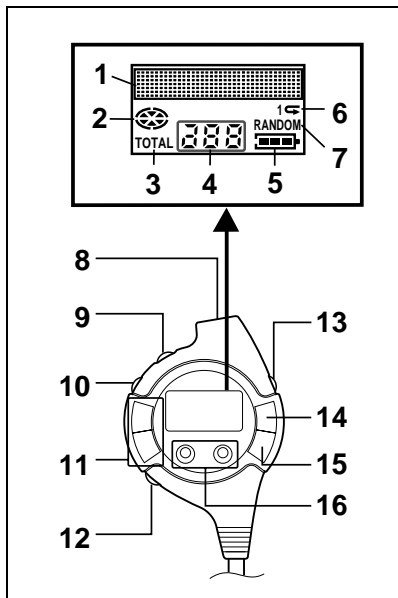

■ Remote control unit

1. Character/Time Information Display
2. Disc Mode Indicator
3. Total Track Number Display
4. Track Number Indicator
5. Battery Indicator:
6. Repeat Indicator:
7. Random Indicator:
8. Headphones Jack
9. Hold Switch
10. Play Mode Button
11. Volume Buttons: +, -
12. Bass Button
13. Display Button
14. Play/Pause Button: ▶||
15. Stop/Power Off Button: ■
16. Fast Reverse/Fast Forward Buttons: |◀◀/▶▶|

POWER SOURCE

This unit can be used with 4 different power sources: a rechargeable battery, an AC adaptor, an optionally available battery case (AD-S30BC), and an optionally available car adaptor (AD-CA20X).

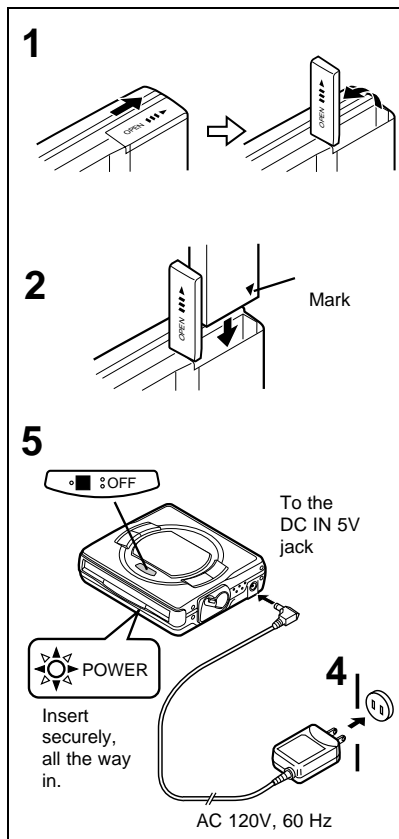

■ Rechargeable battery power

When the rechargeable battery is used for the first time or when you want to use it after a long period of disuse, be sure to charge it fully.

- 1** Open the rechargeable battery compartment cover.
- 2** Insert the rechargeable battery.
 - Insert the side with the arrow first.
- 3** Close the rechargeable battery compartment cover.
- 4** Plug the AC adaptor into the AC outlet, and then insert the plug on the AC adaptor cord into the DC IN 5V jack.
- 5** Press the ■:OFF button to begin charging.
 - The POWER indicator will flash, and the battery will begin charging.
 - Battery charging will be complete in 3 hours. When the battery is fully charged, the POWER indicator will go out.

Notes:

- After charging is complete, the AC adaptor may be left connected. (For example, when charging at night)
- The battery will not be charged whenever the power to the main unit is turned on.
- If the operation in step 5 is performed without inserting the rechargeable battery, the POWER indicator will flash for 5 seconds. This is normal.
- Do not force open the rechargeable battery cover too far.
- Do not attach the optionally available battery case when charging the internal battery.

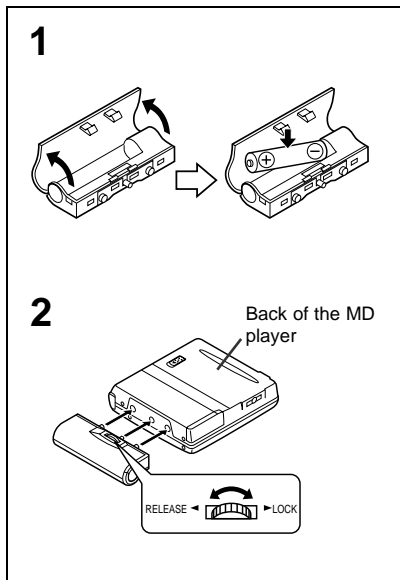

■ Alkaline battery power

Use of the optionally available alkaline battery case combined with the rechargeable battery will result in extended playback times.

- Use one, commercially available alkaline battery (LR6, "AA" size).

- 1** Insert the battery into the battery case.
 - (1) Open the case cover.
 - (2) Insert the battery according to the polarity marked on the inside of the battery case. Then, close the case cover.

- 2** Attach the battery case to the main unit.
 - (1) Match the convex part of the battery case to the concave area in the main unit.
 - (2) Turn the screw in the direction marked "LOCK" to secure the battery case.

Cautions:

- While you are using the rechargeable battery and the alkaline battery at the same time, do not remove either of them. If you do, playback will stop, and the power may be disconnected.
- Do not replace the battery or the rechargeable battery during operation.
- Do not use rechargeable batteries (nickel-cadmium battery etc.) in the battery case.
- If the unit is not used for a long period of time, remove the battery. (Even if the power is turned off, the battery will drain slowly but continuously.)
- Be sure to hold the plug when removing it. If you pull on the cord, it may break, or the unit may malfunction.
- Do not use any car adaptor except for the optionally available AD-CA20X.
- For information about the battery life, see the battery item in the SPECIFICATIONS on page 20.
- This unit should only be used within the range of 32°F - 104°F (0°C - 40°C).

■ AC power

- 1** Connect the cord from the AC adaptor to the DC IN 5V jack on the main unit.
- 2** Plug the AC adaptor into an AC outlet.

Notes:

- If there is an electrical storm in your vicinity, unplug the AC adaptor from the AC outlet.
- When the unit is not in use for extended periods, remove the AC adaptor from the AC outlet.
- Never use an AC adaptor other than the one specified. Otherwise, malfunctions or serious safety hazards may result.
- Do not bend, twist or tie the power cord or put heavy objects on top of it.

PLAYING A MINIDISC

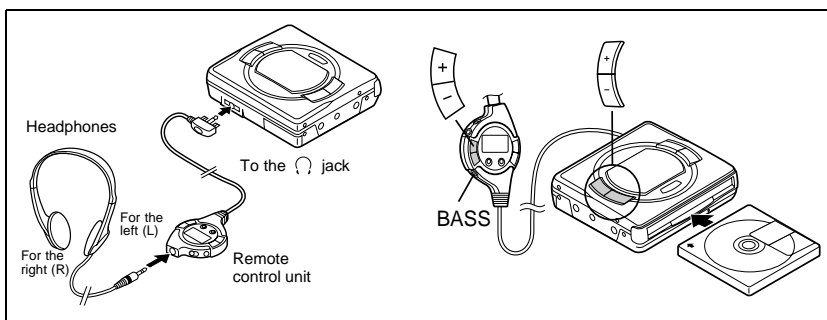

1 Insert the headphones plug firmly into the headphones jack on the remote control unit.

2 Plug the remote control unit into the jack on the main unit. Push the plug all the way in.

- Since the remote control unit plug has only one correct orientation, plug it in as shown in the drawing.

3 Load a MiniDisc in the direction indicated by the arrow on the MiniDisc, with the label side facing up. (Insert the MiniDisc firmly, until a click is heard.)

- The power will be turned on automatically, and playback will start from the first track. (Auto-play function)

When track names are included on the MiniDisc, the track names will be scrolled.

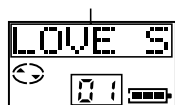

Track number

- After playback of the last track has finished, the unit will stop automatically.

4 Press the VOLUME + button to increase the volume and the VOLUME - button to decrease the volume.

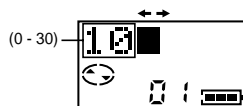

5 Adjust the bass level. Each time the BASS button is pressed, the tone will be switched as follows:

BASS 1 ... Bass is emphasized a little.
 ↓
 BASS 2 ... Bass is emphasized more.
 ↓
 BASS 3 ... Bass is emphasized still more.
 ↓
 BASS 0 ... Bass emphasis is canceled.



- The most recent volume or bass settings are saved when the power is turned off.

Note:

- Whenever any button is pressed, the remote control display will light for about 4 seconds.

To interrupt playback:

Press the ►|| button on the remote control unit during playback.

- To resume playback, press the ►|| button again.

To stop playback:

Press the ■:OFF (■) button.

- When you press the ►/▶▶ (▶||) button to resume playback, it will start at the point on the disc where playback was halted (Resume function). However, if the MiniDisc is removed and reinserted, playback will start from the first track.

To turn off the power:

Press the ■:OFF (■) button while in the stop mode.

- If the unit is not operated for at least 2 minutes while in the stop mode, the power will be turned off automatically.

To remove the MiniDisc:

Turn off the power and move the EJECT lever in the direction indicated by the arrow.

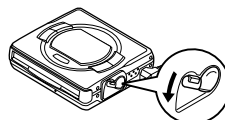
**When using the unit with just the battery in the battery case:**

- The auto-play function will not work.
- To start playback, hold down the ►/▶▶ (▶||) button for about 1 second.
- Even if a MiniDisc is replaced while the power is turned off, the random or repeat play settings will remain unchanged in memory.

Precautions when making connections:

- Do not use any remote control unit, except for the one included with this unit.
- Insert each plug securely, all the way in.
- Be sure to hold the plug when removing it. If you pull on the cord, it may break, or the unit may malfunction.

Interrupted sound:

- This product is designed to eliminate interruptions in the sound which can be caused by vibrations. However, if the unit is continuously exposed to vibrations or mechanical shock, the sound may be interrupted momentarily.

Note while in the playback mode:

If you do any of the following during playback, the volume and the tone settings may not be stored correctly.

- Plug or unplug the AC adaptor.
- Remove the rechargeable battery or the alkaline battery.
- Plug or unplug the car adaptor or turn off the car's ignition key.

When the sound is distorted:

- If the volume is too high while the bass is being emphasized, the sound may be distorted, depending on the music on the track. If this happens, decrease the bass level or lower the volume level.
- If the volume is increased to "23" or higher, the bass level will be adjusted automatically. (This is done to reduce the distortion in the sound.)

Cautions:

- When the unit is not to be used immediately after a MiniDisc has been inserted, or when you plan to carry the unit, turn off the power or cancel the auto-play function. Otherwise, the auto-play function will be activated and the battery will run down.
- When a MiniDisc is inserted, if any resistance is felt, do not force the MiniDisc into the unit. It may cause more problems. If resistance is felt, remove the MiniDisc and try reloading it.
- Since the main unit and the AC adaptor can heat up during use, you should avoid allowing the unit to be in direct contact with your skin for any length of time.

When using the unit with a car adaptor:

- When switching off the ignition during playback, the power to this unit will also be turned off. When the ignition is switched on, playback will start from the beginning of the track where playback was halted (Resume auto-play function). However, the power to the unit may not be turned off when the ignition is turned off, depending on the type of car.

CONVENIENT PLAYBACK FUNCTIONS

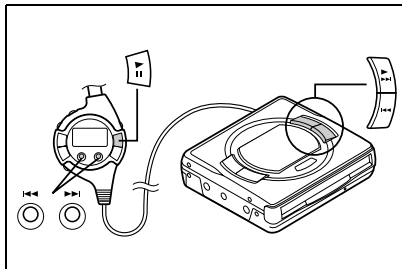

■ APSS (Auto Program Search System)

APSS automatically locates the beginning of any track.

To move to the beginning of the next track:

Press the ►/►► (►►►) button during playback.

To re-start the track being played:

Press the ◀◀ button during playback.

To skip a number of tracks at one time, press the ◀◀ or ►/►► (►►►) button repeatedly until the desired track number is shown.

To begin playback at a desired track, press the ◀◀ or ►► button while in the stop mode to select the track number. Then press the ►/►► (►►►) button.

Note:

- When the first track is selected and the ◀◀ button is pressed, the last track on the disc will be located. When the last track is selected and the ►/►► (►►►) button is pressed, the first track will be located.

■ Cue and review

- 1 Load a MiniDisc and begin playback.
- 2 Press and hold down the ►/►► (►►►) button for audible fast forward, or press and hold down the ◀◀ button for audible fast reverse.
- 3 Normal playback will resume when the ◀◀ or ►/►► (►►►) button is released.

Notes:

- When the end of the last track is reached during fast forward, the unit will enter the pause mode. When the beginning of the first track is reached during fast reverse, the unit will enter the playback mode.
- When the unit is in the all track repeat mode, the search will wrap around from the last track to the first, or vice versa.
- Depending on the contents recorded on a MiniDisc, some sounds may be skipped while cueing and reviewing.

To search very quickly:

When fast forward or fast reverse is used while in the pause mode, the search will be performed more quickly than during audible fast forward or fast reverse playback.

- In this mode, no sound is heard. Therefore, you should refer to the time display.
- When you lift your finger, the unit will re-enter the pause mode.

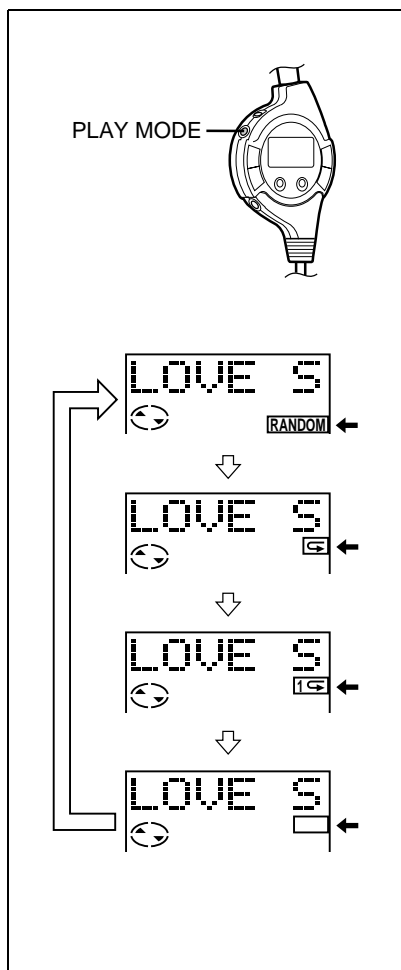

■ Random play or repeat play

(Remote control)

During playback or while in the stop mode, press the PLAY MODE button repeatedly to select the playback mode.

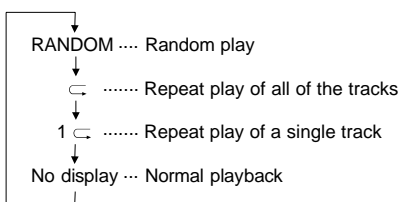

- If the playback mode is selected while stopped, press the ►|| button to start playback.

Notes:

- In random play the unit will select and play tracks automatically. (You cannot select the order of the tracks.) After all of the tracks have been played once each in random order, the unit will stop automatically.
- During random play or repeat play of a single track, cue and review of the previous or next tracks are not possible.
- During random play, the unit cannot find the beginning of any track which has been played.

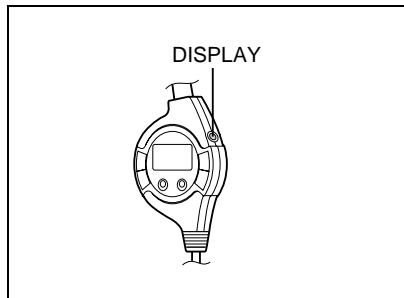

■ **To check the total playing time**

(Remote control)

While in the stop mode, press the DISPLAY button.

- Each time the button is pressed, the display will change as follows:

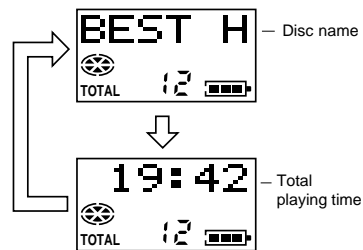

Note:

If character information was not originally recorded on the MiniDisc, nothing will be displayed.

■ **To check the elapsed time and remaining time of the track**

(Remote control)

During playback, press the DISPLAY button.

- Each time the button is pressed, the display will change as follows:

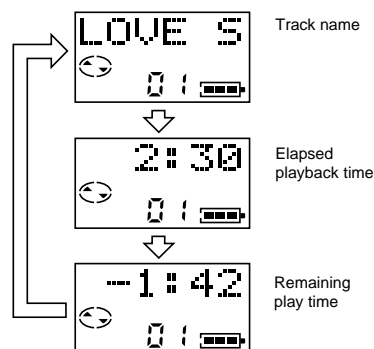

To check individual track names one by one:

Press the ◀◀ or ▶▶ button while in the stop mode.

Each time the button is pressed, the name of the previous or next track will be displayed.

Note:

- The display of elapsed time during playback may be different from the actual time on a clock.

CONVENIENT OPERATION OF THE UNIT

■ Checking the remaining amount of battery charge

The remaining amount of battery charge is shown by the battery indicator () on the remote control display during operation.

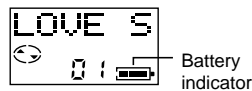

How to read the battery indicator

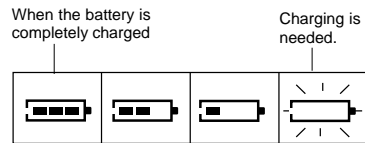

- When the battery is completely discharged, the whole battery indicator will flash. Recharge the battery or replace the alkaline battery with a new one.
- When the battery has completely run out, "Lo BATT" will appear in the display. Then, the power will be disconnected automatically.

Notes:

- When the AC adaptor included with this unit or an optionally available car adaptor is used, the battery indicator will not be shown.
- The number of bars shown in the battery indicator may increase or decrease, depending on the operation being performed. This is normal.
- When the rechargeable battery and the alkaline battery are used at the same time, the rechargeable battery is used first, and then the alkaline battery. Since the battery indicator shows the remaining amount of the particular battery being used, the number of bars will increase when the unit switches to the alkaline battery.

■ To prevent the unit from being operated by mistake

To avoid operations being started by accidentally pressing the buttons, use the hold function.

Move the HOLD switch to the safety position (direction indicated by the arrow).

- When the unit is in the safety mode, pressing the buttons will have no effect.

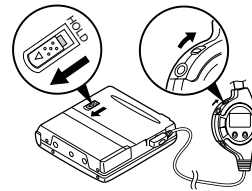

- To cancel the safety mode, move the HOLD switch away from the safety position (the opposite direction of the arrow).

	Remote control unit	Main unit
Can be operated from either the remote control unit or the main unit.	Cancel	Cancel
Can only be operated from the remote control unit.	Cancel	Hold
Can only be operated from the main unit.	Hold	Cancel
Cannot be operated from either the remote control unit or the main unit.	Hold	Hold

If the hold function is active while the power is turned off, the power cannot be turned on by mistake and the battery will not be accidentally drained. (The auto-play function will be activated.)

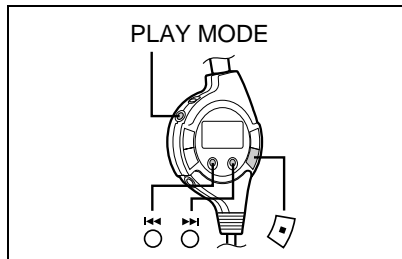

■ To eliminate the confirmation sound

(Remote control)

Every time a button is pressed, a “beep” will be heard in the headphones. To silence the “beep” sound, do the following:

- 1 While in the stop mode ...**
Hold down the PLAY MODE button until “SET UP” appears.
 - When you release the button, “BEEP 1” will appear.
- 2** Press the PLAY MODE button.
 - “BEEP 0” will appear, and the confirmation sound will disappear.
 - To restore the confirmation sound, select “BEEP 1”.
- 3** Press the ■ button.
 - The normal display will reappear.

■ To turn off the display backlight

(Remote control)

Whenever you press a button, the display will light for about 4 seconds, so that you can read it in the dark. You can turn off the backlight.

- 1 While in the stop mode ...**
Hold down the PLAY MODE button until “SET UP” appears.
 - When you release the button, “BEEP 1” or “BEEP 0” will appear.
- 2** Press the ◀◀ or ▶▶ button until “EL on” appears.
- 3** Press the PLAY MODE button.
 - “EL off” will appear, and the backlight will go out.
 - To turn the backlight back on, select “EL on”.
- 4** Press the ■ button.
 - The normal display will reappear.

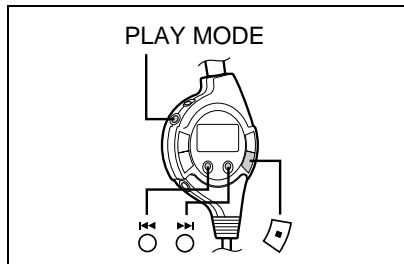

■ To cancel the auto-play function

(Remote control)

When a MiniDisc is inserted, the power will be turned on automatically, and playback will begin. You can cancel automatic playback.

- 1** While in the stop mode ...
Hold down the PLAY MODE button until "SET UP" appears.
 - When you release the button, "BEEP 1" or "BEEP 0" will appear.
- 2** Press the ◀◀ or ▶▶ button until "auto PL" appears.
- 3** Press the PLAY MODE button.
 - "PL off" will appear, and the auto-play function will be canceled.
 - To restore the auto-play function, select "auto PL".
- 4** Press the ■ button.
 - The normal display will reappear.

■ To cancel the auto power save function

(Remote control)

Power consumption can be reduced by controlling the memory storage time. You can cancel the auto power save function.

- 1** While in the stop mode ...
Hold down the PLAY MODE button until "SET UP" appears.
 - When you release the button, "BEEP 1" or "BEEP 0" will appear.
- 2** Press the ◀◀ or ▶▶ button until the "auto PS" appears.
- 3** Press the PLAY MODE button.
 - "PS off" will appear, and the auto power save function will be canceled.
 - To restore the auto power save function, select "auto PS".
- 4** Press the ■ button.
 - The normal display will reappear.

About the sound skip guard memory:

During playback, approximately 10 seconds of information is stored in the semiconductor memory. Therefore, even when the pickup cannot read information for a second or two due to an external shock, the sound will continue without interruption because the information stored in memory is used.

About the auto power save function:

This is a function used to save power when using the unit with the rechargeable battery or the alkaline battery. While in the auto power save mode, 5 - 10 seconds of sound information is stored in memory. When the unit is used in places exposed to excessive vibration, cancel the auto power save function. When the auto power save function is disabled, 10 seconds of sound information is always stored in memory. (When the AC adaptor or a car adaptor is used, the information storage time is always 10 seconds, regardless of the auto power save mode.)

USING EXTERNAL UNITS

- Before connecting any other equipment, turn off the power to all units.
- Connect the plugs securely.
Improper connections may cause noise or malfunctions.
- Adjust the volume on both this unit and any other equipment connected to it.

■ Recording both sound and character information on another MiniDisc at the same time

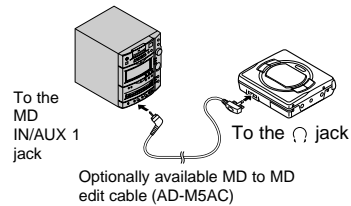

- To make an MD ► MD edit recording, check the operation manual for the equipment connected to this unit.
- The recording will be made in the analog mode.

■ Listening through a car stereo

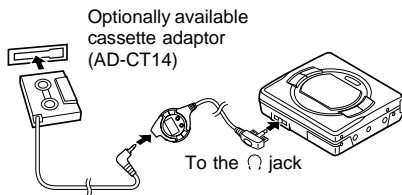

- The optionally available cassette adaptor may not work, depending on your car's stereo.

■ Listening through a stereo or a radio cassette player or recording on a cassette tape

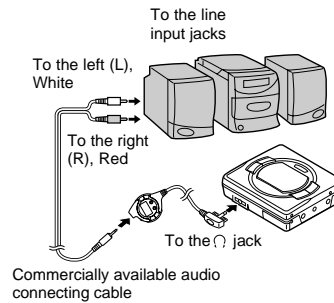

- The recording will be made in the analog mode.

■ Listening through commercially available headphones

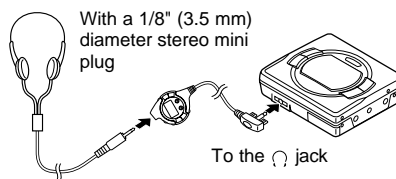

- The battery life may be different, depending on the impedance of the headphones used.
- Headphones can be connected directly to the main unit.

WHAT IS A MINIDISC?

A MiniDisc is a disc inside a protective cartridge. You can handle it freely without worrying about dust, fingerprints, etc. However, if dust enters the opening of the cartridge, or there is excessive dirt on the cartridge, or the cartridge becomes warped, you may experience malfunctions. Please note the following.

■ Handling the MiniDisc

Do not touch the disc directly!

Do not open the shutter or touch the disc directly.

If the shutter is opened forcibly, it may break.

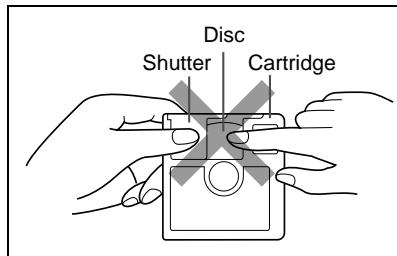

- Never disassemble a MiniDisc.

■ Where not to store discs

Do not store discs in places with high temperatures or humidity. Specifically, do not leave discs in places exposed to direct sunlight or in cars with the doors and windows closed.

Do not leave discs in places where sand or dust can get into the cartridge easily (e.g., beaches).

■ Helpful tip when attaching a label

When attaching a label to an MD cartridge, be sure to note the following. If the label is not attached properly, the MiniDisc may jam inside the unit and it may not be possible to remove it.

- If the label peels off or partially lifts away, replace it with a new one.
- Do not put a new label on top of an existing one.
- Attach the label only in the specified location. (If it is not within the specified area, it may cause the disc to jam in the unit.)

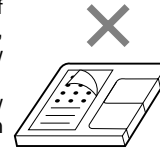

■ Regular cleaning

If the surface of the cartridge becomes dusty or dirty, clean it with a dry cloth.

TROUBLESHOOTING

■ Moisture condensation

In the following cases, condensation may form inside the unit.

- Shortly after turning on a heater.
- When the unit is placed in a room where there is excessive steam or moisture.
- When the unit is moved from a cool place to a warm place.

When the unit has condensation inside, the disc signals cannot be read, and the unit may not function properly.

- If this happens, remove the disc. The condensation should evaporate in approximately 1 hour. The unit will then function properly.

Many potential "problems" can be resolved by the owner without calling a service technician. If something seems to be wrong with this product, check the following before calling your authorized SHARP dealer or service center.

PROBLEM	CAUSE
The unit does not turn on.	<ul style="list-style-type: none"> ● Is the AC adaptor disconnected? ● Is the battery exhausted? ● Is the unit in the safety mode? ● Has condensation formed inside the unit? ● Is the unit being influenced by mechanical shock or by static electricity?
No sound is heard from the headphones.	<ul style="list-style-type: none"> ● Is the volume set too low? ● Is the remote control unit or the headphones plugged in? ● Are you trying to play a MiniDisc with data on it instead of a MiniDisc containing music?
When the operation buttons are pressed, the unit does not respond.	<ul style="list-style-type: none"> ● Is the unit in the safety mode? ● Is the battery exhausted? ● Is the remote control unit plug or the headphone plug inserted firmly? ● Has condensation formed inside the unit? ● Is the unit being influenced by mechanical shock or by static electricity?
Some sounds are skipped.	<ul style="list-style-type: none"> ● Is the battery exhausted? ● Is the unit being subjected to excessive vibration?

■ If trouble occurs

When this product is subjected to strong external interference (mechanical shock, excessive static electricity, abnormal supply voltage due to lightning, etc.) or if it is operated incorrectly, it may malfunction. If such a problem occurs, do the following:

1. Unplug the AC adaptor from the AC outlet.
2. Remove the battery.

3. Leave the unit completely unpowered for approximately 30 seconds.
4. Plug the AC adaptor back into the AC outlet and retry the operation.

If strange sounds, smell or smoke come out of the unit or an object is dropped into the unit, remove the AC adaptor from the AC outlet immediately and contact an authorized Sharp service center.

ERROR MESSAGES

When an error message is displayed on the display, proceed as follows:

Display	Meaning	Remedy
BLANK	<ul style="list-style-type: none"> ● Nothing is recorded. 	<ul style="list-style-type: none"> ● Replace the disc with a recorded disc.
E-DISC	<ul style="list-style-type: none"> ● The disc is damaged or the music information is not written properly on the disc. 	<ul style="list-style-type: none"> ● Replace the disc.
E-SYS	<ul style="list-style-type: none"> ● The unit is malfunctioning and will require service. 	<ul style="list-style-type: none"> ● For service, contact your local Sharp authorized servicer.
E-TEMP	<ul style="list-style-type: none"> ● The temperature is too high. 	<ul style="list-style-type: none"> ● Turn off the power, and wait for a while.
E-TOC E-UTOC	<ul style="list-style-type: none"> ● The disc is damaged. 	<ul style="list-style-type: none"> ● Replace the disc.
Lo BATT	<ul style="list-style-type: none"> ● The battery has run down. 	<ul style="list-style-type: none"> ● Charge the rechargeable battery or replace the alkaline battery (or use the AC adaptor for power).
No DISC	<ul style="list-style-type: none"> ● A disc has not been loaded. 	<ul style="list-style-type: none"> ● Load a disc.
POWER?	<ul style="list-style-type: none"> ● Improper power is being supplied. 	<ul style="list-style-type: none"> ● Use one of the specified power sources.
?DISC	<ul style="list-style-type: none"> ● There is an error in the signal from the disc. 	<ul style="list-style-type: none"> ● Replace the disc.

MAINTENANCE

■ Cleaning

- **When the unit becomes dirty**
Clean it with a soft cloth.
When the unit is excessively dirty, use a soft cloth dampened in water.
(External surfaces only)
- **Clean the headphone plug.**
This will prevent noise.

- **Clean the battery case connection terminals.**
Wipe them with a dry cotton swab.
(Never use water or alcohol.)

Notes:

- Do not use chemicals for cleaning (gasoline, paint thinner, etc.)
It may affect the quality or color.
- Do not apply oil to the inside of the unit.
It may cause malfunctions.

SPECIFICATIONS

As a part of our policy of continuous improvement, SHARP reserves the right to make design and specification changes for product improvement without prior notice. The performance specification figures indicated are nominal values of production units. There may be some deviations from these values in individual units.

■ General

- Power source:** DC 3.6V (rechargeable lithium-ion battery x 1)
DC 5V (AC adaptor)
AC 120V, 60 Hz
DC 1.5V: Optionally available battery case, AD-S30BC
(commercially available, "AA" size, alkaline battery x 1)
DC 4.5V: Optionally available car adaptor, AD-CA20X
(for cars with a 12-24V DC negative ground electrical system)
- Power consumption:** 0.15 A (AC adaptor)
4W
- Output power:** RMS; 10 mW (5 mW + 5 mW)
(0.2% T.H.D.)
- Charging time:** Approx. 3 hours
(When using the AC adaptor included with the unit)
- Battery life:**

When using the rechargeable battery (fully charged) included with the unit	When using one, commercially available, high capacity, "AA" size, alkaline battery (in the optionally available battery case)	When using one, commercially available, high capacity, "AA" size, battery with the rechargeable battery (fully charged)
Approx. 6 hours	Approx. 3.5 hours	Approx. 9.5 hours

- Volume level: "VOL 15"
- The above values are the standard values when the unit is charged and used at an ambient temperature of 68°F (20°C).
- The playing time when using an alkaline battery may be different, depending on the type and manufacturer of the battery and on the operating temperature.

Output level:

	Specified out-put	Maximum output level	Load impedance
Headphones	–	5 mW + 5 mW	32 ohms
LINE	250 mV (–12 dB)	–	50 kohms

Dimensions:

Width: 3-7/16" (87 mm)
 Height: 31/32" (24 mm)
 Depth: 3-3/32" (78 mm)

Weight:

0.41 lbs. (184 g) with rechargeable battery

Output jack:

Headphones (impedance: 19 ohms)/remote control unit

■ MiniDisc Player

Type:

Portable MiniDisc player

Signal readout:

Non-contact, 3-beam semi-conductor laser pick-up

Audio channels:

2

Frequency response:

20 – 20,000 Hz (± 3 dB)

Rotation speed:

Approx. 400 – 900 rpm

Error correction:

ACIRC (Advanced Cross Interleave Reed-Solomon Code)

Coding:

ATRAC (Adaptive TRansform Acoustic Coding)

D/A converter:

1 bit

Sampling frequency:

44.1 kHz

Modulation system:

EFM (Eight to Fourteen Modulation)

Wow and flutter:

Unmeasurable (less than ±0.001% W. peak)

MEMO

LIMITED WARRANTY

SHARP ELECTRONICS CORPORATION warrants to the first consumer purchaser that this Sharp brand product (the "Product"), when shipped in its original container, will be free from defective workmanship and materials, and agrees that it will at its option, either repair the defect or replace the defective Product or part thereof with a new or remanufactured equivalent at no charge to the purchaser for parts or labor for the period(s) set forth below.

This warranty does not apply to any appearance items of the Product nor to the additional excluded item(s) set forth below nor to any Product the exterior of which has been damaged or defaced, which has been subjected to misuse, abnormal service or handling, or which has been altered or modified in design or construction.

In order to enforce the rights under this limited warranty, the purchaser should follow the steps set forth below and provide proof of purchase to the servicer.

The limited warranty described above is in addition to whatever implied warranties may be granted to purchasers by law. ALL IMPLIED WARRANTIES INCLUDING THE WARRANTIES OF MERCHANTABILITY AND FITNESS FOR USE ARE LIMITED TO THE PERIOD(S) FROM THE DATE OF PURCHASE SET FORTH BELOW. Some states do not allow limitations on how long an implied warranty lasts, so the above limitation may not apply to you. Neither the sales personnel of the seller nor any other person is authorized to make any warranties other than those described above, or extend the duration of any warranties beyond the time period described below on behalf of Sharp.

The warranties described above shall be the sole and exclusive warranties granted by Sharp and shall be the sole and exclusive remedy available to the purchaser. Correction of defects, in the manner and for the period of time described herein, shall constitute complete fulfillment of all liabilities and responsibilities of Sharp to the purchaser with respect to the Product, and shall constitute full satisfaction of all claims, whether based on contract, negligence, strict liability or otherwise. In no event shall Sharp be liable, or in any way responsible, for any damages or defects in the Product which were caused by repairs or attempted repairs performed by anyone other than an authorized servicer. Nor shall Sharp be liable or in any way responsible for any incidental or consequential economic or property damage. Some states do not allow the exclusion of incidental or consequential damages, so the above exclusion may not apply to you.

THIS WARRANTY GIVES YOU SPECIFIC LEGAL RIGHTS. YOU MAY ALSO HAVE OTHER RIGHTS WHICH VARY FROM STATE TO STATE.

Product Model Number: See your product for specific model number and have it available when requesting service for your Product.

Warranty Period for this Product: 90 Days parts and labor from date of purchase. The warranty period continuous for a total of one year for parts only; labor and service are not provided free of charge for this additional period.

Additional item(s) excluded from warranty coverage (if any): non-functional accessories, supplies and consumable items.

Where to obtain service: At a Sharp Authorized Servicer located in the United States. To find the location of the nearest Sharp Authorized Servicer call Sharp toll free at 1-800-BE-SHARP.

What to do to obtain service: Ship prepaid or carry in your Product to a Sharp Authorized Servicer. Be sure to have proof of purchase available; If you ship the Product be sure it is packaged carefully.

TO OBTAIN SUPPLY, ACCESSORY OR PRODUCT INFORMATION CALL 1-800-BE-SHARP.

SHARP

SHARP ELECTRONICS CORPORATION
Sharp Plaza, Mahwah, New Jersey 07430-2135
SHARP CORPORATION

TINSZ1357AFZZ

Printed in Japan
A9711.1.0MYM.HK

MD-MS200-HYOSHI

Free Manuals Download Website

<http://myh66.com>

<http://usermanuals.us>

<http://www.somanuals.com>

<http://www.4manuals.cc>

<http://www.manual-lib.com>

<http://www.404manual.com>

<http://www.luxmanual.com>

<http://aubethermostatmanual.com>

Golf course search by state

<http://golfingnear.com>

Email search by domain

<http://emailbydomain.com>

Auto manuals search

<http://auto.somanuals.com>

TV manuals search

<http://tv.somanuals.com>