

SHARP

MICRO COMPONENT SYSTEM

MODEL

XL-MP10H

OPERATION MANUAL

COMPACT
disc
DIGITAL AUDIO

SAVING ENERGY
STAND-BY POWER
CONSUMPTION **0.9w**

MP3

Thank you for purchasing this SHARP product.
To obtain the best performance from this product, please read this manual carefully. It will guide you in operating your SHARP product.

XL-MP10H Micro Component System consisting of XL-MP10H (main unit) and CP-S10H (speaker system).

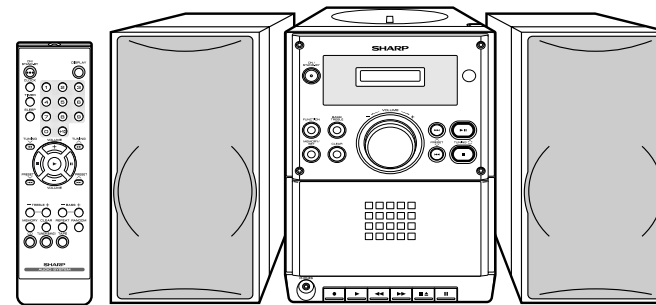

CD-R/RW
Playable

Accessories

Please confirm that the following accessories are included.

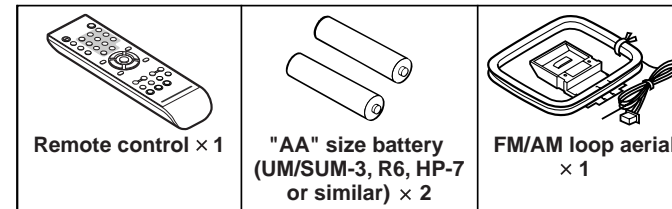

Note:
Only the above accessories are included.

Special notes

Warning:

- When the ON/STAND-BY button is set at STAND-BY position, mains voltage is still present inside the unit. When the ON/STAND-BY button is set at STAND-BY position, the unit may be brought into operation by the timer mode or remote control.
- This unit contains no user serviceable parts. Never remove covers unless qualified to do so. This unit contains dangerous voltages, always remove mains plug from the socket before any service operation and when not in use for a long period.
- To prevent fire or shock hazard, do not expose this appliance to dripping or splashing. No objects filled with liquids, such as vases, should be placed on the apparatus.

CAUTION

- This product is classified as a CLASS 1 LASER product.
- Use of controls, adjustments or performance of procedures other than those specified herein may result in hazardous radiation exposure.

As the laser beam used in this compact disc player is harmful to the eyes, do not attempt to disassemble the cabinet. Refer servicing to qualified personnel only.

Laser Diode Properties
 Material: GaAlAs
 Wavelength: 780 nm
 Emission Duration: continuous
 Laser Output: max. 0.6 mW

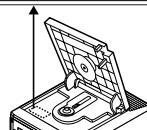
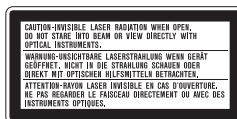

Note for users in Australia:

Copyright may exist in material you wish to record. Copying or broadcasting such material without permission of the relevant licensees or owners of the copyright is prohibited by law. SHARP is not in a position to authorise the copying or broadcasting of copyrighted materials and nothing in this OPERATION MANUAL should be implied as giving that authority.

For other countries:

Audio-visual material may consist of copyrighted works which must not be recorded without the authority of the owner of the copyright. Please refer to the relevant laws in your country.

Contents

	Page
■ General Information	
Precautions	3
Controls and indicators	4, 5
■ Preparation for Use	
System connections	6, 7
Remote control	7
■ Basic Operation	
Sound control	8
Setting the clock	9
■ Disc Playback	
Listening to a disc	10 - 12
Advanced disc playback	13 - 15
■ Radio	
Listening to the radio	16
Listening to the memorised station	17
■ Tape Playback	
Listening to a cassette tape	18
■ Tape Recording	
Recording on a cassette tape	19, 20
■ Advanced Features	
Timer and sleep operation	21, 22
■ References	
Troubleshooting chart	23, 24
Maintenance	24
Specifications	25
WARRANTY	Back cover

Precautions

XL-MP10H

1

■ General

- Please ensure that the equipment is positioned in a well ventilated area and that there is at least 10 cm of free space along the sides and back. There must also be a minimum of 20 cm of free space on the top of the unit.

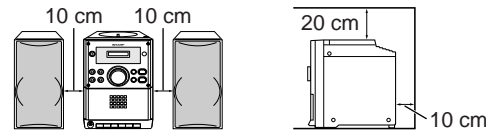

- Use the unit on a firm, level surface free from vibration.



- Keep the unit away from direct sunlight, strong magnetic fields, excessive dust, humidity and electronic/electrical equipment (home computers, facsimiles, etc.) which generate electrical noise.
- Do not place anything on top of the unit.
- Do not expose the unit to moisture, to temperatures higher than 60°C or to extremely low temperatures.
- If your system does not work properly, disconnect the AC power lead from the wall socket. Plug the AC power lead back in, and then turn on your system.
- In case of an electrical storm, unplug the unit for safety.

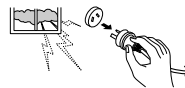

- Hold the AC power plug by the head when removing it from the wall socket, as pulling the lead can damage internal wires.



- Do not remove the outer cover, as this may result in electric shock. Refer internal service to your local SHARP service facility.

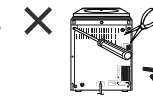

- The ventilation should not be impeded by covering the ventilation openings with items, such as newspapers, tablecloths, curtains, etc.

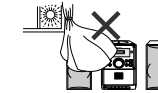

- No naked flame sources, such as lighted candles, should be placed on the apparatus.
- Attention should be drawn to the environmental aspects of battery disposal.
- This unit should only be used within the range of 5°C - 35°C.

Warnings:

- The voltage used must be the same as that specified on this unit. Using this product with a higher voltage other than that which is specified is dangerous and may result in a fire or other type of accident causing damage. SHARP will not be held responsible for any damage resulting from use of this unit with a voltage other than that which is specified.
- CD players use a laser pickup which can damage the eyes if viewed directly. Do not look at the pickup, and do not touch the pickup directly.

■ Volume control

The sound level at a given volume setting depends on speaker efficiency, location, and various other factors. It is advisable to avoid exposure to high volume levels. Do not turn the volume on to full at switch on and listen to music at moderate levels.

General Information

3

Controls and indicators

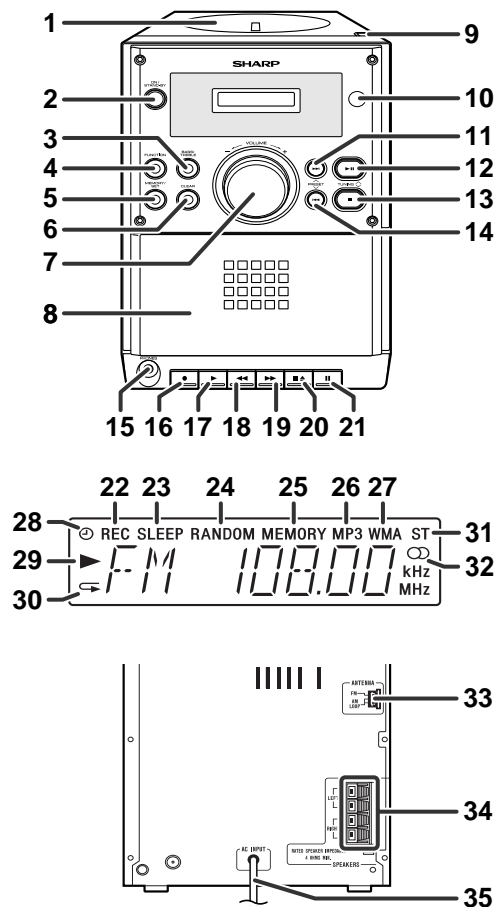

	Reference page
1. Disc Compartment	11
2. On/Stand-by Button	7
3. Bass/Treble Selector Button	8
4. Function Selector Button	11, 16, 18
5. Memory/Set Button	15, 17
6. Clear Button	15, 17
7. Volume Control	8
8. Cassette Compartment	18
9. Disc Eject Button	11
10. Remote Sensor	7
11. Disc Track Up or Fast Forward, Tuner Preset Up Button	13, 17
12. Disc Play or Pause, Tuning Up Button	11, 16
13. Disc Stop, Tuning Down Button	11, 16
14. Disc Track Down or Fast Reverse, Tuner Preset Down Button	13, 17
15. Headphone Socket	12
16. Tape Record Button	19, 20
17. Tape Play Button	18
18. Tape Rewind Button	18
19. Tape Fast Forward Button	18
20. Tape Stop/Eject Button	18
21. Tape Pause Button	18
22. Tape Record Indicator	19
23. Sleep Indicator	22
24. Disc Random Play Indicator	14
25. Memory Indicator	15, 17
26. MP3 Track Indicator	11
27. WMA Track Indicator	11
28. Timer Play Indicator	21
29. Disc Play Indicator	11
30. Disc Repeat Indicator	14
31. FM Stereo Mode Indicator	16
32. FM Stereo Receiving Indicator	16
33. FM/AM Loop Aerial Socket	6
34. Speaker Terminals	6
35. AC Power Lead	6, 7

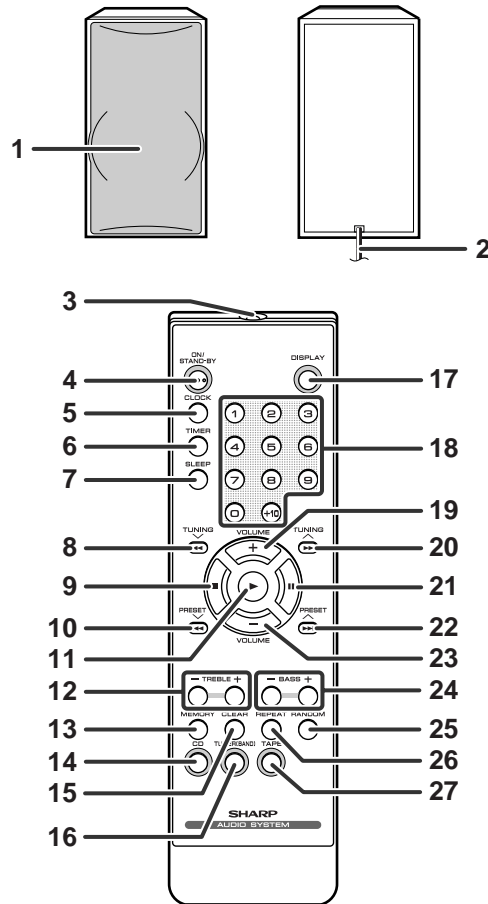

- 1. Full-Range Speaker
- 2. Speaker Wire

Note:
The speaker grilles are not removable.

	Reference page
3. Remote Control Transmitter	7
4. On/Stand-by Button	7
5. Clock Button	9
6. Timer Button	21
7. Sleep Button	22
8. Disc Fast Reverse, Tuning Down Button	13, 16
9. Disc Stop Button	11
10. Disc Track Down, Tuner Preset Down, Time Down Button	9, 13, 17
11. Disc Play Button	11
12. Treble Up and Down Buttons	8
13. Memory Button	9, 15, 17
14. Disc Button	11
15. Clear Button	15, 17
16. Tuner and Band Selector Button	16
17. MP3/WMA Display Button	12, 13
18. Direct Search Buttons	14
19. Volume Up Button	8
20. Disc Fast Forward, Tuning Up Button	13, 16
21. Disc Pause Button	11
22. Disc Track Up, Tuner Preset Up, Time Up Button	9, 13, 17
23. Volume Down Button	8
24. Bass Up and Down Buttons	8
25. Disc Random Play Button	14
26. Disc Repeat Button	14
27. Tape Button	18

System connections

Make sure to unplug the AC power lead before making any connections.

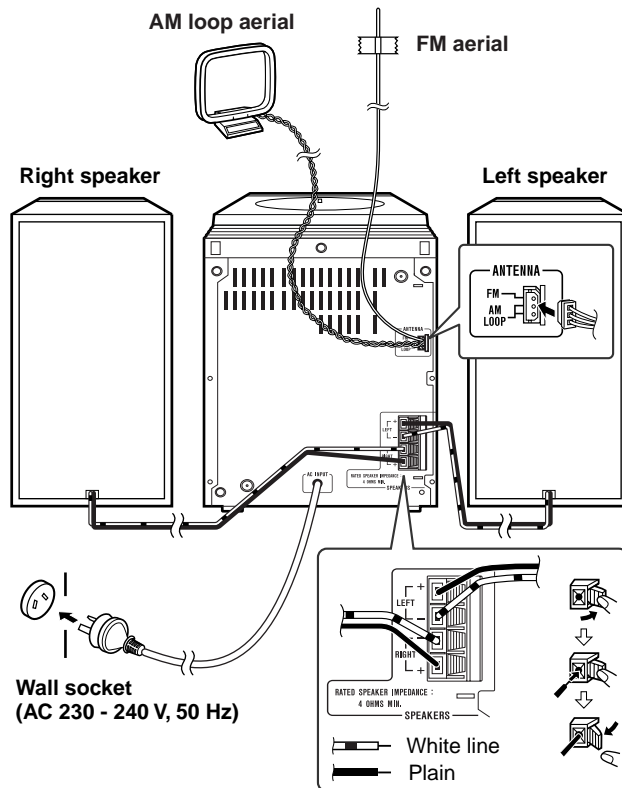

■ Aerial connection

Connect the FM/AM loop aerial to the ANTENNA socket. Position the FM aerial wire and rotate the AM loop aerial for optimum reception. Place the AM loop aerial on a shelf, or attach it to a stand or a wall.

Notes:

- Placing the aerial on the unit or near the AC power lead may cause noise pickup. Place the aerial away from the unit for better reception.
- Do not connect the attached FM aerial to an external aerial as this may cause trouble.

Installing the AM loop aerial:

< Assembling >

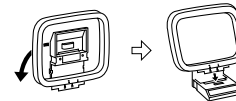

< Attaching to the wall >

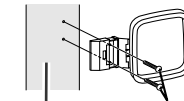

Wall Screws (not supplied)

■ Speaker connection

Connect the wire with the white line to the minus (-) terminal and the plain wire to the plus (+) terminal.

Caution:

- Do not let the bare speaker wires touch each other.
- Use speakers with an impedance of 4 ohms or more, as lower impedance speakers can damage the unit.
- Do not mistake the right and the left channels. The right speaker is the one on the right side when you face the unit.

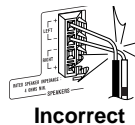

Placing the speaker system:

There is no distinction between the right and the left speakers.

■ AC power connection

After checking all the connections have been made correctly, plug the AC power lead of this unit into the wall socket.

Note:

Unplug the AC power lead from the wall socket if the unit will not be in use for a prolonged period of time.

■ To turn the power on

Press the ON/STAND-BY button to turn the power on.

After use:

Press the ON/STAND-BY button to enter the power stand-by mode.

Remote control

■ Battery installation

- 1 Remove the battery cover.
- 2 Insert the supplied batteries according to the direction indicated in the battery compartment.
When inserting or removing the batteries, push them toward the ⊖ battery terminals.
- 3 Replace the cover.

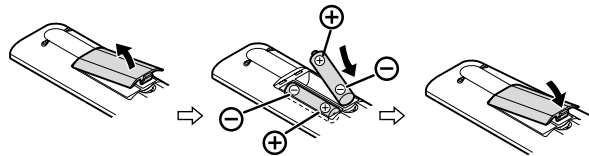

Precautions for battery use:

- Replace all old batteries with new ones at the same time.
- Do not mix old and new batteries.
- Remove the batteries if the unit is not to be used for long periods of time. This will prevent potential damage due to battery leakage.

Caution:

- Do not use rechargeable batteries (nickel-cadmium battery, etc.).
- Installing the batteries incorrectly may cause the unit to malfunction.

Battery removal:

Remove the battery cover. Push each battery toward the ⊖ battery terminal and take them out.

Notes concerning use:

- Replace the batteries if the operating distance is reduced or if the operation becomes erratic. Purchase 2 "AA" size batteries (UM/SUM-3, R6, HP-7 or similar).
- Periodically clean the transmitter on the remote control and the sensor on the unit with a soft cloth.
- Exposing the sensor on the unit to strong light may interfere with operation. Change the lighting or the direction of the unit.
- Keep the remote control away from moisture, heat, shock, and vibrations.

■ Test of the remote control

Check the remote control after checking all the connections (see pages 6 - 7).
Point the remote control directly at the remote sensor on the unit.

The remote control can be used within the range shown:
Press the ON/STAND-BY button.
Does the power turn on? Now, you can enjoy music.

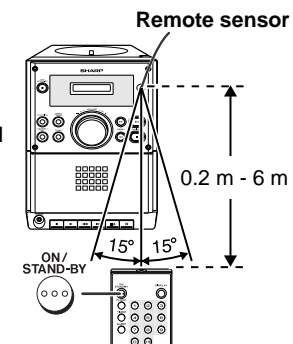

Sound control

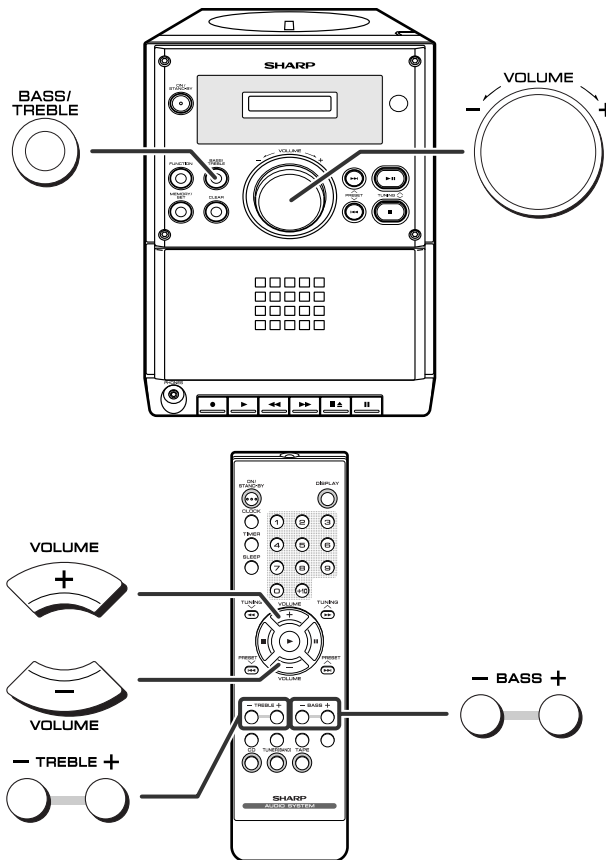

■ Adjusting the volume

Main unit operation:

When the VOLUME control is turned clockwise, the volume will increase. When it is turned anti-clockwise, the volume will decrease.

Remote control operation:

Press the VOLUME (- or +) button to increase or decrease the volume.

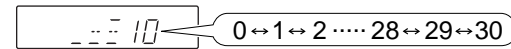

■ Adjusting the bass

Main unit operation:

- 1 Press the BASS/TREBLE button to select "BASS".
- 2 Within 5 seconds, turn the VOLUME control to adjust the bass.

Remote control operation:

Press the BASS (- or +) button to adjust the bass.

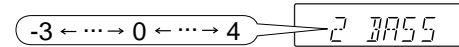

■ Adjusting the treble

Main unit operation:

- 1 Press the BASS/TREBLE button to select "TRE".
- 2 Within 5 seconds, turn the VOLUME control to adjust the treble.

Remote control operation:

Press the TREBLE (- or +) button to adjust the treble.

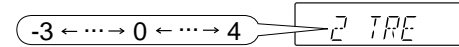

Setting the clock

XL-MP10H

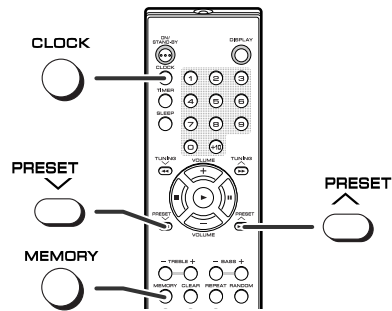

This may be operated only with the remote control.
In this example, the clock is set for the 24-hour (0:00) display.

- 1 Press the **CLOCK** button and within 5 seconds, press the **MEMORY** button.

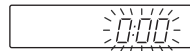

- 2 Within 1 minute, press the **PRESET** (∨ or ∧) button to select 24-hour or 12-hour display and then press the **MEMORY** button.



- "0:00" → The 24-hour display will appear.
(0:00 - 23:59)
- "AM 12:00" → The 12-hour display will appear.
(AM 12:00 - PM 11:59)

- 3 Within 1 minute, press the **PRESET** (∨ or ∧) button to adjust the hour and then press the **MEMORY** button.

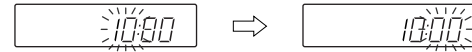

Press the **PRESET** (∨ or ∧) button once to advance the time by 1 hour. Hold it down to advance continuously.

- 4 Within 1 minute, press the **PRESET** (∨ or ∧) button to adjust the minutes and then press the **MEMORY** button.



Press the **PRESET** (∨ or ∧) button once to advance the time by 1 minute. Hold it down to advance continuously.

To confirm the time display:

Press the **CLOCK** button.
The time display will appear for about 5 seconds.

Note:

The "0:00" or time will flash when the AC power supply is restored after a power failure or unplugging the unit.
Readjust the clock as follows.

To readjust the clock:

Perform "Setting the clock" from the beginning. If the "0:00" is not flashing in step 1, step 2 (for selecting the 24-hour or 12-hour display) will be skipped.

To change the 24-hour or 12-hour display:

- 1 Clear all the programmed contents. [Refer to "Clearing all the memory (reset)" on page 24 for details.]
- 2 Perform "Setting the clock" from the beginning.

3

Basic Operation

9

Listening to a disc

This system can play back a standard CD, CD-R/RW in the CD format and CD-R/RW with MP3 or WMA files, but cannot record on them.

Some audio CD-R and CD-RW discs may not be playable due to the state of the disc or the equipment used for recording.

MP3:

MP3 is a form of compression. It is an acronym which stands for MPEG Audio Layer 3.

MP3 is a type of audio code which is processed by significant compression from the original audio source with very little loss in sound quality.

- The MP3 track indicator will light up when an MP3 track is read.
- This system supports MPEG 1 Layer 3, MPEG 2 Layer 3, and VBR files.
- During VBR file playback, time counter in the display may differ from its actual playback time.

WMA:

WMA files are ASF (Advanced Systems Format) audio files which are compressed with Windows Media Audio codec. WMA is developed by Microsoft as an audio format file for Windows Media Player.

- The WMA track indicator will light up when a WMA track is read.
- Supported bit rates for WMA files range from 64 kbps to 160 kbps.

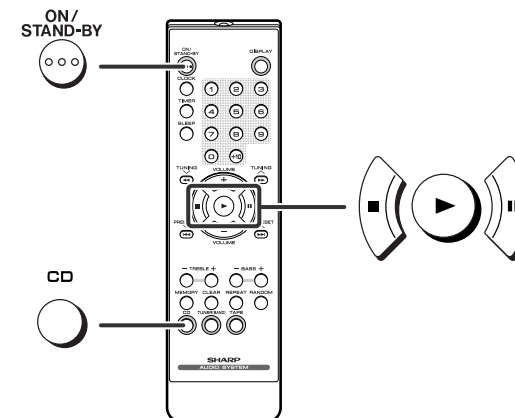
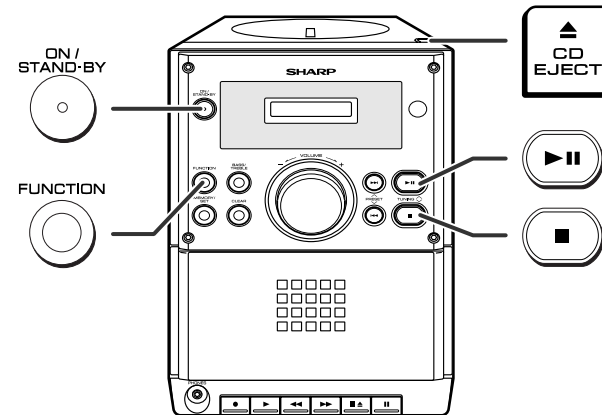

1 Press the ON/STAND-BY button to turn the power on.

2 Press the FUNCTION button until "CD DISC" appears on the display.
When operating with the remote control, press the CD button.

3 Press the ▲ CD EJECT button to open the disc compartment.

4 Place the disc on the spindle, label side up.

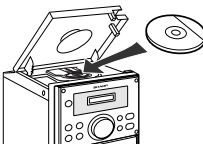

5 Close the disc compartment by firmly pushing the corner marked "PUSH CLOSE".

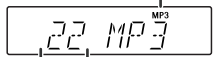

[MP3] MP3 track indicator

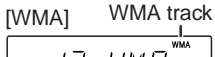
 Total number of tracks

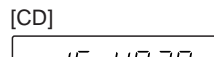
[WMA] WMA track indicator

 Total number of tracks

[CD]

 Total number of tracks Total playing time

- Due to the structure of its disc information, it takes longer (approximately 20 to 90 seconds) to read a CD-R/RW disc recorded in the MP3 or WMA format than a normal CD.

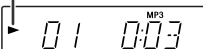
6 Press the ►II (▶) button to start playback from track 1.

Disc play indicator



When the last track on the disc has finished playing, the unit will stop automatically.

To interrupt playback:
Main unit operation:
 Press the ►II button.
 To resume playback from the same point, press the ►II button again.

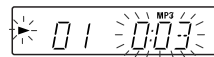

Remote control operation:
 Press the II button.
 To resume playback from the same point, press the ▶ button.

To stop playback:
 Press the ■ button.

To remove the disc:
 Whilst in the stop mode, press the ▲ CD EJECT button.

- Caution:**
- Do not play discs with special shapes (heart or octagon shaped) as it may cause malfunctions.
 - If a disc is damaged, dirty, or loaded upside down, "NO DISC" will appear on the display.
 - Keep foreign objects out of the disc compartment.
 - Subjecting the unit to shock or vibration may cause mistracking.
 - When the unit is not being used, be sure to close the disc compartment. If it is left open, the lens may be covered with dust and the unit may not operate properly.
 - If TV or radio interference occurs during disc operation, move the unit away from it.

Listening to a disc (continued)

■ Care of compact discs

Compact discs are fairly resistant to damage, however mistracking can occur due to an accumulation of dirt on the disc surface. Follow the guidelines below for maximum enjoyment from your CD collection and player.

- Do not write on either side of the disc, particularly the non-label side from which signals are read. Do not mark this surface.
- Keep your discs away from direct sunlight, heat, and excessive moisture.
- Always hold the CDs by the edges. Fingerprints, dirt, or water on the CDs can cause noise or mistracking. If a CD is dirty or does not play properly, clean it with a soft, dry cloth, wiping straight out from the centre, along the radius.

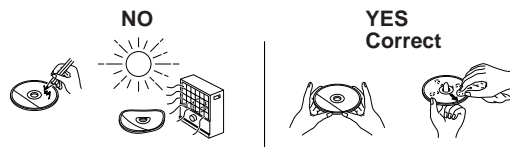

■ Headphones

- Before plugging in or unplugging the headphones, reduce the volume.
- Be sure your headphones have a 3.5 mm diameter plug and impedance between 16 and 50 ohms. The recommended impedance is 32 ohms.
- Plugging in the headphones disconnects the speakers automatically. Adjust the volume using the VOLUME control.

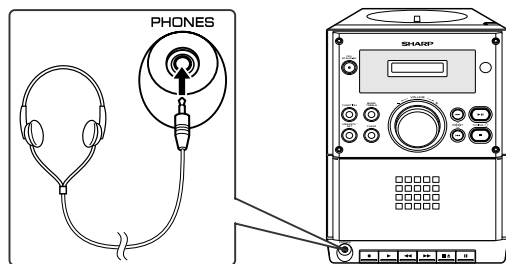

■ To change the display (CD-R/RW discs recorded in the MP3 or WMA format only)

Whilst in the stop mode or playback mode, press the DISPLAY button.

Each time the button is pressed, the display will change as follows.

[When in the stop mode]

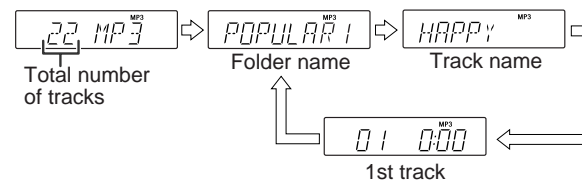

- To check the total number of tracks, press the ■ button.

[When in the playback mode]

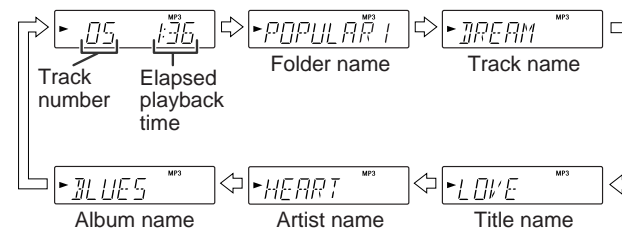

Advanced disc playback

XL-MP10H

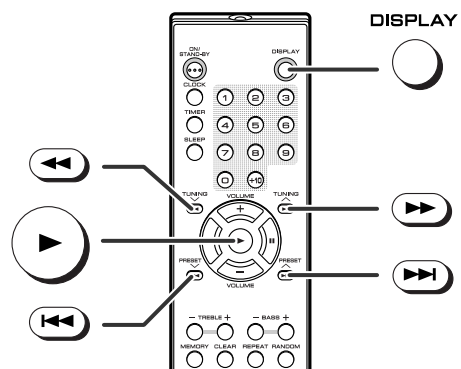

- **To select the desired folder or track by name (CD-R/RW discs recorded in the MP3 or WMA format only)**

1	Whilst in the stop mode, press the DISPLAY button on the remote control to display the folder name.	POPULAR MP3
2	Select the desired folder by pressing the ◀◀ or ▶▶ button.	
3	Press the DISPLAY button to display the track name.	HAPPY MP3
4	Select the desired track by pressing the ◀◀ or ▶▶ button.	
5	Press the ▶ (▶) button to begin playback.	▶ 05 0:01 MP3

- **To locate the beginning of a track**

To move to the beginning of the next track: Press the ▶▶ button for less than 0.5 seconds during playback.
To restart the track being played: Press the ◀◀ button for less than 0.5 seconds during playback.

Note:
You can skip to any track by pressing the ◀◀ or ▶▶ button repeatedly until the desired track number appears.

- **To locate the desired portion**

Sound will be heard for a CD, but not for CD-R/RW discs recorded in the MP3 or WMA format. (Check the displayed playback time for these discs.)

For fast forward: Press and hold down the ▶▶ button during playback.
For fast reverse: Press and hold down the ◀◀ button during playback.

Notes:

- Normal playback will resume when the ◀◀ or ▶▶ button is released.
- When the end of the last track is reached during fast forward, "END" will appear on the display and disc operation will be paused. When the beginning of the first track is reached during fast reverse, the disc will start playback automatically.
- The ◀◀ or ▶▶ button on the main unit allows you to locate the desired portion.

Advanced disc playback (continued)

■ Direct search of the track

By using the direct search buttons, the desired tracks can be played.

- 1 Whilst in the stop mode, use the direct search buttons on the remote control to select the desired track.

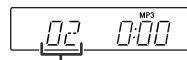

Selected track number

- The direct search buttons allow you to select up to number 9.
- When selecting number 10 or higher, use the "+10" button.

A. For example, to choose 13

- 1 Press the "+10" button once.
- 2 Press the "3" button.

B. For example, to choose 30

- 1 Press the "+10" button three times.
- 2 Press the "0" button.

- 2 Press the ► (▶II) button to start playback.

Playback of the selected track is started. When the last track on the disc has finished playing, the unit will stop automatically.

To stop playback:

Press the ■ button.

Notes:

- The selected track can be started simply by pressing the direct search buttons during playback. [It is not necessary to press the ► (▶II) button.]
- A track number higher than the number of tracks on the disc cannot be selected.
- During random play, direct search is not possible.
- For CD-R/RW discs recorded in the MP3 or WMA format, you can select the track number but cannot select the folder by pressing the direct search buttons.

■ Repeat play

All tracks or a programmed sequence can be continuously repeated.

To repeat all tracks:

- 1 Press the REPEAT button.
- 2 Press the ► (▶II) button.



To repeat a desired track:

- 1 Perform steps 1 - 3 in the "Programmed play" section on page 15 and then press the REPEAT button.
- 2 Press the ► (▶II) button.

To repeat random play:

Press the REPEAT button during random play.

To cancel repeat play:

Press the REPEAT button again. "◀" will go out.

Caution:

After performing repeat play, be sure to press the ■ button. Otherwise, the disc will play continuously.

■ Random play

The tracks can be played in random order automatically.

Whilst in the stop mode, press the RANDOM button and the ► (▶II) button sequentially to begin random play.



To cancel random play:

Whilst in the stop mode, press the RANDOM button again.

Notes:

- When you press the RANDOM button during playback, the main unit switches to random play.
- Random play will stop automatically when all tracks are played once. (The same track will not be played back twice.)
- In random play, the unit will select and play tracks automatically. (You cannot select the order of the tracks.)
- If you press the ► (▶II) button during random play, you can move to the next track by the random operation. On the other hand, the ◀◀ button does not allow you to move to the previous track. The beginning of the track being played will be located.

■ Programmed play

You can choose up to 32 selections for playback in the order you like.

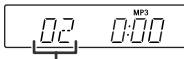
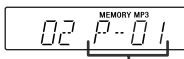
<p>1 Whilst in the stop mode, use the direct search buttons to select the desired track.</p>	
	<p>Selected track number</p> <p>You can also select a track by pressing the ◀◀ or ▶▶ button.</p>
<p>2 Press the MEMORY (MEMORY/SET) button to save the track number.</p>	
	<p>Playback order</p> <p>When the track is memorised, "MEMORY" will appear.</p>
<p>3 Repeat steps 1 - 2 for other tracks. Up to 32 tracks can be programmed.</p> <p>If you make a mistake, the programmed tracks can be cleared by pressing the CLEAR button.</p>	
<p>4 Press the ▶ (▶II) button to start playback.</p>	

To clear the programmed selections:

Whilst the "MEMORY" indicator is lit, set the CD to the stop mode and then press the CLEAR button. Each time the button is pressed, one track will be cleared, beginning with the last track programmed. When all the tracks are cleared, "MEMORY" will disappear.

Adding tracks to the programme:

If a programme has been previously stored, the "MEMORY" indicator will be displayed. Then follow steps 1 - 2 to add tracks. The new tracks will be stored after the last track of the original programme.

Notes:

- Opening the disc compartment automatically cancels the programmed sequence.
- Even if you press the ON/STAND-BY button to enter the stand-by mode or change the function from CD to another, the programmed selections will not be cleared.
- During the programme operation, random play is not possible.
- For CD-R/RW discs recorded in the MP3 or WMA format, you can select the track number but cannot select the folder by pressing the direct search buttons.

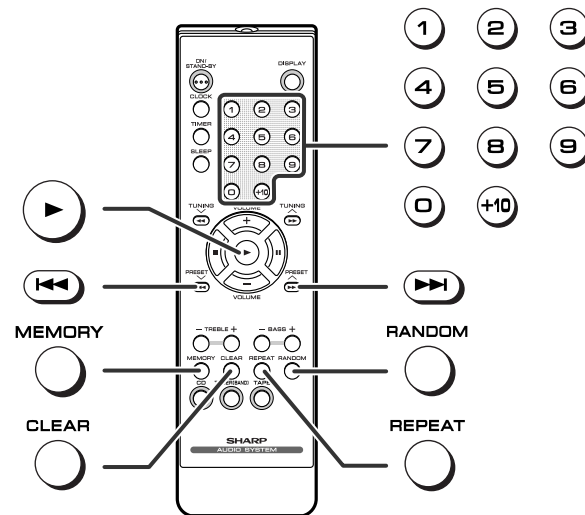

Listening to the radio

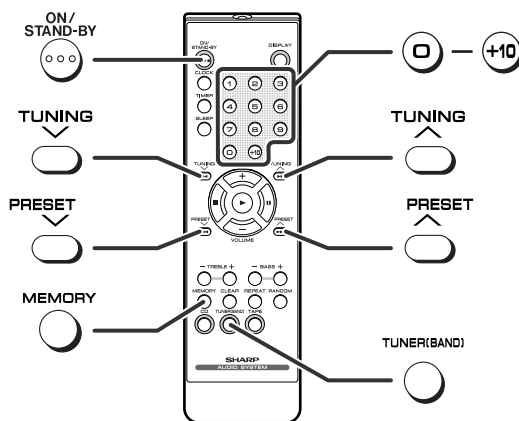
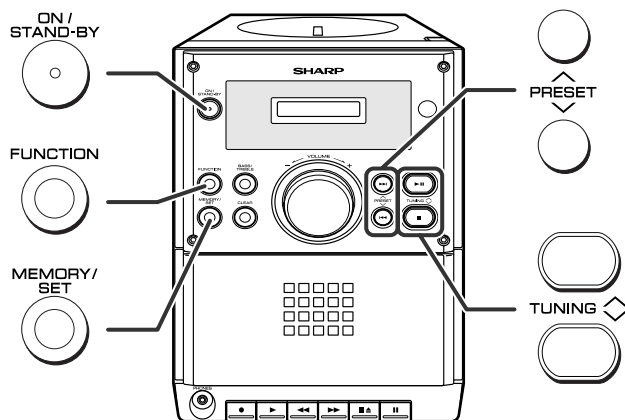

- 1 Press the ON/STAND-BY button to turn the power on.**
- 2 Press the FUNCTION button until "FM" or "AM" appears on the display.**
When operating with the remote control, press the TUNER (BAND) button to select "FM" or "AM".
- 3 Press the TUNING (∨ or ∧) button to tune in to the desired station.**
Manual tuning:
Press the TUNING button as many times as required to tune in to the desired station.
Auto tuning:
When the TUNING button is pressed for more than 0.5 seconds, scanning will start automatically and the tuner will stop at the first receivable broadcast station.

Notes:

- When radio interference occurs, auto scan tuning may stop automatically at that point.
- Auto scan tuning will skip weak signal stations.
- To stop the auto tuning, press the TUNING button again.

To receive an FM stereo transmission:

Press the FUNCTION [TUNER (BAND)] button to display the "ST" indicator.

- "∞" will appear when an FM broadcast is in stereo.
- If the FM reception is weak, press the FUNCTION [TUNER (BAND)] button to extinguish the "ST" indicator. The reception changes to monaural, and the sound becomes clearer.

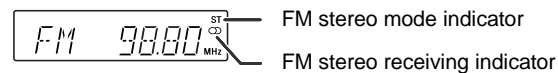

Note:



This product can receive FM stereo/FM monaural and AM monaural broadcasts. AM stereo broadcasts will not be played in stereo.

Listening to the memorised station

XL-MP10H

■ Memorising a station

You can store 40 AM and FM stations in memory and recall them at the push of a button. (Preset tuning)

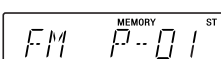
- | | | |
|----------|--|--|
| 1 | Perform steps 1 - 3 in "Listening to the radio" on page 16. | |
| 2 | Press the MEMORY/SET (MEMORY) button to enter the preset tuning saving mode. |  |
| 3 | Within 5 seconds, press the PRESET (∨ or ∧) button to select the preset channel number. |  |
| | Store the stations in memory, in order, starting with preset channel 1. | |
| 4 | Within 5 seconds, press the MEMORY/SET (MEMORY) button to store that station in memory. |  |
| | If the "MEMORY" and preset number indicators go out before the station is memorised, repeat the operation from step 2. | |
| 5 | Repeat steps 1 - 4 to set other stations, or to change a preset station. | |
| | When a new station is stored in memory, the station previously memorised will be erased. | |

Note:

The backup function protects the memorised stations for a few hours should there be a power failure or the AC power lead disconnection.

■ To recall a memorised station

Press the PRESET (∨ or ∧) button for less than 0.5 seconds to select the desired station.

To select a preset station with the direct number buttons:

Press the corresponding number ("0" - "+10").

Example:

To select 28, press "+10", "+10" and "8".

■ To scan the preset stations

The stations saved in memory can be scanned automatically. (Preset memory scan)

- 1 Press the PRESET (∨ or ∧) button for more than 0.5 seconds. The preset number will flash and the programmed stations will be tuned in sequentially, for 5 seconds each.
- 2 Press the PRESET (∨ or ∧) button again when the desired station is located.

■ To clear a memorised station

- 1 Recall the memorised station.
- 2 Whilst it is displayed, press the MEMORY/SET (MEMORY) button.
- 3 Within 5 seconds, press the CLEAR button on the remote control.

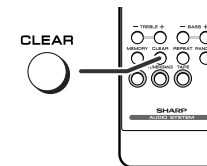

■ To erase entire preset memory

- 1 Press the ON/STAND-BY button to enter the power stand-by mode.
- 2 Whilst pressing down the MEMORY/SET button and the PRESET ∨ button, press the ON/STAND-BY button until "TUCL" appears.



Listening to a cassette tape

Before playback:

- For playback, use normal or low-noise tapes for the best sound. (Metal or CrO₂ tapes are not recommended.)
- Do not use C-120 tapes or poor-quality tapes, as they may cause malfunctions.
- Before loading a tape into the cassette compartment, tighten the slack with a pen or a pencil.

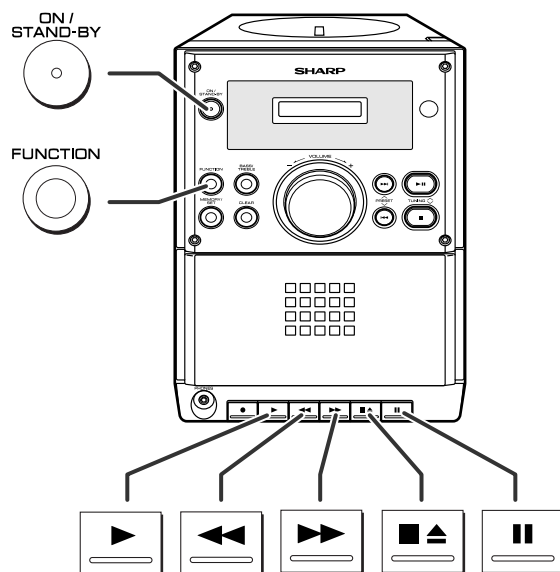

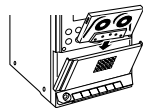
- 1 Press the ON/STAND-BY button to turn the power on.
- 2 Press the FUNCTION button until "TAPE" appears on the display.
When operating with the remote control, press the TAPE button.
- 3 Press the ■ ▲ button to open the cassette compartment.
- 4 Load a cassette into the cassette compartment with the side to be played facing toward you. 
- 5 Close the cassette compartment.
- 6 Press the ► button to start playback.

To stop playback:

Press the ■ ▲ button.

Fast forward/rewind:

To advance the tape, press the ■ ▲ button, then press the ►► button. To rewind, press the ■ ▲ button, then press the ◀◀ button.

To interrupt playback:

Press the || button during playback.

Press the || button again to resume playback.

Caution:

- Do not press the || button whilst the fast forward or rewind operations are in progress. The ◀◀ or ►► button will not be released when the tape end is reached. Once this occurs, press the ■ ▲ button.
- Before changing from one tape operation to another, press the ■ ▲ button.

Recording on a cassette tape

XL-MP10H

Before recording:

- When recording important selections, make a preliminary test to ensure that the desired material is properly recorded.
- SHARP is not liable for damage or loss of your recording arising from malfunction of this unit.
- The volume and sound controls can be adjusted with no effect on the recorded signal (Variable Sound Monitor).
- **For recording, use only normal tapes. Do not use metal or CrO₂ tapes.**
- Do not use C-120 tapes or poor-quality tapes, as they may cause malfunctions.

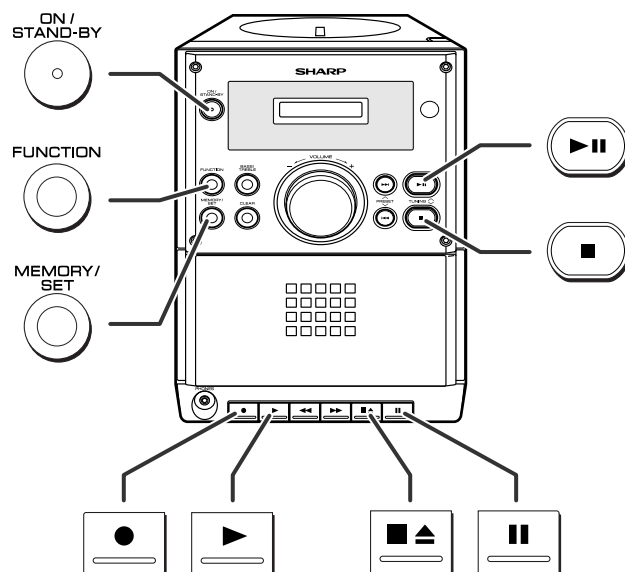

Erase-prevention tab of cassette tapes:

- When recording on a cassette tape, make sure that the erase-prevention tabs are not removed. Cassettes have removable tabs that prevent accidental recording or erasing.
- To protect the recorded sound, remove the tab after recording. Cover the tab hole with adhesive tape to record on the tape without the tab.

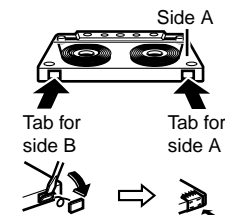

■ Recording from a disc

- 1 Press the ON/STAND-BY button to turn the power on.
- 2 Press the FUNCTION button until "CD DISC" appears on the display.
When operating with the remote control, press the CD button.
- 3 Load the desired disc.
- 4 Load a cassette into the cassette compartment with the side to be recorded on facing you.
Wind past the leader of the tape, on which recording cannot be performed.
- 5 Press the || button.
- 6 Press the ● button, which also engages the ▶ button.

- 7 Press the || button again to cancel the pause mode.
- 8 Press the ▶|| (▶) button to start recording.

6

Tape Recording

19

Recording on a cassette tape (continued)

To perform programmed recording:

- 1 Programme tracks (see page 15).
- 2 Press the **||** button.
- 3 Press the **●** button, which also engages the **▶** button.
- 4 Press the **||** button again to cancel the pause mode.
- 5 Press the **▶||** (**▶**) button to start recording.

To interrupt recording:

Press the **||** button.
To resume recording, press the **||** button.

To stop recording:

Press the **■▲** button.
The tape will stop.

■ Recording from the radio

- | |
|---|
| 1 Tune in to the desired station (see page 16). |
| 2 Load a cassette into the cassette compartment with the side to be recorded on facing you.
Wind past the leader of the tape, on which recording cannot be performed. |
| 3 Press the button. |
| 4 Press the ● button, which also engages the ▶ button. |
| 5 Press the button again to begin recording. |

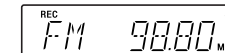

To stop recording:

Press the **■▲** button.

Note:

If you hear a whistling noise whilst recording an AM station, move the AM loop aerial.

■ Erasing recorded tapes

- 1 Load the tape to be erased into the cassette compartment with the side to be erased facing toward you.
- 2 Press the FUNCTION button until "TAPE" appears on the display.
When operating with the remote control, press the TAPE button.
- 3 Press the **●** button, which also engages the **▶** button to begin erasing.

Timer and sleep operation

XL-MP10H

This may be operated only with the remote control.

Timer playback:

The unit turns on and plays the desired source (disc or tuner) at a preset time.

Sleep operation:

The radio or disc can be turned off automatically.

Note:

The timer and sleep operations are not available during tape mode.

Before setting timer:

- 1 Check that the clock is set to the correct time (refer to page 9).
- 2 Load a disc to be played.

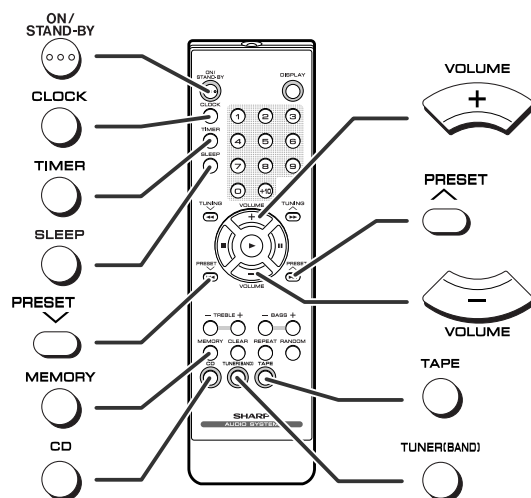

■ Timer playback

- 1 Press the ON/STAND-BY button to turn the power on.**
- 2 Press the CD or TUNER (BAND) button to select the desired function.**
When you selected the TUNER (BAND), tune in to the desired station.
- 3 Adjust the volume using the VOLUME buttons.**
Do not turn the volume up too high.
- 4 Press the TIMER button and within 6 seconds, press the MEMORY button.**

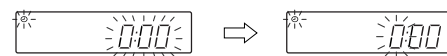

- 5 Within 1 minute, press the PRESET (∨ or ∧) button to specify the hour to start, then press the MEMORY button.**

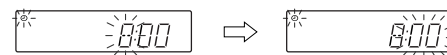

- 6 Within 1 minute, press the PRESET (∨ or ∧) button to specify the minutes to start, then press the MEMORY button.**

- The timer playback starting time, function, and volume will be displayed, and then the unit will enter the stand-by mode automatically.
- "⌚" will appear and the current time will be displayed.



To cancel the timer playback:

Press the ON/STAND-BY button to turn the power on.

Continued to the next page

Timer and sleep operation (continued)

7 When the preset time is reached, playback will start.

The volume will increase gradually until it reaches the volume you were listening at before your system enters the timer stand-by mode.

8 The unit will enter the stand-by mode one hour after the timer playback starts. However, when disc playback time is one hour or less, it will enter the stand-by mode after completing playback.

To reset or change the timer setting:

Perform "Timer playback" from the beginning.

■ Sleep operation

1 Play back the desired sound source.

2 Press the SLEEP button.



To change the sleep time:

Press the SLEEP button repeatedly to select the desired sleep time. The time will decrease as follows.

The amount of sleep time can also be changed whilst in the sleep mode.

(Maximum: 3 hours - Minimum: 5 minutes)

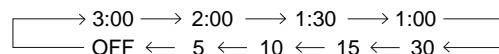

3 Your system will enter the power stand-by mode automatically after the preset time has elapsed.

The volume will turn down 40 seconds before the sleep operation finishes.

To cancel the sleep operation:

Press the ON/STAND-BY button whilst "SLEEP" is indicated.

To cancel the sleep operation without setting the system to the stand-by mode, press the SLEEP button until "OFF" appears on the display.

To confirm the remaining sleep time:

Press the SLEEP button once whilst the sleep timer is set.

The remaining sleep time is displayed for about 3 seconds.

■ To use timer and sleep operation together

Example: To fall asleep and wake up to the same radio station

You can play back the same source only (the function cannot be switched).

1 Set the sleep time (steps 1 - 2 on the left).

2 Whilst the sleep timer is set, set the desired playback time (steps 4 - 6, page 21).

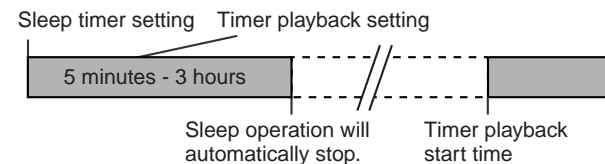

Troubleshooting chart

XL-MP10H

Many potential problems can be resolved by the owner without calling a service technician.

If something is wrong with this product, check the following before calling your authorised SHARP dealer or service centre.

■ General

Symptom	Possible cause
<ul style="list-style-type: none"> The clock is not set to the correct time. 	<ul style="list-style-type: none"> Did a power failure occur? Reset the clock. (Refer to page 9.)
<ul style="list-style-type: none"> When a button is pressed, the unit does not respond. 	<ul style="list-style-type: none"> Set the unit to the power stand-by mode and then turn it back on. If the unit still malfunctions, reset it. (Refer to page 24.)
<ul style="list-style-type: none"> No sound is heard. 	<ul style="list-style-type: none"> Is the volume level set to "0"? Are the headphones connected? Are the speaker wires disconnected?

■ CD player

Symptom	Possible cause
<ul style="list-style-type: none"> Playback does not start. Playback stops in the middle or is not performed properly. 	<ul style="list-style-type: none"> Is the disc loaded upside down? Does the disc satisfy the standards? Is the disc distorted or scratched?
<ul style="list-style-type: none"> Playback sounds are skipped, or stopped in the middle of a track. 	<ul style="list-style-type: none"> Is the unit located near excessive vibrations? Is the disc very dirty? Has condensation formed inside the unit?

■ Tuner

Symptom	Possible cause
<ul style="list-style-type: none"> The radio makes unusual noises continuously. 	<ul style="list-style-type: none"> Is the unit placed near the TV or computer? Is the FM/AM loop aerial placed properly? Move the aerial away from the AC power lead if located nearby.

■ Cassette deck

Symptom	Possible cause
<ul style="list-style-type: none"> Cannot record. 	<ul style="list-style-type: none"> Is the erase-prevention tab removed?
<ul style="list-style-type: none"> Cannot record tracks with proper sound quality. Cannot erase completely. 	<ul style="list-style-type: none"> Is it a normal tape? (You cannot record on a metal or CrO₂ tape.)
<ul style="list-style-type: none"> Sound skipping. 	<ul style="list-style-type: none"> Is there slack in the tape? Is the tape stretched?
<ul style="list-style-type: none"> Cannot hear treble. Sound fluctuation. 	<ul style="list-style-type: none"> Are the capstans, pinch rollers, or heads dirty?

■ Remote control

Symptom	Possible cause
<ul style="list-style-type: none"> The remote control does not operate. 	<ul style="list-style-type: none"> Is the AC power lead of the unit plugged in? Is the battery polarity correct? Are the batteries dead? Is the distance or angle incorrect? Does the remote control sensor receive strong light?

■ If trouble occurs

When this product is subjected to strong external interference (mechanical shock, excessive static electricity, abnormal supply voltage due to lightning, etc.) or if it is operated incorrectly, it may malfunction.

If such a problem occurs, do the following:

- 1 Set the unit to the stand-by mode and turn the power on again.
- 2 If the unit is not restored in the previous operation, unplug and plug in the unit, and then turn the power on.

Note:

If neither operation above restores the unit, clear all the memory by resetting it.

■ Clearing all the memory (reset)

- 1 Press the ON/STAND-BY button to enter the power stand-by mode.
- 2 Whilst pressing down the MEMORY/SET button and the CLEAR button, press the ON/STAND-BY button until "CL" appears.

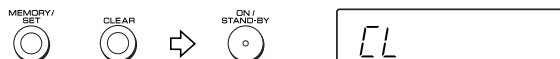

Caution:

This operation will erase all data stored in memory including clock, timer settings, tuner preset, and CD programme.

■ Condensation

Sudden temperature changes, storage or operation in an extremely humid environment may cause condensation inside the cabinet (CD pickup, tape heads, etc.) or on the transmitter on the remote control. Condensation can cause the unit to malfunction. If this happens, leave the power on with no disc (or cassette) in the unit until normal playback is possible (about 1 hour). Wipe off any condensation on the transmitter with a soft cloth before operating the unit.

Maintenance

■ Cleaning the CD pickup lens

Do not touch the laser pickup lens. If fingerprints or dust accumulate on the pickup, clean it gently with a dry cotton swab.



■ Cleaning the cabinet

Periodically wipe the cabinet with a soft cloth and a diluted soap solution, then with a dry cloth.

Caution:

- Do not use chemicals for cleaning (petrol, paint thinner, etc.). It may damage the cabinet finish.
- Do not apply oil to the inside of the unit. It may cause malfunctions.

■ Cleaning the tape-handling parts

- Dirty heads, capstan or pinch roller can cause poor sound and tape jams. Clean these parts with a cotton swab moistened with commercial head/pinch roller cleaner or isopropyl alcohol.
- When cleaning the heads, pinch roller, etc., unplug the unit which contains high voltages.

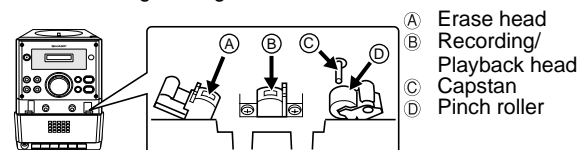

- After long use, the deck's heads and capstan may become magnetised, causing poor sound. Demagnetise these parts once every 30 hours of playing/recording time by using a commercial tape head demagnetiser. Read the demagnetiser's instructions carefully before use.

Specifications

XL-MP10H

As part of our policy of continuous improvement, SHARP reserves the right to make design and specification changes for product improvement without prior notice. The performance specification figures indicated are nominal values of production units. There may be some deviations from these values in individual units.

■ General

Power source	AC 230 - 240 V, 50 Hz
Power consumption	Power on: 25 W Power stand-by: 0.9 W
Dimensions	Width: 160 mm Height: 242 mm Depth: 250 mm
Weight	2.3 kg

■ Amplifier

Output power	RMS: 10 W (5 W + 5 W) (10 % T.H.D.)
Output terminals	Speakers: 4 ohms Headphones: 16 - 50 ohms (recommended: 32 ohms)

■ Tuner

Frequency range	FM: 87.5 - 108.0 MHz AM: 522 - 1,620 kHz
------------------------	---

■ CD player

Type	Compact disc player
Signal readout	Non-contact, 3-beam semiconductor laser pickup
D/A converter	1-bit D/A converter
Frequency response	20 - 20,000 Hz
Dynamic range	90 dB (1 kHz)

■ Cassette deck

Frequency response	125 - 8,000 Hz (normal tape)
Signal/noise ratio	50 dB (recording/playback)
Wow and flutter	0.3 % (WRMS)

■ Speaker

Type	10 cm full-range speaker
Maximum input power	10 W
Rated input power	5 W
Impedance	4 ohms
Dimensions	Width: 130 mm Height: 240 mm Depth: 161 mm
Weight	1.4 kg/each

MEMO

04/10/27 XL-MP10H(A)_MEMO.fm TINSEA036SJZZ

SHARP

FOR LOCATION ENQUIRIES WITHIN

AUSTRALIA

REGARDING YOUR LOCAL
SHARP APPROVED SERVICE CENTRE
VISIT OUR WEBSITE AT

www.sharp.net.au

OR CALL SHARP CUSTOMER CARE

1300 135 022

(LOCAL CALL COST APPLY WITHIN AUSTRALIA)

SHARP CORPORATION OF AUSTRALIA PTY LTD

SHARP

FOR LOCATION ENQUIRIES WITHIN

NEW ZEALAND

REGARDING YOUR LOCAL
SHARP APPROVED SERVICE CENTRE
VISIT OUR WEBSITE AT

www.sharp.net.nz

CONTACT YOUR SELLING DEALER/RETAILER
OR CALL

SHARP CUSTOMER SERVICES

TELEPHONE: 09 573 0111

FACSIMILE: 09 573 0113

SHARP CORPORATION OF NEW ZEALAND LIMITED

SPform019(JUNE 2004)

04/10/27 XL-MP10H(A)_WA.fm

TINSEA036SJZZ

SHARP

WARRANTY

Consumer Electronic Products

Congratulations on Your Purchase!

This Sharp product is warranted against faults in materials and manufacture for a period of twelve(12) months from the date of original purchase.

If service is required during the warranty period, please contact your nearest Sharp Approved Service Centre. These repairs would be carried out at no charge to the owner, subject to the conditions specified herein.

The owner is responsible for any transportation and insurance costs if the product has to be returned for repair.

This warranty does not extend to accessories or defects or injuries caused by or resulting from causes not attributable to faulty parts or the manufacture of the product, including but not limited to, defect or injury caused by or resulting from misuse, abuse, neglect, accidental damage, improper voltage, liquid spillage, vermin infestation, software, or any alterations made to the product which are not authorised by Sharp.

Please retain your sales documentation, as this should be produced to validate a warranty claim.

This warranty is in addition to and in no way limits, varies or excludes any express and implied rights and remedies under any relevant legislation in the country of sale.

IMPORTANT DO NOT RETURN THIS DOCUMENT TO SHARP

For your reference, please enter the particulars of your purchase below and retain, with your purchase documentation.

Model No. _____ Date of Purchase _____

Serial No. _____ Retailer _____

SHARP
SHARP CORPORATION OF AUSTRALIA PTY. LIMITED
1 Hurlingham Drive
Hurlingham NSW 2148
SHARP CORPORATION OF NEW ZEALAND LIMITED
59 Hargreaves Avenue
Perth, Auckland
©Sharp 2014 (JUNE 2009)

IMPORTANT NOTICE: This warranty applies only to products sold in Australia & New Zealand

SHARP

SHARP CORPORATION

TINSEA036SJZZ
04L N HK ①

04/10/13 XL-MP10H(A)_BACK.fm

TINSEA036SJZZ

Free Manuals Download Website

<http://myh66.com>

<http://usermanuals.us>

<http://www.somanuals.com>

<http://www.4manuals.cc>

<http://www.manual-lib.com>

<http://www.404manual.com>

<http://www.luxmanual.com>

<http://aubethermostatmanual.com>

Golf course search by state

<http://golfingnear.com>

Email search by domain

<http://emailbydomain.com>

Auto manuals search

<http://auto.somanuals.com>

TV manuals search

<http://tv.somanuals.com>