

SHARP



ENGLISH

Please refer to pages i to iv and E-1 to E-62.

FRANÇAIS

Se reporter aux pages i et iv F-1 à F-62.

1-BIT DIGITAL RECEIVER WITH DVD AMPLITUNER NUMÉRIQUE 1-BIT AVEC DVD

MODEL
MODÈLE

SD-PX2

OPERATION MANUAL
MODE D'EMPLOI

Thank you for purchasing this SHARP product. To obtain the best performance from this product, please read this manual carefully. It will guide you in operating your SHARP product.

Nous vous remercions d'avoir porté votre choix sur ce produit SHARP. Pour en tirer le meilleur parti, veuillez lire ce mode d'emploi très attentivement.



PROGRESSIVE SCAN



SPECIAL NOTES (for Users in the U.S.A.)



CAUTION
RISK OF ELECTRIC SHOCK
DO NOT OPEN



CAUTION: TO REDUCE THE RISK OF ELECTRIC SHOCK, DO NOT REMOVE COVER (OR BACK). NO USER-SERVICEABLE PARTS INSIDE. REFER SERVICING TO QUALIFIED SERVICE PERSONNEL.

Explanation of Graphical Symbols:



The lightning flash with arrowhead symbol, within an equilateral triangle, is intended to alert the user to the presence of uninsulated "dangerous voltage" within the product's enclosure that may be of sufficient magnitude to constitute a risk of electric shock to persons.



The exclamation point within an equilateral triangle is intended to alert the user to the presence of important operating and maintenance (servicing) instructions in the literature accompanying the appliance.

WARNING: TO REDUCE THE RISK OF FIRE OR ELECTRIC SHOCK, DO NOT EXPOSE THIS APPLIANCE TO RAIN OR MOISTURE.

Note to CATV system installer:

This reminder is provided to call the CATV system installer's attention to Article 820-40 of the National Electrical Code that provides guidelines for proper grounding and, in particular, specifies that the cable ground shall be connected to the grounding system of the building, as close to the point of cable entry as practical.

NOTE

This equipment has been tested and found to comply with the limits for a Class B digital device, pursuant to Part 15 of the FCC Rules. These limits are designed to provide reasonable protection against harmful interference in a residential installation. This equipment generates, uses, and can radiate radio frequency energy and, if not installed and used in accordance with the instructions, may cause harmful interference to radio communications. However, there is no guarantee that interference will not occur in a particular installation. If this equipment does cause harmful interference to radio or television reception, which can be determined by turning the equipment off and on, the user is encouraged to try to correct the interference by one or more of the following measures:

- Reorient or relocate the receiving antenna.
- Increase the separation between the equipment and receiver.
- Connect the equipment into an outlet on a circuit different from that to which the receiver is connected.
- Consult the dealer or an experienced radio/TV technician for help.

WARNING

FCC Regulations state that any unauthorized changes or modifications to this equipment not expressly approved by the manufacturer could void the user's authority to operate this equipment.

CAUTION:

THIS PRODUCT IS A CLASS 1 LASER PRODUCT. USE OF CONTROLS OR ADJUSTMENTS OR PERFORMANCE OF PROCEDURES OTHER THAN THOSE SPECIFIED HEREIN MAY RESULT IN HAZARDOUS RADIATION EXPOSURE. AS THE LASER BEAM USED IN THIS PRODUCT IS HARMFUL TO THE EYES, DO NOT ATTEMPT TO DISASSEMBLE THE CABINET. REFER SERVICING TO QUALIFIED PERSONNEL ONLY.

FOR YOUR RECORDS

For your assistance in reporting this unit in case of loss or theft, please record below the model number and serial number which are located on the rear of the unit.

Please retain this information.

Model number

Serial number

Date of purchase

Place of purchase

IMPORTANT SAFETY INSTRUCTIONS (for Users in the U.S.A.)

- 1 Read Instructions** - All the safety and operating instructions should be read before the product is operated.
- 2 Retain Instructions** - The safety and operating instructions should be retained for future reference.
- 3 Heed Warnings** - All warnings on the product and in the operating instructions should be adhered to.
- 4 Follow Instructions** - All operating and use instructions should be followed.
- 5 Cleaning** - Unplug this product from the wall outlet before cleaning. Do not use liquid cleaners or aerosol cleaners. Use a damp cloth for cleaning.
- 6 Attachments** - Do not use attachments not recommended by the product manufacturer as they may cause hazards.
- 7 Water and Moisture** - Do not use this product near water - for example, near a bath tub, wash bowl, kitchen sink, or laundry tub; in a wet basement; or near a swimming pool; and the like.
- 8 Accessories** - Do not place this product on an unstable cart, stand, tripod, bracket, or table. The product may fall, causing serious injury to a child or adult, and serious damage to the product. Use only with a cart, stand, tripod, bracket, or table recommended by the manufacturer, or sold with the product. Any mounting of the product should follow the manufacturer's instructions, and should use a mounting accessory recommended by the manufacturer.
- 9** A product and cart combination should be moved with care. Quick stops, excessive force, and uneven surfaces may cause the product and cart combination to overturn.



- 10 Ventilation** - Slots and openings in the cabinet are provided for ventilation and to ensure reliable operation of the product and to protect it from overheating, and these openings must not be blocked or covered. The openings should never be blocked by placing the product on a bed, sofa, rug, or other similar surface. This product should not be placed in a built-in installation such as a bookcase or rack unless proper ventilation is provided or the manufacturer's instructions have been adhered to.
- 11 Power Sources** - This product should be operated only from the type of power source indicated on the marking label. If you are not sure of the type of power supply to your home, consult your product dealer or local power company. For products intended to operate from battery power, or other sources, refer to the operating instructions.
- 12 Grounding or Polarization** - This product may be equipped with a polarized alternating-current line plug (a plug having one blade wider than the other). This plug will fit into the power outlet only one way. This is a safety feature. If you are unable to insert the plug fully into the outlet, try reversing the plug. If the plug should still fail to fit, contact your electrician to replace your obsolete outlet. Do not defeat the safety purpose of the polarized plug.
Alternate Warnings - This product is equipped with a three-wire grounding-type plug, a plug having a third (grounding) pin. This plug will only fit into a grounding-type power outlet. This is a safety feature. If you are unable to insert the plug into the outlet, contact your electrician to replace your obsolete outlet. Do not defeat the safety purpose of the grounding-type plug.
- 13 Power-Cord Protection** - Power-supply cords should be routed so that they are not likely to be walked on or pinched by items placed upon or against them, paying particular attention to cords at plugs, convenience receptacles, and the point where they exit from the product.
- 14 Protective Attachment Plug** - The product is equipped with an attachment plug having overload protection. This is a safety feature. See Instruction Manual for replacement or resetting of protective device. If replacement of the plug is required, be sure the service technician has used a replacement plug specified by the manufacturer that has the same overload protection as the original plug.

IMPORTANT SAFETY INSTRUCTIONS (for Users in the U.S.A.) (continued)

15 Outdoor Antenna Grounding - If an outside antenna or cable system is connected to the product, be sure the antenna or cable system is grounded so as to provide some protection against voltage surges and built-up static charges. Article 810 of the National Electrical Code, ANSI/NFPA 70, provides information with regard to proper grounding of the mast and supporting structure, grounding of the lead-in wire to an antenna discharge unit, size of grounding conductors, location of antenna-discharge unit, connection to grounding electrodes, and requirements for the grounding electrode.

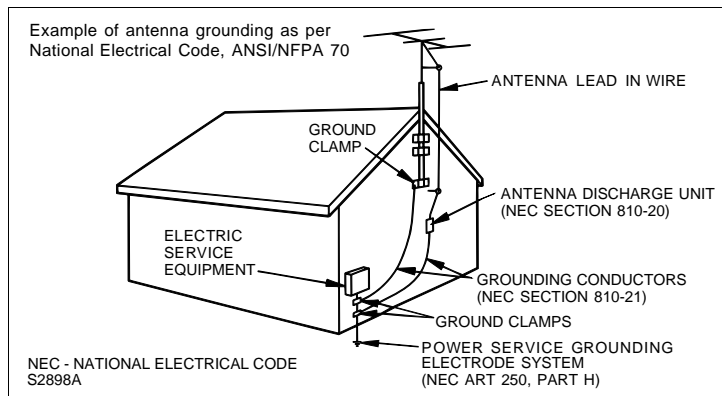

16 Lightning - For added protection for this product during a lightning storm, or when it is left unattended and unused for long periods of time, unplug it from the wall outlet and disconnect the antenna or cable system. This will prevent damage to the product due to lightning and power-line surges.

17 Power Lines - An outside antenna system should not be located in the vicinity of overhead power lines or other electric light or power circuits, or where it can fall into such power lines or circuits. When installing an outside antenna system, extreme care should be taken to keep from touching such power lines or circuits as contact with them might be fatal.

18 Overloading - Do not overload wall outlets, extension cords, or integral convenience receptacles as this can result in a risk of fire or electric shock.

19 Object and Liquid Entry - Never push objects of any kind into this product through openings as they may touch dangerous voltage points or short-out parts that could result in a fire or electric shock. Never spill liquid of any kind on the product.

20 Servicing - Do not attempt to service this product yourself as opening or removing covers may expose you to dangerous voltage or other hazards. Refer all servicing to qualified service personnel.

21 Damage Requiring Service - Unplug this product from the wall outlet and refer servicing to qualified service personnel under the following conditions:

- When the power-supply cord or plug is damaged,
- If liquid has been spilled, or objects have fallen into the product,
- If the product has been exposed to rain or water,
- If the product does not operate normally by following the operating instructions. Adjust only those controls that are covered by the operating instructions as an improper adjustment of other controls may result in damage and will often require extensive work by a qualified technician to restore the product to its normal operation,
- If the product has been dropped or damaged in any way, and
- When the product exhibits a distinct change in performance - this indicates a need for service.

22 Replacement Parts - When replacement parts are required, be sure the service technician has used replacement parts specified by the manufacturer or have the same characteristics as the original part. Unauthorized substitutions may result in fire, electric shock, or other hazards.

23 Safety Check - Upon completion of any service or repairs to this product, ask the service technician to perform safety checks to determine that the product is in proper operating condition.

24 Wall or Ceiling Mounting - The product should be mounted to a wall or ceiling only as recommended by the manufacturer.

25 Heat - The product should be situated away from heat sources such as radiators, heat registers, stoves, or other products (including amplifiers) that produce heat.

SPECIAL NOTES REMARQUES SPÉCIALES

"DTS" and "DTS Digital Surround" are registered trademarks of Digital Theater Systems, Inc.

"DTS" et "DTS Digital Surround" sont des marques déposées de Digital Theater Systems, Inc.

Manufactured under license from Dolby Laboratories. "Dolby", "Pro Logic" and the double-D symbol are trademarks of Dolby Laboratories.

Fabriqué sous licence de Dolby Laboratories. "Dolby", "Pro Logic" et le symbole double D sont des marques de commerce de Dolby Laboratories.

NOTE

Licensed under one or more of U.S. Pat. 4,972,484, 5,214,678, 5,323,396, 5,530,655, 5,539,829, 5,544,247, 5,606,618, 5,610,985, 5,740,317, 5,777,992, 5,878,080 or 5,960,037.

ENERGY STAR® Program Information



Products that have earned the ENERGY STAR® are designed to protect the environment through superior energy efficiency.

ENERGY STAR® is a U.S. registered mark.

Contents

	Page		Page
> General Information		Various settings	
Accessories	2	Brightening the image (Gamma correction)	26
Optional accessory	2	Sharpening the image (Super picture)	26
Precautions	3	To change the display on TV screen	27
Controls and indicators	4 - 7	To change the display on the unit	27
Description of discs	8, 9	Switching elapsed time	28
		Switching playing time	28
		To change the setting on the playback control screen	28
> Preparation for Use		Playing a DVD-Audio disc	29
System installation	10	> SACD and CD Operation	
Speaker connection	11, 12	Playing an SACD disc	
Antenna connection	12	Playing hybrid SACD sound	30
TV connection	13	To play in random order (random play)	31
Remote control	14	Playing an MP3 disc	32
AC power connection	14	> Radio Operation	
Setting the clock	15	Listening to the radio	33
General control	16	Listening to the memorized station	34
> DVD Operation		> Advanced Features	
Playing a disc	17, 18	Enjoying surround sound (sound mode)	35 - 38
Basic operation		Changing the initial setting of DVD	39 - 42
To locate the beginning of a chapter (track) (skip)	19	Changing the default settings of the amplifier	43 - 46
Fast forward/Fast reverse (search)	19	Timer playback	47
To start playback from the desired point (direct play)	20	Setting the timer	47, 48
Useful operation		Operations after setting the timer	49
To play in the desired order (programmed play)	21	Sleep timer	50
To play repeatedly (repeat play)	22	Operating the connected TV	51, 52
To play the contents between the specified points repeatedly (A-B repeat)	22	Mounting the unit on the wall	53, 54
Still picture/Frame advance	23	Connecting other equipment	55 - 57
Slow-motion play	23	> References	
Resume play	23	Maintenance	58
To change the angle	24	Error indicators and warnings	58
To zoom images (zoom)	24	Troubleshooting chart	59, 60
To select a title from the top menu of the disc	25	Language code list for disc language	61
To select a subtitle or audio language from the disc menu	25	Specifications	62
To change the subtitle language	25		
To change the audio language (audio output)	26		

Accessories

Please confirm that the following accessories are included.

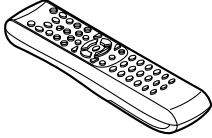
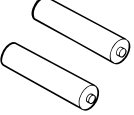
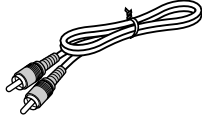
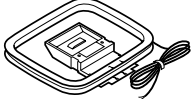
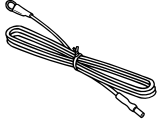
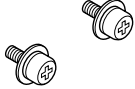
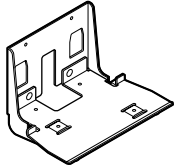
 <p>Remote control × 1 (RRMCGA003AWSA)</p>	 <p>"AA" size battery (UM/SUM-3, R6, HP-7 or similar) × 2 (UBATU0001AWZZ)</p>
 <p>Video cable × 1 (QCNWG0045AWZZ)</p>	 <p>AM loop antenna × 1 (QANTL0012AWZZ)</p>
 <p>FM antenna × 1 (92LFANT1535A)</p>	 <p>Screw [1/8" (4 mm) in diameter × 3/8" (8 mm)] × 2 (XBPSN40P08KS0)</p>
 <p>Main unit bracket × 1 (GDAI-A003AWPA)</p>	

Note:
Only the above accessories are included.

Optional accessory

Use only the specified optional accessory to operate this product properly.

OPTICAL DIGITAL CABLE
Model: AD-M3DC



Copyright Information:

- Unauthorized copying, broadcast, public display, transmission, public performance and rental (regardless of whether or not such activities are for profit) of disc contents are prohibited by law.
- This system is equipped with copy protection technology that causes substantial degradation of images when the contents of a disc are copied to a video tape.

Copy Protection:
This unit supports Macrovision copy protection. On DVD discs that include a copy protection code, if the contents of the DVD disc are copied using a VCR, the copy protection code prevents the videotape copy from playing normally.

Apparatus Claims of U.S. Patent Nos. 4,631,603, 4,577,216, 4,819,098, and 4,907,093, licensed for limited viewing uses only.

This product incorporates copyright protection technology that is protected by method claims of certain U.S. patents and other intellectual property rights owned by Macrovision Corporation and other rights owners. Use of this copyright protection technology must be authorized by Macrovision Corporation, and is intended for home and other limited viewing uses only unless otherwise authorized by Macrovision Corporation. Reverse engineering or disassembly is prohibited.

Precautions

ENGLISH

> General

- Please ensure that the equipment is positioned in a well-ventilated area and that there is at least 4" (10 cm) of free space along the sides and back. There must also be a minimum of 6" (15 cm) of free space on the top of the unit.

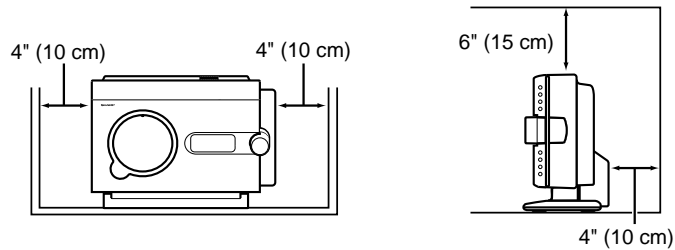

- Use the unit on a firm, level surface free from vibration.

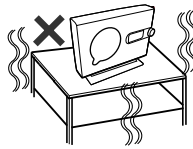

- Keep the unit away from direct sunlight, strong magnetic fields, excessive dust, humidity and electronic/electrical equipment (home computers, facsimiles, etc.) which generate electrical noise.



- Do not place anything on top of the unit.
- Do not expose the unit to moisture, to temperatures higher than 140°F (60°C) or to extremely low temperatures.

- If the unit does not work properly, unplug and plug it in again. Then turn on the unit.
- In case of an electrical storm, unplug the unit for safety.

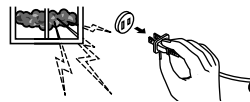

- Hold the AC power plug by the head when removing it from the AC outlet, as pulling the cord can damage internal wires.

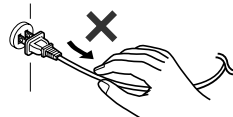

- Do not remove the outer cover, as this may result in electric shock. Refer internal service to your local SHARP service facility.

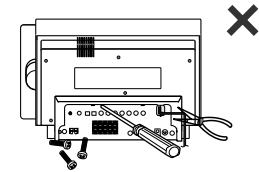

- This unit should only be used within the range of 41°F - 95°F (5°C - 35°C).

Warning:

The voltage used must be the same as that specified by this unit. Using this product with a higher voltage other than that specified is dangerous and may result in a fire or other types of accident, causing damage. SHARP will not be held responsible for any damage resulting from the use of this unit with a voltage other than that specified.

> Volume control

The sound level at a given volume setting depends on speaker efficiency, location and various other factors. It is advisable to avoid exposure to high volume levels, which occurs while turning the unit on with the volume control setting up high, or while continually listening at high volumes.

> Care of DVD/SACD/CD discs

DVD/SACD/CD discs are fairly resistant to damage, however mistracking can occur due to an accumulation of dirt on the disc surface. Follow the guidelines below for maximum enjoyment from your DVD/SACD/CD collection and player.

- Do not write on either side of the disc, particularly the non-label side from which signals are read. Do not mark this surface.
- Keep your discs away from direct sunlight, heat, and excessive moisture.
- Always hold the DVD/SACD/CDs by the edges. Fingerprints, dirt, or water on the DVD/SACD/CDs can cause noise or mistracking. If a DVD/SACD/CD is dirty or does not play properly, clean it with a soft, dry cloth, wiping straight out from the center, along the radius.

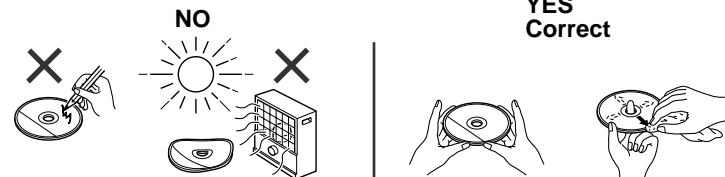

Controls and indicators

> Main unit (front panel)

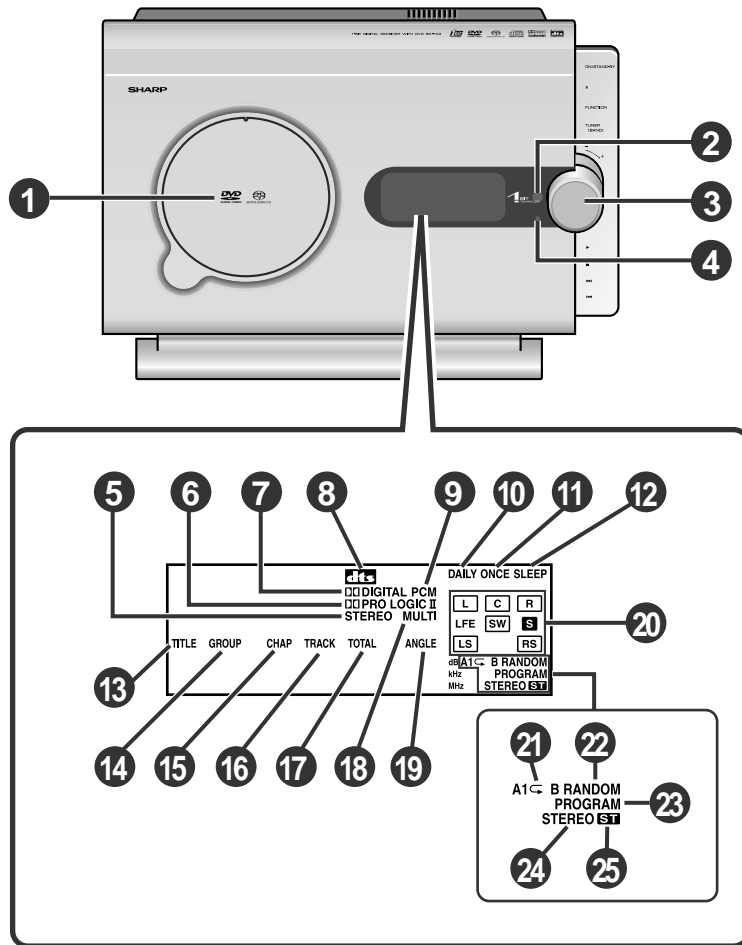

	Reference page
1. Sliding Door	17
2. Remote Sensor	14
3. Volume Control	16
4. Timer Set Indicator	49
5. SACD/DVD-AUDIO Stereo Indicator	30
6. Dolby Pro Logic II Indicator	35
7. Dolby Digital Signal Indicator	35
8. DTS Signal Indicator	35
9. PCM Signal Indicator	35
10. Daily Timer Indicator	49
11. Once Timer Indicator	49
12. Sleep Indicator	50
13. Title Indicator	27
14. Group Indicator	27
15. Chapter Indicator	27
16. Track Indicator	27
17. Total Indicator	28
18. SACD/DVD-AUDIO Multi Indicator	30
19. Angle Indicator	24
20. Audio Signal/Speaker Indicators	36
21. Repeat/One Track Repeat/A-B Repeat Indicator	22
22. Random Play Indicator	31
23. Program Indicator	33
24. FM Stereo Mode Indicator	33
25. FM Stereo Receiving Indicator	33

Controls and indicators (continued)

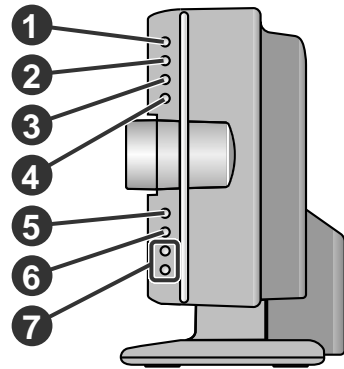

> Main unit (right side panel)

	Reference page
1. On/Stand-by Button	.14, 60
2. Sliding Door Open/Close Button	.17
3. Function Button	.56
4. Tuner (Band) Button	.33
5. Disc Play Button	.17
6. Disc Stop Button	.17, 18
7. Chapter (track) Skip Up and Down Buttons	.19, 33

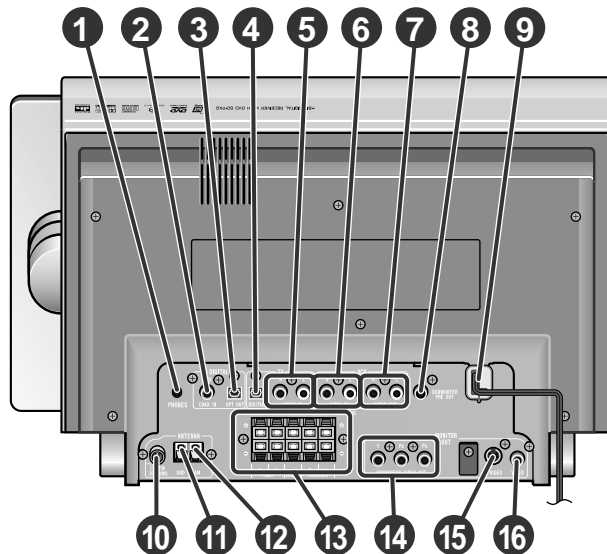

> Main unit (rear panel)

1. Headphone Jack	.55
2. Coaxial Digital Audio Input Jack	.55
3. Optical Digital Audio Output Jack	.57
4. Optical Digital Audio TV Input Jack	.55
5. Audio TV Input Jacks	.55
6. Audio VCR Input Jacks	.55
7. Audio VCR Output Jacks	.55
8. Subwoofer Pre Output Jack	.55
(Connect a subwoofer with a built-in amplifier.)	
9. AC Power Cord	.14
10. FM 75 Ohm Antenna Jack	.12
11. Antenna Ground Terminal	.12
12. AM Antenna Terminal	.12
13. Speaker Terminals	.11
14. Component Video Output Jacks	.13
15. S-video Output Jack	.13
16. Video Output Jack	.13

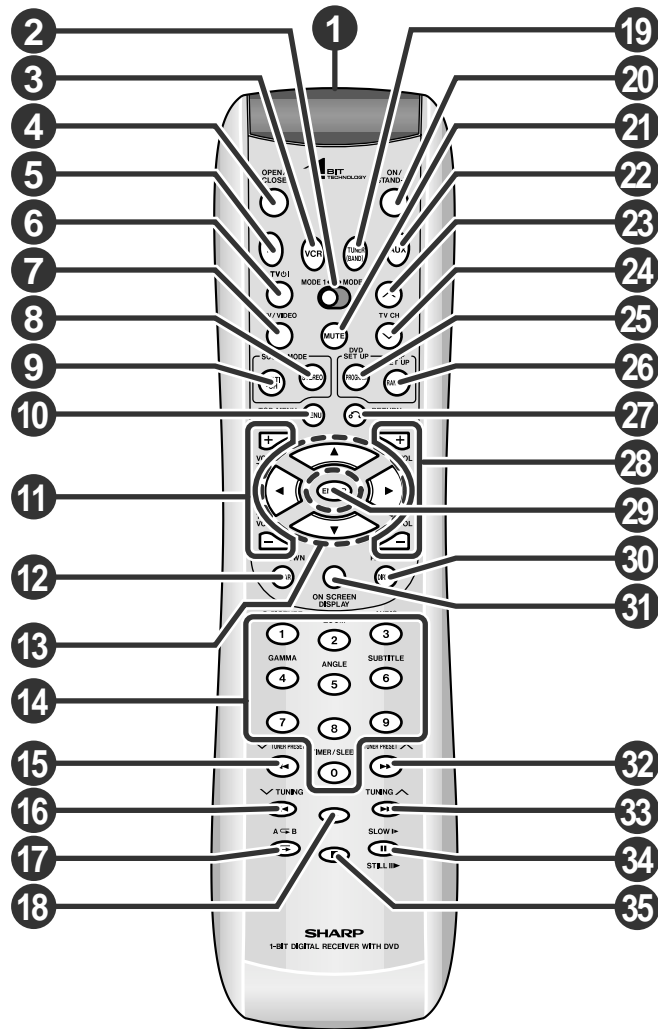

> Remote control

	Reference page
1. Remote Control Transmitter	14
2. MODE 1/MODE 2 Switch	7
3. VCR Button	56
4. Sliding Door Open/Close Button	17
5. TV Button	56
6. TV On/Stand-by Button	51
7. TV/Video Select Button	51
8. Stereo (2 channel) Select Button	38
9. Multi Channel Select Button	37
10. Menu Button	25
11. TV Volume Up and Down Buttons	51
12. Clear Button	21
13. Cursor Buttons	15
14. Direct Number Buttons	20
15. Fast Reverse or Preset Down Button	19, 34
16. Chapter (track) Skip Down or Tuning Down Button	19, 33
17. Repeat Play Button	22
18. Disc Play Button	17
19. Tuner (Band) Button	33
20. On/Stand-by Button	14
21. Mute Button	16
22. Auxiliary Button	56
23. TV Channel Up Button	51
24. TV Channel Down Button	51
25. Program Button	21
26. Random Play Button	31
27. Return Button	20
28. Volume Up and Down Buttons	16
29. Enter Button	15
30. Direct Button	20
31. Unit Display Select Button	16, 27
32. Fast Forward or Preset Up Button	19, 34
33. Chapter (track) Skip Up or Tuning Up Button	19, 33
34. DVD Frame Advance, Disc Pause Button	18, 23
35. Disc Stop Button	17, 18

Controls and indicators (continued)

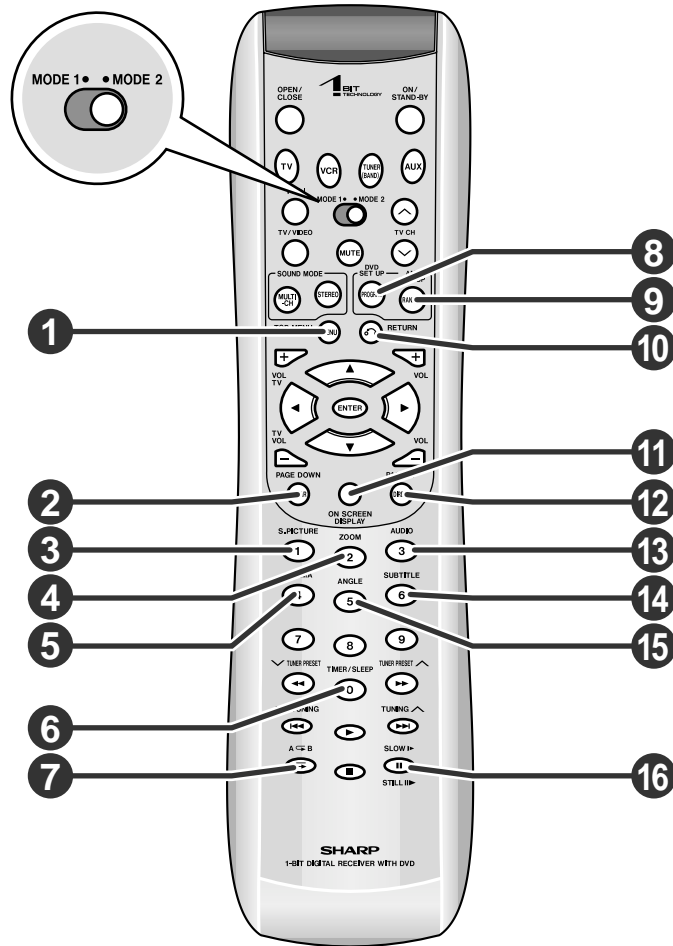

> Remote control

Set the MODE 1/MODE 2 switch to MODE 2 and press the following buttons (indicated in blue). Available operations change.

	Reference page
1. DVD Top Menu Button	.25
2. DVD Page Down Button	.29
3. DVD Super Picture Button	.26
4. DVD Zoom Button	.24
5. DVD Gamma Button	.26
6. Timer/Sleep Button	.15, 48
7. A - B Repeat Button	.22
8. DVD Setup Button	.28, 39
9. Amplifier Setup Button	.43
10. Return Button	.28
11. On-Screen Display Button	.27
12. DVD Page Up Button	.29
13. DVD Audio Language or CD Audio Output Select Button	.26
14. DVD Subtitle Button	.25
15. DVD Angle Button	.24
16. DVD Slow Button	.23





Notes:

- * In "MODE 2", you can use buttons other than the above for the same operations as in "MODE 1".
- * After operations in "MODE 2", switch to "MODE 1".

Description of discs



> Types of playable discs

The unit can play back discs bearing any of the following marks:

DVD	
DVD-Video Disc for NTSC system 	DVD-Audio Disc for NTSC system 
DVD-R for NTSC system 	DVD-RW for NTSC system 
Recorded in the video mode (*)	Recorded in the video mode (*)

Some DVD discs may not function as described in the manual. See the disc jacket for restrictions.

SACD
 SUPER AUDIO CD

CD		
Audio CD 	Audio CD-R  Or CD-R recorded in MP3 format (*)	Audio CD-RW  Or CD-RW recorded in MP3 format (*)

(*) Some discs may not play properly due to the status of the equipment used for recording, characteristics of the discs, scratches, dirt, or dirty optical pickup lens.

> DVD-Video

A popular type of DVD disc of the same size as a CD, mainly containing video images.

Region number

DVD discs are programmed with region numbers indicating countries in which they can be played. This system can play discs with region number "1" or "ALL".

Region number
(playable area number)



Title and chapter

DVD-Video discs are divided into "titles" and "chapters". If the disc has more than one movie on it, each movie is a separate "title". "Chapters" are subdivisions of titles.

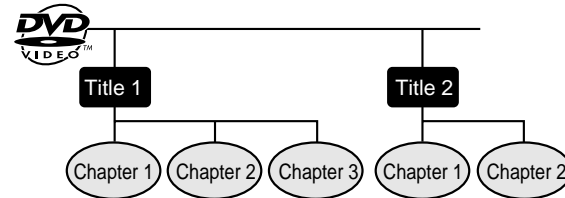

> DVD-Audio

Whereas DVD-Videos mainly contain video images, DVD-Audios mostly contain high-quality sound data. Its recording capacity is seven times as much as a CD. Its physical structure is the same as DVD-Videos, but largely differs in data and directory structures. It consists of the audio zone, which is the main part, and the video zone, which records video images.

Group and track

A DVD-Audio disc consists of "groups" and "tracks". Groups are equivalent to albums containing multiple songs. Tracks are the individual songs within a group.

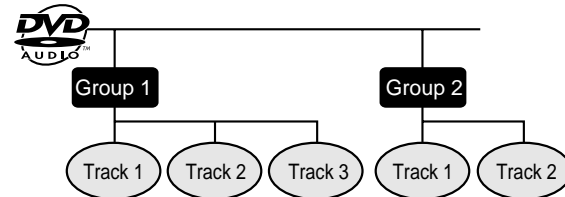

Description of discs (continued)

> DVD-R/DVD-RW playback

- You can play DVD-R and DVD-RW discs recorded in the video mode.
- Before playing DVD-R/DVD-RW discs with this unit, finalize them with the equipment used for recording.**

> SACD (Super Audio CD)

An SACD is a high-quality audio disc, capable of recording seven times as much data as a CD. There are three types of SACD: single layer, dual layer and hybrid. Hybrid disc contains both SACD and CD structures. Some SACD discs contain multi channel audio recordings.

Track

SACD and music CD are composed of "tracks". Tracks are equivalent to songs on a CD.

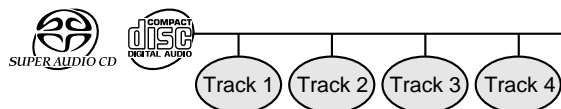

> MP3 format on CD-R/CD-RW

An MP3 file is an audio data compressed in the MPEG 1 audio layer 3 format. MP3 files have the extension ".mp3". (Files with the extension ".mp3" may not play, or noise may occur during playback if not recorded in the MP3 format.)





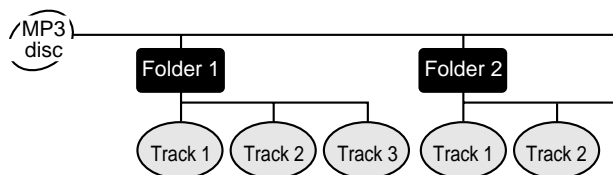

Folder and track

MP3 discs consist of "folders" and "tracks".



> Icons used on DVD discs

Check the icons of the DVD jacket before playing your discs.

Display	Description
Format recorded on the DVD   	To adopt the video format to the connected TVs ("wide-screen TV" or "4:3 size TV").
Type of subtitles recorded  Example: 1: English 2: Japanese	Recorded subtitle languages. You can select a subtitle language.
Number of camera angles 	Number of angles recorded on the DVD. You can view scenes from different angles.
Number of audio tracks and audio recording systems  Example: 1: Original <English> (Dolby Digital 5.1 Surround) 2: Japanese (Dolby Digital 2 ch)	The number of audio tracks and audio recording systems are indicated. <ul style="list-style-type: none"> You can change the audio language. Audio and recording system vary depending on the DVD. Check them in the DVD's manual.

> Discs that cannot be played

- DVDs without the region number "1" or "ALL".
 - DVDs with PAL system
 - DVDs with SECAM system
 - DVDs with MPEG sound
 - DVD-ROM
 - DVD-RAM
 - CDG
 - Video CD
 - Photo CD
 - CD-ROM
 - Discs recorded in special formats, etc.
- The discs above cannot be played at all, or no sound is heard although images appear on the screen or vice versa.
- Faulty playback may damage the speakers and can have an adverse effect on your hearing when played at high volume settings.
- This DVD player adopts the NTSC system. Discs that were made in foreign countries may not be played back. Check the recording system before purchasing discs.**
- You cannot play illegally produced discs.

System installation

SD-PX2

ENGLISH

> Placing the speaker system

The best surround effect will be achieved by placing each speaker at the same distance from the listening position.

It is recommended to arrange the speakers as shown below.

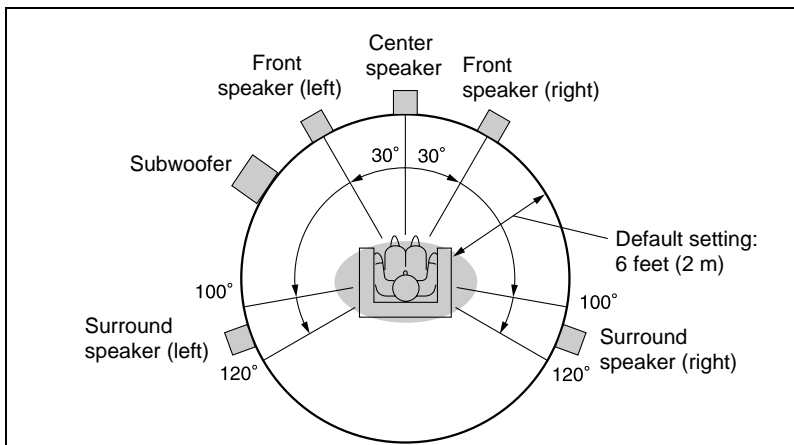

Note:

The default distance is set to 6 feet (2 m). If speakers cannot be placed at equal distances, refer to "Speaker delay setting" (see page 44).

Installation image:

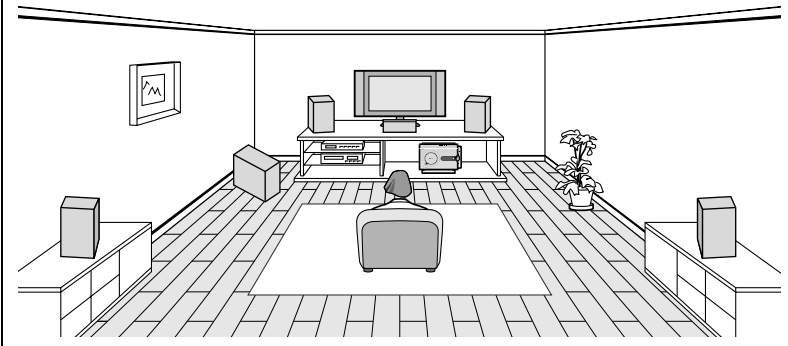

Notes:

- Place the TV halfway between the front speakers.
- It is recommended that the center speaker be placed near the television.
- Place the surround speakers at a position just above the height of your ears.
- The subwoofer vibrates while reproducing bass. Place it on a stable, sturdy surface.
- The subwoofer reproduces bass. Place it anywhere you like.

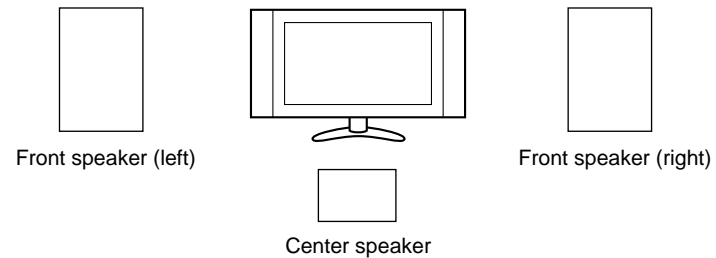

> Cooling fan

This unit is fitted with a cooling fan at the rear for improved cooling. Do not cover the opening in this section with any obstacles.

Cooling fan

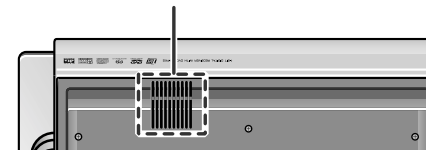

Caution:

- The unit will get warm while being used. Do not touch the warm areas of the unit for prolonged periods to avoid damage to you.
- Protect the amplifier unit from damage. When it is activated, the sound switch is turned off. In this case, set the unit to the stand-by mode and turn on again.

Preparation for Use
- System installation -

Speaker connection

ENGLISH

Make sure to leave the AC power cord disconnected when connecting the speakers.

See page 10 for placing the speakers.

To enjoy the high-quality sound of DVD-Audio or SACD discs, it is recommended to connect speakers with a wide frequency range.

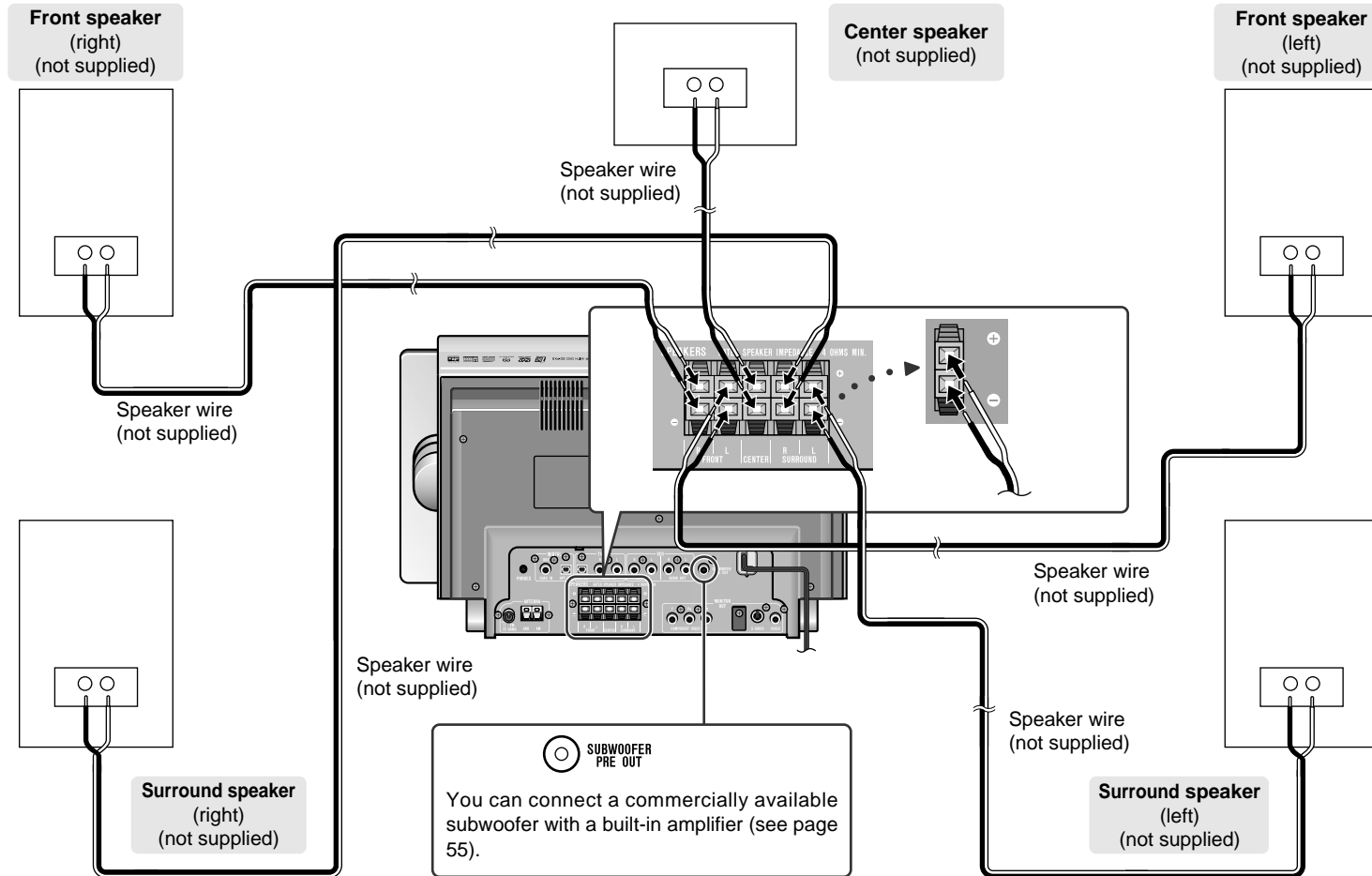

Preparation for Use
- Speaker connection -

> Connecting speaker wires

- Make sure to leave the AC power cord disconnected when connecting the speakers.
- Connect the speaker wires to the speakers first, then to the unit.

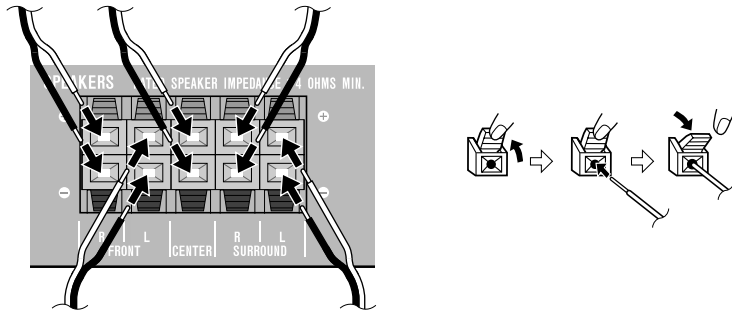

Caution:

- Use a speaker system which has 35 W or more rated power input and 4 ohm impedance.
- If the volume is turned up too high with the speakers of less than 4 ohm impedance connected, the protection circuit of the amplifier is activated. No sound is produced temporarily.
- Do not mistake the \oplus and \ominus , and right and left terminals of the speaker wires. (The right speaker is placed on the right when you face the unit.)
- Do not short-circuit the speaker wire. If it happens with the power on, the protection circuit is activated and the unit is set to the power stand-by mode. In this case, check that the speaker wire is connected correctly before turning on the power again.

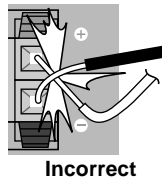

- When the center and surround speakers and subwoofer are not connected, set the speaker size to "C-NO", "S-NO" and "SW-NO". Otherwise, the protection circuit may be activated and the power is turned off.

Antenna connection

Supplied FM antenna:

Connect the FM antenna wire to the FM 75 OHMS jack and position the FM antenna wire in the direction where the strongest signal can be received.

Supplied AM loop antenna:

Connect the AM loop antenna wire to the AM and GND terminals. Position the AM loop antenna for optimum reception. Place the AM loop antenna on a shelf, etc., or attach it to a stand or a wall with screws (not supplied).

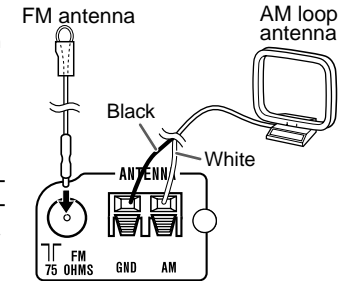

Note:

Placing the antenna on the unit or near the AC power cord may cause noise pickup. Place the antenna away from the unit for better reception.

Installing the AM loop antenna:

< Assembling >

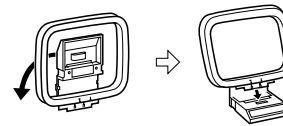

< Attaching to the wall >

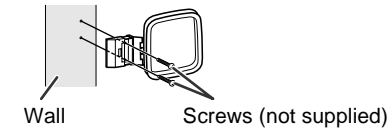

Outdoor FM or AM antenna:

Use an outdoor FM or AM antenna if you require better reception. Consult your dealer.

When using an outdoor AM antenna, be sure to keep the wire of the AM loop antenna connected.

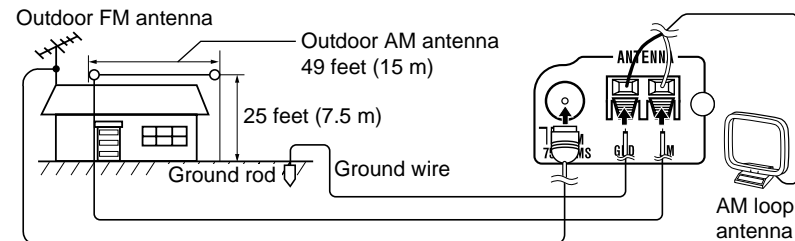

TV connection

ENGLISH

Unplug all equipment before making any connections.

Connect a TV with the supplied video cable.

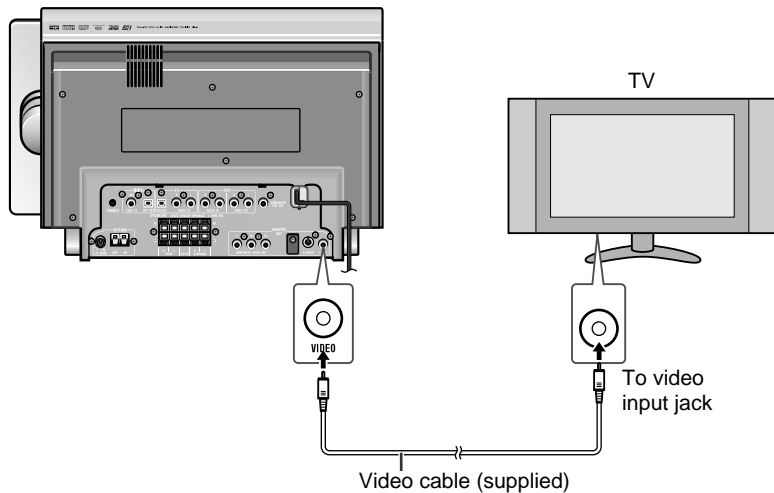

Notes:

- Change the TV input in accordance with the connected jack.
- Do not connect other equipment between the TV and this unit. If they are connected via a VCR, pictures may be distorted.
- Using the audio cable, you can listen to the TV sound with this unit.

If your TV is equipped with an S-video input jack or component video input jacks, purchase an appropriate cable to enjoy higher quality images. When you use a TV supporting progressive scan, open the initial setting screen and set "PROGRESSIVE OUT" to "ON" in "TV MODE" (see page 41).

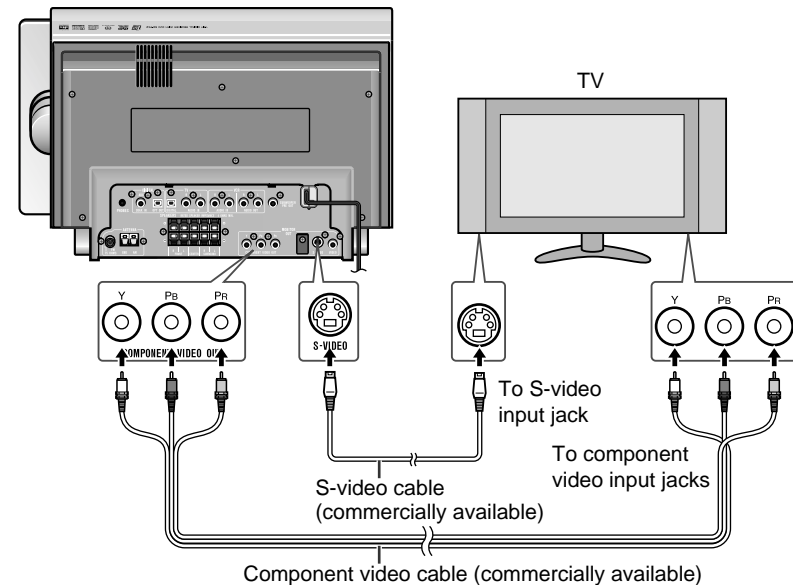

Notes:

- Change the TV input in accordance with the connected jack.
- Do not connect other equipment between the TV and this unit. If they are connected via a VCR, pictures may be distorted.
- Using the audio cable, you can listen to the TV sound with this unit.
- If your TV has different indications for the component video inputs (Y, CB and CR or Y, B-Y and P-Y), connect jacks with its matching color.
- Do not connect to a component video input jack designed for the high-vision system, which is not DVD-compatible (the images may be distorted or not appear).
- Use a video cable, S-video cable or component video cable to connect the unit to a TV.

Remote control

> Battery installation

- 1 Open the battery cover.
- 2 Insert the supplied batteries according to the direction indicated in the battery compartment.

When inserting or removing the batteries, push them toward the \ominus battery terminals.

- 3 Close the cover.

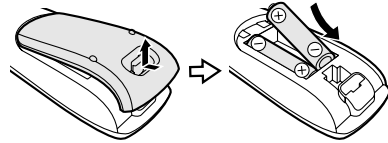

Precautions for battery use:

- Replace all old batteries with new ones at the same time.
- Do not mix old and new batteries.
- Remove the batteries if the unit will not be used for long periods of time. This will prevent potential damage due to battery leakage.

Caution:

- Do not use rechargeable batteries (nickel-cadmium battery, etc.).
- Installing the batteries incorrectly may cause the unit to malfunction.

Notes concerning use:

- Replace the batteries if the operating distance is reduced or if the operation becomes erratic. Purchase 2 "AA" size batteries (UM/SUM-3, R6, HP-7 or similar).
- Periodically clean the transmitter on the remote control and the sensor on the unit with a soft cloth.
- Exposing the sensor on the unit to strong light may interfere with operation. Change the lighting or the direction of the unit.
- Keep the remote control away from moisture, heat, shock, and vibrations.

> Test of the remote control

Point the remote control directly at the remote sensor on the unit.

The remote control can be used within the range shown on the right:

Press the ON/STAND-BY button. Does the power turn on? Now, you can enjoy your system.

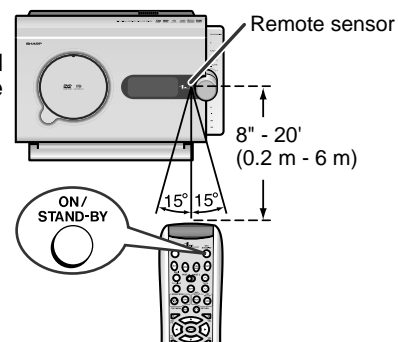

AC power connection

> Connecting the AC power cord

After checking all the connections have been made correctly, plug the AC power cord of this unit into the AC outlet.

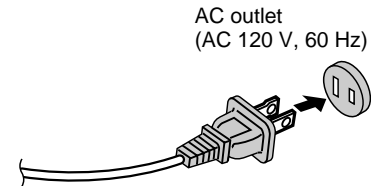

Note:

Unplug the AC power cord from the AC outlet if the unit will not be in use for a prolonged period of time.

CAUTION:

TO PREVENT ELECTRIC SHOCK, MATCH WIDE BLADE OF PLUG TO WIDE SLOT, FULLY INSERT.

> To turn the power on

Press the ON/STAND-BY button.

If the power does not turn on, check if the power cords are plugged in properly.

To set the unit to stand-by mode:

Press the ON/STAND-BY button again.

Notes:

- After the unit enters the power stand-by mode, wait a few seconds to turn on again.
- You can also use the ON/STAND-BY button on the remote control.

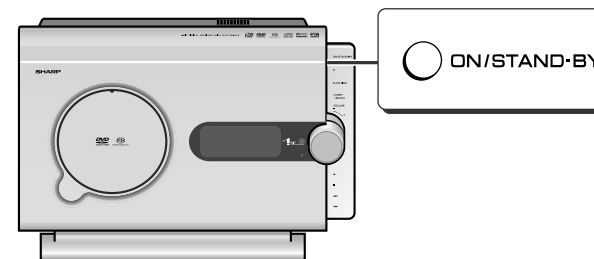

Setting the clock

ENGLISH

Preparation for Use
- Setting the clock -

By setting the unit to the correct time, you can use it not only as a clock but also for timer playback.

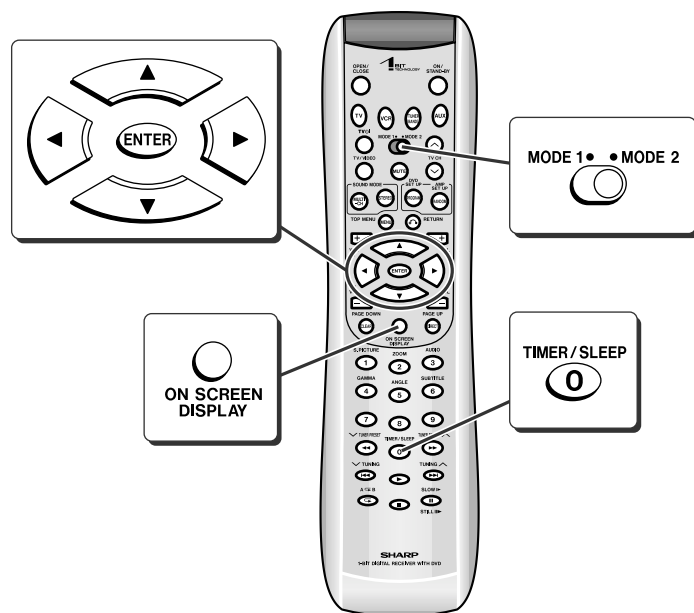

In this example, the clock is set to 9:30 AM.

1 Turn on the power, set the MODE 1/MODE 2 switch to MODE 2 and press the TIMER/SLEEP button.

2 Within 10 seconds, press the ▲ or ▼ button to select "CLOCK ADJUST", and then press the ENTER button.

CLOCK
ADJUST

3 Press the ◀ or ▶ button to adjust the hour and then press the ENTER button.

CLOCK
9:00 AM

- Press the ◀ or ▶ button once to advance the time by 1 hour. Hold it down to advance continuously.
- The 12-hour display will appear.
- "AM" will change to "PM" automatically.

4 Press the ◀ or ▶ button to adjust the minutes and then press the ENTER button.

CLOCK
9:30 AM

- Press the ◀ or ▶ button once to advance the time by 1 minute. Hold it down to advance continuously.
- The hour will not advance even if minutes advance from "59" to "00".
- The clock starts from "0" second (seconds are not displayed).
- The time disappears after approx. 2 seconds.

To confirm the time display:

[When the unit is in the stand-by mode]

Set the MODE 1/MODE 2 switch to MODE 1 and press the DISPLAY button. The time display will appear for about 5 seconds.

[When the power is on]

Set the MODE 1/MODE 2 switch to MODE 2 and press the TIMER/SLEEP button. Within 10 seconds, press the ▲ or ▼ button to select "CLOCK". The time display will appear for about 10 seconds.

To readjust the clock:

- Perform "Setting the clock" from the beginning.
- In step 2, the time will be displayed.
 - Follow steps 3 - 4.

Note:

Unplugging the unit or power failure will clear the clock setting. Readjust the clock.

General control

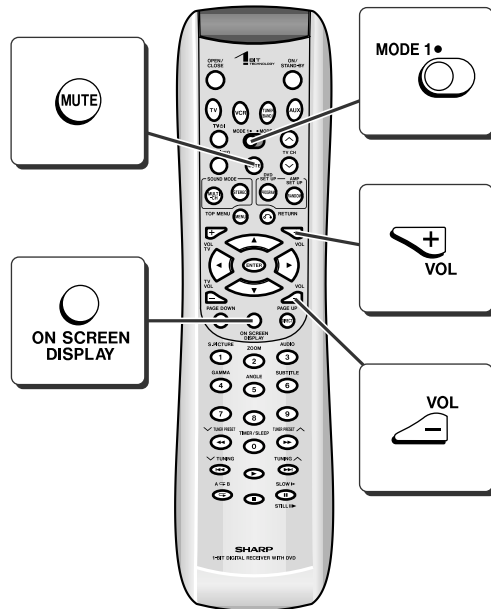
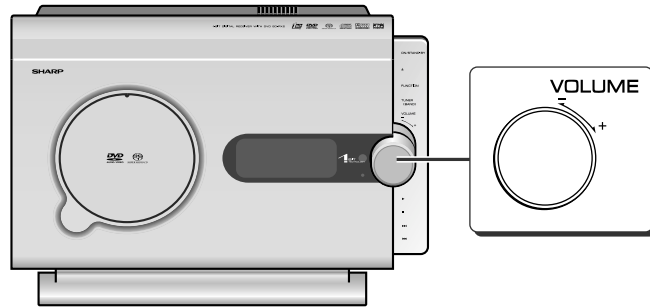

> Volume control

Main unit operation:

When the VOLUME control is turned clockwise, the volume will increase. When it is turned counterclockwise, the volume will decrease.



Remote control operation:

Press the VOL + button to increase the volume and the VOL - button for decreasing.

0 ↔ 1 ↔ 2 38 ↔ 39 ↔ 40

> Muting

The volume is muted temporarily when pressing the MUTE button on the remote control.

- Press again to restore the volume.
- The mute status is canceled when you adjust the volume.



> To change the display brightness (2 levels)

Set the MODE 1/MODE 2 switch to MODE 1 and hold down the DISPLAY button for 3 seconds or more.

Each time you press, brightness changes.

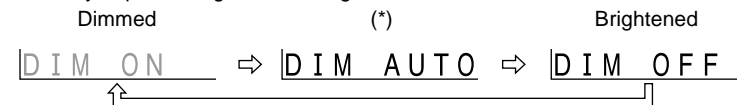

(*) After approx. 5 seconds of DVD-Video playback, the display dims and the original brightness returns when you stop playback. The brightness remains unchanged during playback of other media.

Note:

The blue light on the right side of the volume control goes out when the display dims with "DIM ON" or "DIM AUTO".

Playing a disc

ENGLISH

DVD Operation
- Playing a disc -

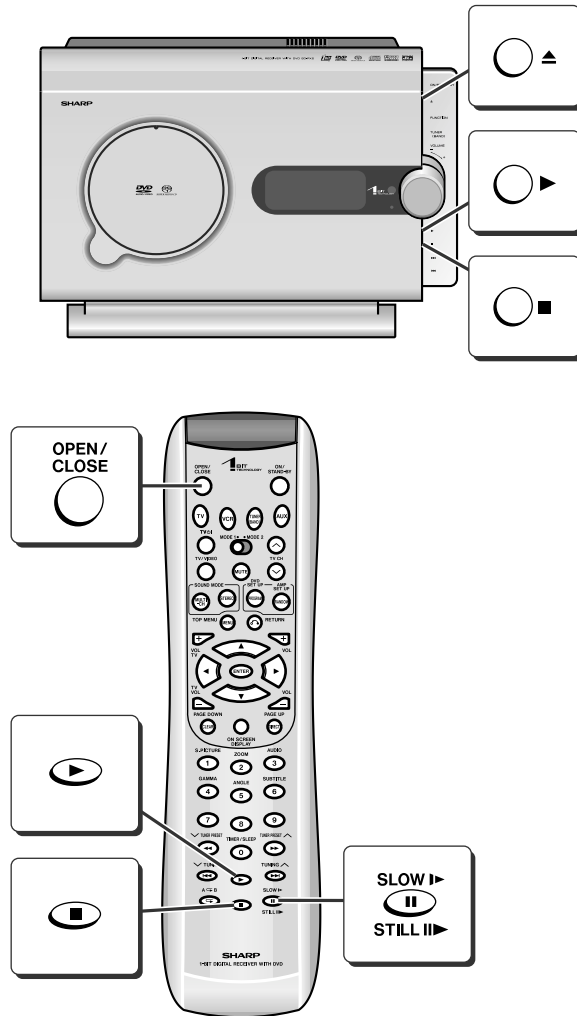

Volume control (See page 16).

> Playback DVD SACD CD

- For a wide-screen TV, set the video output to 16:9 (see page 40).
- Turn on the TV, and switch the input to the "VIDEO 1", "VIDEO 2", etc. accordingly.

- 1 Turn on the power and press the ■ button to set the input to "DVD".

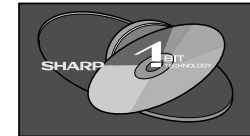

You can also use the ■ button on the main unit.

- 2 Press the OPEN/CLOSE button to open the sliding door.

The sliding door closes after approx. 2 minutes of inactivity.

- 3 Insert a disc.

To avoid damage, insert the disc carefully.

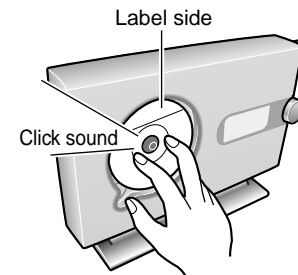

- 4 Press the OPEN/CLOSE button to close the sliding door.



Some discs play automatically.



- 5 If you cannot start playback in step 4, press the ▶ button.

When you press the ▶ button with the sliding door open, it closes and playback starts.

You can also use the ▲ or ▶ button on the main unit.

Operations during disc playback			
Action	Remote control	Main unit	Operation
To stop playback			When you press once, "RESUME" appears. Press again to enter the stop mode. While "RESUME" appears, press the ► button. Playback resumes from the point where it was stopped. (Resume play: See page 23.)
To pause playback		Not available	Press during playback. In the pause mode, press the ► button. Playback resumes from the point where it was paused.

Removing discs:

- 1 Stop playback and press the OPEN/CLOSE button.
- 2 Press the eject button to remove the disc.
- 3 Press the OPEN/CLOSE button to close the sliding door.

If you turn off the power with the sliding door open, the door closes.

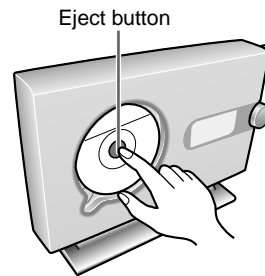
**Caution:**

Do not touch the sliding door while it is moving, and be careful not to pinch your fingers.

Notes:

- Some DVD discs may not function as described in the manual. See the disc jacket for restrictions.
- During an operation, "⊘" may appear indicating that the operation is disabled by the disc.
- Some DVD-R/DVD-RW/CD-R/CD-RW may not play properly due to the status of the disc or equipment used for recording. Change the recording speed or disc. For more details, see the manual for the equipment.
- When you turn on the power or switch the input to "DVD", initialization starts and operation is not possible for a few seconds.
- Sound may skip at high volume depending on the disc. In this case, turn down the volume.
- Do not insert more than one disc. Discs may be damaged.
- A disc with scratches or fingerprints may not play properly. Refer to "Care of DVD/SACD/CD discs (page 3)" and clean the disc.
- Do not play the discs of special shapes (heart or octagon shaped) as they can be ejected while rotating and cause injury.



An error message appears on TV or the unit when you try to play the following discs (see page 58):

- Scratched discs
- Unplayable discs
- The region number is neither 1 nor ALL.
- Discs supporting parental control (*)

(*) Some DVDs support parental control which restricts viewing according to the age (see page 41).

Icons used in this operation manual

Some functions may not be available depending on discs. The following icons indicate the discs that can be used in the section.

-  ... DVD-Videos and DVD-Audios.
-  ... Super Audio CDs.
-  ... Audio CDs and CD-R/CD-RW with MP3 recording.

Basic operation

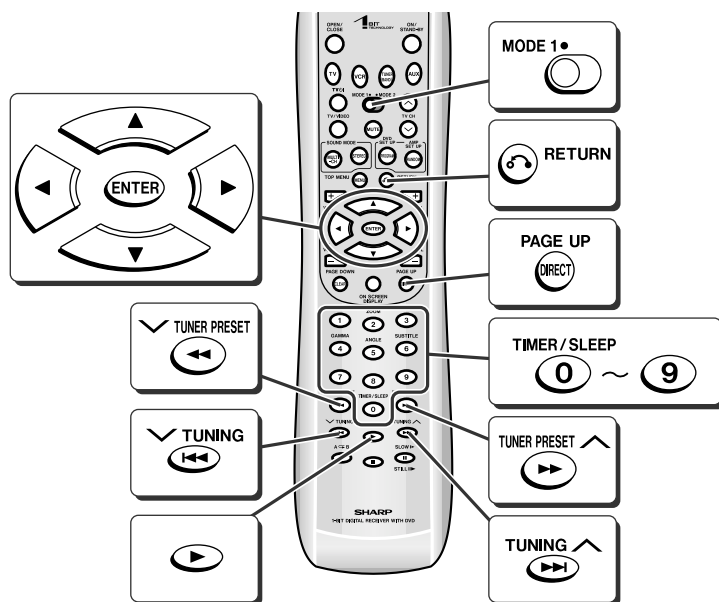

> To locate the beginning of a chapter (track) (skip) DVD SACD CD

You can move to other chapter (track) with simple operations.

While a disc is playing, press the **◀◀** or **▶▶** button.

- Press the **▶▶** button to skip to the next chapter (track).
- Press the **◀◀** button to skip to the beginning of the current chapter (track). Press the **◀◀** button again to skip to the beginning of the previous chapter (track).
- The same operation can be performed by pressing the **◀◀** or **▶▶** button on the main unit.

Notes:

- Some discs do not display the chapter (track) and the skip feature is disabled.
- On a DVD, the skip function may not be available between titles (groups).

> Fast forward/Fast reverse (search)

DVD SACD CD

You can search the desired point as you play the disc.

1 While a disc is playing, press the **◀◀** or **▶▶** button.

Example: When the **▶▶** button is pressed

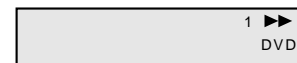

2 Press the **◀◀** or **▶▶** button repeatedly to select a search speed.

1 (about × 2 times) → 2 (about × 8 times) → 3 (about × 32 times)



- The disc is forwarded by the **▶▶** button and reversed by the **◀◀** button.
- The same operation can be performed by holding down the **◀◀** or **▶▶** button on the main unit for 2 seconds or more.

Press the **▶** button to return to normal playback.

Notes:

- On some discs, the search function is disabled.
- The search function is not possible across titles (groups).
- During fast forward, subtitles appear and sound is heard only at the search speed 1 (about × 2 times). Sound is not heard on SACD discs.
- Depending on the disc or scene, the search speed may differ from that in this manual.

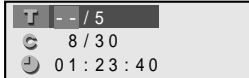
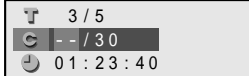
> To start playback from the desired point (direct play) DVD SACD CD

1 During playback, set the MODE 1/MODE 2 switch to MODE 1.	
2 Selecting a title of DVD: Press the DIRECT button.	TV screen 
Selecting a chapter of DVD: Press the DIRECT button twice.	
Selecting a track on SACD/CD discs: Press the DIRECT button.	Unit display 
3 Within 10 seconds, enter a number with the direct number buttons (0 - 9) and press the ENTER button.	
<ul style="list-style-type: none"> • To correct the number, enter again. • To cancel, press the RETURN ⏪ button. • Instead of the direct number buttons (0 - 9), you can use the ▲ or ▼ button. 	

How to specify:

Example:



To select chapter 12: Press 1, 2, and the ENTER button.

Notes:

- Direct play feature is disabled on some discs.
- Some DVD discs may not display the chapter number.
- During programmed play, this operation is not available.
- On DVD-Audio discs, groups and tracks are played directly instead of titles and chapters.

To play by specifying time (time search):

You can play back from the desired point by specifying the time.

1 During playback, set the MODE 1/MODE 2 switch to MODE 1.	
2 DVD: Press the DIRECT button three times.	TV screen 
SACD (CD): Press the DIRECT button twice.	Unit display 
3 Within 10 seconds, enter a number with the direct number buttons (0 - 9) and press the ENTER button.	
<ul style="list-style-type: none"> • To specify 1 hour 23 minutes and 40 seconds, enter "012340". • To correct the number, enter again. • To cancel, press the RETURN ⏪ button. • When you use the ▲ or ▼ button instead of the direct number buttons (0 - 9), press the ◀ or ▶ to switch among hour, minute and second. • For DVD-Video discs, specify the elapsed time of the title. • For DVD-Audio, SACD, CD discs specify the elapsed time of the track. 	

Notes:

- Time search is not possible across titles (tracks).
- On DVD-Audio discs, time search is not possible across tracks.
- Some discs cannot play from the specified point.
- Time search feature is disabled on some discs.
- During programmed play, this operation is not available.
- For MP3 discs, time search is not available.
- Some discs contain time portions you cannot specify.

Useful operation

ENGLISH

DVD Operation
- Useful operation -

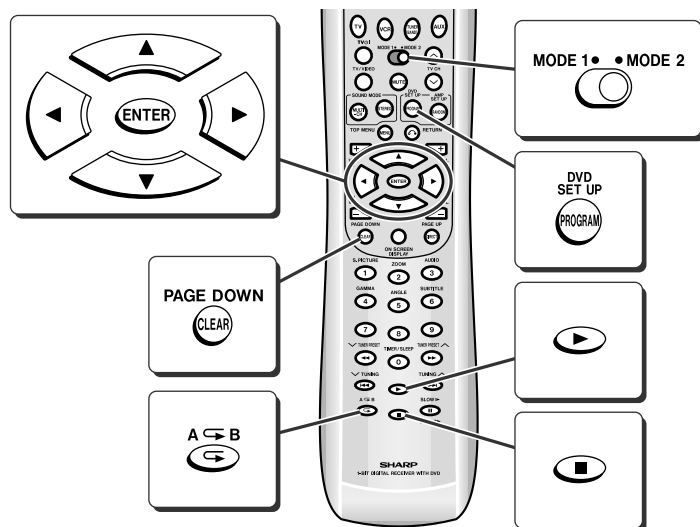

▶ To play in the desired order (programmed play) DVD SACD CD

You can play chapters (tracks) in the desired order within a title (group). 24 chapters can be programmed (programmed play). Titles (groups) cannot be programmed.

1 In the stop mode, set the MODE 1/MODE 2 switch to MODE 1 and press the PROGRAM button.

Example: DVD

The programming screen is displayed.

To program tracks on SACD/CD discs, go to step 3.

DVD-VIDEO PROGRAM	
TITLE	
T : 1	
T : 2	

2 Select a title number with the ▲ or ▼ button and press the ENTER button.

The chapter selection screen appears.

DVD-VIDEO PROGRAM	
TITLE	
T : 1	
T : 2	

Cursor

3 Use the ▲ or ▼ button to select a chapter (track) number, and press the ENTER button.

DVD-VIDEO PROGRAM		
T	:	T
C	1	1: C 1
C	2	2: C
C	3	3: C
C	4	4: C
C	5	5: C
C	6	6: C

- The number is saved in the confirmation area.
- Repeat the operation to program another number.
- To correct, press the ► button to move the cursor to the confirmation area, select the chapter (track) number with the ▲ or ▼ button, and press the CLEAR button. After deleting the number, press the ◀ button to return the cursor to the selection area.

4 Press the ► button to start playback.

- The unit stops after playing the chapters (tracks) in the programmed order.
- The programmed contents will be stored until the disc is removed.

To add numbers to the program:

Repeat steps 1 and 3.

Additional chapter (track) numbers are added immediately after the chapter (track) already programmed.

To delete all numbers in the program:

- 1 In the stop mode, press the PROGRAM button.
- 2 Press the ► button to move the cursor to the confirmation area.
- 3 Press the CLEAR button for 4 seconds or more.

To cancel the operation:

Press the PROGRAM button.

To repeat the disc using programmed play:

Press the PROGRAM button, and then press the ► button. Programmed play is canceled when playback stops.

Notes:

- Programming cannot be performed while paused or in the playback mode.
- Programmed play is prohibited on some discs.
- Chapters in other titles cannot be programmed together.
- For programmed play on DVD-Audio discs, select groups or tracks.
- For an MP3 disc, programmed play is not available.

> To play repeatedly (repeat play) DVD SACD CD

You can play a chapter (track) or a title (group) repeatedly by specifying it during playback.

- 1 During playback, set the MODE 1/MODE 2 switch to MODE 1 and press the **C** button.

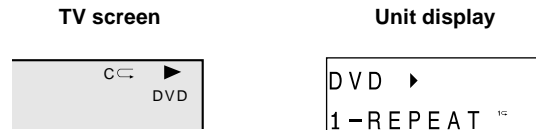

Each time the button is pressed, the repeat play mode changes in the following order.

The repeat play mode changes as follows on DVD:

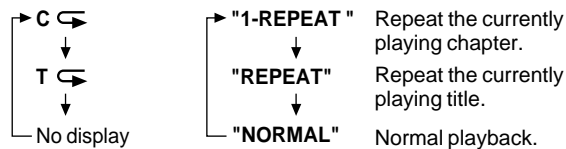

The repeat play mode changes as follows on SACD/CD:

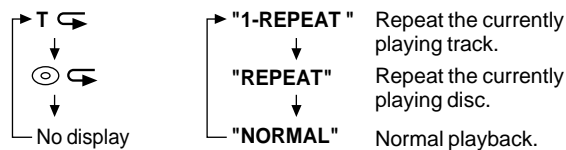

On DVD-Audio discs, the mode switches as follows: T (track), G (group), no display (normal playback).

- 2 To return to normal playback, press the **C** button repeatedly to select "NORMAL".

Caution:

After performing repeat play, be sure to press the **■** button. Otherwise, the disc will play continuously.

Notes:

- On some discs, the repeat play function is disabled.
- To repeat SACD/CD programmed play, perform repeat play during playback.
- If you press the RANDOM button, the current SACD/CD repeat play is canceled and switched to random play.
- During DVD programmed play, repeat play is not available.
- When you press the **■** button, the current repeat play of DVD, it is canceled.

> To play the contents between the specified points repeatedly (A-B repeat) DVD SACD CD

You can play the desired portion repeatedly by specifying it during playback.

- 1 During playback, set the MODE 1/MODE 2 switch to MODE 2 and press the **A** **C** **B** button.

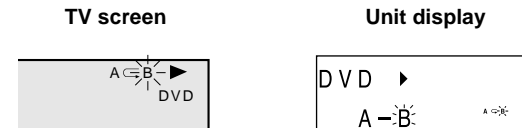

The start point (A) is created.

- 2 Press the **A** **C** **B** button again to enter the end point (B).



A-B repeat starts from the start point (A) to the end point (B).

- 3 Press the **A** **C** **B** button to return to normal playback.

Notes:

- A-B repeat play is disabled on some discs.
- A-B repeat play for DVD-Video is possible only within a title.
- A-B repeat play for DVD-Audio/SACD/CD is possible only within a track.
- Some scenes on DVD may not allow A-B repeat play.
- During programmed play, A-B repeat play is not available.
- When you press the **■** button, the current A-B repeat play is canceled.
- For MP3 discs, A-B repeat play is not available.
- An end point (B) is created when playback of the title (track) ends.

Useful operation (continued)

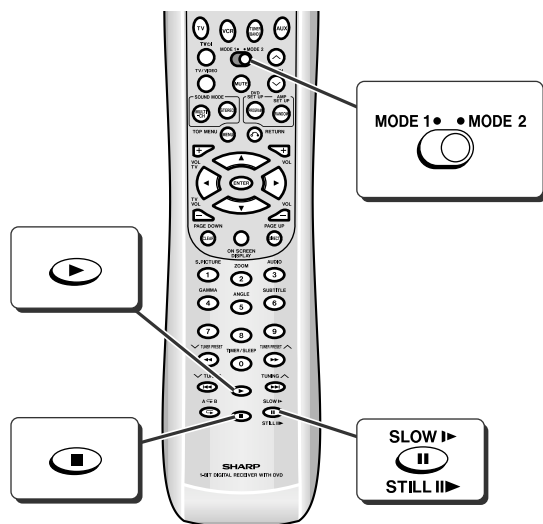

> Still picture/Frame advance DVD

You can freeze the image and advance frame by frame.

- 1** During playback, set the MODE 1/MODE 2 switch to MODE 1 and press the STILL ► button.
A still picture appears.
- 2** Press the STILL ► button during still picture playback.
Each press of the STILL ► button advances the frame.
- 3** Press the ► button to return to normal playback.

Notes:

- Still picture and frame advance features are disabled on some discs.
- Frame advance is not available on DVD-Audio discs.

> Slow-motion play DVD

You can slow down the playback speed.

- 1** During playback, set the MODE 1/MODE 2 switch to MODE 2 and press the SLOW ► button. 
- 2** Press the SLOW ► button repeatedly to select a playback speed.

1 (about × 1/2 times) → 2 (about × 1/8 times) → 3 (about × 1/16 times)
- 3** Press the ► button to return to normal playback.

Notes:

- On some discs, the slow-motion playback functions are disabled.
- Slow-motion play is not available on DVD-Audio discs.

> Resume play DVD SACD CD

You can resume playback from the point where it was stopped.

- 1** While the disc is playing, press the ■ button. 
The system stores the point.
- 2** To resume playback, press the ► button.
Play resumes from the point.

To cancel resume play:

Press the ■ button while "RESUME" is displayed.

Notes:

- The resume play feature is disabled on some discs.
- Depending on the disc, playback may resume from slightly before the stopped position.
- For MP3 discs, resume play is not available.

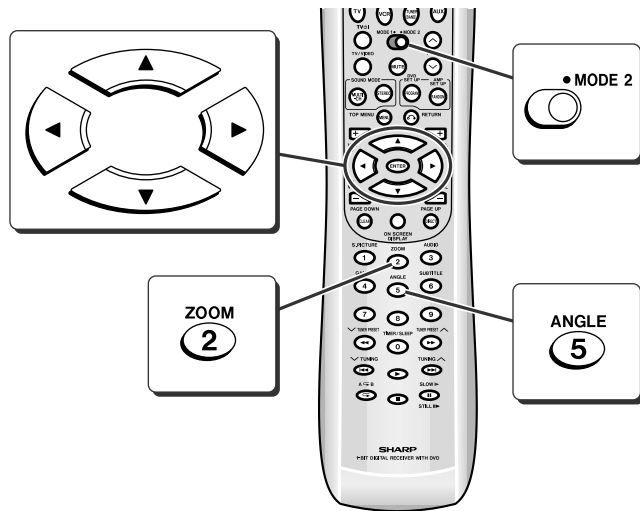

> To change the angle DVD

You can change the angle of view when playing a DVD disc that contains scenes recorded from multiple angles.

- 1 When "ANGLE" appears on the unit display during playback, set the MODE 1/MODE 2 switch to MODE 2 and press the ANGLE button.

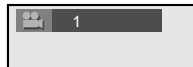

- 2 Use the ANGLE button to select an angle number.

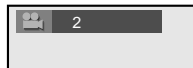

Each time you press, the angle changes.

Notes:

- Some DVDs prohibit changing the angle.
- The angle number is not displayed if there is no other angle recorded. "XX" is displayed instead.
- Refer to the manual of the disc as the operation may vary depending on the disc.

> To zoom images (zoom) DVD

You can magnify images during playback.

- 1 In the pause mode or during playback, set the MODE 1/MODE 2 switch to MODE 2 and press the ZOOM button.

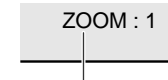

ZOOM indicator

Pressing the button cycles through the zoom settings as follows:

ZOOM: 1 (× 1.2) → ZOOM: 2 (× 1.5) → ZOOM: 3 (× 2.0) → Off (The indicator goes out.).

- 2 To shift the view and display the desired part of a zoomed image, press the ▲, ▼, ◀ or ▶ button repeatedly.

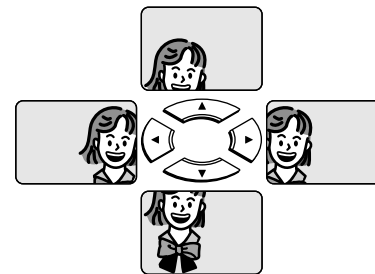

To return to normal view:

Press the ZOOM button repeatedly to select "Off" (the indicator goes out). When you cancel the zoom function, you cannot shift the view.

Notes:

- An image may become distorted when zoomed.
- Subtitles cannot be zoomed.
- When the zoom indicator changes from white to red while shifting the image, you cannot shift it any further.

Useful operation (continued)

ENGLISH

DVD Operation
- Useful operation -

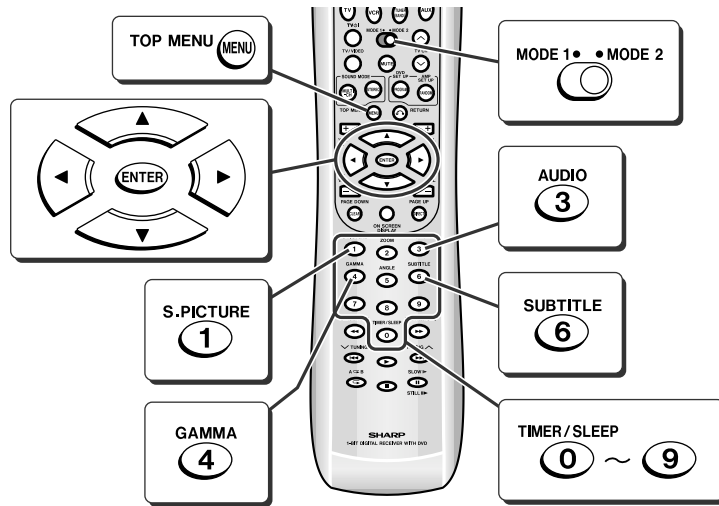

> To select a title from the top menu of the disc DVD

On a DVD with multiple titles, you can select a title from the top menu.

1 In the stop mode or during playback, set the MODE 1/MODE 2 switch to MODE 2 and press the TOP MENU button.	Example <table border="1" style="margin: auto;"> <tr> <td style="padding: 2px;">1 Drama</td> <td style="padding: 2px;">2 Action</td> </tr> <tr> <td style="padding: 2px;">3 SF</td> <td style="padding: 2px;">4 Comedy</td> </tr> </table>	1 Drama	2 Action	3 SF	4 Comedy
1 Drama	2 Action				
3 SF	4 Comedy				
2 Use the ▲, ▼, ◀, or ▶ button to select the title, and then press the ENTER button.					
<ul style="list-style-type: none"> • The selected title is played. • You can also use the direct number buttons for some discs. 					

Notes:

- The procedure shown here provides only general steps. The actual procedure for using the disc menu depends on the disc you are using. See the disc jacket for details.
- On DVD-Audio discs, select a group instead of title.
- During programmed play, setting is not possible on the top menu.

> To select a subtitle or audio language from the disc menu DVD

You can select the desired subtitle/audio language and sound system [Dolby Digital (5.1 ch) or DTS sound] on your DVD if it has a disc menu.

1 In the stop mode or during playback, set the MODE 1/MODE 2 switch to MODE 1 and press the MENU button.	Example <table border="1" style="margin: auto;"> <tr> <td style="padding: 2px;">Menu</td> </tr> <tr> <td style="padding: 2px;">1.Highlights</td> </tr> <tr> <td style="padding: 2px;">2.Start Movie</td> </tr> </table>	Menu	1.Highlights	2.Start Movie
Menu				
1.Highlights				
2.Start Movie				
2 Press the ▲, ▼, ◀ or ▶ button to select a subtitle/audio language and press the ENTER button.				
You can also use the direct number buttons for some discs.				

Notes:

- The procedure shown here provides only general steps. The actual procedure for using the disc menu depends on the disc you are using. See the disc jacket for details.
- During programmed play, setting is not possible on the disc menu.

> To change the subtitle language DVD

You can change the subtitle language or hide subtitles during playback.

1 During playback, set the MODE 1/MODE 2 switch to MODE 2 and press the SUBTITLE button.	Example <table border="1" style="margin: auto;"> <tr> <td style="padding: 2px;">1 ENGLISH</td> </tr> </table>	1 ENGLISH													
1 ENGLISH															
2 Press the SUBTITLE button repeatedly to select the subtitle language.															
<ul style="list-style-type: none"> • You can select one of the subtitle languages that are recorded on a DVD. 															
<table style="margin: auto; text-align: center;"> <tr> <td>ENGLISH</td> <td>→</td> <td>FRENCH</td> <td>→</td> <td>...</td> <td>→</td> <td>SPANISH</td> </tr> <tr> <td colspan="7">↑</td> </tr> </table>	ENGLISH	→	FRENCH	→	...	→	SPANISH	↑							
ENGLISH	→	FRENCH	→	...	→	SPANISH									
↑															
<ul style="list-style-type: none"> • To hide subtitles on the screen, press the ◀ or ▶ button to select "OFF". 															

Notes:

- The subtitle language on some DVDs may not be changed.
- If no subtitles are recorded on the disc, "XX" is displayed.
- It may take a little time to switch the subtitle language to the selected one.
- When you set the unit to the stand-by mode or replace the disc, settings return to the default.

> To change the audio language (audio output)

During playback, you can change the audio language (audio output).

1 During playback, set the MODE 1/MODE 2 switch to MODE 2 and press the AUDIO button.

2 Press the AUDIO button repeatedly to select the audio language (audio output).



Each time you press, audio language (audio output) changes.

Example:

 1: Original <English> (Dolby Digital 5.1 Surround)

 2: Original <English> (DTS 5.1 Surround)

 3: Japanese (Dolby Digital 2 ch)

Notes:

- The audio language on some DVDs may not be changed.
- For available audio languages (audio outputs), see the disc jacket.
- When you switch the audio language (audio output) during DVD-Audio playback, the unit may return to the beginning of the track. In this case, it takes longer to switch the language.
- During CD playback, the audio output switches as follows: "L + R", "L", "R".
- When you set the unit to the stand-by mode or replace the disc, settings return to the default.
- For MP3 discs, you cannot change the audio output.

Various settings

> Brightening the image (Gamma correction)

1 During playback, set the MODE 1/ MODE 2 switch to MODE 2 and press the GAMMA button to select "ON".



"ON" and "OFF" will be switched with each press of this button.

2 Within 10 seconds, press the ◀ or ▶ button to set the level.



Level	Setting	Level	Setting
OFF	Normal	ON ▶▶▶	Brighter
ON ▶▶▶	Slightly brighter	ON ▶▶▶▶	A lot brighter

To restore the original brightness:

In step 1, select "OFF".

> Sharpening the image (Super picture)

1 During playback, set the MODE 1/ MODE 2 switch to MODE 2 and press the S.PICTURE button to select "ON".



"ON" and "OFF" will be switched with each press of this button.

2 Within 10 seconds, press the ◀ or ▶ button to set the level.



Level	Setting	Level	Setting
OFF	Normal	ON ◀▶▶▶▶	A lot clearer
ON ◀▶▶▶▶	Slightly clearer	ON ◀▶▶▶▶▶	Soft
ON ◀▶▶▶▶	Clearer		

To restore the original image quality:

In step 1, select "OFF".

Various settings (continued)

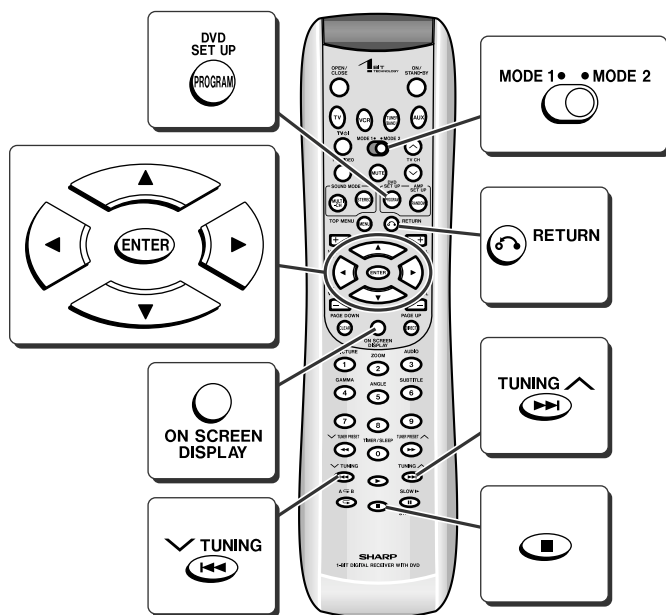

> To change the display on TV screen

DVD SACD CD

During playback, set the MODE 1/MODE 2 switch to MODE 2 and press the ON SCREEN button.

Each time you press, the display changes.

Example: DVD

Always displayed Not displayed Displayed for approx. 3 seconds

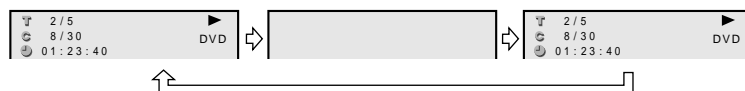

> To change the display on the unit **DVD**

During playback, set the MODE 1/MODE 2 switch to MODE 1 and press the DISPLAY button.

Each time you press, the display changes.

DVD-Video:

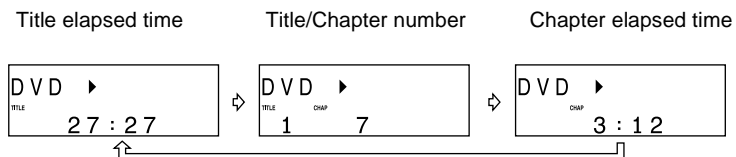

DVD-Audio:

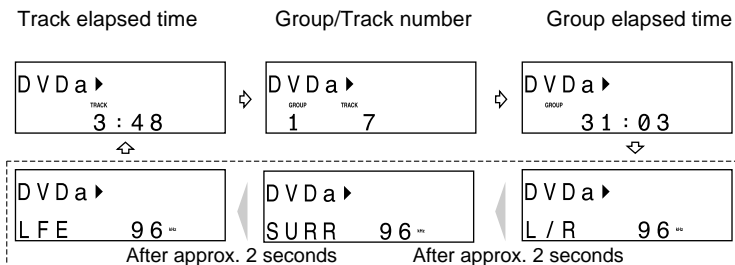

Sampling frequency (low frequency effects)(*)	Sampling frequency (surround)(*)	Sampling frequency (2 channel)(*)

(*) Sampling frequency display may differ or may not appear depending on the disc.

Notes:

- Title/Chapter numbers or elapsed time may not appear depending on the disc.
- The playing time of the disc specified on the jacket, etc. may not include silence between tracks, and may differ from that displayed on the unit.
- Elapsed time on the display does not indicate the actual time.
- During MP3 playback, total elapsed time does not appear, and elapsed time cannot be switched.

> Switching elapsed time SACD CD

During playback, set the MODE 1/MODE 2 switch to MODE 1 and press the DISPLAY button.

Each time you press, the display changes.

SACD:

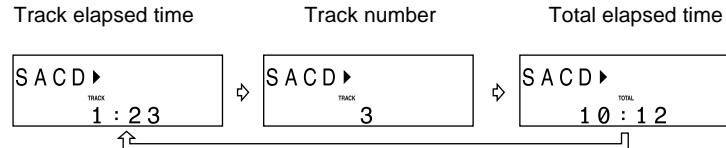

CD:

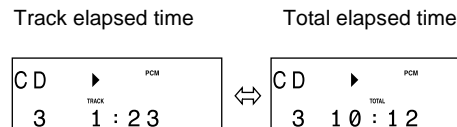

> Switching playing time SACD CD

In the stop mode (SACD/CD), select a track number with the ◀◀ or ▶▶ button.

SACD:

Track number Track playing time



After approx. 2 seconds

CD:

Track playing time

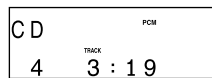

> To change the setting on the playback control screen DVD

On the playback control screen, various settings can be changed at the same time.

1 During playback, set the MODE 1/MODE 2 switch to MODE 2 and press the DVD SET UP button.

2 Press the ▲ or ▼ button to select the item, and press the ENTER button.

Example: DVD

- 1 Title number
- 2 Chapter number
- 3 Elapsed playing time
- 4 Subtitle
- 5 Angle
- 6 Audio language
- 7 Gamma
- 8 Super picture
- 9 BIT RATE indicator (unchangeable)

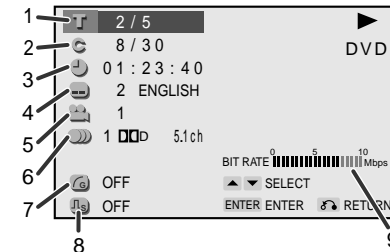

3 Press the ▲, ▼, ◀ or ▶ button to change the setting and press the ENTER button.

Example: Gamma is selected

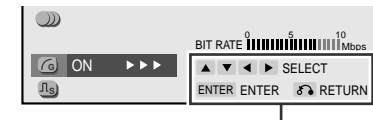

Repeat the operation as instructed.

(The number of repetition depends on the setting item.)

To change other settings, begin from step 2.

4 Press the RETURN button twice.

The setting is memorized and the playback screen reappears.

Notes:

- Some items may not be selected depending on the type of the disc.
- If the RETURN button is pressed while selecting an item or setting, the previous screen appears.
- On DVD-Audio discs, groups and tracks appear instead of titles and chapters.

Playing a DVD-Audio disc

ENGLISH

Some DVD-Audio discs contain still pictures, or grouped tracks called "bonus group". A 4-digit password may be required to play a bonus group.

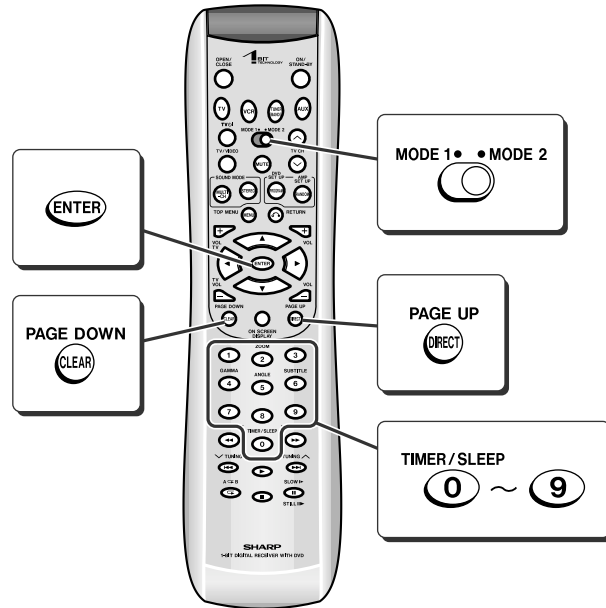

> Switching still pictures on a DVD-Audio disc

1 Play a DVD-Audio disc (see page 17).

2 During playback, set the MODE 1/MODE 2 switch to MODE 2 and press the PAGE UP or PAGE DOWN button.

Each time you press, the image switches.

Notes:

- This operation is not available for some still pictures.
- On DVD-Video discs, you can enjoy various sounds by changing the multi channel mode or stereo mode (see pages 37, 38). On DVD-Audio discs (audio part only), you cannot change the two modes.

> Playing bonus groups

1 During playback, set the MODE 1/MODE 2 switch to MODE 1 and press the DIRECT button.

2 Enter a bonus group number with the direct number buttons (0 - 9) and press the ENTER button.



3 Enter a 4-digit password with the direct number buttons (0 - 9) and press the ENTER button.

Notes:

- For a 4-digit password, see the disc jacket, etc.
- On some discs, a password is not required to play bonus groups.

Playing an SACD disc

The procedure of the following playback functions are the same as the DVD operation.

	Page
To locate the beginning of a chapter (track) (skip)	19
Fast forward/Fast reverse (search)	19
To start playback from the desired point (direct play)	20
To play in the desired order (programmed play)	21
To play repeatedly (repeat play)	22
To play the contents between the specified points repeatedly (A-B repeat) ..	22
Resume play	23
To change the audio language (audio output)	26
To change the display on TV screen	27
Switching elapsed time	28
Switching playing time	28

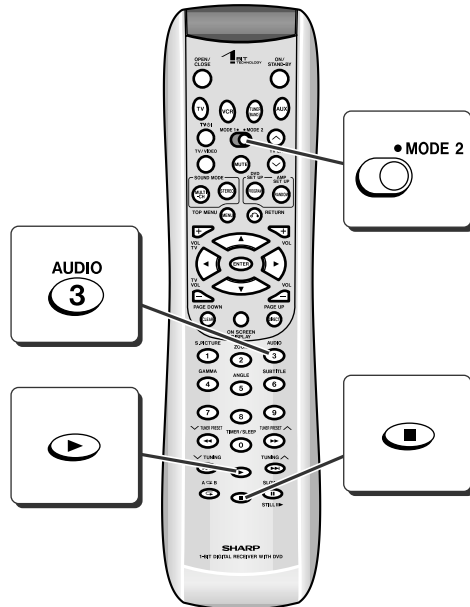

> Playing hybrid SACD sound SACD

On hybrid discs (consisting of an SACD layer and a CD layer), you can select sound to play.

1 Insert an SACD disc and press the button.

2 In the stop mode, set the MODE 1/ MODE 2 switch to MODE 2 and press AUDIO button to select the desired layer.

TV screen



It takes a few seconds to switch the audio output for reading the disc information.

Example: Playing a multi channel SACD disc

You can switch the audio output if the multi channel and stereo 2 channel systems are supported.

	TV screen	Unit display
5.1 channel SACD layer		MULTI
2 channel SACD layer		STEREO
2 channel CD layer		PCM

3 Press the button.

Playback starts.

Notes:

- For sound types, see the manual for the hybrid disc.
- When you remove the disc, the audio output returns to "MULTI".
- On SACD (CD layer only)/CD discs, you can enjoy various sounds by changing the multi channel mode or stereo mode (see pages 37, 38). You cannot change the two modes for the SACD (SACD layer).

Playing an SACD disc (continued)

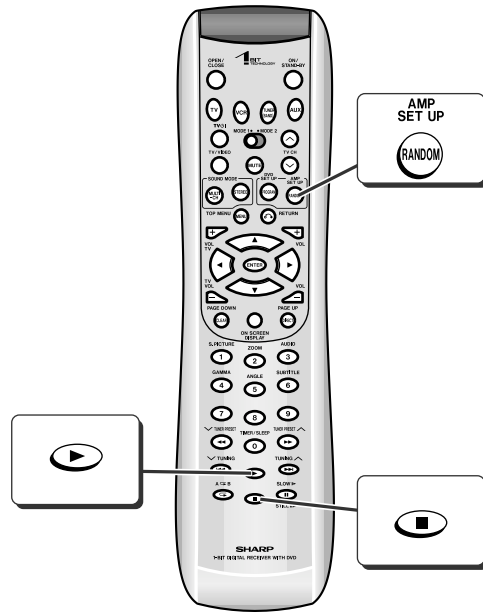

> To play in random order (random play)

SACD CD

The tracks on the disc can be played in random order automatically.

- 1 While in the stop or playback mode, press the RANDOM button.

SACD	
RANDOM	RANDOM

- 2 In the stop mode, press the ► button.

All tracks play in random order.

To cancel random play, press the RANDOM button.

When you press the ■ button, the current random play is canceled.

Notes:

- Random play is not allowed during programmed playback.
- In random play, the unit will select and play tracks automatically. (You cannot select the order of the tracks.)
- For MP3 discs, random play is not available.
- In random play, press the ◀ button to switch to repeat play.

Playing an MP3 disc

You can play back a CD-R/CD-RW disc on which tracks are recorded in the MP3 format.

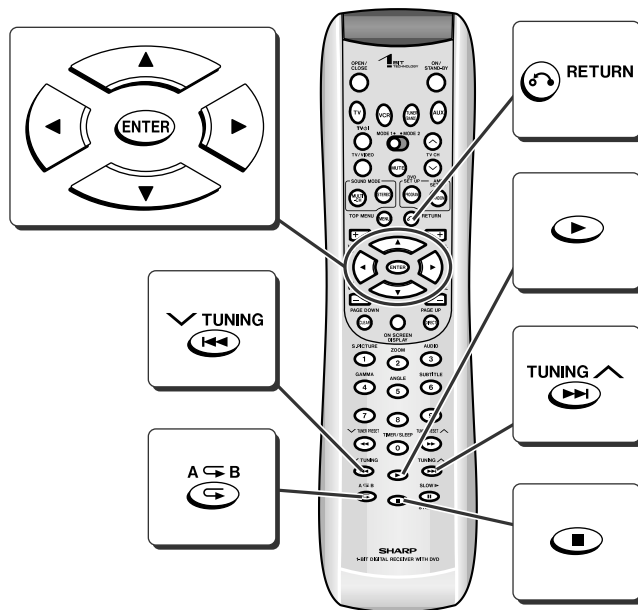

> Selecting a folder on an MP3 disc

- 1 Insert an MP3 disc and press the **■** button.

The folder selection screen appears.

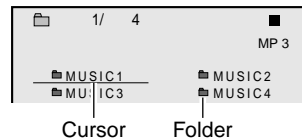

- 2 Select a folder using the **▲, ▼, ◀** or **▶** button and press **ENTER** button.

- The track selection screen appears.
- Move the cursor to a folder and press the **▶** button. Playback starts from the first track.
- Press the RETURN **↶** button to return to the folder selection screen.

- 3 Select a track using the **▲, ▼, ◀** or **▶** button and press the **ENTER** button.

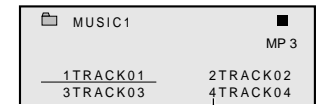

Playback starts from the track.

Track number

Skipping tracks:

While a disc is playing, press the **◀◀** or **▶▶** button. Tracks skip within a folder.

Playing repeatedly (Repeat play)

While a disc is playing, press the **↺** button.

The mode switches as follows: "T" (track), "■" (folder), "no display (normal playback)".

Notes:

- Alternatively, select a track number with the direct number buttons (0 - 9) and press the ENTER button to play.
- If the cursor is placed on a track (not playing) for 10 seconds or more, it starts to play.
- Tracks may not play in the recorded order.
- The unit recognizes up to 8 levels in the folder tree, including folders and tracks.
- 256 tracks can be recognized.
- You can also play multi session discs.
- When the first session contains audio tracks in the CD format, the unit recognizes the disc as a CD and plays only those tracks.
- It may take some time to read a disc depending on the number of files or folder tree structure.
- Up to 8 characters are displayed for folder or track names. Some characters and symbols may not appear properly.
- MP3 discs with data recorded at high speed may not play, or noise may occur during playback.
- The MP3 functions are not available when you burn MP3 files on a CD-R/CD-RW disc to create an audio CD. Play the disc as a standard CD.

Listening to the radio

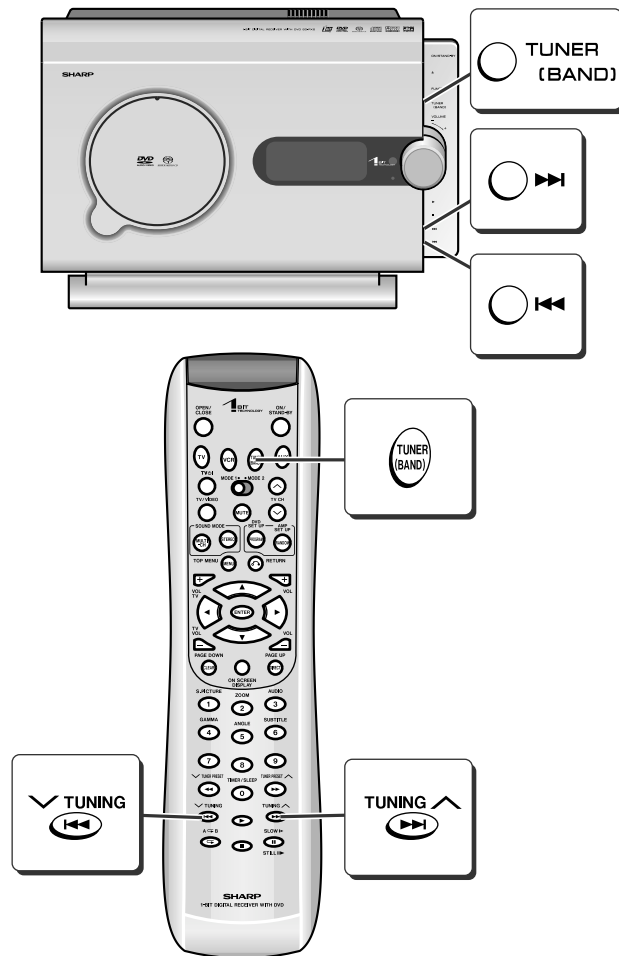

Volume control (See page 16).

1 Turn on the power and press the **TUNER (BAND)** button to set the input to "FM (AM)".

2 Press the **TUNER (BAND)** button repeatedly to select the desired frequency band.

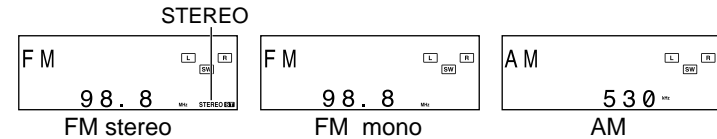

3 Press the **TUNING** (∨ or ∧) button to tune in to the desired station.

Manual tuning:

Press the **TUNING** button as many times as required to tune in to the desired station.

Auto tuning:

When the **TUNING** button is pressed for 0.5 seconds or more, scanning will start automatically and the tuner will stop at the first receivable broadcast station.

- When radio interference occurs, auto scan tuning may stop automatically. Should this happen, tune in manually.
- Auto scan tuning will skip weak signal stations.
- To stop the auto tuning, press the **TUNING** button again.

To receive an FM stereo transmission:

Press the **TUNER (BAND)** button to display the "STEREO" indicator.

- "ST" will appear when an FM broadcast is in stereo.

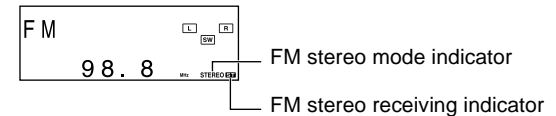

- If the FM reception is weak, press the **TUNER (BAND)** button to extinguish the "STEREO" indicator. The reception changes to mono, and the sound becomes clearer.

After use:

Press the **ON/STAND-BY** button to enter the power stand-by mode.

Listening to the memorized station

You can store 40 AM and FM stations in memory and recall them at the push of a button. (Preset tuning)

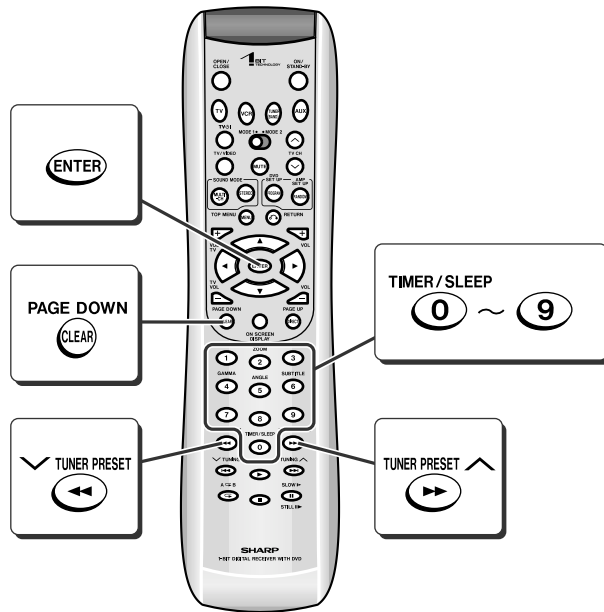

1 Tune in the desired station and press the ENTER button.

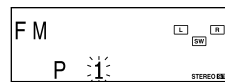

- For FM stations, stereo and mono modes are memorized.
- Store the stations in memory, in order, starting with preset channel 1.

2 Within 5 seconds, press the TUNER PRESET (∨ or ∧) button to select the preset channel number.

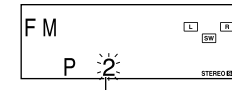

Preset channel number

3 Within 5 seconds, press the ENTER button to store that station in memory.

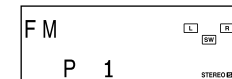

- Repeat steps 1 - 3 to set other stations, or to change a preset station.
- When a new station is stored in memory, the station previously memorized will be erased.

To recall a memorized station:

Press the TUNER PRESET (∨ or ∧) button to select the desired station.

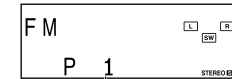

Preset channel number

To select a preset station with the direct number buttons:

- Press the corresponding number ("0" - "9").
- Press the ENTER button.

For example, to choose 28

- Press the "2" button.
- Press the "8" button.
- Press the ENTER button.

- Press buttons within 5 seconds.
- To correct, enter the number again.

To erase all the contents of the preset memory:

- Hold the CLEAR button down for 4 seconds or more.
- Within 10 seconds, press the ENTER button.



Note:

The backup function protects the memorized stations for a few hours should there be a power failure or the AC power cord disconnection.

Enjoying surround sound (sound mode)

This product is equipped with Dolby Digital and DTS decoders. You can enjoy powerful and high-quality surround sound as if you were on the scene.

Dolby Digital



Disc with this trademark

One of the digital audio systems for theatrical use. You can enjoy the stereophonic effect in the home theater system.

When you set the audio output to Dolby Digital for a disc recorded in Dolby Digital, the DIGITAL indicator lights up (see page 26).

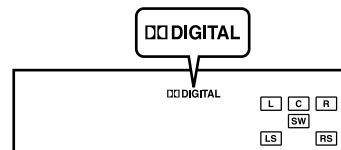

DTS (Digital Theater Systems)



Disc with this trademark

One of the digital audio systems for theatrical use. As the sound quality is emphasized, you can enjoy the realistic sound effect in the home theater system.

When you set the audio output to DTS for a disc recorded in DTS, the indicator lights up (see page 26).

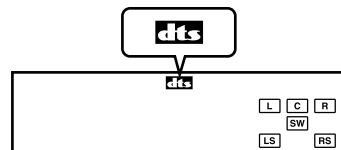

Dolby Pro Logic II reproduces 5.1 channel surround from 2 channel stereo sound.

Dolby Pro Logic II

Stereo-recorded discs and video tapes

Dolby Pro Logic II decodes 2 channel stereo sound from discs, videotapes, etc. to reproduce 5.1 channel surround sound. You can enjoy a three-dimensional sound field.

When Dolby Pro Logic II is activated, the PRO LOGIC II indicator lights up.

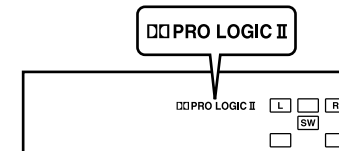

Linear PCM

A signal recording format without compression

Used in DVD and CD featuring a musical or concert.

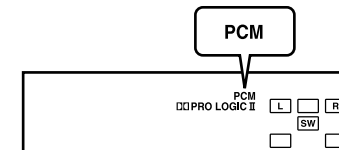

> Audio signal/Speaker indicators

Audio signal indicators light up for the corresponding audio source, and speaker indicators are illuminated according to signals sent to the speakers.

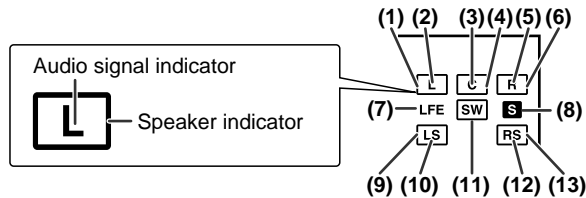

Example:

When 2.1 channel audio signals (L, R, LFE) are received, the audio signal indicators "L", "R" and "LFE" light up. The illustration on the right indicates that 2 channel stereo sound (L and R) is reproduced.

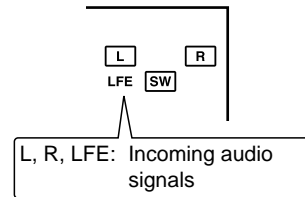

When Dolby Pro Logic II is activated

2 channel stereo sound is converted to 5.1 channel surround sound, and all the speaker indicators "□" light up.

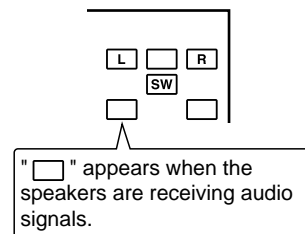

Audio Signal/Speaker Indicators:

- (1) Left Front Speaker Indicator
- (2) Left Indicator
- (3) Center Indicator
- (4) Center Speaker Indicator
- (5) Right Indicator
- (6) Right Front Speaker Indicator
- (7) Low Frequency Effect Indicator
- (8) Surround Monaural Signal Indicator
(Lights up when the surround speakers receive monaural signals.)
- (9) Left Surround Speaker Indicator
- (10) Left Surround Indicator
- (11) Subwoofer Indicator
- (12) Right Surround Indicator
- (13) Right Surround Speaker Indicator

Notes:

- You can switch the audio output when the disc contains sounds of multiple audio formats (Dolby Digital, DTS, etc.). See page 26.
- Sound may not be produced from the subwoofer depending on the disc.
- You cannot change the multi channel mode or stereo mode on DVD-Audio discs (audio part only) or SACD discs (SACD layer only), or while listening to the radio.

Enjoying surround sound (sound mode) (continued)

ENGLISH

You can enjoy spacious sound recorded in Dolby Digital or DTS.
Also, Dolby Pro Logic II allows you to enjoy spacious 2 channel stereo sound.

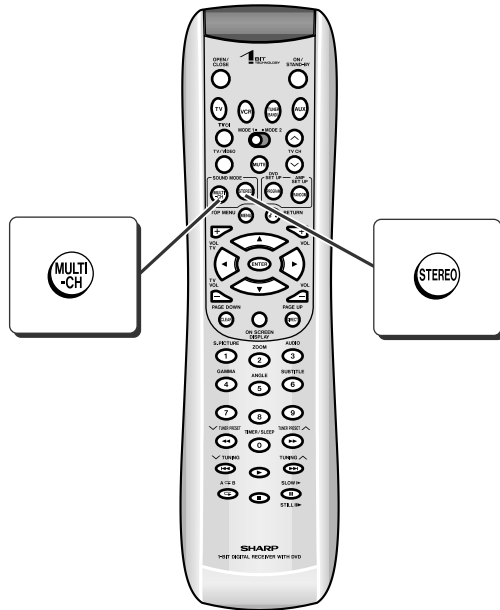

Notes:

- You cannot change the multi channel mode or stereo mode on DVD-Audio discs (audio part only) or SACD discs (SACD layer only), or while listening to the radio.
- If sound is unpleasant to listen to, change the multi channel mode or stereo mode.
- Settings for the multi channel mode and stereo mode are retained by input (DVD, TV, AUX and VCR).

> Listening to sounds in the multi channel mode (5.1 ch, etc.)

DVD (Dolby Digital or DTS)

While the disc is playing, press the MULTI-CH button.

Example: DTS format

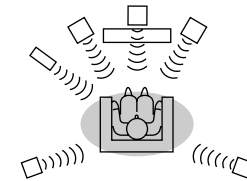

A maximum of 5.1-ch surround sound is reproduced to provide three-dimensional effect.

When you press once, the last used setting appears. To change it, press the button repeatedly within 3 seconds.

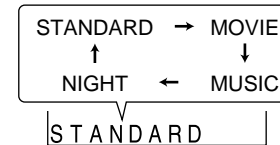

STANDARD: You can enjoy the original sound as it is.

MOVIE: The bass level is increased for powerful sound effect.

MUSIC: You can enjoy lively sound by producing the articulate sound.

NIGHT: Soft but powerful sound is achieved even at low volumes.

Note:

When listening to Dolby Digital or DTS sound, you cannot select "STADIUM" and "HALL".

2 channel stereo sound (CD, videotapes, etc.)

While the disc is playing, press the **MULTI-CH** button.

Example: 2-ch stereo sound



Dolby Pro Logic II converts 2 channel stereo sound of CDs, etc. to 5.1 channel.

When you press once, the last used setting appears. To change it, press the button repeatedly within 3 seconds.

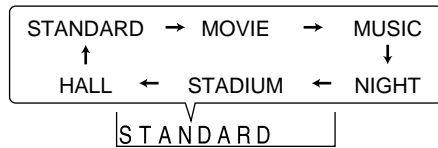

- STANDARD:** You can enjoy the original sound as it is.
- MOVIE:** The bass level is increased for powerful sound effect.
- MUSIC:** You can enjoy lively sound by producing the articulate sound.
- NIGHT:** Soft but powerful sound is achieved even at low volumes.
- STADIUM:** You feel like one of the audience in a stadium.
- HALL:** A concert hall atmosphere is created.

Notes:

- When monaural signals are received in the multi channel mode, only the center speaker and subwoofer produce sound.
- When you play Dolby Digital or DTS sound with "STADIUM" or "HALL" set, surround is automatically set to "STANDARD".

> Listening to 2 channel stereo sounds

While the disc is playing, press the **STEREO** button.

Example: DTS format



You can enjoy 2 channel stereo sound.

When you press once, the last used setting appears. To change it, press the button repeatedly within 3 seconds.

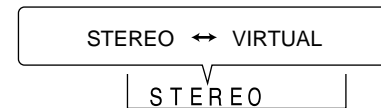

- STEREO:** You can enjoy the great acoustic effects of the front speakers and subwoofer.
- VIRTUAL:** Although the surround speaker does not work, you can enjoy spacious surround effects.
It sounds as if speakers were also placed in .

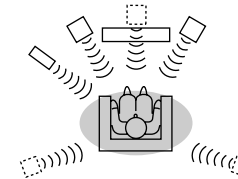

Notes:

- When the surround mode is set to "STEREO" or "VIRTUAL", the same monaural sound is reproduced in the both of the right and left channels.
- Some discs are recorded at 96 kHz of sampling frequency. When this type of disc is played, the sound mode is changed to "STEREO" automatically. The sound mode cannot be changed during playback.

Changing the initial setting of DVD

ENGLISH

Advanced Features
- Changing the initial setting of DVD -

A new setting will be retained even if the unit is set to the stand-by mode. If you want to restore or change the setting, reset it.

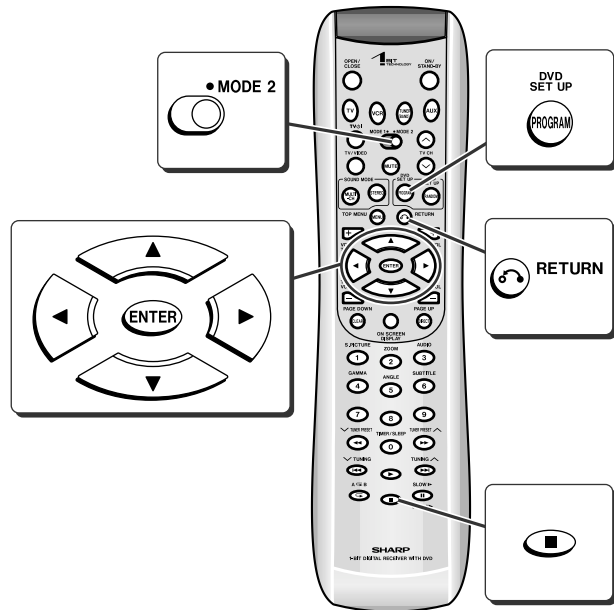

- 1** Press the button, set the MODE 1/ MODE 2 switch to MODE 2 and press the DVD SET UP button.

The initial setting screen appears.



- 2** Press the or button to select a setting item and press the ENTER button.

For setting items, see the table on page 40.

- 3** Press the , , or button to select a parameter and press the ENTER button.

Example: "TV MODE" is selected

To change other settings, begin from step 2.

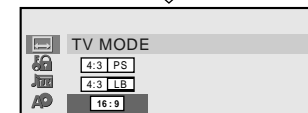
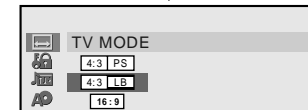
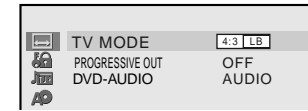









- 4** Press the RETURN button twice.

The new setting is memorized.



Notes:

- You cannot display the initial setting screen while a disc is playing.
- The previous screen appears by pressing the RETURN button while selecting an item or setting.

Setting	Selectable parameters (* indicates initial settings.)	Description	Reference page
 TV MODE	TV MODE   	Select according to the TV.	P. 41
	PROGRESSIVE OUT ON OFF*	If the TV supports progressive scan, select "ON" to enjoy high resolution images. If not, set to "OFF".	P. 41
	DVD-AUDIO (Selectable when a disc is not inserted.) AUDIO* VIDEO	Some DVD-Audio discs contain both DVD-Audio and DVD-Video contents. Select either as default.	P. 29
 PARENTAL	PASSWORD Please enter a 4-digit password.	You can set a 4-digit password required to change the "LEVEL" and "CODE" (country code). If you forget the password, press the  button four times.	P. 41
	LEVEL LEVEL 1 - 8 OFF*	Restrict viewing by selecting a level.	P. 41
	CODE USA* CANADA :	Set a country code according to a parental control level of discs.	P. 41
 AUDIO	<input type="checkbox"/> DIGITAL BITSTREAM* D-PCM	Select the audio output according to the external equipment connected to the optical digital audio output jack.	P. 57
 DISC LANGUAGE	AUDIO ENGLISH* SPANISH : OTHER	Select a language to play. If the selected language is not available, the disc plays in a default language.	P. 42
	SUB TITLE ENGLISH SPANISH : OTHER OFF*	Select a language for subtitles (displayed on the TV screen). If the selected language is not available, subtitles appear in a default language. OFF: Select this to hide subtitles.	P. 42
	MENU EN* :	Select a language for the disc menu, etc. If the selected language is not available, the display appears in a default language.	P. 42
 OSD LANGUAGE	ENGLISH* ESPAÑOL FRANÇAIS ITALIANO DEUTSCH 中文 SVENSKA NEDERLANDS	Select an OSD (On Screen Display) language for initial settings and operations.	—

Changing the initial setting of DVD (continued)

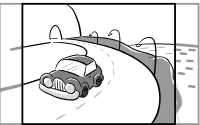
> Video format

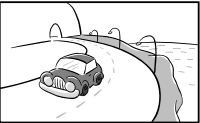
Indicator	Setting
4:3 PS	<p>When playing a wide image (16:9) disc, the left and right sides of the image are cut (pan scan) to display a natural-looking 4:3 size image.</p> <p>A wide image disc without pan scan [4:3] [PS] is played back in letterbox [4:3] [LB].</p>  <p>A 4:3 disc is played in 4:3.</p>
4:3 LB	<p>When playing a wide image (16:9) disc, black bands are inserted at the top and bottom and you can enjoy full wide images (16:9) on a 4:3 size TV.</p>  <p>A 4:3 disc is played in 4:3.</p>
16:9	<p>A wide image (16:9) is displayed when playing a wide image (16:9) disc.</p>  <p> <ul style="list-style-type: none"> When playing a 4:3 image disc, the image size depends on the setting of the connected TV. If you play back a wide image (16:9) disc with the unit connected to a 4:3 TV, images appear stretched vertically. </p>

Note:

When playing the disc with a fixed video format, it will not change even if the TV screen size is changed.

> Progressive scan playback

Connect the unit to a TV supporting progressive scan with a component video cable. You can enjoy flicker-free images.

Setting	Description
ON (Progressive)*1	If the TV supports progressive scan, set to "ON". You can enjoy flicker-free images.
OFF (Interlace)*2	If the TV does not support progressive scan, set to "OFF". Images are displayed in the interlaced system.

*1 Progressive

525 scanning lines are drawn in order without interlacing (first field), and then 525 scanning lines are drawn in the same pass on the next field.

*2 Interlace (Interlaced scan)

Following odd-numbered scan lines, even-numbered scan lines (262.5 lines each) are drawn in 1/60 seconds. This occurs in two separate fields. As a result, a 525-line image (frame) is created.

Notes on a non-progressive scan TV

If "PROGRESSIVE OUT" is set to "ON", the TV does not display images. Connect the supplied video cable, switch the input to video, and set "PROGRESSIVE OUT" to "OFF".

Compatibility of the progressive scan TV

Some progressive scan TVs are not fully compatible with this product, which may cause image distortion. In this case, set "PROGRESSIVE OUT" to "OFF".

> Parental setting

Indicator	Setting
LEVEL 1	Only DVD software intended for children can be played back.
LEVEL 2 to 7	Only DVD software intended for general use and children can be played back.
LEVEL 8	DVD software of any grade (adult/general/children) can be played back.
OFF	Parental control is canceled.
CODE	Country code for parental control

Country code list:

USA	SPAIN	BELGIUM	PHILIPPINE
CANADA	SWISS	HONG KONG	AUSTRALIA
JAPAN	SWEDEN	SINGAPORE	RUSSIA
GERMANY	HOLLAND	THAILAND	CHINA
FRANCE	NORWAY	MALAYSIA	-
UK	DENMARK	INDONESIA	-
ITALY	FINLAND	TAIWAN	-

Notes:

- For the parental setting, enter a 4-digit number (example: 1234), which will be your password. Enter "1234" from the next time.
- While playing a disc with parental control, the display may appear requesting a password in order to watch some restricted scenes. In such a case, enter the password to temporarily change the control level.

> Disc language

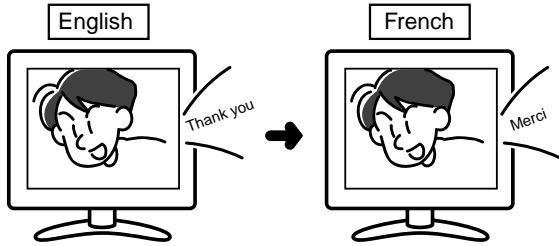
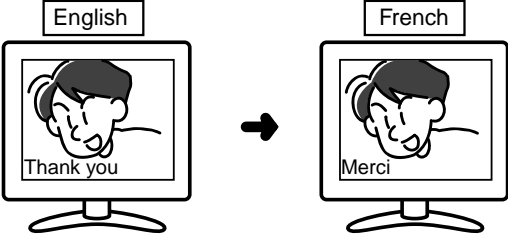
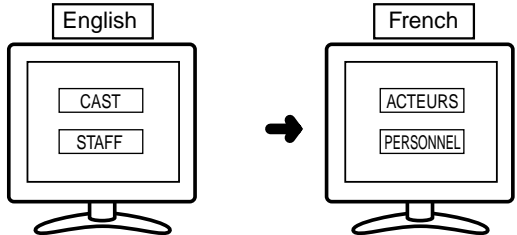
Indicator	Setting
AUDIO	<p>A language for audio can be set. You can specify a language for dialogues and narration.</p> 
SUB TITLE	<p>A language for subtitle can be set. The subtitle is displayed in a specified language.</p> 
MENU	<p>A language for disc menus can be set. Menu screens are displayed in a specified language.</p> 

> Selecting a language for "DISC LANGUAGE", etc.

Check the code of the language (See the language code list on page 61).
Example: When you select HU (Hungarian)

- On the initial setting screen, select "DISC LANGUAGE" (see steps 1 - 2 on page 39), and select "MENU" and press the ENTER button.

- Press the ◀ or ▶ button to select "H" for the first letter.

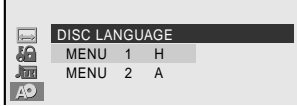
- Press the ▲ or ▼ button to move the cursor to the "MENU 2".

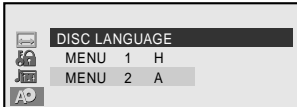
- Press the ◀ or ▶ button to select "U" for the second letter.

- Press the ENTER button.
- Press the RETURN button twice.
The new setting is memorized.

Changing the default settings of the amplifier

Change settings according to the connected speakers.

Speaker size setting (See pages 43, 44).

Speaker delay setting (See page 44).

Speaker level setting (See page 45).

Test tone (See page 45).

Changing crossover frequency (See page 46).

Example:

If the right surround speaker is 10 feet (3.3 m) away from the listening position, change settings as shown below (adjust the SR).

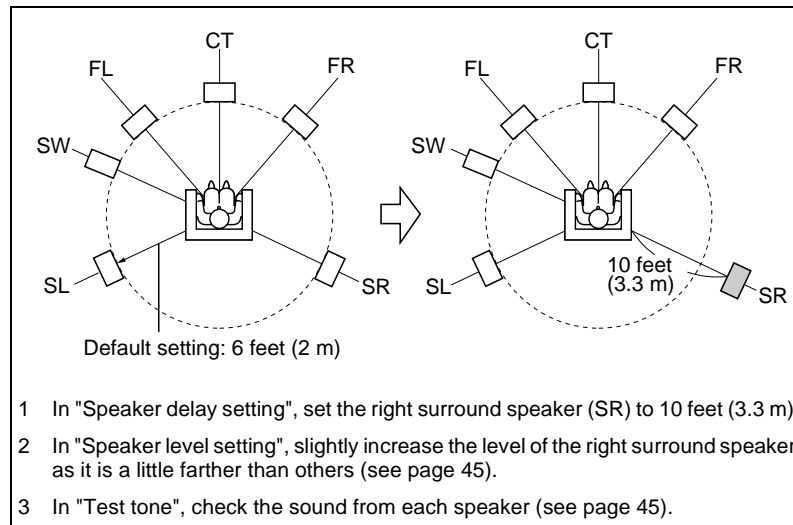

Notes:

- The subwoofer setting applies to a subwoofer connected to SUBWOOFER PRE OUT.
- You cannot change the default settings while playing SACD/DVD-Audio discs.

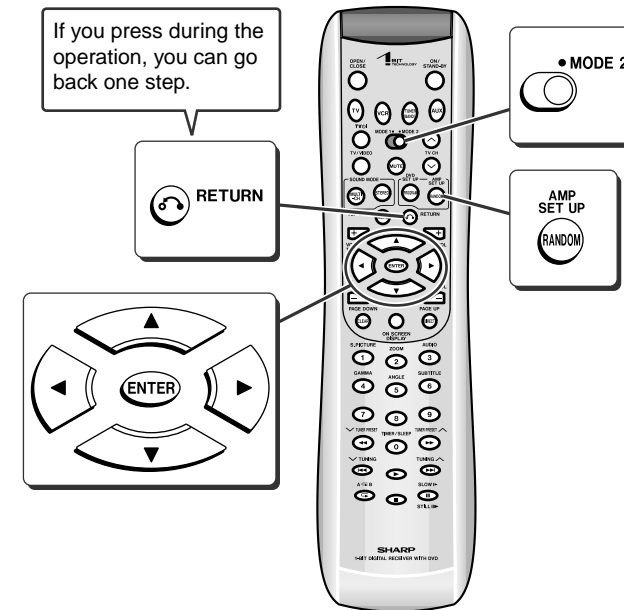

> Speaker size setting

You can change the sizes of the front speakers, center speaker, and surround speakers, or turn on or off the center speaker, surround speakers, or subwoofer.

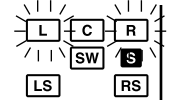
- 1 Set the MODE 1/MODE 2 switch to MODE 2 and press the AMP SET UP button.
- 2 Within 10 seconds, press the ▲ or ▼ button to select "SP SIZE", and press the ENTER button.
 
- 3 Within 10 seconds, press the ▲ or ▼ button to select the desired speaker. The indicators of selected speakers flash.
 

4 Within 10 seconds, press the ◀ or ▶ button to select their sizes.

To set sizes of other speakers, repeat the operation from step 3.



5 Press the RETURN ↵ button twice.

The setting is complete.

When you select "LARGE", all channel signals are sent to the speaker.
When you select "SMALL", frequencies below the value you set for crossover frequency (see page 46) are sent to the subwoofer.

Speaker type	Speaker size	
Front speaker (Left, Right)	F-SMALL *	Small diameter
	F-LARGE	Large diameter
Center speaker	C-SMALL *	Small diameter
	C-LARGE	Large diameter
	C-NO	OFF
Surround speaker (Left, Right)	S-SMALL *	Small diameter
	S-LARGE	Large diameter
	S-NO	OFF
Subwoofer	SW-YES *	ON
	SW-NO	OFF

(*) indicates the default setting.

Notes:

- The speaker size setting is only available for the subwoofer if the input is set to tuner, or the surround is "STEREO" or "VIRTUAL".
- On some DVD-Audio or SACD discs, the subwoofer may not produce sound even if the speaker size is set to "SMALL".
- "F-SMALL" and "SW-NO" cannot be combined. If the subwoofer is changed to "SW-NO" while the front speakers are set to "F-SMALL", they are changed to "F-LARGE". When the front speakers are changed to "F-SMALL" while the subwoofer is set to "SW-NO", it is changed to "SW-YES".
- If "LARGE" is set for a small speaker, malfunction may result. Be sure to set the speaker size to "SMALL".
- When the center and surround speakers and subwoofer are not connected, set the speaker size to "C-NO", "S-NO" and "SW-NO". Otherwise, the protection circuit may be activated and the power is turned off.

> Speaker delay setting

When some of the speakers are at a different distance from the listening point, you can select the speaker delay to make it seem as though the speaker distances are the same.

1 Set the MODE 1/MODE 2 switch to MODE 2 and press the AMP SET UP button.

2 Within 10 seconds, press the ▲ or ▼ button to select "SP DELAY", and press the ENTER button.



3 Within 30 seconds, press the ▲ or ▼ button to select the desired speaker.

The indicator of the selected speaker flashes.

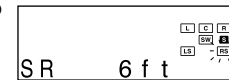

4 Within 30 seconds, press the ◀ or ▶ button to select the distance.

- You can change the distance in 1 foot (0.3 m) steps.
- To set the distance of other speakers, repeat the operation from step 3.

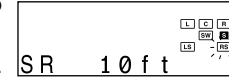

5 Press the RETURN ↵ button twice.

The setting is complete.

Speaker type		Delay range	Default setting
FL	Front speaker (Left)	1 to 29 ft	6 ft (2 m)
CT	Center speaker	1 to 29 ft	6 ft (2 m)
FR	Front speaker (Right)	1 to 29 ft	6 ft (2 m)
SR	Surround speaker (Right)	1 to 29 ft	6 ft (2 m)
SL	Surround speaker (Left)	1 to 29 ft	6 ft (2 m)
SW	Subwoofer	1 to 29 ft	6 ft (2 m)

Notes:

- The speaker delay setting is only available for the front speakers and subwoofer if the input is set to tuner, or the surround is "STEREO" or "VIRTUAL".
- The speaker delay setting is invalid while playing DVD-Audio or SACD discs (valid for the CD layer of SACD discs).

Changing the default settings of the amplifier (continued)

> Speaker level setting

If sounds from the speakers are uneven, you can equalize them by adjusting the speaker levels.

- 1 Set the MODE 1/MODE 2 switch to MODE 2 and press the AMP SET UP button.**
- 2 Within 10 seconds, press the ▲ or ▼ button to select "SP LEVEL", and press the ENTER button.**

- 3 Within 10 seconds, press the ▲ or ▼ button to select the desired speaker.**

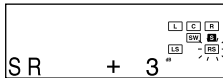
The indicator of the selected speaker flashes.

- 4 Within 10 seconds, press the ◀ or ▶ button to adjust the level.**
 - You can adjust the level at 1 dB intervals.
 - To adjust the levels of other speakers, repeat the operation from step 3.
- 5 Press the RETURN ↵ button twice.**

The setting is complete.

Speaker type		Level range	Default setting
FL	Front speaker (Left)	- 10 dB to + 10 dB	0 dB
CT	Center speaker	- 10 dB to + 10 dB	0 dB
FR	Front speaker (Right)	- 10 dB to + 10 dB	0 dB
SR	Surround speaker (Right)	- 10 dB to + 10 dB	0 dB
SL	Surround speaker (Left)	- 10 dB to + 10 dB	0 dB
SW	Subwoofer	- 10 dB to + 10 dB	0 dB

Notes:

- The speaker level setting is only available for the front speakers and subwoofer if the input is set to tuner, or the surround is "STEREO" or "VIRTUAL".
- If subwoofer sound is distorted, lower the subwoofer level.

> Test tone

You can check each speaker sound by a test tone. Readjust the volume set in "Speaker level setting".

- 1 Set the MODE 1/MODE 2 switch to MODE 2 and press the AMP SET UP button.**
- 2 Within 10 seconds, press the ▲ or ▼ button to select "TONE", and press the ENTER button.**

The test tone will be heard from each speaker, in order, at about 2-second intervals.

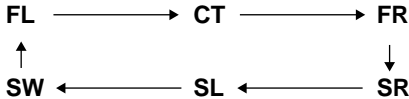

To adjust speaker levels
While the test tone is heard:
Adjust the level with the ◀ or ▶ button.
Press the ▲ or ▼ to select a speaker.
- 3 Press the RETURN ↵ button twice.**

The setting is complete.

Notes:

- The test tone is produced only from the front speakers and subwoofer if the input source is set to tuner or the surround is "STEREO" or "VIRTUAL".
- If NO (OFF) is selected for a speaker in the speaker size setting, no test tone will be heard from it.

> Changing crossover frequency

Change the level above which subwoofer frequencies are cut, to adjust the balance with the front speakers. When the speaker setting is "SMALL", low frequencies from the speaker are cut. It is recommended to set the level slightly above that of the lowest front speaker frequency (the lowest reproducible frequency).

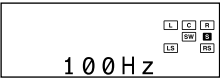
- 1 Set the MODE 1/MODE 2 switch to MODE 2 and press the AMP SET UP button.**
- 2 Within 10 seconds, press the ▲ or ▼ button to select "X-FREQ", and press the ENTER button.**

- 3 Within 10 seconds, press the ◀ or ▶ button to select frequency and press the ENTER button.**

- 4 Press the RETURN button twice.**
The setting is complete.

Adjustable frequency range	Recommended frequency range
80 Hz	The lowest reproducible frequency of the front speakers is below 80 Hz.
100 Hz *	The lowest reproducible frequency of the front speakers is between 80 and 100 Hz.
120 Hz	The lowest reproducible frequency of the front speakers is between 100 and 120 Hz.
150 Hz	The lowest reproducible frequency of the front speakers is between 120 and 150 Hz.

(*) indicates the default setting.

Note:

The crossover frequency setting is invalid when playing DVD-Audio discs.

In the stop mode, you can change the amplifier settings on the TV screen.

- 1 Set the MODE 1/MODE 2 switch to MODE 2 and press the AMP SET UP button.**

The amplifier setting screen appears.

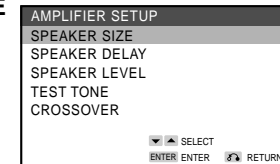

- 2 Press the ▲ or ▼ button to select the menu and press the ENTER button.**

- 3 Press the ▲, ▼, ◀ or ▶ button to change the setting and press the ENTER button.**

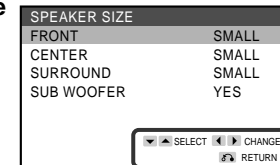

Repeat the operation as instructed.

(The number of repetition depends on the setting item.)

To change other settings, begin from step 2.

- 4 Press the RETURN button twice.**

The setting is complete.

Note:

You cannot change the amplifier settings unless the input source is set to DVD/CD.

Timer playback

The unit starts playback or turns on the radio at a specified time. This unit has 2 types of timer functions: "once timer" and "daily timer".

Once timer:

Once timer playback works for one time only at a preset time.

Use when...

You want to listen to a radio program on the day. (After operation, the timer setting is canceled.)

Daily timer:

Daily timer playback works at the same preset time every day.

Use when...

You want to use the timer as a wake up call, or listen to the radio at the same time every day.

You can use the once timer and daily timer together.

For example, use the timer as a wake-up call (daily timer), and listen to the radio later on the day.

- 1 Set the daily timer (pages 47 - 48).
- 2 Set the once timer (pages 47 - 48).

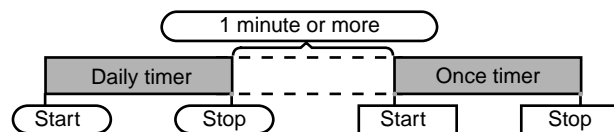

Notes:

- If both timers are set for the same time, the once timer setting will start.
- When using both timers, allow at least 1 minute between operations. Otherwise the timer used later will not work.

Before setting timer:

- 1 Set the clock (see page 15).
If the clock is not set to the correct time, the timers do not work properly.
- 2 Prepare a source to play back.
 - Insert a disc to play.
 - To use the radio for timer playback, store a station (see page 34).

Notes:

- When you use the timer to play a DVD with a menu screen, playback stops at the menu screen.
- If the unit is unplugged or a power failure occurs after timer setting, the clock stops and the timer setting will be canceled. Set the clock and timer again.
- You cannot use the timer to operate other equipment.
- Timer playback does not start if the unit is turned on at the start time.

Setting the timer

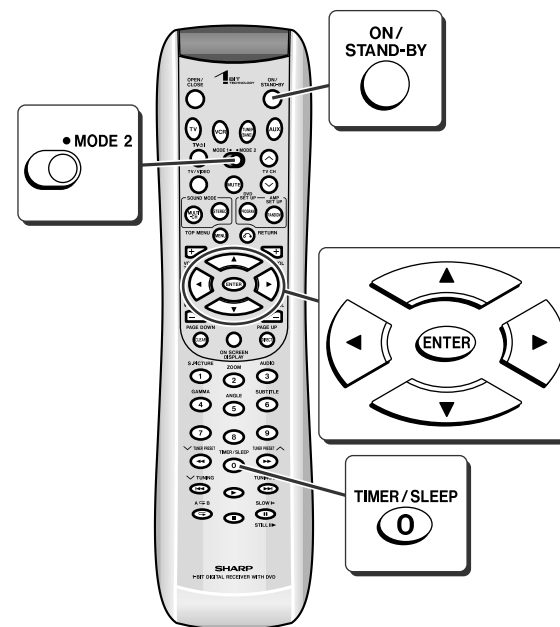

1 Turn on the power, set the MODE 1/MODE 2 switch to MODE 2 and press the TIMER/SLEEP button.

2 Within 10 seconds, press the ▲ or ▼ button to select "TIMER ONCE" or "TIMER DAILY", and press the ENTER button.

Once timer

Daily timer

TIMER
ONCE

TIMER
DAILY

3 Within 10 seconds, press the ▲ or ▼ button to select "ONCE SET" or "DAILY SET", and press the ENTER button.

Once timer

Daily timer

ONCE
SET

DAILY
SET

4 Press the ◀ or ▶ button to adjust the hour and then press the ENTER button.

ON
1:00 AM

5 Press the ◀ or ▶ button to adjust the minutes and then press the ENTER button.

ON
7:00 AM

6 Set the time to finish as in steps 4 and 5 above.

OFF
8:00 AM

7 Switch the input with the ◀ or ▶ button, and then press the ENTER button.

- Available playback sources: DVD/CD, TUNER, TV, AUX and VCR.
- If you select TV, AUX or VCR, connect the unit to the corresponding equipment and set the timer.
- When you select "TUNER", select a station by pressing the ◀ or ▶ button, and then press the ENTER button.
- If a station has not been programmed, "NO P.SET" will be displayed and timer setting will be canceled.

FM P 1 STEREO ↔ FM 76.0 STEREO

Preset channel number

8 Adjust the volume with the ◀ or ▶ button and press the ENTER button.

VOLUME 20

Do not set the volume too high.

9 Press the ON/STAND-BY button to enter the power stand-by mode.

- The unit enters the timer stand-by mode. (The timer set indicator lights up. See page 49.)
- The timer setting is retained.

Operations after setting the timer

ENGLISH

1 After setting the timer

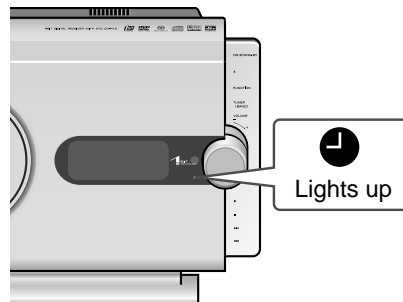

- The unit is in the timer stand-by mode.
- If the timer set indicator does not light up, turn on the power and set the timer again.

2 At the start time

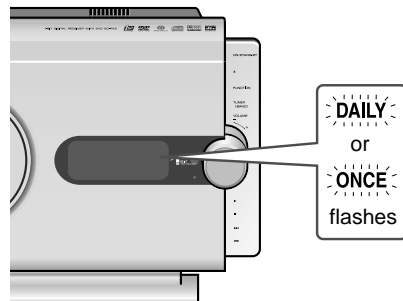

The volume will increase gradually until it reaches the preset volume.

3 When the finish time is reached:

The unit is set to the power stand-by mode automatically.

> In the timer stand-by mode

Checking the timer setting:

- 1 Set the MODE 1/MODE 2 switch to MODE 2 and press the TIMER/SLEEP button.
- 2 Within 10 seconds, press the ▲ or ▼ button to select "TIMER ONCE" or "TIMER DAILY", and press the ENTER button.
- 3 Within 10 seconds, press the ▲ or ▼ button to select "ONCE CALL" or "DAILY CALL", and press the ENTER button.
The unit returns to the timer stand-by mode after displaying the settings in order.

Canceling the timer setting:

- 1 Set the MODE 1/MODE 2 switch to MODE 2 and press the TIMER/SLEEP button.
- 2 Within 10 seconds, press the ▲ or ▼ button to select "TIMER ONCE" or "TIMER DAILY", and press the ENTER button.
- 3 Within 10 seconds, press the ▲ or ▼ button to select "ONCE OFF" or "DAILY OFF", and press the ENTER button.
Timer will be canceled (the setting will be retained).

> To use the same timer setting

Once timer:

- 1 Turn on the power, set the MODE 1/MODE 2 switch to MODE 2 and press the TIMER/SLEEP button.
- 2 Within 10 seconds, press the ▲ or ▼ button to select "TIMER ONCE", and press the ENTER button.
- 3 Within 10 seconds, press the ▲ or ▼ button to select "ONCE ON", and press the ENTER button.
- 4 Press the ON/STAND-BY button to enter the power stand-by mode.

Daily timer:

The timer will operate at the same time every day. It will continue until the daily timer setting is canceled. Cancel the daily timer when it is not in use. When you use the same setting for the daily timer, select "TIMER DAILY" instead of "TIMER ONCE", and select "DAILY ON" instead of "ONCE ON".

Sleep timer

The unit turns off at a specified time when listening to a disc or the radio.

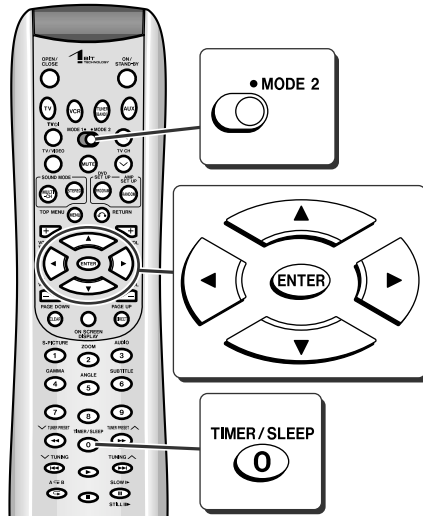

1 During playback, set the MODE 1/MODE 2 switch to MODE 2 and press the TIMER/SLEEP button.

2 Within 10 seconds, press the ▲ or ▼ button to select "SLEEP SET", and press the ENTER button.

SLEEP
SET

3 Press the ◀ or ▶ button to select the time.

(Maximum: 2 hours - Minimum: 1 minute)

• 2 hours - 5 minutes → 5-minute intervals

• 5 minutes - 1 minute → 1-minute intervals

SLEEP
2 : 0 0

4 Press the ENTER button.

• The unit will enter the power stand-by mode automatically after the preset time has elapsed.

• The volume will be turned down 1 minute before the sleep operation finishes, and then you cannot change the volume.

SLEEP
2 : 0 0

To confirm the remaining sleep time:

- While "SLEEP" appears, set the MODE 1/MODE 2 switch to MODE 2 and press the TIMER/SLEEP button.
- Within 10 seconds, press the ▲ or ▼ button to select "SLEEP".

SLEEP
1 : 5 7

Remaining sleep time

- The remaining sleep time is displayed for about 10 seconds.
- You can change the remaining sleep time while it is displayed by pressing the ENTER button (steps 3 - 4).

To cancel the sleep operation:

Press the ON/STAND-BY button while "SLEEP" is indicated.

To cancel the sleep operation without setting the unit to the stand-by mode, proceed as follows.

- Set the MODE 1/MODE 2 switch to MODE 2 and press the TIMER/SLEEP button.
- Within 10 seconds, press the ▲ or ▼ button to select "SLEEP OFF".
- Within 10 seconds, press the ENTER button. ("SLEEP" goes out.)

SLEEP
OFF

> To use timer and sleep operation together

For example, you can fall asleep to the radio, and wake up to CD.

- Set the sleep time (steps 1 - 4).
- Set the timer playback (steps 1 - 8, page 48).
Make sure timer playback does not start while sleep timer is active.

The unit enters into the power stand-by mode after the time set for sleep timer, and turns on at the start time of timer playback.

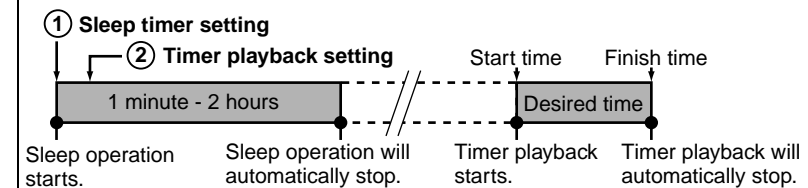

Operating the connected TV

You can operate Sharp TVs with the remote control. Change the remote control setting if operating other manufacturers' TV, or if you cannot operate a Sharp TV.

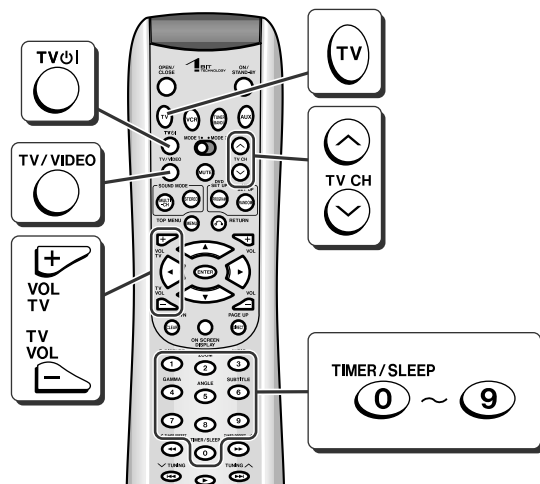

> Watching TV

- 1** Press the TV button to turn on the TV.
- 2** Press the TV CH (or) button to set the channel.

Other buttons available for operating TVs

Operation	Button
Volume control	
Switching the input	

> Changing the TV registration

- 1** While holding down the TV button, enter the manufacturer setting number (4 digits).
- 2** Release the TV button.
The setting is registered and the TV can be operated with the remote control of this unit.

Notes:

- You cannot operate some Sharp TVs with the remote control.
- As for manufacturers with 2 or more setting numbers, select one with which you can operate the TV.
- Once you set a number, the number previously memorized will be canceled.
- After replacing the batteries in the remote control, the registered number may automatically be set to 1044 (SHARP). If it occurs, register the desired number again.
- Registration cannot be executed depending on TVs. Even if numbers can be set, some buttons may not work.

TV manufacturer	Setting number	TV manufacturer	Setting number
SHARP	1011, 1025, 1044 (*)	BELL & HOWELL	1005, 1021
AIWA	1052	BROCKWOOD	1007
ADMIRAL	1037	BROKSONIC	1032, 1037
AIKO	1019	CANDLE	1009, 1015
AKAI	1009	CARNIVALE	1009
ALARON	1031	CARVER	1014, 1026
AMBASSADOR	1029	CELEBRITY	1001
AMPRO	1045	CINERAL	1019, 1036
AMSTRAD	1034	CITIZEN	1009, 1011, 1015, 1016, 1019
ANAM	1004, 1024, 1035	CME	1039
ANAM NATIONAL	1024, 1035	CONCERTO	1015
AOC	1007, 1009	CRAIG	1024
AUDIOVOX	1019, 1036, 1041	CROSLEY	1014
BAUR	1039	CROWN	1011
BELCOR	1007		

(*): The default manufacturer number is 1044 (SHARP).

TV manufacturer	Setting number	TV manufacturer	Setting number
CURTIS MATHES	1005, 1009, 1011, 1012, 1013, 1014, 1015, 1016, 1020, 1021, 1036, 1038, 1044, 1048, 1050	INTEQ	1006
		INTERFUNK	1039
		JBL	1014
		JCB	1001
		JVC	1018, 1023
DAEWOO	1007, 1011, 1017, 1019, 1021, 1036, 1041, 1042	KENWOOD	1007, 1009
		KONIG	1039
		KTV	1009, 1011
DAYTRON	1007	LG	1015
DENON	1020	LOEWE	1039
DUMONT	1006, 1007	LOGIK	1005
DWIN	1044, 1046	LUXMAN	1015
ELECTRONBAND	1001	LXI	1012, 1014, 1021, 1022, 1030
EMERSON	1007, 1010, 1011, 1021, 1029, 1030, 1031, 1032, 1037, 1041, 1042	MAGNAVOX	1009, 1014, 1031
		MAJESTIC	1005
		MARANTZ	1009, 1014
		MEGATRON	1020, 1030
ENVISION	1009	MEMOREX	1005, 1015, 1021, 1030, 1037
ETRON	1043	METZ	1007, 1009, 1030
FISHER	1021	MGA	1007, 1009, 1028
FORTRESS	1044	MIDLAND	1006, 1011, 1012, 1013
FUJITSU	1031	MINOKA	1034
FUNAI	1027, 1031	MINUTZ	1008
		MITSUBISHI	1007, 1030, 1039
GE	1008, 1012, 1013, 1030, 1036, 1048, 1050	MTC	1007, 1009, 1015, 1016, 1039
GIBRALTER	1006, 1007, 1009	NAD	1022, 1030
GOLDSTAR	1002, 1007, 1009, 1011, 1015, 1030	NEC	1007, 1009, 1015, 1026
GRADIENTE	1015, 1026	NIKKO	1009, 1019, 1030
GRANADA	1033	NTC	1019
GRUNPY	1031	OPTIMUS	1021
HALLMARK	1030	OPTONICA	1025, 1044
HARLEY DAVIDSON	1031	ORION	1031, 1032, 1037
HARMAN/KARDON	1014	OSAKA	1034
HCM	1034		
HITACHI	1010, 1015, 1020		
INFINITY	1014		

TV manufacturer	Setting number	TV manufacturer	Setting number		
OTTO	1039	SCOTT	1007, 1030, 1031, 1032		
PANASONIC	1013, 1024	SEARS	1012, 1014, 1015, 1021, 1022, 1027, 1030, 1031		
PENNEY	1003, 1007, 1008, 1009, 1011, 1012, 1013, 1015, 1016, 1022, 1030, 1050			SEMP	1022
				SHOGUN	1007
PHILCO	1007, 1009, 1014, 1020, 1037	SIGNATURE	1005		
PHILIPS	1014	SONY	1001		
PILOT	1007, 1009, 1011	SOUNDESIGN	1030, 1031		
PIONEER	1010, 1028	SQUAREVIEW	1027		
PORTLAND	1007, 1011, 1019	SSS	1007		
PRISM	1013	SUPREME	1001		
PROSOCAN	1012	SYLVANIA	1009, 1014		
PROTON	1030, 1038	SYMPHONIC	1027		
PULSAR	1006, 1007	TANDY	1044		
QUASAR	1013, 1025	TECHNICS	1013		
QUELLE	1039	TECHNOL ACE	1031		
RADIO SHACK	1007, 1009, 1011, 1012, 1015, 1028, 1030	TECHWOOD	1013, 1015		
		TEKNIKA	1005, 1007, 1011, 1014, 1015, 1016, 1019, 1031		
RCA	1007, 1010, 1012, 1013, 1044, 1047, 1048, 1049, 1050, 1051	TELEFUNKEN	1015		
		THORN	1039		
		TMK	1015, 1029, 1030		
REALISTIC	1007, 1009, 1011, 1015, 1021, 1025, 1030	TOSHIBA	1016, 1021, 1022		
		TOTEVISION	1011		
		VECTOR RESEARCH	1009		
RUNCO	1006, 1009, 1040	VICTOR	1023		
SAMPO	1009, 1011	VIDIKRON	1014		
SAMSUNG	1007, 1009, 1015, 1016, 1030	VIDTECH	1007, 1030		
		WARDS	1005, 1007, 1008, 1009, 1014, 1015, 1025, 1030, 1031		
SAMSUX	1011	WHITE WESTINGHOUSE	1037, 1041, 1042		
SANSEI	1036				
SANSUI	1037				
SANYO	1021, 1033				
SCIMITSU	1007	YAMAHA	1007, 1009		
SCOTCH	1030	ZENITH	1005, 1006, 1019, 1037		

Mounting the unit on the wall

> Attaching the main unit bracket to the unit

- 1 Route all connection cables through the main unit bracket.

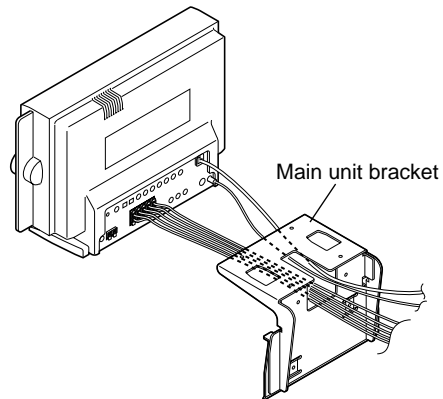

- 2 Attach the main unit bracket to the unit.

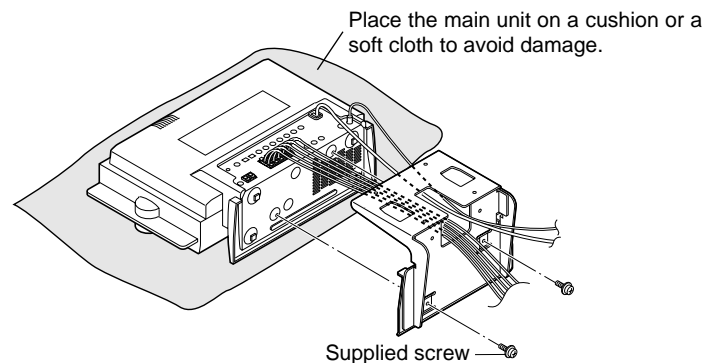

- Fix them securely with the supplied 2 screws.
- Do not use other screws. The unit may fall or break.

> Mounting the main unit bracket on the wall

VESA (*) compliant fittings (commercially available) can be attached to the main unit bracket.

A wall bracket and adaptor not supplied, but can be purchased.

Note:

(*) VESA (Video Electronics Standards Association) is an organization to promote the standardization of digital imaging device for PCs.

Types of fittings:

Fittings must satisfy the following.

- Compatible with the VESA standard.
- Have a gap of 3.973" (100 mm) × 3.973" (100 mm) between the screw holes on the section to be attached.
- Sturdy and stable to prevent fall or breakage.

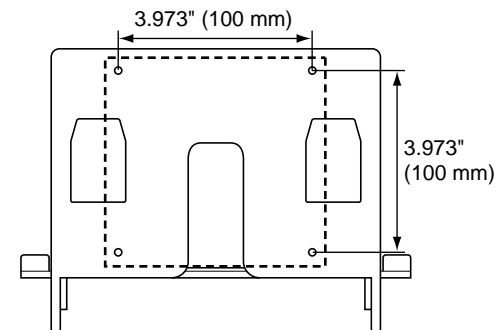

How to attach the main unit bracket

- There are four VESA (*) screw holes on the main unit bracket. You can use commercially available fittings for mounting.
- **Follow the method recommended by the bracket manufacturer.**

Warning:

- Install brackets properly following the operation manual. Improper installation may cause the main unit to fall leading to injury or breakage.
- To ensure a proper installation, contact your dealer or installer.
- During installation, be careful not to pinch your fingers.
- The wall should be strong enough to support the weight of the main unit. (Install on a reinforced part.)
- Do not impose an extra load on a wall bracket. It may cause the main unit to fall leading to injury or breakage.
- Do not modify or change the main unit bracket. It may cause the main unit to fall leading to injury or breakage.

Caution:

- Do not block the ventilation opening of the main unit with a tablecloth, etc. Heat may be kept inside causing fire.
- Select a mounting position carefully to avoid injury by hitting head.
- Never step on or hang from the main unit. Pay special attention to children. It may cause injury or breakage to the main unit.
- **Check the wall strength. SHARP is not liable for accidents caused by insufficient strength of the wall or improper mounting.**
- **Improper mounting may cause the main unit to fall. If you need assistance, contact your dealer or installer.**

Connecting other equipment

ENGLISH

Turn off the other equipment before making this connection.

- An optical digital cable, audio digital cable and audio cable are not supplied. Purchase an optional or commercially available cable.
- If using an audio cable, purchase one without resistance. If you use an audio cable with resistance, sound volume will decrease.

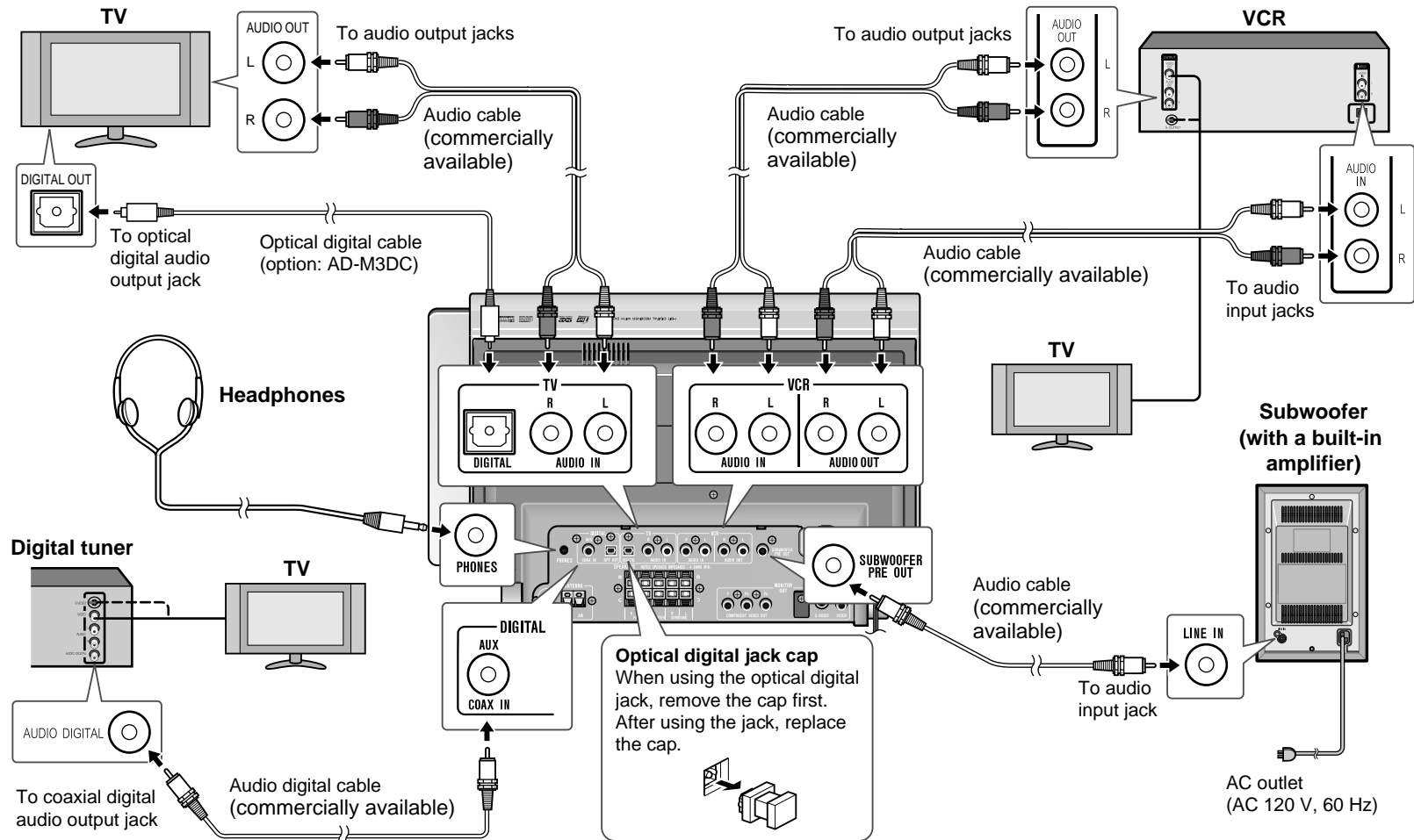

> Audio connection to TV

You can listen to TV sound from the speakers by connecting the unit using an optical digital cable or audio cable (not supplied).

To listen to TV sound:

Turn the power on and press the TV button.

Each press of this button changes the input in the order of "AUTO"→"DIGITAL"→"ANALOG".

AUTO: The audio input switches automatically. (*)

DIGITAL: The audio input is switched to digital.

ANALOG: The audio input is switched to analog.

(*) When digital and analog signals are received, the unit selects digital signals.

Notes:

- Plug in each cable fully to prevent noise interference.
- Refer to the manual for the connected equipment.
- You can also use the FUNCTION button to set the input to TV.

> Audio connection to VCR

You can listen to VCR sound from the speakers by connecting the unit using an audio cable.

To listen to VCR sound:

Turn the power on and press the VCR button.

Notes:

- The audio VCR output jacks sends signals coming from a DVD/CD, the tuner, audio TV input jacks, digital audio input jack, and digital audio TV input jack. Signals from the audio VCR input jacks are not sent.
- When sending signals coming from the digital audio input jack or digital audio TV input jack via the audio VCR output jacks on the unit, set the stereo mode to "STEREO" (see page 38). In the multi channel mode, signals may not be sent properly. When sending signals from the digital audio input jack to the audio VCR output jacks, the audio output level decreases. (Leave headphones unplugged while recording to avoid further level decrease.)
- Plug in each cable fully to prevent noise interference.
- Refer to the manual for the connected equipment.
- You can also use the FUNCTION button to set the input to "VCR".

> Audio connection to a digital tuner

You can listen to sound from the digital tuner, etc. from the speakers by connecting the unit using an audio digital cable.

To listen to the digital tuner:

Turn the power on and press the AUX button.

Notes:

- You can also listen to the digital tuner sound by connecting the tuner to the digital audio TV input jack. Set the input to TV in this case.
- Plug in each cable fully to prevent noise interference.
- Refer to the manual for the connected equipment.
- You can also use the FUNCTION button to switch the input to auxiliary.

> Using other subwoofer

You can connect a subwoofer with an amplifier to the subwoofer pre output jack.

Note:

No sound is heard from the speaker in which an amplifier is not built in.

> Headphones

- Before plugging in or unplugging the headphones, reduce the volume.
- Be sure your headphones have a 1/8" (3.5 mm) diameter plug and are between 16 ohm and 50 ohm impedance. The recommended impedance is 32 ohms.
- While headphones are connected, sound is not produced from the speakers.
- You cannot use the surround feature with headphones.
- Do not plug in or unplug headphones while recording. The sound may skip.

Connecting other equipment (continued)

Turn off the other equipment before making this connection.

An optical digital cable is not supplied.
Purchase an optional optical digital cable.

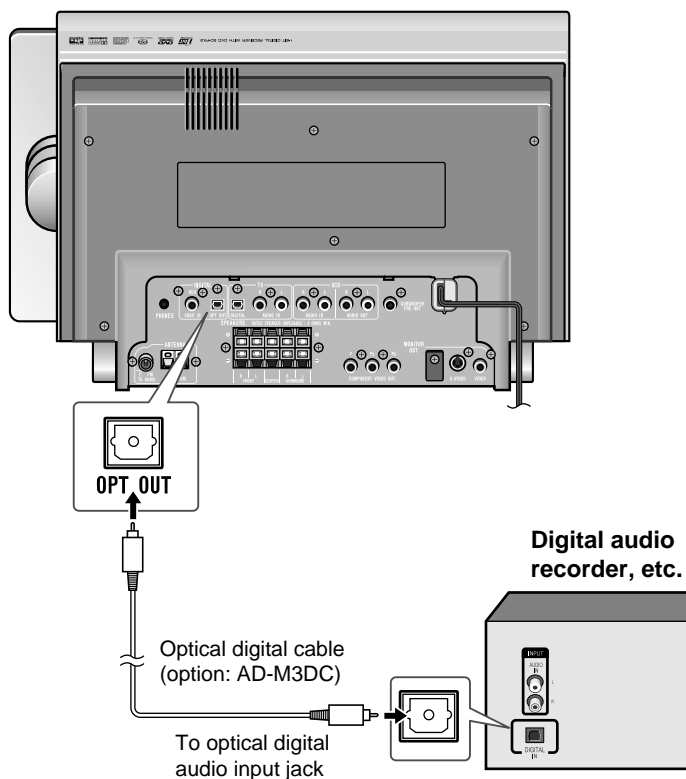

> Digital connection to a digital audio recorder, etc.

You can record sound on a digital audio recorder by connecting to the digital audio output jack using an optical digital cable.

When connecting a digital audio recorder to the digital audio output jack, set the "DIGITAL" to "D-PCM" (see page 39).

BITSTREAM	For 5.1 channel Dolby Digital/DTS surround processors, etc.
D-PCM	For 2 channel digital input amplifiers, etc.

To record sound on a digital audio recorder:

Turn the power on and press the **■** button.

Notes:

- Some discs are copy protected and digital recording is not possible (including DTS signals).
- The digital audio output jack sends signals coming from a DVD/CD, the digital audio TV input jack, and digital audio input jack. Signals from the tuner, audio TV input jacks and the audio VCR input jacks are not sent.
- When you play DVD-Video discs with Linear PCM sound recorded at a 96 kHz sampling rate, sound may be sampled at 96 kHz (or 48 kHz depending on the disc).
- The digital audio output jack does not send signals coming from SACD or MP3 discs.**
- In DVD-Audio playback, the digital audio output jack does not send some signals. Also, the sampling rate of digital audio signals may reduce or no signals may be sent.**
- Plug in each cable fully to prevent noise interference.

Maintenance

> Cleaning the cabinet

Periodically wipe the cabinet with a soft cloth and a diluted soap solution, then with a dry cloth.

- Do not use chemicals for cleaning (gasoline, paint thinner, etc.). It may damage the cabinet finish.
- Do not apply oil to the inside of the unit. It may cause malfunctions.

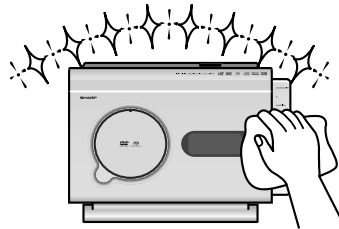

> Cleaning the laser pickup lens

Do not touch the laser pickup lens. If fingerprints or dust accumulate on the pickup, clean it gently with a dry cotton swab.

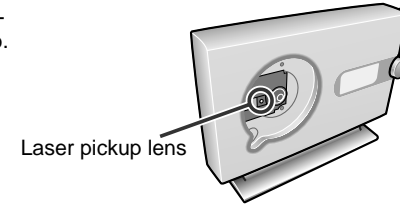

Notes:

- Close the disc compartment when it is not used.
- Be careful not to damage the optical pickup or to touch it by hand.

Error indicators and warnings

When you load an unplayable disc or fail to perform operations properly, the following messages are displayed on the unit and the TV screen.

Display	Meaning
DSP NG	Place the unit away from noise source or plug the AC power cord to another AC outlet. (*)
Er-** (** indicates numbers/symbols.)	<ul style="list-style-type: none"> The unit considers the DVD mechanism is defective. The amplifier is defective. Set this unit to the stand-by mode and turn the power on again. (*)
FAN LOCK	<ul style="list-style-type: none"> The cooling fan on the back of the main unit does not run due to foreign objects caught in it. Set this unit to the stand-by mode and remove the foreign objects around the fan.
NO DISC	<ul style="list-style-type: none"> The disc is not loaded. The disc is loaded upside down.
NO PLAY	The disc's region number is neither 1 nor ALL.
No Signal	<ul style="list-style-type: none"> The digital audio input jack is not connected properly. Unspecified signal is received and cannot be recognized.

(*): Should the same message appear even if the unit is unplugged and plugged in or is set to the stand-by mode and on again, contact your local dealer where you purchased the unit.

TV screen	Meaning
	The disc cannot be played with this unit or the disc is loaded in an incorrect way.
	The region number of the DVD is not "1" or "ALL".
	A disc has not been loaded.
	<ul style="list-style-type: none"> You are trying to perform an incorrect operation. The operation is prohibited.
	The disc does not support the operation described in this operation manual.

Troubleshooting chart

Many potential problems can be resolved by the owner without calling a service technician.

If something is wrong with this product, check the following before calling your authorized SHARP dealer or service center.

> General

Symptom	Possible cause	Reference page
No sound is heard.	<ul style="list-style-type: none"> • Is the volume level set to "0"? • Are the headphones connected? • Are the speaker wires disconnected? 	P. 16 P. 55 P. 11
The sounds from speakers are not well balanced.	<ul style="list-style-type: none"> • Are the speaker wires connected to the wrong channels? 	P. 11
Noise is heard during playback.	<ul style="list-style-type: none"> • Move the unit away from any computers or mobile phones. 	—
When a button is pressed, the unit does not respond.	<ul style="list-style-type: none"> • Set this unit to the power stand-by mode and then turn it back on. If the unit still malfunctions, reset it. 	P. 60
Interference or noise occurs on the TV image.	<ul style="list-style-type: none"> • Is the unit placed near TV with internal antenna? Use an outdoor antenna. 	P. 12
Timer playback does not start.	<ul style="list-style-type: none"> • Did you remove the plug from the AC outlet, or did a power failure occur? Reset the clock and timer. 	P. 15, 48
"CLOCK ADJUST" appears when checking the clock.	<ul style="list-style-type: none"> • Did you remove the plug from the AC outlet, or did a power failure occur? Reset the clock. 	P. 15
The display on the unit is dark.	<ul style="list-style-type: none"> • Is the display in the dimmer mode? 	P. 16
The display does not appear.	<ul style="list-style-type: none"> • Is the sliding door open? 	P. 17
The power is not turned on.	<ul style="list-style-type: none"> • Is the unit unplugged? 	P. 14
No images are displayed.	<ul style="list-style-type: none"> • Is TV turned on? • Is the input of TV switched? 	P. 51 P. 51

> Tuner

Symptom	Possible cause	Reference page
The radio makes unusual noises continuously.	<ul style="list-style-type: none"> • Is the unit placed near the TV or computer? • Is the FM antenna or AM loop antenna placed properly? Move the antenna away from the AC power cord or the unit if located near. 	— P. 12
The preset channel cannot be recalled.	<ul style="list-style-type: none"> • Did you remove the plug from the AC outlet, or did a power failure occur? Preset the channel again. 	P. 34

> Remote control

Symptom	Possible cause	Reference page
The remote control does not operate properly.	<ul style="list-style-type: none"> • Is the battery polarity respected? • Are the batteries dead? • Is the distance or angle incorrect? • Are there any obstructions in front of the unit? • Is the remote control sensor exposed to strong light (inverter fluorescent light, direct sunlight, etc.)? • Is the remote control for another equipment used simultaneously? 	P. 14 — P. 14 — P. 14 —
The unit cannot be turned on with the remote control.	<ul style="list-style-type: none"> • Is the AC power cord of the unit plugged in? • Are the batteries inserted? 	P. 14 P. 14

> DVD/CD player

Symptom	Possible cause	Reference page
Even though a disc is loaded, "NO PLAY" is displayed. Playback sounds are skipped.	<ul style="list-style-type: none"> * Is the disc loaded upside down? * Is the disc very dirty? * Does the disc satisfy the standards? * Is the unit located near excessive vibrations? * Has condensation formed inside the unit? 	<ul style="list-style-type: none"> — — — — P. 60
The control buttons do not function. Music or video playback is interrupted.	<ul style="list-style-type: none"> * Is the disc very dirty? * Does the disc satisfy the standards? * Is the unit located near excessive vibrations? * Has condensation formed inside the unit? 	<ul style="list-style-type: none"> — — — P. 60
Pictures and sound are skipped.	<ul style="list-style-type: none"> * Is the disc very dirty? * Is the unit located near excessive vibrations? * Has condensation formed inside the unit? 	<ul style="list-style-type: none"> — — P. 60
The system does not operate even if the power is on.	<ul style="list-style-type: none"> * Is a disc other than a DVD (region number 1 or ALL) and an audio CD loaded? 	<ul style="list-style-type: none"> P. 8
Image cannot be played back. (Sound is not heard.)	<ul style="list-style-type: none"> * Are the video and audio cables connected improperly? * Is a disc other than a DVD (region number 1 or ALL) and an audio CD loaded? * Is the disc very dirty? * Is the disc loaded upside down? * Clean the optical pickup if it is dirty. * Is the TV input set to "VIDEO 1/VIDEO 2" etc.? * Is the unit turned on? 	<ul style="list-style-type: none"> P. 13, 55 P. 8 — — P. 58 P. 51 P. 14

> Condensation

Sudden temperature changes, storage or operation in an extremely humid environment may cause condensation inside the cabinet (laser pickup, etc.) or on the transmitter on the remote control.

Condensation can cause the unit to malfunction. If this happens, leave the power on with no disc in the unit until normal playback is possible (about 1 hour). Wipe off any condensation on the transmitter with a soft cloth before operating the unit.

> If trouble occurs

When this product is subjected to strong external interference (mechanical shock, excessive static electricity, abnormal supply voltage due to lightning, etc.) or if it is operated incorrectly, it may malfunction.

If such a problem occurs, do the following:

Clearing all the memory (reset)

- 1 Unplug the unit.
- 2 While holding down the ON/STAND-BY button, plug in the AC power cord. "RESET" appears for about 1 second and the power turns off.

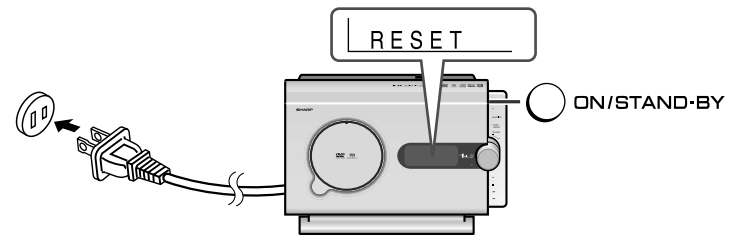

Caution:

When you reset, all data is deleted and the settings return to the default. (DVD initial settings are retained.)

Language code list for disc language

ENGLISH

References
- Language code list for disc language -

Code	Language name	Code	Language name
AA	Afar	FY	Frisian
AB	Abkhazian	GA	Irish
AF	Afrikaans	GD	Scots Gaelic
AM	Amharic	GL	Galician
AR	Arabic	GN	Guarani
AS	Assamese	GU	Gujarati
AY	Aymara	HA	Hausa
AZ	Azerbaijani	HI	Hindi
BA	Bashkir	HR	Croatian
BE	Byelorussian	HU	Hungarian
BG	Bulgarian	HY	Armenian
BH	Bihari	IA	Interlingua
BI	Bislama	IE	Interlingue
BN	Bengali; Bangla	IK	Inupiaq
BO	Tibetan	IN	Indonesian
BR	Breton	IS	Icelandic
CA	Catalan	IT	Italian
CO	Corsican	IW	Hebrew
CS	Czech	JA	Japanese
CY	Welsh	JI	Yiddish
DA	Danish	JW	Javanese
DE	German	KA	Georgian
DZ	Bhutanese	KK	Kazakh
EL	Greek	KL	Greenlandic
EN	English	KM	Cambodian
EO	Esperanto	KN	Kannada
ES	Spanish	KO	Korean
ET	Estonian	KS	Kashmiri
EU	Basque	KU	Kurdish
FA	Persian	KY	Kirghiz
FI	Finnish	LA	Latin
FJ	Fiji	LN	Lingala
FO	Faroese	LO	Laotian
FR	French	LT	Lithuanian
		LV	Latvian, Lettish

Code	Language name	Code	Language name
MG	Malagasy	SN	Shona
MI	Maori	SO	Somali
MK	Macedonian	SQ	Albanian
ML	Malayalam	SR	Serbian
MN	Mongolian	SS	Siswati
MO	Moldavian	ST	Sesotho
MR	Marathi	SU	Sundanese
MS	Malay	SV	Swedish
MT	Maltese	SW	Swahili
MY	Burmese	TA	Tamil
NA	Nauruan	TE	Telugu
NE	Nepali	TG	Tajik
NL	Dutch	TH	Thai
NO	Norwegian	TI	Tigrinya
OC	Occitan	TK	Turkmen
OM	(Afan) Oromo	TL	Tagalog
OR	Oriya	TN	Setswana
PA	Panjabi	TO	Tonga
PL	Polish	TR	Turkish
PS	Pashto, Pushto	TS	Tsonga
PT	Portuguese	TT	Tatar
QU	Quechua	TW	Twi
RM	Rhaeto-Romance	UK	Ukrainian
RN	Kirundi	UR	Urdu
RO	Romanian	UZ	Uzbek
RU	Russian	VI	Vietnamese
RW	Kinyarwanda	VO	Volapuk
SA	Sanskrit	WO	Wolof
SD	Sindhi	XH	Xhosa
SG	Sango	YO	Yoruba
SH	Serbo-Croatian	ZH	Chinese
SI	Singhalese	ZU	Zulu
SK	Slovak		
SL	Slovenian		
SM	Samoan		

Specifications

As part of our policy of continuous improvement, SHARP reserves the right to make design and specification changes for product improvement without prior notice. The performance specification figures indicated are nominal values of production units. There may be some deviations from these values in individual units.

> General

Power source	AC 120 V, 60 Hz
Power consumption	60 W
Dimensions	Width: 14-1/2" (368 mm) Height: 9-11/16" (245 mm) Depth: 4-1/2" (114 mm)
Weight	8.2 lbs. (3.7 kg)
Audio output terminals	Front speakers, Center speaker and Surround speakers: more than 4 ohms Headphones: 16 - 50 ohms (recommended: 32 ohms) Subwoofer pre-out: RCA type × 1 Optical digital output: Square type × 1 Audio output (VCR): RCA type × 1 pair (L/R)
Audio input terminals	Audio input (TV, VCR): RCA type × 2 pairs (L/R) Coaxial digital input (AUX): RCA type × 1 Optical digital input (TV): Square type × 1
Monitor output terminals	Video output: RCA type × 1 S-video output: S-terminal × 1 Component video output: RCA type × 3

> Amplifier

Amplification system	5.6448 MHz (128 fs) 1-bit switching (Remarks: fs = 44.1 kHz)
Power output (FTC)	25 watts minimum RMS per channel into 4 ohms from 120 Hz to 20 kHz, 2 % total harmonic distortion
Rated power output	Front: 35 W + 35 W, Center: 35 W, Surround: 35 W + 35 W (4 ohms at 1 kHz)
A/D noise shaping	7th-order $\Delta \Sigma$ (delta - sigma) modulation

> SACD/DVD player

Signal system	NTSC color	
Supported disc types	DVD-Video/Audio (Region number 1, ALL), SACD, DVD-R/RW (video mode), audio CD, CD-R, CD-RW	
Video signal	Horizontal resolution: 500 lines S/N ratio: 70 dB	
Audio signal	Frequency characteristics	Linear PCM DVD: 4 Hz to 22 kHz (sampling rate: 48 kHz) 4 Hz to 44 kHz (sampling rate: 96 kHz) CD: 4 Hz to 20 kHz
	S/N ratio	CD: 96 dB (1 kHz)
	Dynamic range	Linear PCM DVD: 95 dB CD: 94 dB
	Total harmonic distortion ratio	0.006 % maximum

> Tuner

Frequency range	FM: 87.5 - 108 MHz AM: 530 - 1,720 kHz
------------------------	---

VALID IN U.S.A. ONLY

CONSUMER LIMITED WARRANTY

SHARP ELECTRONICS CORPORATION warrants to the first consumer purchaser that this Sharp brand product (the "Product"), when shipped in its original container, will be free from defective workmanship and materials, and agrees that it will, at its option, either repair the defect or replace the defective Product or part thereof with a new or remanufactured equivalent at no charge to the purchaser for parts or labor for the period(s) set forth below.

This warranty does not apply to any appearance items of the Product nor to the additional excluded item(s) set forth below nor to any Product the exterior of which has been damaged or defaced, which has been subjected to improper voltage or other misuse, abnormal service or handling, or which has been altered or modified in design or construction.

In order to enforce the rights under this limited warranty, the purchaser should follow the steps set forth below and provide proof of purchase to the servicer.

The limited warranty described herein is in addition to whatever implied warranties may be granted to purchasers by law. ALL IMPLIED WARRANTIES INCLUDING THE WARRANTIES OF MERCHANTABILITY AND FITNESS FOR USE ARE LIMITED TO THE PERIOD(S) FROM THE DATE OF PURCHASE SET FORTH BELOW. Some states do not allow limitations on how long an implied warranty lasts, so the above limitation may not apply to you.

Neither the sales personnel of the seller nor any other person is authorized to make any warranties other than those described herein, or to extend the duration of any warranties beyond the time period described herein on behalf of Sharp.

The warranties described herein shall be the sole and exclusive warranties granted by Sharp and shall be the sole and exclusive remedy available to the purchaser. Correction of defects, in the manner and for the period of time described herein, shall constitute complete fulfillment of all liabilities and responsibilities of Sharp to the purchaser with respect to the Product, and shall constitute full satisfaction of all claims, whether based on contract, negligence, strict liability or otherwise. In no event shall Sharp be liable, or in any way responsible, for any damages or defects in the Product which were caused by repairs or attempted repairs performed by anyone other than an authorized servicer. Nor shall Sharp be liable or in any way responsible for any incidental or consequential economic or property damage. Some states do not allow the exclusion of incidental or consequential damages, so the above exclusion may not apply to you. THIS WARRANTY GIVES YOU SPECIFIC LEGAL RIGHTS. YOU MAY ALSO HAVE OTHER RIGHTS WHICH VARY FROM STATE TO STATE.

Model Specific Section

Your Product Model Number & Description:

SD-PX2 1-Bit Digital Receiver with DVD

(Be sure to have this information available when you need service for your Product.)

Warranty Period for this Product:

One (1) year parts and labor from the date of purchase.

Additional Item(s) Excluded from Warranty Coverage (if any):

Non-functional accessories, supplies, and consumable items.

Where to Obtain Service:

At a Sharp Authorized Servicer located in the United States.

To find a location of the nearest Sharp Authorized Servicer, call Sharp toll free at 1-800-BE-SHARP.

What to do to Obtain Service:

Ship prepaid or carry in your Product to a Sharp Authorized Servicer.

Be sure to have **Proof of Purchase** available. If you ship the Product, be sure it is insured and packaged securely.

TO OBTAIN SUPPLY, ACCESSORY OR PRODUCT INFORMATION, CALL **1-800-BE-SHARP**.

SHARP

SHARP ELECTRONICS CORPORATION

Sharp Plaza, Mahwah, New Jersey 07430-2135

SHARP CORPORATION

PRINTED IN MALAYSIA
IMPRIMÉ EN MALAISIE
TINSKA014AWZZ
04A R AO ②

Free Manuals Download Website

<http://myh66.com>

<http://usermanuals.us>

<http://www.somanuals.com>

<http://www.4manuals.cc>

<http://www.manual-lib.com>

<http://www.404manual.com>

<http://www.luxmanual.com>

<http://aubethermostatmanual.com>

Golf course search by state

<http://golfingnear.com>

Email search by domain

<http://emailbydomain.com>

Auto manuals search

<http://auto.somanuals.com>

TV manuals search

<http://tv.somanuals.com>