

SHARP®

MICRO COMPONENT SYSTEM
MICRO-CHAÎNE
MIKRO KOMPONENTEN SYSTEM
MICRO SISTEMI

MODEL
MODÈLE
MODELL
MODELLO

XL-DAB10NH XL-DAB20NH

OPERATION MANUAL MODE D'EMPLOI BEDIENUNGSANLEITUNG MANUALE DI ISTRUZIONI

XL-DAB10NH

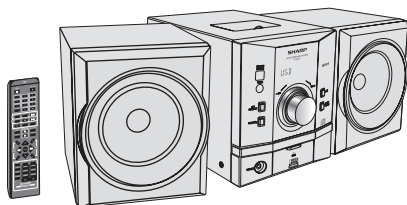

XL-DAB20NH

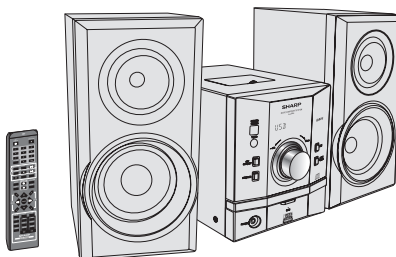

iPod is a trademark of Apple Inc., registered in the U.S. and other countries.



MP3



- | | | |
|----------|-----|--|
| ENGLISH | ... | Please refer to pages i to viii and E-1 to E-25. |
| FRANÇAIS | ... | Se reporter aux pages i à viii et F-1 à F-25. |
| DEUTSCH | ... | Siehe Seiten i bis viii und D-1 bis D-25. |
| ITALIANO | ... | Leggere le pagine i a viii e I-1 a I-25. |

BESONDERE ANMERKUNGEN
REMARQUES SPÉCIALES
NOTAS ESPECIALES
SÄRSKILDA ANMÄRKNINGAR
NOTE PARTICOLARI
BIJZONDERE OPMERKINGEN
NOTAS ESPECIAIS
ERITYISHUOMAUTUS
SPECIAL NOTES

● **Dichiarazione di conformità**

La società SHARP ELECTRONICS EUROPE GmbH dichiara che il prodotto SHARP MICRO SISTEMI XL-DAB10NH / XL-DAB20NH è costruito in conformità alle prescrizioni del D.M.no 548 del 28/8/95, pubblicato sulla G.U.no 301 del 28/12/95 ed in particolare è conforme a quanto indicato nell'art. 2, comma 1 dello stesso decreto.

- Bei Einstellung der ON/STAND-BY-Taste auf STAND-BY ist die Netzspannung immer noch im Gerät vorhanden. Wenn die ON/STAND-BY-Taste auf STAND-BY eingestellt wird, kann das Gerät unter Verwendung der Timer-Betriebsart oder Fernbedienung in Betrieb gesetzt werden.

Warnung:

In diesem Gerät sind keine vom Benutzer wartbaren Teile vorhanden. Niemals Abdeckungen entfernen, außer wenn Sie dafür qualifiziert sind. In diesem Gerät sind gefährliche Spannungen vorhanden. Vor Ausführung von irgendwelchen Kundendienstarbeiten oder bei längerer Nichtverwendung des Gerätes stets den Netzstecker aus der Netzsteckdose ziehen.

- Lorsque la touche ON/STAND-BY est mise en STAND-BY, l'appareil est toujours sous tension.

Lorsque la touche ON/STAND-BY se trouve sur la position STAND-BY, l'appareil est prêt à fonctionner par la minuterie ou la télécommande.

Avertissement:

Cet appareil contient des pièces non réparables par l'utilisateur. Personne non qualifiée n'enlèvera jamais les couvercles. L'appareil contient des organes portés à haute tension, débrancher l'appareil avant toute réparation ou en période de non-utilisation.

- Cuando el botón ON/STAND-BY está puesto en la posición STAND-BY, todavía hay tensión dentro del aparato.

Cuando el botón ON/STAND-BY está puesto en la posición STAND-BY, el aparato puede ponerse en funcionamiento utilizando el modo del temporizador o el controlador remoto.

Advertencia:

Tenga en cuenta que dentro de este aparato no hay piezas que pueda reparar. No quite nunca las tapas a menos que se esté cualificado para hacerlo. Este aparato tiene en su interior tensiones peligrosas. Desenchufe siempre la clavija de la red del tomacorriente antes de realizar cualquier servicio de mantenimiento y cuando no se use el aparato durante un largo período de tiempo.

- När ON/STAND-BY knappen är i läge STAND-BY, finns nätspänning i apparaten.

Med ON/STAND-BY knappen i läge STAND-BY kan apparaten startas med timerfunktion eller fjärrkontrollen.

Varning:

Apparaten innehåller inga delar som kan åtgärdas av kunden. Höljet får endast öppnas av kvalificerad personal. Apparaten innehåller farliga spänningar. Stickkontakten ska därför dras ut från nätuttaget före reparationsarbeten och bör dras ut om apparaten inte ska användas på mycket länge.

- Quando il tasto ON/STAND-BY si trova in posizione STAND-BY, all'interno dell'apparecchio c'è ancora la corrente. Se il tasto ON/STAND-BY si trova nella posizione STANDBY, l'unità può essere accesa con il modo timer o con il telecomando.

Avvertenza:

L'apparecchio non contiene parti riparabili dall'utente. Non togliere mai i coperchi, a meno di non essere qualificati per farlo. All'interno dell'apparecchio ci sono tensioni pericolose, per cui si deve sempre staccare la spina del cavo d'alimentazione dalla presa di corrente prima di qualsiasi intervento di manutenzione e quando non si usa l'apparecchio per un lungo periodo di tempo.

- Wanneer de ON/STAND-BY toets in de STAND-BY stand staat, loopt er nog steeds stroom (netspanning) in het toestel.

Wanneer de ON/STAND-BY toets in de STAND-BY stand staat, kan het toestel ingeschakeld worden via de timerfunctie of de afstandsbediening.

Waarschuwing:

Dit toestel bevat geen door de gebruiker te repareren onderdelen. Verwijder de behuizing nooit tenzij u deskundig bent op dit gebied. In het toestel loopt een gevaarlijke spanning; haal de stekker altijd uit het stopcontact alvorens onderhoud uit te voeren of wanneer het toestel voor langere tijd niet gebruikt wordt.

- Quando o botão ON/STAND-BY estiver ajustado na posição STAND-BY, a voltagem de alimentação ainda se encontra presente dentro do aparelho.

Quando o botão ON/STAND-BY estiver ajustado na posição STAND-BY, o aparelho pode ser colocado em operação através do modo de programação horária ou pelo controle remoto.

Advertência:

Neste aparelho não há partes que podem ser consertadas pelo usuário. Nunca retire a tampa, a menos que você tenha qualificação para tal. Este aparelho contém voltagens perigosas. Remova sempre o cabo de alimentação da tomada antes de efetuar qualquer conserto ou quando deixar o aparelho muito tempo fora de uso.

- Kun ON/STAND-BY -kytkin on STAND-BY-asenossa, laitteessa on yhä virta.

Kun ON/STAND-BY -kytkin on STAND-BY-asenossa, laite voidaan kytkeä päälle kaukosäätimestä.

Varoitus:

Laitteen sisällä ei ole käyttäjän huollettavissa olevia osia. Kotelon saa irrottaa vain siihen pätevyitynyt henkilö. Laitteen sisällä on vaarallinen jännite. Laite on aina irrotettava verkkovirrasta ennen huoltotoimenpiteitä ja jos laite on pitkään käyttämättä.

- When the ON/STAND-BY button is set at STAND-BY position, mains voltage is still present inside the unit.

When the ON/STAND-BY button is set at STAND-BY position, the unit may be brought into operation by the timer mode or remote control.

Warning:

This unit contains no user serviceable parts. Never remove covers unless qualified to do so. This unit contains dangerous voltages, always remove mains plug from the socket before any service operation and when not in use for a long period.

- När ON/STAND-BY-knappen er sat i STAND-BY positionen, er der stadig netspænding til stede i apparatet.

Når ON/STAND-BY-knappen er sat i STAND-BY position, kan apparatet startes v.h.j.a. timer-funktionen eller fjernbetjeningen.

Advarsel:

Apparatet indeholder ingen dele, der kan repareres af brugeren selv. Fjern aldrig kabinettet med mindre De er kvalificeret hertil. Apparatet indeholder farlig strømspænding. Traek altid stikket ud af stikkontakten før der foretages reparationer, eller hvis apparatet ikke er i brug i længere tid.

PŘED SEJMUTÍM KRYTU NUTNO VYJMOUT VIDLICI ZE SÍŤOVÉ ZÁSUVKY.

PRED ZLOŽENÍM KRYTU JE NUTNÉ ODPOJĚT PŘÍSTROJ ZO SIETE.

DENNA APPARAT ÄR ANSLUTEN TILL 230 V VÄXELSTRÖM NÄR STICKPROPPEN ÄR INSKJUTEN I VÄGGUTTAGET. FÖR ATT FULLSTÄNDIGT KOPPLA IFRÅN APPARATEN, V.G. DRAG UT STICKPROPPEN.

● Audio-visuelles Material kann Urheberrechte umfassen, die ohne Genehmigung des Eigentümers dieser Urheberrechte nicht aufgenommen werden dürfen. Siehe die entsprechenden nationalen Gesetze.

● Le matériel audio-visuel peut comporter des oeuvres faisant l'objet de droits d'auteur qui ne peuvent être enregistrées sans l'autorisation du possesseur du droit d'auteur, veuillez vous référer aux réglementations nationales en vigueur.

● El material audiovisual puede consistir en trabajos que tengan derechos de autor y que no deben grabarse sin la autorización del poseedor de dichos derechos de autor. Sírvase consultar las leyes aplicables en su país.

● Audiovisuellt material kan innehålla upphovsrättsarbete som inte skall mångfaldigas utan tillstånd av copyrightinnehavaren. Se den tillämpliga lagen i ditt land.

● Il materiale audio-visivo che fosse soggetto a copyright non può essere registrato senza l'autorizzazione del possessore del copyright. Si prega di attenersi alle leggi in vigore sul territorio nazionale.

● Audio-visueel materiaal kan worden beschermd door auteursrechten, in welk geval het niet mag worden opgenomen zonder de toestemming van de auteursrechthouder. Zie voor nadere informatie de betreffende wetten in het land van gebruik.

● O material audiovisual pode consistir de trabalhos de direitos autorias que não devem ser gravados sem autorização do proprietário dos direitos. Favor consultar as leis vigentes em seu país.

● Audiovisuaalinen materiaali saattaa olla tekijänoikeudella suojattua, eikä sitä tällöin saa tallentaa ilman tekijänoikeuden haltijan lupaa. Lisätietoja on maassasi sovellettavassa tekijänoikeuslaissa.

● Audio-visual material may consist of copyrighted works which must not be recorded without the authority of the owner of the copyright. Please refer to relevant law in your country.

● **Vorsicht:**
Das Gerät weder Tropf- noch Spritzwasser aussetzen. Ansonsten besteht die Gefahr eines Brandes oder elektrischen Schlages. Es dürfen keine mit Flüssigkeiten gefüllten Gegenstände wie Vasen auf dem Gerät abgestellt werden.

● **Attention:**
Pour éviter un incendie ou une secousse électrique, mettre l'appareil à l'abri de l'eau (éclaboussure, goutte). Ne pas poser sur l'appareil un récipient contenant du liquide.

● **Advertencia:**
Para evitar incendios y descargas eléctricas, no exponga el aparato a goteo o salpicadura de líquidos. No deberán ponerse encima del aparato objetos que estén llenos de líquido, como por ejemplo un florero.

● **Varning:**
Utsätt inte enheten för dropp eller stänk för att förhindra brand eller elektriska stötar. Inga vätskefyllda föremål såsom vasor får placeras på enheten.

● **Attenzione:**
Per prevenire incendi o scosse elettriche, non fare gocciolare nessun liquido sull'apparecchio e non bagnarlo. Non collocarvi sopra nessun oggetto riempito d'acqua, come per esempio vasi.

● **Waarschuwing:**
Stel het toestel niet bloot aan druipend of spattend water om brand en elektrische schokken te voorkomen. Met vloeistoffen gevulde voorwerpen, zoals vazen, mogen niet op het toestel geplaatst worden.

● **Cuidado:**
Para evitar incêndio ou choque elétrico, não exponha este aparelho a gotejamento ou salpicamento de água. Não coloque objetos com água como, por exemplo, um vaso de flores, em cima do aparelho.

● **Varoitus:**
Tulipalon tai sähkökiskun välttämiseksi laitetta ei saa altistaa tippuvalle tai roiskuvalle vedelle. Nestettä sisältäviä astioita kuten esim kukkamaljakoita ei saa asettaa laitteen päälle.

● **Warning:**
To prevent fire or shock hazard, do not expose this appliance to dripping or splashing. No objects filled with liquids, such as vases, shall be placed on the apparatus.

<p>● Advarsel: Til at forbygge ild og stød risiko, lad være med at undsaette denne indretning for drypning eller overstaenkning. Der må ikke anbringes nogen genstande fyldt med vand, som for eksempel vaser, på dette apparat.</p>
<p>● Advarsel: For å unngå brann eller kortslutning, utsett ikke produktet for vann eller fuktighet. Gjenstander som inneholder vaeske, feks. en blomstervase, må ikke plasseres oppå apparatet.</p>
<p>● Varoitus: Älä vie laitetta sateeseen tai kosteisiin tiloihin. Jos laite on kostunut, anna sen kuivua ennen kuin käytät sitä verkkovirralla. Nestettä sisältäviä astioita kuten esim. kukkamaljakoita ei saa asettaa laitteen päälle.</p>

<p>PŘÍSTROJ NEVYSTAVUJTE KAPAJÍCÍ NEBO STŘÍKAJÍCÍ VODĚ.</p>
<p>PŘÍSTROJ NEVYSTAVUJTE KVAPKAJÚCEJ ALEBO STRIEKAJÚCEJ VODE.</p>
<p>Urządzenie należy chronić przed zalaniem i wilgocią.</p>

<p>● Dieses Produkt ist ein Laserprodukt der Klasse 1.</p>
<p>● Ce produit est classifié comme étant un LASER DE CLASSE 1.</p>
<p>● Este producto está clasificado como un PRODUCTO LASER DE CLASE 1.</p>
<p>● Denna produkt klassificeras som KLASS 1 LASERPRODUKT.</p>
<p>● Questo prodotto è classificato come CLASS 1 LASER PRODUCT.</p>
<p>● Dit product is geclassificeerd als een KLASSE 1 LASER PRODUCT.</p>
<p>● Este produto é classificado como PRODUTO LASER DE CLASSE 1.</p>
<p>● Tämä laite on luokiteltu LUOKAN 1 LASERLAITTEEKSI.</p>
<p>● This product is classified as a CLASS 1 LASER PRODUCT.</p>

<p>● Dette produktet er klassifisert som et KLASSE 1 LASERPRODUKT.</p>
<p>● Dette produkt er klassificeret som et KLASSE 1 LASERPRODUKT.</p>
<p>● Tämä laite on luokiteltu LUOKAN 1 LASERLAITTEEKSI.</p>
<p>● Denna produkt klassificeras som KLASS 1 LASERAPPARAT.</p>
<p>● Tento výrobek je klasifikován jako LASEROVÝ VÝROBEK TŘÍDY 1.</p>
<p>● Tento výrobek je klasifikovaný ako LASEROVÝ VÝROBOK TRIEDY 1.</p>

<p>● VORSICHT Dieses Gerät enthält eine Schwachstrom-Lasereinheit. Um die sichere Funktionsweise des Gerätes zu gewährleisten, sollten keine Abdeckungen entfernt oder auf innen liegende Teile zugegriffen werden. Das Gerät sollte nur von qualifiziertem Personal gewartet und repariert werden.</p>
<p>● ATTENTION Ce produit contient un laser de faible puissance. Pour assurer la sécurité, éviter d'ôter l'enveloppe ou d'accéder à l'intérieur de ce produit. Pour toute réparation, s'adresser à une personne qualifiée.</p>
<p>● PRECAUCIÓN Este producto contiene un dispositivo de láser de poca potencia. Para mantener la seguridad, no extraiga ninguna cubierta ni intente acceder al interior del producto. Solicite todo el servicio técnico a una persona cualificada.</p>
<p>● VARNING Denna produkt innehåller en lågeffektlaser-enhet. För att säkra fortsatt säkerhet avlägsna inte något hölje och försök inte komma åt produktens inre. Vänd dig till behörig personal för all form av servicearbete.</p>
<p>● ATTENZIONE Questo prodotto contiene un dispositivo laser a bassa potenza. Per garantire la sicurezza non rimuovere alcuna copertura né tentare di accedere all'interno del prodotto. Per qualunque manutenzione, rivolgersi a personale qualificato.</p>
<p>● LET OP Dit product bevat een lasertoestel met een laag vermogen. Zorg ervoor dat de veiligheid gewaarborgd blijft, verwijder niet een deel van de behuizing en probeer niet door te dringen tot het binnenwerk van het product. Laat alle onderhoudswerkzaamheden over aan gekwalificeerde vakmensen.</p>
<p>● CUIDADO Este produto contém um aparelho laser de baixa potência. Para garantir a segurança continua não remover qualquer tampa ou tente obter acesso ao interior do produto. Consultar os serviços de pessoal qualificado.</p>
<p>● VAARA Tuotteessa on matalatehoinen laserlaite. Käyttöturvallisuuden takaamiseksi kotelo ei saa irrottaa eikä laitteen sisäosiin tule koskea. Laitteen saa huoltaa vain valtuutettu huoltohenkilöstö.</p>
<p>● CAUTION This product contains a low power laser device. To ensure continued safety do not remove any cover or attempt to gain access to the inside of the product. Refer all servicing to qualified personnel.</p>

VÝSTRAHA: VÝROBEK JE VYBAVEN LASEREM. PŘI NESPRÁVNÉ MANIPULACI S PŘÍSTROJEM V ROZPORU S TÍMTO NÁVODEM MŮŽE DOJÍT K NEBEZPEČNÉMU OZÁŘENÍ. NEOTVÍREJTE A NESNÍMEJTE PROTO ŽÁDNÉ KRYTY A PŘÍSTROJ NEOPRAVUJTE. OPRAVU A SERVIS SVĚŘTE ODBORNÉMU SERVISU.

VÝSTRAHA: VÝROBOK JE VYBAVENÝ LASEROM. PRI NESPRÁVNOM MANIPULOVANÍ S PŘÍSTROJOM V ROZPORE S TÝMTO NÁVODOM MÔŽE DÔJSŤ K NEBEZPEČNÉMU OŽIARENÍU. NEODKRÝVAJTE PRETO ŽIADNE KRYTY A PŘÍSTROJ NEOPRAVUJTE OPRAVU A SERVIS PRENECHAJTE ODBORNÉMU SERVISU.

„Made for iPod“ bedeutet, dass ein elektronisches Zubehörteil speziell für den Anschluss an ein iPod konzipiert wurde und der Entwickler dafür garantiert, dass das Gerät den Leistungsstandards von Apple entspricht.

« Made for iPod » signifie qu'un accessoire électronique a été conçu pour se connecter spécifiquement à un iPod et a été certifié par le développeur comme correspondant aux standards de performance d'Apple.

“Made for iPod” significa que se ha diseñado un accesorio electrónico para conectar específicamente al iPod y ha sido certificado por el fabricante para cumplir con las normas de rendimiento de Apple.

“Made for iPod” betyder att ett elektroniskt tillbehör har designats för att kopplas specifikt till en iPod och har certifierats av tillverkaren för att uppfylla Apples prestandanormer.

“Made for iPod” significa che un accessorio elettronico è stato progettato per essere specificamente collegato a iPod; inoltre, il produttore ne ha certificato la conformità agli standard di funzionamento Apple.

“Made for iPod” betekent dat een elektronisch accessoire specifiek is ontworpen voor aansluiting op de iPod en dat de ontwikkelaar garandeert dat voldaan wordt aan de eisen die Apple stelt aan het functioneren ervan.

A indicação “Made for iPod” significa que um acessório electrónico foi concebido para ligar-se especificamente ao iPod e foi certificado pelo fabricante para satisfazer os padrões de desempenho da Apple.

“Made for iPod” tarkoittaa sitä, että elektroninen lisälaite on suunniteltu nimenomaisesti iPod. Valmistaja on sertifioinut laitteen niin, että se vastaa Applen standardeja.

“Made for iPod” means that an electronic accessory has been designed to connect specifically to iPod and has been certified by the developer to meet Apple performance standards.

Apple ist nicht verantwortlich für den Betrieb dieses Gerätes oder dafür, dass es Sicherheits- und Regulierungsstandards einhält.
Apple n'est pas responsable de la manière de faire fonctionner cet appareil ni de sa conformité avec les standards de sécurité et de réglementation.
Apple no se responsabiliza por el funcionamiento de este dispositivo o por su cumplimiento con las normas de seguridad y regulatorias.
Apple ansvarar inte för användning av denna apparat eller dess överensstämmelse med säkerhetsnormer och föreskrifter.
Apple non si ritiene responsabile circa il funzionamento del presente dispositivo o la sua conformità con gli standard normativi e relativi alla sicurezza.
Apple is niet verantwoordelijk voor de werking van dit apparaat of zijn naleving aan veiligheids- en regelgevende maatstaven.
A Apple não é responsável pelo funcionamento deste aparelho ou pelo cumprimento das normas de segurança e regulamentares.
Apple ei ole vastuussa laitteen toiminnasta tai sen yhdenmukaisuudesta turvallisuus- ja sääntelystandardien kanssa.
Apple is not responsible for the operation of this device or its compliance with safety and regulatory standards.

Informations sur la mise au rebut correcte

A. Informations sur la mise au rebut à l'intention des utilisateurs privés (ménages)

1. Au sein de l'Union européenne

Attention : si vous souhaitez mettre cet appareil au rebut, ne le jetez pas dans une poubelle ordinaire!

Les appareils électriques et électroniques usagés doivent être traités séparément et conformément aux lois en vigueur en matière de traitement, de récupération et de recyclage adéquats de ces appareils.

Attention : votre produit comporte ce symbole. Il signifie que les produits électriques et électroniques usagés ne doivent pas être mélangés avec les déchets ménagers généraux. Un système de collecte séparé est prévu pour ces produits.

Suite à la mise en oeuvre de ces dispositions dans les Etats membres, les ménages résidant au sein de l'Union européenne peuvent désormais ramener gratuitement* leurs appareils électriques et électroniques usagés sur des sites de collecte désignés.

Dans certains pays*, votre détaillant reprendra également gratuitement votre ancien produit si vous achetez un produit neuf similaire.

*) Veuillez contacter votre administration locale pour plus de renseignements.

Si votre appareil électrique ou électronique usagé comporte des piles ou des accumulateurs, veuillez les mettre séparément et préalablement au rebut conformément à la législation locale en vigueur.

En veillant à la mise au rebut correcte de ce produit, vous contribuerez à assurer le traitement, la récupération et le recyclage nécessaires de ces déchets, et préviendrez ainsi les effets néfastes potentiels de leur mauvaise gestion sur l'environnement et la santé humaine.

2. Pays hors de l'Union européenne

Si vous souhaitez mettre ce produit au rebut, veuillez contacter votre administration locale qui vous renseignera sur la méthode d'élimination correcte de cet appareil.

Suisse : les équipements électriques ou électroniques usagés peuvent être ramenés gratuitement au détaillant, même si vous n'achetez pas un nouvel appareil. Pour obtenir la liste des autres sites de collecte, veuillez vous reporter à la page d'accueil du site www.swico.ch ou www.sens.ch.

B. Informations sur la mise au rebut à l'intention des entreprises

1. Au sein de l'Union européenne

Si ce produit est utilisé dans le cadre des activités de votre entreprise et que vous souhaitez le mettre au rebut:

Veuillez contacter votre revendeur SHARP qui vous informera des conditions de reprise du produit. Les frais de reprise et de recyclage pourront vous être facturés. Les produits de petite taille (et en petites quantités) pourront être repris par vos organisations de collecte locales.

Espagne: veuillez contacter l'organisation de collecte existante ou votre administration locale pour les modalités de reprise de vos produits usagés.

2. Pays hors de l'Union européenne

Si vous souhaitez mettre ce produit au rebut, veuillez contacter votre administration locale qui vous renseignera sur la méthode d'élimination correcte de cet appareil.

Entsorgungsinformationen

A. Entsorgungsinformationen für Benutzer aus Privathaushalten

1. In der Europäischen Union

Achtung: Werfen Sie dieses Gerät zur Entsorgung bitte nicht in den normalen Hausmüll!

Gemäß einer neuen EU-Richtlinie, die die ordnungsgemäße Rücknahme, Behandlung und Verwertung von gebrauchten Elektro- und Elektronikgeräten vorschreibt, müssen elektrische und elektronische Altgeräte getrennt entsorgt werden.

Nach der Einführung der Richtlinie in den EU-Mitgliedstaaten können Privathaushalte ihre gebrauchten Elektro- und Elektronikgeräte nun kostenlos an ausgewiesenen Rücknahmestellen abgeben*.

In einigen Ländern* können Sie Altgeräte u.U. auch kostenlos bei Ihrem Fachhändler abgeben, wenn Sie ein vergleichbares neues Gerät kaufen.

*) Weitere Einzelheiten erhalten Sie von Ihrer Gemeindeverwaltung. Wenn Ihre gebrauchten Elektro- und Elektronikgeräte Batterien oder Akkus enthalten, sollten diese vorher entnommen und gemäß örtlich geltenden Regelungen getrennt entsorgt werden.

Durch die ordnungsgemäße Entsorgung tragen Sie dazu bei, dass Altgeräte angemessen gesammelt, behandelt und verwertet werden. Dies verhindert mögliche schädliche Auswirkungen auf Umwelt und Gesundheit durch eine unsachgemäße Entsorgung.

2. In anderen Ländern außerhalb der EU

Bitte erkundigen Sie sich bei Ihrer Gemeindeverwaltung nach dem ordnungsgemäßen Verfahren zur Entsorgung dieses Geräts.

Für die Schweiz: Gebrauchte Elektro- und Elektronikgeräte können kostenlos beim Händler abgegeben werden, auch wenn Sie kein neues Produkt kaufen. Weitere Rücknahmesysteme finden Sie auf der Homepage von www.swico.ch oder www.sens.ch.

B. Entsorgungsinformationen für gewerbliche Nutzer

1. In der Europäischen Union

Wenn Sie dieses Produkt für gewerbliche Zwecke genutzt haben und nun entsorgen möchten:

Bitte wenden Sie sich an Ihren SHARP Fachhändler, der Sie über die Rücknahme des Produkts informieren kann. Möglicherweise müssen Sie die Kosten für die Rücknahme und Verwertung tragen. Kleine Produkte (und kleine Mengen) können möglicherweise bei Ihrer örtlichen Rücknahmestelle abgegeben werden.

Für Spanien: Bitte wenden Sie sich an das vorhandene Rücknahmesystem oder Ihre Gemeindeverwaltung, wenn Sie Fragen zur Rücknahme Ihrer Altgeräte haben.

2. In anderen Ländern außerhalb der EU

Bitte erkundigen Sie sich bei Ihrer Gemeindeverwaltung nach dem ordnungsgemäßen Verfahren zur Entsorgung dieses Geräts.



Achtung: Ihr Produkt trägt dieses Symbol. Es besagt, dass Elektro- und Elektronikgeräte nicht mit dem Hausabfall entsorgt, sondern einem getrennten Rücknahmesystem zugeführt werden sollten.

Información sobre la eliminación

A. Información sobre eliminación para usuarios particulares

1. En la Unión Europea

Atención: si quiere deshechar este equipo, por favor no utilice el cubo de la basura habitual!

Los equipos eléctricos y electrónicos usados deberían tratarse por separado de acuerdo con la legislación que requiere un tratamiento, una recuperación y un reciclaje adecuados de los equipos eléctricos y electrónicos usados.

Tras la puesta en práctica por parte de los estados miembros, los hogares de particulares dentro de los estados de la Unión Europea pueden devolver sus equipos eléctricos y electrónicos a los centros de recogida designados sin coste alguno.*

En algunos países* es posible que también su vendedor local se lleve su viejo producto sin coste alguno si Ud. compra uno nuevo similar.

*) Por favor, póngase en contacto con su autoridad local para obtener más detalles.

Si sus equipos eléctricos o electrónicos usados tienen pilas o acumuladores, por favor deséchelos por separado con antelación según los requisitos locales.

Al deshechar este producto correctamente, ayudará a asegurar que los residuos reciban el tratamiento, la recuperación y el reciclaje necesarios, previniendo de esta forma posibles efectos negativos en el medio ambiente y la salud humana que de otra forma podrían producirse debido a una manipulación de residuos inapropiada.

2. En otros países fuera de la Unión Europea

Si desea deshechar este producto, por favor póngase en contacto con las autoridades locales y pregunte por el método de eliminación correcto.

Para Suiza: Los equipos eléctricos o electrónicos pueden devolverse al vendedor sin coste alguno, incluso si no compra ningún nuevo producto. Se puede encontrar una lista de otros centros de recogida en la página principal de www.swico.ch o www.sens.ch.

B. Información sobre Eliminación para empresas usuarias

1. En la Unión Europea

Si el producto se utiliza en una empresa y quiere deshecharlo: Por favor póngase en contacto con su distribuidor SHARP quien le informará sobre la recogida del producto. Puede ser que le cobren los costes de recogida y reciclaje. Puede ser que los productos de tamaño pequeño (y las cantidades pequeñas) sean recogidos por sus centros de recogida locales.

Para España: por favor, póngase en contacto con el sistema de recogida establecido o con las autoridades locales para la recogida de los productos usados.

2. En otros países fuera de la Unión Europea

Si desea deshechar este producto, por favor póngase en contacto con sus autoridades locales y pregunte por el método de eliminación correcto.

Information om återvinning

A. Information om återvinning av elektrisk utrustning för hushåll

1. EU-länder

OBS! Kasta inte denna produkt i soporna! Förbrukad elektrisk utrustning måste hanteras i enlighet med gällande miljögästning och återvinningsföreskrifter.

I enlighet med gällande EU-regler ska hushåll ha möjlighet att lämna in elektrisk utrustning till återvinningsstationer utan kostnad.*

I vissa länder* kan det även hända att man gratis kan lämna in gamla produkter till återförsäljaren när man köper en ny liknande enhet.

*) Kontakta kommunen för vidare information.

Om utrustningen innehåller batterier eller ackumulatörer ska dessa först avlägsnas och hanteras separat i enlighet med gällande miljöföreskrifter.

Genom att hantera produkten i enlighet med dessa föreskrifter kommer den att tas om hand och återvinnas på tillämpligt sätt, vilket förhindrar potentiella negativa hälso- och miljöeffekter.

2. Länder utanför EU

Kontakta de lokala myndigheterna och ta reda på gällande sorterings- och återvinningsföreskrifter om du behöver göra dig av med denna produkt.

B. Information om återvinning för företag

1. EU-länder

Gör så här om produkten ska kasseras:

Kontakta SHARPs återförsäljare för information om hur man går till väga för att lämna tillbaka produkten. Det kan hända att en avgift för transport och återvinning tillkommer. Mindre skrymmande produkter (om det rör sig om ett fåtal) kan eventuellt återlämnas till lokala återvinningsstationer.

2. Länder utanför EU

Kontakta de lokala myndigheterna och ta reda på gällande sorterings- och återvinningsföreskrifter om du behöver göra dig av med denna produkt.



OBS! Produktens är märkt med symbolen ovan. Denna symbol indikerar att elektroniska produkter inte ska kastas i det vanliga hushållsavfallet eftersom det finns ett separat avfallshanteringssystem för dem.

Informazioni per un corretto smaltimento

A. Informazioni sullo smaltimento per gli utenti (privati)

1. Nell'Unione europea

Attenzione: Per smaltire il presente dispositivo, non utilizzare il normale bidone della spazzatura!

Le apparecchiature elettriche ed elettroniche usate devono essere gestite a parte e in conformità alla legislazione che richiede il trattamento, il recupero e il riciclaggio adeguato dei suddetti prodotti. In seguito alle disposizioni attuate dagli Stati membri, i privati residenti nella UE possono conferire gratuitamente le apparecchiature elettriche ed elettroniche usate a centri di raccolta designati*.

In alcuni paesi*, anche il rivenditore locale può ritirare gratuitamente il vecchio prodotto se l'utente acquista un altro nuovo di tipologia simile.

*) Per maggiori informazioni si prega di contattare l'autorità locale competente.

Se le apparecchiature elettriche o elettroniche usate hanno batterie o accumulatori, l'utente dovrà smaltirli a parte preventivamente in conformità alle disposizioni locali.

Lo smaltimento corretto del presente prodotto contribuirà a garantire che i rifiuti siano sottoposti al trattamento, al recupero e al riciclaggio necessari prevenendone il potenziale impatto negativo sull'ambiente e sulla salute umana, che potrebbe derivare da un'ineguale gestione dei rifiuti.

2. In paesi che non fanno parte dell'UE

Se si desidera eliminare il presente prodotto, contattare le autorità locali e informarsi sul metodo di smaltimento corretto.

Per la Svizzera: Le apparecchiature elettriche o elettroniche usate possono essere restituite gratuitamente al rivenditore, anche se non si acquista un prodotto nuovo. Altri centri di raccolta sono elencati sulle homepage di www.swico.ch o www.sens.ch.

B. Informazioni sullo smaltimento per gli utenti commerciali

1. Nell'Unione europea

Se il prodotto è impiegato a scopi commerciali, procedere come segue per eliminarlo.

Contattare il proprio rivenditore SHARP che fornirà informazioni circa il ritiro del prodotto. Potrebbero essere addebitate le spese di ritiro e riciclaggio. Prodotti piccoli (e quantitativi ridotti) potranno essere ritirati anche dai centri di raccolta locale.

Per la Spagna: Contattare il sistema di raccolta ufficiale o l'ente locale preposto al ritiro dei prodotti usati.

2. In paesi che non fanno parte dell'UE

Se si desidera eliminare il presente prodotto, contattare le autorità locali e informarsi sul metodo di smaltimento corretto.



Attenzione: Il dispositivo è contrassegnato da questo simbolo, che segnala di non smaltire le apparecchiature elettriche ed elettroniche insieme ai normali rifiuti domestici. Per tali prodotti è previsto un sistema di raccolta a parte.

Informatie over verantwoorde verwijdering

A. Informatie over afvalverwijdering voor gebruikers (particuliere huishoudens)

1. In de Europese Unie

Let op: Deze apparatuur niet samen met het normale huisafval weggoien!

Afgedankte elektrische en elektronische apparatuur moet gescheiden worden ingezameld conform de wetgeving inzake de verantwoorde verwerking, terugwinning en recycling van afgedankte elektrische en elektronische apparatuur.

Na de invoering van de wet door de lidstaten mogen particuliere huishoudens in de lidstaten van de Europese Unie hun afgedankte elektrische en elektronische apparatuur kosteloos* naar hiertoe aangewezen inzamelingsinrichtingen brengen*.

In sommige landen* kunt u bij de aanschaf van een nieuw apparaat het oude product kosteloos bij uw lokale distributeur inleveren.

*) Neem contact op met de plaatselijke autoriteiten voor verdere informatie.

Als uw elektrische of elektronische apparatuur batterijen of accumulatoren bevat dan moet u deze afzonderlijk conform de plaatselijke voorschriften weggoien.

Door dit product op een verantwoorde manier weg te gooien, zorgt u ervoor dat het afval de juiste verwerking, terugwinning en recycling ondergaat en potentiële negatieve effecten op het milieu en de menselijke gezondheid worden voorkomen die anders zouden ontstaan door het verkeerd verwerken van het afval.

2. In andere landen buiten de Europese Unie

Als u dit product wilt weggoien, neem dan contact op met de plaatselijke autoriteiten voor informatie omtrent de juiste verwijderingsprocedure.

Voor Zwitserland: U kunt afgedankte elektrische en elektronische apparatuur kosteloos bij de distributeur inleveren, zelfs als u geen nieuw product koopt. Aanvullende inzamelingsinrichtingen zijn vermeld op de startpagina van www.swico.ch of www.sens.ch.

B. Informatie over afvalverwijdering voor bedrijven

1. In de Europese Unie

Als u het product voor zakelijke doeleinden heeft gebruikt en als u dit wilt weggoien:

Neem contact op met uw SHARP distributeur die u inlichtingen verschaft over de terugnane van het product. Het kan zijn dat u een afvalverwijderingsbijdrage voor de terugnane en recycling moet betalen. Kleine producten (en kleine hoeveelheden) kunnen door de lokale inzamelingsinrichtingen worden verwerkt.

Voor Spanje: Neem contact op met de inzamelingsinrichting of de lokale autoriteiten voor de terugnane van uw afgedankte producten.

2. In andere landen buiten de Europese Unie

Als u dit product wilt weggoien, neem dan contact op met de plaatselijke autoriteiten voor informatie omtrent de juiste verwijderingsprocedure.

Informação sobre Eliminação de Produtos



Atenção: O seu produto está identificado com este símbolo. Significa que os produtos eléctricos e electrónicos não devem ser misturados com o lixo doméstico comum. Existe um sistema de recolhas específico para estes produtos.

A. Informações sobre a Eliminação de Produtos para os Utilizadores (particulares)

1. Na União Europeia

Atenção: Se quiser eliminar este equipamento, não o deve fazer juntamente com o lixo doméstico comum!

O equipamento eléctrico e electrónico deve ser tratado separadamente e ao abrigo da legislação aplicável que obriga a um tratamento, recuperação e reciclagem adequados de equipamentos eléctricos e electrónicos usados.

Após a implementação desta legislação por parte dos Estados-membros, todos os cidadãos residentes na União Europeia poderão entregar o seu equipamento eléctrico e electrónico usado em estações de recolha específicas a título gratuito*.

Em alguns países* o seu revendedor local também pode recolher o seu equipamento usado a título gratuito na compra de um novo equipamento.

*Contacte as entidades locais para mais informações.

Se o seu equipamento eléctrico e electrónico usado funcionar a pilhas ou baterias, deverá eliminá-las em separado, conforme a legislação local, e antes de entregar o seu equipamento.

Ao eliminar este produto correctamente estará a contribuir para que o lixo seja submetido aos processos de tratamento, recuperação e reciclagem adequados. Desta forma é possível evitar os efeitos nocivos que o tratamento inadequado do lixo poderia provocar no ambiente e na saúde.

2. Em outros Países fora da UE

Se quiser eliminar este produto, contacte as entidades locais e informe-se sobre o método correcto para proceder à sua eliminação. Na Suíça: O equipamento eléctrico e electrónico é aceite, a título gratuito, em qualquer revendedor, mesmo que não tenha adquirido um novo produto. Poderá encontrar uma lista das estações de recolha destes equipamentos na página da Web www.swicho.ch ou www.sens.ch.

B. Informações sobre a Eliminação de Produtos para Utilizadores-Empresas

1. Na União Europeia

Se o produto for usado para fins comerciais e quiser eliminá-lo: Contacte o seu revendedor SHARP que irá informá-lo sobre a melhor forma de eliminar o produto. Poderá ter de pagar as despesas resultantes da recolha e reciclagem do produto. Alguns produtos mais pequenos (e em pequenas quantidades) poderão ser recolhidos pelas estações locais.

Na Espanha: Contacte o sistema de recolhas público ou as entidades locais para mais informações sobre a recolha de produtos usados.

2. Em outros Países fora da UE

Se quiser eliminar este produto, contacte as entidades locais e informe-se sobre o método correcto para proceder à sua eliminação.

Information on Proper Disposal



Attention: Your product is marked with this symbol. It means that used electrical and electronic products should not be mixed with general household waste. There is a separate collection system for these products.

A. Information on Disposal for Users (private households)

1. In the European Union

Attention: If you want to dispose of this equipment, please do not use the ordinary dustbin!

Used electrical and electronic equipment must be treated separately and in accordance with legislation that requires proper treatment, recovery and recycling of used electrical and electronic equipment. Following the implementation by member states, private households within the EU states may return their used electrical and electronic equipment to designated collection facilities free of charge*.

In some countries* your local retailer may also take back your old product free of charge if you purchase a similar new one.

* Please contact your local authority for further details.

If you used electrical or electronic equipment has batteries or accumulators, please dispose of these separately beforehand according to local requirements.

By disposing of this product correctly you will help ensure that the waste undergoes the necessary treatment, recovery and recycling and thus prevent potential negative effects on the environment and human health which could otherwise arise due to inappropriate waste handling.

2. In other Countries outside the EU

If you wish to discard this product, please contact your local authorities and ask for the correct method of disposal.

For Switzerland: Used electrical or electronic equipment can be returned free of charge to the dealer, even if you don't purchase a new product. Further collection facilities are listed on the homepage of www.swico.ch or www.sens.ch.

B. Information on Disposal for Business Users

1. In the European Union

If the product is used for business purposes and you want to discard it:

Please contact your SHARP dealer who will inform you about the take-back of the product. You might be charged for the costs arising from take-back and recycling. Small products (and small amounts) might be taken back by your local collection facilities.

For Spain: Please contact the established collection system or your local authority for take-back of your used products.

2. In other Countries outside the EU

If you wish to discard of this product, please contact your local authorities and ask for the correct method of disposal.

Tietoja laitteen hävittämisestä



Huomio: Tuote on merkitty täällä symbolilla. Tämä tarkoittaa, että käytettyjä sähkö- ja elektroniikkalaitteita ei saa sekoittaa kotitalouden yleisjätteiden kanssa. Näille tuotteille on olemassa erillinen keräysjärjestelmä.

A. Hävitysohjeet käyttäjille (yksityiset kotitaloudet)

1. Euroopan unionissa

Huomio: Jos haluat hävittää tämän laitteen, älä käytä tavallista jätessäiliötä.

Käytetyt sähkö- ja elektroniikkalaitteet pitää hävittää erikseen noudattaen lainsäädäntöä, joka takaa käytettyjen sähkö- ja elektroniikkalaitteiden oikean käsittelyn, keräämisen ja kierrättämisen.

Jäsenvaltioiden täytäntöönpanoa seuraten yksityiset kotitaloudet EU:n jäsenvaltioissa voivat palauttaa käytetyt sähkö- ja elektroniikkalaitteet määrättyihin keräyspaikkoihin ilmaiseksi*. Joissakin maissa* paikalliset hävittämissyötävät voivat myös ottaa vastaan vanhan tuotteen ilmaiseksi, jos asiakas ostaa vastaavan uuden tuotteen.

* Pyydä lisätietoja paikallisviranomaisilta.

Jos käytetyissä sähkö- tai elektroniikkalaitteissa käytetään paristoja tai akkuja, hävitä nämä tuotteet etukäteen erikseen paikallisten säädösten mukaisesti.

Hävittämällä tuotteen asianmukaisesti, autat varmistamaan, että jätteet käsitellään, kerätään ja kierrätetään asianmukaisella tavalla. Näin vältetään haitallisia ympäristö- ja terveysvaikutuksia, joita saattaa olla seuraamuksena jätteen epäasianmukaisesta käsitelystä.

2. Muissa maissa EU:n ulkopuolella

Jos haluat hävittää tuotteen, ota yhteys paikallisiin viranomaisiin ja pyydä ohjeita tuotteen asianmukaiseen hävittämiseen.

B. Hävitysohjeet yrityskäyttäjille

1. Euroopan unionissa

Jos tuotetta on käytetty yrityskäytössä, ja haluat hävittää sen, ota yhteys SHARP-jälleenmyyjään, joka antaa sinulle lisäohjeita tai ottaa tuotteen vastaan. Sinulta saatetaan veloitaa tuotteen vastaanottamisesta ja kierrätyksestä johtuvat kustannukset. Paikalliset keräyspisteet saattavat ottaa vastaan pienet tuotteet (ja pienet määrät).

2. Muissa maissa EU:n ulkopuolella

Jos haluat hävittää tuotteen, ota yhteys paikallisiin viranomaisiin ja pyydä ohjeita tuotteen asianmukaiseen hävittämiseen.

Informazioni zur Batterieentsorgung

Die für dieses Produkt mitgelieferte Batterie kann Spuren von Blei enthalten.

Für die EU: Die durchgestrichene Abfalltonne bedeutet, dass gebrauchte Batterien nicht mit dem Haushaltsmüll entsorgt werden sollten! Es gibt getrennte Sammelsysteme für gebrauchte Batterien, welche eine ordnungsgemäße Behandlung und Verwertung entsprechend gesetzlicher Vorgaben erlauben. Weitere Einzelheiten erhalten Sie von Ihrer Gemeindeverwaltung.

Für die Schweiz: Die gebrauchte Batterie kann an der Verkaufsstelle zurückgegeben werden.

Für andere Nicht-EU Staaten: Bitte erkundigen Sie sich bei Bedarf bei Ihrer Gemeindeverwaltung nach weiteren Informationen zur Entsorgung von gebrauchten Batterien.



Information sur la mise au rebut de la pile

Les piles/accus fournis avec ce produit peuvent contenir des traces de Plomb.

Au sein de l'Union Européenne : Le symbole de la poubelle sur roues barrée laisse supposer que les piles/accus usagées ne doivent pas être mélangées avec les déchets ménagers! Il existe un mode de collecte séparé pour les piles/accus usagées, ce qui permet d'effectuer un traitement et un recyclage en accord avec la législation. Veuillez contacter une autorité locale pour plus de renseignements sur le système mis en place.

Pour la Suisse : Les piles/accus usagées doivent être retournées chez votre détaillant.

Pour les pays hors Union Européenne : Veuillez contacter une autorité locale afin de connaître la bonne méthode à utiliser pour la collecte de vos piles/accus usagées.



Información sobre la eliminación de la batería

Las baterías suministradas con este producto contienen pequeñas cantidades de Plomo.

Para EU: El contenedor de basura con ruedas tachado indica que las baterías usadas no deberían mezclarse con los residuos domésticos generales. Existe un sistema de recogida independiente de baterías usadas, para permitir un correcto tratamiento y reciclado de acuerdo con la legislación vigente. Por favor póngase en contacto con el sistema de recogida establecido o con las autoridades locales para la recogida selectiva de las baterías usadas.

Para Suiza: Las baterías usadas deben ser retornadas al punto de venta.

Para otros países fuera de la Unión Europea: Por favor póngase en contacto con las autoridades locales para un correcto procedimiento de eliminación de las baterías usadas.



Information om batteriavttring

Batteriet som följer med denna produkt kan innehålla spår av Bly.

För EU: Batteriet är märkt med den överkorsade soptunnan vilket betyder att det inte ska kastas i det vanliga hushållsavfallet. Det finns ett separat insamlingsystem för batterier för att underlätta korrekt behandling och återvinning enligt gällande lagstiftning. Kontakta kommunen för vidare information om insamling och återvinning.

För Schweiz: Använda batterier lämnas till inköpsstället.

För länder utanför EU: Kontakta de lokala myndigheterna för information om gällande sorterings- och återvinningsföreskrifter om du behöver göra dig av med ett använt batteri.



Informazioni sullo smaltimento della batteria

La batteria fornita con questo prodotto contiene tracce di Piombo.

Per EU: Il cassonetto barrato indica che le batterie usate non devono essere gettate assieme ai rifiuti domestici! Vi è un sistema di raccolta differenziata per le batterie usate, che consente il loro corretto trattamento e riciclo secondo quanto previsto dalle leggi vigenti. Vi prego di contattare le locali autorità per i dettagli del sistema di raccolta e riciclaggio.

Per la Svizzera: Le batterie usate devono essere restituite al punto vendita.

Per altri Stati non-EU: Vi prego di contattare le autorità locali per conoscere il metodo corretto di conferimento delle batterie usate.



Informatie over afvalverwerking van batterijen

De batterij die bij dit toestel geleverd wordt bevat sporen van Lood.

Voor EU: De doorgestreepte vuilnisbak op wieltjes duidt aan dat de gebruikte batterijen niet mogen terechtkomen in het gewone huishoudelijke afval. Er bestaat een gescheiden ophaalsysteem voor deze gebruikte batterijen om eigen behandeling en recyclage volgens de wetgeving toe te laten. Gelieve de lokale autoriteiten te contacteren voor de details van ophaling en recyclage.

Voor Zwitserland: De gebruikte batterij moet bij hetverkooppunt teruggebracht worden.

Voor andere niet EU landen: Gelieve contact op te nemen met uw lokale autoriteiten voor de correcte methode van verwerking van de gebruikte batterijen.



Informação sobre Eliminação de Pilhas

A bateria fornecida com este produto contém traços de chumbo.

Para a União Europeia: O contedor de rodas tachado significa que as baterias usadas não deverão ser colocadas junto com o lixo doméstico! Existe um sistema de separação próprio para baterias usadas, para permitir um tratamento e reciclagem própria de acordo com a legislação em vigor. Por favor contacte as autoridades locais para mais detalhes nos esquemas de recolha e reciclagem.

Para a Suíça: As baterias usadas deverão ser devolvidas ao ponto de venda.

Para os outros países fora da União Europeia: Por favor contacte a sua autoridade local para o método correcto de disposição das baterias usadas.



Tietoja paristojen hävittämisestä

Tämän tuotteen mukana oleva paristo/akku saattaa sisältää jäänteitä Lyijyä.

EU-maat: Paristo/akku on merkitty yliviivaatun roskasäiliön symbolilla, mikä tarkoittaa, että sitä ei saa hävittää kotitalouden yleisjätteen kanssa. Paristoille/akuille on olemassa erillinen keräysjärjestelmä, joka helpottaa niiden asiamukaista käsittelyä ja lainnukaista kierräystä. Ota yhteys kuntaviranomaisiin saadaksesi lisätietoa keräyksestä ja kierräyksestä.

Sveitsi: Käytetyt paristot/akut palautetaan ostopaikkaan.

EU:n ulkopuoliset maat: Ota yhteys paikallisiviranomaisiin saadaksesi lisätietoa voimassa olevista lajitelu- ja kierrätysäädöksistä ja ohjeet käytetyn pariston/akun hävittämiseen.



Information on Battery Disposal

The battery supplied with this product contains traces of Lead.

For EU: The crossed-out wheeled bin implies that used batteries should not be put to the general household waste! There is a separate collection system for used batteries, to allow proper treatment and recycling in accordance with legislation. Please contact your local authority for details on the collection and recycling schemes.

For Switzerland: The used battery is to be returned to the selling point.

For other non-EU countries: Please contact your local authority for correct method of disposal of the used battery.



XL-DAB10NH Micro Component System consisting of XL-DAB10NH (main unit) and CP-DAB10NH (speaker system).
 XL-DAB20NH Micro Component System consisting of XL-DAB20NH (main unit) and CP-DAB20NH (speaker system).

Introduction





Thank you for purchasing this SHARP product. To obtain the best performance from this product, please read this manual carefully. It will guide you in operating your SHARP product.

Special Note

Supply of this product does not convey a license nor imply any right to distribute content created with this product in revenue-generating broadcast systems (terrestrial, satellite, cable and/or other distribution channels), revenue-generating streaming applications (via Internet, intranets and/or other networks), other revenue-generating content distribution systems (pay-audio or audio-on-demand applications and the like) or on revenue-generating physical media (compact discs, digital versatile discs, semiconductor chips, hard drives, memory cards and the like). An independent license for such use is required. For details, please visit <http://mp3licensing.com>
 MPEG Layer-3 audio coding technology licensed from Fraunhofer IIS and Thomson.

Accessories

Please confirm that the following accessories are included.

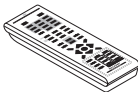
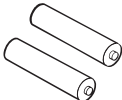
 Adaptor A x 1 (FIXED TO MAIN UNIT)	 Adaptor B x 1	 Adaptor C x 1	 Adaptor D x 1	 Adaptor E x 1
 Remote control x 1		 "AAA" size battery (UM/SUM-4, R3, HP-16 or similar) x 2		

The illustrations printed in this operation manual are for the model XL-DAB10NH.

CONTENTS

	Page		Page
General Information		USB	
Precautions	2	Listening to USB mass storage device/MP3 player	12 - 13
Controls and indicators	2 - 3	Advanced USB playback	13 - 14
Preparation for Use		Radio	
System connections	4	Listening to the radio	14 - 15
Remote control	4 - 5	Advanced Features	
Basic Operation		Using the Radio Data System (RDS)	15 - 17
General control	5 - 6	Listening to the DAB+	18
Setting the clock (Remote control only)	6	Changing the information display	19
iPod		Timer and sleep operation (Remote control only)	19 - 21
Listening to the iPod	7 - 8	Enhancing your system	21
CD or MP3/WMA disc Playback		References	
Listening to a CD or MP3/WMA disc	9	Troubleshooting chart	22 - 23
Advanced CD or MP3/WMA disc playback	10 - 11	Maintenance	23
MP3/WMA folder mode (only for MP3/WMA files)	11 - 12	Specifications	24 - 25

Precautions

General

- Please ensure that the equipment is positioned in a well ventilated area and ensure that there is at least 10 cm (4") of free space along the sides, top and back of the equipment.

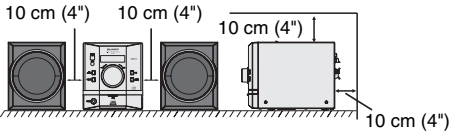

- Use the unit on a firm, level surface free from vibration.
- Keep the unit away from direct sunlight, strong magnetic fields, excessive dust, humidity and electronic/electrical equipment (home computers, facsimiles, etc.) which generate electrical noise.
- Do not place anything on top of the unit.
- Do not expose the unit to moisture, to temperatures higher than 60°C (140°F) or to extremely low temperatures.
- If your system does not work properly, disconnect the AC power lead from the wall socket. Plug the AC power lead back in, and then turn on your system.
- In case of an electrical storm, unplug the unit for safety.
- Hold the AC power plug by the head when removing it from the wall socket, as pulling the lead can damage internal wires.
- The AC power plug is used as a disconnect device and shall always remain readily operable.

- Do not remove the outer cover, as this may result in electric shock. Refer internal service to your local SHARP service facility.

- The ventilation should not be impeded by covering the ventilation openings with items, such as newspapers, tablecloths, curtains, etc.
- No naked flame sources, such as lighted candles, should be placed on the apparatus.
- Attention should be drawn to the environmental aspects of battery disposal.
- This unit should only be used within the range of 5°C - 35°C (41°F - 95°F).
- The apparatus is designed for use in moderate climates.

Warning:

The voltage used must be the same as that specified on this unit. Using this product with a higher voltage other than that which is specified is dangerous and may result in a fire or other type of accident causing damage. SHARP will not be held responsible for any damage resulting from use of this unit with a voltage other than that which is specified.

Volume control

The sound level at a given volume setting depends on speaker efficiency, location and various other factors. It is advisable to avoid exposure to high volume levels, which occurs whilst turning the unit on with the volume control setting up high, or whilst continually listening at high volumes. Excessive sound pressure from earphones and headphones can cause hearing loss.

Controls and indicators

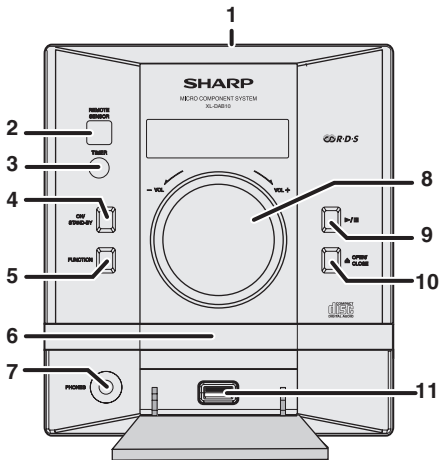

Front panel

	Page
1. iPod Docking Station	.7
2. Remote Sensor	.5
3. Timer Indicator	.20
4. On/Stand-by Button	.5, 7, 9, 19
5. Function Button	.6, 8, 9, 12
6. Disc Tray	.9
7. Headphone Socket	.21
8. Volume Control	.5
9. Disc / USB / iPod Play or Pause or Stop Button	.8, 9, 12
10. Disc Tray Open / Close Button	.9
11. USB Terminal	.12

Speaker system (CP-DAB10NH)

1. Full Range
2. Bass Reflex Duct
3. Speaker Wire

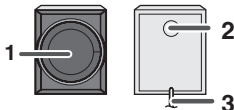

Speaker system (CP-DAB20NH)

1. Tweeter
2. Woofer
3. Bass Reflex Duct
4. Speaker Wire

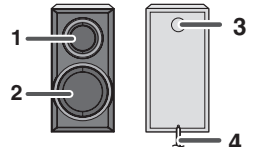

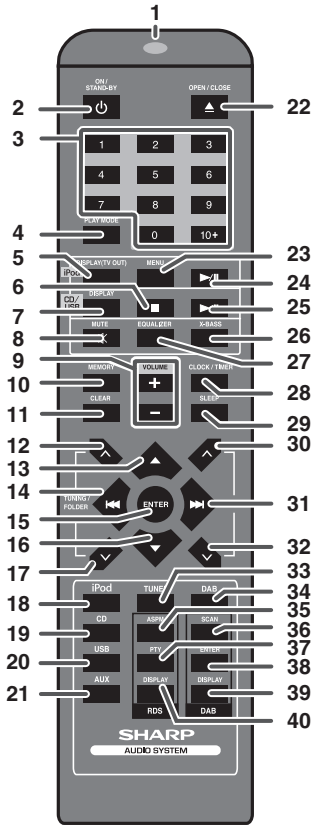

Remote control

	Page
1. Remote Control Transmitter	5
2. On / Stand-by Button	5, 6, 7, 8, 19
3. Direct Search Buttons	10
4. Play Mode Button	9, 10, 13
5. iPod Display (TV OUT) Button	8
6. CD / USB Stop Button	10, 12
7. CD / USB Display Button	11, 12
8. Mute Button	5
9. Volume Up or Down Buttons	5
10. Memory Button	10, 14
11. Clear Button	10
12. Folder Up / Tuning Up Button	12, 13
13. iPod Cursor Up Button	8
14. Fast Reverse or Track Down Button	6, 8, 9, 12, 19
15. Enter Button	8, 12
16. iPod Cursor Down Button	8
17. Folder Down / Tuning Down Button	11, 12
18. iPod Button	8
19. CD Button	9
20. USB Button	12
21. AUX Button	21
22. Open / Close Button	9
23. iPod Menu Button	8
24. iPod Play / Pause Button	8
25. CD / USB Play / Pause Button	8, 9, 12
26. X-Bass Button	5
27. Equaliser Mode Button	6
28. Clock / Timer Button	6, 19
29. Sleep Button	20
30. Preset Up Button	14
31. Fast Forward or Track Up Button	6, 8, 9, 12, 19
32. Preset Down Button	14
33. Tuner Button	14
34. DAB Button	18
35. RDS ASPM Button	15
36. DAB Scan Button	18
37. RDS PTY Button	15
38. DAB Enter Button	18
39. DAB Display Button	18
40. RDS Display Button	15

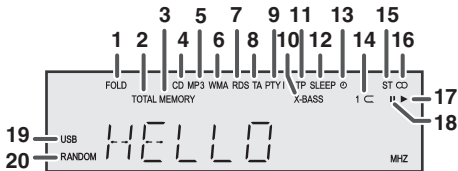

Display

	Page
1. MP3/WMA Folder Indicator	12
2. MP3/WMA Total Indicator	12
3. Memory Indicator	10, 13
4. CD Indicator	10
5. MP3 Indicator	12
6. WMA Indicator	12
7. RDS Indicator	15
8. TA Indicator	15
9. PTY Indicator	15
10. Extra Bass Indicator	5
11. TP Indicator	15
12. Sleep Indicator	20
13. Timer Play Indicator	20
14. Repeat Play Indicator	10
15. FM Stereo Mode Indicator	14
16. FM Stereo Receiving Indicator	14
17. Play Indicator	10
18. Pause Indicator	10
19. USB Indicator	13
20. Random Indicator	10

System connections

Make sure to unplug the AC power lead before making any connections.

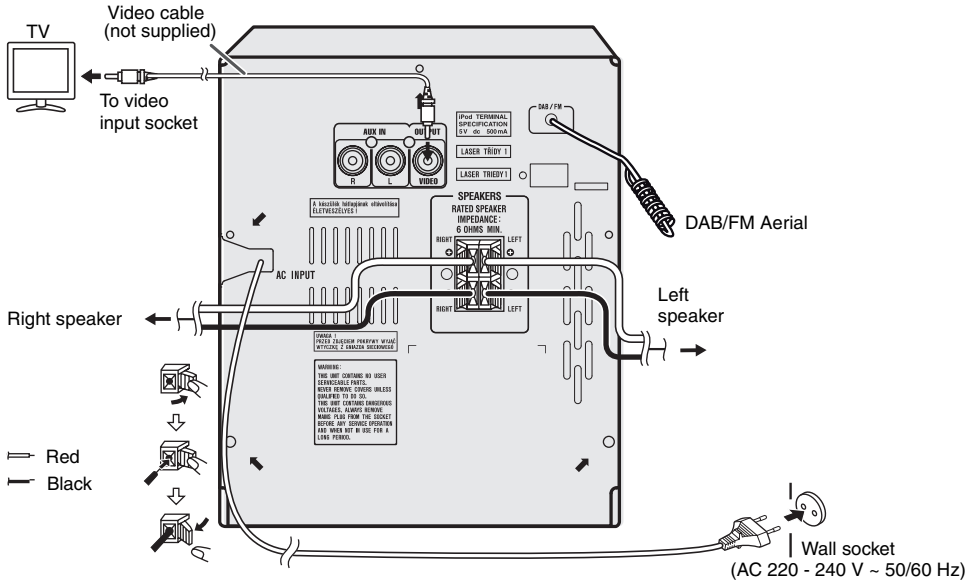

■ Speaker connection

- Connect the black wire to the minus (-) terminal, and the red wire to the plus (+) terminal.
- Use speakers with an impedance of 6 ohms or more, as lower impedance speakers can damage the unit.
- Do not mistake the right and the left channels. The right speaker is the one on the right side when you face the unit.
- **Do not let the bare speaker wires touch each other.**
- Do not allow any objects to fall into or to be placed in the bass reflex ducts.
- Do not stand or sit on the speakers. You may be injured.

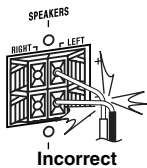

■ Connecting iPod to a TV

The iPod with photo and video can be viewed by connecting to a TV/monitor.

If the TV/monitor has a video input, connect it to the VIDEO OUT socket on the rear of the unit.

Note:

Please make sure to set iPod unit to either NTSC or PAL to match your TV signal. Please visit Apple's home page for further information.

■ AC power connection

After checking all the connections have been made correctly, plug the AC power lead of this unit into the wall socket. If you plug in the unit first, the unit will enter the stand-by mode.

Note:

Unplug the AC power lead from the wall socket if the unit will not be in use for a prolonged period of time.

Remote control

■ Battery installation

- 1 Open the battery cover.
- 2 Insert the batteries according to the direction indicated in the battery compartment. When inserting or removing the batteries, push them towards the (-) battery terminals.
- 3 Close the cover.

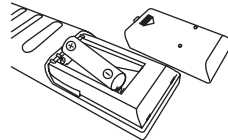

Caution:

- Replace all old batteries with new ones at the same time.
- Do not mix old and new batteries.
- Remove the batteries if the unit will not be used for a long period of time. This will prevent potential damage due to battery leakage.
- Do not use rechargeable batteries (nickel-cadmium battery, etc.).
- Installing the batteries incorrectly may cause the unit to malfunction.
- Batteries (battery pack or batteries installed) shall not be exposed to excessive heat such as sunshine, fire or the like.

Remote control (continued)

Notes concerning use:

- Replace the batteries if the operating distance is reduced or if the operation becomes erratic. Purchase 2 "AAA" size batteries (UM/SUM-3, R6, HP-7 or similar).
- Periodically clean the transmitter on the remote control and the sensor on the unit with a soft cloth.
- Exposing the sensor on the unit to strong light may interfere with operation. Change the lighting or the direction of the unit if this occurs.
- Keep the remote control away from moisture, heat, shock, and vibrations.

■ Test of the remote control

Check the remote control after checking all the connections.

Point the remote control directly at the remote sensor on the unit. The remote control can be used within the range shown below:

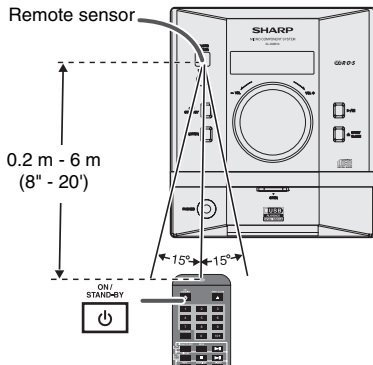

General control

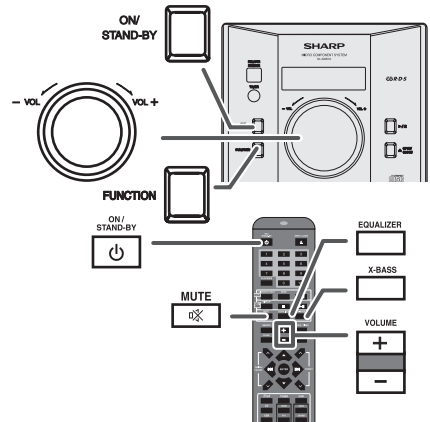

■ To turn the power on

Press the ON/STAND-BY button to turn the power on.

After use:

Press the ON/STAND-BY button to enter the power stand-by mode.

■ Volume auto set-in

- If you turn off and on the main unit with volume set to 16 or higher, the volume will start at 16.
- If you turn the unit off then on again with the volume level set to less than 15, it will turn on again at the level set.

■ Volume control

Turn the volume knob towards VOL +/- (on main unit) or press VOLUME +/- (on remote control) to increase or decrease the volume.

■ Extra bass control (X-BASS)

When the X-BASS button is pressed, the unit will enter the extra bass mode which emphasises the bass frequencies and "X-BASS" indicator will light up.

To cancel the extra bass mode, press the X-BASS button again.

■ Auto power off function

The main unit will enter the stand-by mode after 15 minutes of inactivity during:

iPod : No connection.

CD/USB : In the stop mode.

DAB : No reception of broadcast signal.

AUX IN : No detection of input signal or very low sound audibility.

■ Muting

The volume is muted temporarily when pressing the MUTE button on the remote control. Press again to restore the volume.

General control (continued)

Function (on main unit only)

When the FUNCTION button on main unit is pressed, the current function will change to different mode. Press the FUNCTION button repeatedly to select desired function.

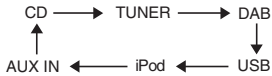

Note:

The backup function will protect the memorised function mode for a few hours should there be a power failure or the AC power lead becomes disconnected.

Equaliser

When the EQUALIZER button is pressed, the current mode setting will be displayed. To change to a different mode, press the EQUALIZER button repeatedly until the desired sound mode appears.

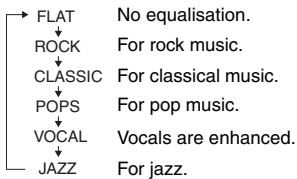

Setting the clock (Remote control only)

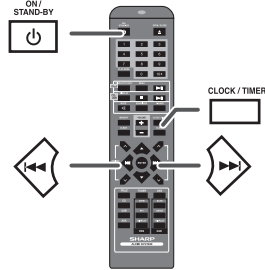

In this example, the clock is set for the 24-hour (00:00) display.

- 1 Press the ON/STAND-BY button to turn to stand-by mode.
- 2 Press and hold the CLOCK/TIMER button until "00:00" appear.



- 3 Within 10 seconds, press the ◀◀ or ▶▶ button to adjust the hour and then press the CLOCK/TIMER button. Press the ◀◀ or ▶▶ button once to advance the time by 1 hour. Hold it down to advance continuously.
- 4 Press the ◀◀ or ▶▶ button to adjust the minutes and then press the CLOCK/TIMER button. Press the ◀◀ or ▶▶ button once to advance the time by 1 minute. Hold it down to advance continuously.

To confirm the time display:

[When the unit is in the stand-by mode]

Press the CLOCK/TIMER button. The time display will appear for about 5 seconds.

[When the power is on]

Press the CLOCK/TIMER button. The time display will appear for about 5 seconds.

Note:

The "00:00" will appear blinking when the AC power supply is restored after a power failure or unplugging the unit. Readjust the clock as follows.

To readjust the clock:

Perform "Setting the clock" from step 1.

Listening to the iPod

Supported iPod models:

- iPod touch (3rd generation)
- iPod touch (2nd generation)
- iPod touch (1st generation)
- iPod classic
- iPod with video
- iPod nano (5th generation)
- iPod nano (4th generation)
- iPod nano (3rd generation)
- iPod nano (2nd generation)
- iPod nano (1st generation)
- iPod with colour display
- iPod mini

Caution:

Please update your iPod unit to the latest software version from Apple's homepage before using it.

Notes:

- Once the iPod is connected to the unit it will begin charging.
- The iPod unit cannot be charged whilst the main unit is in USB mode.

iPod adaptor connection

The marking shows which iPod fits

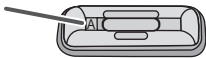

iPod Adaptor No.	iPod Description	Capacity
A	5G iPod (with video)	30GB
A	U2 iPod with video	30GB
A	iPod classic	80GB & 120GB
A	4G iPod & U2 iPod	20GB
A	4G iPod	40GB
A	iPod photo	40GB & 60GB
A	iPod with colour display	60GB
A	iPod Touch	8GB & 16GB
A	iPod Touch (2nd Gen.)	8GB, 16GB & 32GB
A	iPod Touch (3rd Gen.)	32GB, 64GB
B	iPod nano	2GB & 4GB
B	iPod nano (2nd Gen.)	2GB, 4GB & 8GB
B	iPod nano (3rd Gen.)	4GB & 8GB
B	iPod nano (4th Gen.)	8GB & 16GB
B	iPod nano (5th Gen.)	8GB, 16GB
C	iPod mini	4GB & 6GB
D	iPod photo & colour U2 iPod	20GB & 30GB
D	iPod with colour display	20GB, 60GB
E	5G iPod with video	60GB & 80GB
E	iPod classic	160GB

Notes:

- If you have an iPod that does not have an iPod 30 Pin connector, you can use an audio cable to connect it to the AUX IN socket.
- iPhone is not supported by this system.

To insert iPod adaptor

- 1 Press the ON/STAND-BY button to turn the power on.
- 2 Open the iPod cover by pulling up the tip.

pull up

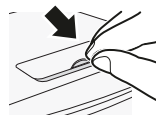

- 3 Insert the iPod adaptor into the iPod dock and connect your iPod.

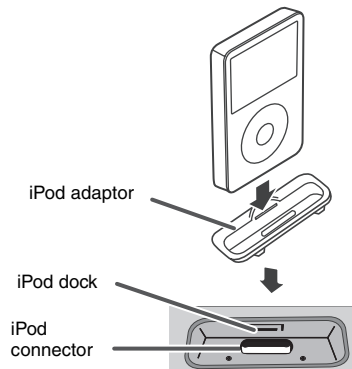
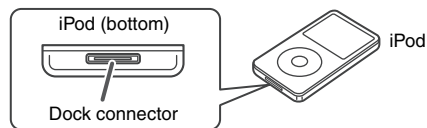

Notes:

- The unit is installed with the iPod adaptor No. A.
- Remove and insert the recommended iPod adaptor if required (refer table on page 7).

To remove iPod adaptor

Insert the tip of a screwdriver ("—" type, small) into the iPod adaptor hole as shown and lift upward to remove.

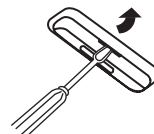

Listening to the iPod (continued)

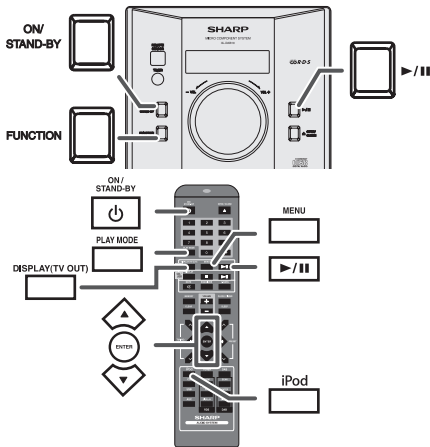

■ iPod playback

- 1 Press the ON/STAND-BY button to turn the power on.
- 2 Press the iPod button on the remote control or FUNCTION button on the main unit repeatedly to select iPod function.
- 3 Insert iPod unit in iPod dock of main unit.
- 4 Press the ►/|| button to start playback.

■ To disconnect iPod

Simply remove the iPod from the iPod dock. It is safe to do so even during playback.

■ Navigating the iPod menus

- 1 Press the MENU button to view the menu on iPod unit. Press it again to go back to previous menu.
- 2 Use the ▼ or ▲ button to select an item on the menu and then press ENTER button.

Note:

When navigating the iPod menus with remote control, do not operate any of the buttons on the iPod unit. The volume level is adjusted by pressing the VOL (+ or -) button on the main unit or the remote control. Adjusting the volume on the iPod unit gives no effect.

iPod operation:

The operations described below depend on the generation iPod you are using.

System on operation:

When the main unit is powered on, the iPod unit will automatically power on when docked in the unit (including TIMER function).

System off (stand-by) operation:

When the main unit is turned to stand-by mode, the docked iPod unit will automatically turn to charging mode.

■ Watching videos on a TV connected to iPod

- 1 Press the DISPLAY (TV OUT) button for more than 2 seconds. "TV DISP" will appear on display.
- 2 Select the desired video from iPod unit to be played.
- 3 Press the ENTER button to start playback.

Notes:

- If the TV Out setting is already turned on at video menu, the video is automatically displayed on the TV screen when ENTER key is pressed.
- To return to watching video on iPod screen, press the MENU button to enter video menu. Then press the DISPLAY (TV OUT) button for more than 2 seconds until "iPodDISP" appears. Repeat steps 2 and 3.
- During iPod video playback, pressing the DISPLAY (TV OUT) button will not toggle video out display between iPod and TV.

iPod playback detection function:

Once the play button on the iPod unit is pressed, the main unit will automatically change to iPod function overriding the previous function selected.

Caution:

Unplug all accessories for the iPod before inserting it into the iPod dock.

■ Various iPod functions

Function	Main unit	Remote control	Operation
Play			Press in the pause mode.
Pause			Press in the playback mode.
Track up/down	—		Press in the playback or pause mode. If you press the button in the pause mode, press the ►/ button to start the desired track.
Fast forward/reverse	—		Press and hold down in the playback mode. Release the button to resume playback.
Display	—		iPod back light ON. Press for more than 2 seconds to toggle the video out display between iPod or TV.
Repeat	—		Press to toggle repeat mode.
Shuffle	—		Press and hold down to toggle shuffle mode.
iPod Menu	—		Press to view the iPod menu during iPod function.
iPod Enter	—		Press to confirm the selection.
iPod Cursor Up/Down	—		Press to select the iPod menu.

Listening to a CD or MP3/WMA disc

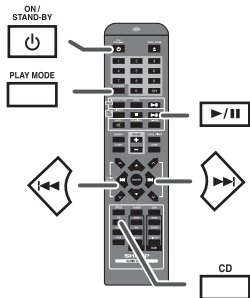
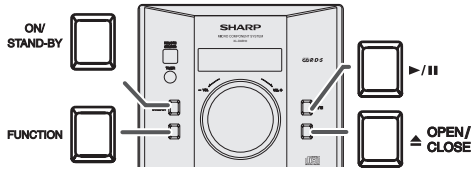

This system can play back a standard CD, CD-R/RW in the CD format and CD-R/RW with MP3 or WMA files, but cannot record on them. Some audio CD-R and CD-RW discs may not be playable due to the state of the disc or the device that was used for recording.

MP3:

MP3 is a form of compression. It is an acronym which stands for MPEG Audio Layer 3. MP3 is a type of audio code which is processed by significant compression from the original audio source with very little loss in sound quality.

- This system supports MPEG 1 Layer 3 and VBR files.
- During VBR file playback, time counter in the display may differ from its actual playback time.
- Bitrate which is supported by MP3 is 32 ~ 320 kbps.

WMA:

WMA files are Advanced System Format files that include audio files which are compressed with Windows Media Audio codec. WMA is developed by Microsoft as an audio format file for Windows Media Player.

- "MP3" and "WMA" indicator will light up after the unit reads information on an MP3 or WMA disc.
- Bitrate which is supported by WMA is 64 ~ 160 kbps.

■ Disc playback

- 1 Press the ON/STAND-BY button to turn the power on.
- 2 Press the CD button on the remote control or FUNCTION button on the main unit repeatedly to select CD function.
- 3 Press the OPEN/CLOSE button to open the disc tray.
- 4 Place the disc on the disc tray, label side up.

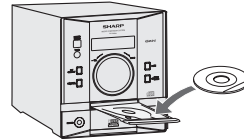

- 5 Press the OPEN/CLOSE button to close the disc tray.
- 6 Press the ►/|| button to start playback. After the last track is played, the unit will stop automatically.





Caution:

- Do not place two discs in one disc tray.
- Do not play discs of special shapes (heart, octagon, etc). It may cause malfunctions.
- Do not push the disc tray whilst it is moving.
- If the power fails whilst the tray is open, wait until the power is restored.
- If TV or radio interference occurs during CD operation, move the unit away from the TV or radio.
- Be sure to place 8 cm (3") disc in the middle of the disc tray.
- Due to the structure of the disc information, it takes longer to read an MP3/WMA disc than a normal CD (approximately 20 to 90 seconds).

Notes for CD or MP3/WMA disc:

- When the end of the last track is reached during fast forward, the CD operation will be stopped. When the beginning of the first track is reached during fast reverse, the unit will enter the playback mode.
- Rewritable multi-session discs with unfinished writing, can still be played.

■ Various disc functions

Function	Main unit	Remote control	Operation
Pause 			Press in the playback mode. Press the ►/ button to resume playback from the paused point.
Track up/down	—		Press in the playback or stop mode. If you press the button in the stop mode, press the ►/ button to start the desired track.
Fast forward/reverse	—		Press and hold down in the playback mode. Release the button to resume playback.

Advanced CD or MP3/WMA disc playback

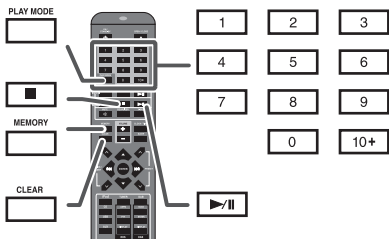

■ Random play

The tracks on the disc can be played in random order automatically.

To random play all tracks:

Press and hold down PLAY MODE button on the remote control until "RANDOM" icon light up. Press the ►/|| button.

To cancel random play:

Press and hold the PLAY MODE button. "RANDOM" icon will disappear.

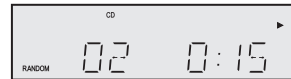

Notes:

- During random playback, repeat function is not possible.
- Playback will stop after all the tracks is played randomly.
- If you press the ►|| button during random play, you can move to the track selected next by the random operation. On the other hand, the ◀◀ button does not allow you to move to the previous track. The beginning of the track being played will be located.
- In random play, the unit will select and play tracks automatically. (You cannot select the order of the tracks.)

■ Direct track search

By using the Direct Search buttons, the desired tracks on the current disc can be played.

Use the Direct Search buttons on the remote control to select the desired track whilst playing the selected disc.

- The Direct Search buttons allow you to select up to number 9.
- When selecting number 10 or higher, use the "10+" button.

A. For example, to choose 13

- 1 Press the "10+" button once.
- 2 Press the "1" button.
- 3 Press the "3" button.

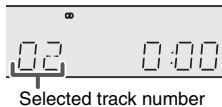

B. For example, to choose 130

- 1 Press the "10+" button twice.
- 2 Press the "1" button.
- 3 Press the "3" button.
- 4 Press the "0" button.

Notes:

- A track number higher than the number of tracks on the disc cannot be selected.
- During random play, direct search is not possible.

To stop playback:

Press and hold ►/|| button on main unit or press CD ■ button.

■ Repeat play

Repeat play can play one track, all tracks or a programmed sequence continuously.

To repeat one track:

Press the PLAY MODE button repeatedly until "RPT ONE" appears. Press the ►/|| button.

To repeat all tracks:

Press the PLAY MODE button repeatedly until "RPT ALL" appears. Press the ►/|| button.

To repeat all desired tracks:

Perform steps 1 - 6 in "Programmed play" section on page 10 and then press the PLAY MODE button until "RPT ALL" appears.

To cancel repeat play:

Press the PLAY MODE button again until "☞" disappears.



■ Programmed play

You can choose up to 32 selections for playback in the order you like.

- 1 Whilst in the stop mode, press the MEMORY button on the remote control to enter the programming save mode.



- 2 Press the ◀◀ or ►► buttons on the remote control to select the desired track.



Selected track number

- 3 Press the MEMORY button to save the track number.



- 4 Repeat steps 2 - 3 for other tracks. Up to 32 tracks can be programmed. If you make a mistake, press the MEMORY button repeatedly to select the wrong track then press the CLEAR button.

- 5 Press the ►/|| button to start playback.

Advanced CD or MP3/WMA disc playback (continued)

- 6 Press the CD  button. The total number in memory will appear.



To cancel the programmed play mode:

Whilst in the stop mode and the "MEMORY" indicator is lit, press the  button on the remote control. The "MEMORY" indicator will disappear and all the programmed contents will be cleared.

Adding tracks to the programme:

If a programme has been previously stored, the "MEMORY" indicator will be displayed. Press the MEMORY button repeatedly until last track appears. Then follow steps 2 - 4 to add tracks. The new tracks will be stored after the last track of the previous programme.

To check which tracks are programmed:

Whilst the unit is stopped in the programmed play mode, press the MEMORY button repeatedly.

To clear the programmed selections:

During stop mode, press the MEMORY button repeatedly to select the unwanted track. Press the CLEAR button to delete it.

Notes:

- When a disc is ejected, the programme is automatically cancelled.
- If you press the ON/STAND-BY button to enter the stand-by mode or change the function from CD to another, the programmed selections will be cleared.
- During the programme operation, random play is not possible.
- Programmed play steps for MP3/WMA disc is same as that of USB on page 13.

MP3/WMA folder mode (only for MP3/WMA files)



To play back MP3/WMA (Windows Media Audio) file

There are many music sites on the internet that you can download MP3/WMA (Windows Media Audio) music files. Follow the instructions from the website on how to download the music files. You can then play back these downloaded music files by burning them to a CD-R/RW disc.

- Your downloaded song/files are for personal use only. Any other usage of the song without owner's permission, is against the law.

About folder playback order

If MP3/WMA files are recorded in several folders, a folder number will be set to each folder automatically.

These folders can be selected by the TUNING/FOLDER ( or ) button on the remote control. If there is no supported file formats inside the selected folder, the folder is skipped and the next folder will be selected.

Example: How to set folder number if MP3/WMA format files are recorded as below figure.

- 1 ROOT folder is set as folder 1.
 - 2 As for folders inside ROOT folder (Folder A and Folder B), the folder which is recorded earlier on the disc will be set as folder 2 and folder 3.
 - 3 As for folder inside Folder A (Folder C and Folder D), the folder which is recorded earlier on the disc will be set as folder 4 and folder 5.
 - 4 Folder E that is inside Folder D will be set as folder 6.
- The folder and file order information which is recorded on the disc depends on the writing software. There maybe possibilities that this unit will playback the files not according to our expected playback order.
 - For CD MP3/WMA, 255 numbers of folders and files inclusive of the folders which have non playable files can be read.

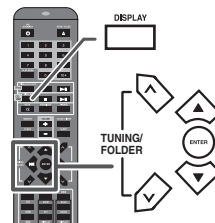
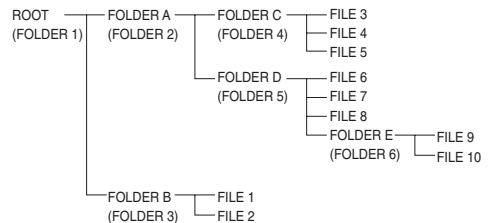

MP3/WMA folder mode (only for MP3/WMA files) (continued)

■ Procedure to playback MP3/WMA disc

To play back CD-R/RW.

- 1 Press the CD button, and load an MP3/WMA disc. After disc is loaded, disc info will be displayed.



Total number of files

- 2 Press the TUNING/FOLDER (▲ or ▼) button, to select desired playback folder. (Folder mode on)

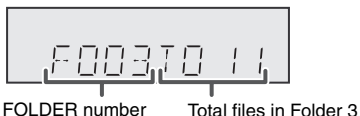

- 3 Select desired file to be played back by pressing the ◀◀ or ▶▶ button.

- 4 Press the ▶/|| (CD ▶/||) button. Playback will start.
 - File name, Title, Artist and Album name are displayed if they are recorded on the disc.
 - Press the TUNING/FOLDER (▼ or ▲) button, and the folder can be selected even though it is in playback mode. It will continue playback mode in the 1st track of the selected folder.
 - Display content can be changed by pressing the CD DISPLAY button.

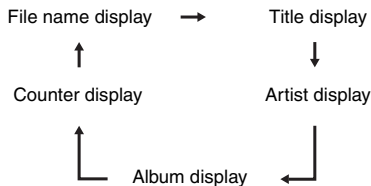

Note:

If the track is skipped during playback, it means "Copyright protected WMA file" or "Not supported playback file" is selected.

Listening to USB mass storage device/MP3 player

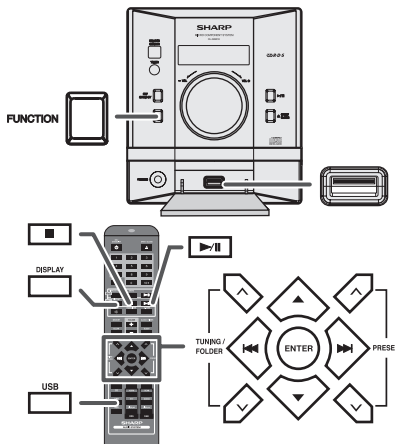

Note:

This USB mass storage device or MP3 player is not compatible with MTP and AAC file systems.

■ To play back USB/MP3 player with folder mode off

- 1 Press the USB button on the remote control or FUNCTION button on main unit repeatedly to select USB function. Connect the USB memory device that has MP3/WMA format files on the unit. When the USB memory is connected to the main unit, the device information will be displayed.

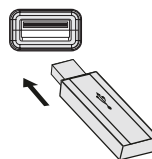

- 2 Select desired file to be played back by pressing the ◀◀ or ▶▶ button.
- 3 Press the ▶/|| (USB ▶/||) button. Playback will start.
 - Title, Artist and Album name are displayed if they are recorded in the USB memory device.
 - Display content can be changed by pressing the DISPLAY button.

Note:

To pause playback:
Press the ▶/|| (USB ▶/||) button.

Listening to USB mass storage device/MP3 player (continued)

■ To play back USB/MP3 player with folder mode on

- 1 Press the USB button on the remote control or FUNCTION button repeatedly on main unit to select USB function. Connect the USB memory device that has MP3/WMA format files on the unit. When the USB memory is connected to the main unit, the track information will be displayed.
- 2 Press the TUNING/FOLDER (∨ or ∧) button to select desired playback folder. To start playback, go to step 4. To change the playback folder, press the TUNING/FOLDER (∨ or ∧) button to select another folder.
- 3 Select desired file to be played back by pressing the ◀◀ or ▶▶ button.
- 4 Press the ▶/|| (USB ▶/||) button. Playback will start.
 - Title, Artist and Album name are displayed if they are recorded in the USB memory device.
 - Display content can be changed by pressing the DISPLAY button.

■ To remove USB memory device

- 1 Press the ■ (USB ■) button to stop playback.
- 2 Disconnect USB memory device from the USB terminal.

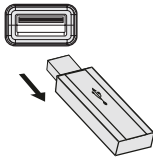

- 3 Close the terminal door.

Notes:

- SHARP will not be held liable for the loss of data whilst the USB memory device is connected to the audio system.
- Files compressed in MP3 and/or WMA format can be played back when connected to the USB terminal.
- This USB memory's format supports FAT 16 or FAT 32.
- SHARP cannot guarantee that all USB memory devices will work on this audio system.
- USB cable is not recommended for use in this audio system to connect to USB memory device. Use of the USB cable will affect the performance of this audio system.
- This USB memory cannot be operated via USB hub.
- The USB terminal in this unit is not intended for a PC connection but is used for music streaming with a USB memory device.
- External HDD-storage cannot be played back via USB terminal.
- If the data inside the USB memory is large, it may take longer time for the data to be read.

Notes:

- This product can play WMA and MP3 files. It will automatically detect the file type being played. If unplayable file is played on this product, the file will be automatically skipped. This will take a few seconds. If abnormal indications appear on the display due to the unspecified file, turn off the unit and then turn it on again.
- This product relates to USB mass storage devices and MP3 players. It may however face some irregularities due to various unforeseen reasons from some devices. Should this happen, turn off the unit and then turn it on again.
- The USB port is only intended for direct connection to a USB memory device without any cable.

Advanced USB playback

■ Repeat play

Repeat play can play all tracks sequence continuously.

To repeat one track:

Press the PLAY MODE button repeatedly until "RPT ONE" appears. Press the ▶/|| (USB ▶/||) button.

To repeat one folder:

Press the PLAY MODE button repeatedly until "RPT FLD" appears. Press the ▶/|| (USB ▶/||) button.

To repeat all tracks:

Press the PLAY MODE button repeatedly until "RPT ALL" appears. Press the ▶/|| (USB ▶/||) button.

To cancel repeat play:

Press the PLAY MODE button repeatedly until "NORMAL" appears and "↵" disappear.

■ Programmed play (Folder mode)

You can choose up to 32 selections for playback in the order you like.

- 1 Whilst in the stop mode, press the MEMORY button on the remote control to enter the programming save mode.



- 2 Press the TUNING/FOLDER (∨ or ∧) to select desired folder then press the ◀◀ or ▶▶ buttons to select the desired track.



Selected track number

- 3 Press the MEMORY button to save the track number.



- 4 Repeat steps 2 - 3 for other tracks. Up to 32 tracks can be programmed.
- 5 Press the ▶/|| (USB ▶/||) button to start playback.
- 6 During programmed playback, press and hold ▶/|| button on main unit or press the CD ■ button to stop programmed playback. The total number in memory will appear.

■ Random play

The tracks can be played in random order automatically.

To random play all tracks:

Press and hold down PLAY MODE button on the remote control. Press the ►/|| (USB ►/||) button.

To cancel random play:

Press and hold the PLAY MODE button. "RANDOM" will disappear.

Notes on random play:

- During random playback, repeat function is not possible.
- Playback will stop after all the tracks is played randomly.
- If you press the ►► button during random play, you can move to the track selected next by the random operation. However, the ◀◀ button does not allow you to move to the previous track. It will go to the beginning of the current track instead.
- In random play, the unit will select and play tracks automatically. (You cannot select the order of the tracks.)

Notes:

- This unit only supports "MPEG-1 Audio Layer-3" format. (Sampling Frequency is 32, 44.1, 48kHz)
- "MPEG-2 Audio Layer-3", "MPEG-2.5 Audio Layer-3" and MP1, MP2 format are not supported.
- Playback order for MP3 files may differ depending on the writing software used during file download.
- Bitrate which is supported by MP3 is 32~320 kbps, WMA is 64~160 kbps.
- For MP3/WMA files, please put ".MP3" ".WMA" extension. Files cannot be played back if there is no MP3/WMA extension.
- Playlists are not supported on this unit.
- This unit can display Folder Name or File Name up to 32 characters.
- Maximum total number of MP3/WMA files is 65280. Maximum total number of folders is 255 inclusive of root directory.
- Folders with non playable files are also counted.
- The display playback time may not be displayed correctly when playing back a variable bitrate file.
- The ID3TAG information supported are TITLE, ARTIST and ALBUM only. Title name, artist name and album name can be displayed by pressing the DISPLAY button during file playback or pause mode.
- WMA meta tag also supports title, artist and album name which are recorded in WMA files. Copyright protected WMA files cannot be played back.

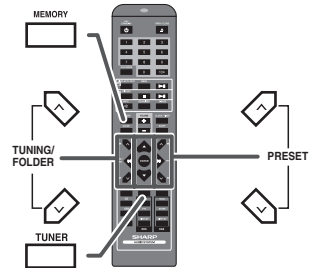
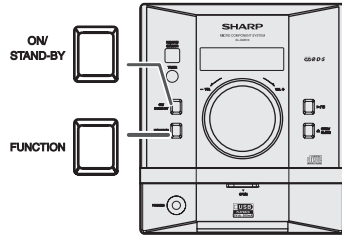

■ Tuning

- 1 Press the ON/STAND-BY button to turn the power on.
- 2 Press the TUNER button to go Tuner function.
- 3 Press the TUNING/FOLDER (∨ or ∧) button on the remote control to tune in to the desired station.

● Manual tuning:

Press the TUNING/FOLDER (∨ or ∧) button repeatedly to tune in to the desired station.

● Auto tuning:

When the TUNING/FOLDER (∨ or ∧) button is pressed for more than 0.5 seconds, scanning will start automatically and the tuner will stop at the first receivable broadcast station.

Notes:

- When radio interference occurs, auto scan tuning may stop automatically at that point.
- Auto scan tuning will skip weak signal stations.

To receive an FM stereo transmission:

- Press the TUNER button to select stereo mode and "ST" indicator will be displayed. "∞" will appear when an FM broadcast is in stereo.
- If the FM reception is weak, press the TUNER button to extinguish the "ST" indicator. The reception changes to monaural, and the sound becomes clearer.

Listening to the radio (continued)

Memorising a station

You can store 40 FM stations in memory and recall them at the push of a button. (Preset tuning)

- 1 Perform steps 1 - 3 in "Tuning".
- 2 Press the MEMORY button.

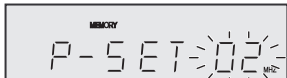

- 3 Within 5 seconds, press the ◀◀ or ▶▶ button to select the preset channel number. Store the stations in memory, in order, starting with preset channel 1.
- 4 Press the MEMORY button to store that station in memory. If the "MEMORY" and preset number indicators disappear before the station is memorised, repeat the operation from step 2.
- 5 Repeat steps 1 - 4 to set other stations, or to change a preset station. When a new station is stored in the memory, the station previously memorised for that preset channel number will be erased.

Note:

The backup function protects the memorised stations for a few hours should there be a power failure or the AC power lead become disconnected.

To recall a memorised station

Press the PRESET (∨ or ∧) button for less than 0.5 seconds to select the desired station.

To scan the preset stations

The stations saved in the memory can be scanned automatically. (Preset memory scan)

- 1 Press the PRESET (∨ or ∧) button for more than 0.5 seconds. The preset number will flash and the programmed stations will be tuned in sequentially, for 5 seconds each.
- 2 Press the PRESET (∨ or ∧) button again when the desired station is located.

To erase entire preset memory

- 1 Press and hold the CLEAR button until "CLR MEM" appears.

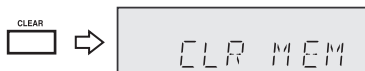

Using the Radio Data System (RDS)

RDS is a broadcasting service which a growing number of FM stations provide. These FM stations send additional signals along with their regular programme signals. They send their station names, and information about the type of programme such as sport, music, etc.

When tuned to an RDS station, "RDS" and the station name will be displayed.

"TP" (Traffic Programme) will appear on the display when the received broadcast carries traffic information, and "TA" (Traffic Announcement) will appear whilst a traffic information is on air.

"PTY" (Dynamic PTY Indicator) will appear whilst the Dynamic PTY station is received.



You can control the RDS by using the buttons on the remote control only.

Information provided by RDS

Each time the RDS DISPLAY button is pressed, the display will switch as follows:

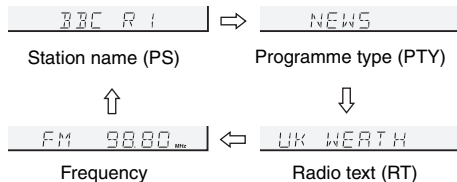
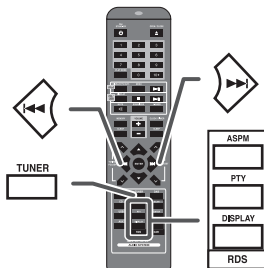

When tuning in to a station other than an RDS station or to an RDS station which sends weak signal, the display will change in the following order:

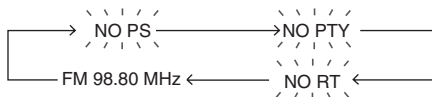

Using the Radio Data System (RDS) (continued)

■ Using the Auto Station Programme Memory (ASPM)

Whilst in the ASPM operation mode, the tuner will automatically search for new RDS stations. Up to 40 stations can be stored.

If you have already stored some stations in memory, the number of new stations you can store will be less.

- 1 Press the TUNER button on the remote control or FUNCTION button repeatedly on the main unit to select TUNER function.
- 2 Press and hold down the RDS ASPM button on the remote control for at least 3 seconds.
 - 1 After "ASPM" has flashed for about 4 seconds, scanning will start (87.50 - 108.00 MHz).



- 2 When an RDS station is found, "RDS" will appear for a short time and the station will be stored in memory.

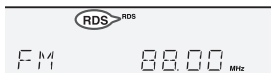

- 3 After scanning, the number of stations stored in memory will be displayed for 4 seconds, and then "END" will appear for 4 seconds.



To stop the ASPM operation before it is complete:

Press the RDS ASPM button whilst it is scanning for stations. The stations which are already stored in memory will be kept there.

Notes:

- If the same station is broadcasting on different frequencies, the strongest frequency will be stored in memory.
- Any station which has the same frequency as the one stored in memory will not be stored.
- If 40 stations have already been stored in memory, the scan will be aborted. If you want to redo the ASPM operation, erase the preset memory.
- If no station have been stored in memory, "00 MEM" and "END" will appear for about 4 seconds.
- If the RDS signals are very weak, station names may not be stored in memory.
- The same station name can be stored in different channels.
- In a certain area or during certain time periods, the station names may temporarily be different.

■ Notes for RDS operation

If any of the following events occur, it does not mean that the unit is faulty:

- "PS", "NO PS" and a station name appear alternately, and the unit does not operate properly.
- If a particular station is not broadcasting properly or a station is conducting tests, the RDS reception function may not work properly.
- When you receive an RDS station whose signal is too weak, information like the station name may not be displayed.
- "NO PS", "NO PTY" or "NO RT" will flash for about 5 seconds, and then the frequency will be displayed.

Notes for radio text:

- The first 8 characters of the radio text will appear for 4 seconds and then they will scroll across the display.
- If you tune in to an RDS station which is not broadcasting any radio text, "NO RT" will be displayed when you switch to the radio text position.
- Whilst radio text data is received or when the text contents change, "RT" will be displayed.

■ To recall stations in memory

To specify programmed types and select stations (PTY search):

You can search a station by specifying the programme type (news, sports, traffic programme, etc. ... see page 17) from the stations in memory.

- 1 Press the TUNER button on the remote control or FUNCTION button on the main unit repeatedly to select TUNER function.
- 2 Press the RDS PTY button on the remote control.



Selected PTY code (blinking) will appear for about 6 seconds.

- 3 Within 6 seconds, press the ◀◀ or ▶▶ button to select the PTY code.



Each time the button is pressed, the PTY code will appear.

- 4 Whilst the selected PTY code is displayed (within 6 seconds), press the RDS PTY button again.

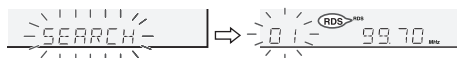

Using the Radio Data System (RDS) (continued)

- The unit searches the all preset stations and stops when it finds a station of the selected category then tunes into the stations. The RDS indicator lights up.
- If no programme is found in the all preset stations, "NO PTY" appear on the display and returns to the previous station.

Notes:

- If the display has stopped flashing, start again from step 2. If the unit finds a desired programme type, the corresponding channel number will lit for about 4 seconds, and then the station name will remain it.
- If you want to listen to the same programme type of another station, press the RDS PTY button and start again from step 2. The unit will look for the next station.

Descriptions of the PTY (Programme Type) codes, TP (Traffic Programme) and TA (Traffic Announcement)

You can search for and receive the following PTY, TP and TA signals.

NEWS	Short accounts of facts, events and publicly expressed views, reportage and actuality.
AFFAIRS	Topical programme expanding or enlarging upon the news, generally in different presentation style or concept, including debate, or analysis.
INFO	Programmes whose purpose is to impart advice in the widest sense.
SPORT	Programme concerned with any aspect of sport.
EDUCATE	Programme intended primarily to educate, of which the formal element is fundamental.
DRAMA	All radio plays and serials.
CULTURE	Programmes concerned with any aspect of national or regional culture, including language, theatre, etc.
SCIENCE	Programmes about the natural sciences and technology.
VARIED	Used for mainly speech-based programmes usually of light-entertainment nature, not covered by other categories. Examples include: quizzes, panel games, personality interviews.
POP M	Commercial music, which would generally be considered to be of current popular appeal, often featuring in current or recent record sales charts.
ROCK M	Contemporary modern music, usually written and performed by young musicians.
EASY M	Current contemporary music considered to be "easy-listening", as opposed to Pop, Rock or Classical, or one of the specialised music styles, Jazz, Folk or Country. Music in this category is often but not always, vocal, and usually of short duration.
LIGHT M	Classical music for general, rather than specialist appreciation. Examples of music in this category are instrumental music, and vocal or choral works.

CLASSICS	Performances of major orchestral works, symphonies, chamber music, etc., and including Grand Opera.
OTHER M	Musical styles not fitting into any of the other categories. Particularly used for specialist music of which Rhythm & Blues and Reggae are examples.
WEATHER	Weather reports and forecasts and meteorological information.
FINANCE	Stock Market reports, commerce, trading, etc.
CHILDREN	For programmes targeted at a young audience, primarily for entertainment and interest, rather than where the objective is to educate.
SOCIAL	Programmes about people and things that influence them individually or in groups. Includes: sociology, history, geography, psychology and society.
RELIGION	Any aspect of beliefs and faiths, involving a God or Gods, the nature of existence and ethics.
PHONE IN	Involving members of the public expressing their views either by phone or at a public forum.
TRAVEL	Features and programmes concerned with travel to near and far destinations, package tours and travel ideas and opportunities. Not for use for announcements about problems, delays, or roadworks affecting immediate travel where TP/TA should be used.
LEISURE	Programmes concerned with recreational activities in which the listener might participate. Examples include, Gardening, Fishing, Antique collecting, Cooking, Food & Wine, etc.
JAZZ	Polyphonic, syncopated music characterised by improvisation.
COUNTRY	Songs which originate from, or continue the musical tradition of the American Southern States. Characterised by a straightforward melody and narrative story line.
NATION M	Current Popular Music of the Nation or Region in that country's language, as opposed to International "Pop" which is usually US or UK inspired and in English.
OLDIES	Music from the so-called "golden age" of popular music.
FOLK M	Music which has its roots in the musical culture of a particular nation, usually played on acoustic instruments. The narrative or story may be based on historical events or people.
DOCUMENT	Programme concerned with factual matters, presented in an investigative style.
TEST	Broadcast when testing emergency broadcast equipment or receivers.
ALARM	Emergency announcement made under exceptional circumstances to give warning of events causing danger of a general nature.

Listening to the DAB+

About DAB+ (Digital Audio Broadcasting)

Digital Audio Broadcasting is a digital transmission system where audio signals are converted to digital signals for broadcasting. DAB+ is broadcast as a group of data called multiplex (ensemble) which may contain one or more stations (services). Each station contains a primary service and there may be one or more secondary services. This allows several programmes or services to be transmitted on a single frequency.

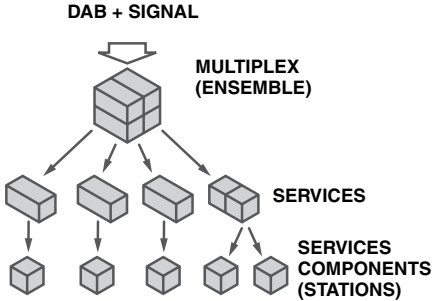

Auto tune

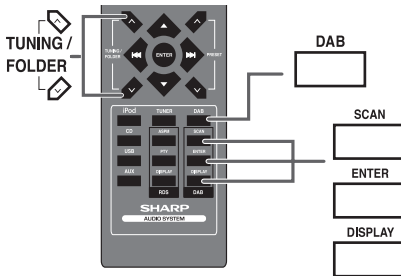

When turned on for the first time, the unit scans radio stations automatically to create a station list. You can make the AUTOTUNE again when you move the unit to other areas or add multiplex channels to the station list.

- 1 Press the DAB button until "DAB" appears on the display.
- 2 Press DAB SCAN button on the remote control for more than 3 seconds. AUTOTUNE scanning begins.

AUTOTUNE

SCANNING

*****10

The scanning progress is indicate by advancing asterisks.
The number of received station

After the scan:

The stations will be stored in alphanumeric order and the first station on the list will be selected and you will hear it through the speakers.

- To listen to other stations, see "Selecting a station in the station list" on page 18.

Notes:

- If no station is found, "NO STN" appears.
- Up to 99 appears for total received stations.

Selecting a station in the station list

Once a DAB+ station is received, you can select stations in the station list.

- 1 Press the DAB button until "DAB" appears on the display.
- 2 Whilst receiving a DAB+ station, press the TUNING/ FOLDER (∧ or ∨) to select the desired station.

STATION1 Display current station

↓
STATION2 The name of the station being selected

- 3 Within 10 seconds, press the DAB ENTER button on the remote control to tune into the desired station.

STATION2

Manual tune

You can manually store stations which AUTOTUNE cannot find. If reception is poor, you can adjust the sensitivity. Manual tune is only available after Auto tune. Perform AUTOTUNE first.

- 1 Press the DAB button until "DAB" appears on the display.
- 2 Press the DAB SCAN button once. SR 17492
- 3 Within 10 seconds, press the TUNING/ FOLDER (∧ or ∨) to select the DAB+ frequency. 93 20464
- 4 Within 10 seconds, press the DAB ENTER button. SIG--100
 - Reception sensitivity appears. The percentage number indicate the current level.
 - If the level is too low, move the aerial or unit to improve reception.
- 5 Press the DAB ENTER button again to store the station and exit manual tune.

Changing the information display

You can switch DAB+ display information.

Press the DAB DISPLAY button.

Each time the button is pressed, the information display changes in the following order.

When "NO SERV" appears, the DAB DISPLAY button does not allow you to change the display.

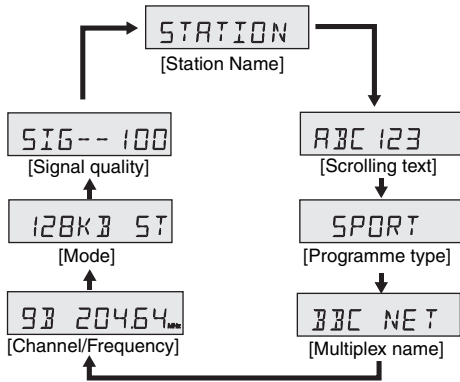

[Station Name]

Station name is displayed. (set by default)

[Scrolling text]

Information scrolls across the display when sent from the station.

[Programme type]

A description of the type of content being broadcast by the station.

[Multiplex name]

The name of the multiplex (ensemble) which provides the current service.

[Channel/Frequency]

The DAB+ channel and frequency for the station. (Frequency is displayed to two decimal places)

[Mode]

The data transfer speed and channel type (stereo or mono) appear.

[Signal quality]

The signal quality is displayed as a number (0 - 100). [85-100: Good, 70-84: Fair, 0-69: Poor]

Timer and sleep operation (Remote control only)

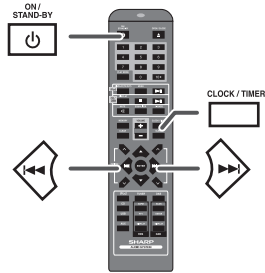

Timer playback:

The unit turns on and plays the desired source (CD, TUNER, USB, iPod) at a preset time.

■ Timer playback

Before setting timer:

- 1 Check that the clock is set to the correct time (refer to page 6). If it is not set, you cannot use the timer function.
- 2 For timer playback, load the disc to be played back.



- 1 Press the ON/STAND-BY button to turn the power on.
- 2 Press the CLOCK/TIMER button for about 2 seconds.



- 3 Within 10 seconds, press the CLOCK/TIMER button.
- 4 Press the ◀ or ▶ button to set hour then press the CLOCK/TIMER button.



- 5 Press the ◀ or ▶ button to set minute and then press the CLOCK/TIMER button.

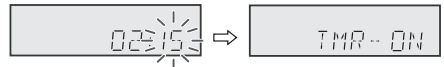

- 6 Switch input with the ◀ or ▶ button to select "TMR-OFF" and then press the CLOCK/TIMER button.

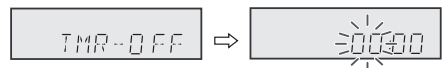

Timer and sleep operation (Remote control only) (continued)

- 7 Press the ◀◀ or ▶▶ button to set hour and then press the CLOCK/TIMER button.



- 8 Press the ◀◀ or ▶▶ button to set minute and then press the CLOCK/TIMER button.



- 9 To select the timer playback source, switch input with ◀◀ or ▶▶ button to select "SOURCE", then press the CLOCK/TIMER button.



- 10 Press the ◀◀ or ▶▶ button to select wake up source (CD, USB, Tuner, iPod) then press the CLOCK/TIMER button to confirm.

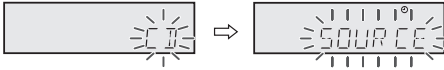

- 11 If "TUNER" is selected, press the CLOCK/TIMER button to enter the preset selection mode.

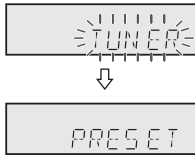

- 12 To select a preset channel number, press the ◀◀ or ▶▶ button and then press the CLOCK/TIMER button.

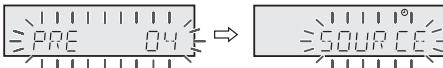

- 13 The "☉" indicator lights up and the unit is ready for timer playback.

- 14 Press the ON/STAND-BY button to enter the power stand-by mode. Press the CLOCK/TIMER button to confirm the timer setting.

- 15 When the preset time is reached, playback will start. "☉" indicator will blink to show timer playback. The volume will increase gradually until it reaches the last volume level.

- 16 When the timer end time is reached, the system will enter the power stand-by mode automatically.

Checking the timer setting:

- 1 Press the CLOCK/TIMER button repeatedly to view as follow:



Canceling the timer setting:

Press the SLEEP button for 2 seconds. The "☉" indicator disappears and the display show "TMR-OFF".

Reusing the memorised timer setting:

The timer setting will be memorised once it is entered. To reuse the same setting, press the SLEEP button for 2 seconds.

The "☉" indicator light up and the display show "TMR-ON".

Notes:

- After selecting the playback source, when press the CLOCK/TIMER button to confirm, "SOURCE" will appear and blink for 2 seconds, then change to last function.
- When the preset time is reached, playback will start at current setting if no selected playback source is made.
- The volume cannot be preset during timer setting.

■ Sleep operation

The radio, compact disc and USB can all be turned off automatically.

- 1 Play back the desired sound source.
- 2 Press the SLEEP button.
- 3 Within 10 seconds, press the SLEEP button repeatedly to select the time.
10 → 20 → 30 → ... → 80 → 90
- 4 "SLEEP" will appear.
- 5 The unit will enter the power stand-by mode automatically after the preset time has elapsed.

To confirm the remaining sleep time:

- 1 Whilst "SLEEP" is indicated, press the SLEEP button. The remaining time is displayed for about 10 seconds.

To cancel the sleep operation:

Press the ON/STAND-BY button whilst "SLEEP" is indicated. To cancel the sleep operation without setting the unit to the stand-by mode, proceed as follows.

- 1 Whilst "SLEEP" is indicated, press the SLEEP button.
- 2 Within 10 seconds, press the SLEEP button repeatedly to select "SLEEP 00".

Timer and sleep operation (Remote control only) (continued)

■ To use timer and sleep operation together

Sleep and timer playback:

For example, you can fall asleep listening to the radio and wake up to CD in the next morning.

- 1 Set the sleep time (see above, steps 1 - 5).
- 2 Whilst the sleep timer is set, set the timer playback (steps 2 - 10, pages 19 - 20).

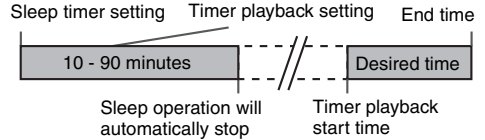

Enhancing your system

The connection lead is not included. Purchase a commercially available lead as shown below.

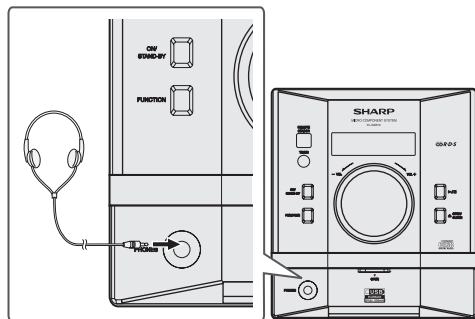
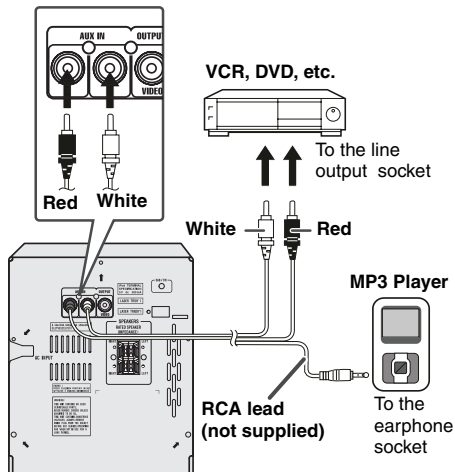

■ Listening to the playback sounds of portable audio player, etc.

- 1 Use a connection lead to connect the portable audio player etc. to the AUX IN socket. When using video equipment, connect the audio output to this unit and the video output to a television.
- 2 Press the ON/STAND-BY button to turn the power on.
- 3 Press the AUX IN button on the remote control or FUNCTION button repeatedly on main unit to select AUX IN function.
- 4 Play the connected equipment. If volume level of the connected device is too high, sound distortion may occur. Should this happen, lower the volume of the connected device. If volume level is too low, increase the volume of the connected device.

Note:

To prevent noise interference, place the unit away from the television.

■ Headphones

- Do not turn the volume on to full at switch on and listen to music at moderate levels. Excessive sound pressure from earphones and headphones can cause hearing loss.
- Before plugging in or unplugging the headphones, reduce the volume.
- Be sure your headphones have a 3.5 mm (1/8") diameter plug and impedance between 16 and 50 ohms. The recommended impedance is 32 ohms.
- Plugging in the headphones disconnects the speakers automatically. Adjust the volume using the VOLUME control.

Troubleshooting chart

Many potential problems can be resolved by the owner without calling a service technician. If something is wrong with this product, check the following before calling your authorised SHARP dealer or service centre.

■ General

Symptom	Possible cause
● The clock is not set to the correct time.	● Did a power failure occur? Reset the clock. (Refer page 6)
● When a button is pressed, the unit does not respond.	● Set the unit to the power stand-by mode and then turn it back on. ● If the unit still malfunctions, reset it. (Refer page 23)
● No sound is heard.	● Is the volume level set to "0"? ● Are the headphones connected? ● Are the speaker wires disconnected?

■ CD player

Symptom	Possible cause
● Playback does not start. ● Playback stops in the middle or is not performed properly.	● Is the disc loaded upside down? ● Does the disc satisfy the standards? ● Is the disc distorted or scratched?
● Playback sounds are skipped, or stopped in the middle of a track.	● Is the unit located near excessive vibrations? ● Is the disc very dirty? ● Has condensation formed inside the unit?

■ Remote control

Symptom	Possible cause
● The remote control does not operate.	● Is the AC power lead of the unit plugged in? ● Is the battery polarity correct? ● Are the batteries dead? ● Is the distance or angle incorrect? ● Does the remote control sensor receive strong light?

■ Tuner

Symptom	Possible cause
● The radio makes unusual noises continuously.	● Is the unit placed near the TV or computer? ● Is the FM aerial placed properly? Move the aerial away from the AC power lead if it is located nearby.

■ USB

Symptom	Possible cause
● Device cannot be detected.	● Is there any MP3/WMA file available? ● Is the device properly connected? ● Is it an MTP device? ● Does the device contain AAC file only?
● Playback does not start.	● Is it a copyright protected WMA file? ● Is it a false MP3 file?
● Wrong time display. ● Wrong file name display.	● Is Variable Bitrate file being played back? ● Is the File Name written in Chinese or Japanese characters?

■ iPod

Symptom	Possible cause
● No sound is produced. No image appears on the TV/monitor.	● The iPod is not playing. ● The iPod is not properly connected to the unit. ● Is the AC power lead of the unit plugged in? ● The video cable is not properly connected. ● The TV/monitor's input selection is not properly set.
● iPod will not charge.	● Wrong iPod adaptor is used. ● The iPod is not making full contact with the iPod connector. ● The main unit is in stand-by mode. ● Using 3 rd generation iPod.

■ Condensation

Sudden temperature changes, storage or operation in an extremely humid environment may cause condensation inside the cabinet (CD pickup, etc.) or on the transmitter on the remote control. Condensation can cause the unit to malfunction. If this happens, leave the power on with no disc in the unit until normal playback is possible (about 1 hour). Wipe off any condensation on the transmitter with a soft cloth before operating the unit.

■ If problem occurs

When this product is subjected to strong external interference (mechanical shock, excessive static electricity, abnormal supply voltage due to lightning, etc.) or if it is operated incorrectly, it may malfunction.

If such a problem occurs, do the following:

- 1 Set the unit to the stand-by mode and turn the power on again.
- 2 If the unit is not restored in the previous operation, unplug and plug in the unit again, and then turn the power on.

Note:

If neither operation above restores the unit, clear all the memory by resetting it.

Troubleshooting chart (continue)

■ Factory reset, clearing all memory

- 1 Press the ON/STAND-BY button to enter the power stand-by mode.
- 2 Whilst pressing down the OPEN/CLOSE button, press the ON/STAND-BY button until "RESET" appears.

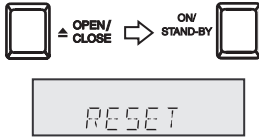

Caution:

This operation will erase all data stored in memory including clock, timer settings, tuner preset, and CD programme.

■ Before transporting the unit

Remove the iPod, USB memory device and disc from the unit. Then, set the unit to the power stand-by mode. Carrying the unit with iPod or USB memory device left docked or discs left inside might damage the unit.

■ Care of compact discs

Compact discs are fairly resistant to damage, however mistracking can occur due to an accumulation of dirt on the disc surface. Follow the guidelines below for maximum enjoyment from your CD collection and player.

- Do not write on either side of the disc, particularly the non-label side from which signals are read. Do not mark this surface.
- Keep your discs away from direct sunlight, heat, and excessive moisture.
- Always hold the CDs by the edges. Fingerprints, dirt, or water on the CDs can cause noise or mistracking. If a CD is dirty or does not play properly, clean it with a soft, dry cloth, wiping straight out from the centre, along the radius.

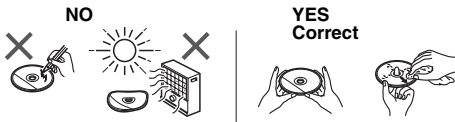

Maintenance

■ Cleaning the cabinet

Periodically wipe the cabinet with a soft cloth and a diluted soap solution, then with a dry cloth.

Caution:

- Do not use chemicals for cleaning (petrol, paint thinner, etc.). It may damage the cabinet.
- Do not apply oil to the inside of the unit. It may cause malfunctions.

Specifications

As part of our policy of continuous improvement, SHARP reserves the right to make design and specification changes for product improvement without prior notice. The performance specification figures indicated are nominal values of production units. There may be some deviations from these values in individual units.

General

Power source	AC 220 - 240 V ~ 50/60 Hz
Power consumption XL-DAB10NH	Power on: 25 W Power stand-by: 0.6 W (*)
Power consumption XL-DAB20NH	Power on: 45 W Power stand-by: 0.6 W (*)
Dimensions	Width: 155 mm (6-3/32") Height: 178 mm (7-1/64") Depth: 243 mm (9-9/16")
Weight XL-DAB10NH	2.12 kg (4.67 lbs.)
Weight XL-DAB20NH	2.12 kg (4.67 lbs.)

(*) This power consumption value is obtained when the main unit is in stand-by mode without iPod charging.

Amplifier

Output power XL-DAB10NH	MPO: 24 W (12 W + 12 W) (10% T.H.D.) RMS: 24 W (12 W + 12 W) (10% T.H.D.)
Output power XL-DAB20NH	MPO: 50 W (25 W + 25 W) (10% T.H.D.) RMS: 50 W (25 W + 25 W) (10% T.H.D.)
Output terminals	Speakers: 6 ohms Headphones: 16 - 50 ohms (recommended: 32 ohms)
Input terminals	AUX IN (Analogue input): 500 mV/47 k ohms

CD player

Type	Single disc multi-play compact disc player
Signal readout	Non-contact, 3-beam semiconductor laser pickup
D/A converter	Multi bit D/A converter
Frequency response	20 - 20,000 Hz
Dynamic range	90 dB (1 kHz)

USB

USB host interface	<ul style="list-style-type: none"> Complies with USB 1.1 (Full Speed)/ 2.0 Mass Storage Class. Support Bulk only and CBI protocol.
Support file	<ul style="list-style-type: none"> MPEG 1 Layer 3 WMA (Non DRM)
Bitrate support	<ul style="list-style-type: none"> MP3 (32 ~ 320 kbps) WMA (64 ~ 160 kbps)
Other	<ul style="list-style-type: none"> Maximum total number of MP3/WMA files is 65280. Maximum total number of folders is 255 INCLUSIVE of root directory. The ID3TAG information supported are TITLE, ARTIST and ALBUM only. Supports ID3TAG version 1 and version 2.
File system support	<ul style="list-style-type: none"> Support USB devices with Microsoft Windows/DOS/FAT 12/ FAT 16/ FAT 32. 2 kbyte block length for sector.

Tuner

Frequency range	FM: 87.5 - 108 MHz DAB: 174.928 - 239.200 MHz
------------------------	--

Speaker (CP-DAB10NH)

Type	1-way type speaker system 10 cm (4") Full range
Maximum input power	24 W
Rated input power	12 W
Impedance	6 ohms
Dimensions	Width: 147 mm (5-51/64") Height: 174 mm (6-13/16") Depth: 171.5 mm (6-49/64")
Weight	1.53 kg (3.37 lbs.)/each

Speaker (CP-DAB20NH)

Type	2-way 2-speaker system 5 cm (2") tweeter 10 cm (4") woofer
Maximum input power	50 W
Rated input power	25 W
Impedance	6 ohms
Dimensions	Width: 132 mm (5-13/64") Height: 260 mm (10-15/64") Depth: 171.5 mm (6-49/64")
Weight	1.98 kg (4.36 lbs.)/each

Specifications (continued)

DAB Frequency table (BAND III)







































Frequency	Label	Frequency	Label
174.928 MHz	5A	208.064 MHz	9D
176.640 MHz	5B	209.936 MHz	10A
178.352 MHz	5C	211.648 MHz	10B
180.064 MHz	5D	213.360 MHz	10C
181.936 MHz	6A	215.072 MHz	10D
183.648 MHz	6B	216.928 MHz	11A
185.360 MHz	6C	218.640 MHz	11B
187.072 MHz	6D	220.352 MHz	11C
188.928 MHz	7A	222.064 MHz	11D
190.640 MHz	7B	223.936 MHz	12A
192.352 MHz	7C	225.648 MHz	12B
194.064 MHz	7D	227.360 MHz	12C
195.936 MHz	8A	229.072 MHz	12D
197.648 MHz	8B	230.784 MHz	13A
199.360 MHz	8C	232.496 MHz	13B
201.072 MHz	8D	234.208 MHz	13C
202.928 MHz	9A	235.776 MHz	13D
204.640 MHz	9B	237.488 MHz	13E
206.352 MHz	9C	239.200 MHz	13F

* Frequencies are displayed to two decimal places on this unit.

Display information table

Notes on the display information:

- Characters are displayed in Uppercase letters (A to Z), numbers and symbols.
- Display examples are as in table shown below.

DISPLAY	INDICATES	DISPLAY	INDICATES
	A		}
	B		,
	D		.
	G		/
	O, 0 _(zero)		\
	Q		?
	R		[
	1	]
	2		!,,:;
	5		+
	6		=
	8		-
	'		*
	"		&
	:		%
	;		^,~
	<,(	\$
	>,)		@
	{		#

SHARP®

SHARP ELECTRONICS (Europe) GmbH
Sonninstraße 3, D-20097 Hamburg

SHARP CORPORATION



92L4MDAB1003SR

10K R MW ①

Free Manuals Download Website

<http://myh66.com>

<http://usermanuals.us>

<http://www.somanuals.com>

<http://www.4manuals.cc>

<http://www.manual-lib.com>

<http://www.404manual.com>

<http://www.luxmanual.com>

<http://aubethermostatmanual.com>

Golf course search by state

<http://golfingnear.com>

Email search by domain

<http://emailbydomain.com>

Auto manuals search

<http://auto.somanuals.com>

TV manuals search

<http://tv.somanuals.com>