

SONY®

3-288-519-13(1)

Digital HD Video Camera Recorder

HANDYCAM®

Handycam Handbook

HDR-TG1E/TG3E

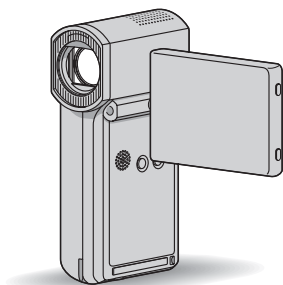

Enjoying Your
Camcorder 8

Getting Started 14

Recording/Playback 22

Editing 45

Utilizing Media 57

Customizing Your
Camcorder 60

Troubleshooting 79

Additional
Information 89

Quick
Reference 99

AVCHD

 MEMORY STICK™

 InfoLITHIUM™ SERIES

HDMI

Read this before operating your camcorder

Before operating the unit, please read this Handbook thoroughly, and retain it for future reference.

Notes on use

On “Handycam Handbook” (this book)

The operations and handling of your camcorder are explained. Refer also to “Operating Guide” (the separate volume).

Handling the images recorded on your camcorder on a computer

Refer to “PMB Guide” stored on the supplied CD-ROM.

Types of “Memory Stick” you can use with your camcorder

• For recording movies, it is recommended that you use a “Memory Stick PRO Duo” of 1 GB or larger marked with:

- MEMORY STICK PRO DUO (“Memory Stick PRO Duo”)*
- MEMORY STICK PRO-HG DUO (“Memory Stick PRO-HG Duo”)

* You can use “Memory Stick PRO Duo” whether Mark2 is indicated or not.

• See page 10 for the recordable time of a “Memory Stick PRO Duo.”

“Memory Stick PRO Duo”/“Memory Stick PRO-HG Duo”

(This size can be used with your camcorder.)



“Memory Stick”
(You cannot use it in your camcorder.)



• “Memory Stick PRO Duo” and “Memory Stick PRO-HG Duo” are both referred to

as “Memory Stick PRO Duo” in this manual.

- You cannot use any type of memory card other than those mentioned above.
- “Memory Stick PRO Duo” can be used only with “Memory Stick PRO” compatible equipment.
- Do not attach a label or the like on a “Memory Stick PRO Duo” or a Memory Stick Duo adaptor.
- Insert the “Memory Stick PRO Duo” into the Memory Stick Duo adaptor when using a “Memory Stick PRO Duo” with “Memory Stick PRO” compatible equipment.

Using the camcorder



- Do not hold the camcorder by the following parts.

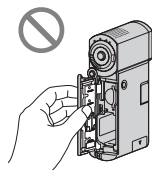

LCD screen



Battery/Memory Stick Duo cover

- The camcorder is not dustproofed, dripproofed or waterproofed. See “About handling of your camcorder” (p. 95).
- Do not do any of the following when the  (Movie)/ (Still) mode lamps (p. 19), the access lamp (p. 21) or the QUICK ON lamp (p. 15) is lit or flashing. Otherwise, the media may be damaged, recorded images may be lost or other malfunctions could occur.
 - Eject the “Memory Stick PRO Duo” from the camcorder
 - Remove the battery pack or AC Adaptor from the camcorder.
 - Apply mechanical shock or vibration to the camcorder.

- If you close the LCD panel when your camcorder is connected to other devices with the USB cable, the recorded images may be lost.
- When connecting your camcorder to another device with a cable, be sure to insert the connector plug in the correct way. Pushing the plug forcibly into the terminal will damage the terminal and may result in a malfunction of your camcorder.
- Disconnect the AC Adaptor from the Handycam Station holding both the Handycam Station and the DC plug.
- Be sure to turn off your camcorder when you insert the camcorder into the Handycam Station or remove the camcorder from it.

About menu items, LCD panel and lens

- A menu item that is grayed out is not available under the current recording or playback conditions.
- The LCD screen is manufactured using extremely high-precision technology, so over 99.99% of the pixels are operational for effective use. However, there may be some tiny black points and/or bright points (white, red, blue, or green in color) that appear constantly on the LCD screen. These points are normal results of the manufacturing process and do not affect the recording in any way.

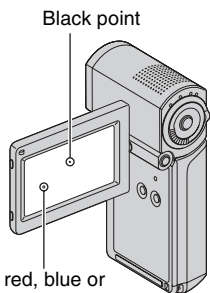

- Exposing the LCD screen or the lens to direct sunlight for long periods of time may cause malfunctions.
- Do not aim at the sun. Doing so might cause your camcorder to malfunction. Take images of the sun only in low light conditions, such as at dusk.

About changing the language setting

- The on-screen displays in each local language are used for illustrating the operating procedures. Change the screen language before using your camcorder if necessary (p. 20).

On recording

- Before starting to record, test the recording function to make sure the image and sound are recorded without any problems.
- Compensation for the contents of recordings cannot be provided, even if recording or playback is not possible due to a malfunction of the camcorder, storage media, etc.
- TV color systems differ depending on the country/region. To view your recordings on a TV, you need a PAL system-based TV.
- Television programs, films, video tapes, and other materials may be copyrighted. Unauthorized recording of such materials may be contrary to the copyright laws.

If you cannot record/play back images, perform [MEDIA FORMAT]

- If you repeat recording/deleting images for a long time, fragmentation of data occurs on the media. Images cannot be saved or recorded. In such a case, save your images on some type of external media first, and then perform [MEDIA FORMAT] (p. 58).

Fragmentation  Glossary (p. 105)

On playing back recorded images on other devices

- Your camcorder is compatible with MPEG-4 AVC/H.264 High Profile for HD (high definition) image quality recording. Therefore, you cannot play back images recorded with HD (high definition) image quality on your camcorder with the following devices;
 - Other AVCHD format compatible devices which are not compatible with High Profile
 - Devices which are not compatible with the AVCHD format

Save all your recorded image data

- To prevent your image data from being lost, save all your recorded images on external media. It is recommended that you save the image data on a disc such as DVD-R using your computer, etc. (p. 44). Also, you can save your image data using a VCR, or a DVD/HDD recorder (p. 52).
- It is recommended that you save your image data periodically, after recording.

About this Handbook

- The images of the LCD screen used in this Handbook for illustration purposes are captured using a digital still camera, and therefore may appear different.
- Design and specifications of your camcorder and accessories are subject to change without notice.

About the Carl Zeiss lens



Your camcorder is equipped with a Carl Zeiss lens, which was developed jointly by Carl Zeiss, in Germany, and Sony Corporation, and produces superior images. It adopts the MTF measurement system for video cameras and offers a quality typical of a Carl Zeiss lens.

MTF= Modulation Transfer Function. The number value indicates the amount of light from a subject coming into the lens.

Table of Contents

| | |
|---|---|
| Read this before operating your camcorder | 2 |
| Subject examples and solutions | 7 |

Enjoying Your Camcorder

| | |
|--|----|
| Operation flow | 8 |
| “  HOME” and “  OPTION” - Taking advantage of two types of menus | 11 |

Getting Started

| | |
|--|----|
| Step 1: Checking supplied items .. | 14 |
| Step 2: Charging the battery pack | 15 |
| Step 3: Turning the power on and adjusting the LCD panel | 18 |
| Step 4: Setting the date and time | 19 |
| Changing the language setting | 20 |
| Step 5: Inserting a “Memory Stick PRO Duo” | 21 |

Recording/Playback

| | |
|---|----|
| Recording and playback with ease (Easy Handycam operation) | 22 |
| Recording | 26 |
| Zooming | 28 |
| Recording sound with more presence (5.1ch surround recording) | 28 |
| Starting shooting quickly (QUICK ON) | 29 |
| Recording high quality still images during movie recording (Dual Rec) | 29 |
| Recording in mirror mode | 29 |
| Recording the fast action in slow-motion (SMTH SLW REC) | 30 |
| Playback | 31 |
| Searching for desired scene by pinpoint (Film Roll Index) | 34 |

| | |
|--|----|
| Searching for desired scene by face (Face Index) | 34 |
| Searching for desired images by date (Date Index) | 35 |
| Using PB zoom | 35 |
| Playing back a series of still images (Slide show) | 36 |
| Playing the image on a TV | 37 |
| Saving images | 44 |



Editing

| | |
|---|----|
|  (OTHERS) category | 45 |
| Deleting images | 46 |
| Capturing a still image from a movie (HDR-TG1E) | 47 |
| Dividing a movie | 48 |
| Creating the Playlist | 49 |
| Dubbing to other devices | 52 |
| Printing recorded images (PictBridge compliant printer) | 55 |

Utilizing Media

| | |
|---|----|
|  (MANAGE MEDIA) category | 57 |
| Setting the image quality | 57 |
| Checking the “Memory Stick PRO Duo” information | 58 |
| Deleting all images (Formatting) | 58 |
| Repairing the image database file | 59 |

Customizing Your Camcorder

| | |
|---|----|
| What you can do with the  (SETTINGS) category of the  HOME MENU | 60 |
| Using the HOME MENU | 60 |
| List of the  (SETTINGS) category items | 61 |

Subject examples and solutions

Checking your golf swing



▶ SMTH SLW REC30

Getting a good shot of a ski slope or beach



▶ BEACH.....76

▶ SNOW76

Capturing still images during movie recording

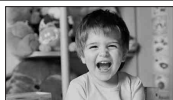

▶ Dual Rec29

A child on the stage under a spot light



▶ SPOTLIGHT76

Flowers in close-up



▶ PORTRAIT76

▶ FOCUS74

▶ TELE MACRO.....74

Fireworks with all its splendor



▶ FIREWORKS.....75

▶ FOCUS.....74

Focusing on the dog on the left side of the screen



▶ FOCUS.....74

▶ SPOT FOCUS74

A sleeping child under dim light



▶ COLOR SLOW SHTR77

Operation flow

► Get ready (p. 14).

- On the “Memory Stick PRO Duo” you can use with your camcorder, see page 2.
- Your camcorder turns on when you open the LCD panel (p. 18).



► Record using your camcorder (p. 26).

■ Recording with HD (high definition) image quality

- Your camcorder is compatible with AVCHD format “1920 × 1080/50i” (p. 92), which provides highly-detailed, beautiful images.

■ Using QUICK ON by opening/closing the LCD panel (p. 29)

- When you close the LCD panel during standby/recording, your camcorder goes to sleep mode (power saving mode). You can start recording quickly when you open the LCD panel again.



⚡ Notes

- The default setting is [HD SP] which is AVCHD format “1440 × 1080/50i” (p. 62).
- You can also record with SD (standard definition) image quality (p. 57).
- “AVCHD 1080i format” is abbreviated as “AVCHD” in this manual, except when it must be described in more detail.



► Play back the images using your camcorder.

■ Viewing on the LCD screen of your camcorder (p. 31)

■ Viewing on a high definition TV (p. 39)

You can enjoy highly-detailed, brilliant quality HD (high definition) movies.



💡 Tips

- You can consult the [TV CONNECT Guide] (p. 38) displayed on the screen on connecting your TV and camcorder.
- You can play back the images on a SD (standard definition) image quality TV.

► Play back the images from the Memory Stick slot of AVCHD format compatible devices.

You can play images saved on a “Memory Stick PRO Duo” inserted into the Memory Stick slot of AVCHD format compatible devices, such as a PLAYSTATION®3*¹ or VAIO*².



*¹ The PLAYSTATION®3 may not be available in some countries/regions.

*² The operation has been confirmed on the VAIO put on the market after January, 2006 that satisfy the recommended operating requirements of the supplied software (Picture Motion Browser).

- Always maintain your PLAYSTATION®3 to use the latest version of the PLAYSTATION®3 system software.
- You may not be able to play images directly from the Memory Stick slot, depending on the AVCHD format compatible device.



► Save recorded images.

■ Dubbing to other devices (p. 52)

The dubbing image quality (HD (high definition)/SD (standard definition)) varies depending on the connected device. For details, see page 52.



■ Editing on a computer (p. 44)

You can import images with HD (high definition) image quality to a computer, or save images on a disc. Refer to “PMB Guide.”



► Delete images.

If the “Memory Stick PRO Duo” is full, you cannot record new images. Delete image data that has been saved on a computer or a disc from the “Memory Stick PRO Duo.” If you delete images that have been saved elsewhere, you can record new images on newly freed up space of the “Memory Stick PRO Duo.”



■ Deleting the selected images (p. 46)

■ Deleting all the images ([MEDIA FORMAT], p. 58)

Expected recording time of movies

The recording time depends on the capacity of “Memory Stick PRO Duo” and recording mode (p. 62).

Approximate recordable time in minutes (Minimum recordable time in minutes)

| “Memory Stick PRO Duo” capacity | 1GB | 2GB | 4GB | 8GB | 16GB |
|--|---------|---------|---------|-----------|-----------|
| HD (high definition) image quality AVCHD format | | | | | |
| AVC HD 16M (FH) (highest quality)* | 6 (6) | 10 (10) | 25 (25) | 55 (55) | 110 (110) |
| AVC HD 9M (HQ) (high quality)** | 10 (9) | 25 (20) | 55 (40) | 115 (80) | 230 (160) |
| AVC HD 7M (SP) (standard quality)** | 15 (10) | 30 (20) | 65 (45) | 140 (100) | 280 (200) |
| AVC HD 5M (LP) (long play)** | 20 (15) | 40 (35) | 85 (70) | 180 (145) | 355 (290) |

* Movies are recorded with AVCHD 1920 × 1080/50i format.

** Movies are recorded with AVCHD 1440 × 1080/50i format.

| “Memory Stick PRO Duo” capacity | 1GB | 2GB | 4GB | 8GB | 16GB |
|--|---------|---------|-----------|-----------|-----------|
| SD (standard definition) image quality MPEG2 format | | | | | |
| SD 9M (HQ) (high quality) | 10 (10) | 25 (25) | 55 (50) | 115 (100) | 230 (205) |
| SD 6M (SP) (standard quality) | 20 (10) | 40 (25) | 80 (50) | 170 (100) | 340 (205) |
| SD 3M (LP) (long play) | 35 (25) | 80 (50) | 160 (105) | 325 (215) | 655 (435) |

• When using a “Memory Stick PRO Duo” made by Sony Corporation.

Tips

- Figures such as 16M in the table show the average bit rate. M stands for Mbps.
- For the recordable number of still images, see page 66.
- You can record movies of a maximum of 3,999 scenes with HD (high definition) image quality, and 9,999 scenes with SD (standard definition) image quality.

Your camcorder uses the VBR (Variable Bit Rate) format to automatically adjust image quality to suit the recording scene. This technology causes fluctuations in the recording time of the “Memory Stick PRO Duo.” Movies containing quickly moving and complex images are recorded at a higher bit rate, and this reduces the overall recording time.

“HOME” and “OPTION”

- Taking advantage of two types of menus

“HOME MENU” - the starting point for operations with your camcorder

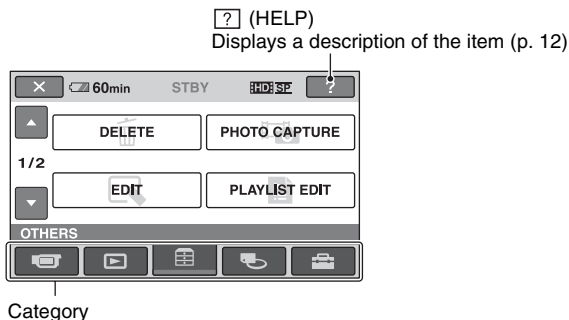

► Categories and items of the HOME MENU

(CAMERA) category

| Item | Page |
|--------------|------|
| MOVIE* | 27 |
| PHOTO* | 27 |
| SMTH SLW REC | 30 |

(VIEW IMAGES) category

| Item | Page |
|---------------|------|
| VISUAL INDEX* | 31 |
| INDEX* | 34 |
| INDEX* | 34 |
| PLAYLIST | 50 |

(OTHERS) category

| Item | Page |
|-----------------|------|
| DELETE* | 46 |
| PHOTO CAPTURE** | 47 |
| EDIT | 48 |
| PLAYLIST EDIT | 49 |
| PRINT | 55 |
| USB CONNECT | 53 |

| Item | Page |
|-------------------|------|
| TV CONNECT Guide* | 38 |

(MANAGE MEDIA) category

| Item | Page |
|------------------|------|
| SET* | 57 |
| MEDIA INFO | 58 |
| MEDIA FORMAT* | 58 |
| REPAIR IMG.DB F. | 59 |

(SETTINGS) category*

To customize your camcorder (p. 60).

* You can also set these items during Easy Handycam operation (p. 22). For the items available in the (SETTINGS) category, see p. 61.

** For HDR-TG1E.

Using the HOME MENU

- 1 Open the LCD panel to turn on your camcorder.

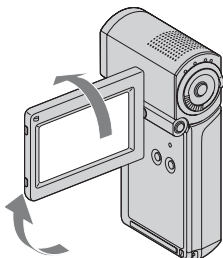

- 2 Touch  (HOME).

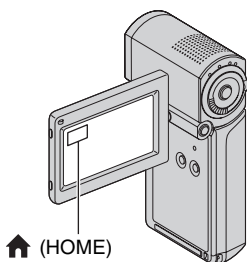

- 3 Touch the desired category.

Example:  (OTHERS) category



- 4 Touch the desired item.

Example: [EDIT]

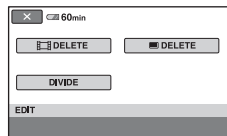

- 5 Follow the guide on the screen for further operation.

To hide the HOME MENU screen

Touch .

- When you want to know something about the function of each item on the HOME MENU - HELP

- 1 Touch  (HOME).

The HOME MENU appears.



- 2 Touch  (HELP).

The bottom of the  (HELP) turns orange.



3 Touch the item you want to learn more about.



When you touch an item, its explanation appears on the screen.

To apply the option, touch [YES], otherwise, touch [NO].

To deactivate the HELP

Touch [?] (HELP) again in step 2.

Using the OPTION MENU

Just a touch on the screen during shooting or playback displays the functions available at that moment. You will find it easy to make various settings. See page 72 for further details.

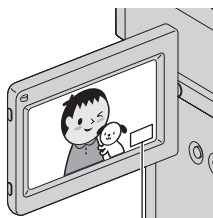

 (OPTION)

Step 1: Checking supplied items

Make sure that you have the following items supplied with your camcorder. The number in the parentheses indicates the number of that item supplied.

"Memory Stick PRO Duo" 4 GB (1) (p. 21)

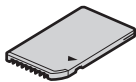

AC Adaptor (1) (p. 15)

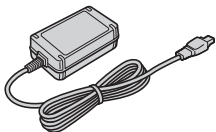

Power cord (Mains lead) (1) (p. 15)



Handycam Station (1) (p. 15, 102)

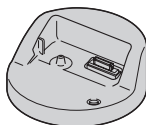

Component A/V cable (1) (p. 39)

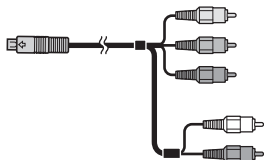

A/V connecting cable (1) (p. 39, 52)



USB cable (long) (1)
USB cable (short) (1) (p. 53, 55)

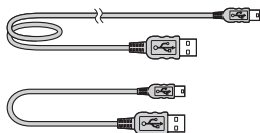

Dedicated USB Terminal Adaptor (1)/
USB adaptor cap (1) (p. 101)

The Dedicated USB Terminal Adaptor and the USB adaptor cap are attached to the USB cable (short) beforehand.



Rechargeable battery pack (1) (p. 15, 93)
NP-FH50

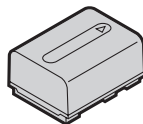

21-pin adaptor (p. 42)

For the model with the **CE** mark printed on their bottom surfaces only.

Wrist strap (1) (p. 101)

CD-ROM "Handycam Application Software" (1)

- Picture Motion Browser (Software)
- PMB Guide
- Handycam Handbook (This Handbook)

"Operating Guide" (1)

Step 2: Charging the battery pack

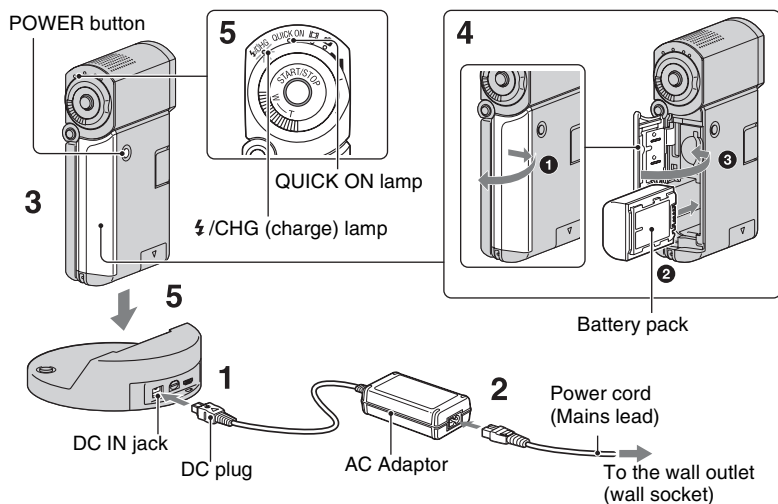

You can charge the “InfoLITHIUM” battery pack NP-FH50 (p. 93) after attaching it to your camcorder.

Notes

- You cannot attach any “InfoLITHIUM” battery pack other than NP-FH50 to your camcorder.

1 Connect the AC Adaptor to the DC IN jack on the Handycam Station.

Be sure that the ▲ mark on the DC plug is facing up.

2 Connect the power cord (mains lead) to the AC Adaptor and the wall outlet (wall socket).

3 Make sure that the LCD panel is closed.

4 Insert the battery.

- 1 Open the battery/Memory Stick Duo cover.
- 2 Insert the battery pack all the way in until it clicks.
- 3 Close the battery/Memory Stick Duo cover.

5 Place the camcorder on the Handycam Station as shown above, and insert it into the Handycam Station securely, all the way to the bottom.

The ⚡/CHG (charge) lamp lights up and charging starts. When the ⚡/CHG (charge) lamp turns off, the battery is fully charged.

⚡ Notes

- You cannot charge the battery pack while the QUICK ON lamp is flashing. When the QUICK ON lamp is flashing, press POWER to turn off your camcorder. Make sure the QUICK ON lamp is not flashing before charging the battery pack.
- When inserting the camcorder into the Handycam Station, close the DC IN jack cover.
- Disconnect the AC Adaptor from the DC IN jack holding both the Handycam Station and the DC plug.

To remove your camcorder from the Handycam Station

Close the LCD panel, then remove the camcorder from the Handycam Station holding both your camcorder and the Handycam Station.

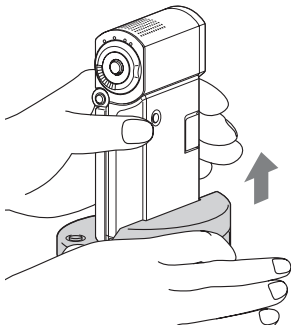

To charge the battery pack using only the AC Adaptor

Close the LCD panel with your camcorder turns off, then connect the AC Adaptor to the DC IN jack on your camcorder.

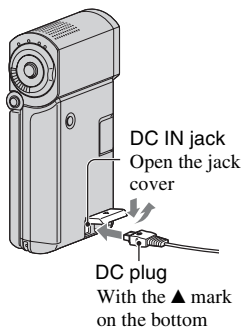

⚡ Notes



- Disconnect the AC Adaptor from the DC IN jack holding both the camcorder and the DC plug.

To remove the battery pack

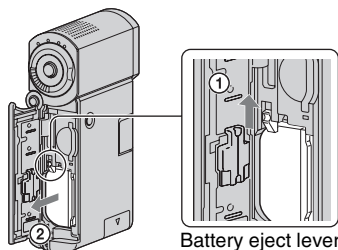
Turn off your camcorder and open the battery/Memory Stick Duo cover. Slide the battery eject lever. Be sure not to drop the battery pack.



⚡ Notes

- When you remove the battery pack or disconnect the AC Adaptor, make sure that the  (Movie) lamp/ (Still) lamp (p. 19)/access lamp (p. 21)/QUICK ON lamp are turned off.
- When you store the battery pack, fully discharge the battery before storing it for an extended period (see page 94 for the details of storage).

To use a power source from a wall outlet (wall socket)

Make the same connections as you do when charging the battery pack. The battery pack will not lose its charge in this case.

To check the remaining battery (Battery Info)

After opening the LCD panel, press POWER to turn off your camcorder, then press DISP/BATT INFO.

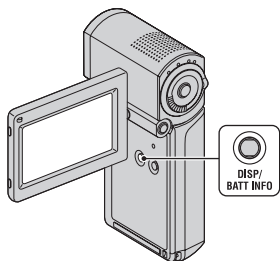

After a while, the approximate recordable time and battery information appear for about 7 seconds. You can view the battery information for up to 20 seconds by pressing DISP/BATT INFO again while the information is displayed.

Remaining battery (approx.)

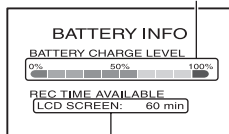

Recording capacity (approx.)

Available running time for the battery pack

Charging time:

Approximate time (min.) required when you fully charge a completely exhausted battery pack.

Recording/Playback time:

Approximate time (min.) available when you use a fully charged battery pack.

“HD” stands for high definition image

quality, and “SD” stands for standard image quality.

(Unit: min.)

| | HD | SD |
|--------------------------------------|-----|-----|
| Charging time | 135 | |
| Recording time* ¹⁺² | | |
| Continuous recording time | 100 | 120 |
| Typical recording time* ³ | 50 | 60 |
| Playback time* ² | 135 | 145 |

*¹ [REC MODE]: SP

*² When the LCD backlight is on.

*³ Typical recording time shows the time when you repeat recording start/stop, turning the power on/off and zooming.

On the battery pack

- When you remove the battery pack, turn off your camcorder, and turn off the (Movie) lamp/ (Still) lamp (p. 19)/access lamp (p. 21)/QUICK ON lamp.
- The /CHG (charge) lamp flashes during charging, or Battery Info (p. 17) will not be correctly displayed under the following conditions:
 - The battery pack is not inserted correctly.
 - The battery pack is damaged.
 - The battery pack is worn-out (For Battery Info only).
- The power will not be supplied from the battery as long as the AC Adaptor is connected to the DC IN jack of your camcorder or the Handycam Station, even when the power cord (mains lead) is disconnected from the wall outlet (wall socket).

On the charging/recording/playback time

- Times measured when using the camcorder at 25 °C (77 °F) (10 °C to 30 °C (50 °F to 86 °F) is recommended).
- The recording and playback time will be shorter when you use your camcorder in low temperatures.
- The recording and playback time will be shorter depending on the conditions under which you use your camcorder.

On the AC Adaptor

- Use the nearby wall outlet (wall socket) when using the AC Adaptor. Disconnect the AC Adaptor from the wall outlet (wall socket) immediately if any malfunction occurs while using your camcorder.
- Do not use the AC Adaptor placed in a narrow space, such as between a wall and furniture.
- Do not short-circuit the DC plug of the AC Adaptor or battery terminal with any metallic objects. This may cause a malfunction.
- Even if your camcorder is turned off, AC power source (mains) is still supplied to it while connected to the wall outlet (wall socket) via the AC Adaptor.

Step 3: Turning the power on and adjusting the LCD panel

Your camcorder turns on when you open the LCD panel.

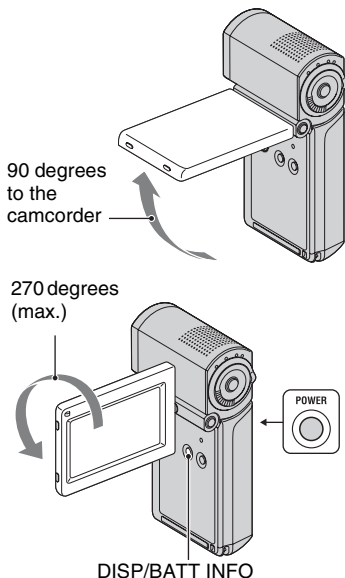

1 Open the LCD panel.

Your camcorder turns on.

To turn on your camcorder when the LCD panel is opened, close it and open it again, or press POWER with the LCD panel opened.

2 Adjust the LCD panel.

Rotate the LCD panel to the best angle to record or play.

Step 4: Setting the date and time

To turn off the LCD backlight to make the battery last longer

Press and hold DISP/BATT INFO for a few seconds until  appears.

This setting is practical when you use your camcorder in bright conditions or you want to save battery power. The recorded image will not be affected by the setting. To turn on the LCD backlight, press and hold DISP/BATT INFO for a few seconds until  disappears.



To turn off the power



When recording standby/recording mode, close the LCD panel, then press POWER. Otherwise, close the LCD panel or press POWER.

Notes

- If you do not use your camcorder for **about 3 months**, the built-in rechargeable battery gets discharged and the date and time settings may be cleared from the memory. In that case, charge the built-in rechargeable battery and then set the date and time again (p. 97).
- It takes a few seconds for your camcorder to be ready to shoot after the power is turned on. You cannot operate your camcorder during this time.
- The lens cover opens automatically when the power is turned on. It closes when the playback screen is selected, or the power is turned off.
- In the setting at the time of purchase, the power turns off automatically if you leave your camcorder without any operation attempted for approximately 5 minutes, to save battery power ([A.SHUT OFF], p. 71).



Tips

- If you rotate the LCD panel 180 degrees, you can close the LCD panel with the LCD screen facing out. This is convenient during playback operations.
- Touch  (HOME) →  (SETTINGS) → [SOUND/DISP SET] → [LCD BRIGHT] (p. 68), and adjust the brightness of the LCD screen.
- The information is displayed or hidden (display ↔ no display) each time you press DISP/BATT INFO.

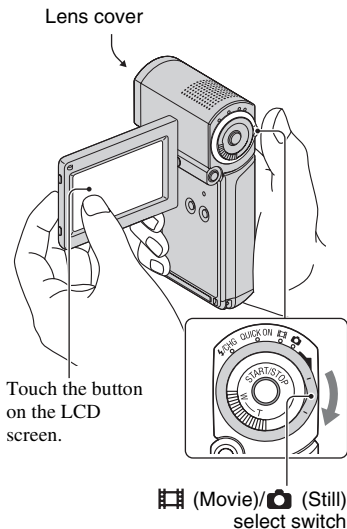
Set the date and time when using this camcorder for the first time. If you do not set the date and time, the [CLOCK SET] screen appears every time you turn on your camcorder or change the  (Movie)/ (Still) select switch position.



1 Open the LCD panel to turn on your camcorder.

2 Slide the  (Movie)/ (Still) select switch repeatedly in the direction of the arrow until the respective lamp lights up.

 (Movie): To record movies

 (Still): To record still images

Go to step 4 when you turn on your camcorder for the first time.

-
- 3** Touch **HOME** → **SETTINGS** → **[CLOCK/ LANG]** → **[CLOCK SET]**.

The **[CLOCK SET]** screen appears.

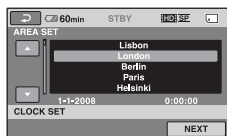

-
- 4** Select the desired geographical area with **▲/▼**, then touch **[NEXT]**.

-
- 5** Set **[SUMMERTIME]**, then touch **[NEXT]**.

-
- 6** Set **[Y]** (year) with **▲/▼**.



-
- 7** Select **[M]** with **◀/▶**, then set the month with **▲/▼**.

-
- 8** Set **[D]** (day), hour and minute in the same way, then touch **[NEXT]**.

-
- 9** Make sure that the clock is correctly set, then touch **[OK]**.

The clock starts.

You can set any year up to the year 2037.

Tips

- The date and time does not appear during recording, but they are automatically recorded on the “Memory Stick PRO Duo,” and can be displayed during playback (**[DATA CODE]**, p. 67).
- Refer to page 90 for information concerning “World time difference.”
- If the buttons on the touch panel do not work correctly, adjust the touch panel (**[CALIBRATION]**, p. 96).

Changing the language setting

You can change the on-screen displays to show messages in a specified language. To select the screen language, touch

HOME → **SETTINGS** → **[CLOCK/ LANG]** → **[LANGUAGE SET]** (p. 70).

Step 5: Inserting a “Memory Stick PRO Duo”

See page 2 on the “Memory Stick” you can use with your camcorder.

💡 Tips

- See following pages on the recordable time of movies and recordable number of still images.
 - Movies (p. 10)
 - Still images (p. 66)

1 Insert the “Memory Stick PRO Duo.”

- 1 Open the battery/Memory Stick Duo cover.
- 2 Insert the “Memory Stick PRO Duo” all the way in until it clicks.
- 3 Close the battery/Memory Stick Duo cover.

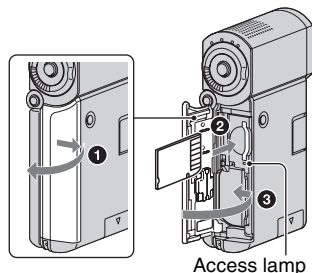

2 Open the LCD panel and turn on the (Movie) lamp.



When you insert a new “Memory Stick PRO Duo,” the [Create a new Image Database File.] screen appears.





3 Touch [YES].

To eject a “Memory Stick PRO Duo”

Open the battery/Memory Stick Duo cover, lightly push the “Memory Stick PRO Duo” in once.

🔌 Notes

- Do not do any of the following when the  (Movie)/ (Still) mode lamps (p. 19), the access lamp or the QUICK ON lamp (p. 15) is lit or flashing. Otherwise, the media may be damaged, recorded images may be lost or other malfunctions could occur.
 - Eject the “Memory Stick PRO Duo” from the camcorder
 - Remove the battery pack or AC Adaptor
 - Shake or knock your camcorder
- Do not open the battery/Memory Stick Duo cover during recording.
- If you force the “Memory Stick PRO Duo” into the slot in the wrong direction, the “Memory Stick PRO Duo,” the Memory Stick Duo slot, or image data may be damaged.
- If [Failed to create a new Image Database File. It may be possible that there is not enough free space.] is displayed on step 3, format the “Memory Stick PRO Duo” (p. 58). Note that formatting will delete all data recorded on the “Memory Stick PRO Duo.”
- When inserting or ejecting the “Memory Stick PRO Duo,” be careful so that the “Memory Stick PRO Duo” does not pop out and drop.

💡 Tips

- You can shoot still images without creating a management file.



Recording and playback with ease (Easy Handycam operation)

Easy Handycam operation makes nearly all settings automatic so that you can perform recording or playback operation without detailed settings. It also makes the screen font size larger for easy viewing.

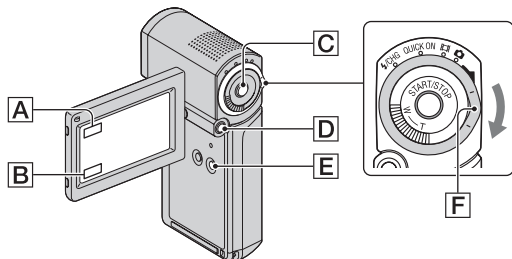

Recording movies



- 1 Open the LCD panel to turn on the  (Movie) lamp.

- 2 Press EASY .



EASY appears on the LCD screen.

- 3 Press START/STOP  to start recording.*

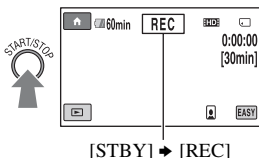





To stop recording, press START/STOP again.

Recording still images





- 1 Open the LCD panel.

- 2 Slide the  (Movie)/ (Still) select switch  in the direction of the arrow until the  (Still) lamp lights up.

- 3 Press EASY .



EASY appears on the LCD screen.

- 4 Press PHOTO  lightly to adjust the focus  (a beep sounds), then press it fully  (a shutter click sounds).

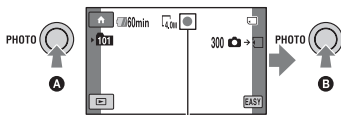

Flashing → Lights up

* The [REC MODE] is fixed to [HD SP] or [SD SP] (p. 62).

Notes

- If you close the LCD panel during recording, the recording will be stopped.

Tips

- During Easy Handycam operation, faces are detected with frames ([FACE DETECTION], p. 65).

Playing back recorded movies/still images

1 Open the LCD panel to turn on your camcorder.

2 Touch (VIEW IMAGES) .

The VISUAL INDEX screen appears on the LCD screen (It may take some time to display the thumbnails).

Appears with the image on each of the tab that was lastly played back/recorded ( for the still image)

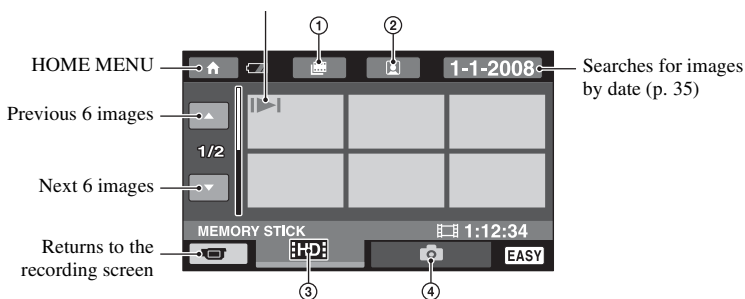



①  :Goes to the Film Roll Index screen.

②  :Goes to the Face Index screen.

③  :Displays movies with HD (high definition) image quality.*

④  :Displays still images.

*  appears when you select the movie with SD (standard definition) image quality in  (p. 57).

3 Start playback.

Movies:

Touch the **[HDI]** or **[HSD]** tab, and then touch the desired movie to play back.

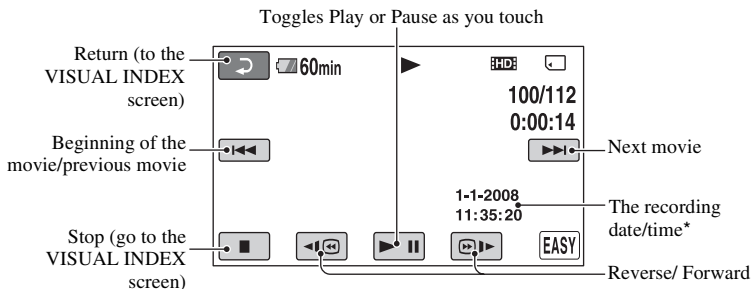

* The setting of [DATA CODE] is fixed to [DATE/TIME] (p. 67).

💡 Tips

- When playback from the selected movie reaches the last movie, the screen returns to the VISUAL INDEX screen.
- You can slow down the playback speed by touching **[<|@|/|@|>]** during pause.
- You can adjust volume by touching **[HOME]** **[A]** → **[SETTINGS]** → **[SOUND SETTINGS]** → **[VOLUME]**, then touch **[-]** / **[+]**.
- To change the image quality of the movie for playback, select the desired image quality with **[HDI/HSD SET]** (p. 57).

Still images:

Touch the **[CAM]** tab, and then touch the desired still image to play back.

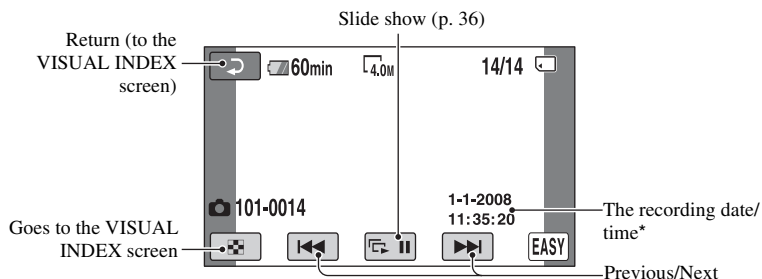

* The setting of [DATA CODE] is fixed to [DATE/TIME] (p. 67).

📌 Notes

- If you close the LCD panel while the index screen is displayed or while playing back the images, the camcorder turns off.

To cancel Easy Handycam operation

Press EASY **[E]** again. **EASY** disappears from the LCD screen.

Menu settings during Easy Handycam operation

Touch **▲** (HOME) **[A]** to display the menu items available for setup changes (p. 11, 60).

🔍 Notes

- Most of the menu items automatically return to the default settings. The settings of some menu items are fixed. For details, see page 79.
- You cannot use the **☰** (OPTION) MENU.
- Cancel Easy Handycam operation if you want to add effects to images or change settings.

Invalid functions during Easy Handycam operation

You cannot use some functions during Easy Handycam operation since they are automatically set (p. 79).

Recording

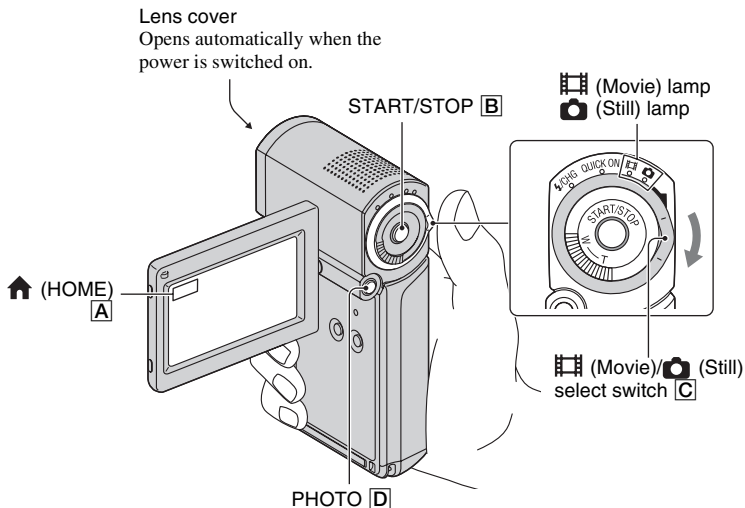

Notes

- If the access lamp is lit or flashing after recording is finished, it means data is still being written onto the "Memory Stick PRO Duo." Do not apply shock or vibration to your camcorder, and do not remove the battery or AC Adaptor.
- When a movie file exceeds 2 GB, the next movie file is created automatically.
- If you close the LCD panel during recording, the recording will be stopped.

Tips

- For types of "Memory Stick" you can use in your camcorder, see page 2.
- You can check the recordable time and the remaining capacity, etc., by touching **HOME [A]** → **MANAGE MEDIA** → [MEDIA INFO] (p. 58).
- Movies are recorded in the HD (high definition) image quality in the default setting (p. 57).
- For the recordable time and the number of recordable images, see page 10 and 66.
- You can record still images during movie recording by pressing **PHOTO [D]** ([Dual Rec], p. 29).
- A frame is shown on the detected face, and the detected face image is optimized automatically ([FACE DETECTION], p. 65).
- When a face is detected during movie recording, **FACE** flashes and the detected face is stored in the index. You can search for a desired scene by a face image when playing back ([Face Index], p. 34).
- You can capture still images from recorded movies (HDR-TG1E) (p. 47).
- You can switch the shooting mode by touching **HOME [A]** → **CAMERA** → [MOVIE] or [PHOTO].

Recording movies



- 1 Open the LCD panel to turn on the (Movie) lamp.
- 2 Press START/STOP **B**.

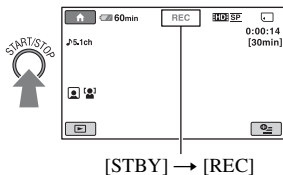

To stop recording, press START/STOP **B** again.

Recording still images



- 1 Open the LCD panel.
- 2 Slide the (Movie)/ (Still) select switch **C** in the direction of the arrow until the (Still) lamp lights up.
- 3 Press PHOTO **D** lightly to adjust the focus **A** (a beep sounds), then press it fully **B** (a shutter click sounds).

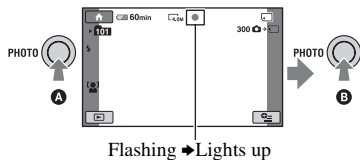

appears beside . When disappears, the image has been recorded.

The “White circular spots” on still images

This is caused by particles (dust, pollen, etc.) floating close to the lens. When they are accentuated by the camcorder’s flash, they appear as white circular spots.

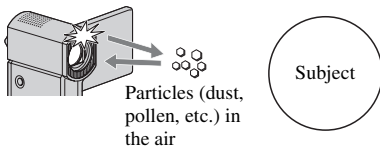

To reduce the “White circular spots,” light the room and shoot the subject without a flash.

Zooming

You can magnify images up to 10 times the original size with the power zoom lever.

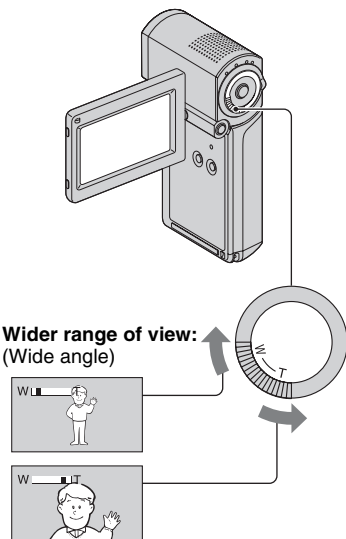

Wider range of view:
(Wide angle)

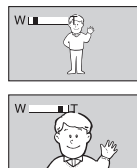

Close view: (Telephoto)

Move the power zoom lever slightly for a slower zoom. Move it further for a faster zoom.

Notes

- Be sure to keep your finger on the power zoom lever. If you move your finger off the power zoom lever, the operation sound of the power zoom lever may also be recorded.
- The minimum possible distance between camcorder and subject while maintaining sharp focus is about 1 cm (about 13/32 in.) for wide angle and about 80 cm (about 2 5/8 feet) for telephoto.

Tips

- You can set [DIGITAL ZOOM] (p. 63) if you want to zoom to a level greater than 10 × when recording movies.

Recording sound with more presence (5.1ch surround recording)

Dolby Digital 5.1ch surround sound can be recorded with the Built-in microphone. You can enjoy realistic sound when playing the movie on devices that support 5.1ch surround sound.

Built-in microphone

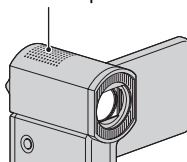

Dolby Digital 5.1 Creator, 5.1ch surround sound
☞ Glossary (p. 105)

Notes

- 5.1ch sound is converted to 2ch when played back on your camcorder.
- To enjoy the 5.1ch surround sound recorded with HD (high definition) image quality, you need an AVCHD format device compatible with 5.1ch surround.
- When you connect your camcorder with an HDMI cable (optional), the sound of movies with HD (high definition) image quality is automatically output in 5.1ch sound. The sound of the movies with SD (standard definition) image quality is converted to 2ch.

Tips

- You can select the recording sound from [5.1ch SURROUND] (⏮5.1ch) or [2ch STEREO] (⏮2ch) ([AUDIO MODE], p. 62).

Starting shooting quickly (QUICK ON)

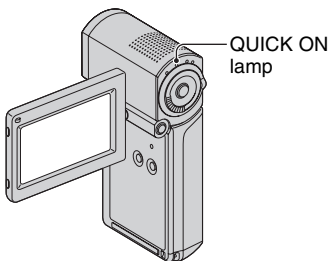

When you close the LCD panel, the camcorder goes to sleep mode (power saving mode) instead of turning off. The QUICK ON lamp keeps flashing during sleep mode. Open the LCD panel again to start recording next time. Your camcorder returns to recording standby in approximately 1 second.

💡 Tips

- During sleep mode, the battery is consumed at about half that of usual recording.
- The power turns off automatically if you do not operate your camcorder for a certain period during sleep mode. You can set the time that you want the camcorder to remain on before automatically turning off in sleep mode ([QUICK ON STBY], p. 71).
- If you close the LCD panel while recording with [SMTH SLW REC] (p. 30), your camcorder will turn off without performing sleep mode.

Recording high quality still images during movie recording (Dual Rec)

You can record high quality still images during movie recording by pressing PHOTO.

📌 Notes

- Do not eject the “Memory Stick PRO Duo” before movie recording is finished and the still images are completely stored on the “Memory Stick PRO Duo.”
- You cannot use the flash during Dual Rec.
- 📷 may appear when the capacity of the “Memory Stick PRO Duo” is not enough or when you record still images continuously. You cannot record still images while 📷 is displayed.

💡 Tips

- When the 📺 (Movie) lamp is lit, the size of still images becomes [📺 2.3M] (16:9 wide) or [1.7M] (4:3).
- You can record still images during recording standby in the same way as when the 📷 (Still) lamp is turned on. You can also record with the flash.

Recording in mirror mode

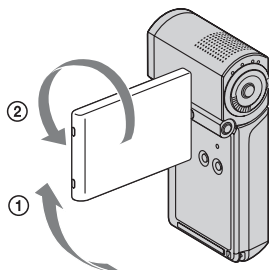

Open the LCD panel 90 degrees to the camcorder (①), then rotate it 270 degrees to the lens side (②).

💡 Tips

- A mirror-image of the subject appears on the LCD screen, but the image will be normal when recorded.
- When recording in mirror mode, frames on the detected faces are not displayed (p. 65).

Recording the fast action in slow-motion (SMTH SLW REC)

Fast moving subjects and actions, which cannot be captured under the ordinary shooting conditions, can be shot in smooth moving slow-motion for about 3 seconds. This is useful to shoot fast actions such as a golf or tennis swing.

- 1 Touch (HOME) → (CAMERA) → [SMTH SLW REC].

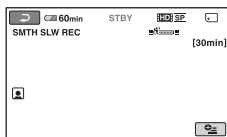

- 2 Press START/STOP.

A 3-second movie (approx.) is recorded as a 12 second-slow-motion-movie.

[Recording...] disappears, when recording is finished.

Touch to cancel the smooth slow recording.

To change the setting

Touch (OPTION) → tab, then select the setting you want to change.

- [TIMING]

Select the recording start point after START/STOP is pressed. The default setting is [3sec AFTER].

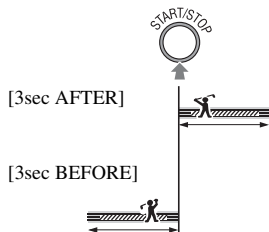

- [RECORD SOUND]
Select [ON] () to superimpose sounds such as conversation on the slow motion pictures (The default setting is [OFF]). Your camcorder records sounds for about 12 seconds while [Recording...] is displayed in step ②.

Notes

- Sounds cannot be recorded while shooting a 3-second movie (approx.).
- Image quality of [SMTH SLW REC] is not as good as that of normal recording.
- During Easy Handycam operation, the [SMTH SLW REC] function cannot be used. Cancel Easy Handycam operation.

Playback

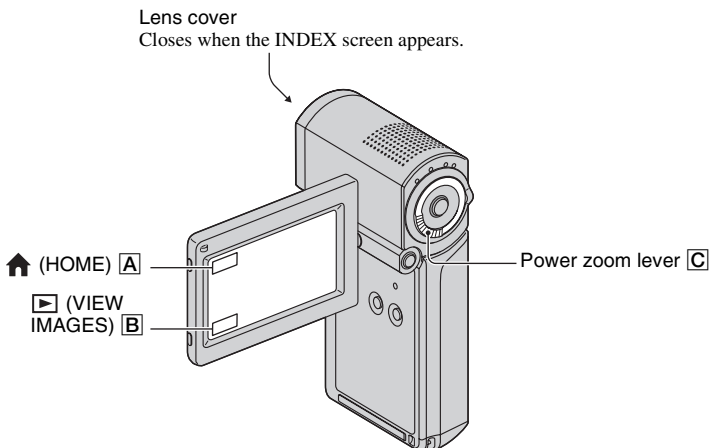

Notes

- If you close the LCD panel while the index screen is displayed or while playing back the images, the camcorder turns off.

1 Open the LCD panel to turn on your camcorder.

2 Touch ▶ (VIEW IMAGES) **B**.

The VISUAL INDEX screen appears on the LCD screen (It may take some time to display the thumbnails).

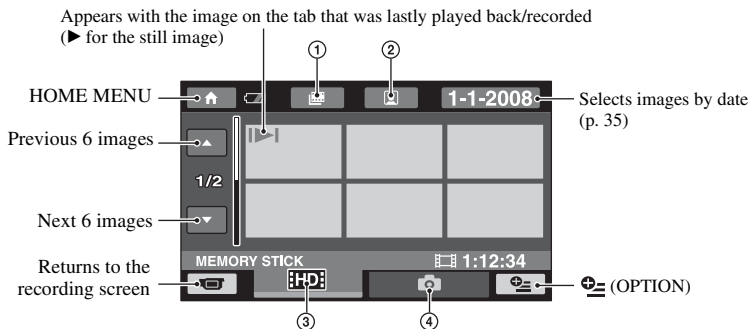

- ① :Goes to the Film Roll Index screen (p. 34).
- ② :Goes to the Face Index screen (p. 34).
- ③ **HD** :Displays movies with HD (high definition) image quality.*
- ④ :Displays still images.

* **SD** appears when you select the movie with SD (standard definition) image quality in **[HD/SD] SET** (p. 57).

Tips

- The number of the images on the VISUAL INDEX screen can be changed 6 ↔ 12 by moving the power zoom lever **[C]**. To fix this number, touch (HOME) **[A]** → (SETTINGS) → **[VIEW IMAGES SET]** → **[DISPLAY]** (p. 68).

3 Start playing back.

Playing movies



Touch the **HD** or **SD** tab, then select the desired movie to play back.

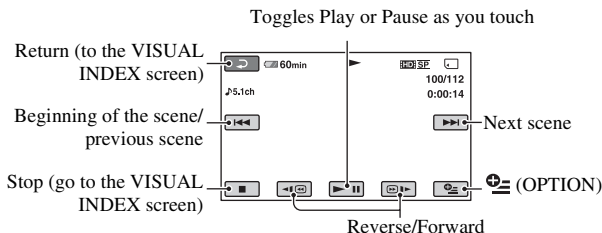

Tips

- When playback from the selected movie reaches the last movie, the screen returns to the VISUAL INDEX screen.
- Touch / during pause to play back movie slowly.
- A touch of / makes the reverse/fast forward approximately 5 times faster, 2 touches makes it approximately 10 times faster, 3 touches makes it approximately 30 times faster, and 4 touches makes it approximately 60 times faster.



Touch the tab, then select the desired still image to play back.

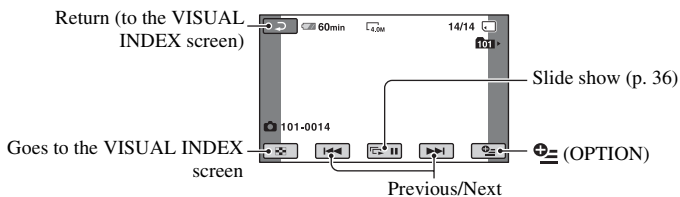

To adjust the sound volume

Touch (OPTION) → tab → [VOLUME], then adjust the volume with / .

Tips

- You can switch the playback mode by touching (HOME) → (VIEW IMAGES) → [VISUAL INDEX].

Searching for desired scene by pinpoint (Film Roll Index)

Movies can be divided by a set time and the first scene of each division is displayed on the index screen. You can start playing back a movie from the selected thumbnail.

1 Turn on the camcorder, and touch (VIEW IMAGES).

The VISUAL INDEX screen appears.

2 Touch (Film Roll Index).

Returns to the VISUAL INDEX screen

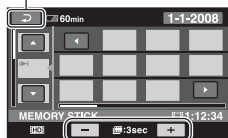



Sets the interval at which to create thumbnails of scenes in a movie.

3 Touch / to select the desired movie.

4 Touch / to search for the desired scene, then touch the scene you want to play back.

Playback starts from the selected scene.

Tips

- You can display the [Film Roll Index] screen by touching  (HOME) →  (VIEW IMAGES) →  [INDEX].

Searching for desired scene by face (Face Index)

The face images detected during movie recording are displayed on the index screen. You can play back the movie from the selected face image.

1 Turn on the camcorder, and touch (VIEW IMAGES).

The VISUAL INDEX screen appears.

2 Touch (Face Index).

Returns to the VISUAL INDEX screen

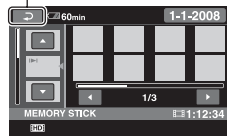



3 Touch / to select the desired movie.



4 Touch /, then touch the desired face image to view the scene.

Playback starts from the beginning of the scene with the selected face image.

Notes

- Faces may not be detected depending on recording conditions.
Example: People wearing glasses or hats, or who do not face towards the camera.
- Set  [INDEX SET] to [ON] before recording to play back from  [INDEX] (the default setting) (p. 65). Make sure that  flashes during recording, and detected face images are stored in [Face Index].

Tips

- You can display the [Face Index] screen by touching  (HOME) →  (VIEW IMAGES) →  [INDEX].

Searching for desired images by date (Date Index)

You can search for desired movies by date efficiently.

Notes

- You cannot use the Date Index function for still images.

1 Turn on the camcorder, and touch (VIEW IMAGES).

The VISUAL INDEX screen appears.

2 Touch the or tab.

3 Touch date on the screen.

The recording dates of movies are displayed on the screen.

Returns to the VISUAL INDEX screen

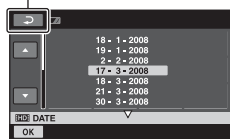

4 Touch / to select the date of the desired movie, then touch .

The movies of the selected date are displayed on the VISUAL INDEX screen.

Tips

- On the [Film Roll Index]/[Face Index] screen, you can use the Date Index function by following the steps 3 to 4.

Using PB zoom

You can magnify still images from about 1.1 to 5 times the original size.

Magnification can be adjusted with the power zoom lever.

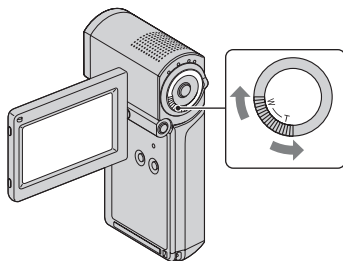

- ① Play back the still images you want to magnify.
- ② Magnify the still image with T (Telephoto). The screen is framed.
- ③ Touch the screen at the point you want to display in the center of the displayed frame.
- ④ Adjust the magnification with W (Wide angle)/T (Telephoto).

To cancel, touch .

Playing back a series of still images (Slide show)

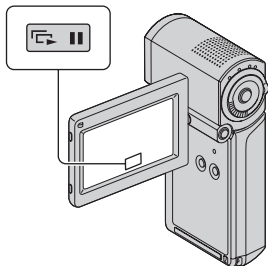

Touch  on the still image playback screen.

The slide show begins from the selected still image.





Touch  to stop the slide show.

To restart, touch  again.

Notes

- You cannot operate playback zoom during slide show.

Tips

- You can also play back the slide show by touching  (OPTION) →  tab → [SLIDE SHOW] on the VISUAL INDEX screen.
- You can set continuous slide show playback by touching  (OPTION) →  tab → [SLIDE SHOW SET]. The default setting is [ON] (continuous playback).

Playing the image on a TV

Connection methods and quality of the image viewed on the TV screen differ depending on what type of TV is connected, and the connectors used.

Use the supplied AC Adaptor as the power source (p. 15).

Refer also to the instruction manuals supplied with the device to be connected.

Notes

- When recording, set [X.V.COLOR] to [ON] to play back on an x.v.Color-compliant TV (p. 63). Some settings may need to be adjusted on the TV when playing back. Refer to the instruction manual of your TV for details.

Operation flow

You can connect your camcorder to the TV easily following the instructions displayed on the LCD screen, [TV CONNECT Guide].

Switch the input on the TV to the connected jack.

Refer to the instruction manuals of the TV.

↓
Connect your camcorder and TV referring to [TV CONNECT Guide].

↓
Make the required output settings on your camcorder (p. 39, 40).

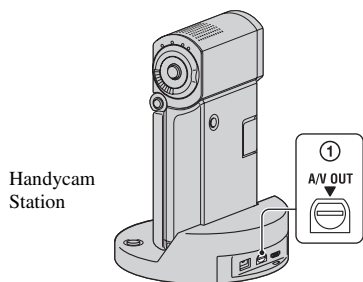
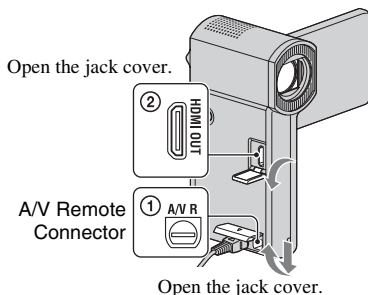





Notes

- Your camcorder and the Handycam Station are equipped with A/V Remote Connector or A/V OUT jack (p. 100, 102). Connect the A/V connecting cable or component A/V cable either to the Handycam Station or to your camcorder.

Selecting the most advantageous connection - [TV CONNECT Guide]

Your camcorder will advise you of the most advantageous way of connecting your TV.

- 1 Turn on your camcorder, and touch  (HOME) →  (OTHERS) → [TV CONNECT Guide].**

If the item is not on the screen, touch / to change the page.

- 2 Touch the answer to the question displayed on the screen.**

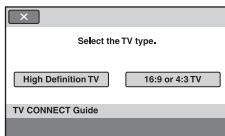

Meanwhile, you can make the relevant connection between your camcorder and the TV.

Connecting to a high definition TV

Images recorded with HD (high definition) image quality are played back with HD (high definition) image quality. Images recorded with SD (standard definition) image quality are played back with SD (standard definition) image quality.

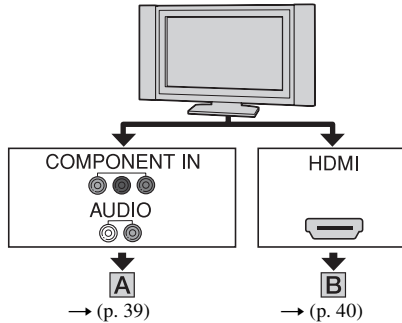

⇨ : Signal flow

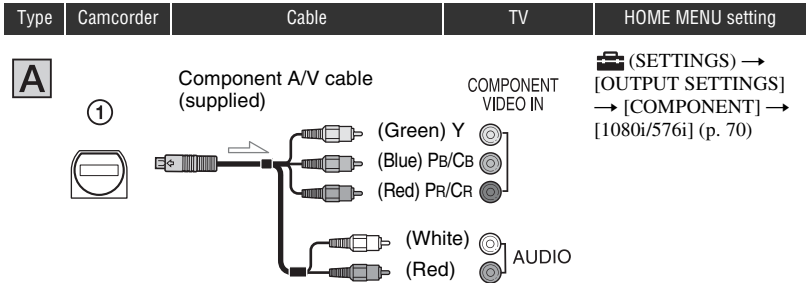

- If you connect only component video, audio signals are not output. Connect the white and red plugs to output audio signals.

| Type | Camcorder | Cable | TV | HOME MENU setting |
|------|-----------|-------|----|-------------------|
|------|-----------|-------|----|-------------------|

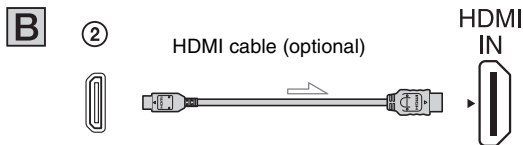

- Use an HDMI cable with the HDMI logo.
- Use an HDMI mini Connector on one end (for the camcorder), and a plug suitable for connection to your TV on the other end.
- Images are not output from the HDMI OUT jack of your camcorder, if copyright protection signals are recorded in the images.
- Some TVs may not function correctly (e.g., no sound or image) with this connection.
- Do not connect the HDMI OUT jack of your camcorder and HDMI OUT jack of the external device with the HDMI cable. This may cause a malfunction.
- When the connected device is compatible with 5.1ch surround sound, movies recorded with the HD (high definition) image quality are output on 5.1ch surround sound automatically. Movies recorded with the SD (standard definition) image quality are converted to 2ch sound.

Connecting to a non-high-definition 16:9 (wide) TV or 4:3 TV

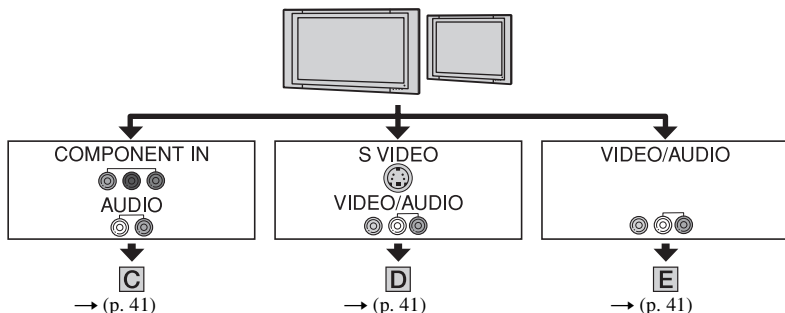

Images recorded with HD (high definition) quality are converted to SD (standard definition) and played back. Images recorded with SD (standard definition) image quality are played back with SD (standard definition) image quality.



To set the horizontal to vertical ratio according to the connected TV (16:9/4:3)

Set [TV TYPE] to [16:9] or [4:3] according to your TV (p. 69).

🔊 Notes

- When you play back a movie recorded with SD (standard definition) image quality on a 4:3 TV that is not compatible with the 16:9 signal, touch  (HOME) →  (SETTINGS) → [MOVIE SETTINGS] → [WIDE SELECT] → [4:3] on your camcorder when recording an image (p. 62).

| Type | Camcorder | Cable | TV | HOME MENU setting |
|------|-----------|-------|----|-------------------|
|------|-----------|-------|----|-------------------|

C

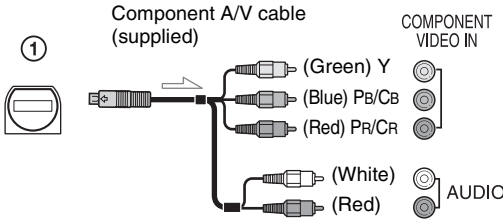

(SETTINGS) →
[OUTPUT SETTINGS]
→ [COMPONENT] →
[576i] (p. 70)

(SETTINGS) →
[OUTPUT SETTINGS]
→ [TV TYPE] → [16:9]/
[4:3]* (p. 69)

- If you connect only component video, audio signals are not output. Connect the white and red plugs to output audio signals.

D

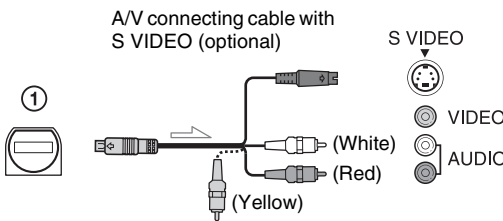

(SETTINGS) →
[OUTPUT SETTINGS]
→ [TV TYPE] → [16:9]/
[4:3]* (p. 69)

- When the S VIDEO plug (S VIDEO channel) is connected, audio signals are not output. To output audio signals, connect the white and red plugs to the audio input jack of your TV.
- This connection produces higher resolution images compared with the A/V connecting cable (Type **E**).

E

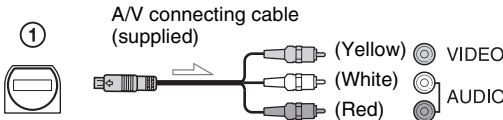

(SETTINGS) →
[OUTPUT SETTINGS]
→ [TV TYPE] → [16:9]/
[4:3]* (p. 69)

* Set [TV TYPE] according to your TV.

When connecting to your TV via a VCR

Connect your camcorder to the LINE IN input on the VCR using the A/V connecting cable. Set the input selector on the VCR to LINE (VIDEO 1, VIDEO 2, etc.).

When your TV is monaural (When your TV has only one audio input jack)

Connect the yellow plug of the A/V connecting cable to the video input jack and connect the white (left channel) or red (right channel) plug to the audio input jack of your TV or VCR.

If your TV/VCR has a 21-pin adaptor (EUROCONNECTOR)

Use the 21-pin adaptor supplied with your camcorder (For models with the **CE** mark printed on their bottom surfaces only). This adaptor is designed for output use only.

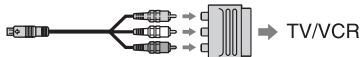

Notes

- When the A/V connecting cable is used to output images, images are output with SD (standard definition) image quality.

Tips

- If you connect your camcorder to the TV using more than one type of cable to output images, the order of priority of the TV input jacks is as follows:
HDMI → component → S VIDEO → video.
- HDMI (High Definition Multimedia Interface) is an interface to send both video/audio signals. The HDMI OUT jack outputs high quality images and digital audio.

On “PhotoTV HD”

Your camcorder is compatible with “PhotoTV HD.” “PhotoTV HD” allows for highly-detailed, photo-like depiction of subtle textures and colors. By connecting Sony’s PhotoTV HD-compatible devices using an HDMI cable* or a component A/V cable**, a whole new world of photos can be enjoyed in breathtaking full HD quality.

* The TV will automatically switch to the appropriate mode when displaying photos.

** Setup of the TV will be necessary. Please refer to the instruction manual of your PhotoTV HD-compatible TV for details.

Using “BRAVIA” Sync

You can do the playback operation with the remote commander of your TV by connecting your camcorder to a “BRAVIA” Sync compatible TV with the HDMI cable.

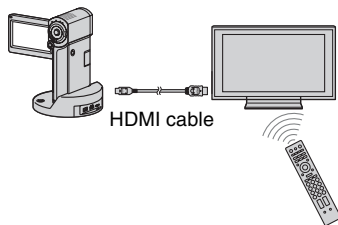



1 Connect your camcorder and a “BRAVIA” Sync compatible TV with the HDMI cable (optional).

2 Turn on your camcorder.



The TV input is switched automatically, and the image of your camcorder is displayed on the TV.

3 Operate the remote commander of the TV.

You can do the following operations.

- Display  (VIEW IMAGES) of  (HOME) by pressing the SYNC MENU button
- Display an INDEX screen, such as the VISUAL INDEX screen, by pressing up/down/left/right/enter buttons on the remote commander of your TV, and play back the desired movies or still images

Notes

- To set your camcorder, touch  (HOME) →  (SETTINGS) → [GENERAL SET] → [CTRL FOR HDMI] → [ON] (the default setting).
- Also set your TV. Refer to the instruction manual of the TV for details.

Tips

- If you turn off the TV, your camcorder is turned off simultaneously.

Saving images

Recorded images are stored on the “Memory Stick PRO Duo.” Due to the limited capacity of the “Memory Stick PRO Duo,” make sure that you save the image data to some type of external media such as a DVD-R or a computer.

You can save the images recorded on the camcorder as described below.

Saving images using a computer

By using “Picture Motion Browser” on the supplied CD-ROM, you can save the images recorded on the “Memory Stick PRO Duo.”

For HDR-TG1E

You can rewrite movies with HD (high definition) image quality from the computer to your camcorder, if necessary. For details, see “PMB Guide.”

Creating a disc with One Touch (One Touch Disc Burn)

You can save images recorded on the camcorder directly to a disc with ease.

Saving images on a computer

You can save images recorded on the camcorder on the hard disk of a computer.



Creating a disc with selected images

You can save images copied to your computer on a disc. You can also edit those images.



Refer to the supplied “Operating Guide.”

Saving images by connecting your camcorder to other devices

Connecting with the A/V connecting cable

You can dub movies with SD (standard definition) image quality.

Connecting with the USB cable

You can dub movies with HD (high definition) image quality or SD (standard definition) image quality.



See page 52.



(OTHERS) category

This category enables you to edit the images on the “Memory Stick PRO Duo.” Also, you can enjoy your camcorder by connecting to other devices.



 (OTHERS) category

Notes

- If you close the LCD panel while editing images or while the USB cable is connected with other devices, the camcorder turns off.

Item list

DELETE

You can delete images on the “Memory Stick PRO Duo” (p. 46).

PHOTO CAPTURE (HDR-TG1E)

You can save a selected frame from a recorded movie as a still image (p. 47).

EDIT

You can edit the images (p. 48).

PLAYLIST EDIT

You can create and edit a Playlist (p. 49).

PRINT

You can print still images on a connected PictBridge printer (p. 55).

USB CONNECT

You can connect the camcorder to a computer etc., via the USB cable. See “Operating Guide” for connecting to the computer.

TV CONNECT Guide

Your camcorder helps you select the appropriate connection for your device (p. 38).

Deleting images

You can delete images recorded on the “Memory Stick PRO Duo” using your camcorder.

Notes

- You cannot restore images once they are deleted.
- Do not remove the battery pack or the AC Adaptor, or eject “Memory Stick PRO Duo” from your camcorder while deleting the images. It may damage the media.
- When write-protection is set to the images in the “Memory Stick PRO Duo” by another device, you cannot delete the images.
- Important data should be saved on external media (p. 44).
- Do not try to delete the files on the “Memory Stick PRO Duo” in your camcorder using a computer.

Tips



- You can select up to 100 images at one time.
- You can delete an image on the playback screen from  (OPTION) MENU.
- To delete all images recorded in the “Memory Stick PRO Duo,” and recover all the recordable space, format the media (p. 58).

Deleting movies

You can increase the free space on the “Memory Stick PRO Duo” by deleting image data.

You can check the free space on the “Memory Stick PRO Duo” using [MEDIA INFO] (p. 58).

Select the image quality of the movie you want to delete before the operation (p. 57).

1 Touch  (HOME) →  (OTHERS) → [DELETE].

2 Touch  [DELETE].

3 Touch [HSD] DELETE] or [HSD] DELETE].

4 Touch the movie to be deleted.



The selected movie is marked with ✓. Press and hold the movie on the LCD screen to confirm the movie. Touch  to return to the previous screen.

5 Touch [OK] → [YES] → [OK].



To delete all movies at one time

In step 3, touch [HSD] DELETE ALL]/ [HSD] DELETE ALL] → [YES] → [YES] → [OK].

To delete all the movies recorded on the same day at one time

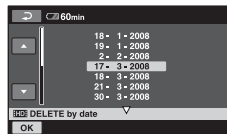
① In step 3, touch [HSD] DELETE by date]/ [HSD] DELETE by date].



② Touch  /  to select the recording date of the desired movie, then touch [OK].

The movies recorded on the selected date are displayed on the screen. Touch the movie on the LCD screen to confirm the movie. Touch  to return to the previous screen.

③ Touch [OK] → [YES] → [OK].

Notes

- If the deleted movie is included in the Playlist (p. 49), the movie added to the Playlist is deleted also from the Playlist.

Deleting still images

1 Touch **HOME** → **OTHERS** → **[DELETE]**.

2 Touch **[DELETE]**.

3 Touch **[DELETE]**.

4 Touch the still image to be deleted.

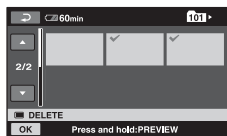

The selected still image is marked with ✓.

Press and hold the still image on the LCD screen to confirm the still image. Touch **[RETURN]** to return to the previous screen.

5 Touch **OK** → **[YES]** → **OK**.

To delete all still images at one time

In step 3, touch **[DELETE ALL]** → **[YES]** → **[YES]** → **OK**.

Capturing a still image from a movie (HDR-TG1E)

You can save a selected frame from a recorded movie as a still image. Select the image quality of the movies to be captured before the operation (p. 57).

1 Touch **HOME** → **OTHERS** → **[PHOTO CAPTURE]**.

The **[PHOTO CAPTURE]** screen appears.

2 Touch the movie to be captured.

The selected movie starts playback.

3 Touch **[PAUSE]** at the point where you want to capture.

The movie pauses.



4 Touch **OK**.

When capturing is finished, the screen returns to pause.

To continue capturing

Touch **[PAUSE]**, then follow the steps 3 to 4. To capture a still image from another movie, touch **[RETURN]** then follow the steps 2 to 4.

To finish capturing

Touch **[RETURN]** → **[X]**.

Dividing a movie

Notes

- The image size is fixed depending on the image quality of the movie:
 - [2.1M] with HD (high definition) image quality
 - [0.2M] in 16:9 (wide) with SD (standard definition) image quality
 - [VGA (0.3M)] in 4:3 with SD (standard definition) image quality
- The “Memory Stick PRO Duo” should have enough free space.
- The recording date and time of captured still images is the same as the recording date and time of the movies.
- If the movie you are capturing from has no data code, the recording date and time of the still image will be the date and time you captured from the movie.

Select the image quality of the movie you want to divide before the operation (p. 57).

1 Touch **HOME** → **OTHERS** → **[EDIT]**.

2 Touch **[DIVIDE]**.

3 Touch the movie to be divided.

The selected movie starts playback.

4 Touch **[]** at the point where you want to divide the movie into scenes.

The movie pauses.

Adjusts the dividing point with more precision after the dividing point has been selected with **[]**.

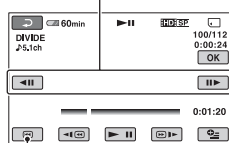

Returns to the beginning of the selected movie.

Play and pause toggles as you press **[]**.

5 Touch **[OK]** → **[YES]** → **[OK]**.

Notes

- You cannot restore movies once they are divided.

Creating the Playlist

- Do not remove the battery pack or the AC Adaptor, or eject the “Memory Stick PRO Duo” from your camcorder while dividing the movie. It may damage the “Memory Stick PRO Duo.”
- If you divide the original movie, the movie added to the Playlist will also be divided.
- A slight difference may occur from the point where you touch  and the actual dividing point, as your camcorder selects the dividing point based on about half-second increments.



The Playlist is a list showing thumbnails of the movies that you have selected.

The original movies are not changed even if you edit or delete the movies added to the Playlist.

Select the image quality of the movie you want to create, play, or edit a Playlist before the operation (p. 57).

Notes



- Images with HD (high definition) image quality and SD (standard definition) image quality are added to an individual Playlist.

1 Touch  (HOME) → 
(OTHERS) → [PLAYLIST EDIT].

2 Touch [] ADD] or [] ADD].

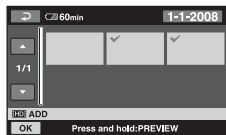
3 Touch the movie to be added to the Playlist.



The selected movie is marked with . Press and hold the movie on the LCD screen to confirm the movie. Touch  to return to the previous screen.

4 Touch [OK] → [YES] → [OK].

To add all the movies recorded on the same day at one time

- 1 In step 2, touch **[HD]** ADD by date/ **[SD]** ADD by date].
The recording dates of movies are displayed on the screen.

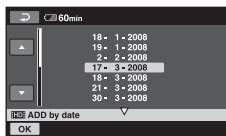

- 2 Touch **▲**/**▼** to select the recording date of the desired movie.
- 3 Touch **[OK]** while the selected recording date is highlighted.
The movies recorded on the selected date are displayed on the screen. Touch the image on the LCD screen to confirm the movie. Touch **[↶]** to return to the previous screen.
- 4 Touch **[OK]** → **[YES]** → **[OK]**.

⚡ Notes

- Do not remove the battery pack or the AC Adaptor, or eject the "Memory Stick PRO Duo" from your camcorder while editing the Playlist. It may damage the "Memory Stick PRO Duo."
- You cannot add still images to a Playlist.
- You cannot create a Playlist which contains both HD (high definition) image quality and SD (standard definition) image quality.

💡 Tips

- You can add a movie on the playback screen or the INDEX screen by touching **[OPTION]**.
- You can copy the Playlist to a disc as it is, by using the supplied software.
- You can add a maximum of 999 movies with HD (high definition) image quality, or 99 movies with SD (standard definition) image quality to the Playlist.

Playing the Playlist

Select the image quality of the movie you want to create, play, or edit a Playlist before the operation (p. 57).

- 1 Touch **▲** (HOME) → **[VIEW IMAGES]** → **[PLAYLIST]**.

The Playlist screen appears.

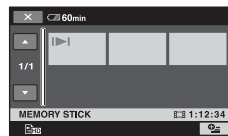

- 2 Touch the movie you want to playback.

The Playlist is played back from the selected movie to the end, then the screen returns to the Playlist screen.

To erase unnecessary movies from the Playlist

- 1 Touch **▲** (HOME) → **[OTHERS]** → **[PLAYLIST EDIT]**.
- 2 Touch **[HD ERASE]**/**[SD ERASE]**.
To erase all the images from the Playlist, touch **[HD ERASE ALL]**/**[SD ERASE ALL]** → **[YES]** → **[OK]**.
- 3 Select the movie to be erased from the Playlist.



The selected movie is marked with **✓**.

Press and hold the movie on the LCD screen to confirm the movie.





Touch  to return to the previous screen.

- ④ Touch  → [YES] → .

Tips

- The original scenes are not changed even if you erase the scenes from the Playlist.

To change the order within the Playlist

- ① Touch  (HOME) →  (OTHERS) → [PLAYLIST EDIT].
- ② Touch [ MOVE]/[ MOVE].
- ③ Select the movie to be moved.



The selected movie is marked with .

Press and hold the movie on the LCD screen to confirm the movie.

Touch  to return to the previous screen.

- ④ Touch .
- ⑤ Select the destination with  / .

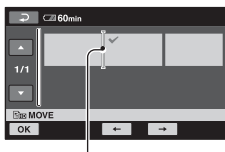

Destination bar

- ⑥ Touch  → [YES] → .

Tips

- When you select multiple movies, the movies are moved following the order appearing in the Playlist.

Dubbing to other devices

Connecting with the A/V connecting cable

You can dub images played back on your camcorder to other recording devices, such as VCRs or DVD/HDD recorders. Connect the device in either of the following ways.

Connect your camcorder to the wall outlet (wall socket) using the supplied AC Adaptor for this operation (p. 15). Refer also to the instruction manuals supplied with the devices to be connected.

Notes

- **Movies recorded with HD (high definition) image quality will be dubbed with SD (standard definition) image quality.**
- To copy a movie recorded with HD (high definition) image quality, install the application software (supplied) on your computer, and copy the images to a disc in the computer.
- Since dubbing is performed via analog data transfer, the image quality may deteriorate.

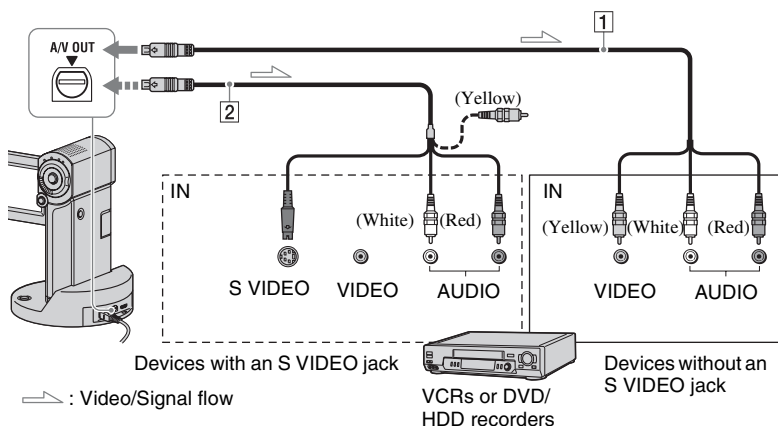



1 A/V connecting cable (supplied)

Your camcorder and the Handycam Station are equipped with A/V Remote Connector or A/V OUT jack (p. 100, 102). Connect the A/V connecting cable either to the Handycam Station or to your camcorder, depending on your setup.

2 A/V connecting cable with S VIDEO (optional)

When connecting to another device via the S VIDEO jack, by using an A/V connecting cable with an S VIDEO cable (optional), higher quality images can be produced than with an A/V connecting cable. Connect the white and red plug (left/right audio) and the S VIDEO plug (S VIDEO channel) of the A/V connecting cable with an S VIDEO cable (optional). The yellow plug connection is not necessary. S VIDEO connection only will not output audio.

Notes

- You cannot dub to recorders connected with an HDMI cable.
- To hide the screen indicators (such as a counter, etc.) on the screen of the monitor device connected, touch  (HOME) →  (SETTINGS) → [OUTPUT SETTINGS] → [DISP OUTPUT] → [LCD PANEL] (the default setting) on the HOME MENU (p. 70). To record the date/time and camera settings data, display them on the screen (p. 67).
- When you are connecting your camcorder to a monaural device, connect the yellow plug of the A/V connecting cable to the video input jack, and the red (right channel) or the white (left channel) plug to the audio input jack on the device.



1 Turn on your camcorder, and select the image quality of the images you want to dub (p. 57).

2 Touch  (VIEW IMAGES).

Set [TV TYPE] according to the display device (p. 69).

3 Insert the recording media in the recording device.

If your recording device has an input selector, set it to the input mode.

4 Connect your camcorder to the recording device (VCR or DVD/HDD recorder) with the A/V connecting cable (supplied)  or an A/V connecting cable with S VIDEO (optional) .

Connect your camcorder to the input jacks of the recording device.

5 Start the playback on your camcorder, and record it on the recording device.

Refer to the instruction manuals supplied with your recording device for details.

6 When dubbing is finished, stop the recording device, and then your camcorder.

Connecting with the USB cable

Connect your camcorder to a DVD writer, etc., compatible with movie dubbing via USB connection, to dub without image degradation.

Connect your camcorder to the wall outlet (wall socket) using the supplied AC Adaptor (p. 15). Refer also to the instruction manuals supplied with the device to be connected.

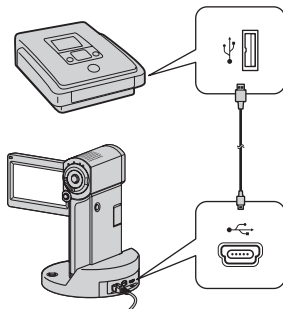

Notes

- Do not attempt the following operations while your camcorder is connected to other devices:
 - Close the LCD panel
 - Press POWER

1 Set the camcorder onto the Handycam Station or attach the Dedicated USB Terminal Adaptor to the camcorder securely, then turn on your camcorder.

2 Connect the ψ (USB) jack of the Handycam Station or the Dedicated USB Terminal Adaptor and a DVD writer, etc., with the supplied USB cable (p. 102).

[USB SELECT] appears on the screen.

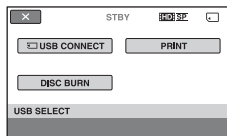

3 Touch [USB CONNECT].

4 Operate the device to be connected, and start recording.

For details, refer to the instruction manuals supplied with the device to be connected.



5 After dubbing is complete, touch [END] → [YES], then disconnect the USB cable.

Attention

This camcorder captures high definition footage in the AVCHD format. Using the enclosed PC software, high definition footage can be copied onto DVD media. However, DVD media containing AVCHD

footage should not be used with DVD based players or recorders, as the DVD player/recorder may fail to eject the media and may erase its contents without warning. DVD media containing AVCHD footage may be played on a compatible Blu-ray Disc™ player/recorder or other compatible device.

💡 Tips

- If the [USB SELECT] screen does not appear, touch  (HOME) →  (OTHERS) → [USB CONNECT].

Printing recorded images (PictBridge compliant printer)

You can print out still images using a PictBridge compliant printer, without connecting the camcorder to a computer.

PictBridge

Connect your camcorder to the AC Adaptor to obtain power from the wall outlet (wall socket) (p. 15). Turn on the printer. Insert the “Memory Stick PRO Duo” containing the still images you want to print into your camcorder.

1 Set the camcorder onto the Handycam Station or attach the Dedicated USB Terminal Adaptor to the camcorder securely, then turn on your camcorder.

2 Connect the Ψ (USB) jack of the Handycam Station or the Dedicated USB Terminal Adaptor to the printer using the USB cable (p. 102).

[USB SELECT] appears on the screen automatically.

3 Touch [PRINT].

When connection is complete,  (PictBridge connecting) appears on the screen.

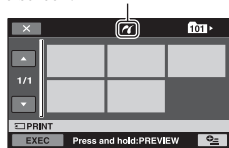

You can select a still image on the screen.

4 Touch the still image to be printed.

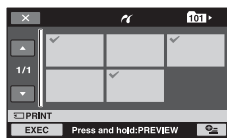

The selected still image is marked with .

Press and hold the still image on the LCD screen to confirm the still image.

Touch  to return to the previous screen.

5 Touch  (OPTION), set the following options, then touch .

[COPIES]: Set the number of copies of a still image to be printed. You can set up to 20 copies.

[DATE/TIME]: Select [DATE], [DAY&TIME], or [OFF] (no date/time printed).

[SIZE]: Select the paper size.

If you do not change the setting, go to step 6.

6 Touch [EXEC] → [YES] → .



The image selection screen appears again.

To finish printing

In step 3, touch  on the image selection screen.

Notes

- We can guarantee the operation of only models that are PictBridge compatible.

- Refer also to the instruction manual of the printer to be used.
- Do not attempt the following operations when  is on the screen. The operations may not be performed properly.
 - Close the LCD panel
 - Press POWER
 - Operate the  (Movie)/ (Still) select switch
 - Remove your camcorder from the Handycam Station or the Dedicated USB Terminal Adaptor
 - Disconnect the USB cable from your camcorder, the Handycam Station, the Dedicated USB Terminal Adaptor or the printer
- If the printer stops working, disconnect the USB cable, turn the printer off and on again, and restart the operation from the beginning.
- You can select only the paper sizes that the printer can print.
- On some printer models, the top, bottom, right, and left edges of images may be trimmed. If you print a still image recorded in a 16:9 (wide) ratio, the left and right ends of the image may be trimmed widely.
- Some printer models may not support the date printing function. Refer to your printer's instruction manual for details.
- The still images described below may not be printed out:
 - The still image edited by a computer
 - The still image recorded by other devices
 - The still image file exceeding 4 MB
 - The still image file larger than 3,680 × 2,760 pixels

Tips

- PictBridge is an industry standard established by the Camera & Imaging Products Association (CIPA). You can print still images without using a computer by connecting a printer directly to a digital video camera or digital still camera, regardless of model or manufacturer.
- You can print a still image on the still image playback screen from  (OPTION) MENU.

(MANAGE MEDIA) category

This category enables you to use the “Memory Stick PRO Duo” for various purposes.



(MANAGE MEDIA) category

Item list

HD/SD SET

You can select the image quality for movies (p. 57).

MEDIA INFO

You can display the “Memory Stick PRO Duo” information such as the recordable time, etc. (p. 58).

MEDIA FORMAT

You can format the “Memory Stick PRO Duo” and recover the recordable free space (p. 58).

REPAIR IMG.DB F.

You can repair the management information on the “Memory Stick PRO Duo” (p. 59).

Setting the image quality

You can select the image quality for recording/playback/editing on your camcorder.

In the default setting, the image quality is set to HD (high definition).

Tips

- You can perform recording/playback/editing operations for the selected image quality. When you want to change the image quality, select the image quality again.

1 Touch **HOME** → **(MANAGE MEDIA)** → **[HD/SD SET]**.

The image quality setting screen appears.

2 Touch the desired image quality.

[HD] indicates HD (high definition) image quality, and **[SD]** indicates SD (standard definition) image quality.

3 Touch **[YES]** → **[OK]**.

The image quality is changed.

Checking the “Memory Stick PRO Duo” information

You can check the remaining recordable time for each [REC MODE] (p. 62), and the approximate free and used space of the “Memory Stick PRO Duo.”

🔔 Notes

- During Easy Handycam operation, you cannot check the “Memory Stick PRO Duo” information. Cancel Easy Handycam operation (p. 22).

1 Turn the  (Movie) lamp on.

2 Touch  (HOME) → 
(MANAGE MEDIA) → [MEDIA INFO].

The remaining recordable time for each recording mode is displayed.

💡 Tips

- You can check the recordable free space, etc. by touching  at the lower right on the screen.

To turn off the display

Touch .

🔔 Notes

- The calculation for space available on a “Memory Stick PRO Duo” is $1\text{MB} = 1,048,576$ bytes. The fractions less than 1 MB are discarded when the “Memory Stick PRO Duo” space is displayed. Therefore, the displayed size of the total space available on a “Memory Stick PRO Duo,” both free and used, will be slightly smaller than the advertised size of the “Memory Stick PRO Duo.”
- Since there is a management file area, the used space is not displayed as 0 MB even if you perform [MEDIA FORMAT] (p. 58).

Deleting all images (Formatting)

Formatting deletes all the images to recover recordable free space.

To avoid the loss of important images, you should save them before formatting. Connect your camcorder to the wall outlet (wall socket) using the supplied AC Adaptor for this operation (p. 15).

1 Insert the “Memory Stick PRO Duo” to be formatted into your camcorder.

2 Turn on your camcorder.

3 Touch  (HOME) → 
(MANAGE MEDIA) → [MEDIA FORMAT].

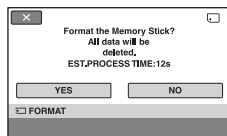



4 Touch [YES] → [YES].

5 When [Completed.] appears, touch .

🔔 Notes

- While the access lamp is lit, do not eject the “Memory Stick PRO Duo” from your camcorder.
- Even the still images protected with another device against accidental deletion are also deleted.

- Do not attempt the following operations when [Executing...] is on the screen:
 - Close the LCD panel
 - Operate the  (Movie)/ (Still) select switch or buttons
 - Eject the “Memory Stick PRO Duo”
- While [MEDIA FORMAT] is activated, do not disconnect the AC Adaptor.

Repairing the image database file

This function checks the management information and the consistency of movies/still images in the “Memory Stick PRO Duo,” and repairs any inconsistencies found.

- 1** Touch  (HOME) → 
(MANAGE MEDIA) → [REPAIR IMG.DB F.].

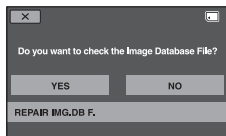

- 2** Touch [YES].

Your camcorder will check the management file.

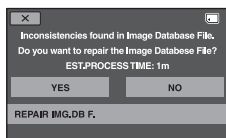

If no inconsistency was found, touch  to finish the operation.

- 3** Touch [YES].

- 4** After [Completed.] appears, touch .

Notes

- Do not apply mechanical shock or vibration to your camcorder, and do not remove the AC Adaptor or the battery pack, or eject “Memory Stick PRO Duo” from your camcorder during the operation.

What you can do with the (SETTINGS) category of the HOME MENU

You can change the recording functions and the operating settings for your convenience.

Using the HOME MENU

- 1 Open the LCD panel to turn on your camcorder, then touch  (HOME).

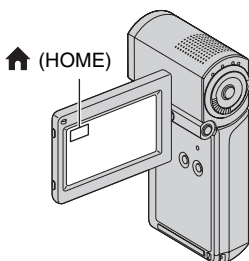

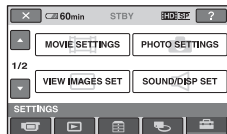

 (SETTINGS) category

- 2 Touch  (SETTINGS).



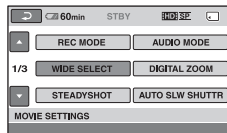

- 3 Touch the desired setup item.

If the item is not on the screen, touch / to change the page.



- 4 Touch the desired item.

If the item is not on the screen, touch / to change the page.

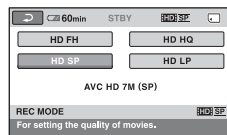

- 5 Change the setting, then touch .

List of the (SETTINGS) category items

MOVIE SETTINGS (p. 62)





| Items | Page |
|---|------|
| REC MODE | 62 |
| AUDIO MODE | 62 |
| WIDE SELECT | 62 |
| DIGITAL ZOOM | 63 |
| STEADYSHOT | 63 |
| AUTO SLW SHUTTR | 63 |
| X.V.COLOR | 63 |
| GUIDEFAME | 63 |
| ZEBRA | 63 |
|  REMAINING SET | 64 |
| SUB-T DATE | 64 |
| FLASH MODE* | 64 |
| FLASH LEVEL | 64 |
| REDEYE REDUC | 65 |
| FACE DETECTION | 65 |
|  INDEX SET* | 65 |

PHOTO SETTINGS (p. 66)

| Items | Page |
|---|------|
|  IMAGE SIZE* | 66 |
| FILE NO. | 66 |
| GUIDEFAME | 63 |
| ZEBRA | 63 |
| FLASH MODE* | 64 |
| FLASH LEVEL | 64 |
| REDEYE REDUC | 65 |
| FACE DETECTION | 65 |

VIEW IMAGES SET (p. 67)

| Items | Page |
|---|------|
| DATA CODE | 67 |
|  DISPLAY | 68 |

SOUND/DISP SET** (p. 68)

| Items | Page |
|---------------------|------|
| VOLUME* | 68 |
| BEEP* | 68 |
| LCD BRIGHT | 68 |
| LCD BL LEVEL | 69 |
| LCD COLOR | 69 |

OUTPUT SETTINGS (p. 69)

| Items | Page |
|--------------------|------|
| TV TYPE | 69 |
| DISP OUTPUT | 70 |
| COMPONENT | 70 |

CLOCK/ LANG (p. 70)

| Items | Page |
|--|------|
| CLOCK SET* | 19 |
| AREA SET | 70 |
| SUMMERTIME | 70 |
|  LANGUAGE SET* | 70 |

GENERAL SET (p. 71)

| Items | Page |
|----------------------|------|
| DEMO MODE | 71 |
| CALIBRATION | 96 |
| A.SHUT OFF | 71 |
| QUICK ON STBY | 71 |
| CTRL FOR HDMI | 71 |

* You can set these items also during Easy Handycam operation (p. 22).

** The menu name is changed to [SOUND SETTINGS] during Easy Handycam operation.

MOVIE SETTINGS

(Items for recording movies)



Touch ①, then ②.

If the item is not on the screen, touch to change the page.

How to set

(HOME MENU) → page 60

(OPTION MENU) → page 72

The default settings are marked with .

REC MODE



You can select a recording quality to record a movie.

■ For HD (high definition) image quality:

HD FH (FH)

Records in the highest quality mode.
(AVC HD 16M (FH))

HD HQ (HQ)

Records in high quality mode.
(AVC HD 9M (HQ))

▶ HD SP (SP)

Records in standard quality mode.
(AVC HD 7M (SP))

HD LP (LP)

Increases the recording time (Long Play).
(AVC HD 5M (LP))

■ For SD (standard definition) image quality:

SD HQ (HQ)

Records in high quality mode.
(SD 9M (HQ)).

▶ SD SP (SP)

Records in standard quality mode.
(SD 6M (SP)).

SD LP (LP)

Increases the recording time (Long Play).
(SD 3M (LP))

Notes

- If you record in the LP mode, the quality of movies may be degraded, or scenes with quick movements may appear with block noise when you play back the image.

Tips

- See page 10 on the expected recording time of each recording mode.

AUDIO MODE



You can change the recording sound format.

▶ 5.1ch SURROUND ()

Records sound in 5.1ch surround.

2ch STEREO ()

Records sound in 2ch stereo.

Notes

- appears temporarily regardless of the setting when you play back movies recorded on the setting; [RECORD SOUND] to [OFF] of [SMTH SLW REC].

WIDE SELECT



When recording with SD (standard definition) image quality, you can select the horizontal to vertical ratio according to the TV connected. Refer also to the instruction manuals supplied with your TV.

▶ 16:9 WIDE

Records images to the full screen on a 16:9 (wide) TV screen.

4:3 ()

Records images to the full screen on a 4:3 TV screen.

Notes

- Set [TV TYPE] correctly according to the TV connected for playback (p. 69).

DIGITAL ZOOM

You can select the maximum zoom level in case you want to zoom to a level greater than 10 × during recording. Note that the image quality decreases when you use the digital zoom.

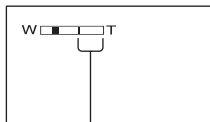

The right side of the bar shows the digital zooming factor. The zooming zone appears when you select the zooming level.

► OFF

Up to 10 × zoom is performed optically.

20 ×

Up to 10 × zoom is performed optically, and after that, up to 20 × zoom is performed digitally.

120 ×

Up to 10 × zoom is performed optically, and after that, up to 120 × zoom is performed digitally.

STEADYSHOT

You can compensate for camera shake (the default setting is [ON]). Set [STEADYSHOT] to [OFF] () when using a tripod (optional), then the image becomes natural.

AUTO SLW SHUTTR (Auto Slow Shutter)

When recording in dark places, the shutter speed is automatically reduced to 1/25 second (The default setting is [ON]).

X.V.COLOR

When recording, set to [ON] to capture wider range of colors. Various colors such as the brilliant color of flowers and turquoise blue of the sea can be more faithfully reproduced.

Notes

- Set [X.V.COLOR] to [ON] when the recorded content will be played back on an x.v.Color-compliant TV.
- If the movie recorded with this function [ON] is played back on a non-x.v.Color-compliant TV, the color may not be reproduced correctly.
- [X.V.COLOR] cannot be set to [ON]:
 - While recording with SD (standard definition) image quality
 - While recording a movie

GUIDEFAME

You can display the frame and check that the subject is horizontal or vertical by setting [GUIDEFAME] to [ON]. The frame is not recorded. Press DISP/BATT INFO to make the frame disappear (The default setting is [OFF]).

Tips

- Positioning the subject at the cross point of the guide frame makes a balanced composition.

ZEBRA

Diagonal stripes appear in portions of the screen where brightness is at a preset level. This is useful as a guide when adjusting the brightness. When you change the default setting,  is displayed. The zebra pattern is not recorded.

► OFF

The zebra pattern is not displayed.

70

The zebra pattern appears at a screen brightness level of about 70 IRE.

100

The zebra pattern appears at a screen brightness level of about 100 IRE or higher.

🔊 Notes

- Portions of the screen where brightness is about 100 IRE or above may appear overexposed.

💡 Tips

- IRE represents the unit of images brightness amplitude.

REMAINING SET





▶ ON

Always displays the remaining "Memory Stick PRO Duo" indicator.

AUTO

Displays the remaining recording time of movies for about 8 seconds in situations such as those described below.

- When your camcorder recognizes the remaining "Memory Stick PRO Duo" capacity while the  (Movie) lamp lights up
- When you press DISP/BATT INFO to switch the indicator from off to on while the  (Movie) lamp lights up
- When you select the movie recording mode on the HOME MENU.

🔊 Notes

- When the remaining recordable time for movies is less than 5 minutes, the indicator stays on the screen.

SUB-T DATE (Subtitle date)



When you set to [ON] (the default setting), you can display the recording date and time while playing back the images recorded on your camcorder, on devices compatible with the subtitle display function. Refer also to the instruction manual of the display device.

🔊 Notes

- The images recorded with HD (high definition) image quality can be played back only on AVCHD format compatible devices.
- [SUB-T DATE] cannot be set for SD (standard definition) image quality.

FLASH MODE



You can select the flash setting when you record still images with the built-in flash.

▶ AUTO

Automatically flashes when there is insufficient ambient light.

ON ()

Always uses the flash regardless of the surrounding brightness.

OFF ()

Records without flash.

🔊 Notes

- The recommended distance to the subject when using the built-in flash is approximately 0.3 to 1.5 m (1 to 5 feet).
- Remove any dust from the surface of the flash before using it. Flash effect may be impaired if heat discoloration or dust obscures the lamp.
- The  /CHG (charge) lamp flickers while charging the flash, and remains lit when the battery charge is complete.
- If you use the flash in bright places such as when shooting a backlit subject, the flash may not be effective.

FLASH LEVEL



You can set this function when you use the built-in flash.

HIGH()

Makes the flash level higher.

▶ NORMAL()

LOW()

Makes the flash level lower.

REDEYE REDUC



You can set this function when you record still images using the built-in flash. When you set [REDEYE REDUC] to [ON], then set [FLASH MODE] to [AUTO] or [ON], appears. You can prevent redden by activating the pre-flash before the flash flashes.

Notes

- The redden reduction may not produce the desired effect due to individual differences and other conditions.

FACE DETECTION



Detects faces and adjusts the focus, color and exposure automatically. Also, optimizes the face image.

▶ ON ()

Detects a face and shows a frame on it. The detected face image is optimized automatically.

Face detection frame

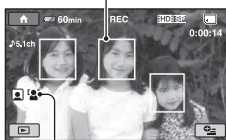

Face detection mark

ON[NO FRAMES] ()

Detects a face without showing a frame. The detected face image is optimized automatically.

OFF

Does not use [FACE DETECTION] function.

Notes

- Faces may not be detected depending on recording conditions.
- [FACE DETECTION] may not function properly depending on recording conditions. Set [FACE DETECTION] to [OFF] in this case.

INDEX SET



The default setting is [ON], allowing you to search for faces automatically and to display the [Face Index] screen (p. 34).

Face icons and their meanings

- : This icon appears when the setting is [ON].
- : This icon flashes when your camcorder detects a face. The icon stops flashing when the face is recorded in the [Face Index].
- : This icon appears when faces cannot be recorded in the [Face Index].*

* The number of faces that can be detected is limited.

PHOTO SETTINGS

(Items for recording still images)



Touch ①, then ②.

If the item is not on the screen, touch / to change the page.

How to set

(HOME MENU) → page 60

(OPTION MENU) → page 72

The default settings are marked with .

IMAGE SIZE



▶ 4.0M ()

Records still images clearly (2,304 × 1,728).

3.0M ()

Records still images clearly in the 16:9 (wide) ratio (2,304 × 1,296).

1.9M ()

Allows you to record more still images in relatively clear quality (1,600 × 1,200).

VGA (0.3M) ()

Allows the maximum number of still images to be recorded (640 × 480).

Notes

- The set image size is effective during the (Still) lamp turning on.

Capacity of the “Memory Stick PRO Duo” and the number of recordable images (Unit: number of images)*

When the (Still) lamp lights up:

| | |
|------|-------------------------|
| | 4.0M 2304 × 1728 |
| 1GB | 475 |
| 2GB | 970 |
| 4GB | 1900 |
| 8GB | 3850 |
| 16GB | 7700 |

* The number of recordable still images shown is for the maximum image size of your camcorder. The actual number of recordable still images is displayed on the LCD screen during recording (p. 103).

Notes

- When using a “Memory Stick PRO Duo” made by Sony Corporation. The number of recordable still images varies depending on the recording conditions or type of “Memory Stick.”
- The unique pixel array of Sony’s ClearVid CMOS sensor and image processing system (BIONZ) allows for still image resolution equivalent to the sizes described.

Tips

- You can also use a “Memory Stick Duo” with a capacity of under 1 GB for recording still images.

FILE NO.



▶ SERIES

Assigns file numbers in sequence even if the “Memory Stick PRO Duo” is replaced with another one. The file number is reset when a new folder is created or the recording folder is replaced with another.

RESET

Assigns file numbers in sequence, following the largest file number existing on the current recording “Memory Stick PRO Duo.”

GUIDEFAME

See page 63.

ZEBRA

See page 63.

FLASH MODE

See page 64.

FLASH LEVEL

See page 64.

REDEYE REDUC

See page 65.

FACE DETECTION

See page 65.

VIEW IMAGES SET

(Items to customize the display)



Touch ①, then ②.

If the item is not on the screen, touch /
 to change the page.

How to set

(HOME MENU) → page 60

(OPTION MENU) → page 72

The default settings are marked with ►.

DATA CODE



During playback, displays the information (data code) recorded automatically at the time of recording.

► OFF

Data code is not displayed.

DATE/TIME

Displays the date and time.

CAMERA DATA (below)

Displays camera setting data.

DATE/TIME

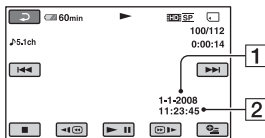

① Date

② Time

SOUND/DISP SET

(Items to adjust the sound and the screen)

CAMERA DATA

Movie

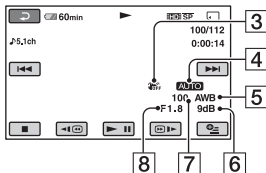

Still image

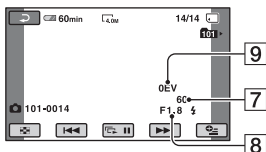

- 3 SteadyShot off
- 4 Brightness
- 5 White balance
- 6 Gain
- 7 Shutter speed
- 8 Aperture value
- 9 Exposure

💡 Tips

- appears for an image recorded using a flash.
- The data code is displayed on the TV screen if you connect your camcorder to a TV.
- Depending on the "Memory Stick PRO Duo" condition, bars [--:--:--] appear.

DISPLAY

You can select the number of thumbnails that appear on the VISUAL INDEX screen. Thumbnail Glossary (p. 105)

▶ ZOOM LINK

Change the number of thumbnails (6 or 12) with the power zoom lever on your camcorder.

6IMAGES

Displays thumbnails of 6 images.

12IMAGES

Displays thumbnails of 12 images.



Touch ①, then ②.

If the item is not on the screen, touch / to change the page.

How to set

(HOME MENU) → page 60

(OPTION MENU) → page 72

The default settings are marked with .

VOLUME



Touch / to adjust the volume (p. 33).

BEEP



▶ ON

A melody sounds when you start/stop recording, or operate the touch panel.

OFF

Cancels the melody.

LCD BRIGHT



You can adjust the brightness of the LCD screen with / .

① Adjust the brightness with / .

② Touch .

💡 Tips

- This adjustment does not affect the recorded images in any way.

LCD BL LEVEL



You can adjust the brightness of the LCD screen's backlight.

► **NORMAL**

Standard brightness.

BRIGHT

Brightens the LCD screen.

Notes

- When you connect your camcorder to outside power sources, [BRIGHT] is automatically selected for the setting.
- When you select [BRIGHT], battery life is slightly reduced during recording.
- If you open the LCD panel 180 degrees to face the screen outside and close the LCD panel to the camcorder body, the setting becomes [NORMAL] automatically.

Tips

- This adjustment does not affect the recorded images in any way.

LCD COLOR



You can adjust the color of the LCD screen with / .



Low intensity High intensity

Tips

- This adjustment does not affect the recorded images in any way.

OUTPUT SETTINGS

(Items for when connecting other devices)

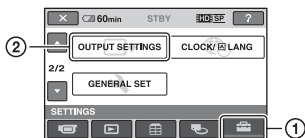

Touch ①, then ②.

If the item is not on the screen, touch / to change the page.

How to set

(HOME MENU) → page 60

(OPTION MENU) → page 72

The default settings are marked with ►.

TV TYPE



You need to convert the signal depending on the TV connected when playing back the image. The recorded images are played back as following illustrations.

► **16:9**

Select this to view your images on a 16:9 (wide) TV.

16:9 (wide) images



4:3 images

**4:3**

Select this to view your images on a 4:3 standard TV.

16:9 (wide) images



4:3 images

 **Notes**

- Horizontal to vertical ratio of the image recorded with HD (high definition) image quality is 16:9.

DISP OUTPUT

▶ LCD PANEL

Shows displays such as the time code on the LCD screen.

V-OUT/PANEL

Shows displays such as the time code on the TV screen and the LCD screen.

Notes

- The setting of [DISP OUTPUT] may be changed according to the setting of [CTRL FOR HDMI] (p. 71).

COMPONENT

Select [COMPONENT] when connecting your camcorder to a TV with the component input jack.

576i

Select when connecting your camcorder to a TV with the component input jack.

▶ 1080i/576i

Select when connecting your camcorder to a TV that has the component input jack and is capable of displaying the 1080i signal.

CLOCK/ LANG

(Items to set clock and language)



Touch ①, then ②.

If the item is not on the screen, touch  to change the page.

How to set

 (HOME MENU) → page 60

 (OPTION MENU) → page 72

CLOCK SET

See page 19.

AREA SET

You can adjust a time difference without stopping the clock.

Set your local area using  when using your camcorder in other time zones.

Refer to the world time difference on page 90.

SUMMERTIME

You can change this setting without stopping the clock.

Set to [ON] to move the time forward 1 hour.

LANGUAGE SET

You can select the language to be used on the LCD screen.

Tips

- Your camcorder offers [ENG[SIMP]] (simplified English) for when you cannot find your native tongue among the options.

GENERAL SET

(Other setup items)

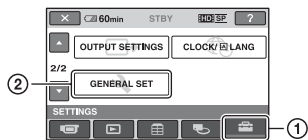

Touch ①, then ②.

If the item is not on the screen, touch / to change the page.

How to set

(HOME MENU) → page 60

(OPTION MENU) → page 72

The default settings are marked with .

DEMO MODE

The default setting is [ON], allowing you to view the demonstration in about 10 minutes, after you turn on the (Movie) lamp.

Tips

- The demonstration will be suspended in situations such as those described below.
 - When you press START/STOP or PHOTO.
 - When you touch the screen during the demonstration (The demonstration starts again after about 10 minutes).
 - When you turn on the (Still) lamp.

CALIBRATION

See page 96.

A.SHUT OFF (Auto shut off)

5 min

The camcorder is automatically turned off when you do not operate your camcorder for more than approximately 5 minutes.

NEVER

The camcorder is not automatically turned off.

Notes

- When you connect your camcorder to a wall outlet (wall socket), [A.SHUT OFF] is automatically set to [NEVER].

QUICK ON STBY (Quick on standby)

You can set the time that you want the camcorder to remain on before turning off in sleep mode (p. 29) from [OFF], [5 min] (the default setting), [10 min] and [15 min].

Notes

- [A.SHUT OFF] does not work during sleep mode.

Tips

- When you set to [OFF], you can save battery power by not using the QUICK ON function.

CTRL FOR HDMI (Control for HDMI)

The default setting is [ON], allowing you to do the playback operation with the remote commander of your TV by connecting your camcorder to a “BRAVIA” Sync compatible TV with the HDMI cable (p. 42).

Activating functions using the OPTION MENU

The  OPTION MENU appears just like the pop-up window that appears when you right-click the mouse on a computer. Various available functions are displayed.

Using the OPTION MENU

- 1 While using your camcorder, touch  (OPTION) on the screen.

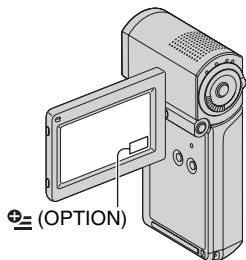

Tab

- 2 Touch the desired item.

If you cannot find the desired item, touch another tab to change the page.

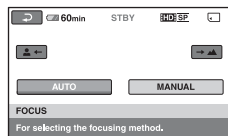





If you cannot find the item anywhere, the function does not work under the current situation.

- 3 Change the setting, then touch .

Notes











- The tabs and items that appear on the screen depend on the recording/playback status of your camcorder at the time.
- Some items appear without a tab.
- The  OPTION MENU cannot be used during Easy Handycam operation.

Recording items on the OPTION MENU

| Items |  * | Page |
|---|---|------|
|  tab | | |
| FOCUS | – | 74 |
| SPOT FOCUS | – | 74 |
| TELE MACRO | – | 74 |
| EXPOSURE | – | 75 |
| SPOT METER | – | 75 |
| SCENE SELECTION | – | 75 |
| WHITE BAL. | – | 76 |
| COLOR SLOW SHTR | – | 77 |
| | | |
|  tab | | |
| FADER | – | 77 |
| D.EFFECT | – | 77 |
| PICT.EFFECT | – | 77 |
| | | |
|  tab | | |
| REC MODE | ○ | 62 |
| BLT-IN ZOOM MIC | – | 78 |
| MICREF LEVEL | – | 78 |
|  IMAGE SIZE | ○ | 66 |
| SELF-TIMER | – | 78 |
| FLASH MODE | ○ | 64 |
| TIMING | – | 30 |
| RECORD SOUND | – | 30 |

* Items that are included also in the HOME MENU.

Viewing items on the OPTION MENU

| Items |  * | Page |
|--|---|------|
|  tab | | |
| DELETE | ○ | 46 |
| DELETE by date | ○ | 46 |
| DELETE ALL | ○ | 46 |
| | | |
|  tab | | |
| DIVIDE | ○ | 48 |
| ERASE ALL | ○ | 50 |
| MOVE | ○ | 51 |
| | | |
| -- (The tab depends on the situation/No tab) | | |
|  ADD** | ○ | 49 |
|  ADD** | ○ | 49 |
|  ADD by date** | ○ | 50 |
|  ADD by date** | ○ | 50 |
| PRINT | ○ | 55 |
| SLIDE SHOW | – | 36 |
| VOLUME | ○ | 68 |
| DATA CODE | ○ | 67 |
| SLIDE SHOW SET | – | 36 |
|  ADD | ○ | 49 |
|  ADD | ○ | 49 |
|  ADD by date | ○ | 50 |
|  ADD by date | ○ | 50 |
| COPIES | – | 55 |
| DATE/TIME | – | 55 |
| SIZE | – | 55 |
| ERASE | ○ | 50 |

* Items that are included also in the HOME MENU.

** Items that are included in the HOME MENU by a different name.

Functions set in the OPTION MENU





Items you can set only on the  OPTION MENU will be described below.

The default settings are marked with .

FOCUS

You can adjust the focus manually. You can select this function also when you want to focus on a certain subject intentionally.



- 1 Touch [MANUAL].
 appears.
- 2 Touch  (focusing on close subjects)/
 (focusing on distant subjects) to sharpen the focus.  appears when the focus cannot be adjusted any closer, and  appears when the focus cannot be adjusted farther away.
- 3 Touch [OK].

To adjust the focus automatically, touch [AUTO] → [OK] in step 1.

Notes

- The minimum possible distance between camcorder and subject while maintaining sharp focus is about 1 cm (about 13/32 in.) for wide angle and about 80 cm (about 2 5/8 feet) for telephoto.

Tips

- It is easier to focus on the subject by moving the power zoom lever towards T (telephoto) to adjust the focus, then towards W (wide angle) to adjust the zoom for recording. When you want to record a subject at close range, move the power zoom lever to W (wide angle), then adjust the focus.
- The focal distance information (distance at which the subject is focused on, if it is dark and focus adjustment is difficult) appears for a few seconds in the following cases.
 - when the focus mode is switched from automatic to manual
 - when you set focus manually

SPOT FOCUS

You can select and adjust the focal point to aim it at a subject not located at the center of the screen.

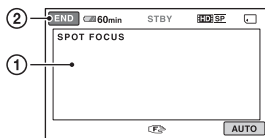

- 1 Touch the subject on the screen.
 appears.
- 2 Touch [END].

To adjust the focus automatically, touch [AUTO] → [END] in step 1.

Notes

- If you set [SPOT FOCUS], [FOCUS] is automatically set to [MANUAL].

TELE MACRO

This is useful to shoot small subjects, such as flowers or insects. You can blur out backgrounds and the subject stands out clearer.

When you set [TELE MACRO] to [ON] () , the zoom (p. 28) moves to the top of the T (telephoto) side automatically and allows recording subjects at a close distance as down to about 36 cm (14 1/4 in.).



To cancel, touch [OFF], or zoom to wide-angle (W side).

Notes

- When recording a distant subject, focusing may be difficult and can take some time.
- Adjust the focus manually ([FOCUS], p. 74) when it is hard to focus automatically.

EXPOSURE



You can fix the brightness of a picture manually. Adjust the brightness when the subject is too bright or too dark.

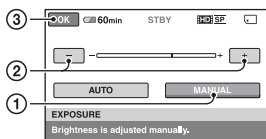

- 1 Touch [MANUAL].
————— appears.
- 2 Adjust the exposure by touching [—]/
[+].
- 3 Touch [OK].

To return the setting to automatic exposure, touch [AUTO] → [OK] in step ①.

SPOT METER (Flexible spot meter)



You can adjust and fix the exposure to the subject, so that it is recorded in suitable brightness even when there is strong contrast between the subject and the background, such as subjects in the spotlight on stage.

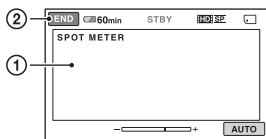

- 1 Touch the point where you want to fix and adjust the exposure on the screen.
————— appears.
- 2 Touch [END].

To return the setting to automatic exposure, touch [AUTO] → [END] in step ①.

Notes

- If you set [SPOT METER], [EXPOSURE] is automatically set to [MANUAL].

SCENE SELECTION



You can record images effectively in various situations.

▶ AUTO

Select to automatically record images effectively without the [SCENE SELECTION] function.

TWILIGHT* (☾)

Select to maintain the darkening atmosphere of the distant surroundings in twilight scenes.



TWILIGHT PORT. (👤)

Select to take subject in foreground against night view.



CANDLE (🕯)

Select to maintain the dim atmosphere of a candlelit scene.



SUNRISE&SUNSET* (🌅)

Select to reproduce the atmosphere of scenes such as sunsets or sunrises.



FIREWORKS* (💣)

Select to take spectacular shots of fireworks.



LANDSCAPE* (🏞️)

Select to shoot distant subjects clearly. This setting also prevents your camcorder from focusing on glass or metal mesh in windows that comes in between the camcorder and the subject.



PORTRAIT (Soft portrait) (👤)

Select to bring out the subject such as people or flowers while creating a soft background.



SPOTLIGHT** (🎤)

Select to prevent people's faces from appearing excessively white when subjects are lit by strong light.



BEACH** (🏖️)

Select to take the vivid blue of the ocean or a lake.



SNOW** (❄️)

Select to take bright pictures of a white landscape.



* Adjusted to focus on subjects farther away only.

** Adjusted not to focus on subjects a short distance away.

🔊 Notes

- Even if you set [TWILIGHT PORT.] while the 📷 (Still) lamp is lit, the setting changes to [AUTO] once the 🎬 (Movie) lamp lights up.

- If you set [SCENE SELECTION], [WHITE BAL.] setting is canceled.

WHITE BAL. (White balance)



You can adjust the color balance to the recording environment.

▶ AUTO

The white balance is adjusted automatically.

OUTDOOR (☀️)

The white balance is adjusted to be appropriate for the following recording conditions:

- Outdoors
- Night views, neon signs and fireworks
- Sunrise or sunset
- Under daylight fluorescent lamps

INDOOR (💡)

The white balance is adjusted to be appropriate for the following recording conditions:



- Indoors
- At party scenes or studios where the lighting conditions change quickly
- Under video lamps in a studio, or under sodium lamps or incandescent-like color lamps

ONE PUSH (📷)

The white balance will be adjusted according to the ambient light.

- ① Touch [ONE PUSH].
- ② Frame a white object such as a piece of paper, to fill the screen under the same lighting conditions as you will shoot the subject.
- ③ Touch [📷].
📷 flashes quickly. When the white balance has been adjusted and stored in the memory, the indicator stops flashing.

Notes

- Set [WHITE BAL.] to [AUTO] or adjust the color in [ONE PUSH] under white or cool white fluorescent lamps.
- When you select [ONE PUSH], keep framing white objects while  is flashing quickly.
-  flashes slowly if [ONE PUSH] could not be set.
- When [ONE PUSH] was selected, if  keeps flashing after touching [OK], set [WHITE BAL.] to [AUTO].
- If you set [WHITE BAL.], [SCENE SELECTION] is set to [AUTO].

Tips

- If you have changed the battery pack while [AUTO] was selected, or bring your camcorder outdoors from inside the house, or vice versa, select [AUTO] and aim your camcorder at a nearby white object for about 10 seconds for better color balance adjustment.
- When the white balance has been set with [ONE PUSH], if you change the [SCENE SELECTION] settings, or bring your camcorder outdoors from inside the house, or vice versa, you need to redo the [ONE PUSH] procedure to readjust the white balance.

COLOR SLOW SHTR (Color Slow Shutter)



When you set [COLOR SLOW SHTR] to [ON],  appears, and you can record an image brighter in color even in dark places. To cancel, touch [OFF].

Notes

- Adjust the focus manually ([FOCUS], p. 74) when it is hard to focus automatically.
- The shutter speed of your camcorder changes depending on the brightness, which may result in a slowdown of the motion of the image.

FADER



You can record a transition with the following effects added to the interval between scenes.

① Select the desired effect in [STBY] (to fading in) or [REC] (to fading out) mode, then touch [OK].

② Press START/STOP.

The fader indicator stops flashing and disappears when the fade is complete.

To cancel the fader before starting the operation, touch [OFF] in step ①. If you press START/STOP, the setting is canceled.



WHITE FADER



BLACK FADER



D.EFFECT (Digital effect)



When you select [OLD MOVIE],  appears and you can add an old movie effect to images. To cancel [D.EFFECT], touch [OFF].

PICT.EFFECT (Picture effect)



You can add special effects to an image during recording.  appears.

► OFF

Does not use [PICT.EFFECT] setting.

SEPIA

Images appear in sepia.

B&W (Black and white)

Images appear in black and white.

PASTEL



Images appear as a pale pastel drawing.

BLT-IN ZOOM MIC (Built-in zoom microphone)



When you set [BLT-IN ZOOM MIC] to [ON] (), you can record a movie with directional sound as you move the power zoom lever (The default setting is [OFF]).

MICREF LEVEL (Microphone reference level)



You can select the microphone level for recording sound.
Select [LOW] when you want to record exciting and powerful sound in a concert hall, etc.

► NORMAL

Records surrounding sounds, converting them into the appropriate level.

LOW ()

Records surrounding sounds faithfully.
This setting is not suitable for recording conversations.

SELF-TIMER



 appears when [SELF-TIMER] is set to [ON].

Press PHOTO to start the count down. A still image is recorded after about 10 seconds.

To cancel the recording, touch [RESET].
To cancel the self-timer, select [OFF].

Troubleshooting

If you run into any problems using your camcorder, use the following table to troubleshoot the problem. If the problem persists, disconnect the power source and contact your Sony dealer.

| | |
|--|----|
| • Overall operations/Easy Handycam operation..... | 79 |
| • Batteries/Power sources | 80 |
| • LCD screen..... | 80 |
| • “Memory Stick PRO Duo”..... | 81 |
| • Recording | 81 |
| • Playing back images | 83 |
| • Editing images on your camcorder | 83 |
| • Viewing on the TV..... | 84 |
| • Playing the “Memory Stick PRO Duo” on other devices..... | 84 |
| • Dubbing/Connecting to other devices... .. | 84 |
| • Functions that cannot be used simultaneously..... | 84 |

Overall operations/Easy Handycam operation

The power does not turn on.

- Insert a charged battery pack into the camcorder (p. 15).
- The plug of the AC Adaptor has been disconnected from the wall outlet (wall socket). Connect it to the wall outlet (wall socket) (p. 15).
- Set the camcorder onto the Handycam Station securely (p. 15).

The camcorder does not operate even when the power is set to on.

- It takes a few seconds for your camcorder to be ready to shoot after the power is turned on. This is not a malfunction.
- Disconnect the AC Adaptor from the wall outlet (wall socket) or remove the battery pack, then reconnect it after about 1 minute. If the functions still do not work, press the RESET button (p. 99) using a pointed object (If you press the RESET button, all settings, including the clock setting, are reset).

Buttons do not work.

- During Easy Handycam operation (p. 22), the following buttons/functions are not available.
 - Playback zoom (p. 35)
 - To turn on and off the LCD backlight (Pressing and holding the DISP/BATT INFO button for a few seconds) (p. 19)

(OPTION) is not displayed.





- The OPTION MENU cannot be used during Easy Handycam operation.

The menu settings have changed automatically.

- During Easy Handycam operation, nearly all the menu items will be automatically set to the default settings.
- During Easy Handycam operation, some menu items are fixed as follows.
 - [REC MODE]: [HD SP]/[SD SP]
 - [DATA CODE]: [DATE/TIME]
- The following menu items return to the default settings when you turn off your camcorder for more than 12 hours.
 - [FLASH MODE]
 - [FOCUS]
 - [SPOT FOCUS]
 - [EXPOSURE]
 - [SPOT METER]
 - [SCENE SELECTION]
 - [WHITE BAL.]
 - [COLOR SLOW SHTR]
 - [BLT-IN ZOOM MIC]
 - [MICREF LEVEL]

Even if you press EASY, menu settings do not switch to their defaults automatically.

- During Easy Handycam operation, settings for the following menu items are maintained the ones before Easy Handycam operation.
 - [] SET
 - [AUDIO MODE]
 - [WIDE SELECT]
 - [X.V.COLOR]
 - [SUB-T DATE]

- [FLASH MODE]
- [ INDEX SET]
- [ IMAGE SIZE]
- [FILE NO.]
- [ DISPLAY]
- [VOLUME]
- [BEEP]
- [TV TYPE]
- [COMPONENT]
- [CLOCK SET]
- [AREA SET]
- [SUMMERTIME]
- [ LANGUAGE SET]
- [DEMO MODE]
- [CTRL FOR HDMI]

Your camcorder gets warm.

- This is because the power has been turned on for a long time. This is not a malfunction.

Batteries/Power sources

The power abruptly turns off.

- When approximately 5 minutes have elapsed while you do not operate your camcorder, the camcorder is automatically turned off (A.SHUT OFF). Change the setting of [A.SHUT OFF] (p. 71), or turn on the power again, or use the AC Adaptor.
- When the time selected in [QUICK ON STBY] has elapsed during sleep mode, the camcorder is automatically turned off (p. 71). Turn on the power again.
- Charge the battery pack (p. 15).

The ζ /CHG (charge) lamp does not light while the battery pack is being charged.

- Turn off your camcorder (p. 15).
- Insert the battery pack into the camcorder correctly (p. 15).
- Connect the power cord (mains lead) to the wall outlet (wall socket) properly.
- The battery charge is completed (p. 15).
- Set the camcorder onto the Handycam Station securely (p. 15).

The ζ /CHG (charge) lamp flashes while the battery pack is being charged.

- Insert the battery pack into the camcorder correctly (p. 15). If the problem persists, disconnect the AC Adaptor from the wall outlet (wall socket) and contact your Sony dealer. The battery pack may be damaged.

The remaining battery time indicator does not indicate the correct time.

- The ambient temperature is too high or too low. This is not a malfunction.
- The battery pack has not been charged enough. Fully charge the battery again. If the problem persists, replace the battery pack with a new one (p. 15).
- The indicated time may not be correct depending on the environment of use.

The battery pack is quickly discharged.

- The ambient temperature is too high or low. This is not a malfunction.
- Fully charge the battery again. If the problem persists, replace the battery pack with a new one (p. 15).

LCD screen

Menu items are grayed out.

- You cannot select grayed items in the current recording/playback situation.
- There are some functions you cannot activate simultaneously (p. 84).

The buttons do not appear on the touch panel.

- Touch the LCD screen lightly.
- Press DISP/BATT INFO (p. 18).

The buttons on the touch panel do not work correctly or do not work at all.

- Adjust the touch panel ([CALIBRATION], p. 96).

“Memory Stick PRO Duo”

You cannot operate functions using the “Memory Stick PRO Duo.”

- If you use a “Memory Stick PRO Duo” formatted on a computer, format it again on your camcorder (p. 58).

You cannot delete images stored on or format the “Memory Stick PRO Duo.”

- The maximum number of images that you can delete at one time is 100.
- You cannot delete the images protected on another device.





The data file name is not indicated correctly or flashes.

- The file is damaged.
- The file format is not supported by your camcorder (p. 92).

Recording

Refer also to “Memory Stick PRO Duo” (p. 81).

Pressing START/STOP or PHOTO does not record images.

- The playback screen is displayed. Slide the  (Movie)/ (Still) select switch to turn on the  (Movie) lamp or  (Still) lamp (p. 27).
- You cannot record images in sleep mode. Open the LCD panel (p. 29).
- Your camcorder is recording the image you have just shot on the “Memory Stick PRO Duo.” You cannot make new recording during this period.

- The “Memory Stick PRO Duo” is full. Use a new “Memory Stick PRO Duo” or format the “Memory Stick PRO Duo” (p. 58). Or delete the unnecessary images (p. 46).
- Total number of movie scenes or still images exceeds the recordable capacity of your camcorder (p. 10). Delete unnecessary images (p. 46).
- Moisture condensation has occurred. Turn off your camcorder and leave it for about 1 hour in a cool place (p. 95).

You cannot record a still image.

- You cannot record a still image together with:
 - [SMTH SLW REC]
 - [FADER]
 - [D.EFFECT]
 - [PICT.EFFECT]

The access lamp remains lit or flashing even when you stop recording.

- Your camcorder is recording the scene you have just shot on the “Memory Stick PRO Duo.”

The recording angle looks different.

- The recording angle may look different depending on the condition of your camcorder. This is not a malfunction.

The flash does not work.

- You cannot record with the flash when capturing still images while shooting a movie.
- Even if auto flash or  (Auto redefy reduction) is selected, you cannot use the internal flash with:
 - [TWILIGHT], [CANDLE], [SUNRISE&SUNSET], [FIREWORKS], [LANDSCAPE], [SPOTLIGHT], [BEACH] or [SNOW] in [SCENE SELECTION]
 - [MANUAL] in [EXPOSURE]
 - [SPOT METER]

The actual recording time for movie is less than the expected approximate recording time of the "Memory Stick PRO Duo."

- Depending on the recording conditions, the time available for recording may be shorter, for example when recording a fast moving object, etc. (p. 10, 64).

There is a time difference between the point where you press START/STOP and the point that the recorded movie starts/stops.

- On your camcorder, there may be a slight time difference between the point where you press START/STOP and the actual point that recording movie starts/stops. This is not a malfunction.

The horizontal to vertical ratio (16:9 (wide)/4:3) cannot be changed.

- The horizontal to vertical ratio of the movie recorded with HD (high definition) image quality is 16:9 (wide).

The auto focus does not function.

- Set [FOCUS] to [AUTO] (p. 74).
- The recording conditions are not suitable for auto focus. Adjust the focus manually (p. 74).

[STEADYSHOT] does not function.

- Set [STEADYSHOT] to [ON] (p. 63).
- [STEADYSHOT] may not be able to compensate for excessive vibrations.

The subjects passing by the lens very fast appear crooked.

- This is called the focal plane phenomenon. This is not a malfunction. Because of the way the image device (CMOS sensor) reads out image signals, the subjects passing by the lens rapidly might appear crooked depending on the recording conditions.

Tiny spots in white, red, blue, or green appear on the screen.

- The spots appear when you are recording with [COLOR SLOW SHTR]. This is not a malfunction.

The screen image is dark, and the subject does not appear on the screen.

- Press and hold DISP/BATT INFO for a few seconds to turn on the backlight (p. 19).

Horizontal stripes appear on the images.

- This occurs when recording images under a fluorescent lamp, sodium lamp, or mercury lamp. This is not a malfunction.

Black bands appear when you record a TV screen or computer screen.

- Set [STEADYSHOT] to [OFF] (p. 63).

[COLOR SLOW SHTR] does not operate correctly.



- [COLOR SLOW SHTR] may not operate correctly in total darkness.

You cannot adjust [LCD BL LEVEL].

- You cannot adjust [LCD BL LEVEL] when:
 - The LCD panel is closed on your camcorder with the LCD screen facing out.
 - The power is supplied from the AC Adaptor.

Playing back images

An image cannot be found for playback.

- Select the image quality of a movie you want to play back by touching  (HOME) →  (MANAGE MEDIA) → [HDMI/HSD] SET] (p. 57).

Images cannot be played back.

- Images cannot be played back if you have modified files or folders, or have edited the data on a computer. (The file name flashes in the case of still images.) This is not a malfunction (p. 93).
- Images recorded on other devices may not be played back. This is not a malfunction (p. 93).

“?” is indicated on an image in the VISUAL INDEX screen.

- This may appear on still images recorded on other devices, edited on a computer, etc.
- You removed the AC Adaptor or the battery pack before the access lamp is turned off after recording. This may damage your image data and  is displayed.

“” is indicated on an image in the VISUAL INDEX screen.

- Perform [REPAIR IMG.DB F.] (p. 59). If it still appears, delete the image marked with  (p. 46).

No sound or only a quiet sound is heard during playback.

- Turn up the volume (p. 33).
- When you record sound with [MICREF LEVEL] (p. 78) set to [LOW], the recorded sound may be difficult to hear.
- When using [SMTH SLW REC], set [RECORD SOUND] to [ON] (p. 30).

Left and right sound will be heard unbalanced when playing back on computers or other devices.

- This happens when sound recorded in 5.1ch surround is converted to 2ch (normal stereo sound) by a computer or other device (p. 28). This is not a malfunction.
- Change the sound conversion type (downmix type) when playing back on 2ch stereo devices. Refer to the instruction manual supplied with your playback device for details.
- Change the sound to 2ch when creating a disc using the supplied software “Picture Motion Browser.”
- Record sound with [AUDIO MODE] set to [2ch STEREO] (p. 62).

Editing images on your camcorder

Unable to edit.

- Unable to edit because of the condition of the image.

Images cannot be added in the Playlist.

- There is no free space in the “Memory Stick PRO Duo.”
- You can add no more than 999 images with HD (high definition) image quality, or 99 images with SD (standard definition) image quality, to a Playlist. Erase unnecessary images from the Playlist (p. 50).
- You cannot add still images in the Playlist.

A movie cannot be divided.

- A movie that is too short cannot be divided.
- A movie protected on another device cannot be divided.

Still images cannot be captured from a movie (HDR-TG1E).

- There is no space on the “Memory Stick PRO Duo” to record a still image.

Viewing on the TV

You cannot view the image or hear the sound on the TV.

- When you are using the component A/V cable, set [COMPONENT] according to the requirements of the connected device (p. 70).
- When you are using the component video plug, make sure the red and white plugs of the A/V connecting cable are connected (p. 39, 41).
- Images are not output from the HDMI OUT jack, if copyright protection signals are recorded in the images.
- When you are using the S VIDEO plug, make sure the red and white plugs of the A/V connecting cable are connected (p. 41).

The image appears distorted on the 4:3 TV.

- This happens when viewing an image recorded in the 16:9 (wide) mode on a 4:3 TV. Set [TV TYPE] correctly (p. 69) and play back the image.

Black bands appear at the top and bottom of the screen of the 4:3 TV.

- This happens when viewing an image recorded in the 16:9 (wide) mode on a 4:3 TV. This is not a malfunction.

Playing the “Memory Stick PRO Duo” on other devices

The device does not play or read the “Memory Stick PRO Duo.”

- You can play back the images with HD (high definition) image quality only on devices that comply with AVCHD-format.

Dubbing/Connecting to other devices

You cannot dub correctly.

- You cannot dub images using an HDMI cable.
- The A/V connecting cable is not connected properly. Make sure to connect to the input jack of another device (p. 52).

Functions that cannot be used simultaneously

The following list shows examples of unworkable combinations of functions and menu items.

| Cannot use | Because of following settings |
|----------------------------|---|
| [SCENE SELECTION] | [COLOR SLOW SHTR], [FADER], [OLD MOVIE], [TELE MACRO] |
| [ONE PUSH] in [WHITE BAL.] | [SMTH SLW REC] |
| [SPOT FOCUS] | [SCENE SELECTION] |
| [COLOR SLOW SHTR] | [FADER], [D.EFFECT], [SCENE SELECTION] |
| [FADER] | [COLOR SLOW SHTR], [D.EFFECT], [CANDLE], [FIREWORKS] |
| [D.EFFECT] | [COLOR SLOW SHTR], [FADER], [SCENE SELECTION], [PICT.EFFECT] |
| [PICT.EFFECT] | [OLD MOVIE] |
| [STEADYSHOT] | [SMTH SLW REC] |
| [TELE MACRO] | [SCENE SELECTION] |
| [AUTO SLW SHUTTR] | [SMTH SLW REC], [D.EFFECT], [SCENE SELECTION], [COLOR SLOW SHTR], [FADER] |

| Cannot use | Because of following settings |
|------------------|--|
| [WIDE SELECT] | [OLD MOVIE] |
| [FACE DETECTION] | [SMTH SLW REC], [FOCUS], [SPOT FOCUS], [EXPOSURE], [SPOT METER], [COLOR SLOW SHTR], [D.EFFECT], [PICT.EFFECT], [WHITE BAL.], [DIGITAL ZOOM], [TWILIGHT]/ [TWILIGHT PORT.]/ [CANDLE]/ [SUNRISE&SUNSET]/ [FIREWORKS]/ [LANDSCAPE]/ [SPOTLIGHT]/ [BEACH]/[SNOW] in [SCENE SELECTION] |
| [MICREF LEVEL] | [BLT-IN ZOOM MIC] |
| [DISP OUTPUT] | [CTRL FOR HDMI] |

Warning indicators and messages

Self-diagnosis display/Warning indicators

If indicators appear on the LCD screen, check the following.

You can fix some symptoms by yourself. If the problem persists even after you have tried a couple of times, contact your Sony dealer or local authorized Sony service facility.

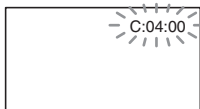

C:(or E): □□:□□ (Self-diagnosis display)

C:04:□□

- The battery pack is not an “InfoLITHIUM” battery pack NP-FH50. Use an “InfoLITHIUM” battery pack NP-FH50 (p. 93).
- Connect the DC plug of the AC Adaptor to the DC IN jack of the Handycam Station or your camcorder securely (p. 15).

C:13:□□ / C:32:□□

- Remove the power source. Reconnect it and operate your camcorder again.

E:20:□□ / E:31:□□ / E:61:□□ / E:62:□□ / E:91:□□ / E:94:□□

- A malfunction that you cannot service has occurred. Contact your Sony dealer or local authorized Sony service facility. Inform them of the 5-digit code, which starts from “E”.

101-0001 (Warning indicator pertaining to files)

Slow flashing

- The file is damaged.
- The file is unreadable.

⚡ (Battery level warning)

Slow flashing

- The battery pack is nearly used up.
- Depending on the operating environment or battery conditions, ⚡ may flash, even if there are approximately 20 minutes remaining.

[H] (High temperature warning)

Slow flashing

- The temperature of your camcorder is getting higher. Turn off your camcorder and leave it for a while in a cool place.

Fast flashing*

- The temperature of your camcorder is extremely high. Turn off your camcorder and leave it for a while in a cool place.

⚡ (Warning indicator pertaining to “Memory Stick PRO Duo”)

Slow flashing

- Free space for recording images are running out. For the type of “Memory Stick” you can use with your camcorder, see page 2.
- No “Memory Stick PRO Duo” is inserted (p. 21).

Fast flashing

- There are not enough free space for recording images. Delete unnecessary images, or format the “Memory Stick PRO Duo” after storing the images on other media (p. 44, 46, 58).
- The Image Database File is damaged (p. 59).

⚡ (Warning indicators pertaining to “Memory Stick PRO Duo” formatting)*

- The “Memory Stick PRO Duo” is damaged.
- The “Memory Stick PRO Duo” is not formatted correctly (p. 58, 92).

 **(Warning indicator pertaining to incompatible “Memory Stick PRO Duo”)***

- An incompatible “Memory Stick PRO Duo” is inserted (p. 92).

 **(Warning indicator pertaining to the write-protect of the “Memory Stick PRO Duo”)***

- Access to the “Memory Stick PRO Duo” was restricted on another device.

 **(Warning indicator pertaining to the flash)**

Fast flashing*

- There is something wrong with the flash.

 **(Warning indicator pertaining to camera-shake warning)**

- The amount of lights is not sufficient, so camera-shake easily occurs. Use the flash.
- The camcorder is unsteady, so camera-shake easily occurs. Hold the camcorder steady with both hands and record the image. However, note that the camera-shake warning indicator does not disappear.

 **(Warning indicator pertaining to still image recording)**

- The “Memory Stick PRO Duo” is full.
- Still images cannot be recorded during processing. Wait for a while, then record.

* You hear a melody when the warning indicators appear on the screen (p. 68).

Description of warning messages

If messages appear on the screen, follow the instructions.

■ “Memory Stick PRO Duo”

 **Reinsert the Memory Stick.**

- Reinsert the “Memory Stick PRO Duo” a few times. If even then the indicator flashes, the “Memory Stick PRO Duo” could be damaged. Try with another “Memory Stick PRO Duo.”

 **This Memory Stick is not formatted correctly.**

- Check the format, then format the “Memory Stick PRO Duo” with your camcorder if necessary (p. 58, 92).

Memory Stick folders are full.

- You cannot create folders exceeding 999MSDCF. You cannot create or delete folders using your camcorder.
- Format the “Memory Stick PRO Duo” (p. 58), or delete unnecessary folders using your computer.

This Memory Stick may not be able to record or play movies.

- Use the recommended “Memory Stick” (p. 2).

This Memory Stick may not be able to record or play images correctly.

- Contact your Sony dealer or local authorized Sony service facility.

Do not eject the Memory Stick during writing. Data may be damaged.

- Insert the “Memory Stick PRO Duo” again, and follow the instructions on the screen.

The Image Database File is damaged. Do you want to create a new file?

HD movie management information is damaged. Create new information?

- The image management file is damaged. When you touch [YES], a new image management file is created. The old recorded images on the “Memory Stick PRO Duo” cannot be played back (Image files are not damaged). If you perform [REPAIR IMG.DB F.] after creating new information, playing back the old recorded images may become possible. If it does not work, copy the image to a computer using the supplied software.

Inconsistencies found in Image Database File. Do you want to repair the Image Database File?

The Image Database File is damaged. Do you want to repair the Image Database File?

Inconsistencies found in Image Database File. Cannot record or play HD movies. Do you want to repair the Image Database File?

- The Image Database File is damaged, and you cannot record movies. Touch [YES] to repair.
- You can record still images on a “Memory Stick PRO Duo.”

Recovering data

- Your camcorder tries to recover data automatically if the data writing was not performed properly.

Cannot recover data.

- Because data writing onto the “Memory Stick PRO Duo” failed, your camcorder tried to recover the data, but could not recover data. You may not be able to record or edit data on the “Memory Stick PRO Duo.”

■ **PictBridge compliant printer**

Not connected to PictBridge compatible printer.

- Turn off the printer and on again, then remove the USB cable (supplied) and reconnect it.

Cannot print. Check the printer.

- Turn off the printer and on again, then remove the USB cable (supplied) and reconnect it.

■ **Other**

No further selection is possible.

- You can select only 100 images at one time for:
 - deleting images
 - editing the playlist of HD (high definition) movies
 - printing still images

Data protected.

- You tried to delete data protected on another device. Release the protection of the data on the device used to protect the data.

Using your camcorder abroad

Power supply

You can use your camcorder in any countries/regions using the AC Adaptor supplied with your camcorder within the AC 100 V to 240 V, 50/60 Hz range.

Viewing images recorded with HD (high definition) image quality

In countries/regions where 1080/50i is supported, you can view the images with the same HD (high definition) image quality as that of the recorded images. You need a PAL-system-based and 1080/50i compatible TV (or monitor) with component and AUDIO/VIDEO input jacks, or an HDMI input jack. A component A/V cable or an HDMI cable (optional) must be connected.

Viewing images recorded with SD (standard definition) image quality

To view images recorded with SD (standard definition) image quality, you need a PAL-system-based TV with AUDIO/VIDEO input jacks. An A/V connecting cable must be connected.

On TV color systems

Your camcorder is a PAL-system-based camcorder. If you want to view the playback image on a TV, it must be a PAL-system-based TV with an AUDIO/VIDEO input jack.

| System | Used in |
|---------|--|
| PAL | Australia, Austria, Belgium, China, Czech Republic, Denmark, Finland, Germany, Holland, Hong Kong, Hungary, Italy, Kuwait, Malaysia, New Zealand, Norway, Poland, Portugal, Singapore, Slovak Republic, Spain, Sweden, Switzerland, Thailand, United Kingdom, etc. |
| PAL - M | Brazil |
| PAL - N | Argentina, Paraguay, Uruguay. |
| NTSC | Bahama Islands, Bolivia, Canada, Central America, Chile, Colombia, Ecuador, Guyana, Jamaica, Japan, Korea, Mexico, Peru, Surinam, Taiwan, the Philippines, the USA, Venezuela, etc. |
| SECAM | Bulgaria, France, Guiana, Iran, Iraq, Monaco, Russia, Ukraine, etc. |

Setting to the local time

You can easily set the clock to the local time by setting a time difference when using your camcorder abroad. Touch **HOME** → **SETTINGS** → [CLOCK/**A**] LANG → [AREA SET] and [SUMMERTIME] (p. 70).

World time difference

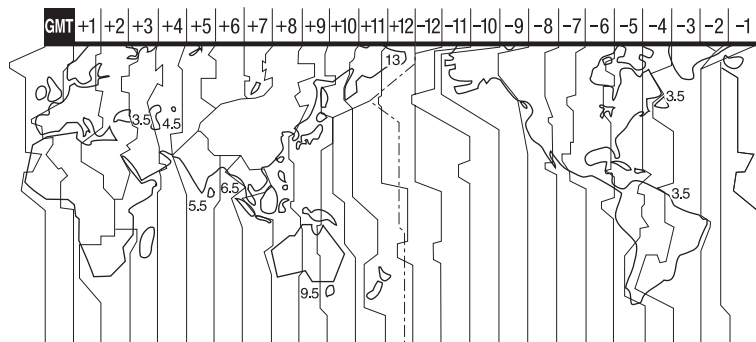

| Time-zone differences | Area setting |
|-----------------------|------------------------------|
| GMT | Lisbon, London |
| +01:00 | Berlin, Paris |
| +02:00 | Helsinki, Cairo, Istanbul |
| +03:00 | Moscow, Nairobi |
| +03:30 | Tehran |
| +04:00 | Abu Dhabi, Baku |
| +04:30 | Kabul |
| +05:00 | Karachi, Islamabad |
| +05:30 | Calcutta, New Delhi |
| +06:00 | Almaty, Dhaka |
| +06:30 | Rangoon |
| +07:00 | Bangkok, Jakarta |
| +08:00 | HongKong, Singapore, Beijing |
| +09:00 | Seoul, Tokyo |
| +09:30 | Adelaide, Darwin |
| +10:00 | Melbourne, Sydney |

| Time-zone differences | Area setting |
|-----------------------|------------------------|
| +11:00 | Solomon Is. |
| +12:00 | Fiji, Wellington |
| -12:00 | Eniwetok, Kwajalein |
| -11:00 | Samoa |
| -10:00 | Hawaii |
| -09:00 | Alaska |
| -08:00 | LosAngeles, Tijuana |
| -07:00 | Denver, Arizona |
| -06:00 | Chicago, Mexico City |
| -05:00 | New York, Bogota |
| -04:00 | Santiago |
| -03:30 | St. John's |
| -03:00 | Brasilia, Montevideo |
| -02:00 | Fernando de Noronha |
| -01:00 | Azores, Cape Verde Is. |

Files/folder structure on the “Memory Stick PRO Duo”

The file/folder structure is shown below. You do not usually need to acknowledge the file/folder structure, when recording/playing back images on the camcorder. To enjoy still images or movies by connecting to a computer, see “PMB Guide” on the supplied CD-ROM, then use the supplied application.

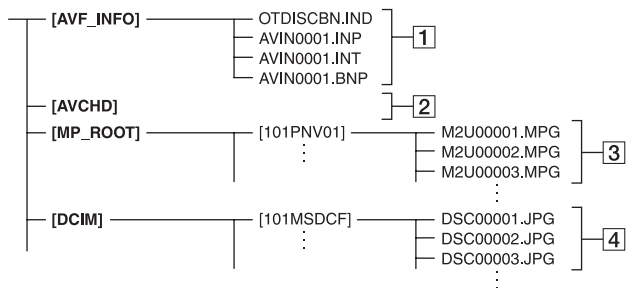

1 Image management files

When you delete the files, you cannot record/play back the images correctly. The files are defaulted as hidden files and not usually displayed.

2 HD movie management information folder

This folder contains recording data of movies with HD (high definition) image quality. Do not try to open this folder or access the contents of this folder from a computer. Doing so might damage image files, or prevent image files from being played back.

3 SD movie files (MPEG2 files)

The extension of the files is “.MPG”. The maximum size is 2 GB. When the capacity of a file exceeds 2 GB, the file becomes divided.

The file numbers go up automatically. When the capacity of a file number exceeds 9999, another folder is created to record new movie files.

The folder name goes up: [101PNV01] → [102PNV01]

4 Still image files (JPEG files)

The extension of the files is “.JPG”. The file numbers go up automatically. When the capacity of a file number exceeds

9999, another folder is created to store new image files.

The folder name goes up: [101MSDCF] → [102MSDCF]

- By selecting (HOME) → (OTHERS) → [USB CONNECT] → [USB CONNECT], you can access a “Memory Stick PRO Duo” in the camcorder from a computer through USB connection.
- Do not modify the files or folders on a “Memory Stick PRO Duo” in the camcorder from a computer. The image files may be destroyed or may not be played back.
- We (Sony) will not be responsible for the results of operating the data on a “Memory Stick PRO Duo” in the camcorder from a computer.
- When you delete image files, follow the steps on page 46. Do not delete the image files on a “Memory Stick PRO Duo” in the camcorder directly from a computer.
- Do not format a “Memory Stick PRO Duo” in the camcorder using a computer. The camcorder may not operate correctly.
- Do not copy the files on a “Memory Stick PRO Duo” in the camcorder from a computer. We (Sony) will not be responsible for the results of this kind of operation.

Maintenance and precautions

About the AVCHD format

What is the AVCHD format?

The AVCHD format is a high definition digital video camera format used to record an HD (high definition) signal of either the 1080i specification*¹ or the 720p specification*², using efficient data compression coding technology. The MPEG-4 AVC/H.264 format is adopted to compress video data, and the Dolby Digital or Linear PCM system is used to compress audio data.

The MPEG-4 AVC/H.264 format is capable of compressing images at higher efficiency than that of the conventional image compressing format. The MPEG-4 AVC/H.264 format enables a high definition video signal shot on a digital video camera recorder to be recorded on 8 cm DVD discs, internal hard disk drive, flash memory, "Memory Stick PRO Duo," etc.

Recording and playback on your camcorder

Based on the AVCHD format, your camcorder records with the HD (high definition) image quality mentioned below. In addition to HD (high definition) image quality, your camcorder is capable of recording an SD (standard definition) signal in the conventional MPEG2 format.

Video signal*³:

MPEG-4 AVC/H.264 1920 × 1080/50i,
1440 × 1080/50i

Audio signal:

Dolby Digital 5.1/2 ch

Recording media:

"Memory Stick PRO Duo"

*1: 1080i specification

A high definition specification which utilizes 1,080 effective scanning lines and the interlace system.

*2: 720p specification

A high definition specification which utilizes 720 effective scanning lines and the progressive system.

*3: Data recorded in AVCHD format other than the above mentioned cannot be played on your camcorder.

About the "Memory Stick"

A "Memory Stick" is a compact, portable IC recording medium with a large data capacity.

You can use only a "Memory Stick Duo," which is about the half size of a standard "Memory Stick," with your camcorder. However, we do not guarantee the operation of all types of "Memory Stick Duo" on your camcorder.

| Types of "Memory Stick" | Recording/ Playback |
|--|------------------------|
| "Memory Stick Duo" (with "MagicGate") | - |
| "Memory Stick PRO Duo" | ○ |
| "Memory Stick PRO-HG Duo" | ○* |

* This product does not support 8-bit parallel data transfer but it supports 4-bit parallel data transfer the same as with "Memory Stick PRO Duo."

- This product cannot record or play data that uses "MagicGate" technology. "MagicGate" is a copyright protection technology that records and transfers the contents in an encrypted format.
- A "Memory Stick PRO Duo" formatted by a computer (Windows OS/Mac OS) does not have guaranteed compatibility with your camcorder.
- Data read/write speed may vary depending on the combination of the "Memory Stick PRO Duo" and the "Memory Stick PRO Duo" compliant product you use.
- Damaged or lost data may occur in the following cases (the data will not be compensated for):
 - If you eject the "Memory Stick PRO Duo," or turn off your camcorder while your camcorder is reading or writing image files on the "Memory Stick PRO Duo" (while the access lamp is lit or flashing).

– If you use the “Memory Stick PRO Duo” near magnets or magnetic fields.

- It is recommended you make a back-up of important data on the hard disk of a computer.
- Be careful not to apply excessive force when writing on a memo area on a “Memory Stick PRO Duo.”
- Do not attach a label or the like on a “Memory Stick PRO Duo” or a Memory Stick Duo adaptor.
- When you carry or store a “Memory Stick PRO Duo,” put it in its case.
- Do not touch, or allow metallic objects to come into contact with the terminals.
- Do not bend, drop or apply strong force to the “Memory Stick PRO Duo.”
- Do not disassemble or modify the “Memory Stick PRO Duo.”
- Do not let the “Memory Stick PRO Duo” get wet.
- Keep “Memory Stick PRO Duo” media out of the reach of small children. There is danger that a child might swallow it.
- Do not insert anything other than a “Memory Stick PRO Duo” into the Memory Stick Duo slot. Doing so may cause a malfunction.
- Do not use or keep the “Memory Stick PRO Duo” in the following locations:
 - Places subject to extremely high temperature, such as a car parked outside in the summer
 - Places under direct sunlight
 - Places with extremely high humidity or subject to corrosive gases

■ On the Memory Stick Duo adaptor

- When using a “Memory Stick PRO Duo” with a “Memory Stick” compliant device, be sure to insert the “Memory Stick PRO Duo” into a Memory Stick Duo adaptor.
- When inserting a “Memory Stick PRO Duo” into a Memory Stick Duo adaptor, make sure the “Memory Stick PRO Duo” is inserted facing in the correct direction, then insert it all the way in. Note that improper use may cause a malfunction. Also, if you force the “Memory Stick PRO Duo” into the Memory Stick Duo adaptor in the wrong direction, it may be damaged.
- Do not insert a Memory Stick Duo adaptor without a “Memory Stick PRO Duo” attached into a “Memory Stick” compliant device. Doing so may result in malfunctions of the device.

■ On a “Memory Stick PRO Duo”

- The maximum memory capacity of a “Memory Stick PRO Duo” that can be used with your camcorder is 16 GB.

On image data compatibility

- Image data files recorded on a “Memory Stick PRO Duo” by your camcorder conform to the “Design rule for Camera File system” universal standard established by the JEITA (Japan Electronics and Information Technology Industries Association).
- On your camcorder, you cannot play back still images recorded on other devices (DCR-TRV900E or DSC-D700/D770) that do not conform to the universal standard. (These models are not sold in some regions.)
- If you cannot use a “Memory Stick PRO Duo” that has been used with another device, format it with your camcorder (p. 58). Note that formatting erases all information on the “Memory Stick PRO Duo.”
- You may not be able to play back images with your camcorder:
 - When playing back image data modified on your computer.
 - When playing back image data recorded with other devices.

About the “InfoLITHIUM” battery pack

Your camcorder operates only with an “InfoLITHIUM” battery pack NP-FH50. “InfoLITHIUM” H series battery packs have the  mark.

What is an “InfoLITHIUM” battery pack?

An “InfoLITHIUM” battery pack is a lithium-ion battery pack that has functions for communicating information related to operating conditions between your camcorder and an optional AC Adaptor/charger.

The “InfoLITHIUM” battery pack calculates the power consumption according to the operating conditions of

your camcorder, and displays the remaining battery time in minutes.

The battery pack NP-FH50 supplied with HDR-TG1E/TG3E is compatible with "ActiFORCE." "ActiFORCE" is a new generation power system. Battery capacity, boost charge, and the speed and accuracy of battery time remaining calculations have been improved when compared with current "InfoLITHIUM" P-series batteries.

To charge the battery pack

- Be sure to charge the battery pack before you start using your camcorder.
- We recommend charging the battery pack in an ambient temperature of between 10 °C to 30 °C (50 °F to 86 °F) until the  /CHG (charge) lamp turns off. If you charge the battery pack outside of this temperature range, you may not be able to charge it efficiently.



To use the battery pack effectively

- Battery pack performance decreases when the ambient temperature is 10 °C (50 °F) or below, and the length of time you can use the battery pack becomes shorter. In that case, do one of the following to use the battery pack for a longer time.
 - Put the battery pack in a pocket to warm it up, and insert it in your camcorder right before you start taking shots.
- Frequent use of the LCD screen or a frequent playback, fast forward or rewind operation wears out the battery pack faster.
- Be sure to turn off your camcorder when not recording or playing back on your camcorder. The battery pack is also consumed when your camcorder is in recording standby or playback pause.
- Have spare battery packs ready for 2 or 3 times the expected recording time, and make trial recordings before making the actual recording.
- Do not expose the battery pack to water. The battery pack is not water resistant.

About the remaining battery time indicator

- When the power goes off even though the remaining battery time indicator indicates that the battery pack has enough power to operate, charge the battery pack fully again. Remaining battery time will be indicated correctly. Note, however, that the battery indication will not be restored if it is used in high temperatures for a long time, or if left in a fully charged state, or when the battery pack is frequently used. Use the remaining battery time indication as a rough guide only.
- The  mark that indicates low battery flashes even if there are still 5 to 10 minutes of battery time remaining, depending on the operating conditions or ambient temperature.

About storage of the battery pack

- If the battery pack is not used for a long time, fully charge the battery pack and use it up on your camcorder once a year to maintain proper function. To store the battery pack, remove it from your camcorder and put it in a dry, cool place.
- To discharge the battery pack on your camcorder completely, touch  (HOME) →  (SETTINGS) → [GENERAL SET] → [A.SHUT OFF] → [NEVER] and leave your camcorder in recording standby with the LCD panel opened until the power goes off (p. 71).

About battery life

- Battery capacity decreases over time and through repeated use. If decreased usage time between charges becomes significant, it is probably time to replace it with a new one.
- Each battery's life is governed by storage, operating and environmental conditions.

About x.v.Color

- x.v.Color is a more familiar term for the xvYCC standard proposed by Sony, and is a trademark of Sony.
- xvYCC is an international standard for color space in video. This standard can express a wider color range than the currently used broadcast standard.

About handling of your camcorder

On use and care

- Do not use or store the camcorder and accessories in the following locations:
 - Anywhere extremely hot, cold or humid.
Never leave them exposed to temperatures above 60 °C (140 °F), such as under direct sunlight, near heaters or in a car parked in the sun. They may malfunction or become deformed.
 - Near strong magnetic fields or mechanical vibration. The camcorder may malfunction.
 - Near strong radio waves or radiation. The camcorder may not be able to record properly.
 - Near AM receivers and video equipment.
Noise may occur.
 - On a sandy beach or anywhere dusty. If sand or dust gets in your camcorder, it may malfunction. Sometimes this malfunction cannot be repaired.
 - Near windows or outdoors, where the LCD screen or the lens may be exposed to direct sunlight. This damages inside the LCD screen.
- Operate your camcorder on DC 6.8 V/7.2 V (battery pack) or DC 8.4 V (AC Adaptor).
- For DC or AC operation, use the accessories recommended in these operating instructions.
- Do not let your camcorder get wet, for example, from rain or sea water. If your camcorder gets wet, it may malfunction. Sometimes this malfunction cannot be repaired.
- If any solid object or liquid gets inside the casing, unplug your camcorder and have it checked by a Sony dealer before operating it any further.
- Avoid rough handling, disassembling, modifying, physical shock, or impact such as hammering, dropping or stepping on the product. Be particularly careful of the lens.
- Keep your camcorder turned off when you are not using your camcorder.
- Do not wrap your camcorder with a towel, for example, and operate it. Doing so might cause heat to build up inside.
- When disconnecting the power cord (mains lead), pull it by the plug and not the cord (lead).

- Do not damage the power cord (mains lead) such as by placing anything heavy on it.
- Keep metal contacts clean.
- If the battery electrolytic liquid has leaked:
 - consult your local authorized Sony service facility.
 - wash off any liquid that may have contacted your skin.
 - if any liquid gets in your eyes, wash with plenty of water and consult a doctor.

■ When not using your camcorder for a long time

- Periodically turn it on and let it run such as by playing back or recording images for about 3 minutes.
- Use up the battery pack completely before storing it.

Moisture condensation

If your camcorder is brought directly from a cold place to a warm place, moisture may condense inside your camcorder. This may cause a malfunction to your camcorder.

■ If moisture condensation has occurred

Leave your camcorder for about 1 hour without turning it on.

■ Note on moisture condensation

Moisture may condense when you bring your camcorder from a cold place into a warm place (or vice versa) or when you use your camcorder in a humid place as follows:

- You bring your camcorder from a ski slope into a place warmed up by a heating device.
- You bring your camcorder from an air conditioned car or room into a hot place outside.
- You use your camcorder after a squall or a shower.
- You use your camcorder in a hot and humid place.

■ How to prevent moisture condensation

When you bring your camcorder from a cold place into a warm place, put your camcorder in a plastic bag and seal it tightly. Remove the bag when the air temperature inside the plastic bag has reached the ambient temperature (after about 1 hour).

LCD screen



- Do not exert excessive pressure on the LCD screen, as it may cause damage.
- If your camcorder is used in a cold place, a residual image may appear on the LCD screen. This is not a malfunction.
- While using your camcorder, the back of the LCD screen may heat up. This is not a malfunction.

■ To clean the LCD screen

If fingerprints or dust make the LCD screen dirty, it is recommended you use a soft cloth to clean it. When you use the LCD Cleaning Kit (optional), do not apply the cleaning liquid directly to the LCD screen. Use cleaning paper moistened with the liquid.

■ On adjustment of the touch panel (CALIBRATION)

The buttons on the touch panel may not work correctly. If this happens, follow the procedure below. It is recommended that you connect your camcorder to the wall outlet (wall socket) using the supplied AC Adaptor during the operation.

- ① Turn on your camcorder.
- ② Touch  (HOME) →  (SETTINGS) → [GENERAL SET] → [CALIBRATION].

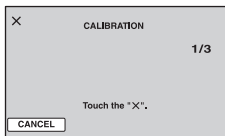

- ③ Touch "X" displayed on the screen with the corner of the "Memory Stick PRO Duo" or the like 3 times.

Touch [CANCEL] to cancel.

If you did not press the right spot, try the calibration again.

🔧 Notes

- Do not use a sharp-pointed object for calibration. Doing so may damage the LCD screen.
- You cannot calibrate the LCD screen if it is rotated, or closed with the screen facing out.

On handling the casing

- If the casing is soiled, clean the camcorder body with a soft cloth lightly moistened with water, and then wipe the casing with a dry soft cloth.
- Avoid the following to avoid damage to the finish:
 - Using chemicals such as thinner, benzine, alcohol, chemical cloths, repellent, insecticide and sunscreen.
 - Handling the camcorder with above substances on your hands.
 - Leaving the casing in contact with rubber or vinyl objects for a long period of time.

About care and storage of the lens

- Wipe the surface of the lens clean with a soft cloth in the following instances:
 - When there are fingerprints on the lens surface.
 - In hot or humid locations
 - When the lens is exposed to salty air such as at the seaside.
- Store in a well-ventilated location subject to little dirt or dust.
- To prevent mold, periodically clean the lens as described above. It is recommended that you operate your camcorder about once a month to keep it in optimum state for a long time.

On charging the pre-installed rechargeable battery

Your camcorder has a pre-installed rechargeable battery to retain the date, time, and other settings even when your camcorder turned off. The pre-installed rechargeable battery is always charged while your camcorder is connected to the wall outlet (wall socket) via the AC Adaptor or while the battery pack is attached. The rechargeable battery will be fully discharged in about **3 months** if you do not use your camcorder at all. Use your camcorder after charging the pre-installed rechargeable battery.

However, even if the pre-installed rechargeable battery is not charged, the camcorder operation will not be affected as long as you are not recording the date.

■ Procedures

Connect your camcorder to a wall outlet (wall socket) using the supplied AC Adaptor, and leave it with the power turned off for more than 24 hours.

On trademarks

- “Handycam” and **HANDYCAM** are registered trademarks of Sony Corporation.
- “AVCHD” and “AVCHD” logotype are trademarks of Matsushita Electric Industrial Co., Ltd. and Sony Corporation.
- “Memory Stick,” “,” “Memory Stick Duo,” “**MEMORY STICK DUO**,” “Memory Stick PRO Duo,” “**MEMORY STICK PRO DUO**,” “Memory Stick PRO-HG Duo,” “**MEMORY STICK PRO-HG DUO**,” “MagicGate,” “**MAGICGATE**,” “MagicGate Memory Stick” and “MagicGate Memory Stick Duo” are trademarks or registered trademarks of Sony Corporation.
- “InfoLITHIUM” is a trademark of Sony Corporation.
- “x.v.Colour” is a trademark of Sony Corporation.
- “BIONZ” is a trademark of Sony Corporation.
- “BRAVIA” is a trademark of Sony Corporation.
- “VAIO” is a trademark of Sony Corporation.
- “PLAYSTATION” is a registered trademark of Sony Computer Entertainment Inc.
- Dolby and the double-D symbol are trademarks of Dolby Laboratories.
- HDMI, the HDMI logo and High-Definition Multimedia Interface are trademarks or registered trademarks of HDMI Licensing LLC.
- Microsoft, Windows, and Windows Media are trademarks or registered trademarks of U.S. Microsoft Corporation in the U.S. and other countries.
- Macintosh and Mac OS are registered trademarks of Apple Inc. in the U.S. and other countries.
- Intel, Intel Core, and Pentium are trademarks or registered trademarks of Intel Corporation or its subsidiaries in the United States and other countries.
- Adobe, the Adobe logo, and Adobe Acrobat are either registered trademarks or trademarks of Adobe Systems Incorporated in the United States and/or other countries.

All other product names mentioned herein may be the trademarks or registered trademarks of their respective companies. Furthermore, TM and “®” are not mentioned in each case in this Handbook.

Notes on the License

ANY USE OF THIS PRODUCT OTHER THAN CONSUMER PERSONAL USE IN ANY MANNER THAT COMPLIES WITH THE MPEG-2 STANDARD FOR ENCODING VIDEO INFORMATION FOR PACKAGED MEDIA IS EXPRESSLY PROHIBITED WITHOUT A LICENSE UNDER APPLICABLE PATENTS IN THE MPEG-2 PATENT PORTFOLIO, WHICH LICENSE IS AVAILABLE FROM MPEG LA, L.L.C., 250 STEELE STREET, SUITE 300, DENVER, COLORADO 80206.

THIS PRODUCT IS LICENSED UNDER THE AVC PATENT PORTFOLIO LICENSE FOR THE PERSONAL AND NON-COMMERCIAL USE OF A CONSUMER TO

(i) ENCODE VIDEO IN COMPLIANCE WITH THE AVC STANDARD ("AVC VIDEO") AND / OR

(ii) DECODE AVC VIDEO THAT WAS ENCODED BY A CONSUMER ENGAGED IN A PERSONAL AND NON-COMMERCIAL ACTIVITY AND/OR WAS OBTAINED FROM A VIDEO PROVIDER LICENSED TO PROVIDE AVC VIDEO. NO LICENSE IS GRANTED OR SHALL BE IMPLIED FOR ANY OTHER USE. ADDITIONAL INFORMATION MAY BE OBTAINED FROM MPEG LA, L.L.C. SEE <[HTTP://MPEGLA.COM](http://MPEGLA.COM)>

"C Library," "Expat," "zlib," and "libjpeg" software are provided in your camcorder. We provide this software based on license agreements with their owners of copyright. Based on requests by the owners of copyright of these software applications, we have an obligation to inform you of the following. Please read the following sections.

Read "license1.pdf" in the "License" folder on the CD-ROM. You will find licenses (in English) of "C Library," "Expat," "zlib," and "libjpeg" software.

On GNU GPL/LGPL applied software

The software that is eligible for the following GNU General Public License (hereinafter referred to as "GPL") or GNU Lesser General Public License (hereinafter referred to as "LGPL") are included in the camcorder.

This informs you that you have a right to have access to, modify, and redistribute source code for these software programs under the conditions of the supplied GPL/LGPL.

Source code is provided on the web. Use the following URL to download it. When downloading the source code, select DCR-DVD810 as the model for your camcorder.

<http://www.sony.net/Products/Linux/>

We would prefer you do not contact us about the contents of source code.





Read "license2.pdf" in the "License" folder on the CD-ROM. You will find licenses (in English) of "GPL," and "LGPL" software.

To view the PDF, Adobe Reader is needed. If it is not installed on your computer, you can download it from the Adobe Systems web page:
<http://www.adobe.com/>

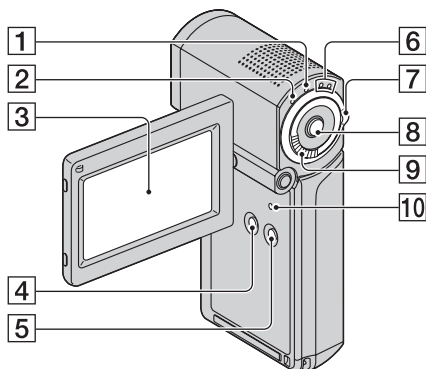
Identifying parts and controls

The numbers in () are reference pages.



- 1 QUICK ON lamp (29)
- 2  /CHG (charge) lamp (15)
- 3 LCD screen/touch panel (18)
- 4 DISP/BATT INFO button (17, 19)
- 5 EASY button (22)
- 6  (Movie)/ (Still) mode lamps (19)
- 7  (Movie)/ (Still) select switch (19)
- 8 START/STOP button (27)
- 9 Power zoom lever (28, 35)
- 10 RESET button
Initializes all the settings, including the setting of the date and time.

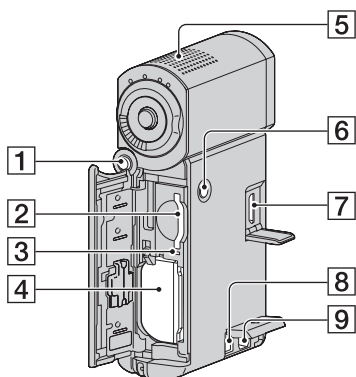

- 1** PHOTO button (27)
- 2** Memory Stick Duo slot (21)
- 3** Access lamp (21)
- 4** Battery pack (15)
- 5** Built-in microphone (28)
- 6** POWER button (18)
- 7** HDMI OUT jack (37)
- 8** DC IN jack (15)
- 9** A/V Remote Connector (37)

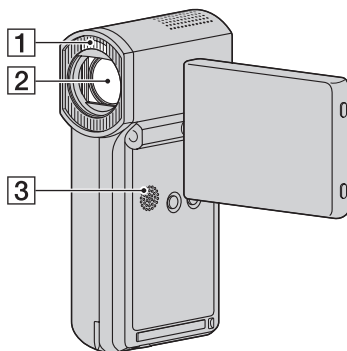

- 1** Flash (64)
- 2** Lens (Carl Zeiss Lens) (4)
- 3** Speaker
Playback sounds come out from the speaker. For how to adjust the volume, see page 33.

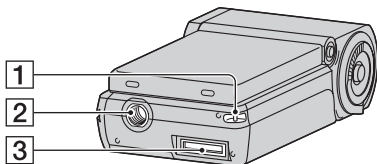

1 Hook for wrist strap

Attach the strap and place your hand through the loop to prevent the camcorder from damage by being dropped.

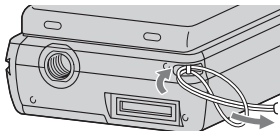

2 Tripod receptacle

Attach the tripod (optional) to the tripod receptacle using a tripod screw (optional: the length of the screw must be less than 5.5 mm (7/32 in.)).

3 Interface connector

Connects your camcorder to the Handycam Station or the Dedicated USB Terminal Adaptor. By attaching the Dedicated USB Terminal Adaptor, you can connect the USB cable to your camcorder without using the Handycam Station.

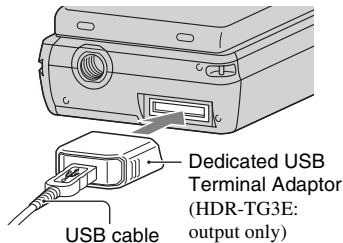

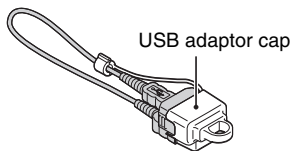
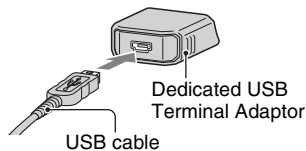

On attaching the Dedicated USB Terminal Adaptor/USB adaptor cap

- Depending on when or where you use the camcorder, attach the Dedicated USB Terminal Adaptor to either the long or the short cable.
- Attach the USB adaptor cap on the USB cable when carrying it in bags, etc.
- Be careful not to hang or give strong impact to the adaptor or the cable. It may become damaged.

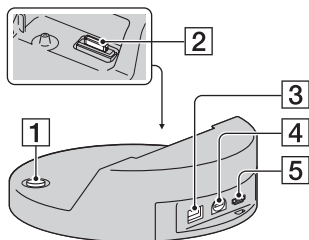

Handycam Station



- 1**  (DISC BURN) button (44)
- 2** Interface connector
Connect to the interface connector on your camcorder when you attach your camcorder to the Handycam Station.
- 3** DC IN jack (15)
- 4** A/V OUT jack (37)
- 5**  (USB) jack (53, 55)
HDR-TG3E: output only

Indicators displayed during recording/playback

Recording movies

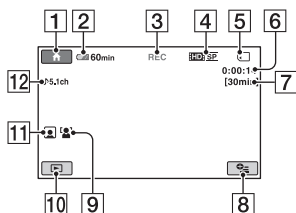

Recording still images

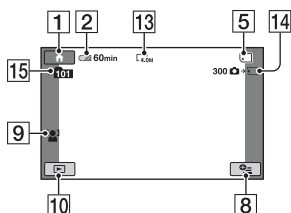

Viewing movies

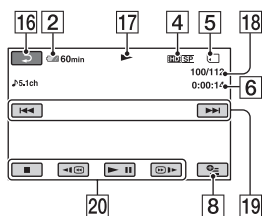

Viewing still images

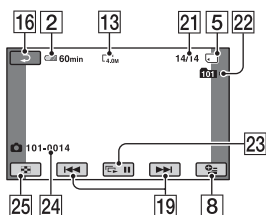

- 1 HOME button (12)
- 2 Remaining battery (approx.) (17)
- 3 Recording status ([STBY] (standby) or [REC] (recording))
- 4 Recording quality (HD/SD) (57) and recording mode (FH/HQ/SP/LP) (62)
- 5 Media
- 6 Counter (hour/minute/second)
- 7 Recording remaining time
- 8 OPTION button (13)
- 9 FACE DETECTION (65)
- 10 VIEW IMAGES button (31)
- 11 Face Index set (65)
- 12 5.1ch surround recording (28)
- 13 Image size (66)
- 14 Approximate number of recordable still images and media/During still image recording
- 15 Recording folder
- 16 Return button
- 17 Playback mode
- 18 Currently playing movie number/ Number of total recorded movies
- 19 Previous/Next button (32)
- 20 Video operation buttons (32)
- 21 Currently playing still image number/ Number of total recorded still images
- 22 Playback folder
- 23 Slide show button (36)
- 24 Data file name
- 25 VISUAL INDEX button (31)

Indicators when you made changes

Following indicators appear during recording/playback to indicate the settings of your camcorder.

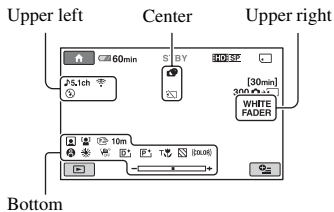

Upper left

| Indicator | Meaning |
|-------------|--|
| J5.1ch J2ch | AUDIO MODE (62) |
| | Self-timer recording (78) |
| | Flash light (64), REDEYE REDUC (65) |
| | MICREF LEVEL low (78) |
| | WIDE SELECT (62) |
| | BLT-IN ZOOM MIC (78) |

Center

| Indicator | Meaning |
|-----------|-------------------------------|
| | IMAGE SIZE (66) |
| | Continuous slide show (36) |
| | Color Slow Shutter (77) |
| | PictBridge connecting (55) |
| | Warning (86) |

Upper right

| Indicator | Meaning |
|-------------------------|------------------------|
| WHITE FADER BLACK FADER | Fader (77) |
| | LCD backlight off (19) |

Bottom

| Indicator | Meaning |
|-----------|-----------------------------------|
| | Picture effect (77) |
| | Digital effect (77) |
| | Manual focus (74) |
| | SCENE SELECTION (75) |
| | White balance (76) |
| | SteadyShot off (63) |
| | SPOT METER (75)/ EXPOSURE (75) |
| | Tele macro (74) |
| | Zebra (63) |
| | X.V.COLOR (63) |
| | Face Index (65) |
| | FACE DETECTION (65) |

💡 Tips

- Indicators and their positions are approximate and differ from what you actually see.

Data code during recording

The recording date and time is recorded automatically on the "Memory Stick PRO Duo." They are not displayed while recording. However, you can check them as [DATA CODE] during playback (p. 67).

Glossary

■ 5.1ch surround sound

A system that plays back sound on 6 speakers, 3 at the front (left, right and center) and 2 at the rear (right and left) with an additional low-pass subwoofer counted as a 0.1 channel for frequencies of 120 Hz or lower.

■ AVCHD format

A high definition digital video camera format used to record an HD (high definition) signal using the MPEG-4 AVC/H.264 format.

■ Dolby Digital

An audio encoding (compression) system developed by Dolby Laboratories Inc.

■ Dolby Digital 5.1 Creator

Sound compression technology developed by Dolby Laboratories Inc. which compresses audio efficiently while preserving high sound quality. Sounds are compressed effectively with high quality sound, and it enables producing 5.1ch surround sound.

■ Fragmentation

The condition of a media in which files are divided into pieces scattered around the media. You may not save your images correctly. You can solve the condition by performing [MEDIA FORMAT] (p. 58).

■ JPEG

JPEG stands for Joint Photographic Experts Group, a still image data compression (data capacity reduction) standard. Your camcorder records still images in JPEG format.



■ MPEG

MPEG stands for Moving Picture Experts Group, the group of standards for the coding (image compression) of video (movie) and audio. There are MPEG1 and MPEG2 formats. Your camcorder records movies with SD (standard definition) image quality in MPEG2 format.

■ MPEG-4 AVC/H.264

The latest image coding format standardized jointly by two international standardization organizations, the ISO-IEC and the ITU-T, in 2003. Compared with the conventional MPEG2 format, MPEG-4 AVC/H.264 has more than twice the efficiency. Your camcorder employs MPEG-4 AVC/H.264 to encode high definition movies.

■ Thumbnail

Reduced-size images which enable you to view many images at the same time. [VISUAL INDEX]/[ INDEX]/[ INDEX] are thumbnail display system.

■ VBR

VBR stands for Variable Bit Rate, the recording format for automatically controlling the bit rate (the volume of recording data in a given time segment) according to the scene being recorded. For fast-moving video, a lot of "Memory Stick PRO Duo" space is used to produce a clear image, so the recording time to the "Memory Stick PRO Duo" shortens.

Index

Numeric

| | |
|-------------------------------|----|
| 1080i/576i..... | 70 |
| 16:9..... | 69 |
| 21-pin adaptor..... | 42 |
| 2ch STEREO..... | 62 |
| 4:3..... | 69 |
| 576i..... | 70 |
| 5.1ch SURROUND..... | 62 |
| 5.1ch surround recording..... | 28 |

A

| | |
|--|------------|
| AC Adaptor..... | 14, 15 |
| ADD by date..... | 50 |
| AREA SET..... | 70 |
| AUDIO MODE..... | 62 |
| AUTO SLW SHUTTR (Auto Slow Shutter)..... | 63, 84 |
| AVCHD format..... | 92, 105 |
| A.SHUT OFF (Auto shut off)..... | 71 |
| A/V connecting cable..... | 14, 41, 52 |
| A/V OUT jack..... | 37 |
| A/V Remote Connector..... | 37 |

B

| | |
|---|-------------------|
| Backup..... | See Saving images |
| Battery pack..... | 15 |
| BEACH..... | 76 |
| BEEP..... | 68 |
| BLACK FADER..... | 77 |
| BLT-IN ZOOM MIC (Built-in zoom microphone)..... | 78 |
| “BRAVIA” Sync..... | 42 |
| B&W (Black and white)..... | 77 |

C

| | |
|------------------|----|
| CALIBRATION..... | 96 |
| CAMERA DATA..... | 67 |
| CANDLE..... | 75 |
| CD-ROM..... | 14 |

| | |
|---|------------|
| Charging the battery..... | 15 |
| Charging time..... | 17 |
| CLOCK SET..... | 19 |
| CLOCK/LANG..... | 70 |
| COLOR SLOW SHTR (Color Slow Shutter)..... | 77, 84 |
| COMPONENT..... | 70 |
| Component A/V cable..... | 14, 39, 41 |
| Connection..... | |
| 4:3 TV..... | 40 |
| DVD/HDD recorders..... | 52 |
| High definition TV..... | 39 |
| Printer..... | 55 |
| USB device..... | 53 |
| VCR..... | 52 |
| Wide TV..... | 40 |
| CTRL FOR HDMI (Control for HDMI)..... | 71 |

D

| | |
|-------------------------------------|-------------|
| DATA CODE..... | 67, 104 |
| Date Index..... | 35 |
| DATE/TIME..... | 67, 104 |
| DC IN jack..... | 15 |
| Dedicated USB Terminal Adaptor..... | 14, 54, 101 |
| DELETE..... | 46 |
| DELETE ALL..... | 46 |
| DELETE by date..... | 46 |
| Still image..... | 47 |
| DEMO MODE..... | 71 |
| DIGITAL ZOOM..... | 63 |
| DISP OUTPUT..... | 70, 85 |
| DISPLAY..... | 68 |
| Display indicators..... | 103 |
| DIVIDE..... | 48 |
| Dolby Digital 5.1 Creator..... | 28 |
| Dual Rec..... | 29 |
| D.EFFECT (Digital effect)..... | 77, 84 |

E

| | |
|------------------------------|----|
| Easy Handycam operation..... | 22 |
| Editing..... | 45 |
| EXPOSURE..... | 75 |

F

| | |
|-----------------------------|--------|
| FACE DETECTION..... | 65, 85 |
| Face Index..... | 34 |
| FADER..... | 77, 84 |
| FH..... | 62 |
| File..... | 91 |
| FILE NO. (File number)..... | 66 |
| Film Roll Index..... | 34 |
| FIREWORKS..... | 75 |
| Flash..... | 81 |
| FLASH LEVEL..... | 64 |
| FLASH MODE..... | 64 |
| FOCUS..... | 74, 82 |
| Folder..... | 91 |
| Fragmentation..... | 105 |
| Full charge..... | 17 |

G

| | |
|------------------|----|
| GENERAL SET..... | 71 |
| GUIDEFRA..... | 63 |

H

| | |
|---|--------|
| Handycam Station..... | 15 |
| HD (high definition) image quality..... | 8 |
| HDMI cable..... | 40 |
| HD/SD SET..... | 57 |
| HELP..... | 12 |
| High Definition TV..... | 39 |
| Holding the camcorder..... | 26 |
| HOME MENU..... | 11, 60 |
| CLOCK/LANG..... | 70 |
| GENERAL SET..... | 71 |
| MOVIE SETTINGS..... | 62 |
| OUTPUT SETTINGS..... | 69 |
| PHOTO SETTINGS..... | 66 |

| | |
|-------------------------|----|
| SETTINGS category | 60 |
| SOUND/DISP SET | 68 |
| VIEW IMAGES SET | 67 |
| HQ | 62 |

I

| | |
|-----------------------------------|------------------------|
| Icon | See Display indicators |
| Image management files | 91 |
| Image quality | 57 |
| image quality setting | 57 |
| IMAGE SIZE | 66 |
| Index screen display button | 103 |
| INDEX SET (Fase Index set) | 65 |
| Indicators | 104 |
| INDOOR | 76 |
| "InfoLITHIUM" battery pack | 93 |

J

| | |
|------------|---------|
| JPEG | 91, 105 |
|------------|---------|

L

| | |
|--------------------|----|
| LANDSCAPE | 76 |
| LANGUAGE SET | 70 |
| LCD BL LEVEL | 69 |
| LCD BRIGHT | 68 |
| LCD COLOR | 69 |
| LCD panel | 18 |
| LCD BL LEVEL | 69 |
| LCD BRIGHT | 68 |
| LCD COLOR | 69 |
| LCD screen | 18 |
| LP | 62 |

M

| | |
|-----------------------------|----|
| Maintenance | 92 |
| MANAGE MEDIA category | 57 |
| MEDIA FORMAT | 58 |
| MEDIA INFO | 58 |

| | |
|---|--------|
| "Memory Stick" | 2, 92 |
| Memory Stick Duo adaptor | 2, 93 |
| "Memory Stick PRO Duo" | 2, 92 |
| "Memory Stick PRO-HG Duo" | 2, 92 |
| MICREF LEVEL (Microphone reference level) | 78, 85 |
| Mirror mode | 29 |
| Moisture condensation | 95 |
| Movie | |

| | |
|-------------------------|----|
| Recording mode | 62 |
| Recording quality | 10 |
| Shooting | 26 |

| | |
|------------------------|-----|
| MOVIE SETTINGS | 62 |
| MPEG | 105 |
| MPEG2 | 91 |
| MPEG-4 AVC/H.264 | 105 |

N

| | |
|-------------------------------------|----|
| Number of recordable pictures | 66 |
|-------------------------------------|----|

O

| | |
|-----------------------------------|----------|
| OLD MOVIE | 77 |
| ONE PUSH | 76 |
| Operation confirmation beep | See BEEP |
| OPTION MENU | 72 |
| Original | 49 |
| OTHERS category | 45 |
| OUTDOOR | 76 |
| OUTPUT SETTINGS | 69 |

P

| | |
|----------------------|----|
| PAL | 89 |
| PASTEL | 78 |
| PB zoom | 35 |
| PHOTO CAPTURE | 47 |
| PHOTO SETTINGS | 66 |
| "PhotoTV HD" | 42 |

| | |
|--|--------|
| PictBridge | 55 |
| PICT.EFFECT (Picture effect) | 77, 84 |
| Playback | 23, 31 |
| Playback time | 17 |
| Playlist | 49 |
| PORTRAIT (Soft portrait) | 76 |
| Power cord (Mains lead) | 14 |
| Pre-installed rechargeable battery | 97 |
| Print | 55 |

Q

| | |
|--|----|
| QUICK ON | 29 |
| QUICK ON STBY (Quick on standby) | 71 |

R

| | |
|------------------------------|--------|
| REC MODE | 62 |
| Recording | 22, 26 |
| Recording format | 92 |
| Recording quality | 10 |
| Recording time | 17 |
| REDEYE REDUC | 65 |
| Remaining | |
| Battery | 17 |
| "Memory Stick PRO Duo" | 58 |
| Remaining battery | 17 |
| REMAINING SET (movie) | 64 |
| REPAIR IMG.DB F. | 59 |
| RESET | 99 |

S

| | |
|--|--------|
| S VIDEO cable | 41, 52 |
| Saving images | 44 |
| SCENE SELECTION | 75, 84 |
| SD (standard definition) image quality | 8 |
| Self-diagnosis display | 86 |
| SELF-TIMER | 78 |

| | |
|--|--------|
| SEPIA | 77 |
| SETTINGS | 60 |
| SETTINGS category | 60 |
| Sleep mode | 29 |
| Slide show | 36 |
| SLIDE SHOW SET | 36 |
| SMTH SLW REC..... | 30 |
| SNOW | 76 |
| SOUND/DISP SET | 68 |
| SP..... | 62 |
| SPOT FOCUS | 74, 84 |
| SPOT METER (Flexible spot meter)..... | 75 |
| SPOTLIGHT | 76 |
| STEADYSHOT..... | 63, 84 |
| Still image | |
| IMAGE SIZE | 66 |
| Shooting | 27 |
| Still image files | 91 |
| SUB-T DATE (Subtitle date) | 64 |
| SUMMERTIME..... | 70 |
| SUNRISE&SUNSET | 75 |

T

| | |
|-----------------------|--------|
| TELE MACRO..... | 74, 84 |
| Telephoto..... | 28 |
| Thumbnail | 105 |
| Tripod | 101 |
| TV color system | 89 |
| TV CONNECT Guide..... | 38 |
| TV TYPE..... | 69 |
| TWILIGHT | 75 |
| TWILIGHT PORT. | 75 |

U

| | |
|----------------------|---------|
| USB adaptor cap..... | 14, 101 |
| USB cable..... | 14 |
| USB CONNECT | 91 |
| USB SELECT..... | 53, 54 |
| Using abroad..... | 89 |

V

| | |
|-------------------------------|---------|
| VBR | 10, 105 |
| VIEW IMAGES SET..... | 67 |
| Viewing pictures on a TV | 37 |
| VISUAL INDEX | 23, 31 |
| VOLUME | 68 |
| Volume adjustment | 33 |

W

| | |
|-------------------------------------|--------|
| Wall outlet (Wall socket).... | 15 |
| Warning indicators..... | 86 |
| Warning messages | 87 |
| WHITE BAL. (White balance) | 76, 84 |
| WHITE FADER | 77 |
| Wide angle | 28 |
| WIDE SELECT | 62, 85 |
| Wide TV | 40 |
| World time difference..... | 90 |
| Wrist strap..... | 101 |

X

| | |
|-----------------|--------|
| X.V.COLOR | 63, 94 |
|-----------------|--------|

Z

| | |
|-------------|----|
| ZEBRA | 63 |
| Zoom..... | 28 |

Additional information on this product and answers to frequently asked questions can be found at our Customer Support Website.

<http://www.sony.net/>

Free Manuals Download Website

<http://myh66.com>

<http://usermanuals.us>

<http://www.somanuals.com>

<http://www.4manuals.cc>

<http://www.manual-lib.com>

<http://www.404manual.com>

<http://www.luxmanual.com>

<http://aubethermostatmanual.com>

Golf course search by state

<http://golfingnear.com>

Email search by domain

<http://emailbydomain.com>

Auto manuals search

<http://auto.somanuals.com>

TV manuals search

<http://tv.somanuals.com>