

SONY

SONY®

HANDYCAM

Digital HD Video Camera Recorder

HANDYCAM®

Operating Guide

HDR-FX1000

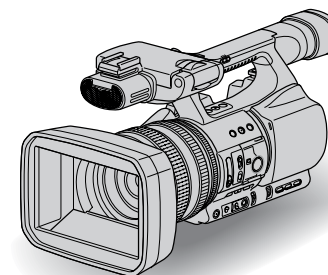
 Enjoying pictures with
high definition quality 12

Getting Started 16

 Recording/
Playback 28

Using the Menu 62

Dubbing/Editing 84

Using a Computer 91

Troubleshooting 94

Additional Information 107

Quick Reference 123

Spanish Quick Guide/
Guía rápida en español 135

US

Additional information on this product and answers to frequently asked questions can be found at our Customer Support Website.

<http://www.sony.net/>



Printed on 70% or more recycled paper using VOC (Volatile Organic Compound) -free vegetable oil based ink.

Printed in Japan



4 111 862 110

HDV Mini DV Digital Video Cassette

HDV 1080i



© 2008 Sony Corporation

Download from www.somanuals.com. All Manuals Search And Download.

WARNING

To reduce fire or shock hazard, do not expose the unit to rain or moisture.

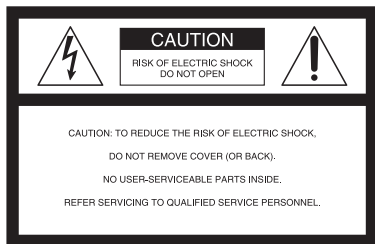

This symbol is intended to alert the user to the presence of uninsulated “dangerous voltage” within the product’s enclosure that may be of sufficient magnitude to constitute a risk of electric shock to persons.



This symbol is intended to alert the user to the presence of important operating and maintenance (servicing) instructions in the literature accompanying the appliance.

Never expose the battery pack to temperature above 60 °C (140 °F), such as in a car parked in the sun or under direct sunlight.

IMPORTANT SAFETY INSTRUCTIONS

SAVE THESE INSTRUCTIONS.
DANGER - TO REDUCE THE RISK OF FIRE
OR ELECTRIC SHOCK,
CAREFULLY FOLLOW THESE
INSTRUCTIONS.

- Read these instructions.
- Keep these instructions.
- Heed all warnings.
- Follow all instructions.
- Do not use this apparatus near water.
- Clean only with dry cloth.
- Do not block any ventilation openings. Install in accordance with the manufacturer's instructions.
- Do not install near any heat sources such as radiators, heat registers, stoves, or other apparatus (including amplifiers) that produce heat.
- Do not defeat the safety purpose of the polarized or grounding-type plug. A polarized plug has two blades with one wider than the other. A grounding type plug has two blades and a third grounding prong. The wide blade or the third prong are provided for your safety. If the provided plug does not fit into your outlet, consult an electrician for replacement of the obsolete outlet.
- Protect the power cord from being walked on or pinched particularly at plugs, convenience receptacles, and the point where they exit from the apparatus.
- Only use attachments/accessories specified by the manufacturer.
- Use only with the cart, stand, tripod, bracket, or table specified by the manufacturer, or sold with the apparatus. When a cart is used, use caution when moving the cart/apparatus combination to avoid injury from tip-over.



- Unplug this apparatus during lightning storms or when unused for long periods of time.

IMPORTANT SAFETY INSTRUCTIONS (Continued)

- Refer all servicing to qualified service personnel. Servicing is required when the apparatus has been damaged in any way, such as power-supply cord or plug is damaged, liquid has been spilled or objects have fallen into the apparatus, the apparatus has been exposed to rain or moisture, does not operate normally, or has been dropped.
- This set should be operated only from the type of power source indicated on the marking label. If you are not sure of the type of electrical power supplied to your home, consult your dealer or local power company. For those sets designed to operate from battery power, or other sources, refer to the operating instructions.
- For connection to a supply not in the U.S.A., use an attachment plug adapter of the proper configuration for the power outlet.

Read this first

Before operating the unit, please read this manual thoroughly, and retain it for future reference.

CAUTION

Replace the battery with the specified type only. Otherwise, fire or injury may result.

Excessive sound pressure from earphones and headphones can cause hearing loss.

Do not expose the batteries to excessive heat such as sunshine, fire or the like.

For customers in the U.S.A. and CANADA

RECYCLING LITHIUM-ION BATTERIES

Lithium-Ion batteries are recyclable. You can help preserve our environment by returning your used rechargeable batteries to the collection and recycling location nearest you.



For more information regarding recycling of rechargeable batteries, call toll free 1-800-822-8837, or visit <http://www.rbrcl.org>

Caution: Do not handle damaged or leaking Lithium-Ion batteries.

Owner's Record

The model and serial numbers are located on the bottom. Record the serial number in the space provided below. Refer to these numbers whenever you call upon your Sony dealer regarding this product.

Model No. HDR-FX1000

Serial No. _____

Model No. AC- _____

No. _____

For customers in the U.S.A.

If you have any questions about this product, you may call:
Sony Customer Information Center 1-800-222-SONY (7669).

The number below is for the FCC related matters only.

Regulatory Information

Declaration of Conformity

Trade Name: SONY

Model No.: HDR-FX1000

Responsible Party: Sony Electronics Inc.

Address: 16530 Via Esprillo, San Diego, CA 92127 U.S.A.

Telephone Number: 858-942-2230

This device complies with Part 15 of the FCC Rules.

Operation is subject to the following two conditions:

(1) This device may not cause harmful interference, and (2) this device must accept any interference received, including interference that may cause undesired operation.

CAUTION

You are cautioned that any changes or modifications not expressly approved in this manual could void your authority to operate this equipment.

Note

This equipment has been tested and found to comply with the limits for a Class B digital device, pursuant to Part 15 of the FCC Rules.

These limits are designed to provide reasonable protection against harmful interference in a residential installation. This equipment generates, uses, and can radiate radio frequency energy and, if not installed and used in accordance with the instructions, may cause harmful interference to radio communications.

However, there is no guarantee that interference will not occur in a particular installation. If this equipment does cause harmful interference to radio or television reception, which can be determined by turning the equipment off and on, the user is encouraged to try to correct the interference by one or more of the following measures:

Read this first (Continued)

- Reorient or relocate the receiving antenna.
- Increase the separation between the equipment and receiver.
- Connect the equipment into an outlet on a circuit different from that to which the receiver is connected.
- Consult the dealer or an experienced radio/TV technician for help.

The supplied interface cable must be used with the equipment in order to comply with the limits for a digital device pursuant to Subpart B of Part 15 of FCC Rules.

For the State of California, USA only

Perchlorate Material - special handling may apply. See www.dtsc.ca.gov/hazardouswaste/perchlorate
Perchlorate Material: Lithium battery contains perchlorate.

Notes on use

Types of cassette you can use in your camcorder

You can use mini DV cassettes marked with ^{Mini} **DV**. Your camcorder does not support the Cassette Memory function (p. 110).

Types of "Memory Stick" you can use in your camcorder

You can use "Memory Stick" that have the logo shown below (p. 111).

- MEMORY STICK DUO ("Memory Stick Duo")
- MEMORY STICK PRO DUO ("Memory Stick PRO Duo")
- MEMORY STICK PRO-HG DUO ("Memory Stick PRO-HG Duo")

"Memory Stick Duo"
(This size can be used with your camcorder.)



"Memory Stick"
(You cannot use with your camcorder.)



- You cannot use any type of memory card except "Memory Stick Duo."
- "Memory Stick PRO Duo" can be used only with "Memory Stick PRO" compatible equipment.
- Do not attach a label or the like on a "Memory Stick Duo" or a "Memory Stick Duo" Adaptor.

When using a "Memory Stick Duo" with "Memory Stick" compatible equipment

Be sure to insert the "Memory Stick Duo" into the "Memory Stick Duo" Adaptor.

"Memory Stick Duo" Adaptor



Using the camcorder

- Do not hold the camcorder by the following part.



Lens hood with lens cover



Viewfinder



LCD panel

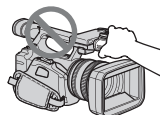

Microphone

Notes

- The camcorder is not dustproof, dripproof or waterproof.
See "About handling of your camcorder" (p. 115).

- Do not connect cables to your camcorder with their terminals placed the wrong way. Squeezing the terminals into your camcorder's jacks may damage them or results in a malfunction of your camcorder.

About menu items, LCD panel, viewfinder, and lens

- A menu item that is grayed out is not available under the current recording or playback conditions.
- The LCD screen and the viewfinder are manufactured using extremely high-precision technology, so over 99.99% of the pixels are operational for effective use. However, there may be some tiny black points and/or bright points (white, red, blue, or green in color) that appear constantly on the LCD screen and the viewfinder. These points are normal results of the manufacturing process and do not affect the recording in any way.

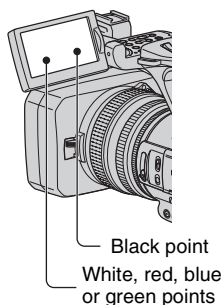

About temperature of your camcorder and battery pack

- Your camcorder has a protective function that disables recording or playback if the temperature of your camcorder or battery pack is beyond the safely operable range. In this case, a message appears on the screen or in the viewfinder (p. 105).

Do not expose your camcorder's viewfinder, lens, or LCD screen to the sun or strong light source for extended periods.

- Intense light sources, especially the sun will converge on the viewfinder or lens and damage the internal parts of your camcorder. Avoid sunlight or other strong light sources when storing your camcorder. Protect this device by always closing the lens cover or by placing it in its bag when not in use.

On recording

- Before starting to record, test the recording function to make sure the picture and sound are recorded without any problems.
- Compensation for the contents of recordings cannot be provided, even if recording or playback is not possible due to a malfunction of the camcorder, storage media, etc.
- TV color systems differ depending on the countries/regions. To view your recordings on a TV, you need an NTSC system-based TV.
- Television programs, films, video tapes, and other materials may be copyrighted. Unauthorized recording of such materials may be contrary to the copyright laws.
- Because of the way that the image device (CMOS sensor) reads out image signals, the subjects passing by the frame rapidly might appear crooked depending on the recording conditions. This phenomenon may be notable in displays having high motion resolution.

Read this first (Continued)

On playing back HDV tapes on other devices

You cannot play back a tape recorded in the HDV format on DV format video cameras or on mini DV players.

Check the contents of tapes by playing them back on this camcorder prior to playing them back on other devices.

Note on the icons used in this manual

 Features available for the HDV format only

 Features available for the DV format only

 This function that can be used when i.LINK cable is connected.

 The function that can be assigned to an ASSIGN button.

About this manual

- The images of the LCD screen and the viewfinder used in this manual for illustration purposes are captured using a digital still camera, and therefore may appear different.
- The on-screen displays in each local language are used for illustrating the operating procedures. Change the screen language before using your camcorder if necessary (p. 25).
- Design and specifications of recording media and other accessories are subject to change without notice.

Table of Contents

IMPORTANT SAFETY INSTRUCTIONS	3
Read this first	5



Enjoying pictures with high definition quality

Trying out the new HDV format!	12
Features of this camcorder	13
Handy Functions for Recording	14
Viewing video recorded in the HDV format!	15

Getting Started

Step 1: Checking supplied items	16
Step 2: Attaching the lens hood with lens cover	17
Step 3: Charging the battery pack	18
Step 4: Turning the power on and holding your camcorder properly	21
Step 5: Adjusting the LCD panel and viewfinder	22
Step 6: Setting the date and time	24
Changing the language setting	25
Step 7: Inserting a tape or a "Memory Stick Duo"	26









Recording/Playback

Recording	28
Changing the settings of your camcorder recordings	31
Adjusting the zoom	31
Adjusting the focus manually	32
Adjusting the image brightness	33
Adjusting to Natural Color (White balance).....	36
Customizing the picture quality (Picture profile).....	37
Adjusting the volume	42
Assigning the functions to the ASSIGN buttons	44
Recording an index signal	45
Reviewing the most recently recorded scenes (Rec review).....	45
Searching for the last scene of the most recent recording (End search)	45
Using the Shot transition	46
Playback	49

Table of Contents (Continued)

Changing/checking the settings in your camcorder	52
Changing the screen	52
Displaying recording data (Data code)	52
Displaying the settings in your camcorder (Status check)	53
Checking the remaining battery (Battery Info)	53
Locating a scene on a tape	54
Searching quickly for a desired scene (Zero set memory)	54
Searching for a scene by date of recording (Date search)	55
Searching for a recording start point (Index search)	55
Playing the picture on a TV	56

Using the Menu

<i>Using the menu items</i>	62
Menu items	64
 (CAMERA SET) menu	66
Settings to adjust your camcorder to the recording conditions (GAIN SETUP/ BACK LIGHT/STEADYSHOT, etc.)	
 (AUDIO SET) menu	73
Settings for the audio recording (DV AU.MODE/DV AUDIO MIX, etc.)	
 (DISPLAY SET) menu	74
Display settings of the display and the viewfinder (MARKER/VF B.LIGHT/DISP OUTPUT, etc.)	
 (IN/OUT REC) menu	77
Recording settings, input and output settings (VCR HDV/DV/DV REC MODE/ DV WIDE REC/ TV TYPE, etc.)	
 (MEMORY SET) menu	80
Settings for the "Memory Stick Duo" (ALL ERASE/FORMAT, etc.)	
 (OTHERS) menu	81
Settings while recording on a tape or other basic settings (QUICK REC/BEEP, etc.)	

Dubbing/Editing

Dubbing to VCR, DVD/HDD device, etc.	84
Recording pictures from a VCR	88

Using a Computer

Copying movies on a tape to a computer	91
Copying still images to a computer	93

Troubleshooting

Troubleshooting	94
Warning indicators and messages	104

Additional Information

Using your camcorder abroad	107
Maintenance and precautions	110
HDV format and recording/playback	110
About the "Memory Stick"	111
About the "InfoLITHIUM" battery pack	112
About i.LINK	113
About x.v.Color	114
About handling of your camcorder	115
Specifications	119

Quick Reference

Identifying parts and controls	123
Indicators for the LCD screen and viewfinder	128
Index	131

Spanish Quick Guide/Guía rápida en español

135

Trying out the new HDV format!

High image quality

Being HDV format compliant, your camcorder is ready to shoot crystal clear, high-definition images.

? What is the HDV format?

The HDV format is a video format for shooting and playing back high definition images on popular DV standard cassette tapes.

- **Your camcorder adopts the HDV1080i specification, which utilizes 1,080 effective scanning lines, within the HDV standards,** and records pictures at the image bit rate of about 25 Mbps.



1,080 effective scanning lines

- These operating instructions refer to the HDV1080i specification as HDV format unless there is a need to specify.

? Why shoot in the HDV format?

By moving to digital video, like the rest of the world, you will be able to capture important moments in your life in high quality digital HDV format, allowing you to relive them.

Your camcorder's down convert function converts pictures in HDV format to SD (standard definition) quality for viewing on older wide TV formats, and on 4:3 aspect ratio TVs when a high definition TV set is not available. This provides an easy path to HDV format video.

- The down convert function converts HDV format video to DV for playback or editing when your camcorder is connected to a TV or VCR that is not HDV1080i compliant. The resulting image is displayed in SD (standard definition).

Features of this camcorder

The HDV1080i specification digital HD video camera recorder has the following features to enable you to record beautiful scenery while traveling, etc., in high definition quality.

1 3-ClearVid CMOS sensor system installed

This camcorder is fitted with the 3-ClearVid CMOS sensor system. Superb spectroscopic characteristics and high definition are achieved by the use of three ClearVid CMOS sensors developed by Sony for high definition, enabling reproduction of digital high definition with excellent sensitivity and color reproducibility.

2 20 × optical zoom G Lens installed

The 20 × optical zoom G Lens enables you to zoom-in on distant objects and record in high definition quality.

3 Realistic sound recording with built-in high performance microphone

The high performance stereo microphone built into this camcorder enables highly realistic sound recording.

4 Detailed manual settings for serious filming

Extensive manual setting functions allow you to shoot high definition videos with customized settings.

- The zoom ring, focus ring and iris ring provide full manual control.
- You can manually fine-adjust the shutter speed, white balance and gain.

5 Connecting to other devices

Superb external connectability is provided by an i.LINK (HDV/DV) jack, an A/V Remote Connector (for component A/V cable, A/V connecting cable with S VIDEO and A/V connecting cable), an HDMI OUT jack, a LANC jack and a headphone jack on the rear of your camcorder, and a “Memory Stick Duo” slot on the right side.

Handy Functions for Recording

Still image Dual Rec (p. 30)

You can record 1.2M still images on the “Memory Stick Duo” during recording movie.

Smooth slow recording (p. 69)

Moving subjects can be shot in smooth moving slow-motion.

Saving Camera profile (p. 81)

Two settings profiles, including brightness, color, etc., can be saved in your camcorder. This enables you to use saved settings data to quickly reproduce suitable shooting settings.

Iris ring (p. 33)

You can adjust the brightness using the iris ring. You can select either [IRIS] or [EXPOSURE] for the brightness adjustment with the iris ring.

Viewing video recorded in the HDV format!



Viewing on a high definition TV (p. 57)

Pictures recorded in the HDV format can be played back as crisp HD (high definition) picture on a high definition TV.

- For details on HDV1080i specification compliant TVs, see page 58.



Viewing on a 16:9 TV/4:3 TV (p. 59)

Your camcorder can down convert video recorded in the HDV format to SD (standard definition) quality for playback on a conventional TV.



Dubbing to other video equipment (p. 84)

■ Connecting to an HDV1080i specification

An optional i.LINK cable allows you to copy pictures in HD (high definition) quality.

■ Connecting to HDV1080i non-compliant specification

Use your camcorder to convert HDV format video to SD (standard definition) quality to enable copying.



Connecting to a computer (p. 91)

■ Copying movie from tape to a computer

You can copy movie to a computer, and save to DVD from copying movie.

The computer will need to be set up differently depending on whether HDV or DV format video is to be copied. See page 91 for details.

Step 1: Checking supplied items

Make sure that you have following items supplied with your camcorder. The number in the parentheses indicates the number of that item supplied.

- The cassette tape and “Memory Stick Duo” are not included. See p. 6, p. 110 and p. 111 for types of cassette tapes and “Memory Stick Duo” that you can use on your camcorder.

AC Adaptor (1) (p. 18)

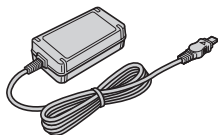

Power cord (mains lead) (1) (p. 18)



Wireless Remote Commander (1) (p. 54, 127)



A button-type lithium battery is already installed.

Component A/V cable (1) (p. 56)

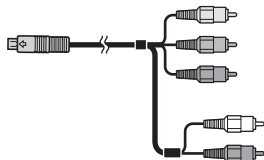

A/V connecting cable (1) (p. 56, 84)



Large eyecup (1) (p. 23)



Rechargeable battery pack NP-F570 (1) (p. 18, 112)

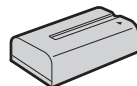

Lens hood with lens cover (1) (p. 17)
This lens hood is pre-mounted.

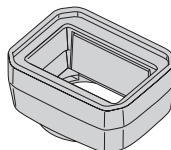

Operating Guide (This manual) (1)

Step 2: Attaching the lens hood with lens cover

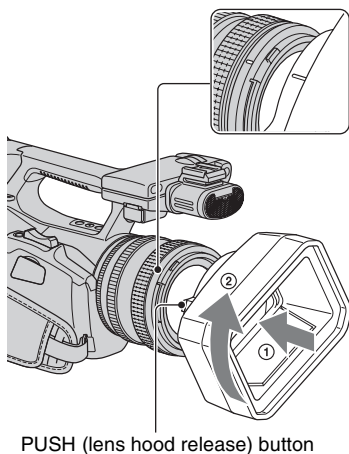

PUSH (lens hood release) button

Align the marks on the lens hood to those on the camcorder, and turn the lens hood in the direction of the arrow ②.

To remove the Lens hood with lens cover

Turn the lens hood in the opposite direction to the arrow ② in the illustration while pressing the PUSH (lens hood release) button.

Tips

- If you attach or remove a 72mm (2 7/8 in.) PL filter or MC protector, remove the lens hood with lens cover.

To open or close the shutter of the Lens hood with lens cover

Move the lens cover lever up or down to open or close the lens cover.

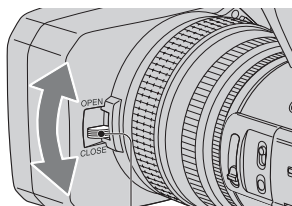

Move the lens cover lever to OPEN to open the lens cover, and move the lever to CLOSE to close the lens cover.

Step 3: Charging the battery pack

You can charge the “InfoLITHIUM” battery pack (L series) with the supplied AC Adaptor.

Notes

- You cannot use batteries other than the “InfoLITHIUM” battery pack (L series) (p. 112).

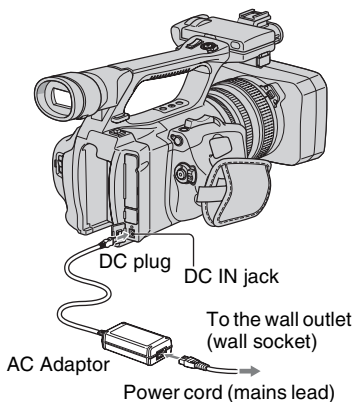

- Press the battery pack against the back of your camcorder and slide it down.

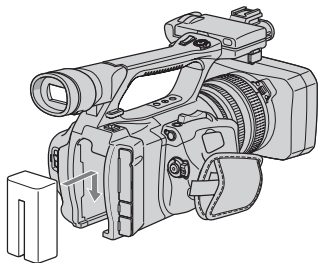

- With the ► mark on the DC plug facing outwards, connect the DC plug to the DC IN jack on your camcorder.

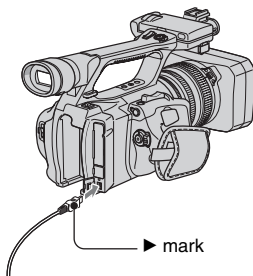

- Connect the power cord (mains lead) to the AC Adaptor.

- Connect the power cord (mains lead) to the wall outlet (wall socket).

- Set the POWER switch to OFF (CHG).

The CHG lamp lights up and charging starts.

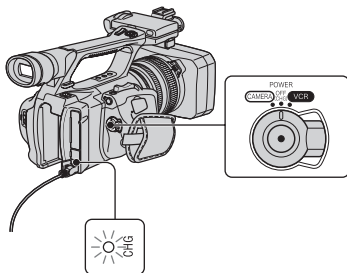

After charging the battery

The CHG lamp turns off when the battery is fully charged. Disconnect the AC Adaptor from the DC IN jack.

💡 Tips

- You can check the remaining battery life with the battery info function (p. 53)

To remove the battery pack

Set the POWER switch to OFF (CHG). Push the BATT RELEASE (battery release) button and remove the battery pack.

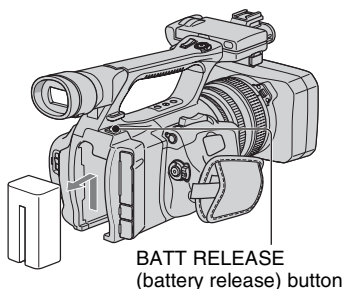

To store the battery pack

If the battery pack will not be used for a while, run down the battery and store it. See page 113 for details on storage of the battery pack.

Charging time

Approximate time (min.) required when you fully charge a fully discharged battery pack.

Battery pack	Charging time
NP-F570 (supplied)	260
NP-F770	370
NP-F970	485

Recording time

Approximate time (min.) available when you use a fully charged battery pack.

🔊 Notes

- You cannot use the NP-F330 battery pack with this camcorder.

Recording in the HDV format

Battery pack	Continuous recording time	Typical recording time*
NP-F570 (supplied)	135	65
	140	70
NP-F770	290	145
	295	145
NP-F970	430	215
	445	220

Recording in the DV format

Battery pack	Continuous recording time	Typical recording time*
NP-F570 (supplied)	145	70
	150	75
NP-F770	300	150
	310	155
NP-F970	450	225
	465	230

Top: When the LCD backlight turns on.

Bottom: Recording time when recording with the viewfinder while the LCD panel is closed.

* Typical recording time shows the time when you repeat recording start/stop, turning the power on/off and zooming.

Step 3: Charging the battery pack (Continued)

Playing time

Approximate time (min.) available when you use a fully charged battery pack.

HDV format pictures

Battery pack	LCD panel opened*	LCD panel closed
NP-F570 (supplied)	200	210
NP-F770	415	435
NP-F970	630	660

DV format pictures

Battery pack	LCD panel opened*	LCD panel closed
NP-F570 (supplied)	220	230
NP-F770	445	470
NP-F970	675	705

* When the LCD backlight turns on.

On the battery pack

- Before changing the battery pack, set the POWER switch to OFF (CHG).
- The CHG lamp flashes during charging, or Battery Info (p. 53) will not be correctly displayed under the following conditions.
 - The battery pack is not attached correctly.
 - The battery pack is damaged.
 - The battery pack is worn-out (For Battery Info only).
 - The battery pack is too cold.
Replace the battery pack, or remove it and put it in a warm place.
 - The battery pack is too hot.
Replace the battery pack, or remove it and put it in a cool place.
- The power will not be supplied from the battery as long as the AC Adaptor is connected to the DC IN jack of your camcorder, even when the power cord (mains lead) is disconnected from the wall outlet (wall socket).

On the charging/recording/playback time

- Times measured with the camcorder at 25 °C (77 °F). 10 °C to 30 °C (50 °F to 86 °F) is recommended.

- The recording and playback time will be shorter when you use your camcorder in low temperatures.
- The recording and playback time will be shorter depending on the conditions under which you use your camcorder.

Using an outside power source

You can use the AC Adaptor to obtain AC. While you are using the AC Adaptor, the battery pack will not lose its charge even when it is attached to your camcorder.

Connect your camcorder as shown in Step3:Charging the battery pack (p. 18).

On the AC Adaptor

- Use the nearby wall outlet (wall socket) when using the AC Adaptor. Disconnect the AC Adaptor from the wall outlet (wall socket) immediately if any malfunction occurs while using your camcorder.
- Do not use the AC Adaptor placed in a narrow space, such as between a wall and furniture.
- Do not short-circuit the DC plug of the AC Adaptor or battery terminal with any metallic objects. This may cause a malfunction.
- Even if your camcorder is turned off, AC power (mains) is still supplied to it while connected to the wall outlet (wall socket) via the AC Adaptor.

Step 4: Turning the power on and holding your camcorder properly

To record or play back, set the POWER switch to the respective direction. When you use your camcorder for the first time, the [CLOCK SET] screen appears (p. 24).

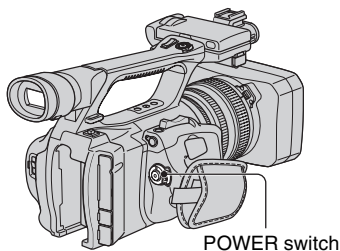

1 While pressing the green button, slide the POWER switch.

POWER
CAMERA OFF (CHG) VCR



Press and hold the green button when you slide the POWER switch from OFF (CHG).

CAMERA: To record pictures.
VCR: To play or edit pictures.

Notes

- The current date and time appear on the LCD screen for a few seconds when you turn on your camcorder once you set the date and time ([CLOCK SET], p. 24).

2 Hold the camcorder properly.

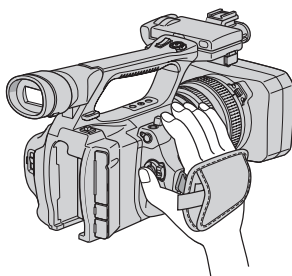

3 Ensure a good grip, then fasten the grip belt.

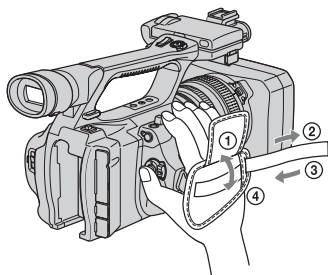

To turn off the power

Slide the POWER switch to OFF (CHG).

Notes

- If warning messages appear on the screen, follow the instructions (p. 105).

Step 5: Adjusting the LCD panel and viewfinder

The LCD panel

Open the LCD panel 180 degrees (①), then rotate it to the best angle to record or play back (②).

① Open 180 degrees.

② 90 degrees (max.)

② 180 degrees (max.)

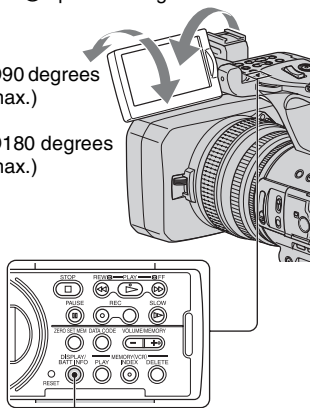

DISPLAY/BATT INFO button

💡 Tips

- You can see your mirror image on the LCD screen by setting the LCD panel facing you. The image will be recorded in a normal image.

To turn off the LCD backlight to make the battery last longer

Press and hold the DISPLAY/BATT INFO button for a few seconds until OFF appears. This setting is practical when you use your camcorder in bright conditions or when you want to save battery power. The recorded picture will not be affected by the setting. To turn on the LCD backlight, press the DISPLAY/BATT INFO button. OFF disappears.

💡 Tips

- You can adjust the brightness of the LCD screen from [LCD BRIGHT] (p. 76).

The viewfinder

You can view pictures using the viewfinder to save the battery, or when the picture on the LCD screen is not clear.

Viewfinder lens adjustment lever

Move it until the picture becomes clear.

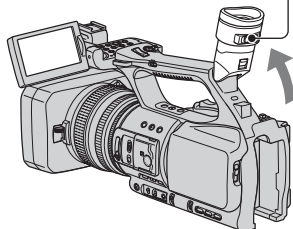
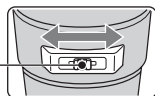

⚠ Notes

- You may see primary colors shimmering in the viewfinder when you move your eye line. This is not a malfunction. The shimmering colors will not be recorded on the recording media.

💡 Tips

- You can adjust the brightness of the viewfinder backlight from [VF B.LIGHT] (p. 76).
- To display images both on the LCD display and in the viewfinder, set [VF POWERMODE] to [ON] (p. 76).

When the picture in the viewfinder is hard to see

If you cannot see the picture in the viewfinder clearly under bright circumstances, use the supplied large eyecup. To attach the large eyecup, stretch it slightly and align it with the eyecup groove in the viewfinder. You can attach the large eyecup facing either the right or left side.

⚡ Notes

- Do not remove the pre-attached eyecup.

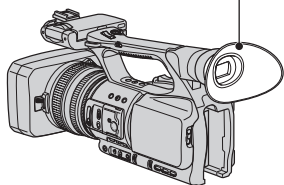
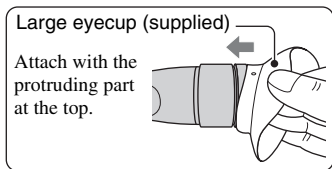

Step 6: Setting the date and time

Set the date and time when using this camcorder for the first time. If you do not set the date and time, [CLOCK SET] screen appears every time you turn on your camcorder or change the POWER switch positions.

💡 Tips

- If you do not use your camcorder for **about 3 months**, the built-in rechargeable battery gets discharged and the date and time settings may be cleared from the memory. In that case, charge the rechargeable battery and then set the date and time again (p. 117).

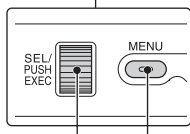
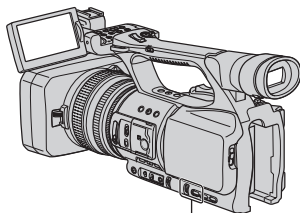

SEL/PUSH EXEC dial MENU button

Skip to step 4 when you set the clock for the first time.

1 Press the MENU button.

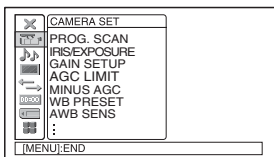

2 Select [OTHERS] by turning the SEL/PUSH EXEC dial, then press the dial.

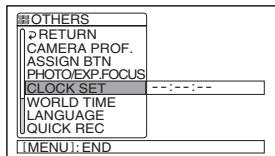

3 Select [CLOCK SET] by turning the SEL/PUSH EXEC dial, then press the dial.

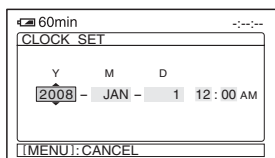

4 Set [Y] (year) by turning the SEL/PUSH EXEC dial, then press the dial.

You can set any year up to the year 2079.

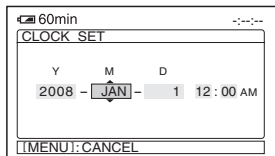

5 Set [M] (month), [D] (day), hour and minute, then press the dial.

The clock starts.

For midnight, set it to 12:00 AM.

For midday, set it to 12:00 PM.

Tips

- The date and time are automatically recorded on the tape, and can be displayed during playback (DATA CODE button, p. 52).

Changing the language setting

You can change the on-screen displays to show messages in a specified language.

Press the MENU button to select the

 (OTHERS) with the SEL/PUSH EXEC dial.

Select the screen language in [LANGUAGE] (p. 82).

Step 7: Inserting a tape or a “Memory Stick Duo”

Cassette tape

You can use mini DV **Mini DV** cassettes only (p. 110).

- 1 Slide and hold the **OPEN/EJECT** lever in the direction of the arrow and open the lid.

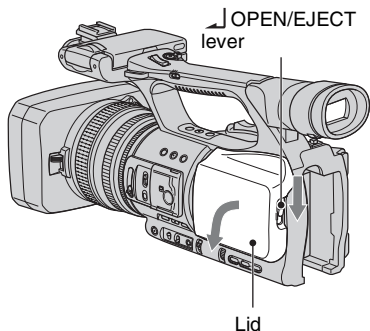

The cassette compartment automatically comes out.

- 2 Insert a cassette with its window facing outwards, then press **[PUSH]**.

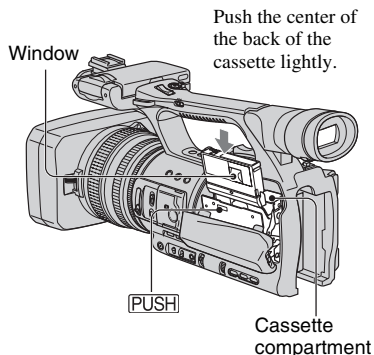

The cassette compartment automatically slides back in.

Notes

- Do not push the portion marked **[DO NOT PUSH]** while the cassette compartment is sliding in. Doing so may cause a malfunction.

- 3 Close the lid.

Tips

- The recordable time varies depending on [DV REC MODE] (p. 78). **DV**

To eject the cassette

Open the lid following the same procedure as described in step 1 and remove the cassette.

“Memory Stick Duo”

You can use only a “Memory Stick Duo” marked with **MEMORY STICK DUO**, **MEMORY STICK PRO DUO** or **MEMORY STICK PRO-HG DUO** (p. 111).

- 1 Open the “Memory Stick Duo” slot cover in the direction of the arrow.

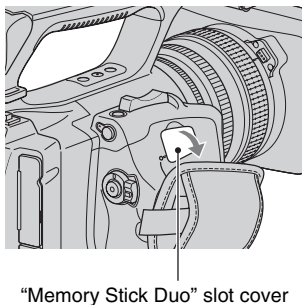

-
- 2** Insert the “Memory Stick Duo” into the “Memory Stick Duo” slot in the right direction until it clicks.

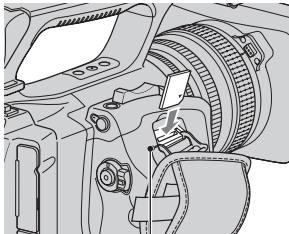

Access lamp

⚡ Notes

- If you insert the “Memory Stick Duo” into the slot in the wrong direction, the “Memory Stick Duo,” the “Memory Stick Duo” slot, or image data may be damaged.

To eject a “Memory Stick Duo”

Lightly push the “Memory Stick Duo” once.

⚡ Notes

- When the access lamp is lit or flashing, your camcorder is reading/writing data. Do not shake or knock your camcorder, turn the power off, eject the “Memory Stick Duo,” or remove the battery pack. Otherwise, image data may be damaged.
- When inserting or ejecting the “Memory Stick Duo,” be careful with the “Memory Stick Duo” from popping out and dropping.

Recording

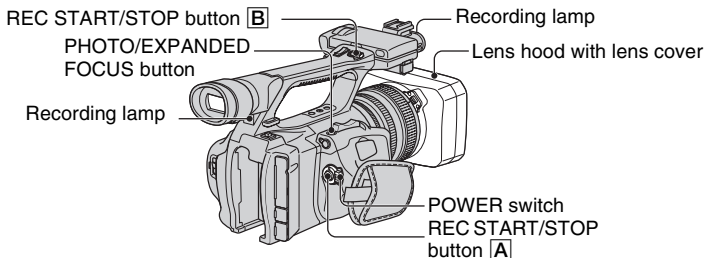

Your camcorder records movies on tape and still images on "Memory Stick Duo." Do the following steps to record movies.

💡 Tips

- This camcorder can record movies in HDV or DV format. The factory setting is HDV format ([REC FORMAT] p. 77).

1 Open the shutter of the lens hood.

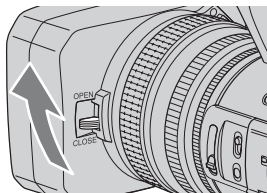

2 Slide the POWER switch to CAMERA while pressing the green button.

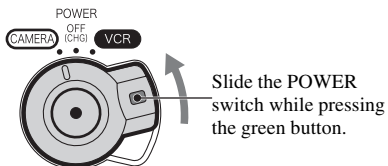

3 Press the REC START/STOP button **A** (or **B**).

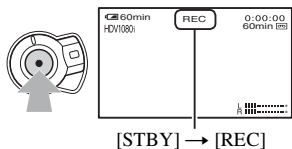

The recording lamp lights up during recording.

To stop the movie recording, press the REC START/STOP button again.

Tips

- When recording in HDV format, the aspect ratio is fixed to 16:9. When recording in DV format, you can switch the aspect ratio to 4:3 ([DV WIDE REC] p. 78).
- You can change the screen display during recording (p. 52).
- Indicators displayed on the screen during recording are shown on page 128.
- The recording lamp can be set to stay off ([REC LAMP] p. 83).
- You cannot record movies on a "Memory Stick Duo."
- For low angle recording, the REC START/STOP button on the handle is convenient. Release the HOLD lever to enable the REC START/STOP button. It might be helpful if you set the LCD panel face up or close it after turning it face down, or lift the viewfinder up during the low angle recording.

To capture still images

Press the PHOTO/EXPANDED FOCUS button or the PHOTO button on the Remote Commander.

A still image will be recorded on the “Memory Stick Duo.”  disappears when the recording is completed.

You can capture still images during movie recording.





⚙ Notes

- Specifications are for Sony “Memory Stick Duo.” The actual number of recordable pictures can vary depending on the recording environment and the type of “Memory Stick Duo.”
- You cannot store a still image under the following conditions:
 - When [PROG.SCAN] is set to [OFF] or [30] and the shutter speed is slower than 1/60
 - When [PROG.SCAN] is set to [24] and the shutter speed is slower than 1/48
 - While using the fader
 - While using smooth slow rec
 - While using shot transition

💡 Tips

- When you take a still image while not recording a movie, you will hear the shutter click.
- Image sizes of still images are as follows:
 - Recording in HDV format/DV format (16:9): 1.2 M
 - Recording in DV format (4:3): 0.9 M
 - Playing back in HDV format: 1.2 M
 - Playing back in DV format (16:9): 0.2 M
 - Playing back in DV format (4:3): VGA
- Indicators displayed on the screen during shooting are shown on page 128.
- You can set the PHOTO/EXPANDED FOCUS button to start the expanded focus function as you press the button ([PHOTO/EXP.FOCUS] p. 82).
- The unique pixel array of Sony’s ClearVid CMOS sensor and image processing system (Enhanced Imaging Processor) allows for still image resolution equivalent to the sizes described.

Capacity of the “Memory Stick Duo” (MB) and the number of recordable pictures

	1.2M 1440 × 810 	0.9M 1080 × 810 	VGA 640 × 480 	0.2M 640 × 360 
512MB	770	1000	2900	3650
1GB	1550	2100	6000	7500
2GB	3150	4300	12000	15000
4GB	6300	8500	23500	29500
8GB	12500	17000	48000	60000
16GB	25500	34500	97500	122000

To store still images captured from movies on a tape on “Memory Stick Duo”

You can capture an image in a movie and record it on a “Memory Stick Duo” as a still image. Be sure to insert a recorded tape and a “Memory Stick Duo” in your camcorder.

- ① Set the POWER switch to VCR.
- ② Press the  (play) button to search for the scene you want to save as a still image. Press the PHOTO/EXPANDED FOCUS button or the PHOTO button on your Remote Commander at the scene.

⚙ Notes

- The recorded date and time on the tape and the stored date and time on the “Memory Stick Duo” are both saved on the “Memory Stick Duo.” When you view the still images, only the recorded date and time on the tape will be displayed on the screen (Data code, p. 52).
- Camera data stored on the tape will not be copied to the “Memory Stick Duo.”
- You cannot store a still image during using your camcorder with [PB ZOOM] set to [ON] (p. 82).

Changing the settings of your camcorder recordings

Adjusting the zoom

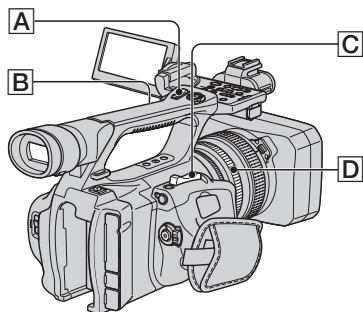

Move the power zoom lever **C** slightly for a slower zoom. Move it further for a faster zoom.

Wide view: (Wide angle)

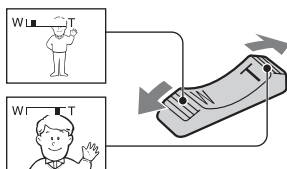

Close view: (Telephoto)

💡 Tips

- The minimum distance required between your camcorder and the subject for focus is about 1 cm (about 13/32 in.) for wide angle and about 80 cm (about 2 5/8 feet) for telephoto.
- The focus may not be adjusted at certain zoom positions if the subject is within 80 cm (about 2 5/8 feet) from your camcorder.
- Be sure to keep your finger on the power zoom lever **C**. If you move your finger off the power zoom lever **C**, the operation sound of the power zoom lever **C** may also be recorded.

Using the handle zoom

- ① Set the handle zoom switch **B** to VAR or FIX.

💡 Tips

- When you set the handle zoom switch **B** to VAR, you can zoom in or out at variable speed.
- When you set the handle zoom switch **B** to FIX, you can zoom in or out at fixed speed set in [HANDLE ZOOM] (p. 69).

- ② Press the handle zoom lever **A** to zoom in or out.

⚠ Notes

- You cannot use the handle zoom lever **A** when the handle zoom switch **B** is set to OFF.
- You cannot change the zoom speed of the zoom lever **C** with the handle zoom switch **B**.

Using the zoom ring

You can zoom at the desired speed by turning the zoom ring **D**. Fine adjustment is also possible.

⚠ Notes

- Turn the zoom ring **D** at a moderate speed. If you turn it too fast, the zoom speed may lag behind the zoom ring rotation speed, or the operation sound of the zoom may also be recorded.

Adjusting the focus manually

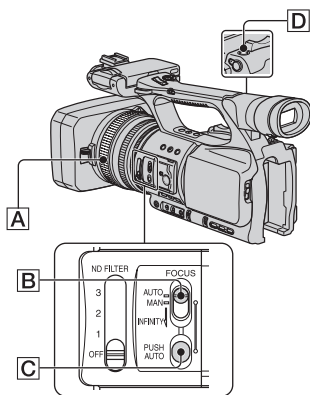

You can adjust the focus manually for different recording conditions. Use this function in the following cases.

- To record a subject behind a window covered with raindrops.
- To record horizontal stripes.
- To record a subject with little contrast between the subject and its background.
- When you want to focus on a subject in the background.

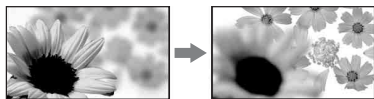

- To record a stationary subject using a tripod.

1 During recording or standby, set the FOCUS switch [B] to MAN.

☞ appears.

2 Rotate the focus ring [A] and adjust the focus.

☞ changes to ▲ when the focus cannot be adjusted any farther. ☞ changes to ■ when the focus cannot be adjusted any closer.

💡 Tips

For focusing manually

- It is easier to focus on the subject when you use the zoom function. Move the power zoom lever towards T (telephoto) to adjust the focus, and then, towards W (wide angle) to adjust the zoom for recording.
- When you want to record a close-up image of a subject, move the power zoom lever towards W (wide angle) to fully magnify the image, then adjust the focus.

To restore automatic adjustment

Set the FOCUS switch [B] to AUTO.

☞ disappears and the automatic focus adjustment is restored.

Using automatic focus temporarily (Push auto focus)

Record the subject while pressing and holding the PUSH AUTO button [C].

If you release the button, the setting returns to manual focusing.

Use this function to shift the focus on one subject to another. The scenes will shift smoothly.

💡 Tips

- The focal distance information (for when it is dark and hard to adjust the focus) appears for about 3 seconds in the following cases. (It will not be displayed correctly if you are using a conversion lens (optional)).
 - When you set the FOCUS switch to MAN and ☞ appears on the screen
 - When you rotate the focus ring while ☞ is displayed on the screen.

Using the expanded focus (Expanded focus)

Assign [EXP.FOCUS] to the PHOTO/EXPANDED FOCUS button **D** beforehand ([PHOTO/EXP.FOCUS], p. 82).

During standby, press the PHOTO/EXPANDED FOCUS button **D**. [EXPANDED FOCUS] appears and the center of the screen is magnified by about 2.0 times. It will be easier to confirm the focus setting during manual focusing. The screen returns to the original size when you push the button again.

Notes

- The image returns to the original size when you press the REC START/STOP button or the PHOTO/EXPANDED FOCUS button **D**.

Tips

- You can select a type of an expanded image displayed during the expanded focus ([EXP.FOCUS TYPE] p. 75).
- You can assign [EXP.FOCUS] to any one of the ASSIGN buttons (p. 44).

Focusing on a distant subject (Focus infinity)

Slide the focus switch to INFINITY and hold it there.

▲ appears.

To return to manual focus mode, release the FOCUS switch.

Use this function to record a distant subject when the focus is automatically set on a close subject.

Notes

- This function is only available during the manual focus.

Adjusting the image brightness

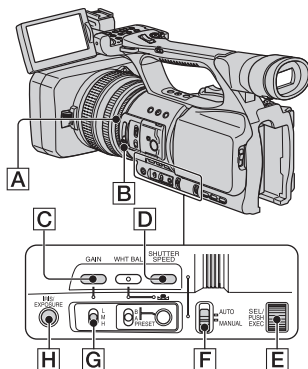

You can adjust the image brightness by adjusting the iris, the gain or the shutter speed or by reducing the light volume with the ND filter **B**. Also, when [EXPOSURE] is assigned to the iris ring, you can adjust the iris, gain and shutter speed with the iris ring **A**. You can assign [IRIS] or [EXPOSURE] to the iris ring **A** from [IRIS/EXPOSURE] of the (CAMERA SET) menu (p. 66). The default setting is [IRIS] .

Notes





- You cannot use the back light function and the spotlight function if at least two of iris, gain and shutter speed are adjusted manually.
- [AE SHIFT] is not effective while you adjust the iris, gain and shutter speed all manually.

Adjusting the iris

You can manually adjust the iris to control the volume of the light entering the lens. By adjusting the iris, you can change or close the aperture of the lens, which is expressed as an F value between F1.6 and F11. The volume of the light increases the more that you open the aperture (decreasing F value). The volume of the light decreases the more that you close the aperture (increasing F

Changing the settings of your camcorder recordings (Continued)

value). The current F value appears on the screen.

- ① Select [IRIS] from  (CAMERA SET) menu → [IRIS/EXPOSURE] → [RING ASSIGN] (p. 66).
- ② During recording or standby, set the AUTO/MANUAL switch  to MANUAL.
- ③ When the iris is automatically adjusted, press the IRIS/EXPOSURE button .  next to the iris value disappears (p. 75), or the iris value appears on the screen.
- ④ Adjust the iris by turning the iris ring .

Tips

- The F value becomes close to F3.4 as the zoom position changes from W to T even when you open the aperture by setting the F value lower than F3.4, such as F1.6.
- The range of focus, an important effect of the aperture, is called the depth of field. The depth of field gets shallower as the aperture is opened, and deeper as the aperture is closed. Use the aperture creatively to obtain the desired effect in your photography.
- This is handy for making the background blurred or sharp on the screen.

To restore automatic adjustment

Press the IRIS/EXPOSURE button , or set the AUTO/MANUAL switch  to AUTO.

The iris value disappears, or  appears next to the iris value.











Notes

- When you set the AUTO/MANUAL switch  to AUTO, other manually adjusted items (gain, shutter speed, white balance) also become automatic.

Adjusting the exposure



When [IRIS/EXPOSURE] is set to [EXPOSURE], you can adjust the image brightness by adjusting the iris, gain and shutter speed with the iris ring. You can

also manually preset one or two of these parameters and adjust the remaining parameter(s) with the iris ring.

- ① Select [EXPOSURE] from  (CAMERA SET) menu → [IRIS/EXPOSURE] → [RING ASSIGN] (p. 66).
- ② During recording or standby, set the AUTO/MANUAL switch  to MANUAL.
- ③ When [EXPOSURE] is automatically adjusted, press the IRIS/EXPOSURE button .  appears on the screen next to the automatically adjusted items (iris, gain and shutter speed), indicating that you can adjust them with the iris ring . Manually adjusted items do not change even when you turn the iris ring. When  is not displayed, do the following operation.  appears next to the items, indicating that you can adjust them with the iris ring .
 - Gain
Press the GAIN button .
 - Shutter speed
Press the SHUTTER SPEED button  twice. When the shutter speed is not locked, press the button once.
- ④ Adjust the image brightness by turning the iris ring .

To restore automatic adjustment

Press the IRIS/EXPOSURE button , or set the AUTO/MANUAL switch  to AUTO.

The values next to which  is displayed disappear, or  appears next to those values.

Notes

- When you set the AUTO/MANUAL switch  to AUTO, all manually adjusted items (iris, gain, shutter speed and white balance) also become automatic.

Tips

- When you press the GAIN button **[C]** while **[E]** is displayed on the screen next to the gain value, **[E]** disappears and you can adjust the gain manually. When you press the GAIN button **[C]** again, **[E]** appears and you can adjust the gain with the iris ring. See step ③ in “Adjusting the gain” on page 35 for details on how to adjust the gain.
- When you press the SHUTTER SPEED button **[D]** while **[E]** is displayed on the screen next to the shutter speed value, **[E]** disappears and you can adjust the shutter speed manually. When you press the SHUTTER SPEED button **[D]** again, **[E]** appears and you can adjust the shutter speed with the iris ring. See steps ③ to ④ in “Adjusting the shutter speed” on page 35 for details on how to adjust the shutter speed.

Adjusting the gain

You can adjust the gain manually when you do not want to use the AGC (automatic gain control).

- ① Set the AUTO/MANUAL switch **[F]** to MANUAL during recording or standby.
- ② When the gain is automatically adjusted, press the GAIN button **[C]**. The gain value appear on the screen, or **[A]** next to the gain value disappears.
- ③ Set the gain switch **[G]** to H, M or L. The gain value set for the selected gain switch position appears on the screen. You can set the gain value for each gain switch position from [GAIN SETUP] of the  (CAMERA SET) menu (p. 66).

Tips

- When you record a movie with the gain set to [-6dB] and play it back with the data code, the gain value is displayed as [---].

To adjust the gain automatically

Press the GAIN button **[C]**, or set the AUTO/MANUAL switch **[F]** to AUTO. The gain value disappears, or **[A]** appears next to the gain value.

Notes

- When you set the AUTO/MANUAL switch **[F]** to AUTO, other manually adjusted items (iris, shutter speed, white balance) also become automatic.

Adjusting the shutter speed

You can manually adjust and fix the shutter speed. You can make a moving subject look still or emphasize the movement of a moving subject by adjusting the shutter speed.

- ① During recording or standby, set the AUTO/MANUAL switch **[F]** to MANUAL.
- ② Press the SHUTTER SPEED button **[D]** until the shutter speed value is highlighted.
- ③ Change the shutter speed displayed on the screen by turning the SEL/PUSH EXEC dial **[E]**. You can set a shutter speed between 1/4 second and 1/10000 second. The selected shutter speed appears on the screen. For example, if you select 1/100 second, [100] appears. The larger the number that appears on the screen, the faster the shutter speed.
- ④ Press the SEL/PUSH EXEC dial **[E]** to lock the shutter speed. To readjust the shutter speed, do steps ② to ④.

Tips

- You can set the shutter speed between 1/3 second and 1/10000 second in the following settings:
 - When [PROG.SCAN] of the  (CAMERA SET) menu is set to [24]
- It is difficult to focus automatically at a lower shutter speed. Manual focusing with your camcorder attached to a tripod is recommended.
- The picture may flicker or change colors under fluorescent lamps, sodium lamps, or mercury lamps.

To adjust the shutter speed automatically

Press the SHUTTER SPEED button **D** twice, or set the AUTO/MANUAL switch **F** to AUTO.

The shutter speed value disappears, or **A** appears next to the shutter speed value.

Notes

- When you set the AUTO/MANUAL switch **F** to AUTO, other manually adjusted items (iris, gain, white balance) also become automatic.

Adjusting the volume of light (ND filter)

You can record the subject clearly by using the ND filter **B** when the recording environment is too bright.

There are 3 levels of ND filter setting. ND filter 1 reduces the volume of light to about 1/4, ND filter 2 to about 1/16 and ND filter 3 to about 1/64.

If $ND\frac{1}{4}$ flashes during the iris automatic adjustment, set the ND filter to 1. If $ND\frac{2}{16}$ flashes during the iris automatic adjustment, set the ND filter to 2. If $ND\frac{3}{64}$ flashes during the iris automatic adjustment, set the ND filter to 3.

The ND filter indicator will stop flashing and remain on the screen.

If $ND\frac{OFF}{CLR}$ flashes, set the ND filter to OFF. $ND\frac{OFF}{CLR}$ will disappear from the screen.

Notes

- If you move the ND filters **B** during recording, the picture and sound may be distorted.
- When adjusting the iris manually, the ND filter indicator does not flash even if the light volume should be adjusted with the ND filter.

Tips

- While recording a bright subject, diffraction may occur if you close the aperture further down, resulting in a fuzzy focus (this is a common phenomenon with video cameras). The ND filter **B** suppresses this phenomenon and gives better recording results.

Adjusting to Natural Color (White balance)

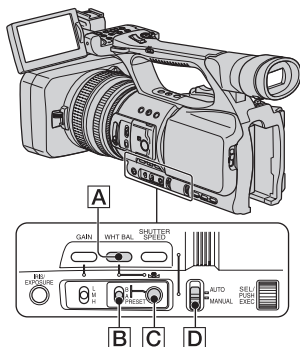





You can adjust and fix the white balance according to the lighting conditions of recording environment. You can store white balance values in memory A (A) and memory B (B), respectively. Unless a white balance is readjusted, values will remain even after the power has been turned off.

When you select PRESET, either [OUTDOOR] or [INDOOR] is selected, according to which one you previously set with [WB PRESET] in the (CAMERA SET) menu.









1 During recording or standby, set the AUTO/MANUAL switch **D** to MANUAL.

2 Press the WHT BAL button **A**.



3 Set the white balance memory switch **B** to any one of PRESET/A/B.

Indicator	Shooting conditions
 A (Memory A)	<ul style="list-style-type: none"> White balance values adjusted for light sources can be stored in memory A and memory B. Follow the steps in "To save the adjusted white balance value in memory A or B" (p. 37).
 B (Memory B)	
 Outdoor ((OUTDOOR))	<ul style="list-style-type: none"> Recording neon signs or fireworks Recording sunset/sunrise, just after sunset or just before sunrise Under daylight color fluorescent lamps
 Indoor ((INDOOR))	<ul style="list-style-type: none"> Under the lighting conditions that change in many ways, such as a party hall Under strong light such as in a photography studio Under sodium lamps or mercury lamps

To save the adjusted white balance value in memory A or B

- Set the white balance memory switch to A ( A) or B ( B) in step 3 of "Adjusting to natural color (White balance)."
- Capture a white subject, such as white paper, full-screen in the same lighting condition as the one in which the subject is.
- Press  (one push) button .  A or  B starts flashing rapidly. It will stay on when the white balance adjustment is completed and the adjusted value is stored in  A or  B.

To adjust the white balance automatically

Press the WHT BAL button  or set the AUTO/MANUAL switch  to AUTO.

Notes

- When you set the AUTO/MANUAL switch  to AUTO, other manual adjustments (iris, gain, shutter speed) also become automatic.

Customizing the picture quality (Picture profile)

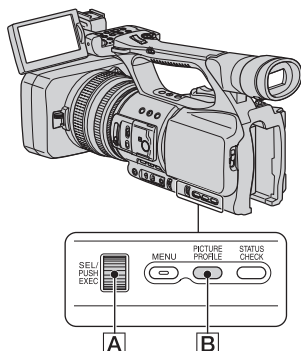

You can customize the picture quality by adjusting picture profile items such as [COLOR LEVEL] and [SHARPNESS]. Connect your camcorder to a TV or monitor, and adjust the picture quality while observing the picture on the TV or monitor screen.

Picture quality settings for different recording conditions are stored in [PP1] through [PP6] as default settings.

Notes

- When you set [x.v.Color] of the  (CAMERA SET) menu to [ON], the picture profile will be disabled.

Changing the settings of your camcorder recordings (Continued)

Picture profile number (setting name)	Recording condition
PP1 :USER	You can assign your own setting
PP2 :USER	You can assign your own setting.
PP3 :PORTRAIT	Appropriate setting to record people
PP4 :CINEMA	Appropriate setting to record film-like pictures
PP5 :SUNSET	Appropriate setting to record sunset
PP6 :MONOTONE	Appropriate setting to record monotone pictures

1 During standby, press the **PICTURE PROFILE** button **[B]**.

2 Select a picture profile number with the **SEL/PUSH EXEC** dial **[A]**.

You can select the items from [PP1] to [PP6].

You can record with the settings of the selected picture profile.

3 Select **[OK]** with the **SEL/PUSH EXEC** dial **[A]**.

To cancel the picture profile recording

Select **[OFF]** in step **2** with the **SEL/PUSH EXEC** dial **[A]**.

To change the picture profile

You can change the settings stored in [PP1] through [PP6].

- ① Press the **PICTURE PROFILE** button **[B]**.
- ② Select the **PICTURE PROFILE** number with the **SEL/PUSH EXEC** dial **[A]**.
- ③ Select **[SETTING]** with the **SEL/PUSH EXEC** dial **[A]**.
- ④ Select an item to be adjusted with the **SEL/PUSH EXEC** dial **[A]**.
- ⑤ Adjust the picture quality with the **SEL/PUSH EXEC** dial **[A]**.
- ⑥ Repeat steps ④ and ⑤ to adjust other items.
- ⑦ Select **[↵ RETURN]** with the **SEL/PUSH EXEC** dial **[A]**.
- ⑧ Select **[OK]** with the **SEL/PUSH EXEC** dial **[A]**.
A picture profile indicator appears.

GAMMA

To select a gamma curve.

Item	Description and settings
[STANDARD]	Standard gamma curve
[CINEMATONE1]	Gamma curve 1 for producing tone of film camera images
[CINEMATONE2]	Gamma curve 2 for producing tone of film camera images

BLK COMPNSTN

To select a gamma curve characteristic for dark areas.

Item	Description and settings
[OFF]	Normal setting
[STRETCH]	Improves gamma curve characteristics and enhances gradation in dark areas.
[COMPRESS]	Controls gamma curve characteristics to produce solid black.

KNEE POINT

To set the point at which video signal compression starts in order to prevent over-highlighting, by limiting signals in high contrast areas of the subject to the dynamic range of your camcorder.

Item	Description and settings
[AUTO]	Automatically sets the knee point.
[HIGH]	Knee point: 100%
[MIDDLE]	Knee point: 95%
[LOW]	Knee point: 80%

COLOR MODE

To set type of colors.

Item	Description and settings
[STANDARD]	Standard colors
[CINEMATONE1]	Film camera image-like colors good with [GAMMA] set to [CINEMATONE1]
[CINEMATONE2]	Film camera image-like colors good with [GAMMA] set to [CINEMATONE2]

COLOR LEVEL

To set the color level.

Item	Description and settings
	-7 (light) to +7 (dark), -8: black and white

Changing the settings of your camcorder recordings (Continued)

COLOR PHASE

To set the color phase.

Item	Description and settings
	-7 (greenish) to +7 (reddish)

COLOR DEPTH

To set the color depth.

This function is more effective for chromatic colors and less effective for achromatic colors. The color looks deeper as you increase the setting value to more positive side, and lighter as you decrease the value to more negative side. This function is effective even if you set [COLOR LEVEL] to [-8] (monotone).

Item	Description and settings
	-7 (shallow) to +7 (deep)

WB SHIFT

To set items for the white balance shift.

Item	Description and settings
	-9 (bluish) to +9 (reddish)

SHARPNESS

To adjust the definition of a subject.

Item	Description and settings
	-7 (soft) to +7 (clear)

SKINTONE DTL

To adjust the detail of skintone areas to reduce wrinkles.

Item	Description and settings
[ON/OFF]	Suppresses details in skin-tone areas to reduce wrinkles. Select [ON] when you want to use this function. You can also select other areas.
[LEVEL]	Sets the adjustment level. 1 (less adjust the detail) to 8 (more adjust the detail)
[COLOR SEL]	Sets color items for the detail adjustment. [RANGE] : Sets the color range. 0 (selects no color), 1 (narrow: selects a single color) to 31 (wide: selects multiple colors in similar color phases and saturation) The detail will not be adjusted when you set [RANGE] to 0. [ONE PUSH SET]: Automatically selects target colors for a subject at the center or the marker. [RANGE] will not be changed.

PROFILE NAME

To name the picture profiles set in [PP1] through [PP6] (p. 42).

COPY

To copy the settings of the picture profile to another picture profile number.

RESET

To reset the picture profile to the default setting.

Changing the settings of your camcorder recordings (Continued)

To name the picture profile settings

You can name picture profile 1 through 6.

- 1 Press the PICTURE PROFILE button **[B]**.
- 2 Select the picture profile that you want to name with the SEL/PUSH EXEC dial **[A]**.
- 3 Select [SETTING] → [PROFILE NAME] with the SEL/PUSH EXEC dial **[A]**.
- 4 Select a letter with the SEL/PUSH EXEC dial **[A]**. Repeat this operation until a complete name is entered.

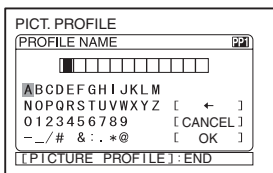

Tips

- Each name can be up to 12 characters long. Characters that can be used in profile names:

- A to Z
- 0 to 9
- - _ / # & : . * @

- 5 Select [OK] with the SEL/PUSH EXEC dial **[A]**. The profile name is changed.
- 6 Select [↶ RETURN] → [OK] with the SEL/PUSH EXEC dial **[A]**.

To copy the picture profile setting to other picture profiles

- 1 Press the PICTURE PROFILE button **[B]**.
- 2 Select the picture profile that you want to copy from with the SEL/PUSH EXEC dial **[A]**.
- 3 Select [SETTING] → [COPY] with SEL/PUSH EXEC dial **[A]**.

- 4 Select the number of the picture profile that you want to copy to with the SEL/PUSH EXEC dial **[A]**.
- 5 Select [YES] with the SEL/PUSH EXEC dial **[A]**.
- 6 Select [↶ RETURN] → [OK] with the SEL/PUSH EXEC dial **[A]**.

To reset the picture profile settings

You can reset the picture profile settings by each picture profile number. You cannot reset all picture profile settings at once.

- 1 Press the PICTURE PROFILE button **[B]**.
- 2 Select the number of the picture profile that you want to reset with the SEL/PUSH EXEC dial **[A]**.
- 3 Select [SETTING] → [RESET] → [YES] → [↶ RETURN] → [OK] with the SEL/PUSH EXEC dial **[A]**.

Adjusting the volume

You can adjust the volume of the stereo internal microphone or an external microphone connected to the MIC jack.

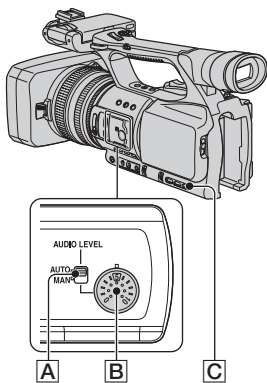

1 Set the **AUDIO LEVEL** switch **A** of the channel to be adjusted to **MAN**.

 appears on the screen.

2 Turn the **AUDIO LEVEL** dial **B** to adjust the volume during recording or standby.

To restore automatic adjustment

Set the **AUDIO LEVEL** switch **A** to **AUTO**.

Tips

- To check other audio settings, press the **STATUS CHECK** button **C**. You can also check microphone audio levels.
- For other settings, see the  (**AUDIO SET**) menu (p. 73).

Assigning the functions to the ASSIGN buttons

Some functions need to be assigned to the ASSIGN buttons for use. You can assign a single function to any one of the ASSIGN 1 to 6 buttons.

Functions you can assign to the ASSIGN buttons

The buttons in parentheses indicate that the functions are assigned to the buttons by default.

- EXP.FOCUS (p. 82)
- D.EXTENDER (p. 69)
- RING ROTATE (p. 66)
- AE SHIFT (p. 67) (ASSIGN 2 button)
- INDEX MARK (p. 45)
- STEADYSHOT (p. 68)
- BACK LIGHT (p. 68)
- SPOTLIGHT (p. 68)
- FADER (p. 69)
- SMTH SLW REC (p. 69)
- COLOR BAR (p. 72)
- REC REVIEW (p. 45) (ASSIGN 3 button)
- END SEARCH (p. 45)
- ZEBRA (p. 74) (ASSIGN 1 button)
- MARKER (p. 75)
- PEAKING (p. 74)
- Picture profile (p. 37)
- SHOT TRANSITION (p. 46)

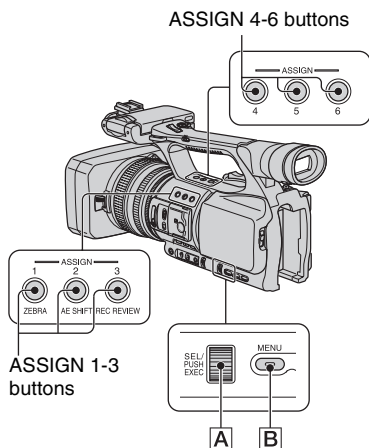

1 Press the MENU button **[B]**.

2 Select the  (OTHERS) → [ASSIGN BTN] with the SEL/PUSH EXEC dial **[A]**.

3 Select the ASSIGN button to which you want to assign a function from [ASSIGN1] to [ASSIGN6] with the SEL/PUSH EXEC dial **[A]**.

- [-----] appears if no function is assigned to the ASSIGN button.
- Select [YES] when you select [SHOT TRANSITION], then do step 6.

4 Select the function that you want to assign with the SEL/PUSH EXEC dial **[A]**.

5 Select [OK] with the SEL/PUSH EXEC dial **[A]**.

6 Press the MENU button **[B]** to hide the menu screen.

Tips

- Shot transition is assigned to the ASSIGN 4, 5 and 6 buttons (p. 46). Cancel the shot transition assignment to return to the pre-setting assignment.
- To cancel the shot transition, select [SHOT TRANSITION] → [YES] in step **3**.

Recording an index signal

If you record a scene with an index signal, you can easily find that scene during playback (p. 55).

The index function will make it easier to check the transition of recording or edit your pictures using index signals.

1 Assign [INDEX MARK] to one of the ASSIGN buttons (p. 44).

2 Press the ASSIGN button to which [INDEX MARK] is assigned.
During recording

 appears for about 7 seconds and an index signal is recorded.

During standby

 flashes.

After you press the REC START/STOP button to start recording,  appears for about 7 seconds and an index signal is recorded.

To cancel the operation

Press the ASSIGN button to which [INDEX MARK] is assigned again before you start recording.

Notes

- You cannot record an index signal on a recorded tape afterward.

Reviewing the most recently recorded scenes (Rec review)

You can view about 2 seconds of the scene recorded just before you stopped the tape. This is convenient during playback of the latest scene check.

1 Assign [REC REVIEW] to one of the ASSIGN buttons. (p. 44).

2 Press the ASSIGN button to which [REC REVIEW] is assigned during standby.

The last 2 seconds (approx.) of the most recently recorded scene will be played back, then your camcorder returns to standby.

Searching for the last scene of the most recent recording (End search)

1 Assign [END SEARCH] to one of the ASSIGN buttons (p. 44).

2 Press the ASSIGN button to which [END SEARCH] is assigned.

The last scene of the most recent recording will be played back for about 5 seconds, and the camcorder goes the standby at the point where the last recording has finished.

Notes

- End search will not work once you eject the tape.
- End search will not work correctly if a blank section exists between recorded sections on the tape.

Using the Shot transition

You can store settings of focus, zoom, iris, gain, shutter speed and white balance, and smoothly shift from the current settings to the stored settings (shot transition).

For example, you can shift the focus from closer objects to farther objects, or change the depth of field by adjusting the iris. You can also develop scenes under different conditions smoothly. If you store manually adjusted settings of white balance, you can smoothly shift from one scene to another under different conditions, such as from indoor to outdoor.

Sony recommends that you use a tripod to avoid image blurring.



You can set the transition curve and duration using [SHOT TRANSITION] (p. 71).

ASSIGN 4-6 buttons

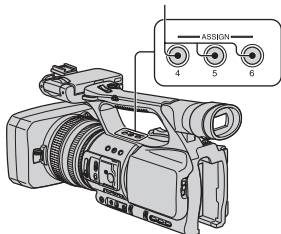

1 Assign [SHOT TRANSITION] to the ASSIGN buttons (p. 44).

Tips

- Shot transition is assigned to ASSIGN 4, 5 and 6 buttons.

2 Store the settings (shot)

- Press the ASSIGN 4 button repeatedly to bring up the SHOT TRANSITION STORE screen.

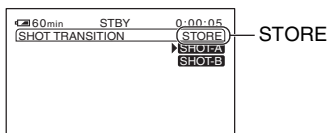

- Adjust the desired items manually.
See pages 31 to 37 for details on adjustment.
- Press the ASSIGN 5 button for storing the setting in SHOT-A, or the ASSIGN 6 button for storing the setting in SHOT-B.

Notes

- The setting values assigned to SHOT-A and SHOT-B are deleted when the POWER switch is turned to OFF (CHG).

3 Check the stored settings

- Press the ASSIGN 4 button repeatedly to bring up the SHOT TRANSITION CHECK screen.

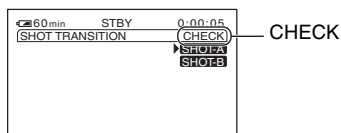

- Press the ASSIGN 5 button to check the SHOT-A. Press the ASSIGN 6 button to check the SHOT-B.
The selected setting will take effect on the picture on the screen. The focus, zoom, and so on, are automatically adjusted as stored in the setting.

Notes

- On the shot transition check screen, the settings do not shift to the stored settings of the transition time and curve set in [TRANS TIME] and [TRANS CURVE] (p. 71)

4 Record using the shot transition function

- Press the ASSIGN 4 button repeatedly to bring up the SHOT TRANSITION EXEC screen.

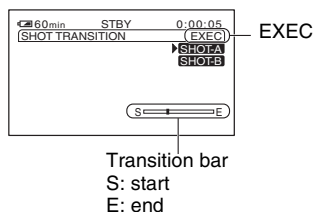

- Press the REC START/STOP button.
- Press the ASSIGN 5 button for recording with SHOT-A, or the ASSIGN 6 button for recording with SHOT-B.

The settings shift from the current ones to the stored ones.

Tips

- Press the ASSIGN 4 button repeatedly to cancel the SHOT TRANSITION.

Notes

- You cannot zoom, focus, or adjust manually while checking or activating the Shot transition.
- When you change [SHOT TRANSITION] (p. 71), press the ASSIGN 4 button repeatedly to exit the shot transition screen.
- You cannot return from the stored SHOT-A or SHOT-B settings to previous settings after you execute the shot transition during recording.
- If you press the following buttons during the shot transition operation, the operation will be canceled:
 - PICTURE PROFILE button
 - MENU button
 - The PHOTO/EXPANDED FOCUS button or ASSIGN button to which [EXP.FOCUS] is assigned.
 - STATUS CHECK button

Assigning the functions to the ASSIGN buttons (Continued)

- The ASSIGN button to which [SMTH SLW REC] is assigned.

Tips

- You can also make a transition from the SHOT-A to saved SHOT-B or from the SHOT-B to the SHOT-A. For example, to make a transition from the SHOT-A to the SHOT-B, display the shot transition check screen, press the ASSIGN 5 button to bring up the SHOT-A and press the REC START/STOP button. Then, display the shot transition execution screen and press the ASSIGN 6 button.
- You can rehearse the shot transition by pressing the ASSIGN button (5 or 6), to which your customized setting are assigned, before pressing the REC START/STOP button in step 4.

To cancel the operation

Press the ASSIGN 4 button repeatedly to exit the shot transition screen.

Playback

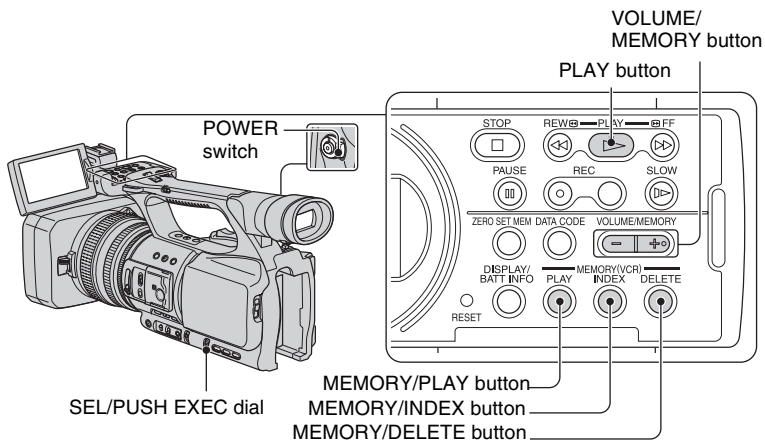

You can play back movies as follows.

- 1** Slide the **POWER** switch to **VCR** while pressing the **green** button.

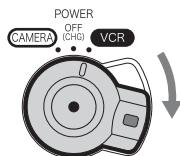

- 2** **Start playing back.**

Press ◀◀ (rewind) to go to the point you want to view, then press ▶▶ (play) to start playback.

- : STOP
- || : PAUSE (Press ▶▶ or || again to restart the playback)
- ◀◀ : REW ◀◀ (Rewind, review)
- ▶▶ : ▶▶ FF (Cue, fast forward)
- ▶▶ : SLOW

🔊 Notes

- Your camcorder automatically goes into a stopped state when it is in pause for more than 3 minutes.
- The screen may temporarily go blank losing images and sound when signals switch between HDV and DV during playback of a tape in which HDV format and DV format are mixed.
- You cannot play back movies recorded in HDV format on DV format video cameras or mini DV players.

Playback (Continued)

Tips

- See page 130 for indicators displayed on the screen during playback.
- See page 52 for how to switch displays during playback.
- To play back the tape recorded using a monaural microphone connected, see [MULTI-SOUND] (p. 73).
- To reset the tape counter, press the ZERO SET MEM button. You can also use the ZERO SET MEMORY button on the Remote Commander (p. 54).

To search for a scene while viewing a movie

Press and hold ◀◀/▶▶ during playback (Picture Search). To view during fast forward, press and hold ▶▶. To view during rewind, press and hold ◀◀ (Skip Scan).

To adjust the volume

Adjust the volume with the VOLUME/MEMORY button.

To view still images

- ① Set the POWER switch to VCR.
- ② Press the MEMORY/PLAY button.
- ③ Select still image that you want to view using the VOLUME/MEMORY button.
To stop viewing still images, press the MEMORY/PLAY button again.

To display the list of still images (index screen)

- ① Set the POWER switch to VCR.
- ② Press the MEMORY/INDEX button.

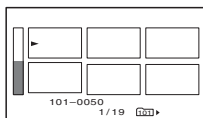

- ③ Select a still image using the VOLUME/MEMORY button.
To display a single image, move ▶ to that image and press the MEMORY/PLAY button.
To stop displaying the list of still images, press the MEMORY/INDEX button again.



To delete still images from the “Memory Stick Duo”

- ① Do the steps of “To view still images” to display still images that you want to delete.
- ② Press the MEMORY/DELETE button.
- ③ Select [YES] with the SEL/PUSH EXEC dial.
The still image will be deleted.

🔔 Notes

- Still images cannot be restored once you delete them.
- You cannot delete still images when the “Memory Stick Duo” is write-protected (p. 111) or the still image is protected (p. 96).

💡 Tips

- To delete a still image in the index, move ▶ to the still image using the VOLUME/MEMORY button, then do steps ② and ③.
- To delete all still images, do [ ALL ERASE] of the  (MEMORY SET) menu (p. 80).

Changing/checking the settings in your camcorder

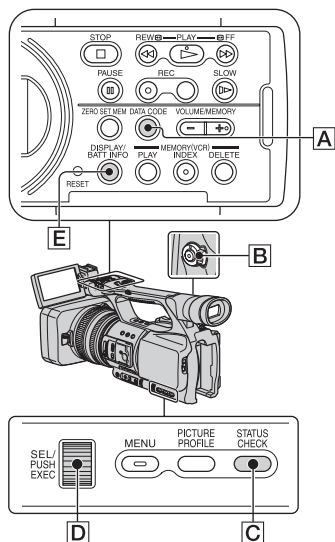

Changing the screen

You can turn on and off the display of the time code, tape counter, and other information on the screen.

Press the DISPLAY/BATT INFO button **E**.

The screen indicators turn on (displayed) and off (undisplayed) as you press the button.

Tips

- You can display the screen indicators during playback on a TV. Select [V-OUT/PANEL] or [ALL OUTPUT] of [DISP OUTPUT] (p. 77).

Displaying recording data (Data code)

You can display information, including date, time and camera data, automatically stored during recording on the screen during playback.

1 Set the POWER switch **B** to VCR.

2 Press the DATA CODE button **A** during playback or pause.

The screen changes (date and time display → camera data display → no display) as you press the button.

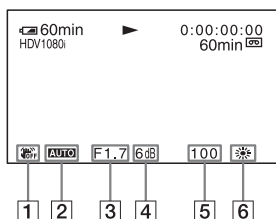

1 SteadyShot off

2 Exposure

AUTO appears during playback of the movie recorded with the iris, gain and shutter speed automatically adjusted.

MANUAL appears during playback of the movie recorded with the iris, gain and shutter speed manually adjusted.

3 Iris

CLOSE appears in the iris value display area during playback of the movie recorded with the iris manually adjusted to its maximum value.

4 Gain

5 Shutter speed

6 White balance

PWB appears during playback of the movie recorded with the shot transition.

Notes

- The exposure correction value (0EV), shutter speed and iris will be displayed during viewing of still images on "Memory Stick Duo."
- Date and time will be displayed in the same area when you select the date and time display. If you record without setting date and time, [---:---] and [---:---] will be displayed.
- An accurate shutter speed may not be displayed when you play back a tape recorded with your camcorder on another device. Check the data code that is displayed on the screen when you play back the tape on your camcorder for the accurate shutter speed.
- When you record a movie with the gain set to [-6dB] and play it back with the data code, the gain value is displayed as [---].

Displaying the settings in your camcorder (Status check)

You can check the settings of the following items.

- Audio setup such as [WIND] (p. 73)
- Output signal setup ([VCR HDV/DV], etc.) (p. 77)
- Functions assigned to the ASSIGN buttons (p. 44)
- Camera setup. (p. 66)

1 Press the **STATUS CHECK** button **C**.

2 Turn the **SEL/PUSH EXEC** dial **D** until a desired display shows up on the screen.

When the POWER switch **B** is set to CAMERA, the display changes in the following sequence:

AUDIO → OUTPUT → ASSIGN → CAMERA

When the POWER switch **B** is set to VCR, the display changes in the following sequence:

AUDIO → OUTPUT → ASSIGN

To hide the display

- Press the STATUS CHECK button **C**.

Checking the remaining battery (Battery Info)

Set the POWER switch to OFF (CHG), then press the DISPLAY/BATT INFO button **E**. The approximate recordable time in the selected format and battery information appear for about 7 seconds. You can view the battery information for up to 20 seconds by pressing the button again while the information is displayed.

Remaining battery (approx.)

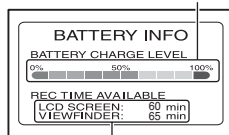

Recording capacity (approx.)

Locating a scene on a tape

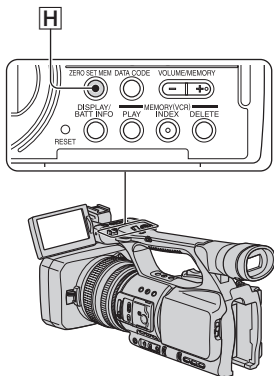
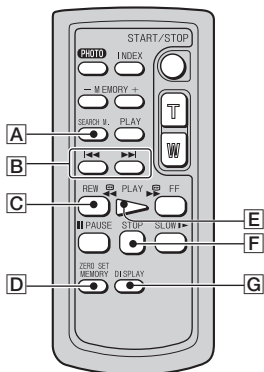

Notes

- See page 127 for details on how to use the Remote Commander.

Searching quickly for a desired scene (Zero set memory)

- 1** During playback, press the **ZERO SET MEM** button **[H]** on your camcorder or the **ZERO SET MEMORY** button **[D]** on the Remote

Commander at the scene where you want to create a cue point.

The tape counter is reset to “0:00:00” and **+0+** appears on the screen.

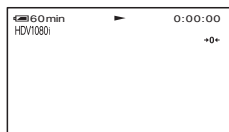

If the tape counter is not displayed, press the **DISPLAY** button **[G]**.

- 2** Press the **STOP** button **[F]** when you want to stop playback.

- 3** Press the **REW** button **[C]**.

The tape stops automatically when the tape counter reaches “0:00:00.”

The tape counter returns to the time code display, and **+0+** disappears.

- 4** Press the **PLAY** button **[E]**.

Playback starts from the point designated “0:00:00” on the tape counter.

To cancel the operation

Press the **ZERO SET MEM** button **[H]** or the **ZERO SET MEMORY** button **[D]** again before rewinding.

Notes

- There may be a discrepancy of several seconds between the time code and the tape counter.
- Zero set memory will not function correctly if there is a blank section between recorded sections on the tape.

Searching for a scene by date of recording (Date search)

You can search scenes by recording dates.

- 1 Set the **POWER** switch to **VCR**.
- 2 Press the **SEARCH M.** button **[A]** on the Remote Commander repeatedly to select **[DATE SEARCH]**.
- 3 Press the **◀◀ (previous)/▶▶ (next)** button **[B]** on the Remote Commander to select a recording date.

You can select a date previous or next to the date of the current tape position.

Playback automatically starts from the scene recorded on the selected date.

To cancel the operation

Press the **STOP** button **[F]** on the Remote Commander.

🔊 Notes

- Each day of recording must be longer than 2 minutes. Your camcorder may not detect the date if the recording of that date is short.
- The date search may not work properly if a blank section exists on the tape.

Searching for a recording start point (Index search)

You can search scenes by indexes recorded at the start of recording (p. 45).

- 1 Set the **POWER** switch to **VCR**.
- 2 Press the **SEARCH M.** button **[A]** on the Remote Commander repeatedly to select **[INDEX SEARCH]**.
- 3 Press the **◀◀ (previous)/▶▶ (next)** button **[B]** on the Remote Commander to select an index point.

You can select an index previous or next to the index of the current tape position.

Playback automatically starts from the scene marked by the index.

To cancel the operation

Press the **STOP** button **[F]** on the Remote Commander.

🔊 Notes

- Recording between indexes must be longer than 2 minutes. Your camcorder may not detect the date if the recording between the indexes is short.
- The index search may not work properly if a blank section exists on the tape.

Playing the picture on a TV

Connection methods and image quality differ depending on what type of TV is connected and connectors used.

Use the supplied AC Adaptor to obtain AC power (p. 18).

Refer also to the instruction manuals supplied with the device to be connected.

Jacks on your camcorder

Open the jack cover and connect the cable.

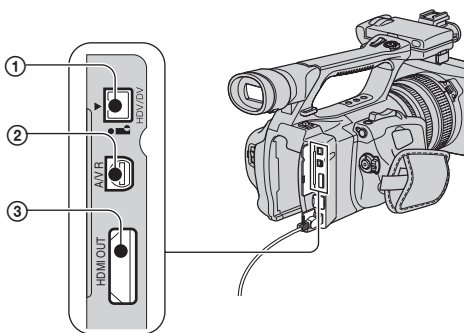

⚡ Notes

- Make all menu settings on your camcorder before connecting. The TV may not recognize the video signal properly when changing [VCR HDV/DV] and [i.LINK CONV] settings after connecting with an i.LINK cable.

Connecting to a high definition TV

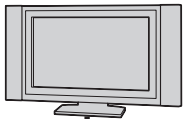

A movie recorded in HD quality is played back in HD quality.
A movie recorded in SD quality is played back in SD quality.

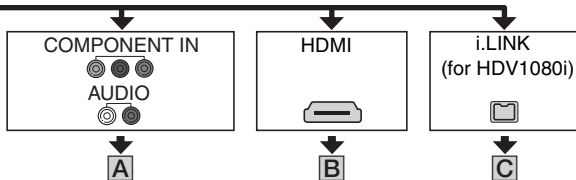

: Signal flow

Type	Camcorder	Cable	TV	Menu Setting
------	-----------	-------	----	--------------

A

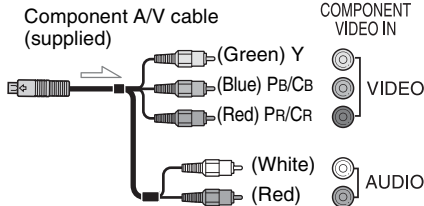

(IN/OUT REC)
menu →
[VCR HDV/DV] →
[AUTO] (p. 77)
[COMPONENT] →
[1080i/480i] (p. 79)

Notes

- If you connect only component video plugs, audio signals are not output. Connect the white and red plugs to output audio signals.

Playing the picture on a TV (Continued)

 : Signal flow

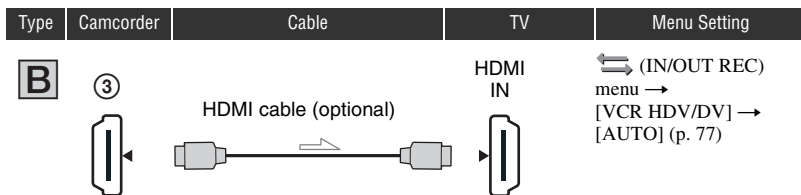

Notes

• **Use an HDMI cable with the HDMI logo.**

- Pictures in the DV format are not output from the HDMI OUT jack, if copyright protection signals are recorded in the pictures.
- DV format pictures input to the camcorder via i.LINK cable (p. 84) cannot be output.
- Your TVs may not function correctly (for example, no sound or image). Do not connect the HDMI OUT jack of your camcorder and HDMI OUT jack of the external device with the HDMI cable. This may cause a malfunction.

Tips

- HDMI (High-Definition Multimedia Interface) is an interface to send both video and audio signals. Connecting HDMI OUT jack to an external device supplies high quality images and digital audio to you.

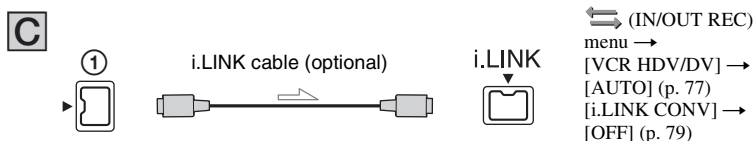

Notes

- **Your TV needs to have an i.LINK jack compatible with HDV1080i. For details, confirm the specifications of your TV.**
- If your TV is not compatible with HDV1080i, connect your camcorder and TV with the supplied component A/V cable as illustrated in **A**.
- The TV needs to be set so that it recognizes that the camcorder is connected. Refer to the instruction manuals supplied with your TV.
- This camcorder has a 4-pin i.LINK terminal. Select a cable that fits the terminal on the TV to be attached.

Connecting to a 16:9 (wide) or 4:3 TV

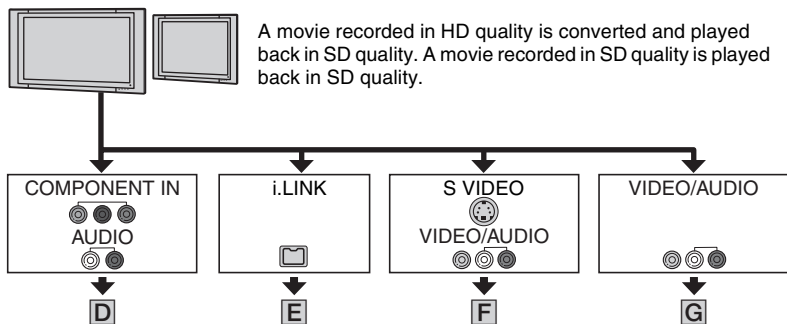

To set the aspect ratio according to the connected TV (16:9/4:3)

Change [TV TYPE] setting to match your TV (p. 79).

🔊 Notes

- When you play back a tape recorded in the DV format on a 4:3 TV not compatible with the 16:9 signal, set [DV WIDE REC] to [OFF] on your camcorder when recording a picture (p. 78).

💡 Tips

- When your TV is monaural (When your TV has only one audio input jack), connect the yellow plug of the A/V connecting cable to the video input jack and connect the white (left channel) or the red (right channel) plug to the audio input jack of your TV or VCR. When you want to play the sound in monaural mode, use a connecting cable for that purpose.

Playing the picture on a TV (Continued)

 : Signal flow

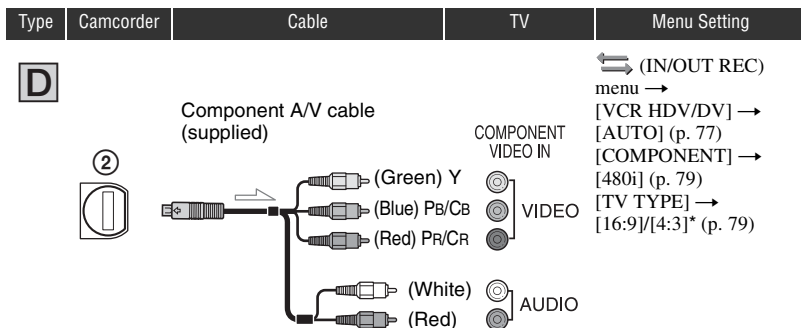

⚡ Notes

- If you connect only component video plugs, audio signals are not outputted. Connect the white and red plugs to output audio signals.

E

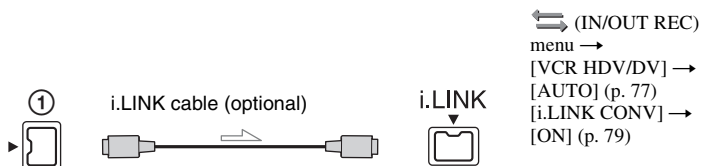

⚡ Notes

- The TV needs to be set so that it recognizes that the camcorder is connected. Refer to the instruction manuals supplied with your TV.
- This camcorder has a 4-pin i.LINK terminal. Select a cable that fits the terminal on the TV to be attached.

* Change the settings according to the TV connected.

Type	Camcorder	Cable	TV	Menu Setting
------	-----------	-------	----	--------------

F

A/V connecting cable with S VIDEO (optional)

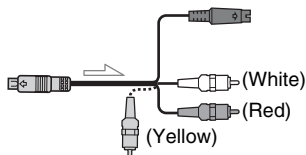

↔ (IN/OUT REC) menu →
 [VCR HDV/DV] →
 [AUTO] (p. 77)
 [TV TYPE] →
 [16:9]/[4:3]* (p. 79)

Tips

- When connecting only an S VIDEO plug (S VIDEO channel), audio signals are not output. To output audio signals, connect the white and red plugs of the A/V connecting cable with S VIDEO to the audio input jack of your TV.
- This connection produces higher resolution pictures compared with the A/V connecting cable (Type **G**).

G

A/V connecting cable (supplied)

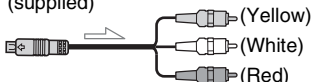

↔ (IN/OUT REC) menu →
 [VCR HDV/DV] →
 [AUTO] (p. 77)
 [TV TYPE] →
 [16:9]/[4:3]* (p. 79)

* Change the settings according to the TV connected.

Notes

- If you connect your camcorder to the TV using more than one type of cable to output images, the order of priority of the TV input jacks is as follows:
 HDMI → component video → S VIDEO → video.
- See page 113 for the details of i.LINK.





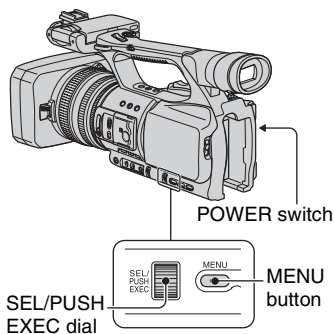

When connecting to your TV via a VCR

Select the connecting method on page 84 depending on the input jack of the VCR. Connect your camcorder to the LINE IN input on the VCR using the A/V connecting cable. Set the input selector on the VCR to LINE (VIDEO 1, VIDEO 2, etc.).

Using the menu items

You can change various settings or make detailed adjustments using the menu items displayed on the screen.



-  CAMERA SET (p. 66)
-  AUDIO SET (p. 73)
-  DISPLAY SET (p. 74)
-  IN/OUT REC (p. 77)
-  MEMORY SET (p. 80)
-  OTHERS (p. 81)

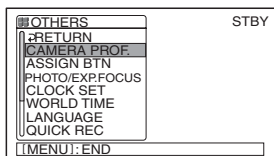

- 4** Turn the SEL/PUSH EXEC dial until the desired menu item is highlighted, then press the dial to select the item.

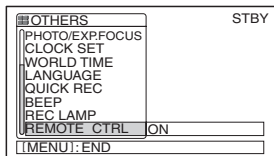

The available menu items vary depending on the position of the power switch of your camcorder. Unavailable items will be grayed out.

- 1** While pressing the green button, set the POWER switch.

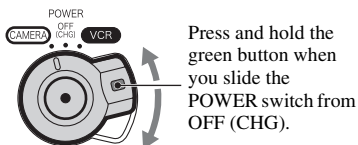

- 2** Press the MENU button.

The menu index screen appears.

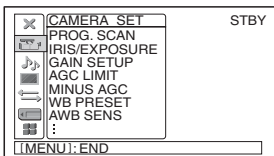

- 3** Turn the SEL/PUSH EXEC dial until the icon of the desired menu is highlighted, then press the dial to select the menu.

- 5** Turn the SEL/PUSH EXEC dial until the desired setting is highlighted or to bring up the desired setting, then press the dial to confirm the setting.

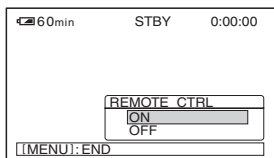

6 Press the MENU button to hide the menu screen.

To return to the previous screen, select [↩ RETURN].

Menu items

Available menu items (●) vary depending on the POWER switch position.

Position of POWER switch:

CAMERA

VCR



(CAMERA SET) menu (p. 66)

PROG.SCAN	●	—
IRIS/EXPOSURE (AS)	●	—
GAIN SETUP	●	—
AGC LIMIT	●	—
MINUS AGC	●	—
WB PRESET	●	—
AWB SENS	●	—
AE SHIFT (AS)	●	—
AE RESPONSE	●	—
AT IRIS LMT	●	—
FLCKR REDUCE	●	—
CNTRST ENHCR	●	—
BACK LIGHT (AS)	●	—
SPOTLIGHT (AS)	●	—
STEADYSHOT (AS)	●	—
AF ASSIST	●	—
HANDLE ZOOM	●	—
D.EXTENDER (AS)	●	—
FADER (AS)	●	—
SMTH SLW REC (AS)	●	—
INTERVAL REC	●	—
DV FRAME REC (DV)	●	—
SHOT TRANSITION (AS)	●	—
x.v.Color (HDMI/1080)	●	—
COLOR BAR (AS)	●	—



(AUDIO SET) menu (p. 73)

DV AU.MODE (DV)	●	—
AUDIO LIMIT	●	—
WIND	●	—
MULTI-SOUND	—	●
DV AUDIO MIX (DV)	—	●





(DISPLAY SET) menu (p. 74)

ZEBRA (AS)	●	—
HISTOGRAM	●	—
PEAKING (AS)	●	—
MARKER (AS)	●	—
EXP.FOCUS TYPE	●	—
CAM DATA DSP	●	—
AU.LVL DISP	●	—
LCD BRIGHT	●	●

Position of POWER switch:

	CAMERA	VCR
LCD COLOR	●	●
LCD BL LEVEL	●	●
VF B.LIGHT	●	●
VF POWERMODE	●	●
LETTER SIZE	●	●
 REMAINING	●	●
DISP OUTPUT	●	●

 **(IN/OUT REC) menu (p. 77)**

REC FORMAT	●	—
VCR HDV/DV	—	●
DV REC MODE 	●	●
DV WIDE REC 	●	—
COMPONENT	●	●
i.LINK CONV	●	●
TV TYPE	●	●

 **(MEMORY SET) menu (p. 80)**

<input type="checkbox"/> ALL ERASE	—	●
<input type="checkbox"/> FORMAT	●	●
FILE NO.	●	●
NEW FOLDER	●	●
REC FOLDER	●	●
PB FOLDER	—	●

 **(OTHERS) (p. 81)**

CAMERA PROF.	●	●
ASSIGN BTN	●	●
PHOTO/EXP.FOCUS	●	●
CLOCK SET	●	●
WORLD TIME	●	●
LANGUAGE	●	●
PB ZOOM	—	●
QUICK REC 	●	—
BEEP	●	●
REC LAMP	●	—
REMOTE CTRL	●	●

(CAMERA SET) menu

Settings to adjust your camcorder to the recording conditions (GAIN SETUP/BACK LIGHT/STEADYSHOT, etc.)

The default settings are marked with ►.
The indicators in parentheses appear when the items are selected.

See page 62 for details on selecting menu items.

Press the MENU button → select the  (CAMERA SET) with the SEL/PUSH EXEC dial.

PROG. SCAN

You can capture progressive scan images with a vertical resolution of 1,080 lines.

► OFF

24 (24pSCAN)

Captures 24 frames per second, the same rate as that of cinema movies.

30 (30pSCAN)

Captures 30 frames per second, the same rate as that of television commercials.

Note

- The captured images are converted to 60i format and recorded on tape.

IRIS/EXPOSURE (AS)

■ RING ASSIGN

You can select either [IRIS] (default setting) or [EXPOSURE] as the function assigned to the iris ring (p. 33).

■ RING ROTATE

You can select the rotation direction of the iris ring.

► NORMAL

Makes images dark with clockwise rotation of the iris ring.

OPPOSITE

Makes images dark with counter-clockwise rotation of the iris ring.

Notes

- When the AUTO/MANUAL switch is set to AUTO, the IRIS/EXPOSURE button is not available.

Tips

- The iris, gain and shutter speed values are adjusted as follows when you change the [RING ASSIGN] setting with the AUTO/MANUAL switch set to MANUAL.

– When you change [RING ASSIGN] from [IRIS] to [EXPOSURE]

The adjustment remains in the same mode that it was in prior to changing [RING ASSIGN]. If it is in automatic adjustment, it remains in automatic adjustment after changing [IRIS] to [EXPOSURE]. If it is in manual adjustment, it remains in manual adjustment after changing [IRIS] to [EXPOSURE].

You can adjust the iris, gain and shutter speed with the iris ring when  is displayed next to the values on the screen.

Adjustment for the gain and shutter speed can be switched between [EXPOSURE] and manual.

– When you change [RING ASSIGN] from [EXPOSURE] to [IRIS]

The adjustment remains in the same mode that it was in prior to changing [RING ASSIGN]. If it is in automatic adjustment, it remains in automatic adjustment after changing [EXPOSURE] to [IRIS]. If it is in manual adjustment, it remains in manual adjustment after changing [EXPOSURE] to [IRIS].

Adjustments for the gain and shutter speed can be switched between automatic and manual.

- You can assign [RING ROTATE] to one of the ASSIGN buttons (p. 44).

GAIN SETUP

You can set gain values for H, M and L positions of the gain switch. The default settings of [H], [M] and [L] are 18dB, 9dB and 0dB, respectively.

- ① Select [H], [M] or [L] with the SEL/PUSH EXEC dial.

- ② Set the gain value with the SEL/PUSH EXEC dial, and press the dial.
You can select the value between -6dB and 21dB by 3dB. The larger the value, the higher the gain.
- ③ Select [OK] with the SEL/PUSH EXEC dial.
- ④ Press the MENU button to hide the menu screen.

AGC LIMIT

You can select the upper limit for the Auto Gain Control (AGC) from [OFF] (21dB, the default setting), [18dB], [15dB], [12dB], [9dB], [6dB], [3dB] and [0dB].

Notes

- If you adjust the gain manually, you cannot obtain the effect of [AGC LIMIT].

MINUS AGC

When you set this function to [ON], the automatic gain control range can be expanded to the negative range. Especially in a bright environment, minus gain control allows more suitable gain setting and enables low noise recording. The dynamic range of your camcorder is not reduced when you set [MINUS AGC] to [ON].

► ON

Enables minus gain control during automatic gain control, as required.

OFF

Disables minus gain control during automatic gain control.

WB PRESET

You can use the preset white balance. For more details, see page 36.

AWB SENS

You can set the auto white balance operation under a reddish light source such as an incandescent lamp or candle, or under a blueish light source such as in outdoor shade.

► INTELLIGENT

Automatically adjusts the white balance so that scenes look natural for the light source.

HIGH

Automatically adjusts the white balance while reducing redness or blueness.

MIDDLE

LOW

Automatically adjusts the white balance while increasing redness or blueness.

Notes

- This is only effective when white balance is adjusted automatically.
- [AWB SENS] is not effective under a clear sky or the sun.

AE SHIFT **AS**

You can set an offset value to adjust the automatic exposure adjustment value between [-7] (dark) and [+7] (bright) with the SEL/PUSH EXEC dial. The default setting is [0]. **AS** and selected value appears on the screen when you change the value from the default setting.

Notes

- This function is not effective while you adjust the iris, shutter speed and gain all manually.
- [AE SHIFT] is canceled when [EXPOSURE] is manually adjusted.

Press the MENU button → select the  (CAMERA SET) with the SEL/PUSH EXEC dial.

AE RESPONSE

You can select the speed at which the automatic exposure adjustment function follows changes in the brightness of the subject. You can select the speed from [FAST], [MIDDLE] and [SLOW]. The default setting is [FAST].

AT IRIS LMT

You can select the highest iris value for the automatic adjustment from [F11], [F9.6], [F8], [F6.8], [F5.6], [F4.8] and [F4]. The default setting is [F11].

Notes

- * This function is not effective during the manual iris adjustment.

FLCKR REDUCE

▶ ON

Reduces flickering. Flickering of the screen under a light source such as fluorescent lamps will be reduced.

OFF

Not reduce flickering.

Notes

- Flickering may not be reduced for certain light sources.

CNTRST ENHCR

When you set this function to [ON], your camcorder detects high contrast images, such as backlit scenes, and automatically improves the unexposed images. The default setting is [ON].

Notes

- When you set [BACK LIGHT] to [ON], [CNTRST ENHCR] is temporarily disabled.

BACK LIGHT

When you set this function to [ON] () , you can correct backlighting. The default setting is [OFF].

Notes

- [BACK LIGHT] is set to [OFF] when you set [SPOTLIGHT] to [ON].
- [BACK LIGHT] is set to [OFF] when [EXPOSURE] is manually adjusted.
- [BACK LIGHT] is set to [OFF] if at least two of iris, gain, and shutter speed are adjusted manually.

SPOTLIGHT

When you set this function to [ON] () , you can prevent overexposure of light during recording of a subject under strong light, such as a stage. For example, you can prevent people's faces from over-highlighting. The default setting is [OFF].

Notes

- [SPOTLIGHT] is set to [OFF] when you set [BACK LIGHT] to [ON].
- [SPOTLIGHT] is set to [OFF] when [EXPOSURE] is manually adjusted.
- [SPOTLIGHT] is set to [OFF] if at least two of iris, gain, and shutter speed are adjusted manually.

STEADYSHOT

■ ON/OFF

When you select [ON], you can reduce camera shakes. Select [OFF] () when you use a tripod (optional) to make images look natural. The default setting is [ON].

■ TYPE

You can select a type of camera-shake reduction for different recording situations.

HARD

Reduces camera shakes at a high level.

This setting is not suitable for panorama tilt recordings.

► STANDARD

Reduces camera shakes at a standard level.

SOFT

Reduces camera shakes at a low level. Slight unsteadiness remains in movies, which make the movies look as they are.

WIDE CONV.

This is for use with wide conversion lenses (optional). It is the optimum setting for use with a Sony VCL-HG0872A wide conversion lens.

AF ASSIST

When you set this function to [ON], you can temporarily focus manually using the focus ring during the auto focus adjustment. The default setting is [OFF].

HANDLE ZOOM

You can select the zoom speed for the FIX position of the handle zoom switch from [1] (slow) through [8] (fast). The default setting is [3].

D.EXTENDER (AS)

When you set this function to [ON] () , the displayed image becomes 1.5 times larger. The image quality decreases because the image is digitally processed. This function helps you to focus on far-away subjects such as a wild bird away at a distance. The default setting is [OFF].

⚙ Notes

- This function is automatically set to [OFF] when you turn the power off and back on.

FADER (AS)

You can add visual effects to transition between scenes.

- ① Select [WHITE FADER] or [BLACK FADER] during standby to fade in with the

selected effect or recording to fade out with the selected effect.

- ② Press the REC START/STOP button.

The fader indicator stops flashing and disappears when the fading is complete.

To cancel before starting the operation, select [OFF] in step ①.

The setting will be cleared every time you press the REC START/STOP button.



WHITE FADER



BLACK FADER



⚙ Notes

- This function is automatically set to [OFF] when you turn the power off and back on.

SMTH SLW REC (Smooth slow recording) (AS)

Fast moving subjects and actions, which cannot be captured under the general shooting conditions, can be shot in smooth moving slow-motion.

This is useful to shoot fast actions such as a golf or tennis swing.

Select [EXECUTE], and press the REC START/STOP button on the [SMTH SLW REC] screen.

An approximately 6-second recording is stretched to about 24-seconds and recorded as a slow-motion movie.

When [Recording...] disappears, recording is finished.

To cancel [SMTH SLW REC], press the MENU button.

Press the MENU button → select the  (CAMERA SET) with the SEL/PUSH EXEC dial.

After executing [SMTH SLW REC] with an ASSIGN button, you can also cancel [SMTH SLW REC] by pressing the ASSIGN button again. See page 44 for details on how to use the ASSIGN buttons.

You can select the [SMTH SLW REC] settings suitable for your recording.

■ TIMING

You can use this to select when recording starts in relation to when the REC START/STOP button is pressed.

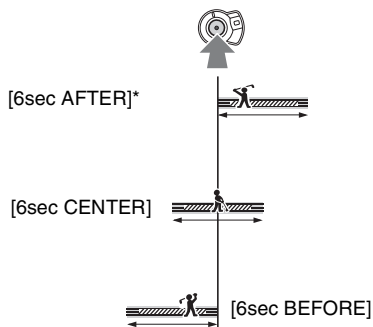

* The default setting is [6sec AFTER].

■ TRIG

When you set this function to [ON], recording automatically starts in response to a preset sound level instead of the REC START/STOP button being pressed. The [ TRIG] setting is canceled when you turn the power off and back on.



■ TRIG LEVEL

You can select the sound level at which recording is triggered from [HIGH], [MIDDLE] and [LOW] in [ TRIG LEVEL]. The default setting is [HIGH].

⚡ Notes

- Sounds cannot be recorded.
- The recording time may be shorter than the set time, depending on recording conditions.
- The image quality is lower than with the regular recording.

💡 Tips

- When [ TRIG] is set to [ON], you can also start recording by pressing the REC START/STOP button.
- When you manually set the microphone volume to a low level, [ TRIG] may not work properly. We recommend that you set [ TRIG LEVEL] to [MIDDLE] or [LOW].

INTERVAL REC

You can record a series of movies on a tape at regular intervals. This function is useful to observe things like cloud movements or daylight changes. The scenes run smoothly into each other when you play back the tape. Use the AC Adapter/Charger to obtain AC power for long recording.

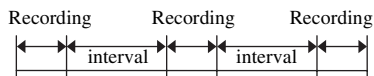

- ① Select [ON/OFF] → [ON] with the SEL/PUSH EXEC dial.
- ② Perform the following step if you are changing the recording time from the default setting of [0.5sec]. If you are keeping the default recording time, go straight to step ③.
Select [REC TIME] → [0.5sec], [1sec], [1.5sec] or [2sec] with the SEL/PUSH EXEC dial.
- ③ Perform the following step if you are changing the interval time from the default setting of [30sec]. If you are keeping the default interval time, go straight to step ④.
Select [INTERVAL] → [30sec], [1min], [5min] or [10min].
- ④ Select [OK] with the SEL/PUSH EXEC dial.
- ⑤ Press the MENU button to hide the menu screen.
- ⑥ Press the REC START/STOP button.
The [INTERVAL REC] recording starts.

To cancel [INTERVAL REC], press the REC START/STOP button.

The operation of your camcorder differs depending on when you press the REC START/STOP button.

If you press the button during [INTERVAL REC] recording, the recording temporarily stops. If you press it again, the [INTERVAL REC] recording restarts. If you press the button during [INTERVAL REC] interval, the [INTERVAL REC] recording stops and regular recording starts. If you press it again, regular recording stops. If you press the button once again, the [INTERVAL REC] recording restarts. To cancel the [INTERVAL REC] recording, select [ON/OFF] → [OFF] with the SEL/PUSH EXEC dial.

Notes

- The recording time and interval time may differ slightly from the settings.
- If you focus manually, you can get sharp images even if the lighting changes.
- You can disable the beep during recording by setting [BEEP] to [OFF].

DV FRAME REC DV

You can record stop motion (or frame-by-frame) animation movies. That type of animation uses a technique of changing the subject, such as a doll or a toy's positions and recording it at each different position while your camcorder sits still. Use the Remote Commander to reduce camera shakes.

► OFF

Not use this function.

ON ()

Records a movie by stop motion (or frame-by-frame) technique.

- ① Select [ON] with the SEL/PUSH EXEC dial.
- ② Press the MENU button to hide the menu screen.
- ③ Press the REC START/STOP button.
Your camcorder records a movie for about 6 frames and returns to standby.

- ④ Move the subject and repeat step ③.

Notes

- When you use frame recording continuously, the remaining tape time will not be indicated correctly.
- The last scene will be longer than other scenes.
- You cannot record index signals during frame recording.
- This function is automatically set to [OFF] when you turn the power off and back on.

SHOT TRANSITION AS

You can set [TRANS TIME] and [TRANS CURVE]. See page 46 for details on using the shot transition function.

■ TRANS TIME

You can set the transition time between [3.5 sec] and [90.0 sec]. The default setting is [4.0 sec].

■ TRANS CURVE

You can select the transition curve. The characteristics of the transition curves are illustrated in the following graphs.

*1: parameter level

*2: time

LINEAR

Make the transition linearly.

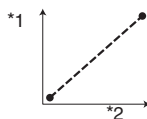

► SOFT STOP

Make the transition slowly at the end.

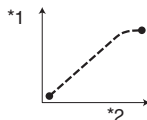

SOFT TRANS

Make the transition slowly at the beginning and end, and linearly in between.

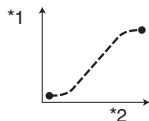

Notes

- You cannot change [TRANS TIME] and [TRANS CURVE] settings during store, check, or execution of [SHOT TRANSITION]. Cancel [SHOT TRANSITION] setting by pressing the ASSIGN 4 button several times before changing [TRANS TIME] or [TRANS CURVE] setting.

x.v.Color

When you set this function to [ON], you can record with the wider color range. Your camcorder can reproduce brilliant and vivid colors for flowers and the beautiful blue-green of tropical oceans that cannot be matched by conventional technologies.

Notes

- The colors may not be well reproduced when you play back a movie recorded with this function set to [ON] on a TV that does not support x.v.Color.
- You cannot set [x.v.Color] in the following cases:
 - When recording in SD (standard) format
 - When recording movies
- When you set [x.v.Color] to [ON], the picture profile will be disabled.

COLOR BAR

ON/OFF

When you select [ON], you can display color bars on the screen or record them on a tape. This function helps you to adjust colors when you view movies recorded with your camcorder on a TV or a monitor. The default setting is [OFF].

Notes

- This function is automatically set to [OFF] when you turn the power off and back on.

TYPE

- Selects a type of the color bars.

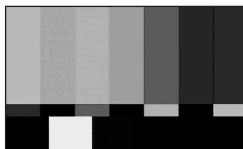

TYPE1



TYPE2

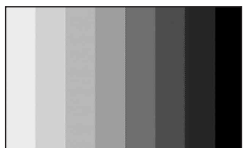

TYPE3



TYPE4
(75% brightness of TYPE3)

(AUDIO SET) menu

Settings for the audio recording (DV AU.MODE/DV AUDIO MIX, etc.)

The default settings are marked with ►.
The indicators in parentheses appear when the items are selected.

See page 62 for details on selecting menu items.

Press the MENU button → select the  (AUDIO SET) with the SEL/PUSH EXEC dial.

DV AU.MODE (DV Audio mode)

12BIT ()

Records in the 12-bit mode (2 stereo sounds).

► 16BIT ()

Records in the 16-bit mode (1 stereo sound with high quality).

Notes

- When recording in the HDV format, sound is automatically recorded in [16BIT] mode.

AUDIO LIMIT

You can set the clipping-noise reduction function.

► OFF

Disables the function.

ON

Enables the function.

Notes

- This function is available only when you set the AUDIO LEVEL switch to MAN.

WIND

► ON

Enables wind noise reduction.

OFF

Disables wind noise reduction.

MULTI-SOUND

You can select whether to play back audio recorded using other devices with dual sound or stereo sound.

► STEREO

Plays back with main and sub sound (or stereo sound).

1

Plays back with main sound (or the left channel sound).

2

Plays back with sub sound (or the right channel sound).

Notes

- You can play back, but cannot record a dual sound track cassette on your camcorder.

DV AUDIO MIX

You can monitor the sound dubbed from another device or recorded through 4-channel microphone during playback. You can set how to output the sound.

► ST1

Outputs the originally recorded sound only.

MIX

Outputs the originally recorded sound mixed with the dubbed sound.

ST2

Outputs the dubbed sound only.

Notes

- This function is not effective, when you play back a tape recorded with [DV AU.MODE] set to [16BIT]

(DISPLAY SET)

menu

Display settings of the display and the viewfinder (MARKER/VF B.LIGHT/DISP OUTPUT, etc.)

The default settings are marked with ►. The indicators in parentheses appear when the items are selected.

See page 62 for details on selecting menu items.

Press the MENU button → select the  (DISPLAY SET) with the SEL/PUSH EXEC dial.

ZEBRA (AS)

You can display a zebra pattern as a guide for adjusting brightness.

■ ON/OFF

When you select [ON],  and the brightness level appear on the screen. The zebra pattern will not be recorded on a tape or a “Memory Stick Duo.”

■ LEVEL

You can select the brightness level between 70 and 100 or 100+.

Tips

- The zebra pattern is a strip pattern displayed over a part of an image on the screen when the part is higher than a preset brightness level.

HISTOGRAM

You can adjust the iris while referring to a histogram. A histogram is a graph that shows the distribution of the image brightness. You can use the histogram as a guide for adjusting the iris. The histogram will not be recorded on a tape or a “Memory Stick Duo.”

► OFF

Does not display a histogram.

NORMAL

Displays a histogram.

ADVANCE

Displays a histogram, and a bar that indicates an average of the brightness levels around the center of an image (within the marker) on the histogram.

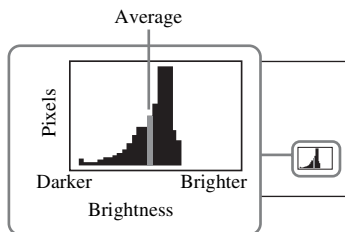

Tips

- The left area on the graph shows the darker areas of the image while the right area shows the brighter areas.
- A vertical line that indicates the brightness level of [ZEBRA] will be displayed on the histogram when you set [ZEBRA] to [ON].

PEAKING (AS)

■ ON/OFF

When you select [ON], you can display an image on the screen with its details enhanced. This function helps you to adjust the focus. The default setting is [OFF].

■ COLOR

You can select the peaking color from [WHITE], [RED] and [YELLOW]. The default setting is [WHITE].

■ LEVEL

You can select a peaking sensitivity from [HIGH], [MIDDLE] and [LOW]. The default setting is [MIDDLE].

Notes

- You cannot record an image with enhanced details on a tape or a "Memory Stick Duo."

Tips

- You can focus more easily using this function in combination with the expanded focus function (p. 33).

MARKER AS

ON/OFF

When you select [ON], you can display marker markers. The default setting is [OFF]. Markers will not be recorded on a tape or "Memory Stick Duo."

CENTER

When you select [ON], you can display a marker at the center of the screen. The default setting is [ON].



GUIDEFAME

When you select [ON], you can display frame markers that help you to check horizontal and vertical positions of a subject. The default setting is [OFF].



Notes

- You cannot output display information, such as the time code, to an external device when [MARKER] is set to [ON].

Tips

- You can display the center marker and the guideframe marker at the same time.
- You can obtain a balanced composition by positioning the subject at the cross points of the guideframe marker.
- You can display markers only on the LCD panel and viewfinder. You cannot display them on an external device.

EXP.FOCUS TYPE

You can set a type of the expanded focus display.

TYPE1

Simply enlarges images.

TYPE2

Enlarges and shows images in white and black.

CAM DATA DSP (Camera data display)

When you set this function to [ON], you can constantly display the iris, shutter speed and gain settings on the screen. The default setting is [OFF].

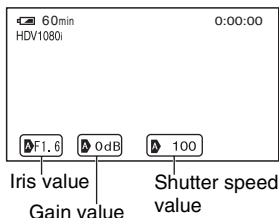

Tips

- The settings appear on the screen during the manual adjustment regardless of the settings of this function.
- A indicates that the settings are automatically adjusted values.
- The displayed settings are different from the settings that will be displayed when you press the DATA CODE button (p. 52).

Press the MENU button → select the  (DISPLAY SET) with the SEL/PUSH EXEC dial.

AU.LVL DISP (Audio level display)

When you set this function to [ON], you can display the audio level meter on the screen. The default setting is [ON].

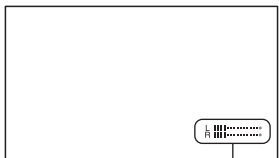

Audio level meter

LCD BRIGHT

You can adjust the brightness of the LCD screen with the SEL/PUSH EXEC dial. Changes in the LCD brightness will not affect the brightness of recording images.

Tips

- You can also turn off the LCD backlight (p. 22).

LCD COLOR

You can adjust the LCD color intensity using the SEL/PUSH EXEC dial. Changes in the LCD color level will not affect the color level of recording images.

LCD BL LEVEL

You can adjust the brightness of the LCD screen's backlight.

▶ **NORMAL**

Standard brightness.

BRIGHT

Brightens the LCD screen.

Notes

- When you connect your camcorder to outside power sources, [LCD BL LEVEL] is automatically set to [BRIGHT].
- When you select [BRIGHT], the recordable time with the battery is slightly reduced.

VF B. LIGHT

You can adjust the brightness of the viewfinder.

▶ **NORMAL**

Standard brightness.

BRIGHT

Brightens the viewfinder screen.

Notes

- When you connect your camcorder to outside power sources, [BRIGHT] is automatically selected for the setting.
- When you select [BRIGHT], the recordable time with the battery is slightly reduced.

VF POWERMODE

▶ **AUTO**

Turns on the viewfinder while you close the LCD panel or record in mirror mode.

ON

Always turns on the viewfinder.

LETTER SIZE

▶ **NORMAL**

Displays the menu in regular letter size.

2x

Displays the selected menu items in letter size, the height of which is doubled.

REMAINING

▶ **AUTO**

Displays the remaining time of a tape for about 8 seconds in the following situation:

- When you set the POWER switch to VCR or CAMERA with a cassette inserted.
- When you press  (Play) or the DISPLAY/BATT INFO button.

ON

Always displays the remaining time of a tape. The remaining time is not displayed when you insert a new tape or a tape that is

rewound to the beginning. It is displayed when you start playback or recording.

DISP OUTPUT

You can select outputs to which display information, such as time code, is outputted.

► LCD PANEL

Outputs the information to the LCD screen and viewfinder.

V-OUT/PANEL

Outputs the information to the LCD screen, viewfinder and composite output.

ALL OUTPUT

Outputs the information to the LCD screen, viewfinder, HDMI output, component output and composite output.

🔊 Notes

- You can output display information only to the viewfinder and the LCD screen when [MARKER] is set to [ON].

↔ (IN/OUT REC) menu

Recording settings, input and output settings (VCR HDV/DV/DV REC MODE/ DV WIDE REC/ TV TYPE, etc.)

The default settings are marked with ►. The indicators in parentheses appear when the items are selected.

See page 62 for details on selecting menu items.

Press the MENU button → select the ↔ (IN/OUT REC) with the SEL/PUSH EXEC dial.

REC FORMAT

You can select a recording format.

► HDV1080i (HDV1080i)

Records in the HDV1080i format.

DV (DV)

Records in the DV format.

Set also [DV REC MODE] when you record in this format.

🔊 Notes

- Set also [i.LINK CONV] as necessary when you output a movie to an external device through an i.LINK cable (p. 79).

VCR HDV/DV

You can select a type of output signal to an external device for playing back a movie on the device. Select [AUTO] in most cases. When you connect your camcorder to an external device with an i.LINK cable, select a type of input and output signals to and from the external device via the i.LINK HDV/DV jack. You can record or play back a movie reproduced by the selected type of signals.

Press the MENU button → select the  (IN/OUT REC) with the SEL/PUSH EXEC dial.

► AUTO

Automatically switches between HDV signals and DV signals during playback. During the i.LINK connection, recognizes HDV signals and DV signals, and automatically inputs or outputs the signals to or from the external device via the  HDV/DV (i.LINK) jack for recording or playback.

HDV (HDV1080i)

Plays back only HDV format sections of a tape.

During the i.LINK connection, inputs or outputs only HDV signals to or from an external device via the  HDV/DV (i.LINK) jack for recording or playback. Select this setting when you connect your camcorder to your computer.

DV (DV)

Plays back only DV format sections of a tape.

During the i.LINK connection, inputs or outputs only DV signals to or from an external device via the  HDV/DV (i.LINK) jack for recording or playback. Select this setting when you connect your camcorder to your computer.

⚙ Notes

- Make sure to disconnect the i.LINK cable prior to changing the setting. Otherwise, a video device may not recognize video signals.
- When you select [AUTO], images and sounds may be cut off on switching between HDV signals and DV signals.
- When you set [i.LINK CONV] to [ON], the following signals will be outputted:
 - [AUTO]: HDV signals are converted to DV signals and outputted.
DV signals are outputted without any conversion.
 - [HDV]: HDV signals are converted to DV signals and outputted. DV signals will not be outputted.
 - [DV]: DV signals are outputted without any conversion. HDV signals will not be outputted.

DV REC MODE (DV Recording mode)

This function is available only when you set [REC FORMAT] to [DV].

► SP (SP)

Records in the SP (Standard Play) mode on a cassette.

LP (LP)

Increases the recording time to 1.5 times the SP mode (Long Play).

⚙ Notes

- If you record in the LP mode, a mosaic-like noise may appear or sound may be interrupted when you play back the tape on other camcorders or VCRs.
- When you mix recordings in the SP mode and in the LP mode on one tape, the playback picture may be distorted or the time code may not be written properly between the scenes.
- You cannot choose the LP mode for the HDV format recording.

DV WIDE REC

You can record a movie in an aspect ratio that matches that of a TV that you want to connect. Refer also to the instruction manuals that come with the TV.

► ON

Records a movie in an aspect ratio that matches the full screen of a 16:9 (wide) TV.

OFF (4:3)

Records a movie in an aspect ratio that matches the full screen of a 4:3 TV.

⚙ Notes

- Set [TV TYPE] correctly to suite a TV that you want to connect for playback (p. 79).
- The aspect ratio will be fixed to 16:9 and you cannot set it to 4:3 when you record in HDV format.

COMPONENT

You can select [480i] or [1080i/480i] depending on your TV when you connect your camcorder to a TV via a component A/V cable.

480i

Supports connection between your camcorder and a TV with a component input jack that supports the 480i format.

▶ 1080i/480i

Supports connection between your camcorder and a TV with a component input jack that supports the 1080i format.

i.LINK CONV

You can convert signals in HDV format to DV format, and output pictures in DV format from the  HDV/DV interface (i.LINK).

▶ OFF

Outputs the pictures from the  HDV/DV interface (i.LINK) in accordance with the settings in [REC FORMAT] and [VCR HDV/DV].

ON

Pictures in HDV format are converted to DV format, and pictures in DV format are output in DV format.

Notes

- For input signal via an i.LINK connection, see [VCR HDV/DV] (p. 77).
- Disconnect the i.LINK cable before setting [i.LINK CONV]. Otherwise, the connected video device may not be able to recognize the video signal from your camcorder.

TV TYPE

You need to convert the signal depending on a type of your TV when playing back the picture. The recorded pictures are played back as following illustrations.

▶ 16:9

Select to view your pictures on a 16:9 (wide) TV.

HDV/DV (16:9)
format pictures



DV (4:3) format
pictures



4:3

Select to view your pictures on a 4:3 standard TV.

HDV/DV (16:9)
format pictures



DV (4:3) format
pictures



Notes

- This is not effective for the i.LINK output.
- When you connect your camcorder to a TV compatible with the ID-1 system or via an S VIDEO jack for playing back the tape, set [TV TYPE] to [16:9]. The TV automatically switches the aspect ratio according to the playback picture. Refer also to the manual supplied with your TV.

(MEMORY SET)

menu

Settings for the “Memory Stick Duo” (ALL ERASE/FORMAT, etc.)

The default settings are marked with ►. The indicators in parentheses appear when the items are selected.

See page 62 for details on selecting menu items.

Press the MENU button → select the  (MEMORY SET) with the SEL/PUSH EXEC dial.

ALL ERASE

You can delete all the still images without image protection on a “Memory Stick Duo” or in the selected folder.

- ① Select [ALL FILES] or [CURRENT FLDR].

[ALL FILES]: Deletes all the images on the “Memory Stick Duo.”

[CURRENT FLDR]: Deletes all the images in the currently selected folder.

- ② Select [YES] → [YES] with the SEL/PUSH EXEC dial.
[Erasing all data...] appears.
[Completed.] appears when all unprotected images are deleted.

Notes

- Release the write protect tab on the “Memory Stick Duo” beforehand for the “Memory Stick Duo” with the write-protect tab (p. 111).
- The folder will not be deleted even when you delete all the images in the folder.
- Do not do any of the following while [Erasing all data...] is displayed:
 - Operate the POWER switch/buttons.
 - Eject the “Memory Stick Duo.”

FORMAT

You do not need to format the “Memory Stick Duo” since it is already formatted at the factory. If you want to format the “Memory Stick Duo,” select [YES]→[YES].

Notes

- Do not do any of the following while [Formatting...] is displayed:
 - Operate the POWER switch/buttons.
 - Eject the “Memory Stick Duo.”
- Formatting erases everything on the “Memory Stick Duo” including protected image data and newly created folders.

FILE NO.

► SERIES

Assigns file numbers in sequence even if the “Memory Stick Duo” is replaced with another one. The file number is reset when a new folder is created or the recording folder is replaced with another.

RESET

Resets the file number to 0001 each time the “Memory Stick Duo” is changed.

NEW FOLDER

When you select [YES], you can create a new folder (102MSDCF to 999MSDCF) on a “Memory Stick Duo.” When a folder is full (a maximum of 9,999 images are stored), a new folder is automatically created.

Notes

- You cannot delete the new folder once you have created it on your camcorder. Format the “Memory Stick Duo” (p. 80) or delete it on your computer.
- The number of recordable pictures on a “Memory Stick Duo” may decrease as the number of folders increases.

REC FOLDER (Recording folder)

You can select a folder in which you want to store still images.

Select the folder with the SEL/PUSH EXEC dial.

💡 Tips

- The still images will be stored in the 101MSDCF folder by default.
- Once you store the still images in the current folder, the folder is selected as a playback folder.

PB FOLDER (Playback folder)

You can select a folder in which still images you want to view are stored.

Select the folder with the SEL/PUSH EXEC dial.

(OTHERS) menu

Settings while recording on a tape or other basic settings (QUICK REC/BEEP, etc.)

The default settings are marked with ►. The indicators in parentheses appear when the items are selected.

See page 62 for details on selecting menu items.

Press the MENU button → select the  (OTHERS) with the SEL/PUSH EXEC dial.

CAMERA PROF. (Camera profile)

You can save up to two camera setting profiles in your camcorder. Using these saved profiles let you quickly obtain suitable camera settings later.

💡 Tips

- You can save menu settings, picture profiles and button settings as a camera profile.

■ To load a camera profile

You can load a camera profile and use it on your camcorder.

- ① Select [LOAD] with the SEL/PUSH EXEC dial.
- ② Select the camera profile that you want to load with the SEL/PUSH EXEC dial.
- ③ Select [YES] in the check screen. Your camcorder is restarted and the selected camera profile becomes effective.

■ To save camera profile settings

- ① Select [SAVE] by the SEL/PUSH EXEC dial.
- ② Select [NEW FILE] or an existing profile name by turning the SEL/PUSH EXEC dial.
- ③ Select [YES] in the check screen by turning the SEL/PUSH EXEC dial. The camera profile settings are saved.

💡 Tips

- If you select [NEW FILE], profile name is set to [CAM1] or [CAM2].
- If you select an existing camera profile as a destination, the camera profile is overwritten.

Press the MENU button → select the  (OTHERS) with the SEL/PUSH EXEC dial.

■ To change the camera profile name

You can change the camera profile name.

- ① Select [PROFILE NAME] with the SEL/PUSH EXEC dial.
- ② Select the camera profile of which you want to change the name with the SEL/PUSH EXEC dial.
[PROFILE NAME] screen appears.
- ③ Change the profile name with the SEL/PUSH EXEC dial.

Tips

- You can enter the name in the same way as the picture profile (p. 42).
- ④ Select [OK] with the SEL/PUSH EXEC dial.
Profile name is changed.

■ To delete camera profile settings

- ① Select [DELETE] with the SEL/PUSH EXEC dial.
- ② Select the camera profile you want to delete with the SEL/PUSH EXEC dial.
- ③ Select [YES] on the check screen.

ASSIGN BTN

See page 44.

PHOTO/EXP.FOCUS

You can select a function to assign to the PHOTO/EXPANDED FOCUS button.

▶ PHOTO

Functions as the PHOTO button (p. 30).

EXP.FOCUS

Functions as the EXPANDED FOCUS button (p. 33).

Notes

- If [EXP.FOCUS] is selected, you cannot record still images with the main unit button. Please use the PHOTO button on the Remote Commander.

CLOCK SET

See page 24.

WORLD TIME

When you use your camcorder abroad, you can adjust the clock to the local time by setting the time difference with the SEL/PUSH EXEC dial.

When you set the time difference to 0, the clock returns to the original setting.

LANGUAGE

You can select the language to be used on the LCD screen.

Tips

- Your camcorder offers [ENG[SIMP]] (simplified English) in case that you cannot find your native tongue among the options.

PB ZOOM (Playback zoom)

When you set this function to [ON], you can enlarge movie images about 1.1 to 5 times (still images about 1.5 to 5 times) with the handle zoom lever. The default setting is [OFF]. To end the zoom, press and hold the W side of the handle zoom lever until it stops.

Tips

- To move the zoom horizontally, press the SEL/PUSH EXEC dial, then turn the dial. To move the zoom vertically, press the SEL/PUSH EXEC dial one more time, then turn the dial.

QUICK REC

You can slightly reduce the recording start point time when resuming recording by changing the POWER switch from OFF (CHG) to CAMERA.

▶ OFF

It takes some time to restart recording from the state that the drum has stopped rotating, but the transition from the last recorded scene is smooth.

ON (Q.REC)

The time shortens slightly until recording restarts from the state that the drum has stopped rotating, but the transition from the last recorded scene may not be smooth. Select this when you do not want to miss a recording chance.

💡 Tips

- When this function is set to [ON], the interval between scenes freezes for a moment (editing on your computer is recommended).
- When the camcorder is left in standby for more than about 3 minutes, your camcorder exits from standby (the drum stops rotating) to prevent tape wear and battery loss. Since the power does not turn off, you can restart recording by pressing the REC START/STOP button again.

BEEP**▶ ON**

Activates a melody when you start/stop recording.

OFF

Cancels the melody.

REC LAMP (Recording lamp)

When you set this function to [OFF], you can turn off the camera recording lamps during recording. The default setting is [ON].

REMOTE CTRL (Remote control)

When you set this function to [ON], you can use the supplied Remote Commander (p. 127). The default setting is [ON].

💡 Tips

- Set to [OFF] to prevent your camcorder from responding to a command sent by another VCR remote control unit.

Dubbing to VCR, DVD/HDD device, etc.

Connect your camcorder to the wall outlet (wall socket) using the supplied AC Adaptor for this operation (p. 18). Refer also to the instruction manuals supplied with the devices to be connected.

Connecting to external devices

The connection method and the image quality will differ depending on the VCR, DVD/HDD device and the connectors used.

Jacks on your camcorder

Open the jack cover and connect the cable.

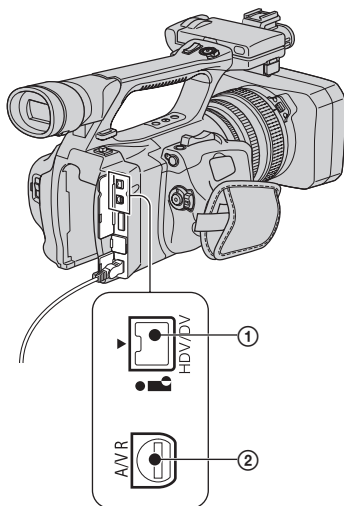

➡ : Signal flow

Camcorder	Cable	External device
-----------	-------	-----------------

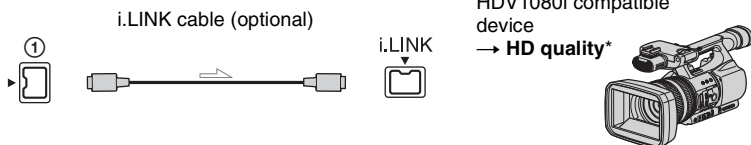

- i.LINK jack which is compatible with HDV1080i specification is required on the external device.

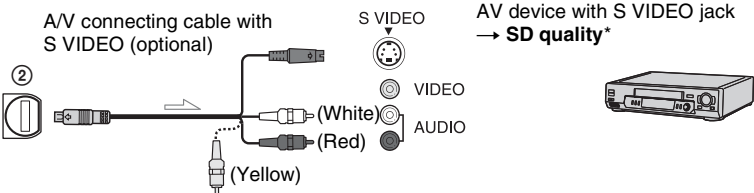
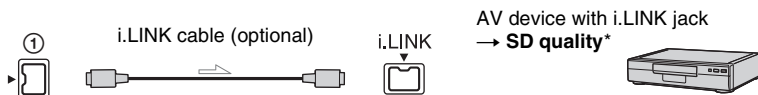

* Pictures recorded in the DV format are dubbed in the SD (standard definition) quality, regardless of the connection.

** When connecting your camcorder to a monaural device, connect the yellow plug of the A/V connecting cable to the video jack on the device, and connect the white (left channel) or red (right channel) plug to the audio jack on the device.

🔊 Notes

- You cannot dub pictures using the HDMI cable.

Using an i.LINK cable (optional)

The dubbed format (HDV/DV) differs depending on the recording format or the format supported by the VCR/DVD device. See the table below for selecting the appropriate settings, and perform necessary menu setting.

Dubbing to VCR, DVD/HDD device, etc. (Continued)

🔊 Notes

- Disconnect the i.LINK cable before changing these menu settings, otherwise the VCR/DVD device may not correctly identify the video signal.

💡 Tips

- This camcorder has a 4-pin i.LINK terminal. Select a cable that fits the terminal on the device to be connected.

Copy format	Camcorder recording format	Format supported by the VCR/DVD device		Menu setting	
		HDV format* ¹	DV format	[VCR HDV/DV] (p. 77)	[i.LINK CONV] (p. 79)
Copy HDV recording as HDV	HDV	HDV	—* ³		[OFF]
Convert HDV recording to DV	HDV	DV	DV	[AUTO]	[ON]
Copy DV recording as DV	DV	DV	DV		[OFF]
When tape is recorded in both HDV and DV format					
Convert both HDV and DV format to DV	HDV/DV	DV	DV	[AUTO]	[ON]
Copy only portions recorded in HDV format	HDV	HDV	—* ³	[HDV]	[OFF]
	DV	—* ²	—* ³		
Copy only portions recorded in DV format	HDV	—* ²	—* ²	[DV]	[OFF]
	DV	DV	DV		

*¹ Recording device compliant with the HDV1080i specification.

*² The tape advances, but no video or sound is recorded (blank).

*³ Picture is not recognized (no recording is made).

🔊 Notes

- When [VCR HDV/DV] is set to [AUTO], and the signal switches between HDV and DV formats, the picture and sound are interrupted temporarily.
- When the recorder is HDR-FX1000, set [VCR HDV/DV] to [AUTO] (p. 77).
- When the player and the recorder are both HDV1080i compatible devices such as HDR-FX1000 and connected with the i.LINK cable, after pausing or stopping and then resuming the recording, the images will be a bit choppy or rough at that point.
- Set [DISP OUTPUT] to [LCD PANEL] (the default setting) when connecting with an A/V connecting cable (p. 77).

When connecting with the A/V connecting cable with S VIDEO (optional)

Connect with S VIDEO jack instead of the video plug (yellow). This connection produces pictures more faithfully. This connection produces higher quality DV format pictures. The audio will not be output when you connect with the S VIDEO cable alone.

Dubbing to another device

1 Prepare your camcorder for playback.

Insert the recorded cassette.
Slide the POWER switch to VCR.

Set [TV TYPE] according to the playback device (TV, etc.) (p. 79).

2 Prepare your VCR/DVD device for recording.

When dubbing to the VCR, insert a cassette for recording.
When dubbing to the DVD recorder, insert a DVD for recording.

If your recording device has an input selector, set it to the appropriate input (such as video input1 and video input2).

3 Connect your VCR/DVD device to your camcorder as a recording device.



See page 84 for connection details.

4 Start playback on the camcorder, and recording on the VCR/DVD device.



Refer to the operating instructions supplied with your recording device for details.

5 When dubbing is complete, stop your camcorder and the VCR/DVD device.

Notes

- The following cannot be output via the  HDV/DV interface (i.LINK):
 - Indicators
 - Titles that are recorded on other camcorder
- Pictures recorded in the HDV format are not output from the  HDV/DV interface (i.LINK) jack during playback pause or in any playback mode other than normal playback.
- Note the following when connecting with an i.LINK cable:
 - The recorded picture becomes rough when a picture is paused on your camcorder while recording to a VCR/DVD device.
 - Data codes (date/time/camera settings data) may not be displayed or recorded depending on the device or application.
 - You cannot record the picture and sound separately.
- When dubbing to a DVD recorder from your camcorder through an i.LINK cable, you may not operate your camcorder on your DVD recorder even if its instruction manual says you can. If you can set the input mode to HDV or DV on your DVD recorder and can input/output pictures, follow the steps in "Using an i.LINK cable (optional)."

Tips

- To record the date/time and camera settings data when connected by the A/V connecting cable, display them on the screen.
- When you use an i.LINK cable, the video and sound signals are transmitted digitally, producing high quality pictures.
- When an i.LINK cable is connected, the format of the output signal (**HDVOUT**  or **DVOUT** ) will be indicated on the LCD screen of your camcorder.

Recording pictures from a VCR

You can record pictures from a VCR on a tape. You can record a scene as a still image on a "Memory Stick Duo." You can record pictures in the HDV format by connecting an HDV1080i specification compatible device. Be sure to insert a cassette or a "Memory Stick Duo" for recording in your camcorder beforehand.

You can connect your camcorder to a VCR device using an i.LINK cable.

Connect your camcorder to the wall outlet (wall socket) using the supplied AC Adaptor for this operation (p. 18). Refer also to the instruction manuals supplied with the devices to be connected.

Notes

- You need an i.LINK cable for this operation.
- You cannot perform this operation with the A/V connecting cable.
- Your camcorder has a 4-pin i.LINK terminal. Select a cable that fits the terminal on the device to be attached.

HDV1080i compatible device

AV device with i.LINK jack



→ HD quality



→ SD quality

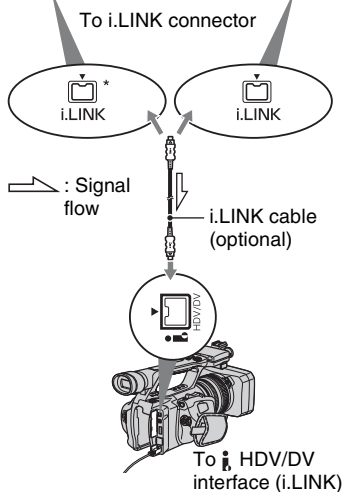

* An i.LINK jack which is compatible with HDV1080i specification is required.

Recording movies

1 Set the POWER switch to VCR.

2 Set the input signal of your camcorder.

Set [VCR HDV/DV] to [AUTO] when recording from an HDV format compatible device.

Set [VCR HDV/DV] to [DV] or [AUTO] when recording from a DV format compatible device (p. 77).

3 Connect your VCR as a player to your camcorder.

When an i.LINK cable is connected, the format of the input signal (HDV IN **i.LINK** or DV IN **i.LINK**) will be indicated on the LCD screen of your camcorder (This indicator may appear on the screen of the playback device but it will not be recorded).

4 Insert a cassette into the VCR.

5 Set your camcorder to recording pause.

While pressing **II** (PAUSE), press both **● REC** (record) buttons simultaneously.

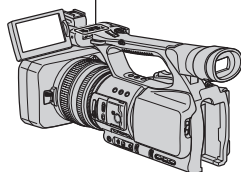

6 Start playing the cassette on your VCR.

The picture played on the VCR appears on the LCD screen of your camcorder.

7 Press **II** (PAUSE) again at the point you want to start recording.

8 Press **■** (STOP) to stop recording.

ⓘ Notes

- You cannot record TV programs from the **i.LINK** HDV/DV interface (i.LINK).
- You can record pictures from DV devices only in the DV format.
- Note the following when connecting with an i.LINK cable:
 - The recorded picture becomes rough when a picture is paused on your camcorder while recording to a VCR.
 - You cannot record the picture and sound separately.
 - If you pause or stop the recording and restart it, the picture may not be recorded smoothly.

💡 Tips

- When a 4:3 video signal is input, it appears with black bands on the right and left sides on the screen of your camcorder.

Recording still images

Be sure to insert a “Memory Stick Duo” for recording in your camcorder beforehand, and set [PHOTO/EXP.FOCUS] to [PHOTO] (the default setting) (p. 82).

1 Perform steps 1 to 4 in “Recording movies.”

2 Start playing the cassette.

The pictures on the VCR appear on the screen of your camcorder.

3 Press the PHOTO/EXPANDED FOCUS button on your camcorder or the PHOTO button on the Remote Commander at the scene you want to record.

Copying movies on a tape to a computer

Connect your camcorder to the computer with an i.LINK cable.

The computer needs to have an i.LINK connector and be installed with editing software that can copy video signals. The software required depends on the format of the recorded pictures and the format for copying to the computer (HDV or DV) as shown in the table below.

Recorded format	Format for copying to the computer	Required software
HDV	HDV	Editing software capable of copying HDV signal
HDV	DV	Editing software capable of copying DV signal
DV	DV	Editing software capable of copying DV signal

Notes

- The **i** HDV/DV jack of your camcorder does not have a power-supply function.
- When you connect your camcorder to a computer via an i.LINK cable, make sure that the terminals of the i.LINK cable are placed the right way. Squeezing the terminals into jacks may damage the terminals and jacks, or result in a malfunction of your camcorder.
- You cannot copy image data stored on a "Memory Stick Duo" onto your computer via an i.LINK cable.
- Refer to the operating instructions of the software for the details on image copying.
- Refer to the operating instructions of the editing software for the recommended connection.
- Some editing software on the computer may not work correctly.
- You cannot change format DV to HDV.

The required menu settings vary depending on the recorded images and the format (HDV or DV) to be copied to the computer.

Recorded format	Format for copying to the computer	Menu setting*
HDV	HDV	[VCR HDV/DV] → [HDV] [i.LINK CONV] → [OFF]
HDV	DV	[VCR HDV/DV] → [HDV] [i.LINK CONV] → [ON]
DV	DV	[VCR HDV/DV] → [DV] [i.LINK CONV] → [OFF]

* See page 62 for menu settings.

Tips

- To copy HDV format images as they are without changing their format, an HDV compatible environment is required. For details, refer to your software instruction manual or contact the software manufacturer.
- To play movies by a regular DVD player, you need to create DVD video in the SD format. The DVD video is not in the HDV format.

Step:1 Connect an i.LINK cable

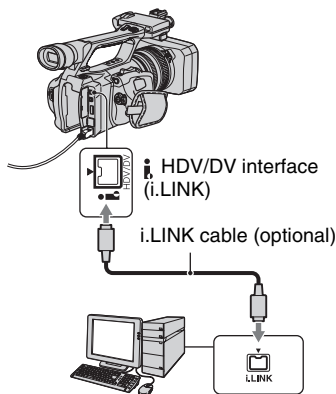

Notes on connecting to the computer

- Connect the i.LINK cable to the computer first, then to your camcorder. Connecting in the opposite order may cause static electricity to build up, resulting in a malfunction of your camcorder.
- The computer may freeze or may not recognize the signal from your camcorder in the following situations.
 - Connecting your camcorder to a computer that does not support the video signal formats appearing on the LCD screen of your camcorder display (HDV or DV).
 - Changing [VCR HDV/DV] (p. 77) and [i.LINK CONV] (p. 79) settings while connected with an i.LINK cable.
 - Changing [REC FORMAT] setting while connected with an i.LINK cable with the POWER switch set to CAMERA (p. 77).
 - Changing the POWER switch position while connected with an i.LINK cable.
- The format (HDV or DV) of input/output signal appears on the LCD screen of your camcorder while connected with an i.LINK cable.

Step:2 Copying the movies

Use the supplied AC Adaptor to obtain AC power (p. 18).

- ① Prepare editing software (not provided).
- ② Turn on your computer.
- ③ Insert a tape into your camcorder and set the POWER switch to VCR.
- ④ Set the menu of your camcorder.
The menu settings vary depending on the copying image.
- ⑤ Copy images to the computer with your software.

Notes

- If images are copied in HDV format but are not recognized, your editing software may not support HDV format. Convert the images to DV format according to step ④ and copy again.
- A tape recorded in DV format cannot be copied to a computer in HDV format.

Tips

- Check the specs, features and latest information of your software on the software manufacturer's website.
- When images recorded in HDV format are copied to a computer, the file size is about 2GB (almost the same as a DV file) for a 10-minute movie if the video compression format is MPEG2.

When copying the movie in the HDV format from the computer to your camcorder

Set [VCR HDV/DV] to [HDV] and [i.LINK CONV] to [OFF] (p. 77, 79).

Notes

- To copy an HDV format movie edited on a computer back onto a tape in HDV format is possible so long as your editing software supports copying HDV movies onto tape. For details, contact the software manufacturer.

When copying the movie in the DV format from the computer to your camcorder

Set [VCR HDV/DV] to [DV] (p. 77).

Copying still images to a computer

System requirements

- For details on precautions and compatible application software, refer also to the operating instructions of the device to be connected.
- Required hardware: “Memory Stick Duo” slot, “Memory Stick” Reader/Writer compatible with “Memory Stick Duo.”

Copying the pictures

For Windows users

You can copy still images stored on a “Memory Stick Duo” to your computer via the “Memory Stick Duo” slot of your computer.

- ① Turn on your computer.
- ② Insert the “Memory Stick Duo” into the “Memory Stick Duo” slot of your computer.
- ③ Double-click the [Removable Disk] icon displayed in [My Computer]. Then, drag and drop a still image from the folder onto the hard disk drive of your computer.

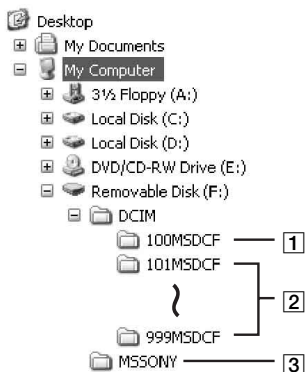

- ① Folder containing image files recorded by other camcorders without the folder creation function (for playback only).

- ② Folder containing image files recorded by your camcorder when no new folders have been created, only [101MSDCF] is displayed.
- ③ Folder containing movie data recorded by other camcorders without the folder creation function (for playback only)

Folder	File	Meaning
101MSDCF (up to 999MSDCF)	DSC0□□ □□.JPG	Still image file

□□□□ are numbers between 0001 and 9999.

For Macintosh users

Double-click the drive icon, then drag and drop the desired picture file onto the hard disk of your computer.

Troubleshooting

If you run into any problems using your camcorder, use the following table to troubleshoot the problem. If the problem persists, disconnect the power source and contact your Sony dealer.

- Power sources/LCD screen/Remote Commander...p. 94
- Cassette tapes/"Memory Stick Duo"...p. 95
- Recording...p. 96
- Playback...p. 99
- Connecting to TV...p. 100
- Dubbing/Editing/Connecting to other devices...p. 101
- Connecting to a computer...p. 103

Power sources/LCD screen/Remote Commander

The power does not turn on or abruptly turns off.

- Attach a charged battery pack to the camcorder (p. 18).
- Use the AC Adaptor to connect to a wall outlet (wall socket) (p. 18).

The camcorder does not operate even when the power is set to on.

- Disconnect the AC Adaptor from the wall outlet (wall socket) or remove the battery pack, then reconnect it after about 1 minute.
- Press the RESET button (p. 124) using a sharp-pointed object.

The camcorder gets warm.

- The camcorder may get warmer while you use it. This is not a malfunction.

The CHG lamp does not light while the battery pack is being charged.

- Slide the POWER switch to OFF (CHG) (p. 18).
- Attach the battery pack to the camcorder correctly (p. 18).
- Connect the power cord (mains lead) to the wall outlet (wall socket) properly.
- The battery charge is completed (p. 18).

The CHG lamp flashes while the battery pack is being charged.

- Attach the battery pack to the camcorder correctly (p. 18). If the problem persists, disconnect the AC Adaptor from the wall outlet (wall socket) and contact your Sony dealer. The battery pack may be damaged.
- When the battery pack is too hot or cold, the CHG lamp may flash slowly, indicating that the battery pack cannot be charged.

The remaining battery time indicator does not indicate the correct time.

- Ambient temperature is too high or too low, or the battery pack has not been charged enough. This is not a malfunction.
- Fully charge the battery again. If the problem persists, the battery may be worn-out. Replace it with a new one (p. 18, 112).

- The indicated time may not be correct in certain circumstances. For example, when you open or close the LCD panel, it takes about 1 minute to display the correct remaining battery time.

The battery pack discharges too quickly.

- Ambient temperature is too high or low, or the battery pack has not been charged enough. This is not a malfunction.
- Fully charge the battery again. If the problem persists, the battery may be worn-out. Replace it with a new one (p. 18, 112).

The picture remains on the LCD screen.

- This occurs if you disconnect the DC plug or remove the battery pack without turning off the power first. This is not a malfunction.

The picture in the viewfinder is not clear.

- Move the viewfinder lens adjustment lever until the picture appears clearly (p. 22).

The picture in the viewfinder has disappeared.

- If you change [VF POWERMODE] to [AUTO], the finder light remains off while the LCD panel is open (p. 76).

The supplied Remote Commander does not function.

- Set [REMOTE CTRL] to [ON] (p. 83).
- Remove any obstructions between the Remote Commander and the remote sensor.
- Keep strong light sources, such as sunlight or overhead lighting, away from the remote sensor, otherwise the Remote Commander may not function properly.
- Insert a fresh battery in the compartment with its +/- terminals matching those of the compartment (p. 127).

Another VCR malfunctions when you use the supplied Remote Commander.

- Select a commander mode other than VTR 2 for your VCR.
- Cover the sensor of your VCR with black paper.

Cassette tapes/“Memory Stick Duo”

The cassette cannot be ejected from the compartment.

- Make sure the power source (battery pack or AC Adaptor) is connected correctly (p. 18).
- Moisture condensation has occurred inside the camcorder (p. 115).

The Cassette Memory indicator or title display does not appear while using a cassette with the Cassette Memory function.

- This camcorder does not support the Cassette Memory function, so the indicator does not appear.

The remaining tape indicator is not displayed.

- Set [REMAINING] to [ON] to always display the remaining tape indicator (p. 76).
-

The cassette is noisier during rewinding or fast-forwarding.

- When using the AC Adaptor, rewind/fast forward speed increases (compared with battery operation) and therefore increases noise. This is not a malfunction.
-

You cannot delete pictures of the “Memory Stick Duo.”

- The pictures are protected. Release the protect function on your computer, etc.
-

Recording

If you are playing back pictures stored on a “Memory Stick Duo,” see also the Cassette tapes/ “Memory Stick Duo” section (p. 95).

The recording does not start when you press the REC START/STOP button.

- Slide the POWER switch to CAMERA (p. 28).
 - The tape has reached the end. Rewind it, or insert a new cassette.
 - Set the write-protect tab of the cassette to REC or insert a new cassette (p. 110).
 - The tape is stuck to the drum due to moisture condensation. Remove the cassette and leave your camcorder for at least 1 hour, then re-insert the cassette (p. 115).
-

The handle zoom does not work.

- Set the handle zoom speed switch to FIX or VAR (p. 31).
-

You cannot record on the “Memory Stick Duo.”

- The “Memory Stick Duo” is full. Delete unnecessary pictures recorded on the “Memory Stick Duo” (p. 50).
 - Format the “Memory Stick Duo” on your camcorder or insert another “Memory Stick Duo” (p. 80).
 - You cannot record still images on the “Memory Stick Duo” in the following cases.
 - While executing [FADER]
 - While executing [SMTH SLW REC]
 - When [PROG.SCAN] is set to [OFF] or [30] and the shutter speed is slower than 1/60
 - When [PROG.SCAN] is set to [24] and the shutter speed is slower than 1/48
 - While using shot transition
 - Set [PHOTO/EXP.FOCUS] to [PHOTO] (p. 82).
-

You cannot record a smooth transition on a tape from the last recorded scene to the next.

- Perform End search (p. 45).
 - Do not remove the cassette (the picture will be recorded continuously without a break even when you turn the power off).
-

- Do not record pictures in the HDV and DV formats on the same tape.
- Do not record pictures in SP mode and LP mode on the same tape. **DV**
- Avoid stopping then recording a movie in the LP mode. **DV**
- When [QUICK REC] is set to [ON], you cannot record a smooth transition (p. 82). **HDV1080i**

The shutter sound is not heard when you record a still image.

- Set [BEEP] to [ON] (p. 83).
- There is no shutter sound while during movie shooting.

End search does not work.

- Do not eject the cassette after recording (p. 45).
- There is nothing recorded on the cassette.
- There is a blank section between recorded sections of the tape. This is not a malfunction.

Automatic focus does not function.

- Set the FOCUS switch to AUTO to enable the automatic focus function (p. 32).
- Adjust the focus manually if the automatic focus does not work properly (p. 32).

Menu items are grayed out or does not work.

- You cannot select gray out display items in the current recording/playback situation.
- There are some functions you cannot activate simultaneously. The following list shows examples of unworkable combinations of functions and menu items.

Cannot use	Situation
[PROG.SCAN]	[INTERVAL REC] is set to [ON].
[CNTRST ENHCR]	[BACK LIGHT] is set to [ON].
[BACK LIGHT]	Two or more of the iris, gain and shutter speed are set manually. [EXPOSURE] is manually adjusted. [SPOTLIGHT] is set to [ON].
[SPOTLIGHT]	Two or more of the iris, gain and shutter speed are set manually. [EXPOSURE] is manually adjusted. [BACK LIGHT] is set to [ON].
[FADER]	No tape is inserted. Moisture condensation has occurred inside the camcorder. The write-protect tab on the cassette is set to SAVE. [INTERVAL REC] is set to [ON].
[ZEBRA], [PEAKING], [CAM DATA DSP], [HISTOGRAM]	[COLOR BAR] is set to [ON].
[SMTH SLW REC]	[PROG.SCAN] is set to [24] or [30]. [COLOR BAR] is set to [ON].

Troubleshooting (Continued)

Cannot use	Situation
[LCD BL LEVEL], [VF B.LIGHT]	AC power source is being used.
[WORLD TIME]	Date and time are not set.
[x.v.Color]	[REC FORMAT] is set to [DV].
[INTERVAL REC]	[PROG.SCAN] is set to [24] or [30].
[DV FRAME REC]	[REC FORMAT] is set to [HDV1080i].

Shutter speed, gain, white balance or iris cannot be adjusted manually.

- Set the AUTO/MANUAL switch to MANUAL.

Tiny spots in white, red, blue, or green appear on the screen.

- This phenomenon appears when using a slow shutter speed (p. 35). This is not a malfunction.

The subjects passing by the frame very fast appear crooked.

- This is called the focal plane phenomenon. This is not a malfunction. Because of the way that the image device (CMOS sensor) reads out image signals, the subjects passing by the frame rapidly might appear crooked depending on the recording conditions.

The screen picture is bright, and the subject does not appear on the screen.

- Set [BACK LIGHT] to [OFF].

The screen picture is dark, and the subject does not appear on the screen.

- Press the DISPLAY/BATT INFO button to turn on the backlight (p. 22).

Horizontal stripes appear on the image.

- This occurs when recording pictures under a fluorescent lamp, sodium lamp, or mercury lamp. This is not a malfunction. This can be improved by changing the shutter speed (p. 35).

Black bands appear when you record a TV screen or computer screen.

- This can be improved by changing the shutter speed (p. 35).

Fine patterns flicker, diagonal lines look jagged.

- Adjust [SHARPNESS] to the negative side (p. 40).

Playback

If you are playing back pictures stored on a “Memory Stick Duo,” see also the Cassette tapes/ “Memory Stick Duo” section (p. 95).

You cannot play back tape.

- Slide the POWER switch to VCR.
- Rewind the tape (p. 49).

Image data stored on a “Memory Stick Duo” cannot be played back correctly.

- Image data cannot be played back if you have modified file names or folders, or have edited the data on a computer (In this case, the file name flashes). This is not a malfunction (p. 112).
- Pictures recorded on other devices may not be played back correctly. This is not a malfunction.

The data file name is displayed incorrectly, or flashing.

- The file is damaged.
- The file format is not supported on your camcorder (p. 111).
- Only the file name is displayed if the folder structure does not meet the universal standard.

Horizontal lines appear on the picture. The displayed pictures are not clear or do not appear.

- Video head is dirty. Clean the head using the cleaning cassette (optional) (p. 116).

You cannot hear the sound recorded with 4CH microphone recording on another camcorder.

- Set [DV AUDIO MIX] (p. 73).
- You cannot reproduce the sound recorded in CH3 and CH4 on your camcorder for the HDV format 4-ch recording.

No sound or only a low sound is heard.

- Turn up the volume (p. 50).
- Set [MULTI-SOUND] to [STEREO] (p. 73).
- Set [DV AUDIO MIX] (p. 73).
- Pictures recorded using [SMTH SLW REC] do not have sounds.

The picture or sound breaks off.

- The tape was recorded in both of the HDV and DV formats. This is not a malfunction.

The movies freeze for a while, or the sound breaks off.

- This occurs if the tape or video head is dirty (p. 116).
 - Use the Sony mini DV cassette tape.
-

“---” is displayed on the screen.

- The tape you are playing back was recorded without setting the date and time.
 - A blank section on the tape is being played back.
 - The data code on a tape with a scratch or noise cannot be read.
 - The tape you are playing was recorded with the gain set to -6dB.
-

Noises appear and **PA1** or **50i** is displayed on the screen.

- The tape was recorded in a TV color system other than that of your camcorder (NTSC). This is not a malfunction.
-

Date Search does not work correctly.

- Be sure to record more than 2 minutes after the date changed. If one day's recording is too short, your camcorder may not accurately find the point where the recording date changes.
 - There is a blank section between recorded sections of the tape. This is not a malfunction.
-

No picture appears during End search or Rec review.

- The tape was recorded in both HDV and DV formats. This is not a malfunction.
-

New sound added to a recorded tape on another camcorder is not heard. **DV**

- Change the [DV AUDIO MIX] setting from [ST1] (original sound) to [MIX] or [ST2].
-

4ch-12b, **24P**, **30P** or **25P** appears on the LCD screen.

- **4ch-12b** appears when you play back a tape recorded on another device using a 4ch microphone (4CH MIC REC). This camcorder does not comply with the 4ch microphone recording standard.
 - **24P**, **30P** or **25P** may appear when you play back a tape recorded on another device in progressive recording mode. Your camcorder does not have progressive recording capability.
-

Connecting to TV

You cannot view the picture on the TV connected with the i.LINK cable.

- You cannot view the picture in the HD (high definition) quality on the TV if an i.LINK jack of the TV is not compatible with the HDV1080i specification (p. 56). Refer to the instruction manuals supplied with your TV.
- Down convert the pictures recorded in HDV format and play back in DV format (SD image quality) (p. 79).
- Connect the TV with another connecting cable, and play back pictures (p. 56).

You cannot hear the sound on the TV connected with the S VIDEO plug (S VIDEO channel) or component video plugs.

- If you are using an S VIDEO plug or component video plugs, make sure the red and white plugs are also connected (p. 56).

You cannot view the picture or hear the sound on the TV connected with the component A/V cable.

- Set [COMPONENT] according to the requirements of the connected device (p. 79).
- When you are using the component A/V cable, make sure the red and white plugs of the component A/V cable are connected (p. 56).

You cannot view the picture or hear the sound on the TV connected with the HDMI cable.

- Pictures in the HDV format are not output from the HDMI OUT jack, if copyright protection signals are recorded in the pictures.
- DV format pictures input to the camcorder via i.LINK cable (p. 84) cannot be output.
- This occurs if you record on a tape in both HDV and DV formats. Disconnect and connect the HDMI cable, or slide the POWER switch to turn on your camcorder again.

The picture appears distorted on the 4:3 TV.

- This happens when viewing a picture recorded in the 16:9 (wide) mode on a 4:3 TV. Set [TV TYPE] and play back the picture (p. 79).

Black zone appears at top and bottom of a 4:3 TV screen.

- This happens when viewing a picture recorded in the 16:9 (wide) mode on a 4:3 TV. This is not a malfunction.

Dubbing/Editing/Connecting to other devices

Pictures from connected devices cannot be zoomed.

- You cannot zoom pictures from connected devices on your camcorder (p. 31).

Time code and other information appear on the display of the connected device.

- Set [DISP OUTPUT] to [LCD PANEL] while connected with an A/V connecting cable (p. 77).

You cannot dub correctly using the A/V connecting cable.

- The A/V connecting cable is not connected properly.
Make sure that the A/V connecting cable is connected to the input jack of the other device for dubbing a picture from your camcorder.

When connected using an i.LINK cable, no picture appears on the monitor screen during dubbing.

- Set [VCR HDV/DV] according to the requirements of the connected device (p. 77).
-

You cannot add sound to the recorded tape.

- You cannot add sound to the recorded tape on this unit.
-

You cannot dub correctly using the HDMI cable.

- You cannot dub pictures using the HDMI cable.
-

Still pictures cannot be dubbed from a tape to a “Memory Stick Duo.”

- You cannot capture pictures at all or good-quality pictures from the tape that has been used repeatedly for recording.
-

When you copy a movie shot in wide (16:9) format using an i.LINK cable, the screen stretches vertically.

- You cannot output the aspect ratio setting using an i.LINK cable. Set the aspect ratio of the TV instead.
- Connect using an A/V connecting cable instead.

Connecting to a computer

The computer does not recognize your camcorder.

- Disconnect the cable from the computer and camcorder, then connect it again securely.
- Disconnect the cable from the computer, restart the computer, then connect the computer to your camcorder correctly.

You cannot view or copy a movie recorded on a tape to a computer. [i.LINK](#)

- Disconnect the cable from the computer, then connect it again.
- You need the editing software (optional) to copy a movie recorded on a tape to your computer (p. 91).

Your computer freezes.

- Set [VCR HDV/DV] correctly according to the connected device (p. 77).
- Disconnect the cable from your computer and camcorder. Reboot your computer, and connect your computer and camcorder following the steps in the correct order (p. 91).

Warning indicators and messages

Self-diagnosis display/Warning indicators

When an error occurs, a warning indicator appears on the LCD screen or in the viewfinder.

Some symptoms you can fix by yourself. If the problem persists even after you have tried a couple of times, contact your Sony dealer or local authorized Sony service facility.

C: (or E): □□:□□ (Self-diagnosis display)

C:04:□□

- The battery pack is not an “InfoLITHIUM” battery pack. Use an “InfoLITHIUM” battery pack (p. 112).
- Connect the DC plug of the AC Adaptor to the DC IN jack of your camcorder securely (p. 18).

C:06:□□

- The battery pack is too hot. Replace the battery pack, or remove it and put it in a cool place.

C:21:□□

- Moisture condensation has occurred. Remove the cassette and leave your camcorder for at least 1 hour, then reinsert the cassette (p. 115).

C:22:□□

- Clean the head using a cleaning cassette (optional) (p. 116).

C:31:□□ / C:32:□□

- Symptoms that are not described above have occurred. Remove and insert the cassette, then operate your camcorder again. Do not perform this procedure if moisture condensation has occurred (p. 115).
- Remove the power source. Reconnect it and operate your camcorder again.
- Change the cassette. Press the RESET button (p. 124), and operate your camcorder again.

E:61:□□ / E:62:□□

- Contact your Sony dealer or local authorized Sony service facility. Inform them of the 5-digit code, which starts from “E.”

101-1001(Warning indicator pertaining to files)

- The file is damaged.
- The file is unreadable (p. 112).

(Battery level warning)

- The battery pack is nearly used up.
- Depending on the operating, environment, or battery conditions,  may flash, even if there are approximately 5 to 10 minutes remaining.

(Moisture condensation warning)

- Eject the cassette, remove the power source, and then leave it for about 1 hour with the cassette lid open (p. 115).

(Warning indicator pertaining to “Memory Stick Duo”)



- A “Memory Stick Duo” is not inserted (p. 26).

(Warning indicators pertaining to “Memory Stick Duo” formatting)

- The “Memory Stick Duo” is damaged.
- The “Memory Stick Duo” is not formatted correctly (p. 80, 111).

(Warning indicators pertaining to unsupported “Memory Stick Duo”)

- A “Memory Stick Duo” that cannot be used in your camcorder is inserted (p. 111).

  (Warning indicator pertaining to battery pack temperature)

- The battery pack is too hot. Replace the battery pack, or remove it and put it in a cool place.

 (Warning indicator pertaining to battery pack temperature)

- The battery pack is too cold. Replace the battery pack, or remove it and put it in a warm place.

 (Warning indicators pertaining to the tape)

Slow flashing:

- There is less than 5 minutes remaining on the tape.
- No cassette is inserted.
- The write-protect tab on the cassette is set to lock (p. 110).

Fast flashing:

- The tape has run out.



 (Eject cassette warning)

Slow flashing:

- The write-protect tab on the cassette is set to lock (p. 110).

Fast flashing:

- Moisture condensation has occurred (p. 115).
- The self-diagnosis display code is displayed (p. 104).

  (Warning indicator pertaining to the write-protect of the “Memory Stick Duo”)

- The write-protect tab on the “Memory Stick Duo” is set to lock (p. 111).

 **Tips**

- You will hear a beep when certain messages appear on the screen.



Description of warning messages

If messages appear on the screen, follow the instructions.

■ **Battery/Power**

Cannot use this battery in the camcorder. (p. 112)

■ **Moisture condensation**

  **Moisture condensation. Eject the cassette** (p. 115)

 **Moisture condensation. Turn off for 1H.** (p. 115)

■ **Cassette/Tape**

 **Reinsert the cassette.** (p. 26)

- Check if the cassette is damaged.

  **The tape is locked - check the tab.** (p. 110)

■ **“Memory Stick Duo”**

 **Reinsert the Memory Stick.** (p. 26, 111)

- Reinsert the “Memory Stick Duo” a few times. If even then the indicator flashes, the “Memory Stick Duo” might be damaged. Try with another “Memory Stick Duo.”

 **This Memory Stick is not formatted correctly.**

- Check the format, then format the “Memory Stick Duo” as necessary (p. 80, 111).

Memory Stick folders are full.

- You cannot create folders exceeding 999MSDCF. You cannot delete created folders using your camcorder.
 - You will have to format the “Memory Stick Duo” (p. 80), or delete them using your computer.
-

Cannot record still images on Memory Stick.

- You cannot record still images in the following cases:
 - When [PROG.SCAN] is set to [OFF] or [30] and the shutter speed is slower than 1/60
 - When [PROG.SCAN] is set to [24] and the shutter speed is slower than 1/48
 - While using [FADER]
 - While using [SMTH SLW REC]
 - While checking or executing shot transition

■ Others

No output image in “VCR HDV/DV.” Change format.

- Stop playback or signal input, or change [VCR HDV/DV] setting (p. 77).
-

Using your camcorder abroad

Power supply

You can use your camcorder in any country/region using the AC Adaptor supplied with your camcorder within the AC 100 V to 240 V, 50/60 Hz range.

Use a commercially available AC plug adaptor [a], if necessary, depending on the design of the wall outlet [b].

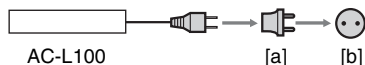

Representative plug of power supply cord of countries/regions around the world.



The representative supply voltage and plug type are described in this chart.

Depend on an area, Different type of plug and supply voltage are used.

Attention: Power cord meeting demands from each country shall be used.

-For only the United States

Use a UL Listed, 1.5-3 m (5-10 ft.), Type SPT-2 or NISPT-2, AWG no. 18 power supply cord, rated for 125 V 7 A, with a NEMA 1-15P plug rated for 125 V 15 A.”

Europe

Countries/regions	Voltage	Frequency (Hz)	Plug type
Austria	230	50	C
Belgium	230	50	C
Czech	220	50	C
Denmark	230	50	C
Finland	230	50	C
France	230	50	C
Germany	230	50	C
Greece	220	50	C
Hungary	220	50	C
Iceland	230	50	C
Ireland	230	50	C/BF
Italy	220	50	C
Luxemburg	230	50	C
Netherlands	230	50	C
Norway	230	50	C
Poland	220	50	C
Portugal	230	50	C
Romania	220	50	C
Russia	220	50	C
Slovak	220	50	C
Spain	127/230	50	C
Sweden	230	50	C
Switzerland	230	50	C
UK	240	50	BF

Asia

Countries/regions	Voltage	Frequency (Hz)	Plug type
China	220	50	A
Hong Kong	200/220	50	BF
India	230/240	50	C
Indonesia	127/230	50	C
Japan	100	50/60	A
Korea (rep)	220	60	C
Malaysia	240	50	BF

Using your camcorder abroad (Continued)

Philippines	220/230	60	A/C
Singapore	230	50	BF
Taiwan	110	60	A
Thailand	220	50	C/BF
Vietnam	220	50	A/C

Oceania

Countries/regions	Voltage	Frequency (Hz)	Plug type
Australia	240	50	O
New Zealand	230/240	50	O

North America

Countries/regions	Voltage	Frequency (Hz)	Plug type
Canada	120	60	A
USA	120	60	A

Central America

Countries/regions	Voltage	Frequency (Hz)	Plug type
Bahamas	120/240	60	A
Costa Rica	110	60	A
Cuba	110/220	60	A/C
Dominican (rep)	110	60	A
El Salvador	110	60	A
Guatemala	120	60	A
Honduras	110	60	A
Jamaica	110	50	A
Mexico	120/127	60	A
Nicaragua	120/240	60	A
Panama	110/220	60	A

South America

Countries/regions	Voltage	Frequency (Hz)	Plug type
Argentina	220	50	C/BF/O
Brazil	127/220	60	A/C
Chile	220	50	C
Colombia	120	60	A
Peru	220	60	A/C
Venezuela	120	60	A

Middle East

Countries/regions	Voltage	Frequency (Hz)	Plug type
Iran	220	50	C/BF
Iraq	220	50	C/BF
Israel	230	50	C
Saudi Arabia	127/220	50	A/C/BF
Turkey	220	50	C
UAE	240	50	C/BF

Africa

Countries/regions	Voltage	Frequency (Hz)	Plug type
Algeria	127/220	50	C
Congo (dem)	220	50	C
Egypt	220	50	C
Ethiopia	220	50	C
Kenya	240	50	C/BF
Nigeria	230	50	C/BF
South Africa	220/230	50	C/BF
Tanzania	230	50	C/BF
Tunisia	220	50	C

On TV color systems

Your camcorder is NTSC system, so its picture can only be viewed on an NTSC system TV with an AUDIO/VIDEO input jack.

System	Used in
NTSC	Bahama Islands, Bolivia, Canada, Central America, Chile, Colombia, Ecuador, Guyana, Jamaica, Japan, Korea, Mexico, Peru, Surinam, Taiwan, the Philippines, the U.S.A., Venezuela, etc.
PAL	Australia, Austria, Belgium, China, Czech Republic, Denmark, Finland, Germany, Holland, Hong Kong, Hungary, Italy, Kuwait, Malaysia, New Zealand, Norway, Poland, Portugal, Singapore, Slovak Republic, Spain, Sweden, Switzerland, Thailand, United Kingdom, etc.
PAL - M	Brazil
PAL - N	Argentina, Paraguay, Uruguay.
SECAM	Bulgaria, France, Guiana, Iran, Iraq, Monaco, Russia, Ukraine, etc.

Viewing HDV format pictures recorded in HDV format

You need an HDV1080i compatible TV (or monitor) with a component jack and AUDIO/VIDEO input jack. You also need a component A/V cable (supplied) or an HDMI cable (optional).

Viewing DV format pictures recorded in DV format

You need a TV with the AUDIO/VIDEO input jack. A connecting cable is also needed.

Simple setting of the clock by time difference

When you are abroad, you can easily adjust the clock to the local time by setting the time difference. Select [WORLD TIME], then set the time difference (p. 82).

Maintenance and precautions

HDV format and recording/ playback

Your camcorder is capable of recording in both HDV and DV formats.
You can use mini DV format cassettes only.
Use a cassette with the ^{Mini}DV mark.
Your camcorder is not compatible with the Cassette Memory function.

What is the HDV format?

The HDV format is a video format developed to record and play back digital high definition (HD) video signals on a DV cassette.

Your camcorder adopts the Interlace mode with 1,080 effective scan lines of screen ruling (1080i, number of pixels 1,440 × 1,080 dots).

The video bit rate for recording is about 25 Mbps.

i.LINK is adopted for the digital interface, enabling a digital connection with an HDV compatible TV or computer.

- HDV signals are compressed in MPEG2 format, which is adopted in BS (broadcast satellite) digital, terrestrial digital HDTV broadcastings, in Blu-ray Disc recorders, etc.

Playback

Your camcorder can play back pictures in both the DV format and HDV1080i specification.

Your camcorder can play back pictures recorded in the HDV 720/30p format, but cannot output it from the  HDV/DV interface (i.LINK).

To prevent a blank section from being created on the tape

Go to the end of the recorded section using [END SEARCH] (p. 45) before you begin the next recording when you have played back the tape.

Copyright signal

■ When you play back

If the cassette you play back on your camcorder contains copyright signals, you cannot copy it to a tape in another video camera connected to your camcorder.

■ When you record

You cannot record software on your camcorder that contains copyright control signals for copyright protection of software. [Cannot record due to copyright protection.] appears on the LCD screen, or on the viewfinder if you try to record such software. Your camcorder does not record copyright control signals on the tape when it records.

Notes on use

■ When not using your camcorder for a long time

Remove the cassette and store it.

■ To prevent accidental erasure

Slide the write-protect tab on the cassette to set it to SAVE.

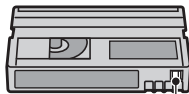

REC: The cassette can be recorded.

SAVE: The cassette cannot be recorded (write-protected).



■ When labeling the cassette

Be sure to place the label only on the locations shown in the following illustration so as not to cause a malfunction of your camcorder.

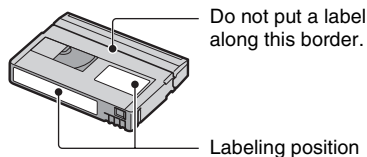

■ After using the cassette

Rewind the tape to the beginning to avoid distortion of the picture or the sound. The cassette should then be put in its case, and stored in an upright position.

■ When cleaning the gold-plated connector

Generally, clean the gold-plated connector on a cassette with a cotton-wool swab after every 10 times it has been ejected. If the gold-plated connector on the cassette is dirty or dusty, the remaining tape indicator may not show correctly.

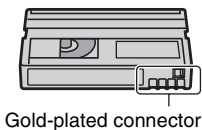

About the "Memory Stick"

A "Memory Stick" is a compact, portable IC recording medium with a large data capacity.

You can use the following types of "Memory Stick" listed below on the camcorder. However, we do not guarantee the operation of all types of "Memory Stick" on your camcorder. (See the list below for more details.)

Types of "Memory Stick"	Recording /Playback
Memory Stick Duo (with MagicGate)	○
Memory Stick PRO Duo	○
Memory Stick PRO-HG Duo	○

- This product does not support high speed data transfer via a parallel interface.
- This product cannot record or play data that uses "MagicGate" technology. "MagicGate" is a copyright protection technology that records and transfers the contents in an encrypted format.
- This product is compatible with "Memory Stick Micro" ("M2"). "M2" is the abbreviation for the "Memory Stick Micro."
- Still image format: Your camcorder compresses and records image data in the JPEG (Joint Photographic Experts Group) format. The file extension is ".JPG."
- A "Memory Stick Duo" formatted by a computer (Windows OS/Mac OS) does not have guaranteed compatibility with your camcorder.
- Data read/write speed may vary depending on the combination of the "Memory Stick Duo" and "Memory Stick Duo" compliant product you use.
- You can prevent accidental erasure of images when you slide the write-protect tab on the "Memory Stick Duo" with a small tapered object, to the write-protect position.
- Damaged or lost image data will not be compensated for, and may occur in the following cases:
 - If you eject the "Memory Stick Duo," turn the power off on your camcorder, or remove the battery pack for replacement while your camcorder is reading or writing image files on the "Memory Stick Duo" (while the access lamp is lit or flashing).
 - If you use the "Memory Stick Duo" near magnets or magnetic fields.
- It is recommended to make a back-up of important data on the hard disk of a computer.
- Be careful not to apply excessive force when writing on a memo area on a "Memory Stick Duo."
- Do not attach a label or the like on a "Memory Stick Duo" or a "Memory Stick Duo" adaptor.
- When you carry or store a "Memory Stick Duo," put it in its case.

Maintenance and precautions (Continued)

- Do not touch, or allow metallic objects to come into contact with the terminals.
- Do not bend, drop or apply strong force to the “Memory Stick Duo.”
- Do not disassemble or modify the “Memory Stick Duo.”
- Do not let the “Memory Stick Duo” get wet.
- Be careful to keep “Memory Stick Duo” media out of the reach of small children. There is danger that a child might swallow it.
- Do not insert anything other than a “Memory Stick Duo” into the “Memory Stick Duo” slot. Doing so may cause a malfunction.
- Do not use or keep the “Memory Stick Duo” in the following locations:
 - Places subject to extremely high temperature, such as a car parked outside in the summer.
 - Places under direct sunlight.
 - Places with extremely high humidity or subject to corrosive gases.

■ On the “Memory Stick Duo” adaptor

- When using a “Memory Stick Duo” with a “Memory Stick” compliant device, make sure to insert the “Memory Stick Duo” into a “Memory Stick Duo” adaptor.
- When inserting a “Memory Stick Duo” into a “Memory Stick Duo” adaptor, make sure the “Memory Stick Duo” is inserted facing in the correct direction, then insert it all the way in. Note that improper use may cause a malfunction. Also, if you force the “Memory Stick Duo” into the “Memory Stick Duo” adaptor in the wrong direction, it may be damaged.
- Do not insert a “Memory Stick Duo” adaptor without a “Memory Stick Duo” attached. Doing so may result in malfunctions of the unit.

■ On a “Memory Stick PRO Duo”

- The maximum memory capacity of a “Memory Stick PRO Duo” that can be used on your camcorder is 16 GB.

Notes on using “Memory Stick Micro”

- To use a “Memory Stick Micro” with the camcorder, you need a Duo-sized M2 Adaptor. Insert the “Memory Stick Micro” into the Duo-sized M2 Adaptor, then insert the adaptor into the “Memory Stick Duo” slot. If you insert a “Memory Stick Micro” into the camcorder without using a Duo-sized M2 Adaptor, you

might not be able to remove it from the camcorder.

- Do not leave the “Memory Stick Micro” within the reach of small children. They might accidentally swallow it.

On image data compatibility

- Image data files recorded on a “Memory Stick Duo” by your camcorder conform to the “Design rule for Camera File system” universal standard established by the JEITA (Japan Electronics and Information Technology Industries Association).
- On your camcorder, you cannot play back still images recorded on other devices (DCR-TRV900 or DSC-D700/D770) that do not conform to the universal standard. (These models are not sold in some regions.)
- If you cannot use a “Memory Stick Duo” that has been used with another device, format it with your camcorder (p. 80). Note that formatting erases all information on the “Memory Stick Duo.”
- You may not be able to play back images with your camcorder:
 - When playing back image data modified on your computer.
 - When playing back image data recorded with other devices.

About the “InfoLITHIUM” battery pack

This unit is compatible with an “InfoLITHIUM” battery pack (L series). Your camcorder operates only with an “InfoLITHIUM” battery pack. “InfoLITHIUM” L series battery packs have the  mark.

What is an “InfoLITHIUM” battery pack?

An “InfoLITHIUM” battery pack is a lithium-ion battery pack that has functions for communicating information related to operating conditions between your camcorder and an AC Adaptor/ Charger. The “InfoLITHIUM” battery pack calculates the power consumption

according to the operating conditions of your camcorder, and displays the remaining battery time in minutes.

With an AC Adaptor/Charger, the remaining battery time and charging time appear.

To charge the battery pack

- Be sure to charge the battery pack before you start using your camcorder.
- We recommend charging the battery pack in an ambient temperature of between 10 °C to 30 °C (50 °F to 86 °F) until the CHG lamp turns off. If you charge the battery pack outside of this temperature range, you may not be able to charge it efficiently.
- After charging is complete, disconnect the cable from the DC IN jack on your camcorder or remove the battery pack.

To use the battery pack effectively

- Battery pack performance decreases when the surrounding temperature is 10 °C (50 °F) or below, and the length of time you can use the battery pack becomes shorter. In that case, do one of the following to use the battery pack for a longer time.
 - Put the battery pack in a pocket to warm it up, and insert it in your camcorder right before you start taking shots.
 - Use a large capacity battery pack: NP-F770/F970 (optional).
- Frequent use of the LCD screen or a frequent playback, fast forward or rewind operation wears out the battery pack faster. We recommend using a large capacity battery pack: NP-F770/F970.
- Be sure to set the POWER switch to OFF (CHG) when not recording or playing back on your camcorder. The battery pack is also consumed when your camcorder is in recording standby or playback pause.
- Have spare battery packs ready for two or three times the expected recording time, and make trial recordings before making the actual recording.
- Do not expose the battery pack to water. The battery pack is not water resistant.

About the remaining battery time indicator

- When the power goes off even though the remaining battery time indicator indicates that the battery pack has enough power to operate, charge the battery pack fully again. Remaining battery time will be indicated correctly. Note, however, that the battery indication will not be restored if it is used in high temperatures for a long time, or if left in a fully charged state, or when the battery pack is frequently used. Use the remaining battery time indication as a rough guide only.
- The  mark that indicates low battery flashes even if there are still 5 to 10 minutes of battery time remaining, depending on the operating conditions or ambient temperature.

About storage of the battery pack

- If the battery pack is not used for a long time, fully charge the battery pack and use it up on your camcorder once a year to maintain proper function. To store the battery pack, remove it from your camcorder and put it in a dry, cool place.
- To discharge the battery pack on your camcorder completely, leave your camcorder in tape recording standby until the power goes off (p. 21).

About battery life

- Battery capacity decreases over time and through repeated use. If decreased usage time between charges becomes significant, it is probably time to replace it with a new one.
- Each battery's life is governed by storage, operating and environmental conditions.

About i.LINK

The  HDV/DV (i.LINK) jack on your camcorder is an i.LINK-compliant 4-pin jack. This section describes the i.LINK standard and its features.

What is i.LINK?

i.LINK is a digital serial interface for transferring digital video, digital audio, and other data to other i.LINK-compatible

Maintenance and precautions (Continued)

devices. You can also control other devices using the i.LINK.

i.LINK-compatible devices can be connected using an i.LINK cable. Possible applications are operations and data transactions with various digital AV devices.

When two or more i.LINK-compatible devices are daisy-chained with the unit, operation becomes possible from any device in the chain. Note that operation method may vary, or data transactions may not be possible, depending on specifications and characteristics of the connected devices.

🔊 Notes

- Normally, only one device can be connected to this unit with an i.LINK cable. When connecting this unit to an HDV/DV compatible device having two or more  HDV/DV interfaces, refer to the operating instructions of the device to be connected.
- i.LINK is a more familiar term for the IEEE 1394 data transport bus proposed by Sony, and is a trademark approved by many corporations.
- IEEE 1394 is an international standard standardized by the Institute of Electrical and Electronics Engineers.

About the i.LINK Baud rate

i.LINK's maximum baud rate varies according to the device. There are 3 types.

S100 (approx. 100Mbps*)

S200 (approx. 200Mbps)

S400 (approx. 400Mbps)

The baud rate is listed under "Specifications" in the operating instructions of each piece of equipment. It is also indicated near the i.LINK interface on some devices.

The baud rate may differ from the indicated value when the unit is connected to a device with a different maximum baud rate.

* What is Mbps?

Mbps stands for "megabits per second," or the amount of data that can be sent or

received in one second. For example, a baud rate of 100 Mbps means that 100 megabits of data can be sent in one second.

To use i.LINK functions on this unit

For details on how to dub when this unit is connected to other video devices having an i.LINK interface, see page 87.

This unit can also be connected to other i.LINK-compatible devices made by Sony (for example, a VAIIO series personal computer) as well as to video devices. Some i.LINK compatible video devices, such as Digital Televisions, DVD, MICROMV or HDV recorders/players are not compatible with this unit. Before connecting to other devices, be sure to confirm whether the device is compatible with an HDV/DV device or not. For details on precautions and compatible application software, refer also to the operating instructions for the device to be connected.

🔊 Notes

- When connecting a device with an i.LINK terminal to your camcorder via an i.LINK cable, switch off the device and unplug it from the power socket before plugging in or unplugging the i.LINK cable.

About the required i.LINK cable

- Use the Sony i.LINK 4-pin-to-4-pin cable (during HDV/DV dubbing).

About x.v.Color

- x.v.Color is a more familiar term for the xvYCC standard proposed by Sony, and is a trademark of Sony.
- xvYCC is an international standard for color space in video. This standard can express a wider color range than the currently used broadcast standard.

About handling of your camcorder

On use and care

- Do not use or store the camcorder and accessories in the following locations.
 - Anywhere extremely hot or cold. Never leave them exposed to temperatures above 60 °C (140 °F), such as under direct sunlight, near heaters or in a car parked in the sun. They may malfunction or become deformed.
 - Near strong magnetic fields or mechanical vibration. The camcorder may malfunction.
 - Near strong radio waves or radiation. The camcorder may not be able to record properly.
 - Near AM receivers and video equipment. Noise may occur.
 - On a sandy beach or anywhere dusty. If sand or dust gets in your camcorder, it may malfunction. Sometimes this malfunction cannot be repaired.
 - Near windows or outdoors, where the LCD screen, the viewfinder, or the lens may be exposed to direct sunlight. This damages the inside of the viewfinder or the LCD screen.
 - Anywhere very humid.
- Operate your camcorder on DC 7.2 V (battery pack) or DC 8.4 V (AC Adaptor).
- For DC or AC operation, use the accessories recommended in these operating instructions.
- Do not let your camcorder get wet, for example, from rain or sea water. If your camcorder gets wet, it may malfunction. Sometimes this malfunction cannot be repaired.
- If any solid object or liquid gets inside the casing, unplug your camcorder and have it checked by a Sony dealer before operating it any further.
- Avoid rough handling, disassembling, modifying, physical shock, or impact such as hammering, dropping or stepping on the product. Be particularly careful of the lens.
- Do not use a deformed or damaged battery pack.
- Keep the POWER switch setting to OFF (CHG) when you are not using your camcorder.
- Do not wrap your camcorder with a towel, for example, and operate it. Doing so might cause heat to build up inside.
- When disconnecting the power cord (mains lead), pull it by the plug and not the cord.

- Do not damage the power cord (mains lead) such as by placing anything heavy on it.
- Keep metal contacts clean.
- Keep the Remote Commander and button-type battery out of children's reach. If the battery is accidentally swallowed, consult a doctor immediately.
- If the battery electrolytic liquid has leaked,
 - consult your local authorized Sony service facility.
 - wash off any liquid that may have contacted your skin.
 - if any liquid gets in your eyes, wash with plenty of water and consult a doctor.

■ When not using your camcorder for a long time



- Periodically turn on the camcorder and play a cassette for about 3 minutes.
- Use up the battery pack completely before storing it.

Moisture condensation

If your camcorder is brought directly from a cold place to a warm place, moisture may condense inside your camcorder, on the surface of the tape, or on the lens. In this state, the tape may stick to the head drum and be damaged or your camcorder may not operate correctly. If there is moisture inside your camcorder, [Moisture condensation. Eject the cassette] or [Moisture condensation. Turn off for 1H.] appears. The indicator will not appear when the moisture condenses on the lens.

■ If moisture condensation has occurred

None of the functions except cassette ejection will work. Eject the cassette, turn off your camcorder, and leave it for about one hour with the cassette lid open. Your camcorder can be used again when both of the following conditions are met:

- The warning message does not appear when the power is turned on.
- Neither  nor  flashes when a cassette is inserted and the video operation buttons are pressed.

If moisture starts to condense, your camcorder sometimes cannot detect

Maintenance and precautions (Continued)

condensation. If this happens, the cassette is sometimes not ejected for 10 seconds after the cassette lid is opened. This is not a malfunction. Do not close the cassette lid until the cassette is ejected.

Note on moisture condensation

Moisture may condense when you bring your camcorder from a cold place into a warm place (or vice versa) or when you use your camcorder in a humid place as shown below.

- When you bring your camcorder from a ski slope into a place warmed up by a heating device.
- When you bring your camcorder from an air conditioned car or room into a hot place outside.
- When you use your camcorder after a squall or a shower.
- When you use your camcorder in a hot and humid place.

How to avoid moisture condensation

When you bring your camcorder from a cold place into a warm place, put your camcorder in a plastic bag and seal it tightly. Remove the bag when the air temperature inside the plastic bag has reached the surrounding temperature (after about one hour).

Video head

If you play back a tape recorded in HDV format, the image and sound may freeze for a while (about 0.5 seconds).

This occurs if the HDV signals cannot be recorded or played back correctly because of dirt on the tape or video head. Depending on the cassette, this fairly infrequently occurs even if the cassette is brand new or is not used a lot.

If this freezing point is created while playing back, you can solve this problem and see the pictures by rewinding after slightly forwarding. Such a freezing point cannot be recovered if it was created while recording.

To prevent such a problem, use the Sony mini DV cassette.

- If the following problem occurs, clean the video heads for 10 seconds with the Sony cleaning cassette (optional).
 - Playback pictures do not move.
 - Playback pictures do not appear.
 - The sound breaks off.
 - [⊗] Dirty video head. Use a cleaning cassette.] appears on the screen during recording.
 - The following phenomenon occurs in HDV format.



The playback screen pauses.



The playback screen goes blank. (Solid blue screen)

- The following phenomenon occurs in DV format.



Block-noise appears.



The playback screen goes blank. (Solid blue screen)

- The video heads will be worn after long use. If you cannot obtain a clear image even after using a cleaning cassette (optional), the video heads may be worn out. Please contact your Sony dealer or local authorized Sony service facility to have the video heads replaced.

LCD screen

- Do not exert excessive pressure on the LCD screen, as it may cause damage.
- If your camcorder is used in a cold place, a residual image may appear on the LCD screen. This is not a malfunction.
- While using your camcorder, the back of the LCD screen may heat up. This is not a malfunction.

■ To clean the LCD screen

If fingerprints or dust make the LCD screen dirty, it is recommended you use a soft cloth to clean it. When you use the LCD Cleaning Kit (optional), do not apply the cleaning liquid directly to the LCD screen. Use cleaning paper moistened with the liquid.

On handling the casing

- If the casing is soiled, clean the camcorder body with a soft cloth lightly moistened with water, and then wipe the casing with a dry soft cloth.
- Avoid the following to avoid damage to the finish.
 - Using chemicals such as thinner, benzene, alcohol, chemical cloths, repellent, insecticide and sunscreen.
 - Handling with above substances on your hands.
 - Leaving the casing in contact with rubber or vinyl objects for a long period of time.

About care and storage of the lens

- Wipe the surface of the lens clean with a soft cloth in the following instances:
 - When there are fingerprints on the lens surface.
 - In hot or humid locations
 - When the lens is exposed to salty air such as at the seaside.
- Store in a well-ventilated location subject to little dirt or dust.
- To prevent mold, periodically clean the lens as described above. It is recommended that you operate your camcorder about once a month to keep it in optimum state for a long time.

On charging the pre-installed rechargeable battery

Your camcorder has a pre-installed rechargeable battery to retain the date, time, and other settings even when the POWER switch is set to OFF (CHG). The pre-installed rechargeable battery is always charged while your camcorder is connected to the wall outlet (wall socket) via the AC Adaptor or while the battery pack is inserted. The rechargeable battery will be

fully discharged in about **3 months** if you do not use your camcorder at all without the AC Adaptor connected or the battery pack attached. Use your camcorder after charging the pre-installed rechargeable battery.

However, even if the pre-installed rechargeable battery is not charged, the camcorder operation will not be affected as long as you are not recording the date.

■ Procedures

Connect your camcorder to a wall outlet (wall socket) using the supplied AC Adaptor, and leave it with the POWER switch set to OFF (CHG) for more than 24 hours.

Removing dust from inside the viewfinder

1 Remove the eye piece of the viewfinder.

Slide down the viewfinder release lever and hold it at the position (①), then lift the eye piece of the viewfinder as indicated with the arrow in the illustration (②).

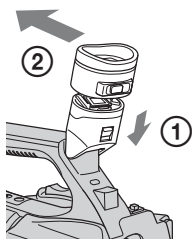

2 Remove dust inside the eye piece and viewfinder with a blower.

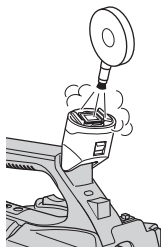

3 Attach the viewfinder following the reverse procedure of step 1.

Specifications

System

Video recording system (HDV)

2 rotary heads, Helical scanning system

Video recording system (DV)

2 rotary heads, Helical scanning system

Still image recording system

Exif Ver. 2.2*

Audio recording system (HDV)

Rotary heads, MPEG-1 Audio Layer -2,

Quantization: 16 bits

Fs48kHz (stereo)

transfer rate: 384 kbps

Audio recording system (DV)

Rotary heads, PCM system

Quantization: 12 bits

Fs32kHz (stereo1, stereo2)

Quantization: 16 bits

Fs48kHz (stereo)

Video signal

NTSC color, EIA standards

1080/60i specification

Usable cassette

Mini DV cassette with the  mark printed

Tape speed (HDV)

Approx. 18.812 mm/s

Tape speed (DV)

SP: Approx. 18.812 mm/s

LP: Approx. 12.555 mm/s

Recording/playback time (HDV)

60 min (using a DVM60 cassette)

Recording/playback time (DV)

SP: 60 min (using a DVM60 cassette)

LP: 90 min (using a DVM60 cassette)

Fast forward/rewind time

Approx. 2 min 40 s (using a DVM60 cassette and rechargeable battery pack)

Approx. 1 min 45 s (using a DVM60 cassette and AC Adaptor)

Viewfinder

Electric viewfinder (color)

Image device

6.0 mm (1/3 type) 3CMOS sensor

Recording Pixels (HDV/DV16:9 still recording):

Max. 1.20 Mega (1 440 × 810) pixels**

Gross: Approx. 1 120 000 pixels

Effective (movie, 16:9):

Approx. 1 037 000 pixels

Effective (movie, 4:3):

Approx. 778 000 pixels

Effective (still, 16:9):

Approx. 1 037 000 pixels

Effective (still, 4:3):

Approx. 778 000 pixels

Lens

G Lens

20 × (Optical), Approx. 30 × (Digital, when [D.EXTENDER] is set to [ON])

Focal length

f= 4.1 - 82.0 mm (3/16 - 3 1/4 in.)

When converted to a 35 mm still camera

29.5 - 590 mm (1 3/16 - 23 1/4 in.) (16:9),

36.1 - 722 mm (1 7/16 - 28 1/2 in.) (4:3)

F1.6 - 3.4

Filter diameter: 72 mm (2 7/8 in.)

Color temperature

Automatically

 (one push) A/B

[INDOOR] (3 200 K)

[OUTDOOR] (5 800 K)

Minimum illumination

1.5 lx (lux) (Fixed Shutter Speed 1/30, auto gain, auto iris) (F 1.6)

* "Exif" is a file format for still images, established by the JEITA (Japan Electronics and Information Technology Industries Association). Files in this format can have additional information such as your camcorder's setting information at the time of recording.

Specifications (Continued)

**The unique pixel array of Sony's ClearVid CMOS sensor and image processing system (Enhanced Imaging Processor) allows for still image resolution equivalent to the sizes described.

Output connectors

A/V Remote Connector

10-pin connector

When A/V connecting cable is connected

Video signal: 1 Vp-p, 75 Ω (ohms)

Luminance signal: 1 Vp-p, 75 Ω (ohms)

Chrominance signal: 0.286 Vp-p (burst signal), 75 Ω (ohms)

When component A/V cable is connected

Y: 1 Vp-p, 75 Ω (ohms), PB/PR, CB/CR: +/- 350 mV, 75 Ω (ohms)

Audio signal: 327 mV (at load impedance 47 k Ω (kilohms)), Output impedance with less than 2.2 k Ω (kilohms)

HDMI OUT jack

TypeA (19-pin)

🎧 (headphones) jack

Stereo-minijack (\varnothing 3.5 mm)

Input/Output connectors

LANC 📺 jack

Stereo mini-minijack (\varnothing 2.5 mm)

📡 HDV/DV jack

i.LINK interface (IEEE 1394, 4-pin connector S100)

MIC jack

Stereo-minijack (\varnothing 3.5 mm)

LCD screen

Picture

8.0 cm (3.2 type, aspect ratio 16:9)

Total dot number

921 600 (1 920 \times 480)

General

Power requirements

DC 7.2 V (battery pack)

DC 8.4 V (AC Adaptor)

Average power consumption

During camera recording using the viewfinder with normal brightness:

HDV recording 6.4 W

DV recording 6.1 W

During camera recording using the LCD with normal brightness:

HDV recording 6.6 W

DV recording 6.3 W

Operating temperature

0 $^{\circ}$ C to 40 $^{\circ}$ C (32 $^{\circ}$ F to 104 $^{\circ}$ F)

Storage temperature

-20 $^{\circ}$ C to +60 $^{\circ}$ C (-4 $^{\circ}$ F to +140 $^{\circ}$ F)

Dimensions (approx.)

169 \times 178 \times 349 mm

(6 3/4 \times 7 \times 13 7/8 in.) (w/h/d)

including the projecting parts except for the grip belt

169 \times 178 \times 349 mm

(6 3/4 \times 7 \times 13 7/8 in.) (w/h/d)

including the projecting parts with the battery pack (NP-F570)

Mass (approx.)

2.1 kg (4 lb 9 oz) including the lens hood with lens cover

2.3 kg (4 lb 15 oz) including the lens hood with lens cover, battery pack (NP-F570), cassette (DVM60) and large eyecup

AC Adaptor AC-L100

Power requirements

AC 100 V - 240 V, 50 Hz/60 Hz

Current consumption

0.35 A - 0.18 A

Power consumption

18 W

Output voltage

DC 8.4 V*

Operating temperature

0 °C to 40 °C (32 °F to 104 °F)

Storage temperature

-20 °C to +60 °C (-4 °F to +140 °F)

Dimensions (approx.)

48 × 29 × 81 mm
(1 15/16 × 1 3/16 × 3 1/4 in.) (w/h/d)
excluding the projecting parts

Mass (approx.)

170 g (6.0 oz) excluding the power cord
(mains lead)

* See the label on the AC Adaptor for other specifications.

Rechargeable battery pack NP-F570

Maximum output voltage

DC 8.4 V

Output voltage

DC 7.2 V

Capacity

15.8 Wh (2 200 mAh)

Dimensions (approx.)

38.4 × 20.6 × 70.8 mm
(1 9/16 × 13/16 × 2 7/8 in.) (w/h/d)

Mass (approx.)

100 g (3.5 oz)

Operating temperature

0 °C to 40 °C (32 °F to 104 °F)

Type

Lithium ion

Design and specifications are subject to change without notice.

CAUTION





If the battery pack is mishandled, the battery pack can burst, cause a fire or even chemical burns. Observe the following cautions.

- Do not disassemble.
- Do not crush and do not expose the battery pack to any shock or force such as hammering, dropping or stepping on it.
- Do not short circuit and do not allow metal objects to come into contact with the battery terminals.
- Do not expose to high temperature above 60 °C (140 °F) such as in direct sunlight or in a car parked in the sun.
- Do not incinerate or dispose of in fire.
- Do not handle damaged or leaking lithium ion batteries.
- Be sure to charge the battery pack using a genuine Sony battery charger or a device that can charge the battery pack.
- Keep the battery pack out of the reach of small children.
- Keep the battery pack dry.
- Replace only with the same or equivalent type recommended by Sony.
- Dispose of used battery packs promptly as described in the instructions.

Specifications

Maximum charge voltage: DC 8.4 V
/Maximum charge current: 3.0 A

On trademarks

- “Handycam” and  are registered trademarks of Sony Corporation.
- “Memory Stick,”  “Memory Stick Duo,” “**MEMORY STICK DUO**,” “Memory Stick PRO Duo,” “**MEMORY STICK PRO DUO**,” “Memory Stick PRO-HG Duo,” “**MEMORY STICK PRO-HG DUO**,” “Memory Stick Micro,” “MagicGate,” “**MAGIC GATE**,” “MagicGate Memory Stick” and “MagicGate Memory Stick Duo” are trademarks of Sony Corporation.
- “InfoLITHIUM” is a trademark of Sony Corporation.
-  is a trademark of Sony Corporation.
- “x.v.Color” is a trademark of Sony Corporation.
- i.LINK and  are trademarks of Sony Corporation.
- Mini  Digital Video Cassette is a trademark.
- Microsoft, Windows, Windows Vista, and Windows Media are trademarks or registered trademarks of U.S. Microsoft Corporation in the U.S. and other countries.
- Macintosh and Mac OS are registered trademarks of Apple Inc. in the U.S. and other countries.
- HDV and the HDV logo are trademarks of Sony Corporation and Victor Company of Japan, Ltd.
- HDMI, HDMI logo, and High-Definition Multimedia Interface are trademarks or registered trademarks of HDMI Licensing LLC.
- Pentium is a trademark or registered trademark of Intel Corporation.
- Adobe, and Adobe Reader. are trademarks of Adobe Systems Incorporated.

All other product names mentioned herein may be the trademarks or registered trademarks of their respective companies. Furthermore, TM and “®” are not mentioned in each case in this manual.

Notes on the License

ANY USE OF THIS PRODUCT OTHER THAN CONSUMER PERSONAL USE IN ANY MANNER THAT COMPLIES WITH THE MPEG-2 STANDARD FOR ENCODING VIDEO INFORMATION FOR PACKAGED MEDIA IS EXPRESSLY PROHIBITED WITHOUT A LICENSE UNDER APPLICABLE PATENTS IN THE MPEG-2 PATENT PORTFOLIO, WHICH LICENSE IS AVAILABLE FROM MPEG LA, L.L.C., 250 STEELE STREET, SUITE 300, DENVER, COLORADO 80206.

Identifying parts and controls

The numbers in () are reference pages.

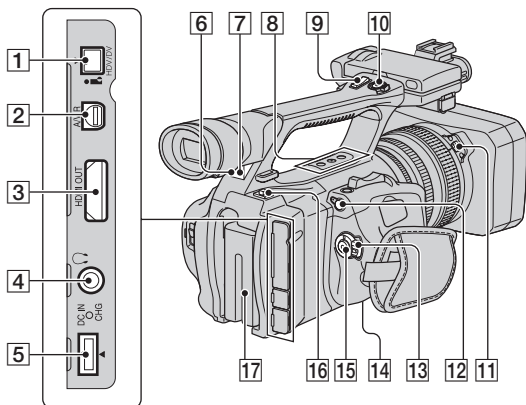

- 1** HDV/DV jack (56)
 - 2** A/V Remote Connector (56)
 - 3** HDMI OUT jack (56)
 - 4** (headphones) jack
When you use headphones, the speaker on your camcorder is silent.
 - 5** DC IN jack (18)
 - 6** Remote sensor (back) (127)
 - 7** Recording lamp (back) (28)
The recording lamp flashes if the remaining tape or battery is low.
 - 8** ASSIGN (4/5/6) buttons*(44)
 - 9** Handle zoom lever (31)
 - 10** REC START/STOP button (28)
 - 11** PUSH (lens hood release) button (17)
 - 12** LANC jack
The LANC control jack is used for controlling the tape transport of video device and peripherals connected to it.
 - 13** POWER switch (21)
 - 14** Tripod receptacle
Make sure that the length of the tripod screw is less than 5.5 mm (7/32 inch). Otherwise, you cannot attach the tripod securely, and it may damage your camcorder.
 - 15** REC START/STOP button (28)
 - 16** BATT RELEASE (battery release) button (19)
 - 17** Battery pack (18)
- * ASSIGN 5 button has a raised tactile dot for your convenience in locating the button.

Identifying parts and controls (Continued)

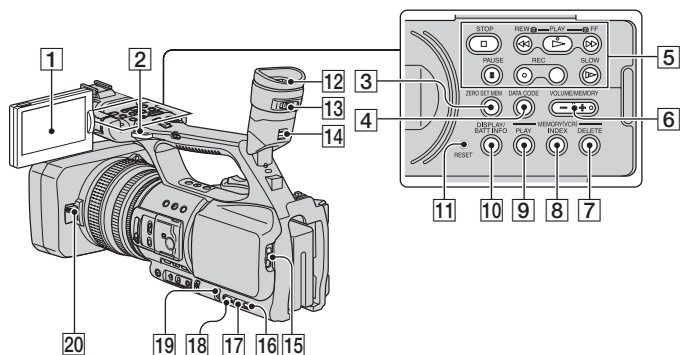

- 1** LCD screen (22)
- 2** Hook for the shoulder strap (125)
- 3** ZERO SET MEM button (54)
- 4** DATA CODE button (52)
- 5** Video control buttons (STOP/REW/
PLAY*/FF/PAUSE/REC/SLOW) (49)
- 6** VOLUME/MEMORY button* (50)
- 7** MEMORY/DELETE button (50)
- 8** MEMORY/INDEX button* (50)
- 9** MEMORY/PLAY button (50)
- 10** DISPLAY/BATT INFO button (52, 53)
- 11** RESET button
If you press the RESET button, all settings including the clock setting (except the Picture profile and Camera profile settings) return to the default.
- 12** Viewfinder (22)
- 13** Viewfinder lens adjustment lever (22)
- 14** Viewfinder release lever (118)
- 15** OPEN/EJECT lever (26)
- 16** STATUS CHECK button (53)
- 17** PICTURE PROFILE button (37)
- 18** MENU button (62)
- 19** SEL/PUSH EXEC dial (24)

- 20** Lens cover lever (17)

* Each of the PLAY button, VOLUME/MEMORY button and MEMORY/INDEX button has a raised tactile dot. (The VOLUME/MEMORY button has it on the + side.) Use it to identify the location of the buttons.

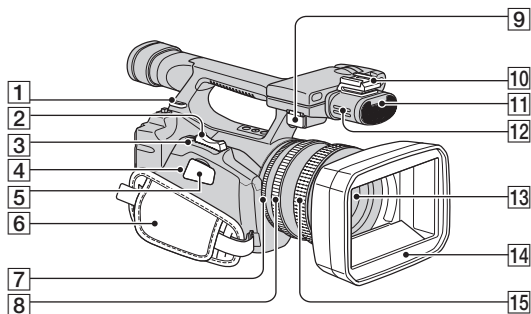

- 1 Hook for the shoulder strap (125)
- 2 Zoom lever (31)
- 3 PHOTO/EXPANDED FOCUS button (30, 33)
- 4 Access lamp (27)
- 5 "Memory Stick Duo" slot (26)
- 6 Grip belt (21)
- 7 Iris ring (33)
- 8 Zoom ring (31)
- 9 MIC jack

When a microphone is connected, it is dominantly used for sound recording over the internal microphone.

- 10 Accessory shoe
- 11 Recording lamp (front) (28)
The recording lamp flashes if the remaining tape or battery is low.
- 12 Microphone (42)
- 13 Lens
- 14 Lens hood with lens cover (17)
- 15 Focus ring (32)

To attach the shoulder strap

Attach the shoulder strap (optional) to the hooks for the shoulder strap.

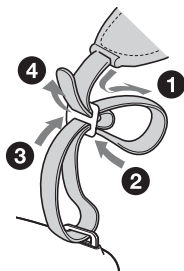

Identifying parts and controls (Continued)

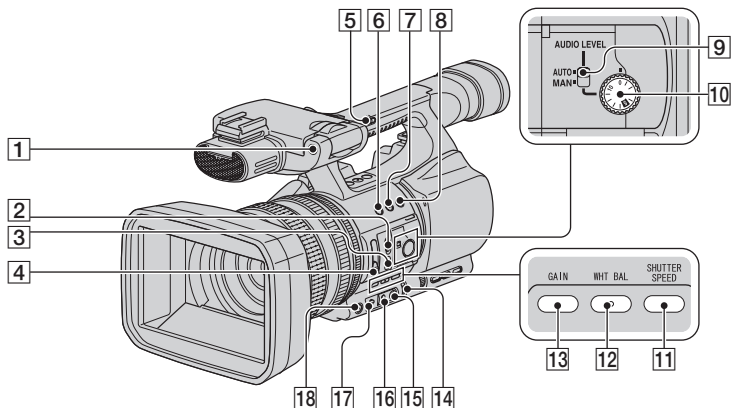

- 1** Remote sensor (front) (127)
- 2** FOCUS switch (32)
- 3** PUSH AUTO button (32)
- 4** ND FILTER switch (OFF/1/2/3) (36)
- 5** Handle zoom switch (FIX/VAR/OFF) (31)
- 6** ASSIGN 1 button/ZEBRA button (44)
- 7** ASSIGN 2 button*/AE SHIFT button (44)
- 8** ASSIGN 3 button/REC REVIEW button (44)
- 9** AUDIO LEVEL switch (42)
- 10** AUDIO LEVEL dial (42)
- 11** SHUTTER SPEED button (35)
- 12** WHT BAL (white balance) button* (36)
- 13** GAIN button (35)
- 14** AUTO/MANUAL switch (33)
- 15**  (one push) button (36)
- 16** White balance memory switch (36)
- 17** Gain switch (35)
- 18** IRIS/EXPOSURE button* (33)

* ASSIGN 2 button/AE SHIFT button, WHT BAL button, IRIS/EXPOSURE button have raised tactile dots for your convenience in locating the buttons.

Remote Commander

Remove the insulation sheet before using the Remote Commander.

Insulation sheet

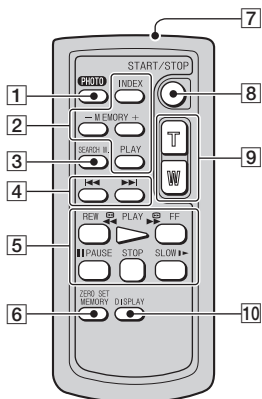
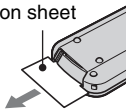

1 PHOTO (30)

The on-screen image when you press this button will be recorded onto the "Memory Stick Duo" as a still image.

2 Memory control buttons (Index, -/+, Memory/playback) (50)

3 SEARCH M. (55)

4 <<>>

5 Video control buttons (Rewind, Playback, Fast-forward, Pause, Stop, Slow) (49)

6 ZERO SET MEMORY (54)

7 Transmitter

8 START/STOP (28, 54)

9 Power zoom (31)

10 DISPLAY (52)

Notes

- Aim the Remote Commander towards the remote sensor to operate your camcorder.
- Point the remote sensor away from strong light sources such as direct sunlight or overhead lighting. Otherwise, the Remote Commander may not function properly.
- When you are operating with the Remote Commander supplied with your camcorder, your VCR may also operate. In that case, select a commander mode other than VTR 2 for your VCR, or cover the sensor of your VCR with black paper.

To change the battery of the Remote Commander

- 1 While pressing on the tab, inset your fingernail into the slit to pull out the battery case.
- 2 Place a new battery with the + side facing up.
- 3 Insert the battery case back into the Remote Commander until it clicks.

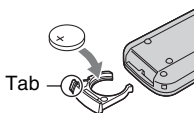

WARNING

Battery may explode if mistreated. Do not recharge, disassemble or dispose of in fire.

- When the lithium battery becomes weak, the operating distance of the Remote Commander may shorten, or the Remote Commander may not function properly. In this case, replace the battery with a Sony CR2025 lithium battery. Use of another battery may present a risk of fire or explosion.

Indicators for the LCD screen and viewfinder

The numbers in () are reference pages.

The indicators will not be recorded on the tape during recording.

Recording movies

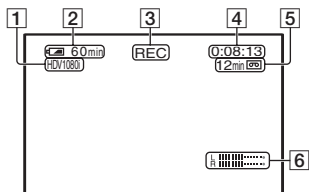

- 1** Recording format (HDV1080i or DV) (77)
Recording mode (SP or LP) is also displayed in the DV format.
- 2** Remaining battery (approx.)
- 3** Recording status ([STBY] (standby) or [REC] (recording))
- 4** During recording:
Tape counter (hour: minute: second)
During playback:
Time code (hour: minute: second: frame)
- 5** Recording capacity of the tape (approx.)
- 6** Audio level display (76)

Recording still images

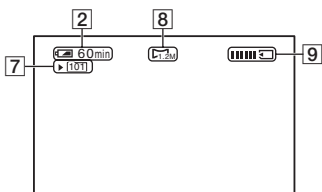

- 7** Recording folder (81)
- 8** Image size (30)
- 9** Recording indicator (30)

Data code during recording

The date/time during recording and the camera setting data will be recorded automatically. They do not appear on the screen during recording, but you can check them on the screen by pressing the DATA CODE button during playback (p. 52).

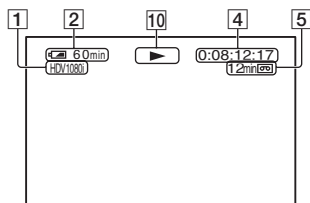

Viewing movies

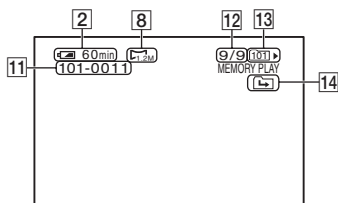

- 10** Tape transport indicator
Recording mode (SP or LP) appears when a tape recorded in the DV format is played back. **DV**

Viewing still images



- 11** Data file name
- 12** Picture number/Total number of recorded pictures in the current playback folder
- 13** Playback folder (81)
- 14** Previous/Next folder icon
The , ,  appear when the first or last picture of the current folder is displayed and when there are multiple folders on the same "Memory Stick Duo." You can move to Previous/Next folder with the VOLUME/MEMORY button.

Indicators for the LCD screen and viewfinder (Continued)

Indicators when you made changes

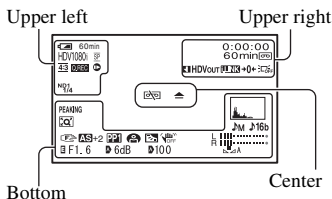

Upper left

Indicator	Meaning
HDV1080i DV	Recording format (77)
SP LP	DV REC MODE (78)*
4:3	DV WIDE REC (78)*
Q.REC	QUICK REC (82)**
1/16	DV FRAME REC (71)*
ND OFF CLR ND1 1/4 ND2 1/16 ND3 1/64	ND filter (36)
Interval REC	INTERVAL REC (70)

Upper right

Indicator	Meaning
INDEX MARK	INDEX MARK (45)
HDV IN DV IN	HDV input/ DV input (89)
HDV OUT DV OUT	HDV output/ DV output (87)
i.LINK	i.LINK connection (56, 84)
+0+	Zero set memory (54)
OFF	LCD backlight off (22)

Center

Indicator	Meaning
Warning	Warning (104)

Bottom

Indicator	Meaning
HISTOGRAM	HISTOGRAM (74)
J16b J12b	DV AU.MODE (73)*
M	Manual volume control (42)
Manual focus	Manual focus (32)
PP1 ~ PP6	Picture profile (37)
SPOTLIGHT	SPOTLIGHT (68)
BACK LIGHT	BACK LIGHT (68)
SteadyShot off	SteadyShot off (68)
PEAKING	PEAKING (74)
D.EXTENDER	D.EXTENDER (69)
AE SHIFT	AE SHIFT (67)
EXPOSURE control	EXPOSURE control (33, 66)
Automatic control	Automatic control (75)
White balance	White balance (36)
(COLOR)	x.v.Color (72)**
ZEBRA	ZEBRA (74)
24pSCAN	PROG.SCAN (66)
30pSCAN	

* The settings can be made only for the pictures in the DV format.

** The setting can be made only for the pictures in the HDV format.

⚡ Tips

- Indicators may look different or appear at different positions.

Index

Numeric

1080i/480i	79
12BIT	73
16BIT	73
3-ClearVid CMOS sensor system	13
480i	79
6sec AFTER	69
6sec BEFORE	69
6sec CENTER	69

A

AC Adaptor	18
Access lamp	27
ADVANCE	74
AE RESPONSE	68
AE SHIFT	67
AF ASSIST	69
AGC LIMIT	67
ALL ERASE	80
ALL FILES	80
ALL OUTPUT	77
ASSIGN BTN	82
ASSIGN buttons	44
AT IRIS LMT	68
AUDIO LEVEL dial	42
AUDIO LEVEL switch	42
AUDIO LIMIT	73
AUDIO SET menu	73
AUTO/MANUAL switch	33
AU.LVL DISP (Audio level display)	76
AWB SENS	67
A/V connecting cable	61, 85
A/V connecting cable with S VIDEO	84
A/V Remote Connector	123

B

BACK LIGHT	68, 97
------------------	--------

BATT RELEASE (battery release) button	19
Battery	
Battery Info	53
Battery pack	18
BEEP	83
BLACK FADER	69
Button-type lithium battery	127

C

CAM DATA DSP (Camera data display)	75, 97
CAMERA PROF. (Camera profile)	81
CAMERA SET menu	66
Cassette	
Insert/Eject	26
Tape	110
Cassette compartment	26
Charging time	19
CHG (charge) lamp	18
CLOCK SET	24, 82
CNTRST ENHCR	68, 97
COLOR BAR	72
COLOR DEPTH	40
COLOR LEVEL	39
COLOR MODE	39
COLOR PHASE	40
COMPONENT	79
Component A/V cable	57, 60
Computer	93
Connect	
TV	56
VCR	84
CURRNT FOLDER	80

D

DATA CODE button	52
Date search	55
DATE/TIME	25, 128
DC IN jack	18

DC plug	18
Deleting camera profile settings	82
Deleting still images	50
DISP OUTPUT	77
DISPLAY SET menu	74
DISPLAY/BATT INFO button	22, 52, 53
Down convert function	12
Dubbing	84
DV	77
DV AUDIO MIX	73
DV AU. MODE (DV Audio mode)	73
DV format	77, 78
DV FRAME REC	71, 98
DV REC MODE (Recording mode)	78
DV WIDE REC	78
D.EXTENDER (Digital Extender)	69, 97

E

END SEARCH	45
End search	45, 97, 100
EXECUTE	69
Expanded focus	33
EXPOSURE	33
EXP. FOCUS	44, 82
EXP.FOCUS TYPE	75

F

FADER	69, 97
FILE NO. (File number)	80
FLCKR REDUCE	68
Focus	32
Focus infinity	33
Focus ring	32
FOCUS switch	32
Folder	
NEW FOLDER	80
PB FOLDER (Playback	

Index (Continued)

- folder).....81
 - REC FOLDER (Recording folder).....81
 - FORMAT80, 111
- ### G
- G Lens 13
 - Gain35
 - GAIN button.....35
 - GAIN SETUP.....66
 - GAMMA39
 - Grip belt.....21
 - GUIDEFRAAME.....75
- ### H
- HANDLE ZOOM.....69
 - Handle zoom.....31
 - HDMI cable.....58
 - HDMI OUT jack56
 - HDV77
 - HDV format.....12, 109
 - HDV 1080i77
 - HDV/DV jack.....84
 - Headphones jack.....123
 - High definition TV57
 - HISTOGRAM74, 97
 - Hook for the shoulder strap124, 125
- ### I
- INDEX MARK.....45
 - Index screen.....50
 - Index search.....55
 - Index signal45
 - Indicators130
 - INDOOR36, 37
 - Indoor37
 - “InfoLITHIUM” battery pack112
 - Insulation sheet.....127
 - INTELLIGENT67
- ### INTERVAL
- INTERVAL 70
 - INTERVAL REC..... 70, 98
 - IN/OUT REC menu 77
- Iris ring..... 33
 - IRIS/EXPOSURE 33, 66
 - IRIS/EXPOSURE button..... 33
 - i.LINK 113
 - i.LINK cable 58, 88, 91
 - i.LINK CONV 56, 79
- ### L
- LANC jack 123
 - LANGUAGE 82
 - Large eyecup..... 23
 - LCD 22
 - LCD backlight..... 22
 - LCD BL LEVEL..... 76, 98
 - LCD BRIGHT..... 76
 - LCD COLOR..... 76
 - LCD PANEL..... 77
 - Lens cover lever..... 17
 - Lens hood with lens cover ... 17
 - LETTER SIZE 76
 - LINEAR..... 71
 - LP (Long Play)..... 78
- ### M
- Macintosh..... 93
 - Maintenance..... 115
 - MARKER 75
 - Memory A..... 37
 - Memory B 37
 - MEMORY SET menu 80
 - “Memory Stick” 111
 - “Memory Stick Duo”
 - Insert/Eject..... 26
 - Number of recordable pictures 30
 - “Memory Stick Duo” slot 27
 - MEMORY/DELETE button 50
- ### MEMORY/INDEX button ... 49
- ### MEMORY/PLAY button 49
- ### Menu
- AUDIO SET menu..... 73
 - CAMERA SET menu ...66
 - DISPLAY SET menu74
 - IN/OUT REC menu 77
 - MEMORY SET menu80
 - Menu items.....64
 - OTHERS menu81
 - Using the menu62
- ### MENU button 24
- ### Menu items64
- ### MIC jack..... 125
- ### Microphone 125
- ### MINUS AGC.....67
- ### MIX 73
- ### Moisture condensation 115
- ### MPEG2.....92
- ### MULTI-SOUND73
- ### N
- ND filter36
 - NEW FOLDER80
 - NORMAL.....74
 - NTSC..... 100, 109
- ### O
- OPEN/EJECT lever26
 - OTHERS menu81
 - OUTDOOR36
 - Outdoor.....37
 - Outside power source20
- ### P
- PAL 109
 - PB FOLDER (Playback folder) 81
 - PB ZOOM (Playback zoom).....82

PEAKING	74, 97
PHOTO	82
PHOTO/EXPANDED FOCUS button	28
PHOTO/EXP.FOCUS	82
Picture profile	37
PICTURE PROFILE button	37
Picture Search	50
PLAY button.....	49
Playback.....	49
Playing time	20
Power cord.....	18
POWER switch.....	21
Pre-installed rechargeable battery	117
PROG. SCAN	66, 97
PUSH AUTO button.....	32
PUSH (lens hood release) button	17

Q

QUICK REC	82
-----------------	----

R

REC FOLDER (Recording folder)	81
REC FORMAT	77
REC LAMP (Recording lamp)	28, 83
REC REVIEW	44, 45
Rec review	45, 100
REC START/STOP button	28
Recording.....	28
Recording time	19
REMAINING	76
Remaining battery.....	53
Remote Commander	127
REMOTE CTRL (Remote control).....	83
RESET button	124

S

S VIDEO cable.....	61
S VIDEO jack	59, 85
Self-diagnosis display	104
SEL/PUSH EXEC dial.....	24
SHOT TRANSITION	46, 71
Shot transition	46
Shoulder strap	125
Shutter speed	35
SHUTTER SPEED button ...	35
SKINTONE DTL (Skintone detail)	41
Skip Scan.....	50
SMTH SLW REC (Smooth slow recording)	69, 97
SOFT STOP	71
SOFT TRANS	71
SP (Standard Play)	78
Specifications	119
SPOTLIGHT	68, 97
ST1	73
ST2	73
Status check.....	53
STATUS CHECK button.....	53
STEADYSHOT	44, 68
STEREO.....	73
Still images.....	30
Supplied items	16

T

Tape counter.....	54, 128
Tape.....	See Cassette
Telephoto	31
Time code.....	128
TIMING	69
TRANS CURVE	71
TRANS TIME	71
Transmitter	127
TRIG	70
TRIG LEVEL.....	70
Tripod receptacle.....	123

Troubleshooting.....	94
TV	56
TV color systems	109
TV TYPE.....	79

U

Using the menu items	62
Using your camcorder abroad	107

V

VCR HDV/DV	77
VF B.LIGHT	76, 98
VF POWERMODE	76
Video control buttons	124
Video head.....	116
Viewfinder.....	22
Viewfinder lens adjustment lever	22
Viewfinder release lever.....	118
Volume	50
VOLUME/MEMORY button	49
V-OUT/PANEL.....	77

W

Warning indicators	104
Warning messages	105
WB PRESET	67
WB SHIFT.....	40
White balance	36
WHITE FADER	69
WHT BAL button.....	36
Wide angle.....	31
WIND	73
Windows.....	93
WORLD TIME.....	82, 98
Write-protect tab.....	110

X

x.v.Color	72, 98
-----------------	--------

Index (Continued)

Z

ZEBRA	74, 97
ZERO SET MEM button.....	54
Zero set memory.....	54
ZERO SET MEMORY button.....	54
Zoom	31
Zoom lever	31
Zoom ring	31

Paso 1: Comprobación de los elementos suministrados

Asegúrese de que su videocámara contiene los siguientes elementos.

El número entre paréntesis indica la cantidad del elemento.

Adaptador de alimentación de ca (1)

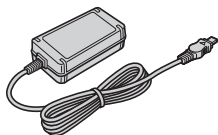

Cable de alimentación (1)

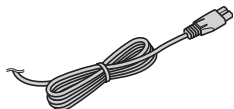

Control remoto inalámbrico (1)



Tiene instalada una pila de litio tipo botón.

Cable A/V componente (1)

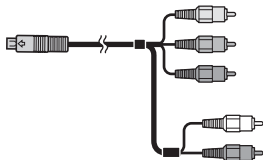

Cable de conexión A/V (1)



Ocular grande (1)



Batería recargable NP-F570 (1)

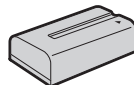

Parasol del objetivo con tapa del objetivo (1)

Este parasol del objetivo está premontado.

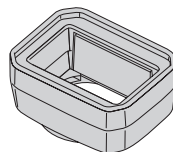

Guía de operaciones (Este manual) (1)

Paso 2: Colocación del parasol del objetivo con la tapa del objetivo

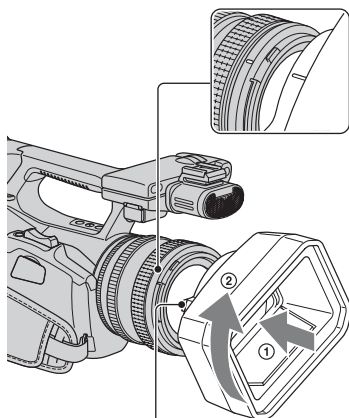

Botón PUSH (liberación del parasol del objetivo)

Para abrir o cerrar el obturador del Parasol del objetivo con tapa del objetivo

Mueva la palanca de la tapa del objetivo hacia arriba o abajo para abrir o cerrar la tapa del objetivo.

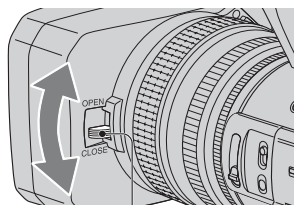

Mueva la palanca de la tapa del objetivo a la posición OPEN para abrir la tapa del objetivo y muévala a la posición CLOSE para cerrarla.

Alinee las marcas en el parasol con las marcas en la videocámara y gire el parasol del objetivo en la dirección que indica la flecha ②.

Para extraer el Parasol del objetivo con tapa del objetivo

Gire el parasol del objetivo en la dirección opuesta a la de la flecha ② de la ilustración mientras presiona el botón PUSH (liberación del parasol del objetivo).

🔧 Consejos

- Si coloca o retira o un filtro PL de 72 mm o el protector MC, retire el parasol del objetivo con la tapa.

Paso 3: Carga de la batería

Puede cargar la batería "InfoLITHIUM" (serie L) con el adaptador de alimentación de ca suministrado.

Notas

- No se puede utilizar baterías que no sean "InfoLITHIUM" (serie L).

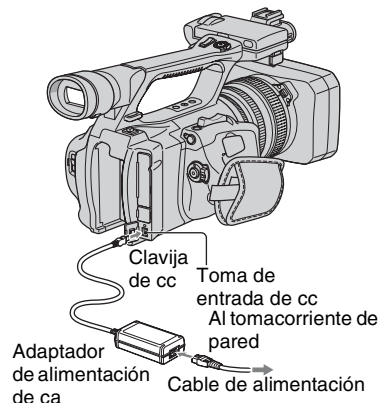

1 Ejercer presión sobre la batería contra la parte posterior de la videocámara y deslicela hacia abajo.

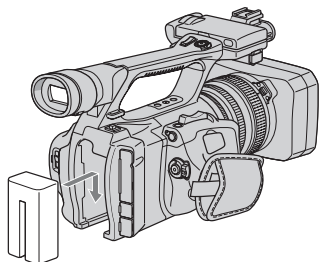

2 Con la marca ► de la clavija de cc hacia fuera, conecte la clavija de cc a la toma de entrada de cc de la videocámara.

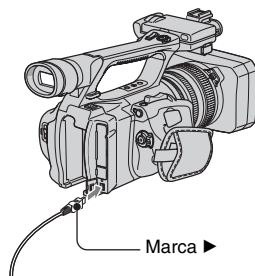

3 Conecte el cable de alimentación al adaptador de alimentación de ca.

4 Conecte el cable de alimentación al tomacorriente de la pared.

5 Ajuste el interruptor POWER en OFF (CHG).

El indicador CHG se enciende y se inicia el proceso de carga.

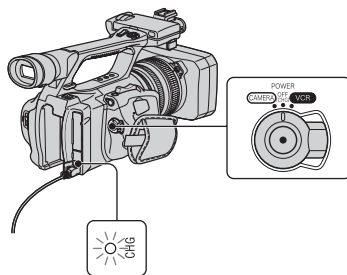

Paso 3: Carga de la batería (Continuación)

Después de cargar la batería

El indicador CHG se apaga cuando la batería está completamente cargada. Desconecte el adaptador de alimentación de ca de la toma de entrada de cc.

Consejos

- Puede comprobar la carga restante de la batería con la función de información de la batería.

Para retirar la batería

Ajuste el interruptor POWER en OFF (CHG). Presione el botón BATT RELEASE (liberación de la batería) y retire la batería.

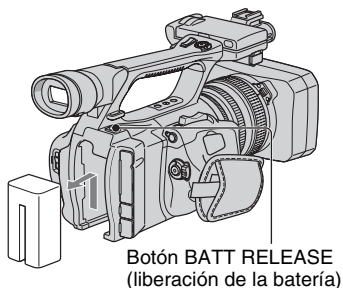

Para guardar la batería

Si la batería no va a ser usada por un tiempo, úsela hasta agotarla y guárdela.

Tiempo de carga

Tiempo aproximado (m) necesario para cargar totalmente una batería descargada por completo.

Batería	Tiempo de carga
NP-F570 (suministrada)	260
NP-F770	370
NP-F970	485

Tiempo de grabación

Tiempo aproximado (m) disponible cuando utiliza una batería completamente cargada.

Notas

- No se pueden usar baterías NP-F330 con esta videocámara.

Grabación en formato HDV

Batería	Tiempo de grabación continua	Tiempo de grabación normal*
NP-F570 (suministrada)	135 140	65 70
NP-F770	290 295	145 145
NP-F970	430 445	215 220

Grabación en formato DV

Batería	Tiempo de grabación continua	Tiempo de grabación normal*
NP-F570 (suministrada)	145 150	70 75
NP-F770	300 310	150 155
NP-F970	450 465	225 230

Parte superior: con la luz de fondo de la pantalla LCD encendida.

Parte inferior: tiempo de grabación cuando se graba con el visor mientras el panel LCD permanece cerrado.

* El tiempo de grabación normal muestra la hora cuando se repite la operación de inicio/detención de la grabación, al conectar y desconectar la alimentación y al usar la función de zoom.

Tiempo de reproducción

Tiempo aproximado (m) disponible cuando utiliza una batería completamente cargada.

HDV Imágenes de formato

Batería	Panel LCD abierto*	Panel LCD cerrado
NP-F570 (suministrada)	200	210
NP-F770	415	435
NP-F970	630	660

DV Imágenes de formato

Batería	Panel LCD abierto*	Panel LCD cerrado
NP-F570 (suministrada)	220	230
NP-F770	445	470
NP-F970	675	705

* Con la luz de fondo de la pantalla LCD encendida.

Acerca de la batería

- Antes de cambiar la batería, coloque el interruptor POWER en la posición OFF (CHG).
- El indicador CHG parpadeará durante la carga o la información de la batería no se mostrará correctamente en las siguientes condiciones.
 - La batería no está correctamente conectada.
 - La batería está dañada.
 - La batería está gastada (sólo para la información de la batería).
 - La batería está demasiado fría.
Reemplace la batería o retírela y colóquela en un lugar cálido.
 - La batería está demasiado caliente.
Reemplace la batería o retírela y colóquela en un lugar fresco.
- Cuando el adaptador de alimentación de ca esté conectado a la toma de entrada de cc de la videocámara, la batería no suministrará alimentación, incluso si el cable de alimentación está desconectado al tomacorriente de pared.

Acerca del tiempo de carga/grabación/reproducción

- Tiempo medido con la videocámara a 25 °C
Se recomienda de 10 °C a 30 °C
- El tiempo de grabación y de reproducción será más corto cuando use la videocámara a bajas temperaturas.
- El tiempo de grabación y de reproducción será más corto en función de las condiciones de uso de la videocámara.

Uso de una fuente de alimentación externa

Puede usar un adaptador de alimentación de ca para obtener energía de ca. Mientras utiliza el adaptador de alimentación de ca la batería no perderá su carga aunque esté conectada a la cámara.

Conecte la videocámara como se indica en el Paso 3: Carga de la batería.

Acerca del adaptador de alimentación de ca

- Si utiliza el adaptador de alimentación de ca conéctelo a un tomacorriente de pared cercano. Si se produce alguna falla de funcionamiento al utilizar la videocámara, desconecte al adaptador de alimentación de ca del tomacorriente de inmediato.
- No utilice el adaptador de alimentación de ca colocado en un espacio angosto, tal como entre una pared y los muebles.
- Evite los cortocircuitos en la clavija de cc del adaptador de alimentación de ca o en el terminal de la batería con objetos metálicos. Podría provocar una falla de funcionamiento.
- Aunque la videocámara esté apagada, seguirá recibiendo adaptador de alimentación de ca (corriente doméstica) mientras esté conectada a la toma de pared mediante el adaptador de alimentación de ca

Paso 4: Encendido y sujeción adecuados de la videocámara

Para grabar o reproducir, coloque el interruptor POWER en la dirección respectiva.

La primera vez que utilice la videocámara, aparecerá la pantalla [AJUS.RELOJ].

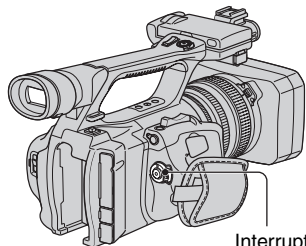

Interruptor
POWER

1 Mientras presiona el botón verde, deslice el interruptor POWER.

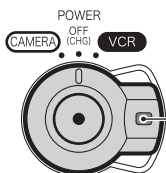

Mantenga presionado el botón verde mientras desliza el interruptor POWER de la posición OFF (CHG).

CAMERA: para grabar imágenes.
VCR: para reproducir o editar imágenes.

🔊 Notas

- La fecha y hora actuales aparecen en la pantalla LCD por unos segundos al encender la videocámara después de haberse ajustado la fecha y la hora ([AJUS.RELOJ]).

2 Sostenga la videocámara correctamente.

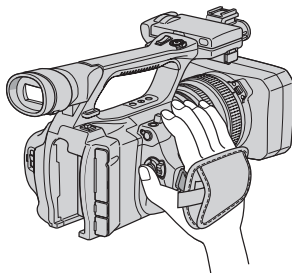

3 Asegúrese de que la sostiene correctamente y luego ajuste la correa de sujeción.

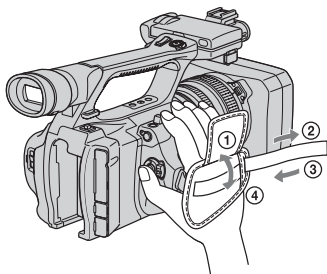

Para apagar la videocámara

Deslice el interruptor POWER a la posición OFF (CHG).

🔊 Notas

- Si en la pantalla aparecen mensajes de advertencia, siga las instrucciones.

Paso 5: Ajuste del panel LCD y el visor

El panel LCD

Abra el panel LCD 180 grados (①), luego gírelo hasta encontrar el mejor ángulo para grabar o reproducir (②).

① Abra 180 grados.

② 90 grados (máx.)

② 180 grados (máx.)

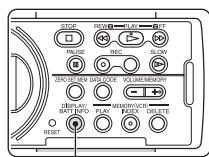



Botón DISPLAY/BATT INFO

💡 Consejos

- Puede ver su imagen reflejada en la pantalla LCD colocando el panel frente a usted. La imagen se grabará como una imagen normal.

Para desactivar la luz de fondo de la pantalla LCD y prolongar la duración de la batería

Mantenga presionado el botón DISPLAY/BATT INFO durante unos segundos hasta que aparezca .

Este ajuste es práctico cuando utiliza la videocámara en lugares muy luminosos o cuando desea ahorrar energía. Este ajuste no afectará a la imagen grabada. Para encender la luz de fondo de la pantalla LCD, presione el botón DISPLAY/BATT INFO.  desaparece.

💡 Consejos

- Puede ajustar el brillo de la pantalla LCD en [BRILLO LCD].

Visor

Puede ver imágenes utilizando el visor para ahorrar energía de la batería o cuando la imagen en la pantalla LCD no sea clara.

Palanca de ajuste del objetivo del visor

Muévala hasta que la imagen aparezca nítida.

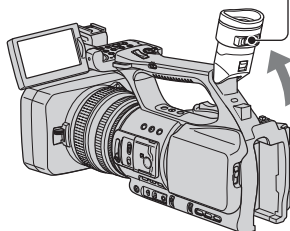
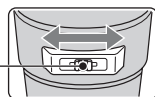

⚠️ Notas

- Es posible que los colores primarios produzcan algún resplandor cuando en el visor usted cambie su línea visual. No se trata de una falla de funcionamiento. Los colores resplandecientes no se grabarán en el medio de grabación.

💡 Consejos

- Puede ajustar el brillo de la luz de fondo del visor con [LUZ F.VISOR].
- Para ver imágenes tanto en la pantalla LCD como en el visor, ajuste [M.ALIM.VISOR] en [ACTIVADO].

Paso 5: Ajuste del panel LCD y el visor (Continuación)

Cuando tenga dificultades para ver la imagen del visor

Si no puede ver claramente la imagen en el visor en condiciones de brillo, use el ocular grande suministrado. Para colocar el ocular grande, ensáchelo un poco y alinéelo con la ranura del ocular en el visor. Puede colocar el ocular grande hacia el lado derecho o izquierdo.

Notas

- No retire el ocular preinstalado.

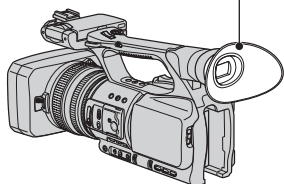
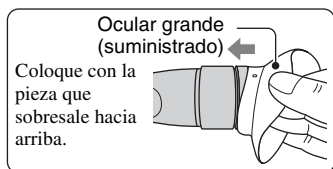

Paso 6: Ajuste de la fecha y la hora

Ajuste la fecha y la hora cuando use la videocámara por primera vez. De lo contrario, la pantalla [AJUS.RELOJ] aparecerá cada vez que encienda la videocámara o cambie las posiciones del interruptor POWER.

Consejos

- Si no usa la videocámara durante **aproximadamente 3 meses**, la batería recargable incorporada se descarga y es posible que los ajustes de la fecha y la hora se borren de la memoria. En este caso, cargue la batería recargable y ajuste la fecha y la hora nuevamente.

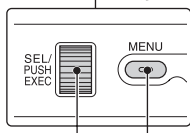
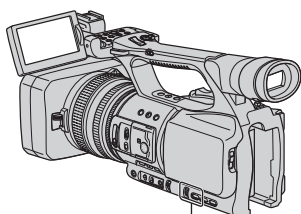

Selector SEL/PUSH EXEC Botón MENU

Vaya directamente al paso 4 cuando ajuste el reloj por primera vez.

1 Presione el botón MENU.

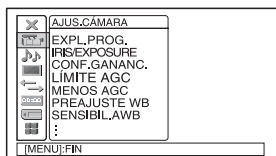

2 Seleccione [OTROS] girando el selector SEL/PUSH EXEC, luego presione el selector.

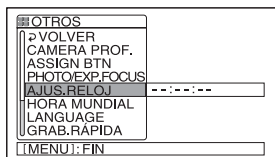

3 Seleccione [AJUS.RELOJ] girando el selector SEL/PUSH EXEC, luego presione el selector.

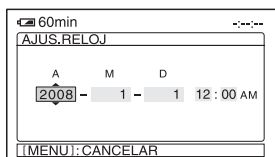

4 Ajuste [A] (año) girando el selector SEL/PUSH EXEC, luego presione el selector.

Puede seleccionar cualquier año hasta el año 2079.

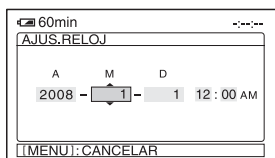

5 Ajuste [M] (mes), [D] (día), hora y minuto, luego presione el selector.

El reloj se pone en marcha.

Para la medianoche, ajústelo en 12:00 AM.

Para el mediodía, ajústelo en 12:00 PM.

Paso 6: Ajuste de la fecha y la hora (Continuación)

Consejos

- La fecha y la hora se graban automáticamente en la cinta y se pueden ver durante la reproducción (botón DATA CODE).

Cambio del ajuste de idioma

Puede cambiar las indicaciones en pantalla para que muestren mensajes en un idioma en particular.

Presione el botón MENU para seleccionar  (OTROS) con el selector SEL/PUSH EXEC.

Seleccione el idioma de los mensajes en pantalla en [LANGUAGE].

Paso 7: Inserción de una cinta o un “Memory Stick Duo”

Casete/cinta

Solamente puede utilizar casetes mini DV
Mini DV.

- 1 Deslice y sostenga la palanca OPEN/EJECT en el sentido de la flecha y abra la tapa.

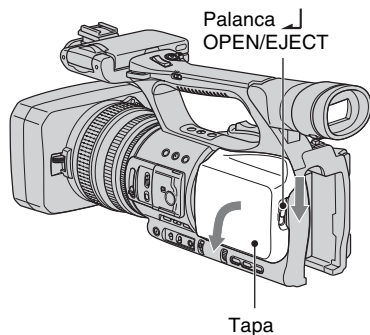

El compartimento del casete sale automáticamente.

- 2 Inserte un casete con la cara de la ventanilla hacia afuera y, a continuación, presione [PUSH].

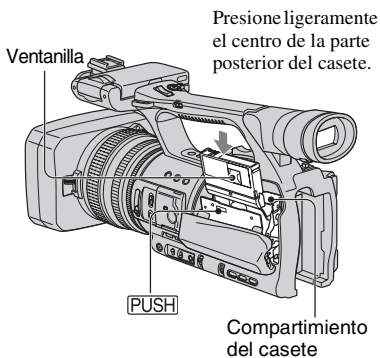

El compartimento del casete se desliza automáticamente hacia adentro.

Notas

- No presione la parte con la marca [DO NOT PUSH] mientras el compartimento del casete se desliza hacia adentro. Podría provocar una falla de funcionamiento.

- 3 Cierre la tapa.

Consejos

- El tiempo disponible para grabación varía en función del [MODO GRAB.DV]. DV

Para expulsar el casete

Abra la tapa realizando el mismo procedimiento que se describe en el paso 1 y extraiga el casete.

“Memory Stick Duo”

Puede utilizar sólo “Memory Stick Duo” que lleven la marca MEMORY STICK DUO, MEMORY STICK PRO DUO o MEMORY STICK PRO-HG DUO.

- 1** Abra la tapa de la ranura del "Memory Stick Duo" en la dirección que indica la flecha.

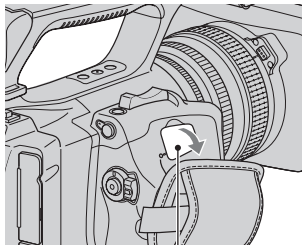

Tapa de la ranura del "Memory Stick Duo"

- 2** Inserte el "Memory Stick Duo" en la ranura para "Memory Stick Duo" en el sentido correcto hasta que calce.

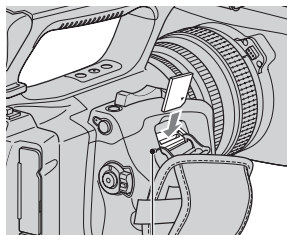

Indicador de acceso

⚠ Notas

- Si inserta el "Memory Stick Duo" en la ranura en la dirección incorrecta, puede dañarse el "Memory Stick Duo", la ranura para el "Memory Stick Duo" o los datos de imágenes.

Para expulsar un "Memory Stick Duo"

Empuje suavemente el "Memory Stick Duo" una vez.

⚠ Notas

- Cuando el indicador de acceso se enciende o parpadea, la videocámara está leyendo o grabando datos. No sacuda ni golpee la videocámara, no la apague, ni extraiga el "Memory Stick Duo" ni retire la batería. De lo contrario, se podrían dañar los datos de imágenes.
- Al insertar o expulsar el "Memory Stick Duo", procure que el "Memory Stick Duo" no salte y se caiga.

Grabación

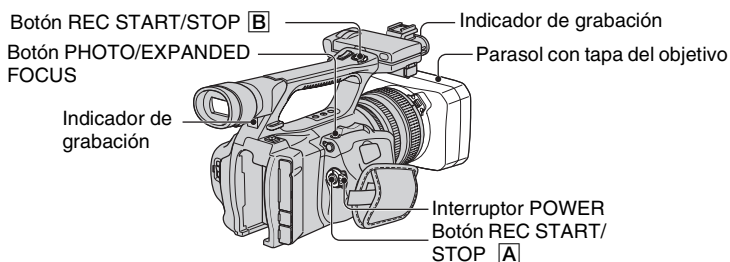

Esta videocámara graba películas en cinta e imágenes en "Memory Stick Duo". Proceda de la siguiente forma para grabar películas.

💡 Consejos

- Esta videocámara puede grabar películas en formato HDV o DV. El ajuste predeterminado es el formato HDV (FORM.GRAB.).

1 Abra el obturador del parasol del objetivo.

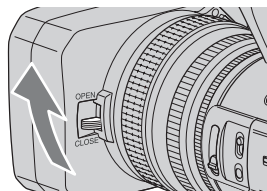

2 Deslice el interruptor POWER a la posición CAMERA mientras presiona el botón verde.

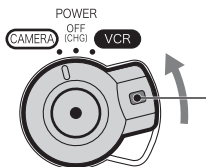

Deslice el interruptor POWER mientras presiona el botón verde.

3 Presione el botón REC START/STOP [A] (o [B]).

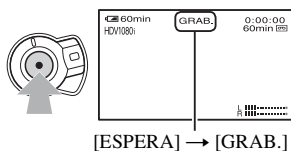

El indicador de grabación se ilumina durante la grabación.

Para detener la grabación, presione nuevamente el botón REC START/STOP.

Consejos

- Al grabar en el formato HDV, el formato está fijado en 16:9. Al grabar en formato DV, puede cambiar a 4:3 ([GRAB.PAN.DV]).
- Puede cambiar la visualización de la pantalla durante la grabación.
- El indicador de grabación se puede desactivar ([IND.GRAB.]).
- No se pueden grabar películas en un "Memory Stick Duo".
- Para grabaciones de ángulo bajo, resulta práctico utilizar el botón REC START/STOP de la palanca. Suelte la palanca HOLD para activar el botón REC START/STOP. Tal vez resulte útil colocar el panel LCD cara arriba o cerrarlo después de colocarlo cara abajo o levantar el visor durante este tipo de grabación.

Para capturar imágenes fijas

Presione el botón PHOTO/EXPANDED FOCUS o el botón PHOTO del control remoto.

Se puede grabar una imagen fija en el "Memory Stick Duo". ■■■■■ desaparece al completarse la grabación.

También puede capturar imágenes fijas durante la grabación de películas.

🔊 Notas

- Las especificaciones son para Sony "Memory Stick Duo". La cantidad real de imágenes que se pueden grabar varía según el entorno de grabación y el tipo de "Memory Stick Duo".
- No se puede almacenar una imagen fija en las siguientes condiciones:
 - Cuando [EXPL.PROG.] está ajustado en [DESACTIV.] o [30] y la velocidad de obturación menor que 1/60
 - Cuando [EXPL.PROG.] está ajustado en [24] y la velocidad de obturación es menor que 1/48
 - Mientras usa el desvanecedor
 - Mientras usa grabación lenta uniforme
 - Mientras usa transición de filmación

💡 Consejos

- Cuando toma una imagen fija y no está grabando una película, escuchará el clic del obturador.
- A continuación se indican los tamaños de las imágenes fijas:
 - Grabación en formato HDV/DV (16:9): 1,2 M
 - Grabación en formato DV (4:3): 0,9 M
 - Reproducción en formato HDV: 1,2 M
 - Reproducción en formato DV (16:9): 0,2 M
 - Reproducción en formato DV (4:3): VGA
- Puede ajustar el botón PHOTO/EXPANDED FOCUS para iniciar la función de enfoque ampliado al presionar el botón ([PHOTO/EXP.FOCUS]).
- La disposición única de píxeles del sensor ClearVid CMOS de Sony y el sistema de procesamiento de imágenes (Enhanced Imaging Processor) permiten una resolución de imágenes fijas equivalente a los tamaños descritos.

Capacidad del "Memory Stick Duo" (MB) y número de imágenes que se pueden grabar

	1,2M 1440 × 810 1,2M	0,9M 1080 × 810 0,9M	VGA 640 × 480 VGA	0,2M 640 × 360 0,2M
512 MB	770	1000	2900	3650
1 GB	1550	2100	6000	7500
2 GB	3150	4300	12000	15000
4GB	6300	8500	23500	29500
8 GB	12500	17000	48000	60000
16 GB	25500	34500	97500	122000

Para almacenar imágenes fijas capturadas de películas de una cinta en un "Memory Stick Duo"

Puede capturar una imagen de una película y grabarla en un "Memory Stick Duo" como una imagen fija. Asegúrese de insertar una cinta grabada y un "Memory Stick Duo" en la videocámara.

- ① Ajuste el interruptor POWER en VCR.
- ② Presione el botón ► (reproducir) para buscar la escena que desea guardar como imagen fija. Presione el botón PHOTO/EXPANDED FOCUS o el botón PHOTO del control remoto en la escena.

🔊 Notas

- En el "Memory Stick Duo" se guardan tanto la hora y la fecha de grabación en la cinta como la hora y la fecha de guardado en el "Memory Stick Duo". Cuando vea las imágenes fijas, en pantalla sólo aparecerán la fecha y hora en que fueron grabadas en la cinta (código de datos).
- Los datos de la cámara almacenados en la cinta no se copian en el "Memory Stick Duo".
- No se puede almacenar una imagen fija mientras se usa la videocámara con [ZOOM REPR.] ajustado en [ACTIVADO].

Free Manuals Download Website

<http://myh66.com>

<http://usermanuals.us>

<http://www.somanuals.com>

<http://www.4manuals.cc>

<http://www.manual-lib.com>

<http://www.404manual.com>

<http://www.luxmanual.com>

<http://aubethermostatmanual.com>

Golf course search by state

<http://golfingnear.com>

Email search by domain

<http://emailbydomain.com>

Auto manuals search

<http://auto.somanuals.com>

TV manuals search

<http://tv.somanuals.com>