

# Linear PCM Recorder

Getting Started	_____	██████████
Basic Operations	_____	██████████
Other Recording Operations	_____	██████████
Other Playback Operations	_____	██████████
Editing Tracks	_____	██████████
About the Menu Function	_____	██████████
Utilizing Your Computer	_____	██████████
Additional Information	_____	██████████
Troubleshooting	_____	██████████
Index	_____	██████████

Operating Instructions

## PCM-M10

## Owner's Record

The model number is located at the rear panel and the serial number is located inside the battery compartment. Record the serial number in the space provided below. Refer to these numbers whenever you call upon your Sony dealer regarding this product.

Model No. PCM-M10 \_\_\_\_\_

Serial No. \_\_\_\_\_

## FOR UNITED STATES CUSTOMERS. NOT APPLICABLE IN CANADA, INCLUDING IN THE PROVINCE OF QUEBEC.

## POUR LES CONSOMMATEURS AUX ÉTATS-UNIS. NON APPLICABLE AU CANADA, Y COMPRIS LA PROVINCE DE QUÉBEC.

## For the customers in the United States

The following FCC statement applies only to the version of this model manufactured for sale in the USA. Other versions may not comply with FCC technical regulations.

## INFORMATION

This equipment has been tested and found to comply with the limits for a Class B digital device, pursuant to Part 15 of the FCC Rules. These limits are designed to provide reasonable protection against harmful interference in a residential installation. This equipment generates, uses and can radiate radio frequency energy and, if not installed and used in accordance with the instructions, may cause harmful interference to radio communications.

However, there is no guarantee that interference will not occur in a particular installation. If this equipment does cause harmful interference to radio or television reception, which can be determined by turning the equipment off and on, the user is encouraged to try to correct the interference by one or more of the following measures:

Reorient or relocate the receiving antenna.

Increase the separation between the equipment and receiver.

Connect the equipment into an outlet on a circuit different from that to which the receiver is connected. Consult the dealer or an experienced radio/TV technician for help.

You are cautioned that any changes or modifications not expressly approved in this manual could void your authority to operate this equipment.

If you have any questions about this product, you may call: Sony Customer Information Service Center 1-800-222-7669 or <http://www.sony.com/>

## Declaration of Conformity

Trade Name : SONY  
Mode : PCM-M10  
Responsible Party : Sony Electronics Inc.  
Address : 16530 Via Esprillo,  
San Diego, CA 92127 USA  
Telephone Number : 858-942-2230

This device complies with part 15 of the FCC Rules. Operation is subject to the following two conditions: (1) this device may not cause harmful interference, and (2) this device must accept any interference received, including interference that may cause undesired operation.

- The recorded music is limited to private use only. Use of the music beyond this limit requires permission of the copyright holders.
- Sony is not responsible for incomplete recording/ downloading or damaged data due to problems of the PCM recorder or computer.
- Depending on the types of the text and characters, the text shown on the PCM recorder may not be displayed properly on device. This is due to:
  - The capacity of the connected PCM recorder.
  - The PCM recorder is not functioning normally.
  - Content information is written in the language or the character that is not supported by the PCM recorder.

## Notice for users

Program © 1999, 2000, 2001, 2002, 2003, 2004, 2005, 2006, 2007, 2008, 2009 Sony Corporation  
Documentation ©2009 Sony Corporation

All rights reserved. This manual or the software described herein, in whole or in part, may not be reproduced, translated or reduced to any machine readable form without prior written approval from Sony Corporation.

IN NO EVENT SHALL SONY CORPORATION BE LIABLE FOR ANY INCIDENTAL, CONSEQUENTIAL OR SPECIAL DAMAGES, WHETHER BASED ON TORT, CONTRACT, OR OTHERWISE, ARISING OUT OF OR IN CONNECTION WITH THIS MANUAL, THE SOFTWARE OR OTHER INFORMATION CONTAINED HEREIN OR THE USE THEREOF.

Sony Corporation reserves the right to make any modification to this manual or the information contained herein at any time without notice. The software described herein may also be governed by the terms of a separate user license agreement. This software is for Windows and cannot be used for Macintosh.

The supplied connecting cable is for the PCM-M10 linear PCM Recorder. You cannot connect other linear PCM recorders.

# Table of Contents

Techniques for Better Recording .....	7
---------------------------------------	---

## Getting Started

Step 1: Checking the Contents of the Package .....	10
Index to parts and controls .....	11
Step 2: Inserting the Batteries .....	13
When to replace batteries .....	14
To operate with the AC power adaptor .....	15
Step 3: Turning the PCM recorder On ....	16
Turning the power on .....	16
Turning the power off .....	16
Step 4: Setting the Clock .....	17
Setting the clock after inserting batteries .....	17
Setting the clock using the menu .....	17
Step 5: Setting the Language to Be Used in the Display Window .....	19
Preventing Accidental Operation – HOLD .....	21
Locking the buttons of the PCM recorder .....	21
Unlocking the buttons of the PCM recorder .....	21

## Basic Operations

Recording .....	22
Listening .....	26
Deleting .....	30

## Other Recording Operations

Changing the Recording Method .....	32
Recording using the remote commander .....	32
Manual recording .....	33
Recording a few seconds in advance – the Pre-Recording function .....	34
Recording on a memory card .....	36
Recording across memory media – Cross-Memory Recording .....	39
Changing the Recording Settings .....	41
Selecting the recording mode .....	41
Setting the microphone sensitivity .....	42
Cutting out low frequency – the LCF function .....	43
Preventing sound distortion– the LIMITER function .....	44
Recording via Other Devices .....	46
Recording with an external microphone .....	46
Recording from other equipment .....	47

## Other Playback Operations

Changing the Playback Method .....	49
Changing the display during playback .....	49
Listening the playback sounds with the headphones or external speakers .....	50
Quickly locating the point you wish to start playback – Easy Search .....	51
Selecting the playback mode .....	51
Playing back repeatedly .....	52
Changing the Playback Sounds .....	54
Adjusting the playback speed – the DPC function .....	54
Adjusting the playback tones – Key Control .....	55
Reinforcing the bass sound – Effect .....	56
Playback via Other Devices .....	58
Recording with other equipment .....	58

## Editing Tracks

Adding a Mark to a Track .....	60
Using a track mark .....	60
Adding a “TAKE” or “KEEP” to a file name .....	62
Protecting a track .....	64
Arranging Tracks .....	65
Copying a track to the other memory .....	65
Dividing a track into two .....	66

Deleting all tracks in a folder .....	69
---------------------------------------	----

## About the Menu Function

Making Settings for the Menu .....	71
Menu settings .....	72

## Utilizing Your Computer

Using the PCM recorder with Your Computer .....	83
Connecting the PCM recorder to your computer .....	84
Structure of folders and files .....	85
Copying Tracks from the PCM recorder to Your Computer .....	87
Copying Files from Your Computer to the PCM recorder and Playing Them Back .....	88
Using the PCM Recorder as a USB Memory – Data Storage Function .....	90
Disconnecting the PCM Recorder from Your Computer .....	91

## Additional Information

Precautions .....	92
Specifications .....	95
System requirements .....	95
Battery life .....	100

## Troubleshooting

Troubleshooting .....	102
Error Messages .....	108
System Limitations .....	112
Display Window .....	113
Index .....	116
Trademarks .....	119

What you record is for personal enjoyment and use only. Copyright laws prohibit other forms of use without the permission of the copyright holders. The use of Memory Stick™ media for recording copyright-protected graphics or other data is limited to the restrictions specified under applicable copyright laws. Any use beyond those restriction is prohibited.

This product is compatible with Memory Stick Micro™ (M2™) media. M2™ is the abbreviated product name for a Memory Stick Micro™. In this booklet, M2™ is used to describe Memory Stick Micro™ media.

# Techniques for Better Recording

The PCM-M10 linear PCM recorder allows you to enjoy high-quality recording in a variety of situations. This section introduces easy recording setups for 6 typical music scenes.

## For recording a solo acoustic guitar performance



### 💡 Tips for setup

- Use a tripod or other device to set the PCM recorder about 1 meter from the guitar.
- Set the PCM recorder so that its built-in microphones face the sound box of the guitar.
- To start, stop recording, or add track marks remotely, use the supplied remote commander.

---

<b>REC LEVEL</b>	AUTO
------------------	------

---

<b>MIC SENS(ATT)</b>	HI
----------------------	----

---

## For recording a piano performance



### 💡 Tips for setup

- Use a tripod or other device to set the PCM recorder level with the piano keyboard.
- Set the PCM recorder approximately 1.5 meters from the piano.

---

<b>REC LEVEL</b>	AUTO
------------------	------

---

<b>MIC SENS(ATT)</b>	• When recording near the piano: LOW
	• When recording far from the piano: HI

---

## For recording a jazz trio performance



### 💡 Tips for setup

- Use a tripod or other device to set the PCM recorder as close to the lead instrument as possible.
- While monitoring recording, move the PCM recorder to the position where volume levels from instruments are well-balanced.

---

<b>REC LEVEL</b>	AUTO
------------------	------

---

<b>MIC SENS(ATT)</b>	• When recording near the instrument: LOW
	• When recording far from the instrument: HI

---

## For recording a band performance at a recording studio



### 💡 Tips for setup

- Use a tripod or other device to set the PCM recorder.
- Adjust the orientation and height of the PCM recorder, so that the built-in microphones face the vocalist.
- Adjust the positions of guitar amplifier and base amplifier so that their volume levels are well-balanced.

---

<b>REC LEVEL</b>	AUTO
------------------	------

---

<b>MIC SENS(ATT)</b>	LOW
----------------------	-----

---



## For recording an electronic piano performance via a line connection

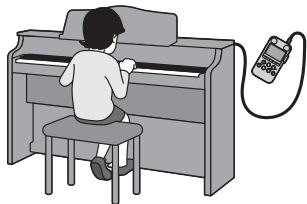

### Tips for setup

- Connect the line output jack of an electronic piano to the LINE IN jack of the PCM recorder with a cable (not supplied).
- Adjust the recording level to the optimum with the REC LEVEL dial.

---

<b>REC LEVEL</b>	MANUAL
------------------	--------

---

<b>LIMITER</b>	ON (menu setting)
----------------	-------------------

---

## For recording a musical performance of large number of performers such as a children's chorus at a concert hall



### Tips for setup

- Set the PCM recorder as close to the conductor or to the stage as possible.
- Set the PCM recorder so that the built-in microphones face the performers.

---

<b>REC LEVEL</b>	MANUAL
------------------	--------

---

<b>LIMITER</b>	ON (menu setting)
----------------	-------------------

---

### For better recording

- For the most natural and dynamic recording, manual recording is recommended. (Adjustment using the REC LEVEL dial is required.)
- To obtain the best recording results, perform a trial recording in advance.

- The PCM recorder provides a level guide function that displays an error message when an excessive recording level is detected during automatic recording.

# Step 1: Checking the Contents of the Package

### Linear PCM recorder (1)



Remove the film on the display window before you use the PCM recorder.

### Remote commander (1)



### AC power adaptor (3V) (1)



### USB connecting cable (1)

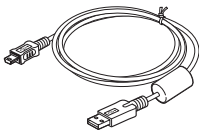

### LR6 (size AA) alkaline batteries (2)

### Hand strap (1)

### CD-ROM (1)

(Sound Forge Audio Studio LE)

### Operating Instructions

“Sound Forge Audio Studio LE” is a software application that supports editing and CD creation on your computer. For an introduction to installation of the software, see the “Sound Forge™ Audio Studio LE Guide.”

You are cautioned that any changes or modifications not expressly approved in this manual could void your authority to operate this equipment.

## Index to parts and controls

### Front

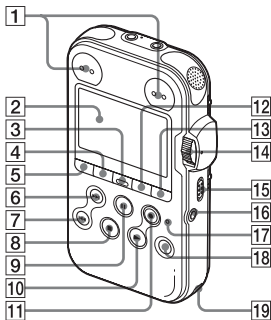

- 1** Peak level L/R (-12 dB/OVER) indicators
- 2** Display window
- 3** DELETE button
- 4** MENU button
- 5** (folder) button
- 6** FF/ (fast-forward/up) button
- 7** FR/ (fast-rewind/down) button
- 8** STOP button
- 9** PAUSE button/indicator
- 10** PLAY/ENTER button/indicator\*
- 11** REC (record) button/indicator

- 12** (repeat) A-B button
- 13** DISPLAY button
- 14** REC LEVEL (recording level) dial
- 15** POWER/HOLD switch
- 16** REMOTE jack
- 17** ACCESS indicator
- 18** T-MARK (track mark) button
- 19** Strap hole

### Rear

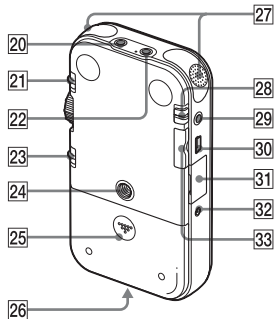





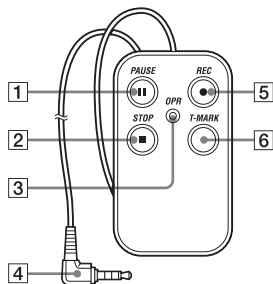

- 20** LINE IN (line input) jack
- 21** MIC SENS(ATT) (microphone sensitivity (attenuator)) HI/LOW (high/low) switch
- 22** (microphone) jack (Plug In Power compatible)\*
- 23** (volume up) button
- 24** (volume down) button
- 25** T-MARK button
- 26** Strap hole
- 27** Headset jack
- 28** MIC (microphone) jack
- 29** LINE OUT (line output) jack
- 30** POWER/HOLD switch
- 31** ACCESS indicator
- 32** REMOTE jack
- 33** REC LEVEL dial

- 23 REC LEVEL (recording level)  
MANUAL/AUTO switch
- 24 Hole for attaching the tripod (not supplied)
- 25 Battery compartment
- 26 Speaker (on the basement)
- 27 Built-in microphones (stereo)
- 28 DPC (SPEED CTRL) (speed control)  
ON/OFF switch
- 29  $\phi$ /LINE OUT (headphone/line output)  
jack
- 30  USB connector
- 31 M2™/microSD memory card slot
- 32 DC IN 3V jack
- 33 VOLUME (volume) +\*/- button

\* These buttons and jack have a tactile dot.  
Use it as a reference point for operations, or  
to identify each terminal.

## Remote commander (supplied)



- 1  PAUSE button
- 2  STOP button
- 3  OPR (Operation) indicator
- 4  Connecting plug
- 5  REC button
- 6  T-MARK (track mark) button

## Step 2: Inserting the Batteries

- 1** Slide and lift the battery compartment lid in the direction of the arrow.

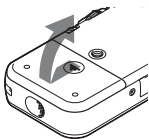

- 2** Insert the two supplied LR6 (size AA) alkaline batteries into the battery compartment, and then close the lid.

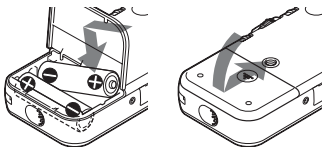

Be sure to insert the batteries with the ⊕ and ⊖ ends in the right position.

### If the battery compartment lid is detached

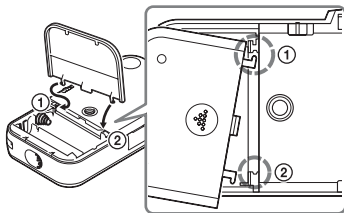

If you drop the PCM recorder or handle it roughly, the battery compartment lid may become detached.

If this occurs, insert a projected part at one end of the battery compartment lid into the opening on the PCM recorder (①), and then align the other projected part of the lid along the slit of the PCM recorder (②) as illustrated above. Then stand up the lid and push it down until the lid is attached to the PCM recorder.

### When using rechargeable batteries

You can use rechargeable batteries with the PCM recorder. To use rechargeable

batteries, select “NiMH Battery” in the “Battery Setting” submenu of the “Detail Menu.” With this setting, the battery remain indicator for the rechargeable batteries will be displayed more precisely. See “Making Settings for the Menu” on page 71.

### Tips

- Even if fully-charged rechargeable batteries are inserted, the battery indicator may not show the full status.
- Use a charger to recharge batteries at room temperatures.
- Use the following charger and rechargeable batteries for the PCM recorder:
  - Nickel metal hydride rechargeable battery: NH-AA-B2K
  - Quick battery charger for nickel metal hydride rechargeable batteries: BCG-34HS2K

## When to replace batteries

When using batteries, the battery indicator on the display shows the battery condition.

### Battery remain indication



: “Low Battery Level” appears.

Replace two old batteries with new ones soon.



: “Change Battery” appears and the PCM recorder will stop operation.

### Tips

- Do not use manganese batteries for this PCM recorder.
- When replacing the batteries, tracks recorded are not deleted even when you remove the batteries.
- When replacing batteries, the clock continues moving for about 3 minutes after you remove the batteries.
- When replacing batteries, turn off the power of the PCM recorder.
- Do not mix different types of batteries.

## To operate with the AC power adaptor

Insert the supplied AC power adaptor securely into the DC IN 3V jack until it stops to the end.

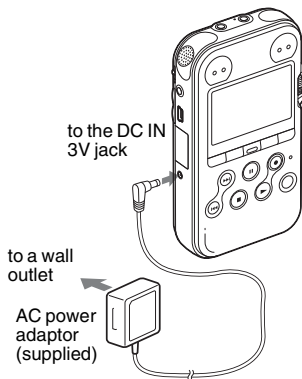

# Step 3: Turning the PCM recorder On

## Turning the power on

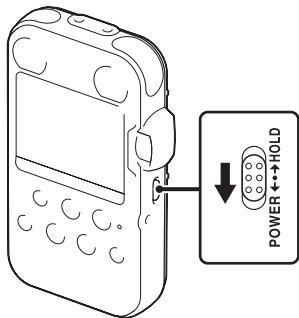

Slide the POWER/HOLD switch in the direction of “POWER” for more than 1 second. The PCM recorder is turned on, and an animation of “Accessing...” is displayed.

## Turning the power off

Slide the POWER/HOLD switch in the direction of “POWER” for more than 2 seconds, and an animation of “See You!” is displayed.

### 💡 Tips

- The PCM recorder is accessing memory while “Accessing...” appears on the display or the ACCESS indicator flashes. During this time, do not remove or insert batteries and do not disconnect or connect the AC power adaptor, or the USB connecting cable. Doing so may damage the data.
- Even if you do not use the PCM recorder, the batteries are consumed slightly. When you are not going to use the PCM recorder for an extended period of time, it is recommended that you turn the power off and remove the batteries.
- When the PCM recorder remains turned on and in the stop mode for about 10 minutes or longer, the window display turns off automatically and the PCM recorder enters the sleep mode. You can operate the PCM recorder by pressing a button.



## Step 4: Setting the Clock

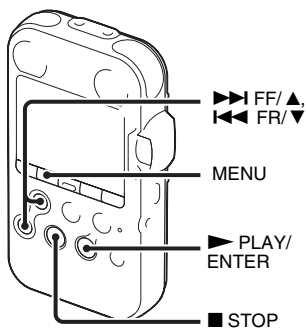

Recorded audio files (tracks) are named using the date and time of the clock. By setting the clock before recording, the recording's date and time will be correctly saved.

When the PCM recorder is turned on before the clock has been set, "Set Clock" appears on the display. Then the "Clock" display of the menu appears, and the year section flashes in the display window.

### Setting the clock after inserting batteries

- 1 Press **▶▶ FF/▲** or **◀◀ FR/▼** to set the year, and then press **▶ PLAY/ENTER**. Perform the same operations to set month, day, hour, and minute in sequence.

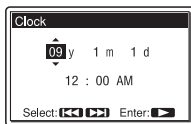

- 2 Press **■ STOP** to return to the stop mode display.

### Setting the clock using the menu

While the PCM recorder is in the stop mode, you can set the clock using the menu.

- 1 Select "Clock" in the menu in the stop mode.

- ① Press MENU to enter the menu mode. The menu mode window will be displayed.

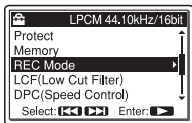

- ② Press ►►► FF/▲ or ◀◀◀ FR/▼ to select "Detail Menu," and then press ►►► PLAY/ENTER.
- ③ Press ►►► FF/▲ or ◀◀◀ FR/▼ to select "Clock," and then press ►►► PLAY/ENTER.

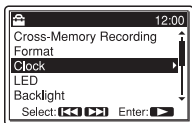

- 2 Press ►►► FF/▲ or ◀◀◀ FR/▼ to select the date, and then press ►►► PLAY/ENTER.

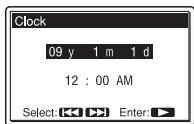

- 3 Press ►►► FF/▲ or ◀◀◀ FR/▼ to set the year, and then press ►►► PLAY/ENTER. Perform the same operations to set month, day, hour, and minute in sequence.

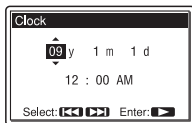

- 4 Press ■ STOP to return to the stop mode display.

#### ■ Notes

- If you do not press a button within 1 minute of entering the clock setting data, the clock setting mode is cancelled and the window will return to the stop mode display.
- If you leave the PCM recorder for approximately 3 minutes or longer, with no batteries inserted, the clock is reset to the default settings. In this case, set the clock again.

## Step 5: Setting the Language to Be Used in the Display Window

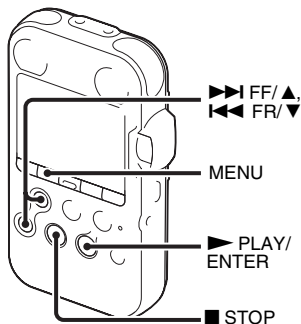

You can select the language to be used for tracks, menus, folder names, file names, etc. from 3 languages.

- 1 Press MENU to enter the menu mode.  
The menu mode window will be displayed.

- 2 Press ►►► FF/▲ or ◀◀◀ FR/▼ to select "Detail Menu," and then press ► PLAY/ENTER.

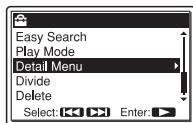

- 3 Press ►►► FF/▲ or ◀◀◀ FR/▼ to select "Language," and then press ► PLAY/ENTER.

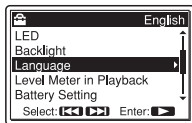

- 4** Press ►► FF/ ▲ or ◀◀ FR/ ▼ to select the language that you want to use, and then press ► PLAY/ENTER.



You can select the following languages.  
English, Español (Spanish), Français (French).

- 5** Press ■ STOP to return to the stop mode display.

# Preventing Accidental Operation – HOLD

## Locking the buttons of the PCM recorder

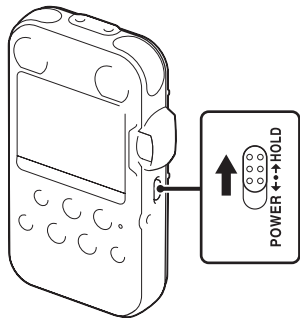

Slide the POWER/HOLD switch in the direction of “HOLD.”  
 “HOLD” will appear for approximately 3 seconds and all the functions of the buttons of the PCM recorder are locked.

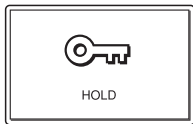

## Unlocking the buttons of the PCM recorder

Slide the POWER/HOLD switch towards the center so that all buttons will be unlocked.

### Note

When the HOLD function is activated during recording, all the functions of the buttons of the PCM recorder are locked to prevent accidental operation. To stop recording, cancel the HOLD function first.

### Tip

Even if the HOLD function is activated, you can start, pause, or stop recording, or add track marks by using the remote commander connected to the PCM recorder.

# Recording



### Note

Before making a recording, turn on the power of the PCM recorder.

## Selecting a folder

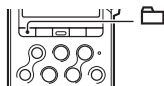
- 1 Press  to display the folder selection window in the stop mode.



- 2 Press  FF/▲ or  FR/▼ to select the folder in which you want to record tracks ( FOLDER01-10).  
When you purchase the PCM recorder, there are 10 folders already available.

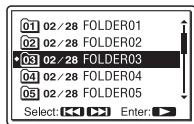
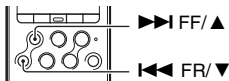

- 3 Press  PLAY/ENTER.

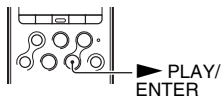

## Starting recording (automatic recording)

- 1 Set the REC LEVEL switch to “AUTO,” and press
  - REC in the stop mode to enter the recording standby mode.

The ● REC indicator lights in red and the || PAUSE indicator flashes in orange (Recording Standby mode).  
When you select “AUTO,” the recording level will be adjusted automatically.

The REC LEVEL dial adjustment is enabled when you select “MANUAL.”

You can change the microphone sensitivity with the MIC SENS(ATT) switch.

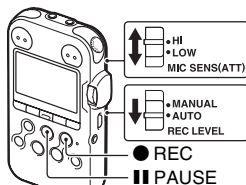

- 2 Turn the built-in microphones in the direction of the source to be recorded, and press || PAUSE, or ► PLAY/ENTER.

Recording starts. The new track will be recorded at the end in the selected folder.

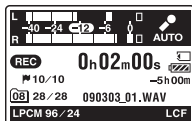
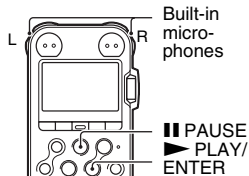

## To stop recording

---

Press **■** STOP.

The ACCESS indicator flashes in orange and the PCM recorder stops at the beginning of the current recording.



## Note while accessing

The PCM recorder is recording data and saving it in memory when the ACCESS indicator flashes in orange. While the PCM recorder is accessing data, do not remove the batteries, plug or unplug the AC power adaptor or connecting cables. Doing so may damage the data.

## Other operations

---

pause recording

Press **||** PAUSE. During recording pause, "**||**" flashes in the display window.

---

release pause and resume recording

Press **||** PAUSE again or press **▶** PLAY/ENTER. Recording resumes from that point. (To stop recording after pausing recording, press **■** STOP.)

---

## 💡 Tips

- You can record up to 99 tracks in each folder.
- When an excessive recording level (exceeding  $-1$  dB) is detected during the recording standby mode, the peak level L/R OVER indicators light in red and the following level guide is displayed. You may solve the problem by moving the PCM recorder far from the sound source, or setting the MIC SENS(ATT) switch to "LOW." If the problem persists, use manual recording (page 33).

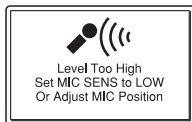



- When a memory card is being inserted, you can continue recording a track by changing the folder to save the track from the internal memory to the memory card automatically after the internal memory is full (Cross-Memory Recording)(page 39).
- When you connect the supplied wired remote commander to the PCM recorder, you can also press ● REC, ■ PAUSE, and ■ STOP on the remote commander to perform recording operations.
- Before you start recording, we recommend you make a trial recording first.

### ■ Notes

- Operating or touch noises may be recorded if an object, such as your finger, etc., accidentally rubs or scratches the PCM recorder during recording.
- You do not need to press and hold ● REC while recording.
- Before making a recording, be sure to check the battery indicator (page 14).
- In automatic recording, the REC LEVEL dial adjustment and the LIMITER setting will not work.

### Listening the recording with headphones (not supplied) – Monitoring

If you connect headphones (not supplied) to the /LINE OUT (headphone/line output) jack, you can monitor the recording. You can adjust the monitoring volume by pressing VOLUME +/-, but the recording level is fixed.

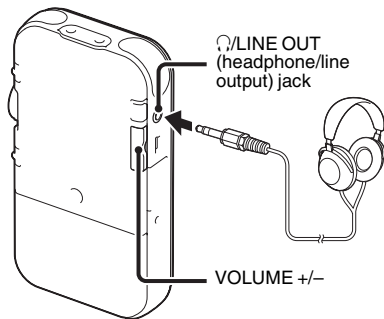

### ■ Note

Make sure that “Audio Out” in the menu is set to “Headphones.” If “LINE OUT” is selected, do not connect headphones; the playback sound from the headphones will be very loud.

The “Audio Out” in the menu is set to “Headphones,” when you purchase the PCM recorder (page 58).

# Listening

## ■ Note

Before the playback starts, turn on the power of the PCM recorder.

## Before you start playback

---

Connect headphones (not supplied) to the /LINE OUT (headphone/line output) jack for better playback sound.

## ■ Note

Make sure that “Audio Out” in the menu is set to “Headphones.” If “LINE OUT” is selected, do not connect headphones; the playback sound from the headphones will be very loud.

The “Audio Out” in the menu is set to “Headphones,” when you purchase the PCM recorder (page 58).

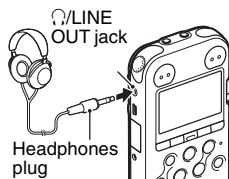

## To start playback

---

1 Press  in the stop mode.

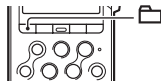

2 Press  or  to select the folder.

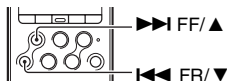

- 3** Press ► PLAY/ENTER.

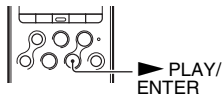

- 4** Press ►► FF/▲ or ◀◀ FR/▼ to select the track you want to play.

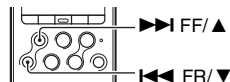

- 5** Press ► PLAY/ENTER.

Playback will start soon, and the ► PLAY/ENTER indicator will light in green. (When “LED” is set to “OFF” in the menu (page 79), the indicator does not light.)

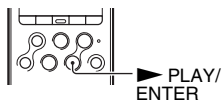

- 6** Press VOLUME +/- to adjust the volume.

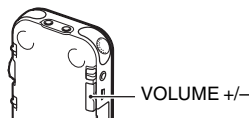

## To stop playback

---

Press ■ STOP.

The PCM recorder stops at the current position. To resume playback from that point, press ► PLAY/ENTER.

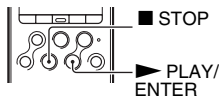

## Other operations

---

stop at the current position (Playback Pause function) Press ■ PAUSE. To resume playback from that point, press ■ PAUSE again or press ► PLAY/ENTER.  
During playback pause, “▶■” flashes in the display window.

---

go back to the beginning of the current track Press ◀◀ FR/ ▼ once.\*1

---

go back to previous tracks Press ◀◀ FR/ ▼ repeatedly.\*2  
(During the stop mode, keep the button pressed to go back the tracks continuously.)\*3

---

skip to the next track Press ▶▶ FF/ ▲ once.\*1

---

skip to the succeeding tracks Press ▶▶ FF/ ▲ repeatedly.\*2  
(During the stop mode, keep the button pressed to skip the tracks continuously.)\*3

---

Fast forward (Cue) Press and hold the ▶▶ FF/ ▲ during playback.\*4

---

Fast reverse (Review) Press and hold the ◀◀ FR/ ▼ during playback.\*4

---

\*1 When a track mark is set, the PCM recorder goes backward or forward to the track mark before or after the current point.

\*2 These operations are for when “Easy Search” is set to “OFF” (page 77).

\*3 In the continuous searching mode, the PCM recorder does not locate track marks.

\*4 If you press and hold the button, the PCM recorder goes forward or backward slowly at first, and then at gradually higher speed.

## 💡 Quickly locating the point you want to start playback (Easy Search)

By setting “Easy Search” to “ON” in the menu, you can go back approximately 3 seconds by pressing ◀◀ FR/ ▼, or advance approximately 10 seconds during playback by pressing ▶▶ FF/ ▲ (page 51).

## 💡 Tracks that the PCM recorder can play back

In addition to the tracks that the PCM recorder has recorded as LPCM (WAV) or MP3 files, the PCM recorder can play back WMA, AAC-LC (m4a), MP3, and LPCM (WAV) files copied from your computer or other external device.

## To select a folder

The PCM recorder saves the tracks it has recorded and the files copied from your computer or other external device in the following folder structure. There are two types of folders, which can be distinguished by the folder indicators in the display window as follows:

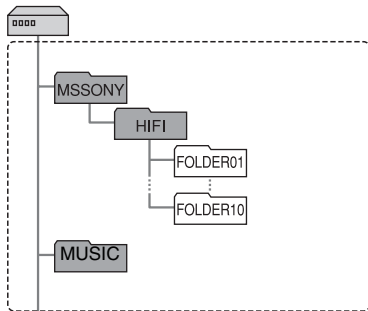

Part of the folder structure of the internal memory

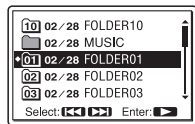

Folder selection window

- Folder for tracks recorded using the PCM recorder (FOLDER01-FOLDER10) (They have already been made when you purchase the PCM recorder.)
- Folder copied from a computer (These folders are displayed when music files have been copied from a computer.)

# Deleting

## ■ Notes

- Once a track has been deleted, you cannot retrieve it.
- Before deleting the track, turn on the power.

## Selecting a track and deleting it

---

**1** Select the track you want to delete when the PCM recorder is in the stop or playback mode.

---

**2** Press DELETE.

“Delete?” appears with the track title.

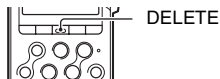

**3** Press ►►► FF/▲ or ◀◀◀ FR/▼ to select “Execute.”

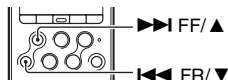
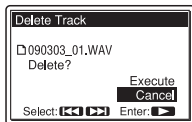

**4** Press ► PLAY/ENTER.

“Deleting...” appears in the display window and the selected track will be deleted.

When a track is deleted, the remaining tracks will advance so that there will be no space between tracks.

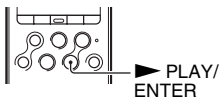

## To cancel deleting midway

---

Select “Cancel” in step 3 of “Selecting a track and deleting it,” and then press ► PLAY/ENTER.

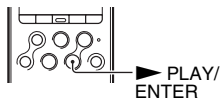

## Deleting another track

Proceed with the steps 1 through 4 in “Selecting a track and deleting it.”

## Deleting a part of a track

Use the Divide function in the menu to divide a track into two first, one you want to delete and the other you do not want to delete. Then proceed with the steps 1 through 4 in “Selecting a track and deleting it.”

# Changing the Recording Method

## Recording using the remote commander

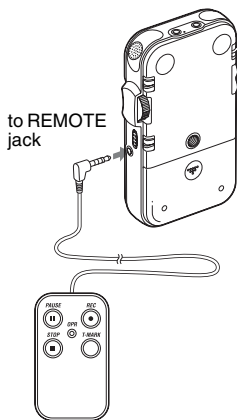

You can use the supplied wired remote commander to perform recorder operations remotely. Insert the remote commander plug securely into the REMOTE jack. Press the appropriate buttons on the remote commander to perform operations such as

recording, pausing and stopping recording, and adding track marks.

You can operate the PCM recorder even while it is in the hold state.

### 💡 Using the remote commander for better recorded sound

- By operating the PCM recorder using the remote commander, you can prevent the PCM recorder from picking up noises which may be caused by accidentally pressing a button, touching the case, or holding the PCM recorder.
- By placing the PCM recorder at the most suitable position for recording (e.g. at the center of multiple players, or near the stage), and by starting and stopping recording remotely, you can obtain a more lively and natural stereo sound recording.



## Manual recording

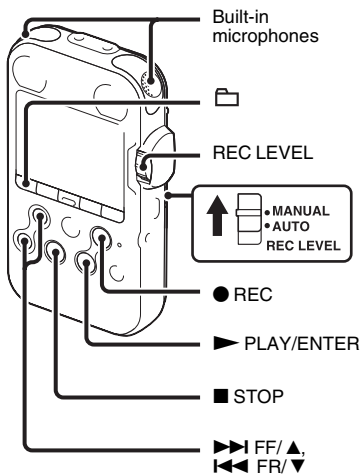

When you set the REC LEVEL switch to “MANUAL,” you can adjust the recording level manually, according to the sound source. If necessary, you can also utilize the “LIMITER” (page 44) and “LCF(Low Cut Filter)” (page 43) in the menu to reduce sound distortion.

**1** Set the REC LEVEL switch to “MANUAL.”

**2** Select a folder.

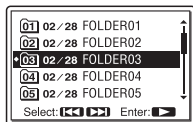

**3** Press ● REC.

The PCM recorder enters the recording standby mode. When the microphones pick up sound, the level meter in the display window moves.

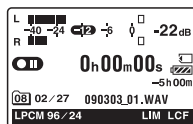

**4** Adjust the recording level with the REC LEVEL dial.

You can check the recording level with both the peak meter of the display window and the peak level indicators. Adjust the level closer to -12 dB, into a range that is appropriate for your sound source.

If the peak level OVER indicator lights in red when the recording level exceeds -1 dB, or “OVER” appears on the display window, distortion may occur. Reduce the recording level.



Adjust the OVER indication maximum level of the sound to about -12 dB.

- 5 Make other settings for recording, such as “LIMITER” (page 44), “LCF(Low Cut Filter)” (page 43), etc., in the menu.
- 6 To start recording, press **|| PAUSE** or **▶ PLAY/ENTER**.

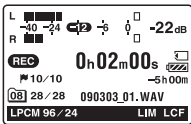

- 7 To stop recording, press **■ STOP**.

## Recording a few seconds in advance – the Pre-Recording function

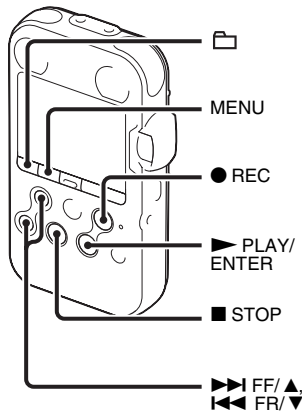

The pre-recording function allows you to record sound sources for approximately 5 seconds prior to the point when recording is actually started.

This is useful for recording during interviews or when making an open-air recording so that you will not miss an opportunity to start recording.

Sounds for 5 seconds are buffered in the memory

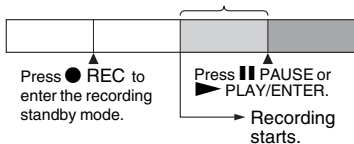

- 1 Press MENU to enter the menu mode. The menu mode window will be displayed.
- 2 Press ►►► FF/▲ or ◀◀◀ FR/▼ to select “Detail Menu,” and then press ► PLAY/ENTER.

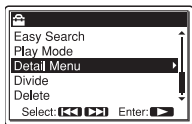

- 3 Press ►►► FF/▲ or ◀◀◀ FR/▼ to select “PRE REC,” and then press ► PLAY/ENTER.

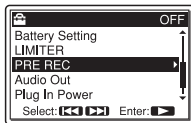

- 4 Press ►►► FF/▲ or ◀◀◀ FR/▼ to select “ON,” and then press ► PLAY/ENTER.

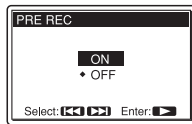

- 5 Press ■ STOP to exit the menu mode.
- 6 Select a folder.
- 7 Press ● REC.

The PCM recorder enters the recording standby mode. Pre-recording starts and sounds for a maximum of the last 5 seconds are buffered in the memory.

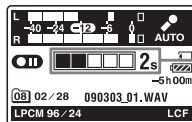

Displays how long the sound is buffered in the memory.

- 8 To start recording, press **|| PAUSE** or **▶ PLAY/ENTER**.

The standby for recording mode is released, and recording continues from the sound buffered in step 7.

- 9 To stop recording, press **■ STOP**.

### ■ Notes

- If you start recording with the pre-recording function using the built-in microphones, a click noise may be recorded when you press **● REC**. To record with the pre-recording function, we recommend you use the supplied wired remote commander or an external microphone.
- When the remaining recordable time is less than 10 seconds, the pre-recording function is disabled. Before starting to use the pre-recording function, delete unwanted files.
- If you stop recording before step 8, sounds buffered in the memory will not be saved.

### To cancel the pre-recording function

Set “PRE REC” to “OFF” in step 4.

## Recording on a memory card

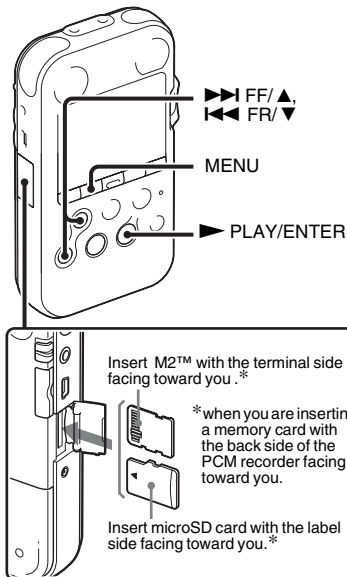

In addition to the built-in memory, you can record a track on a memory card.

## About compatible memory cards

Memory cards that you can use with the PCM recorder are as follows:

- Memory Stick Micro™ (M2™) media:  
Up to 16 GB is supported. For compatible M2™, please refer to the Sony web site (page 95).
- microSD card:  
A microSD (FAT16) card smaller than 2 GB and a microSDHC (FAT32) card from 4 GB to 16 GB are supported.

A memory card of 64 MB or less is not supported.

The microSD/microSDHC cards that have been operationally tested according to our standards are as follows.

Supplier	1 GB	2 GB	4 GB	8 GB	16 GB
Toshiba	○	○	○	○	○
Panasonic	○	○	○	○	○
SanDisk	○	○	○	○	○

○ :Operation tested

– :Operation not tested

As of September 2009

For the PCM recorder, the operational tests performed were using microSD/microSDHC cards available as of September 2009.

In this manual, M2™ and microSD memory cards are generally referred to as a “memory card.”

The M2™/microSD card slot is referred to as the “memory card slot.”

Due to the file system specifications of the PCM recorder, you can record and play back an LPCM file smaller than 2 GB, and an MP3, AAC-LC, or WMA file smaller than 1 GB using a memory card.

The maximum number of tracks you can record on a memory card is 5,000.

### Note

Operations of all types of compatible memory cards are not guaranteed.

## Inserting a memory card

Before recording, be sure to copy all the data saved on the memory card to your computer and format the memory card on the PCM recorder so it contains no data.

- 1 Open the cover of the memory card slot in the stop mode.
- 2 Insert an M2™ or microSD card, in the direction shown in the illustration on page 36, securely to the end of the slot until it clicks into place. Then close the cover.

## To remove a memory card

Be sure that the ACCESS indicator is off, and then push the memory card into the slot. When it pops out, remove it from the memory card slot.

## On folder and track file structure

Ten folders are created in a memory card in addition to those in the built-in memory. The structure of folders and track files is somewhat different from that of the built-in memory (page 85).

### Notes

- Do not insert or remove a memory card during recording/playback. Doing so may cause a malfunction of the PCM recorder.
- Do not remove a memory card while “Accessing...” appears on the display window or the ACCESS indicator flashes in orange. Doing so may damage the data.
- If a memory card is not recognized, remove it and then insert it into the PCM recorder again.
- Close the cover of the memory card slot firmly. Also, do not insert any liquid, metal, flammable or any object other than a memory card into the slot. Doing so may cause fire, electric shock, or malfunctions.

## Using a memory card for recording and playback (Memory setting)

- 1 Press MENU to enter the menu mode.

The menu mode window will be displayed.

- 2 Press ►►► FF/▲ or ◀◀◀ FR/▼ to select “Memory,” and then press ► PLAY/ENTER.

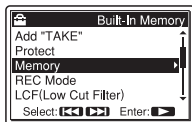

- 3 Press ►►► FF/▲ or ◀◀◀ FR/▼ to select “Memory Card,” and then press ► PLAY/ENTER.

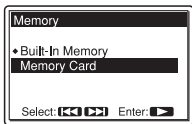

- 4 Press ■ STOP to exit the menu mode.

## To use the built-in memory

Select “Built-In Memory” in step 3.

## To start recording

Select the folder and press **● REC** to enter recording standby mode. Then press **■ PAUSE** or **▶ PLAY/ENTER** to start recording.

For automatic recording, see “Recording” on page 22. For manual recording, see “Manual recording” on page 33.

## Recording across memory media – Cross-Memory Recording

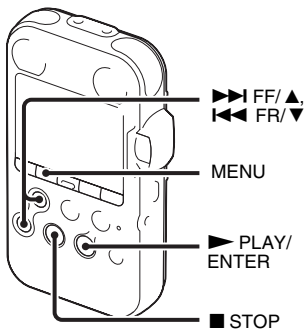

When the memory currently being used becomes full during recording, the PCM

recorder automatically switches its destination to the other memory media and continues recording (Cross-Memory Recording).

**1** Press **MENU** to enter the menu mode.  
The menu mode window will be displayed.

**2** Press **▶▶▶ FF/▲** or **◀◀◀ FR/▼** to select “Detail Menu,” and then press **▶ PLAY/ENTER**.

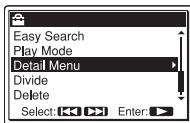

**3** Press **▶▶▶ FF/▲** or **◀◀◀ FR/▼** to select “Cross-Memory Recording,” and then press **▶ PLAY/ENTER**.



- 4 Press ►► FF/ ▲ or ◀◀ FR/ ▼ to select “ON,” and then press ► PLAY/ ENTER.



- 5 Press ■ STOP to exit the menu mode.

### To cancel Cross-Memory Recording

Select “OFF” in step 4.

### When the current memory media becomes full during recording

The following message appears on the display window. Recording continues as a new track in a recordable folder of the smallest folder number available for the other memory media.

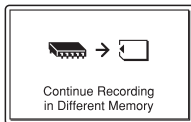

A new track is created with a new file name.

When the recording stops, the PCM recorder stops at the beginning of the new track.

### ■ Notes

- If the other memory media is also full, a message is displayed and the PCM recorder stops recording.
- When you play back the original track recorded with Cross-Memory Recording, the PCM recorder does not play the succeeding track automatically.
- Before attempting Cross-Memory Recording, check to see if the memory card is detected in the “Memory” menu in advance (page 38).



# Changing the Recording Settings

## Selecting the recording mode

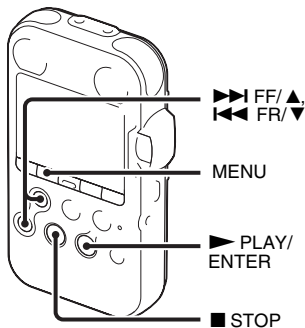

You can select the recording mode in the menu when the PCM recorder is in the stop mode.

### About the recording modes

The PCM recorder is compatible with 2 types of recording modes: LPCM (Linear PCM) and MP3. The features offered by each are as follows.

- **LPCM (Linear PCM):** This is a WAV file and you can record the sound without compression, providing higher quality than MP3. On the other hand, the file size is large, it takes time to copy to a computer, and the available recording time in the PCM recorder is shorter than MP3. We recommend this recording mode for recording when the sound quality is important.
- **MP3:** A standard method of sound compression, which can be played back using many different kinds of computers.

- 1 Press **MENU** to enter the menu mode. The menu mode window will be displayed.
- 2 Press **▶▶ FF/▲** or **◀◀ FR/▼** to select “REC Mode,” and then press **▶ PLAY/ENTER**.

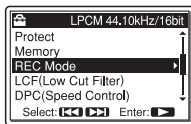

- 3 Press ►►► FF/ ▲ or ◀◀◀ FR/ ▼ to select the desired recording mode, and then press ► PLAY/ENTER.

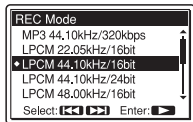

LPCM 22.05kHz/16bit  
LPCM 44.10kHz/16bit\*  
LPCM 44.10kHz/24bit  
LPCM 48.00kHz/16bit  
LPCM 48.00kHz/24bit  
LPCM 96.00kHz/16bit  
LPCM 96.00kHz/24bit

LPCM (Not compressed mode)

You can record with higher sound quality.

MP3 44.10kHz/64kbps\*\*  
MP3 44.10kHz/128kbps  
MP3 44.10kHz/320kbps

MP3 (compressed mode)

You can record with higher sound quality.

\* default setting

\*\* for a long-time recording

- 4 Press ■ STOP to exit the menu mode.

#### ■ Note

You cannot set the recording mode while recording.

#### 💡 About the sampling frequency and quantifying bit number

- Sampling frequency is a value that represents how many times an analog signal is converted into a digital signal (A/D conversion) per second. The larger the value of sampling frequency, the better the sound quality, but also the larger the amount of data.
- Quantifying bit number is a value that represents the amount of data it takes for 1 second of audio. The larger the value of the bit number, the larger the amount of data it takes and the better the sound quality.

## Setting the microphone sensitivity

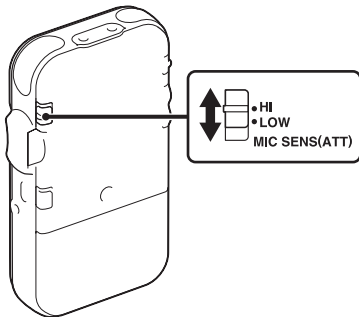

You can set the sensitivity of the built-in microphones and an external microphone connected to the  (microphone) jack of the PCM recorder. Switch the MIC SENS(ATT) switch according to the recording conditions or to suit your purposes, when the PCM recorder is either stopped or is recording.

HI (high)*	Usually select this position. <ul style="list-style-type: none"> <li>• The microphone attenuator is set to "HI." (In manual recording)</li> <li>• The microphone sensitivity is set to high. (In automatic recording)</li> </ul>
LOW	Select this position to record a sudden loud sound. <ul style="list-style-type: none"> <li>• The microphone attenuator is set to "LOW." (In manual recording)</li> <li>• The microphone sensitivity is set to low. (In automatic recording)</li> </ul>

\* The microphone sensitivity is set to "HI" when you purchase the PCM recorder.

## Cutting out low frequency – the LCF function

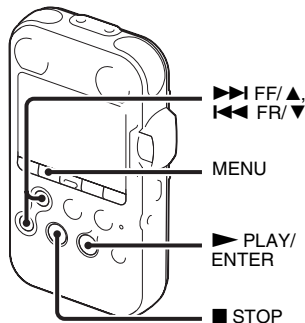

When you set the LCF(Low Cut Filter) function to "ON" in the stop or recording mode, you cut out a low frequency to reduce the air conditioner noise, roaring noise from wind, etc.; therefore you can record a track more clearly.

- 1 Press MENU to enter the menu mode. The menu mode window will be displayed.

- 2 Press ►► FF/ ▲ or ◀◀ FR/ ▼ to select “LCF(Low Cut Filter),” and then press ► PLAY/ENTER.

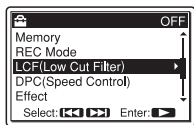

- 3 Press ►► FF/ ▲ or ◀◀ FR/ ▼ to select “ON,” and then press ► PLAY/ENTER.

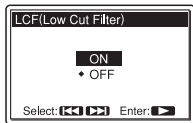

The LCF function is set to “OFF” when you purchase the PCM recorder.

- 4 Press ■ STOP to exit the menu mode.

### To cancel the LCF function

Set “LCF(Low Cut Filter)” to “OFF” in step 3.

## Preventing sound distortion—the LIMITER function

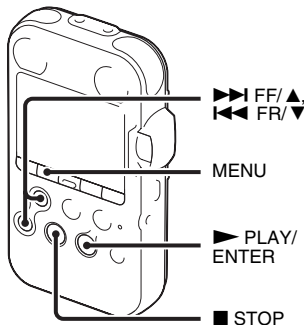

During the stop or recording mode, you can set the LIMITER function.

When the “LIMITER” is set to “ON,” the input sound that is too loud is adjusted automatically to the maximum input level to prevent sound distortion.

- 1 Press MENU to enter the menu mode.  
The menu mode window will be displayed.

- 2 Press **▶▶▶ FF/▲** or **◀◀◀ FR/▼** to select “Detail Menu,” and then press **▶ PLAY/ENTER**.

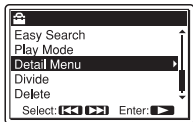

- 3 Press **▶▶▶ FF/▲** or **◀◀◀ FR/▼** to select “LIMITER,” and then press **▶ PLAY/ENTER**.

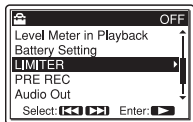

- 4 Press **▶▶▶ FF/▲** or **◀◀◀ FR/▼** to select “ON,” and then press **▶ PLAY/ENTER**.

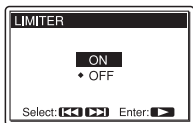

The LIMITER function is set to “OFF” when you purchase the PCM recorder.

- 5 Press **■ STOP** to exit the menu mode.

## To cancel the LIMITER function

Set “LIMITER” to “OFF” in step 4.

### ■ Notes

- When the REC LEVEL switch is set to “AUTO,” the LIMITER function does not work.
- When the “LIMITER” is set to “ON,” the limiter function of the PCM recorder covers the input from the maximum input level to +12 dB. If the input exceeds this limit, sounds may be distorted.

# Recording via Other Devices

## Recording with an external microphone

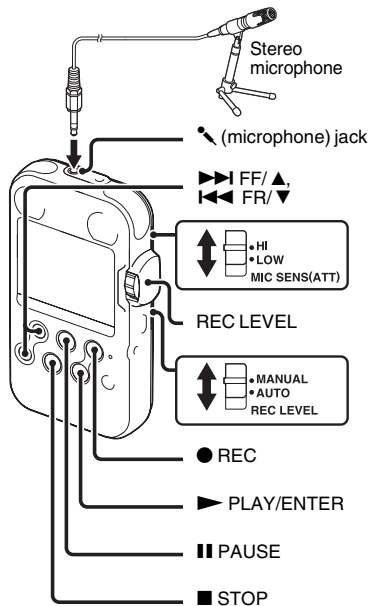

You can record from an external microphone. When an external microphone is connected, the built-in microphones and the input from the LINE IN jack become disabled.

- 1 Connect an external microphone to the (microphone) jack when the PCM recorder is in the stop mode.

“Plug In Power” appears in the display window.

If “Plug In Power” is not displayed, set it in the menu (page 82).

- 2 Press **▶▶▶ FF/▲** or **◀◀◀ FR/▼** to select “ON,” and then press **▶ PLAY/ENTER**.

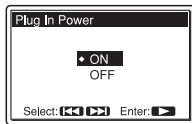

When a plug in power type microphone is connected, power is automatically supplied to the microphone from the PCM recorder.

- 3 Press **■** STOP to exit the menu mode.
- 4 Set the REC LEVEL switch to “AUTO” for automatic recording, or “MANUAL” for manual recording.

- 5 Press **●** REC.

The PCM recorder enters the recording standby mode. The built-in microphones and input from the LINE IN are automatically cut off.

You can adjust the microphone sensitivity with the MIC SENS(ATT) switch (page 42).

- 6 To start recording, press **||** PAUSE or **▶** PLAY/ENTER.
- 7 When “MANUAL” has been selected in step 4, adjust the recording level with the REC LEVEL dial.
- 8 To stop recording, press **■** STOP.

### **💡 Recommended microphones (not supplied)**

We recommend you use the Sony ECM-MS957 electret condenser microphone.

## Recording from other equipment

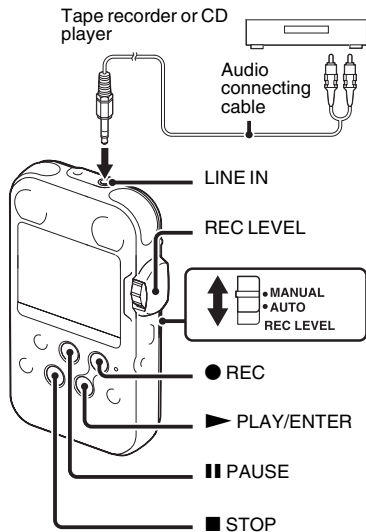

You can make music files without using the computer by recording the sound from other equipment connected to the PCM recorder. When an external equipment is



connected, the built-in microphones become disabled.

- 1** Connect an external equipment to the PCM recorder in the stop mode.  
Connect the audio output jacks (stereo minijack) of external equipment to the LINE IN jack of the PCM recorder using a Sony audio connecting cable (not supplied).
- 2** Set the REC LEVEL switch to “AUTO” for automatic recording, or “MANUAL” for manual recording.
- 3** Press ● REC.  
The PCM recorder enters the recording standby mode.
- 4** Start playback with the connected external equipment.
- 5** To start recording, press ■ PAUSE or ► PLAY/ENTER.
- 6** When “MANUAL” has been selected in step 2, adjust the recording level with the REC LEVEL dial.
- 7** To stop recording, press ■ STOP.

### **Recommended audio connecting cable (not supplied)**

We recommend you use Sony RK-G129 audio connecting cable (not supplied).

#### **Note**

When both  (microphone) jack and LINE IN jack are connected with an external microphone and an external device respectively, the input from the  (microphone) jack has the priority. When using the input from the LINE IN jack, remove an external microphone from the  (microphone) jack.



# Changing the Playback Method

## Changing the display during playback

You can change the display during playback between the file information display and the level meter display.

- File information display

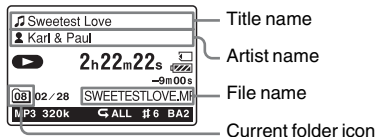

A track recorded using the PCM recorder is displayed as follows.

: Track title name: Date  
(yymmdd)\_file number (e.g.  
090101\_01)

: Artist name (e.g. My Recording)

File Name: Date (yymmdd)\_file number  
\_file extension (e.g.  
090101\_01.wav)

: Current folder name: 01 (FOLDER  
01) to 10 (FOLDER 10)

You can change the folder name, title,  
artist name, and/or file name using your  
computer.

- Level meter display  
You can play back a track while checking the recorded levels.

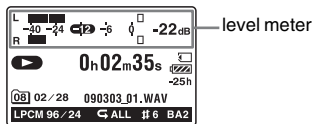

## Selecting the level meter display

- 1 Press MENU to enter the menu mode.  
The menu mode window will be displayed.
- 2 Press FF/ or FR/ to select “Detail Menu,” and then press PLAY/ENTER.

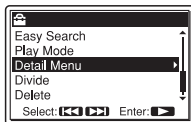

- 3 Press ►►► FF/ ▲ or ◀◀◀ FR/ ▼ to select “Level Meter in Playback,” and then press ► PLAY/ENTER.

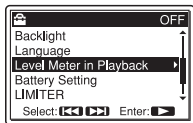

- 4 Press ►►► FF/ ▲ or ◀◀◀ FR/ ▼ to select “ON,” and then press ► PLAY/ENTER.

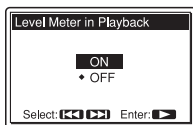

The Level Meter in Playback function is set to “OFF” when you purchase the PCM recorder.

- 5 Press ■ STOP to exit the menu mode.

## To display file information

Set “Level Meter in Playback” to “OFF in step 3.

## Listening the playback sounds with the headphones or external speakers

- To listen with the headphones:  
Connect stereo headphones (not supplied) to the ◌/LINE OUT (headphone/line output) jack. The built-in speaker will be automatically disconnected. Adjust the volume with the VOLUME +/- buttons.
- To listen from an external speaker:  
Connect the speaker cord of the carrying case speaker CKS-M10 (not supplied) to the ◌/LINE OUT (headphone/line output) jack of the PCM recorder. Adjust the volume with the VOLUME +/- buttons.  
Or use a Sony audio connecting cable (not supplied) to connect the microphone or line input jack of an external active or passive speaker (not supplied) with the ◌/LINE OUT (headphone/line output) jack of the PCM recorder.

### ■ Notes

- Set “Audio Out” in the menu to “Headphones” to use the ◌/LINE OUT (headphone/line output) jack as a headphone.

- When “Audio Out” in the menu is set to “LINE OUT,” do not connect headphones; the playback sound from the headphones will be very loud.

## Quickly locating the point you wish to start playback – Easy Search

When “Easy Search” is set to “ON” in the menu, you can quickly locate the point at which you wish to start playback by pressing ►► FF/▲ or ◀◀ FR/▼ repeatedly during playback (page 77). You can go back approx. 3 seconds by pressing ◀◀ FR/▼ once, or advance approx. 10 seconds by pressing ►► FF/▲ once. This function is useful for locating a desired point in a long recording, such as in a recording of musical instruments.

### 💡 When tracks are played back to the end of the last track

- When you play back or fast play back to the end of the last track, “TRACK END” lights up for approx. 5 seconds.
- When “TRACK END” goes off, the PCM recorder will stop at the beginning of the last track.
- If you press and hold ◀◀ FR/▼ while “TRACK END” is lit, the tracks are played

back rapidly, and normal playback will start at the point you release the button.

- If the last track is long and you wish to start playback at a later part of the track, press and hold ►► FF/▲ to go to the end of the track, and then press ◀◀ FR/▼ while “TRACK END” is lit to go back to the desired point.
- For tracks other than the last one, go to the beginning of the next track and play backward to the desired point.

## Selecting the playback mode

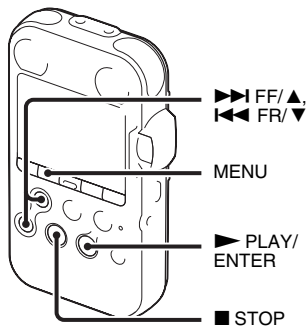

You can select the playback mode in the menu.

- 1** Press MENU to enter the menu mode when the PCM recorder is in the stop or playback mode.

The menu mode window will be displayed.

- 2** Press ►►► FF/▲ or ◀◀◀ FR/▼ to select “Play Mode,” and then press ► PLAY/ENTER.

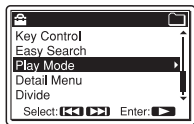

- 3** Press ►►► FF/▲ or ◀◀◀ FR/▼ to select “1,” “📁,” “ALL,” “↶ 1,” “↶ 📁,” or “↶ ALL,” and then press ► PLAY/ENTER.

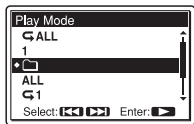

---

**1** A track is played back.

**📁** Tracks in one folder are played back continuously.

---

---

**ALL** All the tracks are played back continuously.

---

**↶ 1** One track is played back repeatedly.

---

**↶ 📁** Tracks in one folder are played back repeatedly.

---

**↶ ALL** All the tracks are played back repeatedly.

---

- 4** Press ■ STOP to exit the menu mode.

## Playing back repeatedly

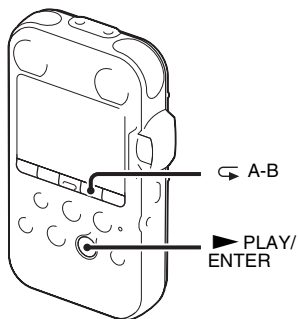

## Playing back a track repeatedly

During playback, press and hold ► PLAY/ENTER until “↺ 1” appears. The selected track will be played back repeatedly.

To resume normal playback, press ► PLAY/ENTER again.

- To change the segment specified for A-B Repeat playback:

During A-B Repeat playback, press ↺ (repeat) A-B again to specify a new starting point A. Then specify a new finishing point B, as in step 2.

## Playing back a specified section repeatedly – A-B Repeat

- 1 During playback, press ↺ (repeat) A-B to specify the starting point A.

“A-B B?” is displayed.

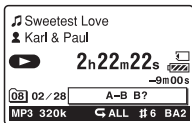

- 2 Press ↺ (repeat) A-B again to specify the finishing point B.

“↺ A-B” is displayed and the specified section is played back repeatedly.

## Other operations

- To resume normal playback:  
Press ► PLAY/ENTER.
- To stop A-B Repeat playback:  
Press ■ STOP.

# Changing the Playback Sounds

## Adjusting the playback speed – the DPC function

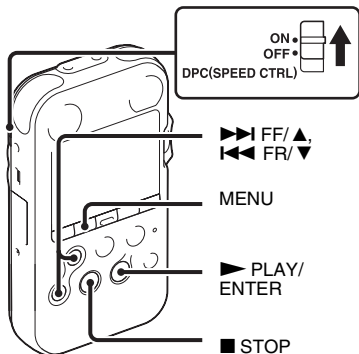

When you slide the DPC (SPEED CTRL) (Digital Pitch Speed Control) switch to “ON,” you can adjust the playback speed between +100% and -75% of normal speed in the menu.

The track is played back in natural tones thanks to the digital processing function.

- 1 Slide the DPC (SPEED CTRL) switch to “ON.”
- 2 Press MENU to enter the menu mode. The menu mode window will be displayed.
- 3 Press ►►► FF/ ▲ or ◀◀◀ FR/ ▼ to select “DPC(Speed Control),” and then press ► PLAY/ENTER.

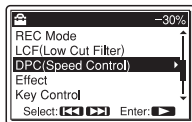

- 4 Press ►►► FF/ ▲ or ◀◀◀ FR/ ▼ to adjust the playback speed. Press ►►► FF/ ▲ to increase the speed, or ◀◀◀ FR/ ▼ to make it slower. Every time the button is pressed, you can decrease the speed by 5% for - from -75% to 0%, and increase the speed by 10% for + between 0% and 100%.

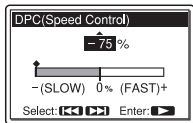

- 5 Press ► PLAY/ENTER to execute the playback speed.
- 6 Press ■ STOP to exit the menu mode.
- 7 Press ► PLAY/ENTER to start playback.  
Tracks are played back at the selected playback speed.

### To resume normal playback

Slide the DPC (SPEED CTRL) switch to "OFF."

## Adjusting the playback tones – Key Control

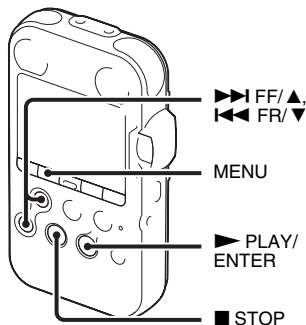

You can adjust the playback sounds in semitones higher or lower, each in 6 step (Key Control), whichever is best suited for practicing songs to the recorded accompaniment.

- 1 Press MENU to enter the menu mode.  
The menu mode window will be displayed.
- 2 Press ►► FF/ ▲ or ◀◀ FR/ ▼ to select "Key Control," and then press ► PLAY/ENTER.

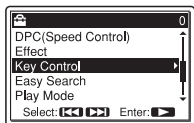

- 3** Press ►► FF/▲ or ◀◀ FR/▼ to adjust the playback tone.

Press ►► FF/▲ to adjust the sounds by a half-tone higher (#1 to #6), or ◀◀ FR/▼ to adjust it by a half-tone lower (♭1 to ♭6), each in 6 steps.

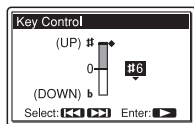

- 4** Press ► PLAY/ENTER to set the playback tone.
- 5** Press ■ STOP to exit the menu mode.
- 6** Press ► PLAY/ENTER to start playback.

Tracks are played back at the selected tone. The setting (#1 to #6, ♭1 to ♭6) is displayed on the display window.

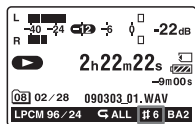

Key control setting

## To resume normal playback sounds

Select "0" in step 3.

## Reinforcing the bass sound – Effect

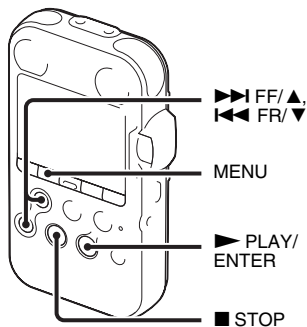

You can set the bass sound you want for the playback in the menu.



- 1** Press **MENU** to enter the menu mode when the PCM recorder is in the stop or playback mode.

The menu mode window will be displayed.

- 2** Press **▶▶▶ FF/▲** or **◀◀◀ FR/▼** to select “Effect,” and then press **▶▶ PLAY/ENTER**.

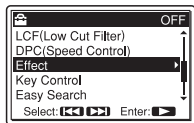

- 3** Press **▶▶▶ FF/▲** or **◀◀◀ FR/▼** to select effect you want for the playback, and then press **▶▶ PLAY/ENTER**.

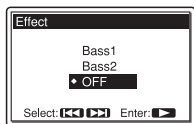

---

**Bass1** Emphasizes the bass sound.

---

**Bass2** Emphasizes the bass sound even more.

---

**OFF** The Effect function does not work.

---

- 4** Press **■ STOP** to exit the menu mode.

- 5** Press **▶▶ PLAY/ENTER** to start playback.

Tracks are played back with the selected effect.

#### ■ Notes

- When you play back using the built-in speaker, this setting does not work.
- When “LINE OUT” is selected in “Audio Out” in the menu, the Effect function does not work.

# Playback via Other Devices

## Recording with other equipment

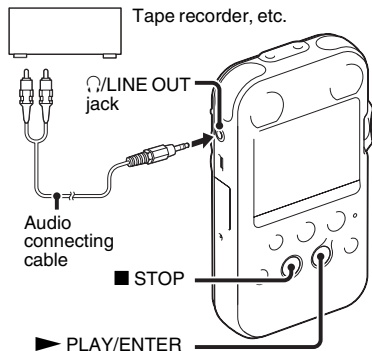

You can record the sound of the PCM recorder with other equipment.

Before you start recording, we recommend you to make a trial recording first.

- 1 Connect the /LINE OUT (headphone/line output) jack of the PCM recorder to

the audio input connector (stereo minijack) of other equipment using an audio connecting cable.

- 2 Press MENU to enter the menu mode in the stop mode.

The menu mode window will be displayed.

- 3 Press FF/ or FR/ to select "Detail Menu," and then press PLAY/ENTER.

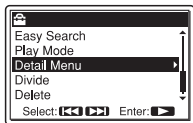

- 4 Press FF/ or FR/ to select "Audio Out," and then press PLAY/ENTER.



- 5 Press ►► FF/ ▲ or ◀◀ FR/ ▼ to select “LINE OUT,” and then press ► PLAY/ENTER.



“Headphones” is selected when you purchase the PCM recorder.

- 6 Press ■ STOP to exit the menu mode.

- 7 Press ► PLAY/ENTER to start playback and at the same time set the connected equipment to the recording mode.

A track from the PCM recorder will be recorded on the equipment connected.

- 8 Press ■ STOP on the PCM recorder and the connected equipment at the same time to stop recording.

### 💡 Recommended audio connecting cable (not supplied)

You can use Sony audio connecting cables RK-G129 (not supplied).

### 📌 Notes

- To listen playback with the headphones, set “Audio Out” to “Headphones” (page 50).
- If input from an external equipment is distorted, select “Headphones” in step 5 and adjust the volume with VOLUME +/- buttons.
- When “LINE OUT” is selected, the Effect function does not work.
- While the “LINE OUT” is selected, you cannot adjust the output volume with the VOLUME +/- buttons.

# Adding a Mark to a Track

## Using a track mark

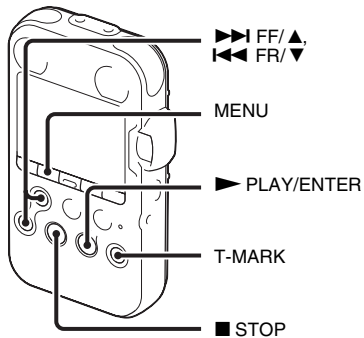

## Adding a track mark

You can add a track mark at a point at which you would like to divide a track later or locate during playback.

You can add a maximum of 98 track marks to each track.

During recording, playback, or pausing, press the T-MARK button at the position you want to add a track mark.

The  (track mark) icon flashes three times, and a track mark is added.

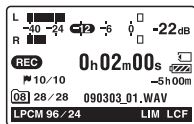

## Using the remote commander

When the supplied remote commander is connected, you can also press T-MARK button on the remote commander to add a track mark.

## Notes

- You can add a track mark only to a track recorded using the PCM recorder. You cannot add a track mark to an MP3/WMA/AAC-LC (m4a)/LPCM (WAV) file copied from a computer.
- You cannot add a track mark at a point within 0.5 seconds from another track mark.
- You cannot add a track mark at the very beginning or at the very end of the track.
- If there are already 98 track marks in a track, you cannot add any more track marks.
- When a track mark is added during playback, the playback stops.

## Locating a track mark and starting playback at the track mark

In the stop mode, press ►►► FF/▲ or ◀◀◀ FR/▼. When the 📌 (track mark) icon flashes once, press ► PLAY/ENTER

## Dividing a track at all the track mark positions

Select “Divide All T-MARK(Track Marks)” from the Divide menu.

## Deleting a track mark

- 1 Stop at a position after the track mark you would like to delete.
- 2 Press MENU to enter the menu mode. The menu mode window will be displayed.
- 3 Press ►►► FF/▲ or ◀◀◀ FR/▼ to select “Delete,” and then press ► PLAY/ENTER. The Delete menu is displayed.

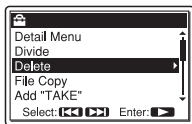

- 4 Press ►►► FF/▲ or ◀◀◀ FR/▼ to select “Delete T-MARK(Track Mark),” and then press ► PLAY/ENTER.

The message “Delete T-MARK(Track Mark)?” is displayed.



- 5 Press ►►► FF/▲ or ◀◀◀ FR/▼ to select “Execute,” and then press ► PLAY/ENTER.

A deletion animation and the message “Deleting...” appear. The selected track mark will be deleted.



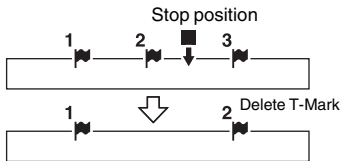

The track mark just before the stop position will be deleted.

**6** Press ■ STOP to exit the menu mode.

### Deleting all the track marks in the selected track at one time

Select a track from which you would like to delete the track marks, and then select “Delete All T-MARK(Track Marks)” in step 4. All the track marks will be deleted at one time.

## Adding a “TAKE” or “KEEP” to a file name

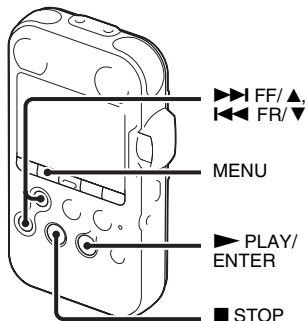

You can add a “TAKE” or “KEEP” to a file name of a track, so that you can narrow down your selections to only marked files. This feature is useful when you want to select one from many recordings, by adding a “TAKE” to the ones most likely to be selected, or adding a “KEEP” to the ones that you would like to save just for possible selection.

**1** Display the track from which you would like to add a “TAKE” or “KEEP” to the file name.

- 2** Press **MENU** to enter the menu mode.  
The menu mode window will be displayed.

- 3** Press **▶▶▶ FF/▲** or **◀◀◀ FR/▼** to select “Add “TAKE”,” and then press **▶ PLAY/ENTER**.

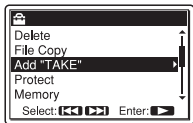

- 4** Press **▶▶▶ FF/▲** or **◀◀◀ FR/▼** to select “Add “TAKE”,” or “Add “KEEP”,” and then press **▶ PLAY/ENTER**.  
A confirmation message is displayed.

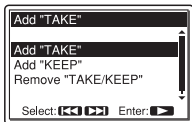

- 5** Press **▶▶▶ FF/▲** or **◀◀◀ FR/▼** to select “Execute,” and then press **▶ PLAY/ENTER**.

A suffix (“TAKE” or “KEEP”) is added to the file name of the track.

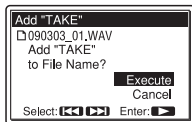



- 6** Press **■ STOP** to exit the menu mode.

## Removing “TAKE” or “KEEP” from the file name of a track

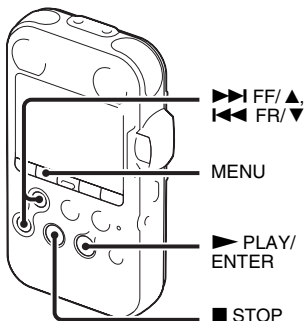

Select “Remove “TAKE/KEEP”” in step 4.

## Protecting a track







To prevent a track from being accidentally deleted or edited, you can protect an important track. A protected track is marked with the  (protect) indicator and is regarded as a read-only file you cannot delete or edit.

- 1 Display the track which you would like to protect.
- 2 Press MENU to enter the menu mode. The menu mode window will be displayed.

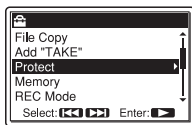
- 3 Press  FF/▲ or  FR/▼ to select “Protect,” and then press  PLAY/ENTER.

A confirmation message is displayed.



- 4 Press  FF/▲ or  FR/▼ to select “Execute,” and then press  PLAY/ENTER.

The track is protected and added with a  (protect) indicator.

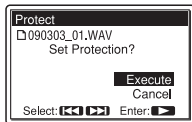

- 5 Press  STOP to exit the menu mode.

### To release protection

Select the protected file, and then proceed with the steps 1 through 5. The protection is released.



# Arranging Tracks

## Copying a track to the other memory

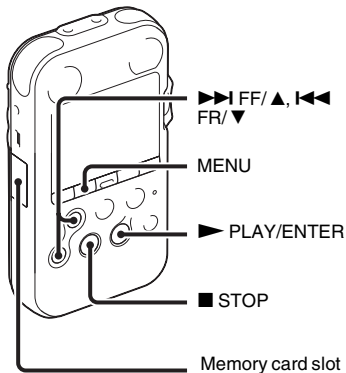

You can copy tracks between the built-in memory and a memory card, which is useful in saving a backup. Before starting the operation, insert a memory card to be used for copying into the memory card slot.

### ■ Notes

- You cannot copy a track that the PCM recorder does not recognize.
- Before starting to copy the target track, make sure to check the battery remain indication. If the batteries are weak, you may not be able to copy tracks (page 14).
- If the remaining memory capacity of the destination memory is insufficient, you may not be able to copy tracks.

- 1 Select the track you want to copy.  
When you want to copy a track from a memory card to the built-in memory, set the “Memory” in the menu to “Memory Card” (page 38).
- 2 Press MENU to enter the menu mode.  
The menu mode window will be displayed.
- 3 Press **▶▶ FF/▲** or **◀◀ FR/▼** to select “File Copy,” and then press **▶ PLAY/ENTER**.  
The message “Copy to Memory Card Select Folder” or “Copy to Built-In

Memory Select Folder” is displayed and the folder selection window is displayed.

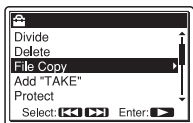

- 4 Press ►► FF/▲ or ◀◀ FR/▼ to select the folder that you want to copy the track into, and then press ► PLAY/ENTER. “Copying...” is displayed and the track is copied to the end in the destination folder.

A file will be copied with the identical file name. The artist name and other settings will also be retained.

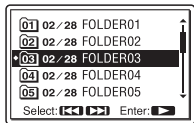

- 5 Press ■ STOP to exit the menu mode.

## To cancel the copy operation

Press ■ STOP before step 4.

## Note

Do not remove or insert a memory card, or turn off the PCM recorder while copying. Files may be damaged.

## Dividing a track into two

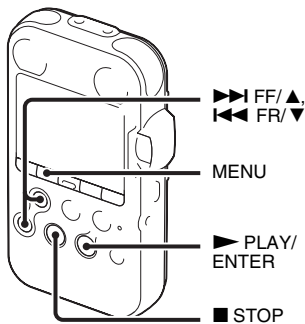

You can divide a track during playback, so that the track is divided into two parts, and the respective tracks are suffixed with “\_1” and “\_2.” You can also divide a track at each and every track mark.

By dividing a track, you can easily find the point from which you want to start playback when you make a long recording.

You can divide a track until the total number of tracks in the folder reaches 99.

## Dividing a track at the current position

- 1 Stop the track at the position where you want to divide a track.
- 2 Press MENU to enter the menu mode.  
The menu mode window will be displayed.
- 3 Press ►►► FF/▲ or ◀◀◀ FR/▼ to select “Divide,” and then press ► PLAY/ENTER.  
The Divide menu is displayed.

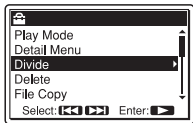

- 4 Press ►►► FF/▲ or ◀◀◀ FR/▼ to select “Divide Current Position,” and then press ► PLAY/ENTER.

A period for approximately 4 seconds from the dividing point will be played back repeatedly.



- 5 Adjust the position to be divided, if you wish.  
Press ►►► FF/▲ to move the position backward, or ◀◀◀ FR/▼ to move it forward.

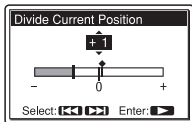

You can adjust the position to be divided by approximately 0.3 seconds in a period approximately 6 seconds each, both before and after the current position.

- 6 Press ► PLAY/ENTER to execute the position to be divided.  
“Divide?” is displayed.

7 Press ►►► FF/▲ or ◀◀◀ FR/▼ to select “Execute,” and then press ► PLAY/ENTER.

“Dividing...” appears, and the divided tracks will be suffixed with a sequential number (“\_1” for the original track, and “\_2” for the new track).”

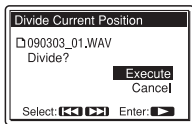

track 1	track 2		track 3
	A track is divided.		
track 1	track 2_1	track 2_2	track 3

A suffix made up of a sequential number is added to each of the divided files.

8 Press ■ STOP to exit the menu mode.

### Notes

- You need a certain amount of free space in the memory to divide a track. For details, see “System Limitations” on page 112.
- When you divide a track with a title and artist name, the new track has the same title, and artist name.

- You can divide a track recorded using the PCM recorder only. An MP3/WMA/AAC-LC (m4a)/LPCM (WAV) file copied from a computer cannot be divided.
- Once a track is divided, you cannot return it to the original status again.
- If you divide a track at the position within 0.5 seconds from a track mark, the track mark will be deleted.
- Because of the system limitations, you cannot divide a track at the very beginning or end of the track.

## Dividing a track at all the track mark positions

1 Perform steps 1 to 3 of “Dividing a track at the current position” on page 67 to display the Divide menu.

2 Press ►►► FF/▲ or ◀◀◀ FR/▼ to select “Divide All T-MARK(Track Marks),” and then press ► PLAY/ENTER. “Divide All T-MARK(Track Marks)?” is displayed.



**3** Press ►►► FF/▲ or ◀◀◀ FR/▼ to select “Execute,” and then press ► PLAY/ENTER.

“Dividing...” appears, and the track is divided at all the track mark positions. The tracks divided from a single track will be suffixed with a sequential number (\_1 and so on).

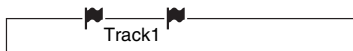
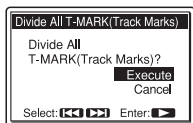

A track is divided. ↓

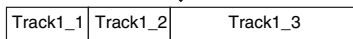

A suffix made up of a sequential number is added each of the divided files.

**4** Press ■ STOP to exit the menu mode.

### To play a divided track

Press ►►► FF/▲ or ◀◀◀ FR/▼ to display the track number, as the divided tracks now each have different track numbers.

### 💡 Tip

To cancel division during the operation at all the remaining track marks, press ■ STOP. The tracks that have been divided before the cancellation remain divided.

## Deleting all tracks in a folder

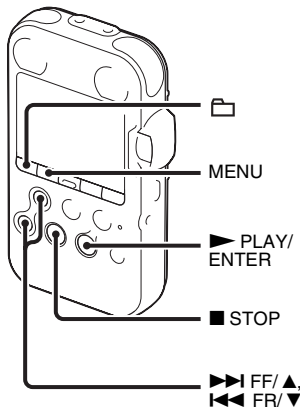

### ■ Note

If the selected folder contains a protected track, you cannot delete the track.

- 1 Select the folder containing the tracks you want to delete when the PCM recorder is in the stop mode.
- 2 Press MENU to enter the menu mode. The menu mode window will be displayed.
- 3 Press ►►► FF/ ▲ or ◀◀◀ FR/ ▼ to select “Delete,” and then press ► PLAY/ ENTER.  
The Delete menu is displayed.

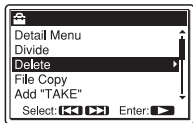

- 4 Press ►►► FF/ ▲ or ◀◀◀ FR/ ▼ to select “Delete All,” and then press ► PLAY/ ENTER.  
A confirmation message is displayed.



- 5 Press ►►► FF/ ▲ or ◀◀◀ FR/ ▼ to select “Execute,” and then press ► PLAY/ ENTER.  
“Deleting...” appears in the display window and all tracks in the selected folder will be deleted.

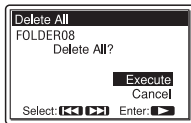

- 6 Press ■ STOP to exit the menu mode.

## To cancel deleting

Select “Cancel” in step 5, and then press ► PLAY/ENTER.

# Making Settings for the Menu

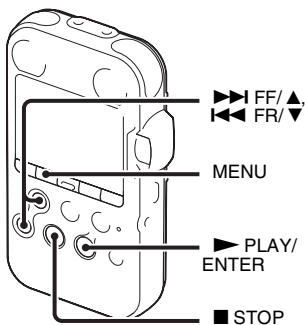

- 1 Press MENU to enter the menu mode.  
The menu mode window will be displayed.

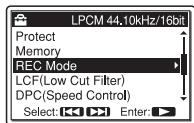

- 2 Press ►►► FF/ ▲ or ◀◀◀ FR/ ▼ to select the menu item for which you want to make setting, and then press ► PLAY/ ENTER.

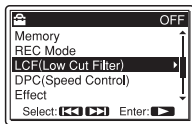

- 3 Press ►►► FF/ ▲ or ◀◀◀ FR/ ▼ to select the setting that you want to set, and then press ► PLAY/ ENTER.

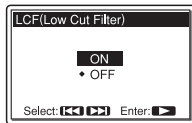

- 4 Press ■ STOP or MENU to exit the menu mode.

### Note

If you do not press any button for 1 minute, the menu mode is automatically cancelled and the window will return to the normal display.

### To return to the previous window

Press MENU during the menu mode.





### To exit the menu mode

Press ■ STOP.

# Menu settings

Menu items	Settings	Operation mode (○ : the setting can be made/ — : the setting cannot be made)		
		Stop mode	Playback mode	Recording mode
Divide		○	—	—
Divide Current Position	Execute, Cancel	○	—	—
Divide All T-MARK(Track Marks)	Execute, Cancel	○	—	—
Delete		○	—	—
Delete All	Execute, Cancel	○	—	—
Delete T-MARK(Track Mark)	Execute, Cancel	○	—	—
Delete All T-MARK(Track Marks)	Execute, Cancel	○	—	—
File Copy	Execute, Cancel	○	—	—
Add "TAKE"	Add "TAKE", Add "KEEP", Remove "TAKE/KEEP"	○	—	—
Protect	Execute, Cancel	○	—	—
Memory	Built-In Memory, Memory Card	○	—	—
REC Mode	LPCM 22.05kHz/16bit, LPCM 44.10kHz/16bit, LPCM 44.10kHz/24bit, LPCM 48.00kHz/16bit, LPCM 48.00kHz/24bit, LPCM 96.00kHz/16bit, LPCM 96.00kHz/24bit, MP3 44.10kHz/64kbps, MP3 44.10kHz/128kbps, MP3 44.10kHz/320kbps	○	—	—
LCF(Low Cut Filter)	ON, OFF	○	—	○
DPC(Speed Control)	-75 % to +100%	○	○	—





Menu items	Settings	Operation mode (○ : the setting can be made/ — : the setting cannot be made)		
		Stop mode	Playback mode	Recording mode
Effect	Bass1, Bass2, OFF	○	○	—
Key Control	<b>b</b> 1 to <b>b</b> 6, <b>#</b> 1 to <b>#</b> 6	○	○	—
Easy Search	ON, OFF	○	○	—
Play Mode	1,  , ALL,  1,   ,  ALL	○	○	—
Detail Menu		○	○	○
Format	Execute, Cancel	○	—	—
Clock	__y__m__d__:__	○	—	—
LED	ON, OFF	○	—	—
Backlight	10 SEC, 60 SEC, Always-ON, OFF	○	—	—
Language	English, Español (Spanish), Français (French)	○	—	—
Level Meter in Playback	ON, OFF	○	○	—
Battery Setting	Alkaline Battery, NiMH Battery	○	—	—
LIMITER	ON, OFF	○	—	○
PRE REC	ON, OFF	○	—	—
Audio Out	Headphones, LINE OUT	○	—	—
Plug In Power	ON, OFF	○	—	—
Cross-Memory Recording	ON, OFF	○	—	—

<b>Menu items</b>	<b>Settings (*: Initial setting)</b>	<b>See page</b>
<b>Divide</b>	Divide a track into two.	61, 66
Divide Current Position	A track will be divided into two at the current position.	
Divide All T-MARK(Track Marks)	A track will be divided at all the track mark positions.	
<b>Delete</b>	Delete tracks or track marks.	30, 61, 62, 69
Delete All	All tracks in the selected folder will be deleted. Press  to return to the folder window before deleting the tracks and select a folder from which all tracks are to be deleted, and then go to the menu window and select "Execute."	
Delete T-MARK(Track Mark)	The track mark just before the current position will be deleted.	
Delete All T-MARK(Track Marks)	All the track marks of the selected track will be deleted.	
<b>File Copy</b>	Copy the selected track from the built-in memory to the desired folder on a memory card, or from a memory card to the desired folder in the built-in memory. Before attempting to copy a track, select the track to be copied and then go to the menu window.	65
<b>Add "TAKE"</b>	Add "TAKE" or "KEEP" to the file name of the selected track. Add "TAKE"*: Add "TAKE" to the file name of the selected track. Add "KEEP": Add "KEEP" to the file name of the selected track. Remove "TAKE/KEEP": Remove "TAKE" or "KEEP" from the file name of the selected track.	62

Menu items	Settings (*: Initial setting)	See page
<b>Protect</b>	Protect the selected track to prevent the track from being deleted or divided. Execute: Protect the selected track. If you specify a track which has already been protected, cancel the protection. Cancel*: Protection or cancel protection is not executed.	64
<b>Memory</b>	Select the memory in which you want to save a track, or which contains the track you want to play, edit, or copy. Built-In Memory*: The built-in memory of the PCM recorder is selected. Memory Card: The memory card inserted in the memory card slot is selected.  <b>Note</b> When no memory card is currently inserted in the PCM recorder, the built-in memory is automatically selected.	36

Menu items	Settings (*: Initial setting)	See page
REC Mode	<p>Set the sampling frequency and quantifying bit number for recording:</p> <p>LPCM 22.05kHz/16bit  LPCM 44.10kHz/16bit*  LPCM 44.10kHz/24bit  LPCM 48.00kHz/16bit  LPCM 48.00kHz/24bit  LPCM 96.00kHz/16bit  LPCM 96.00kHz/24bit</p> <p>MP3 44.10kHz/64kbps  (for a long-time recording)  MP3 44.10kHz/128kbps  MP3 44.10kHz/320kbps</p> <p> <b>About the sampling frequency and quantifying bit number</b></p> <ul style="list-style-type: none"> <li>• Sampling frequency is a value that represents how many times an analog signal is converted into a digital signal (A/D conversion) per second. The larger the value of sampling frequency, the better the sound quality, but also the larger the amount of data.</li> <li>• Quantifying bit number is a value that represents the amount of data it takes for one second of audio. The larger the value of the bit number, the larger amount of data it takes and the better the sound quality.</li> </ul>	<p>41</p> <p>LPCM (not compressed) mode</p> <p>You can record with higher sound quality.</p> <p>MP3 (compressed) mode</p> <p>You can record with higher sound quality.</p>
LCF(Low Cut Filter)	<p>Set the LCF(Low Cut Filter) function to cut a low frequency to reduce the roaring noise from wind or noises such as those of air conditioner fans; therefore you can record a track more clearly.</p> <p>ON:  The LCF function is activated.</p> <p>OFF*:  The LCF function is cancelled.</p>	43

Menu items	Settings (*: Initial setting)	See page
DPC(Speed Control)	Set the DPC(Speed Control) function. You can adjust the playback speed between +100% and -75% of normal speed in the menu. You can set the speed by 5% for - from -75% to 0%, 10% for + between 0% and 100%. (-30%*)	54
Effect	Set the effect you want for the playback in the menu. Bass1: The bass sound is emphasized. Bass2: The bass sound is emphasized even more. OFF*: The Effect function does not work.  <b>■ Notes</b> <ul style="list-style-type: none"> <li>• When playing back tracks using a built-in speaker, the Effect function does not work.</li> <li>• When "LINE OUT" is selected, the Effect function does not work.</li> </ul>	56
Key Control	Adjust the playback sounds in semitones higher or lower. You can adjust from #1 to #6, and b1 to b6. (0*)	55
Easy Search	Set the easy search function. ON: You can go forward for about 10 seconds by pressing ►► FF/▲ and go back for about 3 seconds by pressing ◀◀ FR/▼. This function is useful when attempting to locate desired point in a long recording. OFF*: The easy search function does not work. When you press ◀◀ FR/▼ or ►► FF/▲, a track will be moved forward or backward.	51

Menu items	Settings (*: Initial setting)	See page
Play Mode	Set the playback mode. 1: A track is played back.  *: Tracks in one folder are played back continuously. ALL: All the tracks are played back continuously. ↶ 1: One track is played back repeatedly. ↶  *: Tracks in one folder are played back repeatedly. ↶ ALL: All the tracks are played back repeatedly.	51

---

## Detail Menu

<b>Format</b>	Format the memory currently selected in “Memory” setting in the menu, deleting all the data in the memory and resetting the folder structure to its default status. Execute: “Formatting...” appears and the memory will be formatted. Cancel*: The memory will not be formatted.	–
	<b> Notes</b> <ul style="list-style-type: none"> <li>Do not use your computer to format a memory card you use with the PCM recorder. Format it with the formatting function of the PCM recorder.</li> <li>Once the memory has been deleted, you cannot retrieve the data that was deleted.</li> </ul>	



---

Menu items	Settings (*: Initial setting)	See page
<b>Clock</b>	Set the clock by setting year, month, day, hour, and minute in sequence. (09y01m01d 12:00 AM*)  <b>💡 Tip</b> The clock is displayed in 12-hour system. 12:00AM = midnight, 12:00PM = noon	17
<b>LED</b>	Turn the operation of ACCESS indicator, peak level indicators, ● REC button, ► PLAY/ENTER button, and ■ PAUSE button on or off during operation. ON*: During recording or playback, the indicators light or flash. OFF: The operation indicator does not light or flash, even during operation.  <b>📌 Note</b> When the PCM recorder is connected to a computer, the operation indicators light or flash even if “LED” is set to “OFF.”	–

Menu items	Settings (*: Initial setting)	See page
<b>Backlight</b>	<p>Turn the backlight in the display window on or off.</p> <p>10 SEC*: The backlight in the display window lights up for approx. 10 seconds.</p> <p>60 SEC: The backlight in the display window lights up for approx. 60 seconds.</p> <p>Always-ON: The backlight in the display window lights up always.</p> <p>OFF: The backlight in the display window does not light, even during operation.</p> <p><b>Note</b></p> <p>When you select “Always-ON,” the batteries will be consumed quickly. When you use the PCM recorder with batteries, we recommend you select other options than “Always-ON.”</p>	–
<b>Language</b>	<p>Set the language to be used for messages, menus, folder names, file names, etc.</p> <p>English*, Español (Spanish), Français (French)</p>	19
<b>Level Meter in Playback</b>	<p>Set whether the level meter is displayed on the display window when a track is being played back.</p> <p>ON: The level meter will be displayed.</p> <p>OFF*: The artist name and title name of the track will be displayed.</p>	49
<b>Battery Setting</b>	<p>Set the battery type for the PCM recorder.</p> <p>Alkaline Battery*: Select this option to use alkaline batteries for the PCM recorder.</p> <p>NiMH Battery: Select this option to use rechargeable batteries (not supplied) for the PCM recorder.</p>	13



Menu items	Settings (*: Initial setting)	See page
<b>LIMITER</b>	<p>Set the input level automatically to prevent the sound distortion that may occur when a too loud sound is input in Manual recording.</p> <p>ON: The LIMITER function is activated.</p> <p>OFF*: The LIMITER function is cancelled.</p> <p><b>Note</b></p> <p>This feature is effective only when REC LEVEL switch is set to "MANUAL."</p> <p><b>🔊 On the limiter circuit</b></p> <ul style="list-style-type: none"><li>• The limiter circuit functions to keep the signal level below the maximum input level. When a loud sound is input suddenly, the excess part of the sound is automatically set within the range of the maximum input level in order to prevent distortion.</li><li>• The limiter circuit of the PCM recorder does not compensate for clipping when audio over 12 dB is input. In this case, sound may be distorted.</li></ul>	44
<b>PRE REC</b>	<p>Set the pre-recording function on and off. The pre-recording function allows you to record sound sources for approximately 5 seconds prior to the point when the recording is started. Sounds for approximately 5 seconds are buffered in the memory.</p> <p>ON: The pre-recording function is activated.</p> <p>OFF*: The pre-recording function is cancelled.</p>	34

Menu items	Settings (*: Initial setting)	See page
<b>Audio Out</b>	Set the output of the  /LINE OUT (headphone/line output) jack. Headphones*: You can use the jack as a headphone jack. Select this option to listen playback sound with the headphones (not supplied) or an external speaker. LINE OUT: You can use the jack as a line output jack. Select this option to connect an external recorder such as a tape recorder for recording playback sound of the PCM recorder.	58
<b>Notes</b>		
<ul style="list-style-type: none"> <li>• If “LINE OUT” is selected, do not connect headphones; the playback sound from the headphones will be very loud.</li> <li>• If “LINE OUT” is selected, you cannot adjust output volume with the VOLUME +/- buttons and cannot use the Effect function.</li> </ul>		
<b>Plug In Power</b>	Set the Plug In Power function on and off. When a microphone compatible with the Plug In Power function is connected to the  (microphone) jack of the PCM recorder, the PCM recorder can supply power to the microphone. ON*: The PCM recorder supplies power to the connected Plug In Power type microphone. OFF: The PCM recorder does not supply power to a connected microphone.	–
<b>Cross-Memory Recording</b>	Set the Cross-Memory Recording function on and off. When the memory currently selected in the “Memory” setting in the menu becomes full during recording, the PCM recorder automatically switches its destination to the other memory media and continues recording (Cross-Memory Recording). The new recording is saved as another track. ON: The Cross-Memory Recording function is activated. OFF*: The Cross-Memory Recording function is disabled. Recording stops when the memory currently being selected becomes full.	39

# Using the PCM recorder with Your Computer

When the PCM recorder is connected to your computer, it is recognized by the computer, and you can transfer data between them.

### **Copying tracks from the PCM recorder to your computer to save them (page 87)**

You can copy the tracks recorded on the PCM recorder to save them.

### **Copying music files from your computer to the PCM recorder to play them back (page 88)**

You can copy WAV/MP3/WMA/AAC-LC (m4a) files saved on your computer by a simple drag and drop operation when you connect the PCM recorder to your computer. You can also play back the copied files.

### **Using the PCM recorder as a USB memory – data storage function (page 90)**

You can store image data or text data saved on the computer temporarily in the PCM recorder.

### **System requirements for your computer**

See “System requirements” on page 95.

### **When you are using Windows® 2000 Professional**

Install the driver using “SonyRecorder\_Driver.exe” in the PCM recorder.

## Connecting the PCM recorder to your computer

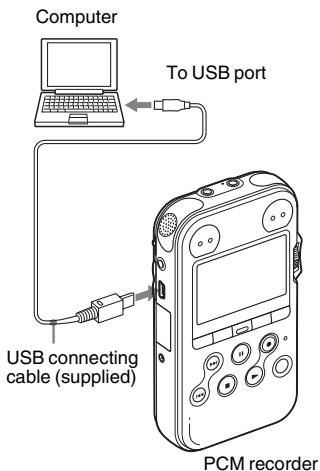

To exchange tracks (files) between the PCM recorder and your computer, connect the PCM recorder to your computer.

- 1 Connect the  USB connector of the PCM recorder with the USB port of your running computer with the supplied USB connecting cable inserted into the

connectors securely until each plug stops to the end.

- 2 Make sure the PCM recorder has been recognized properly.

On the Windows screen; open "My Computer" and make sure that "PCM RECORDER" has been recognized.

On the Macintosh screen; make sure that an "PCM RECORDER" drive is displayed on the desktop.

While the PCM recorder is connected to the computer, "Connecting" is displayed in the display window of the PCM recorder.

### ■ Notes

- If you connect more than two USB devices to your computer, normal operation will not be guaranteed.
- Use of this PCM recorder with a USB hub or a USB extension cable other than the supplied cable is not guaranteed.
- A malfunction may occur depending on the USB devices connected at the same time.
- Before connecting the PCM recorder to the computer, make sure that the batteries are inserted in the PCM recorder.
- It is recommended that you disconnect the PCM recorder from the computer when you are not using the PCM recorder connected to the computer.

# Structure of folders and files

## Built-In Memory and M2™

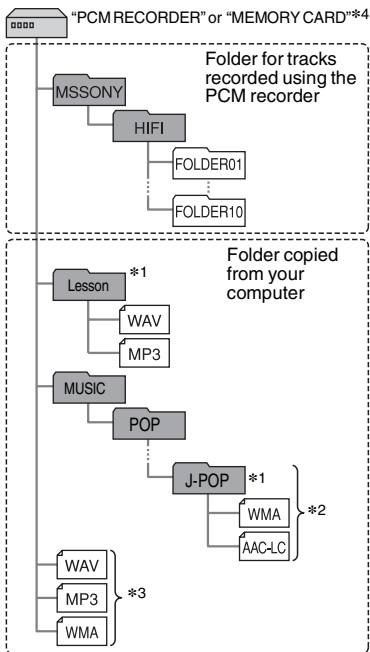

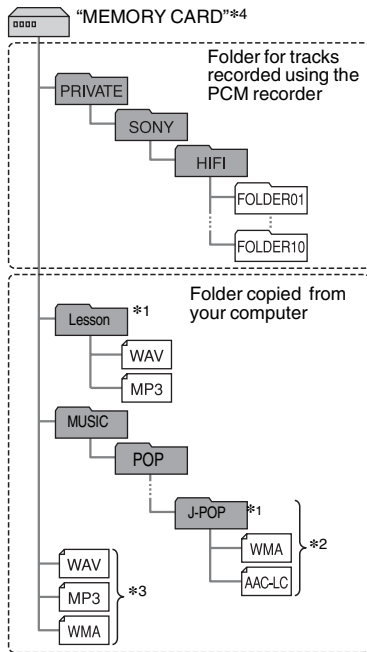

## microSD card



If you connect the PCM recorder to your computer, you can see the structure of folders and files of the built-in memory, memory card (M2™ or microSD card) on the computer screen.

The folders and files are displayed on the computer screen as shown on the previous page.

The folder indicators in the display window of the PCM recorder are as follows:

-  Folder for tracks recorded using the PCM recorder (They have been already made when you purchase the PCM recorder.)
-  Folder copied from a computer (They are displayed when music files have been copied from a computer.)

### Note

You can record tracks in up to 10 folders (FOLDER01-10), each for the built-in memory and memory card, using the PCM recorder.

\*1 The name of a folder in which music files are stored will be displayed on the PCM recorder as it is, so it is convenient if you

put an easy-to-remember name on the folder in advance.

Folders shown in the illustration are examples of folder names.

\*2 The PCM recorder can recognize up to 8 levels of folders copied to the PCM recorder.

\*3 If you copy music files separately, they are classified as being in “No Folder.”

\*4 The volume label of the built-in memory is “PCM RECORDER.” That of M2™ and microSD cards is “MEMORY CARD.”

### Tips

- You can rename a folder, title, artist name, and file name with your computer.
- The title or artist name, etc., registered in the music files can be displayed on the PCM recorder. It is useful if you input the ID3 tag information using the software you use to make the music files on your computer.

### Notes

- You cannot copy more than 511 folders or files to the directory that is located immediately below “MEMORY CARD” on your computer. This is due to FAT file system limitations.
- If no title, or artist name has been registered in the ID3 tag information, “Unknown” will be displayed.

# Copying Tracks from the PCM recorder to Your Computer

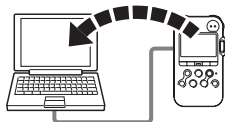

You can save tracks or folders by copying them from the PCM recorder to your computer.

When you wish to create a CD, you can use “Sound Forge Audio Studio LE,” the supplied software application, to create a CD. For the details, see the “Sound Forge Audio Studio LE Guide.”

- 1** Connect the PCM recorder to your computer (page 84).
- 2** Copy tracks or folders you want to copy to your computer.  
Drag and drop the tracks or folders you want to copy from “PCM RECORDER” or “MEMORY CARD” to the local disc on your computer.

 **To copy a track or folder (Drag and drop)**

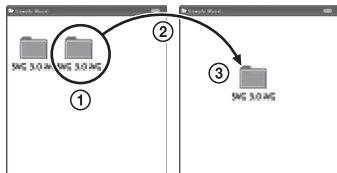

- 1** Click and hold,
- 2** drag,
- 3** and then drop.

- 3** Disconnect the PCM recorder from your computer (page 91).

## **Note**

If you remove a USB connecting cable while the PCM recorder is transferring data to your computer, data may be damaged. For how to disconnect the PCM recorder, see page 91.

# Copying Files from Your Computer to the PCM recorder and Playing Them Back

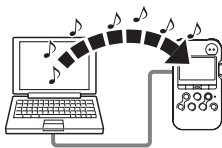

You can copy music or the other audio files (LPCM/MP3/WMA/AAC-LC\*) from your computer to the PCM recorder by dragging and dropping them, and you can play them back using the PCM recorder.

You can make an LPCM/MP3/WMA/AAC-LC file using either a player software application, etc., installed on your computer.

\* For the file formats that can be played back using the PCM recorder, see “Specifications” (page 95).







**1** Connect the PCM recorder to your computer (page 84).





**2** Copy the folder in which the music files are stored to the PCM recorder.

On the Windows screen using Explorer, and on the Macintosh screen using Finder, drag and drop the folder containing the music files onto “PCM RECORDER” or “MEMORY CARD.” The PCM recorder can recognize up to 500 folders. You can copy up to 99 files to one folder and up to 5,000 files in total.

**3** Disconnect the PCM recorder from your computer.

**4** Press .

**5** Press  FF/  or  FR/  to select the folder () in which music files are stored, and then press  PLAY/ ENTER.

**6** Press  FF/  or  FR/  to select the music file you want to play.



**7** Press **▶** PLAY/ENTER to start playback.

**8** Press **■** STOP to stop playback.

The maximum playback time (tracks\*), when playing music files using the PCM recorder, is as follows.

<b>48 kbps</b>	<b>128 kbps</b>	<b>256 kbps</b>
178hr. 55 min. (2,683 tracks)	67 hr.  (1,005 tracks)	33 hr. 30 min. (502 tracks)

\* In the case where tracks of 4 minutes each are copied to the PCM recorder.

### **■ Notes**

- A music file copied from your computer can be played back with the PCM recorder. Dividing a track and setting a track mark, however, may not be performed.
- If you have copied music files using your computer, those files may not be copied in order of copying because of the system limitations. If you copy a music file one by one to the PCM recorder, you can display and play back tracks in order of copying.
- When removing the PCM recorder, see “Disconnecting the PCM Recorder from Your Computer” on page 91.

- The fs/bit (sampling frequency and quantifying bit number) information will not be displayed for a WAV file copied from your computer.
- The bit rate information will not be displayed for a MP3/WMA/AAC-LC (m4a) file copied from your computer.

### **💡 Tip**

You can use your computer to change a folder name, track name, artist name, and file name of a track.

### **💡 To enjoy music files more**

- Selecting the playback mode  
You can select the playback mode, such as playback of one music file, continuous playback of music files in one folder, continuous playback of all music files, repeat playback of one music file, repeat playback of music files in one folder and repeat playback of all music files, in the “Play Mode” menu (page 51).
- Adjusting the playback speed (DPC(Speed Control))  
You can adjust a playback speed between +100% and -75% of normal speed (page 54).
- Selecting a sound effect and tone (Key Control, Effect)  
You can reinforce bass sound by selecting a sound effect from “Bass1” or “Bass2” for playback in the “Effect” menu (page 56). You can also adjust the playback tones in the “Key Control” menu (page 55).

# Using the PCM Recorder as a USB Memory – Data Storage Function

When the PCM recorder is connected to your computer using a USB connecting cable, image data or text data on the computer, as well as tracks or files recorded using the PCM recorder can be temporarily stored in the PCM recorder.

Your computer must meet the operating system requirements and port environment to use the PCM recorder as a USB memory. For details on the system requirements, see page 95.

## **Note**

When you format the memory with the PCM recorder, all the data temporarily stored in the PCM recorder will be deleted. You cannot restore the data.

# Disconnecting the PCM Recorder from Your Computer

Follow the procedures below; otherwise, data may be damaged.

- 1** Make sure that the PCM recorder is in the stop mode.
- 2** Perform the following operation on your computer.  
On the Windows screen, left-click the icon at the bottom of the desktop of the computer.



→ Left-click “Safely remove USB Mass Storage Device.”

The icon can be different on different operating systems.

On the Macintosh screen, drag the “PCM recorder” on the desktop to “Trash” and drop it there.

For details on disconnecting the PCM recorder from your computer, refer to the operating instructions supplied with your computer.

- 3** Disconnect the PCM recorder from the USB port of the computer.

# Precautions

### On noise

- Noise may be heard when the unit is placed near an AC power source, a fluorescent lamp or a mobile phone during recording or playback.
- Operation and touch noises may be recorded when you press the button on the PCM recorder, touch the case, or hold the PCM recorder during recording. By using the supplied remote commander, you can perform recording operations without touching the PCM recorder.
- Roaring noise from wind, or other noises from electric fans, air conditioners, air cleaners, or PC fans will also be recorded. You can reduce the low frequencies noise by setting the LCF(Low Cut Filter) function (page 43). You can also reduce the roaring noise from wind by using the wind screen AD-PCM2 (not supplied).

### On safety

Do not operate the unit while driving, cycling or operating any motorized vehicle.

### On the built-in microphones

The built-in microphones are high-performance electret condenser microphones. Do not expose them to strong wind or water.

### On handling

- Do not subject the PCM recorder to strong shock or vibration. Doing so may cause a malfunction of the PCM recorder.
- Do not place the recorder in the following locations:
  - Anywhere extremely hot. Never expose it to temperatures above 60°C.
  - Under direct sunlight or close to heaters
  - In a sun-heated car with the windows closed (especially in summer)
  - In a humid place, such as in a bathroom
  - Anywhere dusty
- Be careful not to allow water to splash on the unit. The unit is not water-proof. In particular, be careful in the following situations.
  - When you have the unit in your pocket and go to the bathroom, etc.
  - When you bend down, the unit may drop into the water and may get wet.
  - When you use the unit in an environments where the unit is exposed to rain, snow, or humidity.
  - In circumstances where you get sweaty. If you touch the unit with wet hands or if you put the unit in the pocket of sweaty clothes, the unit may get wet.

- You may feel pain in your ears if you use the headphones when the ambient air is very dry. This is not because of a malfunction of the headphones, but because of static electricity accumulated in your body. You can reduce static electricity by wearing non-synthetic clothes that prevent the emergence of static electricity.
- Should any solid object or liquid fall into the unit, remove the batteries and have the unit checked by qualified personnel before operating it any further.

## On maintenance

To clean the exterior, use a soft cloth slightly moistened in water. Do not use alcohol, benzene or thinner.

If you have any questions or problems concerning your unit, please consult your nearest Sony dealer.

### Backup recommendations

To avoid potential risk of data loss caused by accidental operation or malfunction of the PCM recorder, we recommend that you save a backup copy of your recorded tracks on a tape recorder or to a computer, etc.

## On the AC power adaptor

- Use the supplied AC power adaptor for the PCM recorder. Do not use any other AC power adaptor.

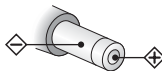

Polarity of the plug

- Connect the AC power adaptor to an easily accessible wall outlet close by. If trouble occurs while using the adaptor, immediately shut off the power by disconnecting the plug from the wall outlet.
- Do not use the AC power Adaptor placed in a narrow space, such as between a wall and furniture.
- To reduce the risk of electrical shock, avoid placing the AC power adaptor in a location subject to humidity.

## On using a memory card

- When formatting (initializing) a memory card, make sure to use the PCM recorder to format it. Memory cards formatted with Windows or other devices may be recognized as incompatible media and cannot be used with the PCM recorder.
- If you format a memory card containing recorded data, the recorded data will be deleted. Be careful not to delete important data.
- Do not leave a memory card within the reach of small children. They might accidentally swallow it.

- Do not remove or insert a memory card while recording or playing back files.
- Do not remove a memory card while “Accessing...” appears on the display window or the ACCESS indicator is flashing in orange. Otherwise, data may be damaged.
- We do not guarantee the operations of all types of compatible memory cards with the PCM recorder.
- M2™ card other than those manufactured by Sony have not been demonstrated as operable with the PCM recorder, and may have problems when used with the PCM recorder. For compatible M2™, please refer to the Sony web site (page 95).
- “MagicGate™” is copyright protection technology that uses encryption technology. The PCM recorder does not support data recording/playback that requires MagicGate™ functions.
- The PCM recorder does not support parallel data transfer.
- A ROM (read-only-memory) type or write-protected memory card is for playback only. You cannot record or edit data on the card.
- SonicStage will create a group on a Memory Stick™ media. The group function, however, cannot be used except with a compatible device.
- Data may be corrupted in the following cases:
  - When a memory card is removed or the PCM recorder is turned off during a read or write operation.
  - When a memory card is used in locations subject to static electricity or electrical noise.
- We assume no responsibility for any loss or damage of recorded data.
- We recommend that you save a backup copy of the important data.
- Do not touch the terminal of a memory card with your hand or a metal object.
- Do not strike, bend or drop a memory card.
- Do not disassemble or modify a memory card.
- Do not expose a memory card to water.
- Do not use a memory card under the following conditions:
  - Locations beyond the required operating conditions, including locations such as the hot interior of a car parked in the sun and/or in the summer, the outdoors exposed to direct sunlight, or a place near a heater.
  - Humid locations or locations with corrosive substances present.
- When using a memory card, make sure to check the correct insertion direction into the memory card slot.

# Specifications

## System requirements

### Operating systems:

- Windows Vista® Ultimate Service Pack 1 or higher
- Windows Vista® Business Service Pack 1 or higher
- Windows Vista® Home Premium Service Pack 1 or higher
- Windows Vista® Home Basic Service Pack 1 or higher
- Windows® XP Media Center Edition 2005 Service Pack 3 or higher
- Windows® XP Media Center Edition 2004 Service Pack 3 or higher
- Windows® XP Media Center Edition Service Pack 3 or higher
- Windows® XP Professional Service Pack 3 or higher
- Windows® XP Home Edition Service Pack 3 or higher
- Windows® 2000 Professional Service Pack 4 or higher
- Mac OS X (v10.2.8-v10.5)
- Pre-Installed

### Hardware environment:

- Port: USB port
- Sound board: Sound cards compatible with any of the supported Microsoft® Windows® operating systems

### Notes

- Operation is not guaranteed if any operating system other than those indicated on the left (Windows® 98 or Linux, etc.) is used.
- 64 bit versions of Windows® XP are not supported.
- For the latest version information and compatibility with your operating system, please access the support home page for the PCM recorder:  
U.S.A.:  
<http://www.sony.com/recordersupport>  
Canada:  
<http://www.sony.ca/ElectronicsSupport/>  
<http://fr.sony.ca/ElectronicsSupport/>
- The following systems are not supported:
  - Operating systems other than the ones indicated on the left
  - Personally constructed computers or operating systems
  - Upgraded operating systems
  - Multi-boot environment
  - Multi-monitor environment

## When you are using Windows® 2000 Professional

Install the driver using  
“SonyRecorder\_Driver.exe” in the PCM recorder.

### PCM recorder section

#### Capacity (User available capacity)

Built-In Memory:  
4 GB (approx. 3.60 GB =  
3,865,470,566 Byte)

A part of the memory capacity is used as a management area.

#### Frequency range (in recording/ playback, LINE IN input)

- LPCM
  - 96.00 kHz: 20 Hz – 40,000 Hz (0 dB, –2 dB)
  - 48.00 kHz: 20 Hz – 22,000 Hz (0 dB, –2 dB)
  - 44.10 kHz: 20 Hz – 20,000 Hz (0 dB, –2 dB)
  - 22.05 kHz: 20 Hz – 10,000 Hz (0 dB, –3.5 dB)
- MP3
  - 320 kbps: 50 Hz – 15,000 Hz (0 dB, –3 dB)
  - 128 kbps: 50 Hz – 15,000 Hz (0 dB, –3 dB)
  - 64 kbps: 50 Hz – 13,000 Hz (0 dB, –3 dB)

#### Recording modes

See page 41.

Bit rate and sampling frequencies for MP3 files\*1

Bit rate: 32 kbps – 320 kbps, VBR  
Sampling frequencies:  
16 kHz/22.05 kHz/24 kHz/32 kHz/  
44.1 kHz/48 kHz  
File extension: .mp3

\*1 Not all encoders are supported.

Bit rate and sampling frequencies\*2 for WMA files

Bit rate: 32 kbps - 192 kbps , VBR  
Sampling frequencies: 44.1 kHz  
File extension: .wma

\*2 WMA Ver. 9 is compatible, however, MBR (Multi Bit Rate), Lossless, Professional, and Voice are not supported.  
Copyright-protected file cannot be played back.  
Not all encoders are supported

Bit rate and sampling frequencies \*3 for AAC-LC (m4a) files

Bit rate: 16 kbps - 320 kbps, VBR  
Sampling frequencies:  
11.025 kHz/12 kHz/16 kHz/22.05 kHz/  
24 kHz/32 kHz/44.1 kHz/48 kHz  
File extension: .m4a

\*3 Copyright-protected file cannot be played back.  
Not all AAC encoders are supported.



## Signal-to-noise ratio (S/N)

(Input from the LINE IN jack and output from LINE OUT jack when recording/playing back LPCM)

87 dB (1 kHz IHF-A) (for 24 bit)

## General

### Speaker

Approx. 16 mm ( $2\frac{1}{32}$  inches) dia.

### Input/Output

- Microphone jack (minijack, stereo), input for plug in power
  - Input impedance: 3.9 k $\Omega$
  - Minimum input level: 0.9 mV
  - Rated input level: 2.5 mV
- LINE IN jack (minijack, stereo)
  - Input impedance: 22 k $\Omega$
  - Minimum input level: 500 mV
  - Rated input level: 2 V
- Headphone/LINE OUT jack (minijack, stereo)
  - Headphone mode
    - Load impedance: 16  $\Omega$
    - Output level: 20 mW + 20 mW
  - LINE OUT mode
    - Load impedance: 22 k $\Omega$
    - Rated output level: 1 Vrms
- USB connector (mini-B jack, High-speed USB, Mass Storage Class)
- REMOTE jack
- DC IN 3V jack
- Memory Stick Micro™ (M2™)/microSD memory card slot

## Playback speed control (DPC)

+100% to -75% (LPCM/MP3/WMA/AAC-LC)

## Maximum power output

250 mW

## Power requirements

DC 3.0 V: When using the AC power adaptor (supplied)

DC 3.0 V: LR6 (size AA) alkaline batteries (supplied) (2)

DC 2.4 V: NH-AA nickel metal hydride rechargeable batteries (not supplied) (2)

## Operating temperature

5°C - 35°C (41 °F- 95 °F)

## Dimensions (w/h/d) (not incl. projecting parts and controls) (JEITA)\*4

62.0 mm × 114.0 mm × 21.8 mm  
(2 1/2 in. × 4 1/2 in. × 7/8 in.)

## Mass (JEITA)\*4

Approx. 187 g (6 5/8 oz.) including 2 LR6 (size AA) alkaline batteries

\*4 Measured value by the standard of JEITA (Japan Electronics and Information Technology Industries Association)

## Supplied accessories

See page 10.

## Optional accessories

Memory Stick Micro™ (M2™) MS-A1GD,  
MS-A2GD, MS-A4GD, MS-A8GU2, MS-  
A16GU2

Stereo headphones MDR-7502, MDR-  
7509HD

Electret condenser microphone ECM-MS957

Audio connecting cable RK-G129

Rechargeable battery NH-AA-B2K

Battery charger BCG-34HS2K

Carrying case speaker CKS-M10

Wind screen AD-PCM2

Tripod VCT-PCM1

Your dealer may not handle some of the above  
listed optional accessories. Please ask the  
dealer for detailed information.

Design and specifications are subject to  
change without notice.

## Maximum recording time\*5\*6

The maximum recording time of all the folders is as follows (rounded figures by 5 minutes).

Recording modes	Built-in memory	Memory card				
	4GB	1 GB	2 GB	4 GB	8 GB	16 GB
LPCM 96.00kHz/24bit	1 hr. 50 min.	25 min.	55 min.	1 hr. 55 min.	3 hr. 50 min.	7 hr. 45 min.
LPCM 96.00kHz/16bit	2 hr. 45 min.	40 min.	1 hr. 25 min.	2 hr. 50 min.	5 hr. 45 min.	11 hr. 35 min.
LPCM 48.00kHz/24bit	3 hr. 40 min.	50 min.	1 hr. 55 min.	3 hr. 50 min.	7 hr. 40 min.	15 hr. 30 min.
LPCM 48.00kHz/16bit	5 hr. 30 min.	1 hr. 20 min.	2 hr. 50 min.	5 hr. 45 min.	11 hr. 35 min.	23 hr. 15 min.
LPCM 44.10kHz/24bit	4 hr.	55 min.	2 hr. 5 min.	4 hr. 10 min.	8 hr. 25 min.	16 hr. 50 min.
LPCM 44.10kHz/16bit	6 hr.	1 hr. 25 min.	3 hr. 5 min.	6 hr. 15 min.	12 hr. 35 min.	25 hr. 20 min.
LPCM 22.05kHz/16bit	12 hr. 5 min.	2 hr. 55 min.	6 hr. 15 min.	12 hr. 35 min.	25 hr. 20 min.	50 hr. 40 min.
MP3 44.10kHz/ 320kbps	26 hr. 45 min.	6 hr. 35 min.	13 hr. 50 min.	27 hr. 50 min.	55 hr. 50 min.	111 hr. 55 min.
MP3 44.10kHz/ 128kbps	67 hr. 5 min.	16 hr. 30 min.	34 hr. 45 min.	69 hr. 40 min.	139 hr. 45 min.	279 hr. 45 min.
MP3 44.10kHz/64kbps	134 hr. 10 min.	33 hr.	69 hr. 35 min.	139 hr. 30 min.	279 hr. 30 min.	559 hr. 35 min.

(hr. : hours/min. : minutes)

\*5 When you are going to record continuously for a long time, you may have to replace the batteries with new ones in the midst of recording. For details on the battery life, see the next table.

\*6 The maximum recording time varies if you record tracks in mixed recording mode.

## Battery life\*1

### When using Sony LR6 (SG) (size AA) alkaline batteries

Recording modes	Recording without monitoring	Recording with monitoring	Playback*2 through speaker	Playback using the headphones
LPCM 96.00kHz/24bit	28 hr.	19 hr.	19 hr.	22 hr.
LPCM 96.00kHz/16bit	28 hr.	19 hr.	19 hr.	24 hr.
LPCM 48.00kHz/24bit	39 hr.	23 hr.	23 hr.	27 hr.
LPCM 48.00kHz/16bit	39 hr.	24 hr.	24 hr.	27 hr.
LPCM 44.10kHz/24bit	41 hr.	24 hr.	24 hr.	28 hr.
LPCM 44.10kHz/16bit	46 hr.	24 hr.	24 hr.	30 hr.
LPCM 22.05kHz/16bit	45 hr.	24 hr.	24 hr.	30 hr.
MP3 44.10kHz/320kbps	40 hr.	26 hr.	24 hr.	28 hr.
MP3 44.10kHz/128kbps	40 hr.	26 hr.	24 hr.	28 hr.
MP3 44.10kHz/64kbps	43 hr.	26 hr.	24 hr.	28 hr.

(hr. : hours/min. : minutes)

## When using Sony NH-AA rechargeable batteries

Recording modes	Recording without monitoring	Recording with monitoring	Playback* <sup>2</sup> through speaker	Playback using the headphones
LPCM 96.00kHz/24bit	28 hr.	19 hr.	19 hr.	21 hr.
LPCM 96.00kHz/16bit	28 hr.	19 hr.	19 hr.	23 hr.
LPCM 48.00kHz/24bit	38 hr.	22 hr.	22 hr.	26 hr.
LPCM 48.00kHz/16bit	39 hr.	23 hr.	23 hr.	26 hr.
LPCM 44.10kHz/24bit	38 hr.	23 hr.	23 hr.	27 hr.
LPCM 44.10kHz/16bit	44 hr.	23 hr.	23 hr.	29 hr.
LPCM 22.05kHz/16bit	41 hr.	23 hr.	23 hr.	29 hr.
MP3 44.10kHz/320kbps	32 hr.	26 hr.	24 hr.	28 hr.
MP3 44.10kHz/128kbps	37 hr.	26 hr.	24 hr.	28 hr.
MP3 44.10kHz/64kbps	38 hr.	26 hr.	24 hr.	28 hr.

(hr. : hours/min. : minutes)

\*1 The battery life is measured in testing using methods proprietary to Sony. The battery life may shorten depending on how you operate the PCM recorder.

\*2 When playing back music through the internal speaker with the volume level set to 16.

# Troubleshooting

Before taking the PCM recorder for repair, check the following sections. Should any problem persist after you have made these checks, consult your nearest Sony dealer.

Please note that recorded tracks may be deleted during service or repair work.

<b>Symptom</b>	<b>Remedy</b>
The PCM recorder cannot be turned off.	<ul style="list-style-type: none"><li>• Slide the POWER/HOLD switch in the direction of "POWER" for more than 2 seconds when the PCM recorder is stopped (page 16).</li></ul>
The PCM recorder cannot be turned on.	<ul style="list-style-type: none"><li>• The power to the PCM recorder is off. Slide the POWER/HOLD switch in the direction of "POWER" for more than 1 second (page 16).</li><li>• The batteries have been inserted with incorrect polarity (page 13).</li></ul>
Display does not disappear. Display appears blurred.	<ul style="list-style-type: none"><li>• Remove the protective film on the display window before you use the PCM recorder.</li></ul>
The PCM recorder does not operate.	<ul style="list-style-type: none"><li>• The batteries are weak (page 14).</li><li>• The power to the PCM recorder is off. Slide the POWER/HOLD switch in the direction of "POWER" for more than 1 second (page 16).</li><li>• The HOLD function is activated. Slide the POWER/HOLD switch in the center direction (page 21).</li></ul>
No sound comes from the speaker.	<ul style="list-style-type: none"><li>• The volume is turned down completely (page 27).</li><li>• Headphones are plugged in (page 50).</li></ul>
Sound comes from the speaker even when the headphones are plugged in.	<ul style="list-style-type: none"><li>• If you plug in the headphones not securely during playback, the sound may come from the speaker. Unplug the headphones and then insert them securely.</li></ul>

Symptom	Remedy
The ACCESS indicator, peak level indicators, ● REC button, ► PLAY/ENTER button, or ■ PAUSE button indicators do not light.	<ul style="list-style-type: none"> <li>• “LED” is set to “OFF”. Display the menu and set “LED” to “ON” (page 79).</li> </ul>
“Memory Full” is displayed and you cannot start recording.	<ul style="list-style-type: none"> <li>• The memory is full. Delete some of the tracks or delete all the tracks after you store them on your computer (page 30, 69).</li> </ul>
“Track Full” is displayed and you cannot operate the PCM recorder.	<ul style="list-style-type: none"> <li>• 99 tracks have been recorded in the selected folder. Therefore you cannot record another track, or copy a track. Delete some of the tracks or delete all the tracks after you store them on your computer (page 30, 69).</li> </ul>
Noise is heard.	<ul style="list-style-type: none"> <li>• A button on the PCM recorder is pressed, the case is touched, or the PCM recorder is held, so that noise was recorded.</li> <li>• The PCM recorder was placed near an AC power source, a fluorescent lamp or a mobile phone during recording or playback.</li> <li>• Roaring noise from wind, or other noises from electric fans, air conditioners, air cleaners, or PC fans have been recorded. You can reduce the noise by setting the LCF(Low Cut Filter) function (page 43).</li> <li>• Plug of the connected microphone was dirty when recording. Clean the plug.</li> <li>• The headphone plug is dirty. Clean the plug.</li> </ul>
The input sound is distorted.	<ul style="list-style-type: none"> <li>• The level is too high in automatic recording. When a guide is displayed, set the MIC SENS(ATT) switch to “LOW,” or place the PCM recorder away from the sound source. If the problem persists, switch to manual recording, and adjust the recording level manually using the REC LEVEL dial.</li> <li>• The sound source has parts that are too loud. Set “LIMITER” in the menu to “ON” (page 44).</li> </ul>

Symptom	Remedy
A howling noise is heard during recording.	<ul style="list-style-type: none"> <li>If you turn up the volume excessively or place the headphones near the microphone while monitoring recording, the microphone may pick up the sound from the headphones, causing acoustic feedback (howling sound). Turn down the volume, or place the headphones far from the microphone.</li> </ul>
You cannot divide a track.	<ul style="list-style-type: none"> <li>You need a certain amount of free space in the memory to divide a track.</li> <li>If 99 tracks have been recorded in the selected folder, you cannot divide a track in that folder. Delete some of the tracks or delete all the tracks after you store them on your computer (page 30, 69).</li> <li>Because of the system limitations, you may not be able to divide a track at the very beginning or end of the track.</li> <li>You can divide or move a track recorded using the PCM recorder only. An MP3/WMA/AAC-LC (m4a) /LPCM (WAV) file copied from a computer cannot be divided or moved.</li> </ul>
When recording from other equipment, the input level is too strong or not strong enough.	<ul style="list-style-type: none"> <li>Connect the headphone jack of other equipment to the (microphone) jack of the PCM recorder and adjust the volume level with the equipment connected to the PCM recorder.</li> </ul>
Playback speed is too fast or too slow.	<ul style="list-style-type: none"> <li>The playback speed is adjusted in DPC. Slide the DPC (SPEED CTRL) switch to "OFF" or adjust the playback speed in the DPC(Speed Control) menu (pages 54).</li> </ul>
"--:--" is displayed.	<ul style="list-style-type: none"> <li>You have not set the clock (page 17).</li> </ul>
"--y--m--d" or "--:--" is displayed on the recording date display.	<ul style="list-style-type: none"> <li>The date of recording will not be displayed if you recorded the track when the clock was not set.</li> </ul>
There are fewer menu items displayed in the menu mode.	<ul style="list-style-type: none"> <li>The menu items displayed are different depending on the operation modes (stop mode, playback mode, and recording mode) (pages 72).</li> </ul>



<b>Symptom</b>	<b>Remedy</b>
The battery life is short.	<ul style="list-style-type: none"><li>• The battery life on page 100 is based on playback with the volume level set to 16. The battery life may shorten depending on the operation of the PCM recorder.</li></ul>
There is no battery power remaining after you have left the batteries inserted for long time without using the PCM recorder.	<ul style="list-style-type: none"><li>• Even if you do not use the PCM recorder, the batteries are consumed slightly. The battery life in this case varies depending on humidity or other environmental conditions. Usually, the batteries last about 4 months. If you do not intend to use the PCM recorder for an extended period of time, it is recommended that you turn the power off diligently or remove the batteries (page 16).</li></ul>
The battery life of the rechargeable batteries are short.	<ul style="list-style-type: none"><li>• You are using the rechargeable batteries in an environment with a temperature of under 5 °C. Charge the batteries in an environment with a temperature of 5 °C - 35 °C.</li><li>• The PCM recorder has not been used for a certain time. Charge and discharge the rechargeable batteries using the PCM recorder several times.</li><li>• Replace the old ones with new rechargeable batteries.</li></ul>
The memory card is not recognized.	<ul style="list-style-type: none"><li>• Since the memory card may contain image data or other files, the memory required for creating initial folders is insufficient. Use Windows Explorer or other tools to delete unwanted files or initialize the memory card on the PCM recorder (page 30).</li><li>• Select “Memory Card” for the “Memory” item of the menu (page 36).</li><li>• Remove a memory card and check the side of the memory card. Then insert it with correct side and direction (page 37).</li></ul>
A character in a folder or track name is displayed in unreadable characters.	<ul style="list-style-type: none"><li>• The PCM recorder cannot support or display some special characters and symbols that are entered on a computer using Windows Explorer or the Macintosh desktop.</li></ul>

<b>Symptom</b>	<b>Remedy</b>
The "Accessing..." display does not disappear.	<ul style="list-style-type: none"> <li>• If the PCM recorder is required to process a large amount of data, the message may be displayed for an extended period of time. This is not a malfunction of the PCM recorder. Wait until the message disappears. In this case, do not remove the batteries or AC power adaptor, while the message is displayed.</li> </ul>
It takes a long time to copy a track.	<ul style="list-style-type: none"> <li>• If the file size of a track is large, it takes a considerable time to finish copying. Please wait until the copying is finished.</li> </ul>
The PCM recorder does not operate with the USB AC adaptor.	<ul style="list-style-type: none"> <li>• You cannot use the USB AC adaptor for the PCM recorder.</li> </ul>
The copied tracks are not displayed.	<ul style="list-style-type: none"> <li>• The PCM recorder can recognize up to 8 levels of folders copied to the PCM recorder.</li> <li>• If tracks are incompatible, other than an LPCM (WAV)/MP3/WMA/AAC-LC (m4a) file that the PCM recorder support, they may not be displayed. See "Specifications" on page 95.</li> </ul>
It takes a long time for the PCM recorder to start.	<ul style="list-style-type: none"> <li>• If the PCM recorder is required to process a large amount of data, it may take longer for the PCM recorder to start. This is not a malfunction of the PCM recorder. Wait until the start-up display disappears.</li> </ul>
Menu does not reflect the change in settings.	<ul style="list-style-type: none"> <li>• Batteries might have been removed just after the menu settings. In this case, the change in settings may not be reflected.</li> </ul>
Some character information does not appear.	<ul style="list-style-type: none"> <li>• When the "Level Meter in Playback" in the menu is set to "ON," you can scroll the title name only. When "OFF" is selected, you can scroll the file name. In both cases, artist name cannot be displayed by scrolling (page 49).</li> </ul>
The PCM recorder does not operate correctly.	<ul style="list-style-type: none"> <li>• Take out the batteries and insert them again (page 13).</li> </ul>

<b>Symptom</b>	<b>Remedy</b>
The PCM recorder does not operate.	<ul style="list-style-type: none"><li>• You may have formatted the memory of the PCM recorder using a computer. Use the PCM recorder formatting function to format the memory (page 78).</li></ul>
The PCM recorder is not recognized by your computer. A folder/file cannot be copied from your computer.	<ul style="list-style-type: none"><li>• Disconnect the PCM recorder from your computer and reconnect it.</li><li>• Do not use a USB hub or USB extension cable other than the supplied USB connecting cable. Connect the PCM recorder to your computer using the supplied USB connecting cable.</li><li>• Operation is not guaranteed if you use any system requirements other than those described on page 95.</li><li>• Depending on the USB port position of the computer you are using, the PCM recorder may not be recognized. If there are multiple USB ports, try another port.</li></ul>
The file copied from your computer cannot be played back.	<ul style="list-style-type: none"><li>• The file format may differ from those that can be played back using the PCM recorder (.wav/.mp3/.wma/.m4a) (page 96). Check the file name.</li></ul>
The computer cannot start.	<ul style="list-style-type: none"><li>• If you reboot the computer with the PCM recorder connected to the computer, the computer may freeze or may not start properly. Disconnect the PCM recorder from the computer and reboot the computer again.</li></ul>

# Error Messages

<b>Error message</b>	<b>Cause/Remedy</b>
Low Battery Level	<ul style="list-style-type: none"><li>• You cannot format the memory or delete all the files in a folder because of insufficient battery power. Prepare new batteries to replace the current ones.</li></ul>
Change Battery	<ul style="list-style-type: none"><li>• Batteries are exhausted. Replace the old LR6 (size AA) alkaline batteries with new ones. Or charge the rechargeable batteries, or replace the old rechargeable batteries with new ones (page 14).</li></ul>
Power Problem	<ul style="list-style-type: none"><li>• An incompatible AC power adaptor may be connected. Check the AC power adaptor. Use the supplied AC power adaptor for the PCM recorder.</li></ul>
Memory Full	<ul style="list-style-type: none"><li>• The remaining memory capacity of the PCM recorder is insufficient. Delete some tracks before recording (page 30).</li><li>• If you copy a large number of files or folders to the directory that is located immediately below "MEMORY CARD" on the computer, editing operations with the PCM recorder may become disabled. Save a backup copy of unwanted files or folders on your computer and delete them from the PCM recorder.</li></ul>
Track Full	<ul style="list-style-type: none"><li>• When there are already 99 tracks in the selected folder, you cannot record a new track. Delete some tracks before recording a new track (page 30).</li></ul>
T-MARK(Track Marks) are Full	<ul style="list-style-type: none"><li>• You can set up to 98 track marks for a track. Cancel unwanted marks (page 60).</li></ul>
Cannot Divide - Exceeding Maximum Number of Tracks in Folder	<ul style="list-style-type: none"><li>• When there are already 99 tracks in the selected folder or the total number of files stored in the PCM recorder exceeds the maximum, you cannot divide a track. Delete some tracks before recording a new track.</li></ul>

<b>Error message</b>	<b>Cause/Remedy</b>
File Damaged	<ul style="list-style-type: none"><li>• You cannot play or edit tracks, because the data of the selected file is damaged.</li></ul>
Format Error	<ul style="list-style-type: none"><li>• The PCM recorder has been formatted using a computer. You cannot perform operations, including recording or playing, because there is no copy of the control file required for operation. Format the PCM recorder using the formatting function in the menu.</li></ul>
Process Error	<ul style="list-style-type: none"><li>• The PCM recorder failed in memory access. Remove and then re-insert the batteries.</li><li>• Save a backup copy of your data and format the PCM recorder using the menu.</li></ul>
Memory Card Error	<ul style="list-style-type: none"><li>• An error occurred while a memory card was being inserted into the memory card slot. Remove and try inserting it again. If this message persists, use a new memory card.</li></ul>
Set Clock	<ul style="list-style-type: none"><li>• Set the clock.</li></ul>
Empty Folder	<ul style="list-style-type: none"><li>• The selected folder does not have any tracks.</li></ul>
Same File Name Exists	<ul style="list-style-type: none"><li>• A track of the same file name already exists in the destination folder when a file is named or copied to the other memory media.</li></ul>
No Entry	<ul style="list-style-type: none"><li>• There are no tracks with “TAKE” or “KEEP” attached to their file names.</li></ul>
No T-MARK(Track Mark)	<ul style="list-style-type: none"><li>• There are no track marks when you attempt to delete or locate a track mark.</li></ul>
No Memory Card	<ul style="list-style-type: none"><li>• There is no memory card inserted into the memory card slot when you attempt to set the “Memory” or “Cross-Memory Recording” menus.</li></ul>
File Protected	<ul style="list-style-type: none"><li>• The selected track is protected or is a “Read only” file. You cannot delete it. You can release the “Read only” attribute using the PCM recorder.</li></ul>

<b>Error message</b>	<b>Cause/Remedy</b>
Memory Card Locked	<ul style="list-style-type: none"> <li>The memory card is write-protected. You cannot record, delete, or edit tracks. To save a track on the card, use a non-write-protected memory card.</li> </ul>
Read Only Memory Card	<ul style="list-style-type: none"> <li>A read-only memory card is inserted. You cannot record, delete, or edit tracks.</li> </ul>
Memory Card Access Denied	<ul style="list-style-type: none"> <li>Since a memory card containing an access control function is inserted, you cannot use it.</li> </ul>
Memory Card Not Supported	<ul style="list-style-type: none"> <li>A memory card that the PCM recorder does not support is inserted. Use a compatible memory card.</li> </ul>
Unknown Memory Card	<ul style="list-style-type: none"> <li>A memory card inserted is incompatible.</li> </ul>
Stop and Reinsert Memory Card	<ul style="list-style-type: none"> <li>A memory card was inserted during recording or playback. Remove the memory card and insert it while the PCM recorder is in the stop mode.</li> </ul>
Unknown Data	<ul style="list-style-type: none"> <li>The data does not have a file format which the PCM recorder supports. The file formats (file extensions) that the PCM recorder supports are LPCM (.wav) files, MP3 (.mp3) files, WMA (.wma) files, and AAC-LC (.m4a) files. For details, see the “Specifications” (page 96).</li> <li>The copyright-protected files cannot be played back.</li> </ul>
Invalid Operation	<ul style="list-style-type: none"> <li>You cannot copy a track or divide a track, because there is more than one folder that has files with same name. Change the file names.</li> <li>You cannot divide or set a track mark to a track not recorded using the PCM recorder.</li> <li>The “Divide All T-MARK(Track Marks)” cannot be executed because there is a track mark within 0.5 seconds from the dividing position.</li> <li>The file name has reached the maximum number of characters; you cannot divide or add “TAKE/KEEP.” Shorten the file name.</li> </ul>

Error message	Cause/Remedy
New Track	<ul style="list-style-type: none"> <li>The file size of the track being recorded has reached the maximum file size: 1 GB for MP3 files, and 2 GB for a LPCM file. The file will be divided automatically and recording will continue as a new track.</li> </ul>
Only Effective During MANUAL Recording Mode	<ul style="list-style-type: none"> <li>When the REC LEVEL switch is set to “AUTO” (automatic recording), you cannot enable “LIMITER” in the menu.</li> </ul>
Level Too High Set MIC SENS to LOW Or Adjust MIC Position	<ul style="list-style-type: none"> <li>When the REC LEVEL switch is set to “AUTO” (automatic recording), the message is displayed when the PCM recorder detects the microphone level is too high to continue automatic recording. If the MIC SENS(ATT) switch is set to “HI,” set it to “LOW.” Or, place the PCM recorder far from the sound source. If the message persists, switch the REC LEVEL switch to “MANUAL” (manual recording).</li> </ul>
Continue Recording in Different Memory	<ul style="list-style-type: none"> <li>When the “Cross-Memory Recording” in the menu is enabled and the memory currently being used becomes full during recording, the PCM recorder switches to the other memory and continues recording.</li> </ul>
Change Folder	<ul style="list-style-type: none"> <li>If there are no tracks in the  folder, no folders are displayed in the display window. Only a folder with a track will be displayed.</li> </ul>
Deleted T-MARK(Track Marks) Too Close to Divided Position	<ul style="list-style-type: none"> <li>When there is a track mark set within 0.5 seconds from the dividing position, the track mark is automatically deleted.</li> </ul>
Invalid when LINE OUT Setting	<ul style="list-style-type: none"> <li>When “Audio Out” is set to “LINE OUT,” the sound volume adjustment with the VOLUME +/- buttons is disabled. Set the “Audio Out” to “Headphones.”</li> </ul>
System Error	<ul style="list-style-type: none"> <li>A system error other than the above has occurred. Remove the batteries and re-insert them.</li> </ul>

# System Limitations

There are some system limitations of the PCM recorder. Troubles as mentioned below are not malfunctions of the PCM recorder.

Symptom	Cause/Remedy
You cannot record tracks up to the maximum recording time.	<ul style="list-style-type: none"><li>• If you record tracks in a mixture of the recording modes, the recordable time varies from the maximum recording time of the highest recording mode to those of the lowest recording mode.</li><li>• The sum of the number on the counter (elapsed recording time) and the remaining recording time may be less than the PCM recorder's maximum recording time.</li></ul>
You cannot display or play back music files in order of copying.	<ul style="list-style-type: none"><li>• If you have copied music files using your computer, those files may not be copied in order of copying because of the system limitations. If you copy a music file one by one to the PCM recorder, you can display and play back tracks in order of copying.</li></ul>
A track/music file is divided automatically.	<ul style="list-style-type: none"><li>• The track/music file being recorded has reached the maximum size limit (1 GB for an MP3/WMA/AAC-LC file, 2 GB for an LPCM file), therefore it is divided automatically.</li></ul>
You cannot enter lower-case characters.	<ul style="list-style-type: none"><li>• Depending on the combination of the characters used for the folder name that was made on your computer, those characters may change to all capitals.</li></ul>
"□" is displayed in place of a folder name, title, artist name, or file name.	<ul style="list-style-type: none"><li>• A character which cannot be displayed on the PCM recorder has been used. Using your computer, replace it with one which can be displayed on the PCM recorder.</li></ul>
When you set A-B Repeat playback, the set positions move a little.	<ul style="list-style-type: none"><li>• Depending on the files, the set positions may move.</li></ul>



# Display Window

## Display when stop or recording

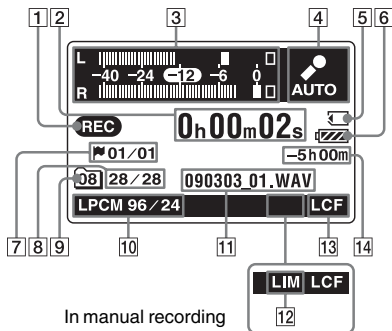

## Display when playback (without level meter display)

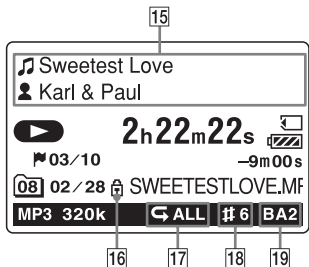

## Level meter display when playback

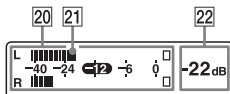

- 1** Operation mode indicator  
 Displays the following, depending on the current operation mode
  - : stop
  - : playback
  - : recording
  - : recording standby/recording pause (The indicator flashes.)
  - : playback pause (The indicator flashes.)
  - : review/fast backward, cue/fast forward
  - : going backward/forward continuously
- 2** Time indication  
 Each time you press DISPLAY button, the time indication changes in the following order: elapsed time (hours, minutes, seconds), remaining time (hours, minutes, seconds), recording

date (year, month, day), and recording time (hour, minute)

- 3 Level meter display in Auto (AGC) recording mode  
In manual recording, the level meter whose colors are reverse is displayed.
- 4 Auto (AGC) recording indication  
In the manual recording mode, a peak level value is displayed.
- 5 Memory Card indication  
When a “Memory Card” is selected as “Memory,” the indication is displayed. When the “Built-In Memory” is selected, no indication is displayed.
- 6 Battery indicator
- 7 The track mark number at the current position/the number of all the track marks  
Appears when a track mark is set for a track.
- 8 Selected track number/Total number of tracks in the folder

#### 9 Folder indication

Displays the information of the current folder:

 : A folder where you can record a track (folder number)

 : A folder whose folder number cannot be obtained.

 : A folder for playback only

#### 10 Recording mode indicator

Displays the recording mode set using the menu when the PCM recorder is in the stop mode, and displays the current recording mode when the PCM recorder is in the playback or recording mode.

**LPCM** 22/16, 44/16, 44/24, 48/16, 48/24, 96/16, 96/24: LPCM file recorded with the PCM recorder

**MP3** 64k, 128k, 320k: MP3 file recorded with the PCM recorder  
When the files are copied from your computer, file formats only are displayed.

**WMA** :WMA files copied

**AAC** : AAC-LC (m4a) files copied

Displays as follows when the PCM recorder cannot get the recording mode.

**----** : Unknown

- 11** File information  
The file name of the track is displayed.
- 12** Limiter indicator  
**LIM** : Appears when the LIMITER is set for a track.
- 13** LCF(Low Cut Filter) indicator  
**LCF** : Appears when the LCF(Low Cut Filter) is set for a track.
- 14** Remaining recording time indication  
Displays the remaining recording time of the memory currently being used in hours, minutes, and seconds.  
If there is more than 10 hours time remaining, the time is displayed in hours.  
If there is more than 10 minutes and less than 10 hours time remaining, the time is displayed in hours and minutes.  
If there is less than 10 minutes time remaining, the time is displayed in minutes and seconds.
- 15** Track information indication  
Track information is displayed:  
🎵 Track title name  
👤 Artist name  
(Depending on the menu setting, the level meter is displayed.)
- 16** Protect indicator  
🔒 : Appears when the protect is set for a track.
- 17** Repeat playback  
🔁 **1** : Appears when one track is played back repeatedly.  
🔁 📁 : Appears when tracks in one folder are played back repeatedly.  
🔁 **ALL** : Appears when all the tracks are played back repeatedly.
- 18** Key Control indicator  
Displays when the Key Control is set for a track:  
**# 6** : Tone is adjusted higher than the natural step (from #1 to #6 in each half-tone step)  
**b 6** : Tone is adjusted lower than the natural step (from b1 to b6 in each half-tone step)
- 19** Effect indicator  
Displays when Effect is set for a track.  
**BA1** : Bass1  
**BA2** : Bass2
- 20** Level meter to display L/R channels output levels
- 21** Peak position marker
- 22** Peak level

# Index

## A

- A-B Repeat ..... 53
- AC power adaptor ..... 15, 93
- Adding a track mark ..... 60
- Adding TAKE or KEEP to a file name ..62
- Adjusting the playback sound tones .....55
- Adjusting the volume ..... 25, 27, 50
- Auto (automatic) recording ..... 22

## B

- Battery life ..... 100
- Battery remain indication ..... 14
- Built-in microphones ..... 23

## C

- Compatible memory cards ..... 37
- Connecting the PCM recorder to your computer ..... 84
- Copying files ..... 88
- Copying tracks to your computer ..... 87
- Cross-Memory Recording ..... 39

## D

- Data Storage ..... 90
- DC IN 3V ..... 15

- Deleting .....30, 69
- Dividing a track .....66
- DPC (the Digital Pitch Control function) .....54

## E

- Easy Search .....51
- Editing tracks .....60
- Effect .....56
- Error messages ..... 108

## F

- File information display .....49
- Folder ..... 22, 26, 29
- Folder structure .....85

## H

- HOLD .....21

## I

- Index to parts and controls
  - Display window ..... 113
  - Front ..... 11
- Inserting and removing a memory card ..36
- Inserting batteries ..... 13

## K

KEEP .....	62
Key Control .....	55

## L

LCF(Low Cut Filter) .....	43
Level meter display .....	49
LIMITER .....	44
Locking the buttons .....	21
LPCM .....	41

## M

Maintenance .....	93
Manual recording .....	33
Memory card .....	37, 93
Memory setting .....	38
Menu	
Add "TAKE" .....	72, 74
Audio Out .....	73, 82
Backlight .....	73, 80
Battery Setting .....	73, 80
Clock .....	73, 79
Cross-Memory Recording .....	73, 82
Delete .....	72, 74
Detail Menu .....	73, 78
Divide .....	72, 74
DPC(Speed Control) .....	72, 77

Easy Search .....	73, 77
Effect .....	73, 77
File Copy .....	72, 74
Format .....	73, 78
Key Control .....	73, 77
Language .....	73, 80
LCF(Low Cut Filter) .....	72, 76
LED .....	73, 79
Level Meter in Playback .....	73, 80
LIMITER .....	73, 81
Making settings .....	71
Memory .....	72, 75
Menu settings .....	72
Play Mode .....	73, 78
Plug In Power .....	73, 82
PRE REC .....	73, 81
Protect .....	72, 75
REC Mode .....	72, 76

Microphone sensitivity .....	42
Monitoring the recording .....	25
MP3 .....	41

## N

Noise .....	92
-------------	----

## P

Playback .....	26, 49
----------------	--------

Playback modes .....	51, 78
Plug In Power .....	46
POWER .....	16
POWER/HOLD switch .....	16, 21
Precautions .....	92
Pre-Recording .....	34
Protect .....	64

## **R**

Recharging batteries .....	13, 101
Recording .....	22, 33
Recording from other equipment .....	47
Recording mode .....	41, 76
Recording time .....	99
Recording with an external microphone .....	46
Recording with other equipment .....	58
Reinforcing the bass sound .....	56
Remote commander .....	32
Repeat .....	52

## **S**

Selecting the sound effect .....	56, 73, 77
Setting the clock .....	17
Setting the language .....	19
Specifications .....	95
Structure of folders .....	85
Supplied accessories .....	10

System Limitations .....	112
--------------------------	-----

## **T**

TAKE .....	62
Track mark .....	60
Troubleshooting .....	102
Turning on the power .....	16

## **U**

USB Memory .....	90
Using the remote commander .....	32
Using your computer .....	83

# Trademarks

- “Memory Stick™,”  “Memory Stick™” and “Memory Stick Micro™” (M2™) are trademarks or registered trademarks of Sony Corporation.
- “MagicGate™” is a trademark of Sony Corporation.
- microSD and microSDHC logos are trademarks of SD-3C, LLC.



- Microsoft, Windows, Windows Vista and Windows Media are registered trademarks or trademarks of Microsoft Corporation in the United States and/or other countries.
- Apple, Macintosh and Mac OS are trademarks of Apple Inc., registered in the USA and other countries.
- MPEG Layer-3 audio coding technology and patents licensed from Fraunhofer IIS and Thomson.
- Sound Forge is a trademark or registered trademark of Sony Creative Software, Inc. in the United States and other countries.

All other trademarks and registered trademarks are trademarks or registered trademarks of their respective holders. Furthermore, “™” and “®” are not mentioned in each case in this manual.

<http://www.sony.net/>



\* 4 1 5 6 5 4 1 1 4 \* (1)

Download from [Www.Somanuals.com](http://Www.Somanuals.com). All Manuals Search And Download.



## Free Manuals Download Website

<http://myh66.com>

<http://usermanuals.us>

<http://www.somanuals.com>

<http://www.4manuals.cc>

<http://www.manual-lib.com>

<http://www.404manual.com>

<http://www.luxmanual.com>

<http://aubethermostatmanual.com>

Golf course search by state

<http://golfingnear.com>

Email search by domain

<http://emailbydomain.com>

Auto manuals search

<http://auto.somanuals.com>

TV manuals search

<http://tv.somanuals.com>