



Please read these instructions carefully and retain for future reference.

Sunbeam Remote Controlled Summit Tower Fan

Instruction Booklet

FA7400 115cm Remote Controlled Tower Fan



Sunbeam is a registered trademark.

Made in China.
Due to minor changes in design or otherwise, the product may differ from the one shown in this leaflet.

© Copyright, Sunbeam Corporation Limited 2010.

ABN 46 000 006 771

Units 5 & 6, 13 Lord Street

Bolton NSW 2019 Australia

Unit 3, Building D

26 Vesley Drive

Mt Wellington Auckland

New Zealand

Sunbeam Corporation is a division of GUD Holdings Ltd.

Need help with your appliance?
Contact our customer service team or visit our website for information and tips on getting the most from your appliance.

In Australia

Visit www.sunbeam.com.au

Or call 1300 881 861

In New Zealand

Visit www.sunbeam.co.nz

Or call 0800 786 232

2 Year Replacement Guarantee

In the unlikely event that this appliance develops any malfunction within 2 years of purchase (3 months commercial use) due to faulty materials or manufacture, we will replace it for you free of charge.

Consumer Law. You are entitled to a replacement or refund for a major failure and for compensation for any other reasonably foreseeable loss or damage. You are also entitled to have the goods repaired or replaced if the goods fail to be of acceptable quality and the failure does not amount to a major failure.

Should your appliance require repair or service after the guarantee period, contact your nearest Sunbeam service centre.

For a complete list of Sunbeam's authorised service centres visit our website or call:

Australia
www.sunbeam.com.au
1300 881 861
Units 5 & 6, 13 Lord Street
Bolton NSW 2019 Australia

New Zealand
www.sunbeam.co.nz
0800 786 232
26 Vesley Drive, Mt Wellington
Auckland, New Zealand

Should you experience any difficulties with your appliance, please phone our customer service line for advice on 1300 881 861 in Australia, or 0800 786 232 in New Zealand. Alternatively, you can send a written claim to Sunbeam at the address listed below. On receipt of your claim, Sunbeam will seek to resolve your difficulties or, if the appliance is defective, advise you on how to obtain a replacement or refund.

Your Sunbeam 2 Year Replacement Guarantee naturally does not cover misuse or negligent handling and normal wear and tear.

Similarly your 2 Year Replacement Guarantee does not cover freight or any other costs incurred in making a claim. Please retain your receipt as proof of purchase.

In Australia, the benefits given to you by this guarantee are in addition to your other rights and remedies under any laws which relate to the appliance.

Our goods come with guarantees that cannot be excluded under the Australian

Important instructions – retain for future use.

請務必理解上述的安全預防措施。
Assurez-vous que les précautions ci-dessus relatives à la sécurité sont bien comprises
Versichern Sie sich, dass die obenstehenden Sicherheitsmaßnahmen verstanden werden
Βεβαιώστε πως οι προειληψίες ασφαλείας απορρέουσες από τα παραπάνω κατανοούνται
Pastikan bahwa tindakan-tindakan keselamatan seperti di atas dimengerti anda
Accertatevi che le suddette norme di sicurezza siano comprese a dovere

上の注意事項をよくお読みになり、安全を確保してください
Yeşerece se Aşağıdaki önlemleri dikkatlice okuyunuz
Asegúrese de que las precauciones de seguridad precedentes sean bien comprendidas
کافی بحث کی اجتناب سے بالکل خاصاً پرکھیں۔
تمام اقدامات کو دیکھ کر سمجھیں اور یقیناً
Yükarıda belirtilen güvenlik önlemlerinin anlaşılığından emin olunuz
Xin kiểm chắc rằng những biện pháp làm an toàn kể trên được hiểu rõ

- Ensure that your fan is switched off and disconnected from the power outlet before cleaning.
- Carefully wipe your fan using a clean cloth. Do not use abrasive cleaners or brushes to clean the appliance as these may scratch the surface.
- Take care that excessive dust does not build up in the air-intake and air-outlet grill, and clean it occasionally using a dry brush or vacuum cleaner.
- Store the fan in a cool dry place when not in use, in its original carton if possible.

Care and cleaning

Sunbeams Safety Precautions	1
Safety Precautions For Your Tower Fan	2
Locating Your Tower Fan	3
Features of Your Tower Fan	4
Illuminated Display Screen	5
Remote Control	5
Assembling Your Tower Fan	6
Using Your Tower Fan	8
Troubleshooting Guide	11
Care And Cleaning	11

Contents







Troubleshooting guide

- If your tower fan fails to operate check the following:**
- Make sure the electrical outlet or circuit breaker is working.
 - Check for obstructions around the air intake grill.
- If your remote control fails to operate check the following:**
- Ensure that you point the remote towards the front of the fan.
 - Check that the batteries are not worn. Replace if necessary.

Sunbeam's Safety Precautions

Using your Tower fan (continued)

- **Sunbeam is very safety conscious when designing and manufacturing consumer products, but it is essential that the product user also exercise care when using an electrical appliance. Listed below are precautions which are essential for the safe use of an electrical appliance:**
- Read carefully and save all the instructions provided with an appliance.
- Always turn the power off at the power outlet before you insert or remove a plug. Remove by grasping the plug - do not pull on the cord.
- Turn the power off and remove the plug when the appliance is not in use and before cleaning.
- Do not use your appliance with an extension cord unless this cord has been checked and tested by a qualified technician or service person.
- Always use your appliance from a power outlet of the voltage (A.C. only) marked on the appliance.
- This appliance is not intended for use by persons (including children) with reduced physical, sensory or mental capabilities, or lack of experience and knowledge, unless they have been given supervision or instruction concerning use of the appliance by a person responsible for their safety.
- Children should be supervised to ensure that they do not play with the appliance.
- The temperature of accessible surfaces may be high when the appliance is operating.
- Never leave an appliance unattended while in use.
- Do not use an appliance for any purpose other than its intended use.
- Do not place an appliance on or near a hot gas flame, electric element or on a heated oven.
- Do not place on top of any other appliance.
- Do not let the power cord of an appliance hang over the edge of a table or bench top or touch any hot surface.
- Do not operate any electrical appliance with a damaged cord or after the appliance has been damaged in any manner. If damage is suspected, return the appliance to the nearest Sunbeam Appointed Service Centre for examination, repair or adjustment.
- For additional protection, Sunbeam recommend the use of a residual current device (RCD) with a tripping current not exceeding 30mA in the electrical circuit supplying power to your appliances.
- Do not immerse the appliance in water or any other liquid unless recommended.
- Appliances are not intended to be operated by means of an external timer or separate remote control system.
- This appliance is intended to be used in household and similar applications such as: staff kitchen areas in shops, offices and other working environments; farm houses; by clients in hotels, motels and other residential type environments; bed and breakfast type environments.

- Nature mode**
Nature mode provides an extra level of comfort by simulating the natural rise and fall of the wind over time. You can use this mode on any fan speed setting.
To use Nature mode:
1. Choose a fan speed.
2. Press the  mode button on either the tower or the remote. The  will illuminate on the display screen.
The fan will now vary its speed every few seconds between the chosen fan speed, each lower fan speed, and off. For example, if you set the fan speed to medium, the actual fan speed will alternate between medium, low and off. To cancel Nature mode, Press the  mode button on either the tower control panel or the remote until the light is no longer illuminated on the display screen.
- Sleep mode**
Sleep mode is identical to Nature mode with the added advantage that the highest fan speed gradually decreases over time. This allows you to turn the fan on a high speed setting last thing at night, knowing that by the time you are asleep, the fan has switched itself down to a slower speed.
To use Sleep mode:
1. Choose a fan speed.
2. Press the  mode button on either the tower control panel or the remote until the  illuminates on the display screen.
The fan will now operate in the same manner as with Nature mode, except that after 30 minutes, the maximum speed will decrease. Eventually in this mode, the fan switches down to low speed and alternates between low and off.
To cancel Sleep mode, Press the  mode button on either the tower control panel or the remote until the  light is no longer illuminated.

If you have any concerns regarding the performance and use of your appliance, please visit www.sunbeam.com.au or contact the Sunbeam Consumer Service Line. **Ensure the above safety precautions are understood.**

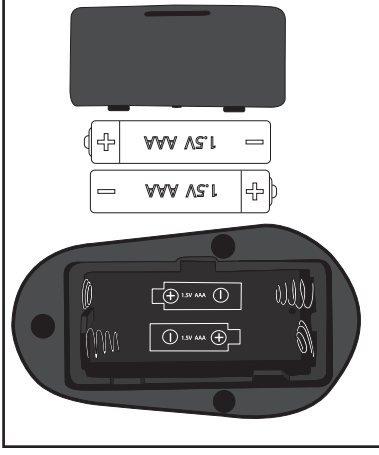

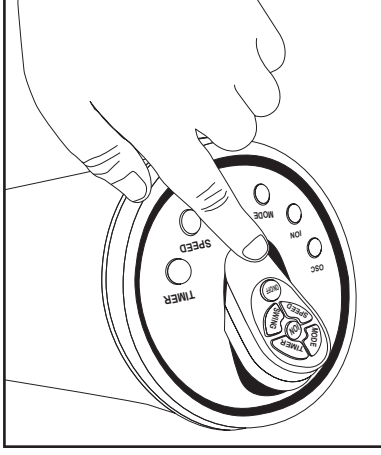

- Changing the batteries**
1. Open the rear cover off the remote control unit.
 2. Replace the spent batteries with 2 fresh AAA batteries as shown.
 3. Replace the rear cover.





- Using the remote control**
1. Remove the remote control from its compartment at the top of the tower by applying downward pressure to the bottom of the remote as shown.
 2. Point the remote towards the control panel on the front of the tower to operate.

Using your Tower fan (continued)

- Using the oscillation function**
- The 70 degree oscillation function can be used on any setting.
1. Turn the unit on and select any fan speed.
 2. Press the  button on the tower control panel or the remote. The 'osc' icon will illuminate and the fan will begin to oscillate from side to side.
- To stop the fan from oscillating, simply press the button  once again.

- Using the auto off timer**
- The auto off timer automatically switches the fan off after a preset number of hours. To activate this feature, simply press the auto off timer button  on the tower control panel or on the remote control unit.
1. Press the auto off timer button once to switch the fan off after 1 hour.
 2. Each subsequent press of the auto off timer button will increase the number of hours the fan will run before turning off automatically by 1 hour increments. The display screen will show the number of hours left before the fan turns off automatically.
- To cancel the setting, keep pressing the auto off button until it cycles past 12 hours, to zero. It will then automatically return to its normal setting displaying the ambient room temperature. The auto off timer will be deactivated and the fan will remain on until it is switched off manually.

Using Your Tower Fan

- Selecting a fan speed setting**
- Your Sunbeam tower fan has 3 speed settings as follows:
- low speed  Display screen shows 2 vertical bars
 - medium speed  Display screen shows 4 vertical bars
 - high speed  Display screen shows 6 vertical bars

To select a fan speed, simply press the fan speed button  on the tower or the remote. Each press of the button will increase the fan speed and then return back to the lowest speed again.

- Switching the fan on**
1. Place the fan on a flat level surface.
 2. Insert the plug into a 230/240V power outlet and turn the power on.
 3. Press the power button  to select low, medium or high depending on your preference.

- Switching the fan off**
- To switch the fan off, simply press the power button .
 - If you will not be using the fan for a length of time, it is advisable to turn the power off at the wall socket and unplug the power cord.

Locating Your Tower Fan

1. Always locate your fan on a flat level surface.
2. Your tower fan should be located in a dry, cool, well ventilated location. Keep your fan away from heat sources, corrosive gases and avoid direct sunlight.
3. Do not attempt to move your tower fan whilst it is operating. If your fan needs to be moved, please ensure that it is turned off and you use the carry handle at the rear of the fan.

Safety Precautions For Your Tower Fan

- Do not use outdoors.
- Do not turn the cord of the fan under carpeting. Do not cover the cord with throw rugs, runners or other floor coverings. Arrange the cord away from traffic areas so that it will not be tripped over.
- Do not use this fan in the immediate surrounds of a bath, shower, laundry area or swimming pool.
- Be sure the fan is placed on a dry, even surface. Do not use on soft surfaces, such as beds, where opening may become blocked.
- Keep your fan away from heat sources, corrosive gases and avoid direct sunlight.
- This fan is only to be used with the base fitted and in good condition.
- Disconnect the power plug before dismantling, assembling or before cleaning.
- Always unplug the fan when not in use for any long length of time.
- The fan must not be used if the guards are damaged in any way.
- Do not insert or allow foreign objects to enter any ventilation or exhaust openings as this may cause electric shock or fire, or damage to the fan.
- Never insert fingers, pencils or any other objects through the guards whenever the power plug is connected, especially while running.
- Avoid touching mobile parts of the fan.
- Do not attempt to move your fan whilst it is operating. If your fan needs to be moved, please ensure that it is turned off and you use the carry handle on top of the tower.
- When scrapping the fan at the end of its useful life, follow local regulations.

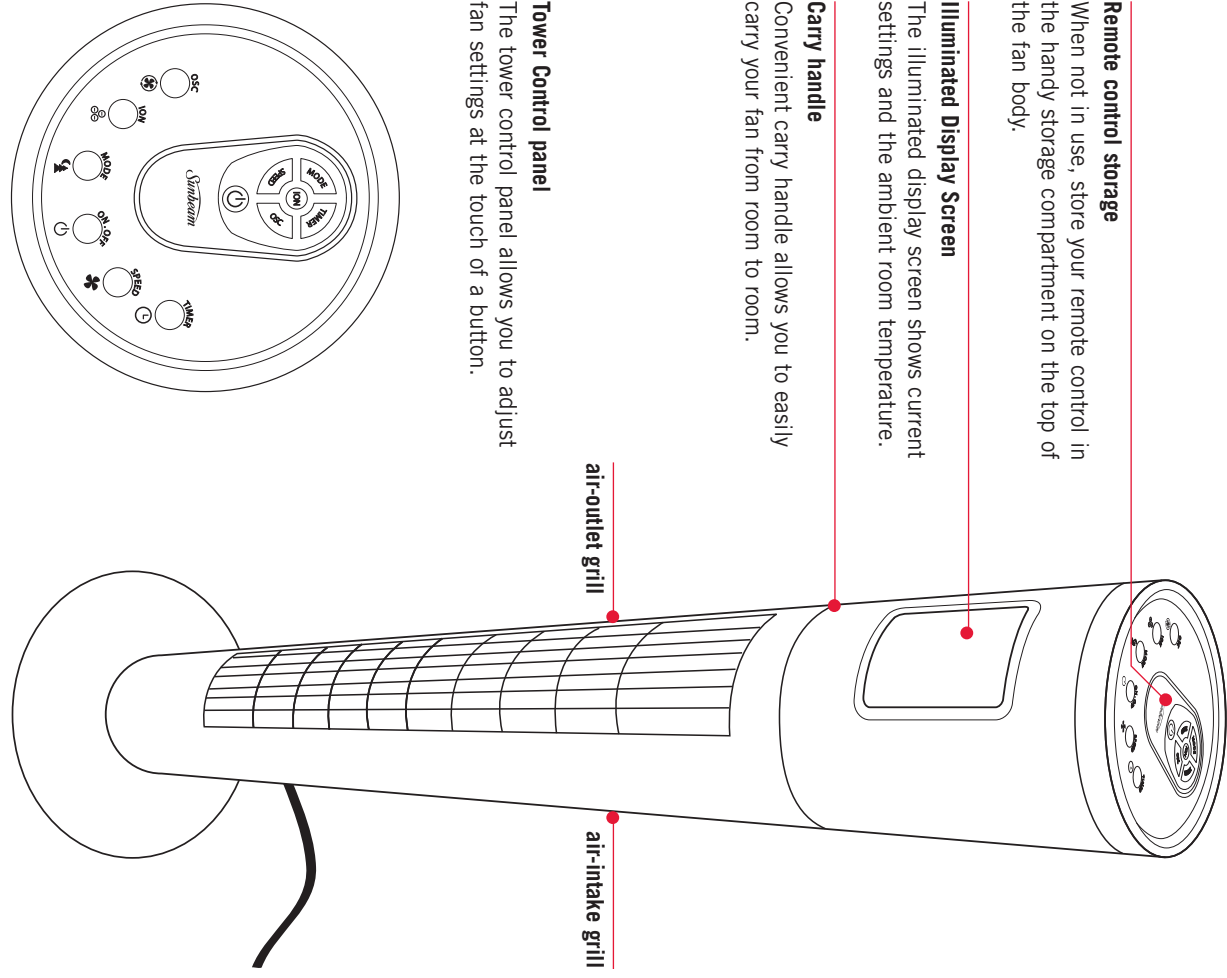

Tower Control panel
The tower control panel allows you to adjust fan settings at the touch of a button.

air-outlet grill

air-intake grill

Carry handle
Convenient carry handle allows you to easily carry your fan from room to room.

Illuminated Display Screen
The illuminated display screen shows current settings and the ambient room temperature.

Remote control storage
When not in use, store your remote control in the handy storage compartment on the top of the fan body.

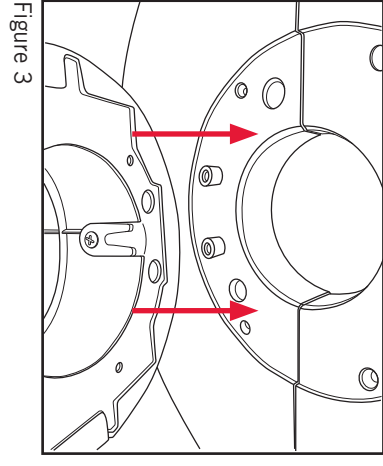

Figure 3

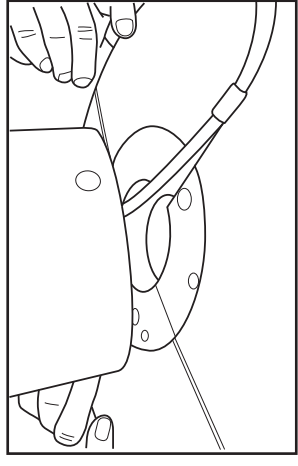

Figure 2

Join the tower to the base

1. Ensure power cord is unplugged.
2. Turn the tower upside down.
3. Align the base and the bottom of the tower so that the two bosses on the base line up with the large holes in the bottom of the tower as shown. Ensure the power cord is sitting in the cord track in the base.
4. Push the base down into the bottom of the tower until it is firmly held into position.

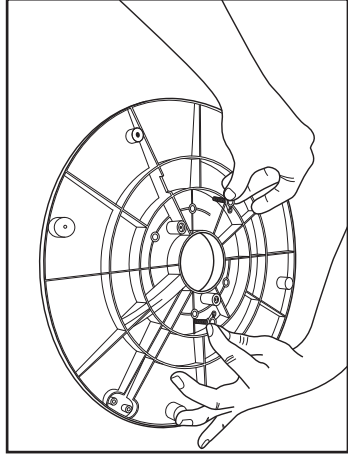

Figure 4

Screw the tower to the base

1. Use the 4 screws to secure the tower to the base.
2. Stand the fan upright. It is now ready for use.

Features Of Your Sunbeam Tower Fan

Illuminated Display Screen

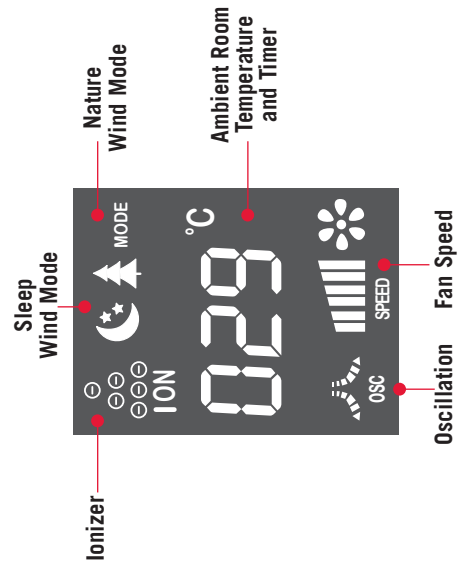

Remote Control

Adjust the fan settings from anywhere in the room using the full function remote control.

Nature and Sleep mode
When used in nature mode, the fan speed is randomly adjusted, giving the feeling of a natural breeze.

Sleep mode is designed to be used when retiring to bed; the fan speed is gradually decreased until the unit is operating on low speed, and when used in conjunction with the auto off timer, will ultimately switch the unit off.

Fan speed button

Choose from 3 speed settings: low, medium or high.

Auto Off Timer button

The auto off timer allows you to set your tower fan to turn off after 1-12 hours.

Ionising Function Button

When turned on, the ion generator releases negative ions into the air.

Oscillation

Your tower fan oscillates 70°, distributing cool air throughout the room.

Power on/off button

Assembling Your Tower Fan

Join the two halves of the base together.
Clip the two halves of the base together.

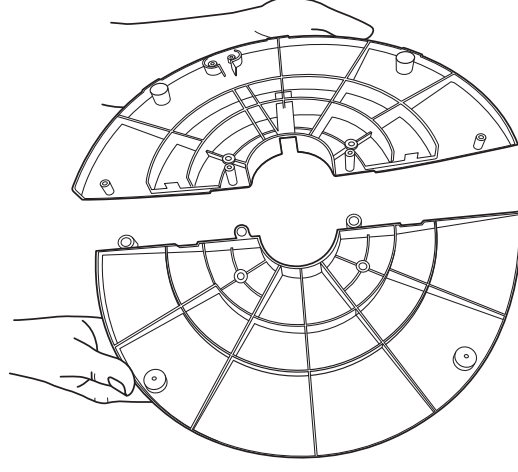

Figure 1

Assembling your Tower fan (continued)

Free Manuals Download Website

<http://myh66.com>

<http://usermanuals.us>

<http://www.somanuals.com>

<http://www.4manuals.cc>

<http://www.manual-lib.com>

<http://www.404manual.com>

<http://www.luxmanual.com>

<http://aubethermostatmanual.com>

Golf course search by state

<http://golfingnear.com>

Email search by domain

<http://emailbydomain.com>

Auto manuals search

<http://auto.somanuals.com>

TV manuals search

<http://tv.somanuals.com>