

Bob Carver's *Sunfire*

Cinema Grand

*Signature 400 ~ seven
and 200 ~ seven*

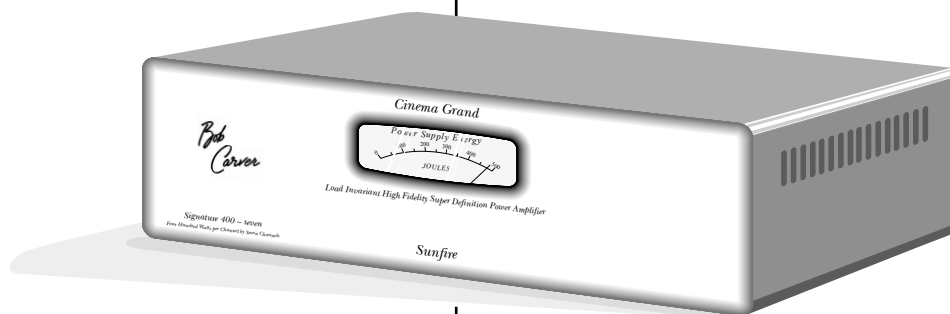
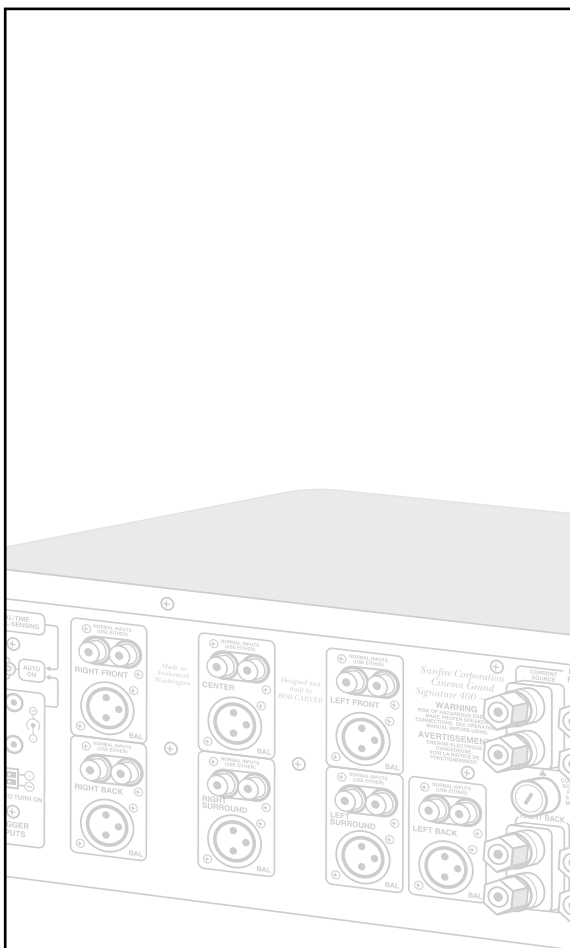

seven

User's Manual

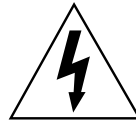

The lightning flash with arrowhead symbol within an equilateral triangle is intended to alert the user to the presence of uninsulated "dangerous voltage" within the product's enclosure, that may be of sufficient magnitude to constitute a risk of electric shock to persons.



The exclamation point within an equilateral triangle is intended to alert the user of the presence of important operating and maintenance (servicing) instructions in the literature accompanying the appliance.

Safety Instructions

- 1. Read Instructions** — All the safety and operation instructions should be read before the Sunfire Component is operated.
- 2. Retain Instructions** — The safety and operating instructions should be kept for future reference.
- 3. Heed Warnings** — All warnings on the Component and in these operating instructions should be followed.
- 4. Follow Instructions** — All operating and other instructions should be followed.
- 5. Water and Moisture** — The Component should not be used near water - for example, near a bathtub, washbowl, kitchen sink, laundry tub, in a wet basement, or near a swimming pool, etc.
- 6. Ventilation** — The Component should be situated so that its location or position does not interfere with its proper ventilation. For example, the Component should not be situated on a bed, sofa, rug, or similar surface that may block any ventilation openings; or placed in a built-in installation such as a bookcase, cabinet, or closed equipment rack that may impede the flow of air through ventilation openings.
- 7. Heat** — The Component should be situated away from heat sources such as radiators, or other devices which produce heat.
- 8. Power Sources** — The Component should be connected to a power supply only of the type described in these operation instructions or as marked on the Component.
- 9. Power Cord Protection** — Power-supply cords should be routed so that they are not likely to be walked upon or pinched by items placed upon or against them, paying particular attention to cords at plugs, convenience receptacles, and the point where they exit the Component.
- 10. Cleaning** — The Component should be cleaned only as recommended in this manual.
- 11. Non-use Periods**—The power cord of the Component should be unplugged from the outlet when unused for a long period of time.
- 12. Object and Liquid Entry** — Care should be taken so that objects do not fall into and liquids are not spilled into the inside of the Component.
- 13. Damage Requiring Service** — The Component should be serviced only by qualified service personnel when:
 - A.** The power-supply cord or the plug has been damaged; or
 - B.** Objects have fallen, or liquid has spilled into the Component; or
 - C.** The Component has been exposed to rain; or
 - D.** The Component does not appear to operate normally or exhibits a marked change in performance; or
 - E.** The Component has been dropped, or its cabinet damaged.
- 14. Servicing** — The user should not attempt to service the Component beyond those means described in this operating manual. All other servicing should be referred to qualified service personnel.

PORTABLE CART WARNING



Carts and stands - The Component should be used only with a cart or stand that is recommended by the manufacturer. A Component and cart combination should be moved with care. Quick stops, excessive force, and uneven surfaces may cause the Component and cart combination to overturn.



15. To prevent electric shock, do not use this polarized plug with an extension cord, receptacle or other outlet unless the blades can be fully inserted to prevent blade exposure.

Pour prévenir les chocs électriques ne pas utiliser cette fiche polarisée avec un prolongateur, un prise de courant ou une autre sortie de courant, sauf si les lames peuvent être insérées à fond sans laisser aucune partie à découvert.

16. Grounding or Polarization — Precautions should be taken so that the grounding or polarization means of the Component is not defeated.

This apparatus does not exceed the Class A/Class B (whichever is applicable) limits for radio noise emissions from digital apparatus as set out in the radio interference regulations of the Canadian Department of Communications.

ATTENTION — Le présent appareil numérique n'émet pas de bruits radioélectriques dépassant les limites applicables aux appareils numériques de class A/de class B (selon le cas) prescrites dans le règlement sur le brouillage radioélectrique édicté par les ministere des communications du Canada.

<p>WARNING – TO REDUCE THE RISK OF FIRE OR ELECTRIC SHOCK, DO NOT EXPOSE THIS APPLIANCE TO RAIN OR MOISTURE.</p>
<p>CAUTION: TO PREVENT ELECTRIC SHOCK, MATCH WIDE BLADE OF PLUG TO WIDE SLOT, FULLY INSERT.</p>
<p>ATTENTION: POUR ÉVITER LES CHOCS ÉLECTRIQUES, INTRODUIRE LA LAME LA PLUS LARGE DE LA FICHE DANS LA BORNE CORRESPONDANTE DE LA PRISE ET POUSSER JUSQU'AU FOND.</p>

Contents

	Safety Instructions	2-3
	Chapter 1: Introduction	4
	Cinema Grand Editions	5
	Unpacking and Installation	6
	Front Panel Features	7
	Rear Panel Features	8
	Chapter 2: System Configurations	10
	Appendix:	
	Series and Parallel	15
	Troubleshooting Guide	16
	Specifications	18
	Limited Warranty	19
	Service Assistance	19

Please read the **Safety Instructions** carefully before connecting and using your Sunfire Amplifier.

Chapter 1 is a general introduction to the features, details and installation of your amplifier.

Chapter 2 shows some typical connections to a preamplifier and speakers.

The Appendix shows some additional information, including a troubleshooting guide, the Warranty, and service assistance details.

To find out more about this and other Sunfire products, please visit our website: www.sunfire.com



Introduction

Bob Carver's
Sunfire

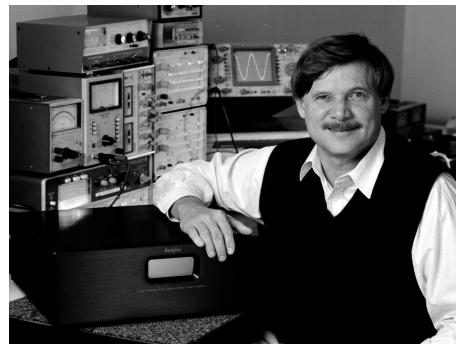

Bob Carver, Amplifier Designer, Physicist

Dear Friend,

Thank you for purchasing my *Sunfire Cinema Grand* seven channel power amplifier. I hope you enjoy it and the music it makes as much as I have enjoyed creating it for you.

This magnificent amplifier represents my very latest thinking - and my best amplifier design ever. I've spent over twenty years developing it, and cannot imagine how I could make it any better, or refine it any further. No matter what, its performance is, at first, somewhat difficult to believe.

The *Signature 400~seven* can produce **400 watts rms per channel into 8 ohms** and **800 watts rms into 4 ohms**.

The *200~seven* can produce **200 watts rms per channel into 8 ohms**, and **400 watts rms into 4 ohms**.

The big breakthrough feature of the *Cinema Grand* is its uncanny tracking downconverter, which uses 18 Herculean Mosfets in the *Signature 400~seven* and 12 in the *200~seven*. This allows the *Cinema Grand* to produce phenomenal power output, without the heat generated by conventional designs.

The circuit boards are heavy glass epoxy, double sided, with a Faraday shield on the back side. All resistors in the signal path are 1% tolerance, metal-film. Critical capacitors are film devices with high dielectric strength and ultra low absorption characteristics. An enormous *Cinema Grand* power source built around a massive power transformer provides the ultimate muscle for limitless dynamics.

I could go on and on, but here's the best part: I've included two kinds of outputs on the **front left** and **front right** channels:

- (1) a standard **voltage-source** (i.e., near zero impedance) output for all typical applications and:
- (2) a higher-impedance **current-source** output, which many prefer for electrostatic, planar magnetic, or ribbon speakers. Or you can biwire your system with the voltage source driving the woofer(s) and the current source driving the upper part of the system. In many cases this provides by far the best possible interface between the amplifier and the speaker system.

Whichever way you decide to hook up the *Sunfire Cinema Grand*, it will create a multilayered soundstage that is deep, wide, three-dimensional, and utterly believable. The optional current-source output can coax forth a sensuous, delicately detailed musical voice long associated with low-powered classic tube amplifiers. (The current-source characteristic of vacuum tubes is the dominant factor in the soundstage delivery of classic tube amplifiers).

Bob Carver



Cinema Grand Editions

The Cinema Grand seven channel power amplifier is available in two editions:

- Signature 400~seven
- 200~seven

The Signature 400~seven has twice the power output, and uses heavier output terminals compared to the 200~seven. Each Signature 400~seven is personally signed on the front panel by Bob Carver.

This manual uses illustrations of the Signature 400~seven. The operational details, features, and connections to loudspeakers and preamplifiers are the same for both models.

Signature 400~seven

400 Watts per channel into 8 Ω

800 Watts per channel into 4 Ω

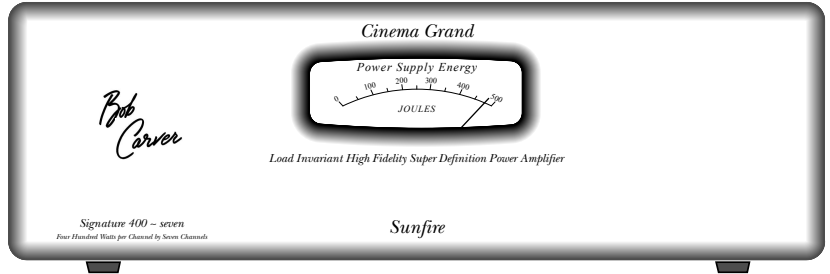

200~seven

200 Watts per channel into 8 Ω

400 Watts per channel into 4 Ω

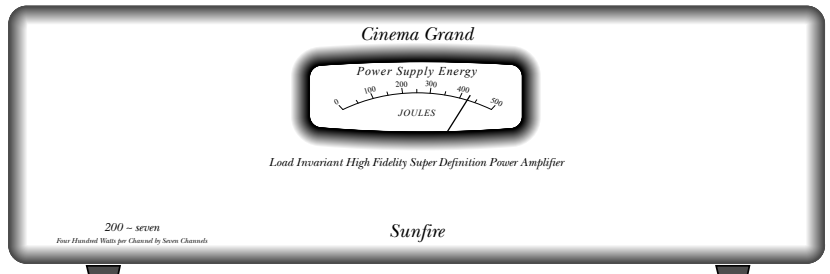



Unpacking

Your Sunfire Amplifier should reach you in perfect condition. If you do notice any shipping damage, please contact your Sunfire Dealer immediately.

Gently lift out the unit and remove all the packing material and accessories. It is important to save all the packing materials and the box in case your amplifier ever needs to be moved or shipped for repair.

Make sure that you keep your sales receipt. It is the only way to establish the duration of your Limited Warranty and it may come in useful for insurance purposes.

Please take a moment to fill out and mail the Sunfire Customer Response card. Also read the serial number located on the rear panel or the underside of the chassis, and record it here:

Serial #:

Purchased at:

Date: _____

Installation

Read and follow all safety instructions shown on pages 2 and 3.

Observe the following precautions when choosing a location for your Cinema Grand Amplifier:

- Protect it from prolonged exposure to direct sunlight and other direct sources of heat, such as heating vents and radiators.
- Do not expose the unit to rain or moisture. If fluid or a foreign object should enter the unit, immediately turn off the power and contact your Sunfire Dealer.
- Avoid excessive exposure to extreme cold or dust.
- Do not place heavy objects on top of the unit.
- Allow adequate ventilation around the amplifier; do not cover the ventilation slots.

AC Power Considerations

Ensure that the unit is plugged into an outlet capable of supplying the correct voltage specified for your model. The outlet should be capable of supplying 15 amps for the 120 V model, 8 amps for the 230 V model.

Care

If you need to clean the front surface, first turn off the power and then use a dry soft cloth, rubbing with the grain. Be careful not to scratch the display window.

Connection Tips

Before setting up your new system, please consider the following :



Always make sure that your components are all turned OFF before making or changing connections.

- Make sure that the power cords of all your components are attached to the same outlet or at least to the same circuit. This will reduce the possibility of a ground loop in the system.



Make sure that the total current draw does not exceed the current rating of your AC outlet or power strip.

- Use the XLR inputs if your preamplifier has XLR outputs. These balanced connections provide superior noise rejection.
- Whenever possible, keep the power cords away from the signal cables or speaker wires to prevent any hum or audio interference being heard in the speakers.
- Choose reliable hookup cables, also called patch cords or RCA cables. They should be fully shielded and as short as possible for the job.
- Some patch cords can be a very tight fit and there is usually a preferred method of getting them off. Some have to be removed with a twisting action. Be gentle or you may damage the jacks of the amplifier or your other components.
- Some special patch cords can only be hooked up in one direction, these are usually marked with arrows.
- It is usual for the right patch cord plugs to be red and the left connections to be white, grey or black. Video connections are usually yellow.



Front Panel Features

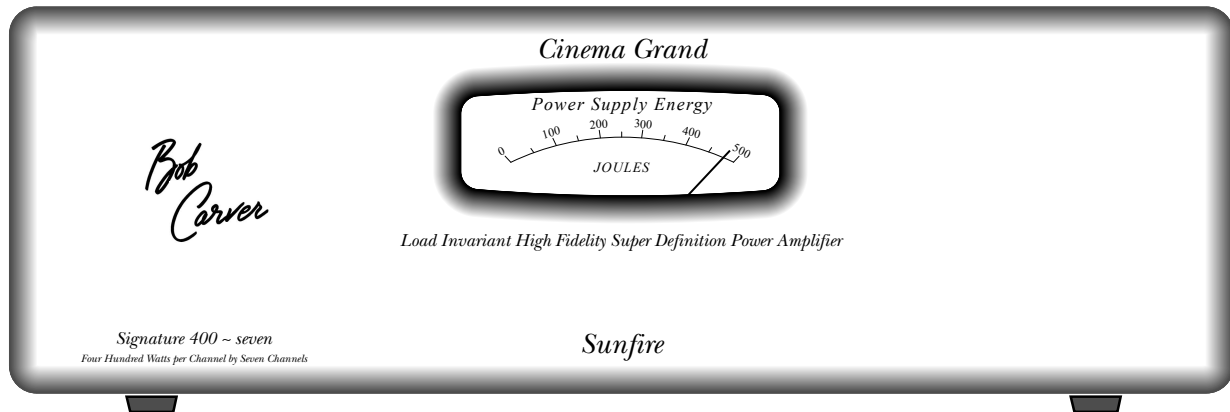

Overview

Your Cinema Grand Amplifier has seven channels of power amplification combined in one chassis for the purpose of reproducing music or video soundtracks. It accepts line level signals from a controlling preamplifier and amplifies them to a higher level, suitable for driving powerful stereo and Home Theater speakers.

Meter

The front panel meter indicates the total energy available from the tracking downconverter power supply. It is calibrated in Joules and will normally indicate approximately 480 Joules for the Signature 400~seven, and 400 Joules for the 200~seven. Note that the needle does not move under normal use.

Crystal Base

The glass base is intended to ensure proper airflow under the amplifier. It prevents any carpeting from restricting the airflow.

If you choose to place the unit on a shelf or other hard surface, the base will isolate the amp from vibration and will help make an attractive installation.

Illumination

The meter is illuminated by an incandescent lamp operating at a very warm color temperature. I have been influenced by the scale lighting of classic electronic equipment from the 1950's, with their warm dim glow, usually with a "headlight effect" from the lamp. I incorporated that historical look and feel into this meter lighting. It is decidedly **not** "evenly back-lit," nor with a cool to cold color temperature. I hope you like my unusual meter lighting treatment.

A switch has been provided on the underside of the unit toward the front. This switch gives you the ability to dim the meter lamp to reduce distractions in a Home Theater environment. I like the brighter of the two settings, as it illuminates the meter nicely and matches my other Sunfire equipment. Feel free to choose the setting that suits you.



Rear Panel Features

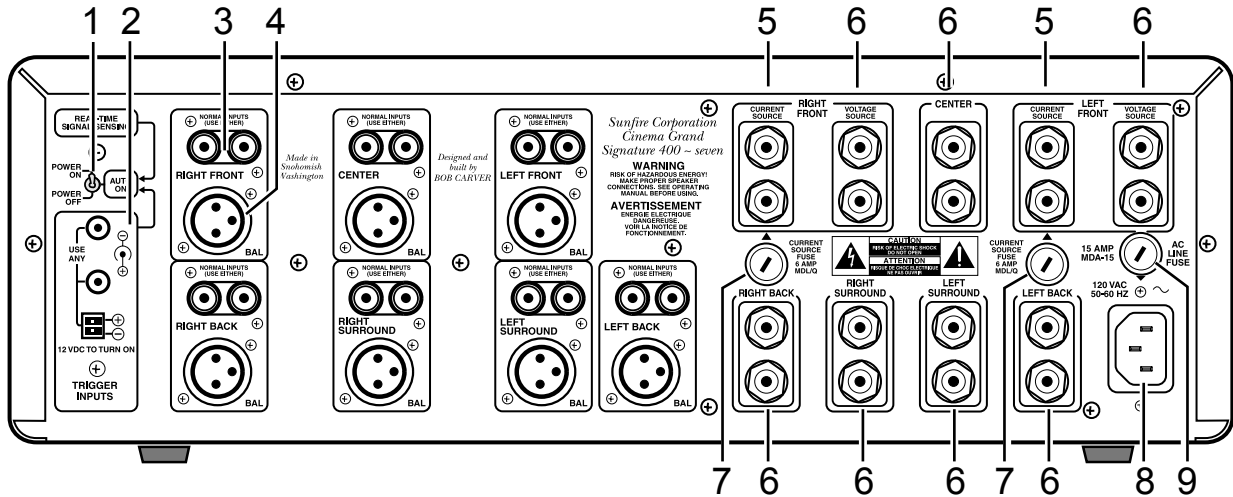

1. AUTO/ON/OFF Switch

Your Cinema Grand Amplifier is designed with an automatic on/off circuit.

- In the AUTO-ON position, the amplifier will automatically turn on if an audio signal is present at any of the inputs, or if it receives a 12 VDC input voltage at the trigger inputs. The amplifier will automatically turn off after a few seconds if the trigger voltage is removed, or after approximately 30 minutes in the absence of an audio signal.
- In the ON position, the amplifier is always on, regardless of input signals or 12 VDC trigger.
- In the OFF position, the amplifier is always off, regardless of input signals or 12 VDC trigger.

2. 12 VDC Trigger Input

Although the AUTO-ON signal sensing turn-on is adequate for most installations, the 12 VDC trigger inputs are offered as an optional way to turn on the amplifier.

The Sunfire Theater Grand II, III and IV Processors have a compatible 12 VDC trigger output (see page 11). This can be used to automatically turn on the Cinema Grand when the Theater Grand Processor is turned on.

1/8" mono mini jacks are provided for ease of installation, along with a terminal strip to allow more flexibility for custom-wired installations. The terminal strip and both mini jacks are internally connected in parallel, allowing 'daisy chaining' to turn on multiple amplifiers.

Any 1/8" miniplug mono or stereo interconnect cable will suffice to connect the trigger output of the Theater Grand preamplifier to the amplifier.



Do not exceed 18 VDC on this input. (CAUTION: Do not connect AC line voltage to this input!)

The voltage range for the trigger input is from 5 to 18 VDC. The input impedance is approximately 600 Ω (20 mA @ 12V).

3. RCA Inputs

Your Cinema Grand Amplifier has three sets of inputs for each of the seven channels. Two are unbalanced RCA inputs and one is a balanced XLR type.

The two RCA inputs for each channel are joined together internally, and either one can be connected to the corresponding output of your preamplifier.

The second RCA input can be used as a daisy-chaining output, sending the preamplifier output signal to another channel or to another amplifier.

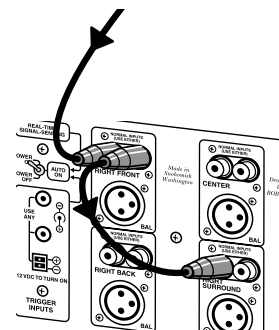



4. XLR Inputs

If your preamplifier has XLR outputs, connect them to these XLR inputs. These balanced connections offer superior noise rejection compared to the unbalanced RCA inputs.

The female XLR inputs are wired as follows:

Pin 1 is ground

Pin 2 is positive (hot)

Pin 3 is negative (cold)

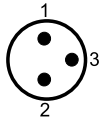

Balanced connections pass the input signal along two conductors. If there is any external noise and interference passing into the audio lines, both conductors will receive the same amount of noise. This noise is then rejected in the balanced input stage of the Cinema Grand Amplifier.

5. Current Source Outputs and:

6. Voltage Source Outputs

The front left and front right channels each have a Voltage Source output and a Current Source output. The remaining channels have Voltage Source outputs only.

The Voltage Source outputs have a source impedance of approximately zero ohms. The Current Source outputs have a source impedance of approximately one ohm.

The top post of each binding post pair is the positive output, and connects to the positive (red) post of your speaker. The bottom post of each pair is the negative, and connects to the negative (black) post of your speaker. The posts can accept bare wire, spade terminals, and dual or single banana connectors.

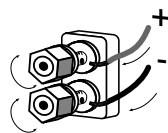

Bare Wire

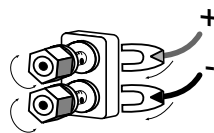

Spade

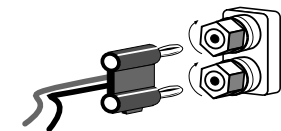

Dual-Banana

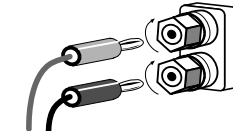

Banana

According to your musical taste, you may select the Current Source for driving electrostatic, planar magnetic or ribbon speakers. Select the Voltage Source for driving subwoofers. For cone based systems, use either. For a biwired system, use the Current Source for midrange and treble drivers, and use the Voltage Source for the subwoofer(s). These are suggestions only. By all means, please feel free to experiment with other wiring options. (See page 14.)

NOTE: The Current Source output is a Voltage Source modified to yield an impedance of one ohm. This corresponds approximately to a vacuum tube amplifier's output impedance and constitutes the dominant factor in the soundstage delivery of classic vacuum tube power amplifiers.

7. Current Source Fuses

Each Current Source output has an in-line fuse to protect your speakers. If one ever opens, there will be no output to that speaker. Turn off the power if you ever have to change a fuse.

8. IEC connector

The amplifier comes with a detachable Linecord which attaches here. Make sure it is firmly pushed in place. Connect the other end to an AC outlet which is properly configured for the type of plug and has the correct voltage for your model.

9. AC Line fuse

If this fuse fails, replace it with the exact same type and current rating.



Note: Always unplug the power cord from your AC outlet before removing the fuse.

With a flat ended screwdriver, push the fuse carrier in slightly and turn it counter-clockwise to release.



System Configurations

The following pages show some typical connections that you might make in your installation. They show how the inputs and outputs of the Cinema Grand Amplifier are connected to your preamplifier and speakers.

Unbalanced Connections

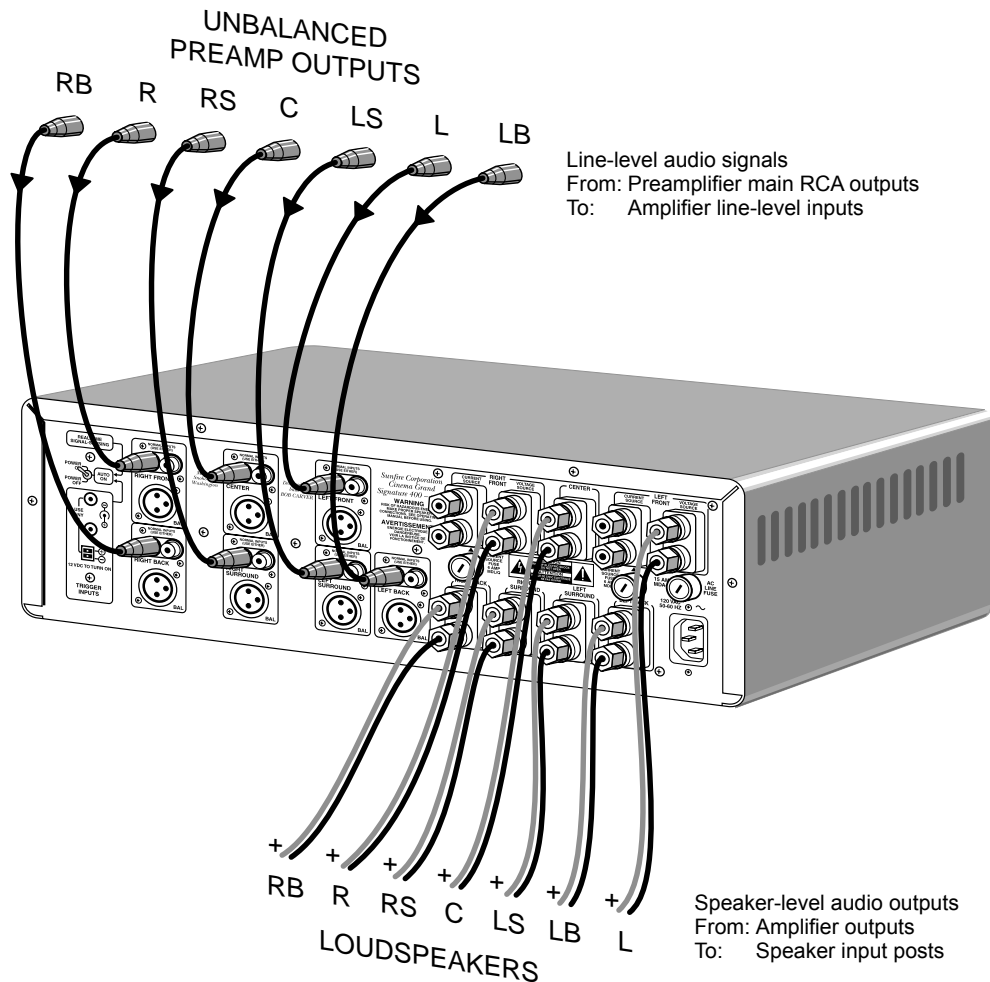

If your preamplifier has RCA outputs, it can be connected to the amplifier inputs as shown. The amplifier will boost the preamplifier's output, up to a level suitable for driving speakers.

This diagram also shows how the Voltage Source outputs connect to the input posts of your speakers. (The Current Source can be used instead, as shown on the next page).



Make sure that the positive speaker wires do not touch the negative speaker wires, or any chassis metal. This will cause a short circuit and may damage your amplifier or speakers.

R = Right Channel
C = Center Channel
L = Left Channel
RS = Right Surround (rear) Channel
LS = Left Surround (rear) Channel
RB = Right Surround Back Channel
LB = Left Surround Back Channel



Balanced Connections

If your preamplifier has XLR outputs, it can be connected to the XLR inputs as shown. This example shows the connections to the Sunfire Theater Grand IV processor. This also shows the Current Source output connections to the front left and right speaker inputs. (The Voltage Source outputs can be used instead, as shown on the previous page.)

Sunfire Theater Grand IV Processor

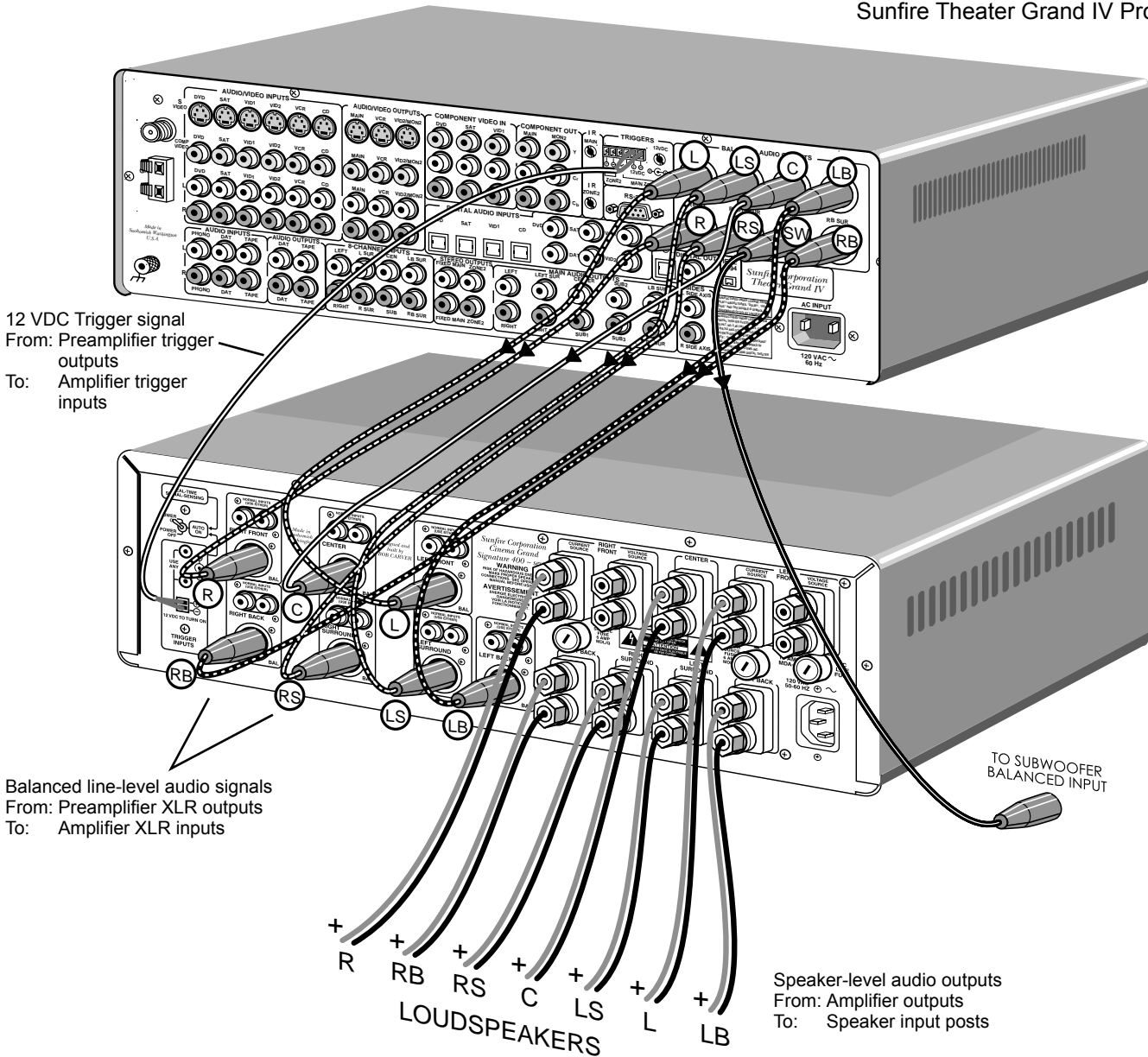

The 12 VDC trigger connection shown can be used to turn the amplifier on when the preamplifier turns on. Alternatively, you could use the amplifier's AUTO-ON switch. The amplifier will then automatically turn on when a preamp audio signal is received.



Biamping

If your speakers can be biamped, the Cinema Grand Amplifier can be configured to provide a very powerful system.

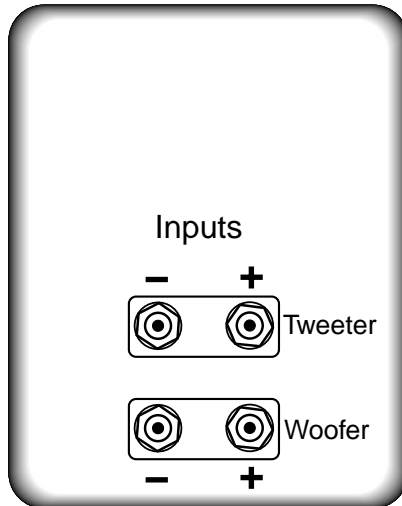

A speaker which can be biamped or biwired will have two sets of binding posts. Sometimes these posts are joined with shorting links for normal operation.



Make sure that any links are removed when you want to biamp or biwire the speakers. If not, this may cause damage to the amplifier.

Each speaker can be driven by two amplifier channels; one to drive the woofer and one for the upper range. You will need to use four amplifier channels to biamp two speakers.

If you use the Cinema Grand Amplifier for biamping, then a total of five speakers can be connected. You will need an extra two channel amplifier if you want to run the surround back speakers in a Home Theater system.

The following connections are shown in the diagram on the top half of the next page.

Output connections

- Connect the amplifier's right rear output to the right speaker's woofer input terminals. Connect the amplifier's right front **current source** output to the right speaker's upper range input terminals. If you prefer, you could use the right front **voltage source** instead.
- Connect the amplifier's left rear output to the left speaker's woofer input terminals. Connect the amplifier's left front **current source** output to the left speaker's upper range input terminals. If you prefer, you could use the left front **voltage source** instead.

Input connections

Each amplifier channel has two RCA inputs which are connected together internally.

- Connect the preamp stereo output to the front channel RCA jacks. Then install short interconnects from the other unused front RCA jacks across to the rear channel RCA jacks. In this way, the front and rear amplifier channels are fed with the same signal from your preamp.
- Note: you cannot use XLR cables in, with RCA out, or RCA in with XLR out. There is no direct internal connection between the RCA and XLR inputs.

Biamping Connections

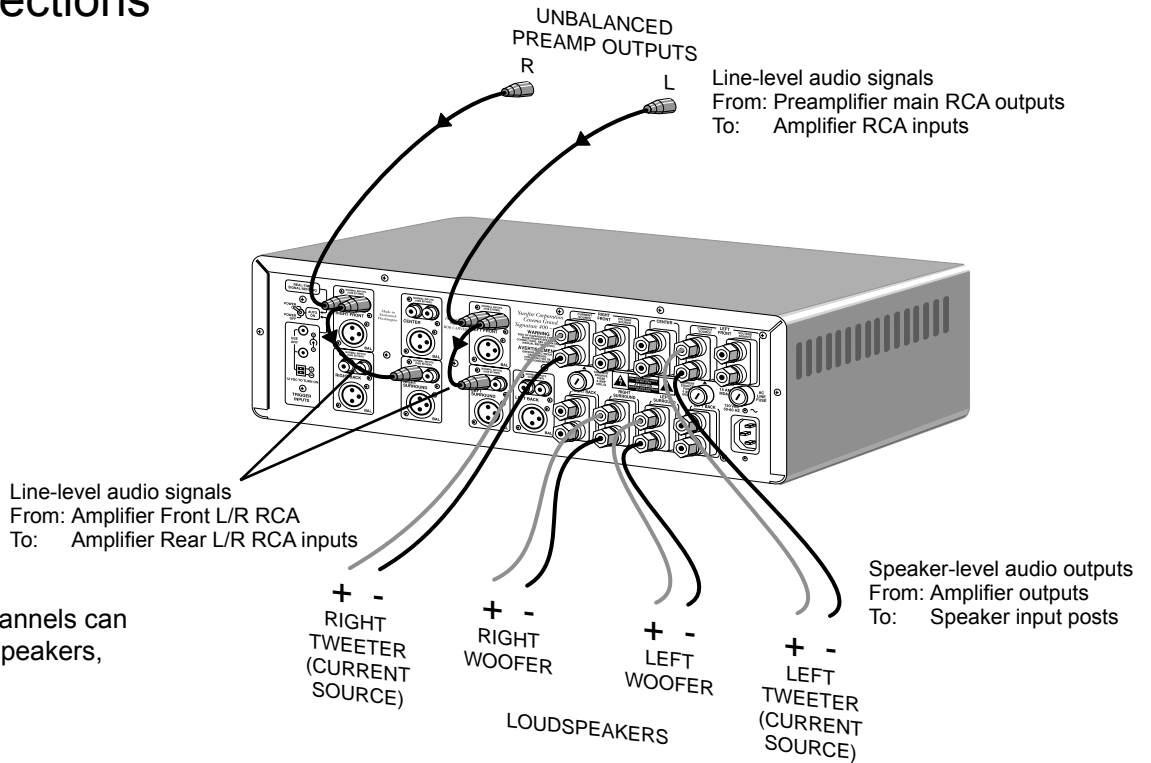

Note: The remaining channels can be used to drive other speakers, or left unconnected.

Biamping with an external crossover

If you have an external active crossover, you can greatly increase the efficiency of your system. The crossover will split the preamplifier output signals into two frequency ranges.

You can connect the crossover's low frequency outputs to the amplifier's rear channel inputs, and the crossover's higher frequency outputs to the amplifier's front channel inputs.

This is an efficient system because the channels only amplify signals within the frequency range of the speaker element they are driving. Little power is wasted.

Make sure that the crossover point of your active crossover is adjusted to match the crossover point of your speakers. Consult your speaker and crossover owner's manuals.

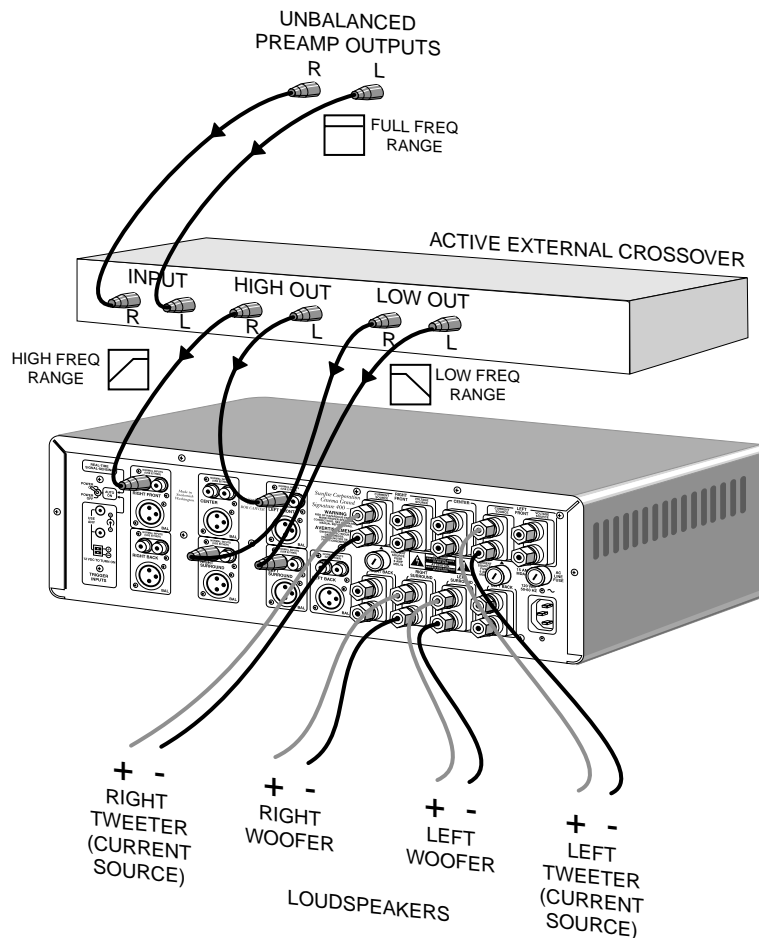



Biwiring Connections

If your speakers can be biwired or biamped, they will have completely separate input terminals for the woofer section and the upper range. See the speaker diagram and discussion on page 12.



Make sure that any links between the woofer and upper range posts are removed from the speakers when you want to biamp or biwire them. Consult your speaker owner's manual for details.

The front channels of the Cinema Grand Amplifier each have two pairs of outputs which can be used to biwire your speakers. The idea is to use the **voltage source** to drive the woofer, and the **current source** to drive the upper range. This will offer improved performance and still allow you to connect seven speakers for your Home Theater system.

This page shows the input and output connections for Biwiring a left front speaker and a right front speaker.

The remaining speaker connections have been omitted from this drawing for clarity. They can be connected as shown on pages 10 and 11.

Output connections

- Connect the amplifier's right front **voltage source** output to the right speaker's woofer input terminals. Connect the amplifier's right front **current source** output to the right speaker's upper range input terminals.
- Connect the amplifier's left front **voltage source** output to the left speaker's woofer input terminals. Connect the amplifier's left front **current source** output to the left speaker's upper range input terminals.

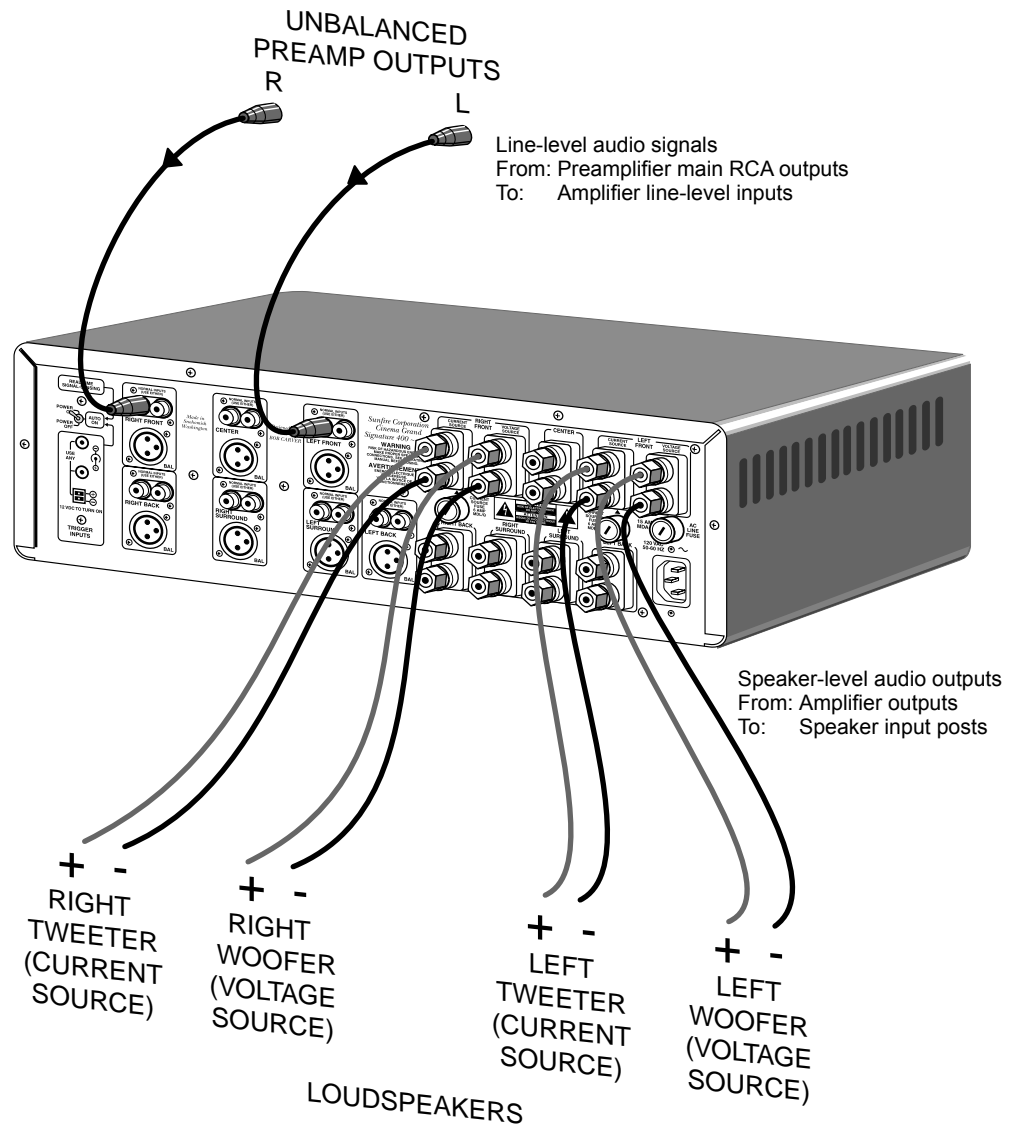

Input connections

Connect your preamplifier's outputs to the corresponding input jacks on the Cinema Grand.

Series and Parallel speaker connections

The connection of more than one speaker per channel will tend to degrade the speaker's frequency response, and may make the amplifier run hot. For the best results use one speaker per channel.

If you do want to connect more than one speaker per channel, there are two main ways: Series or Parallel.

Series

For example, if you want to series-connect two speakers to the front right channel of the amplifier:

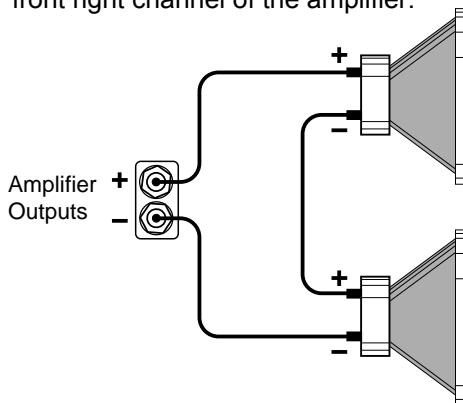

- The positive output terminal of the right channel connects to the positive input post of the first speaker.
- The negative input post of the first speaker connects to the positive input post of the second speaker.
- The negative input post of the second speaker connects to the negative output terminal of the right channel.
- The total impedance of speakers in series is found by adding their impedances together. For example, two four ohm speakers in series is an eight ohm load.
- Series connections are easier on the amplifier than parallel connections as the total impedance is higher than driving a single speaker.

Parallel

For example, if you want to parallel-connect two speakers to the front right channel of the amplifier:

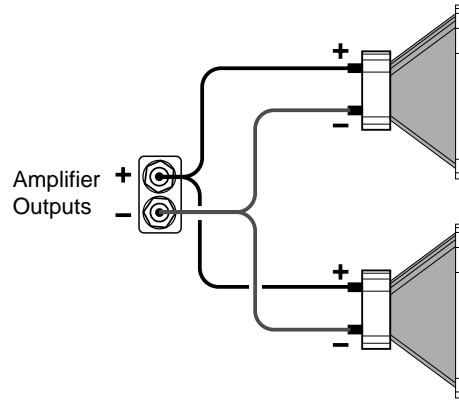

- The positive output terminal of the right channel connects to the positive input post of the first speaker and to the positive post of the second speaker.
- The negative output terminal of the right channel connects to the negative input post of the first speaker and to the negative post of the second speaker.
- The total impedance of equal speakers in parallel is found by dividing the impedance of one speaker by the number of speakers. For example, two eight ohm speakers in parallel is a four ohm load (eight ohms divided by two), four eight ohm speakers in parallel is a two ohm load (eight ohms divided by four).
- Parallel connections are harder on the amplifier than series connections, as the total impedance is lower compared to driving a single speaker, and the amplifier must produce more current to drive them.

- Ideally, the total average impedance should be no less than 2 ohms per channel.
- You must make sure that the lower impedance does not cause the amplifier to over-heat, shut down, blow the line fuse, or pop your circuit breaker. If this happens, you should reduce the number of speakers wired in parallel, rewire them in series, or use more than one power amplifier.



Troubleshooting Guide

The Sunfire Amplifier is expertly designed and built to provide years of trouble-free performance. Most problems that occur can usually be solved by checking your setup or making sure that the audio and video components connected to your processor are on and fully operational.

The following information will help you deal with common setup problems you may experience during normal use of your unit. If the problems still persist, please contact your Sunfire Dealer for assistance.

No sound from one or more speakers

- Speaker cables may have come undone. Turn off your system and check the cables, and tighten the amplifier and speaker binding posts.
- Broken audio cable.
- The preamplifier volume level is low for the channels concerned. Recheck the preamplifier calibration procedure.
- A preamplifier Mute switch may be on, or an external processor loop or a tape monitor loop is engaged.
- Check that your preamplifier or source is running the correct surround sound mode. Maybe it is set for stereo when you were expecting 5.1 surround sound.
- Check in case any missing channels have been turned off in a preamplifier setup menu. For example, the center amplifier channel will not receive a signal if the preamplifier has been set to "Phantom."
- The Auto/on/off switch might be in the off position.
- One of the fuses for the current source outputs may have blown.

The amplifier shuts down often or the line fuse blows often

- Check that the positive and negative speaker wires are not shorted together.
- Make sure that no speakers are shorted internally. If you have an ohm-meter, disconnect the speaker wires and measure the resistance between the speaker's positive and negative terminals. If the reading is less than 2 ohms, the speakers may have an internal short. Measure all speakers and check their impedance specifications.
- If you have connected speakers in Parallel, the overall impedance may be too low. It is recommended that you rearrange the speakers in Series to increase the overall impedance, thus taking some of the load off the amplifier.
- Make sure that the amplifier has good ventilation and is not overheating. Use the crystal base to allow good airflow underneath. If the amplifier is in a closed rack, open up the rear panel or use a quiet fan for improved ventilation.

A hum is heard in your speakers

This problem is more than likely caused by a "ground loop" in your system, rather than a fault in the amplifier. Follow these steps to isolate the main cause of the hum; there may even be more than one.

- If your preamplifier has XLR balanced outputs, use them because they offer greater immunity to noise fields.
- Remember to turn off all components in your system, including the amplifier, before disconnecting or connecting any cables during troubleshooting.

- Try to have all of your equipment on the same electrical outlet or circuit. Group all the low power components (preamp, CD player, DVD etc.) on a single outlet or power strip. This is provided that the overall current draw from your equipment does not exceed the rating of the outlet or breaker.
- Disconnect all cables which come from outside the room, and check if the hum goes away. This includes such connections as cable TV, satellite TV, or roof top antennas. Make sure that they are disconnected where they first enter the room, so they are making no connection to the preamplifier or the TV, or any other component. If the hum is caused by the cable TV line, then you will need a "ground loop isolator." This is an inexpensive device fitted in line with the coaxial cable feed. Contact your cable company or your Sunfire Dealer for assistance.
- Disconnect all connections from the preamplifier to your TV, VCR or DVD.
- As a test, disconnect any other component which has a grounded power cord.

NOTE: Never remove the ground pin from any power cords. This is very dangerous.

- If the hum persists, disconnect all the source components one at a time from the back of the preamplifier, until you identify the problem.
- Ground loop isolators are available for audio lines and video. You can ask your Sunfire Dealer for assistance.
- Try moving the speaker cables away from any power cords. Try just one speaker, connecting it to each amplifier channel and see if one channel is bad.



- Check that the interconnect cables to the amplifier do not have any broken connections.

Other causes of noise

- Speaker noise may also be caused by interference or noise on your AC line. Make sure there are no large appliances sharing the line, or halogen lamps or lamps with dimmer controls.
- Try connecting your system to another AC socket on a separate line.
- Keep power cords away from audio cables.
- Do not place the preamplifier directly on top of the amplifier.
- If the hum is heard from within the amplifier and not through the speakers, this may also be caused by interference on the AC or DC lines. The power transformer may turn this interference into an audible noise. Internal hum can be made worse by a shelf or cabinet resonating, so try moving the amplifier to another shelf.
- Try moving your preamplifier further away from your amplifier. Sensitive preamp circuits may pick up hum from the amplifier transformer's magnetic field.
- Try moving your components further away from the TV, especially if you ever notice the screen has changed color in the area closest to the component.
- If you have very high efficiency speakers, these may show up noise which other speakers may not.
- If you are still having a problem, remember that Sunfire's dealers and technical support staff will assist you. Make a list of the things you have tried.

Poor bass performance

- Make sure that your preamp does not have the bass level turned down.
- Many surround preamplifiers have controls which can direct all the bass to subwoofers, or let your main speakers play the full range. Make sure that the preamplifier has been correctly set. If you are not using a subwoofer, set the speaker options to "Large."
- Check that the speaker wires have been connected correctly: Make sure that the positive of each speaker connects to a positive output of the amplifier, and the negative of each speaker connects to a negative output. If one speaker is wired incorrectly, then it will be "out of phase" with the others, resulting in poor bass performance.
- If you have connected the amplifier using the XLR inputs, make sure that the XLR cables are wired correctly. If one has the hot and cold reversed, then this will also cause a speaker to be out of phase.

Turn-on and turn-off thumps

- Plug the amplifier into an unswitched AC outlet, and use the AUTO-ON feature. This will allow the amplifier to turn on and off silently.

Current source outputs not working

- If you are biamping or biwiring, make sure that the **current source** fuses have not blown.
- If these fuses blow often, it is acceptable to replace with a slo-blo 7 ampere fuse.



Specifications

Signature 400~seven

Power output

400 watts continuous, per channel, into eight ohms, from 20 Hz to 20 kHz with no more than 0.5% T.H.D.

Power at clipping, min

800 watts per channel into four ohms.

1600 watts per channel into two ohms (time limited basis).

Hum and Noise

-118 dB, A-Weighted

Maximum output current

120 amps peak to peak per ch.

Maximum output voltage

56.6 Vrms

Output impedance Front Left and Right channels

Voltage source: Approx. zero ohms
Current source: Approx. one ohm

RCA Input impedance:

24 k Ω

Input sensitivity for rated output

Unbalanced: 1.9 Vrms

Balanced: 0.95 Vrms

XLR Input impedance:

10 k Ω , each leg balanced to ground

Female XLR

Pin 1 is ground

Pin 2 is positive (hot)

Pin 3 is negative (cold)

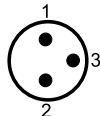

12 VDC Trigger Inputs

Input voltage range 5 -18 VDC

Impedance: approx 600 Ω
(20 mA @ 12 V)

Removable terminal block, and dual 1/8" minijacks for daisy-chaining.

Power Consumption

45 W	At idle
580 W	Typical (1/8th power)
1800 W	Absolute Max (Fuse Limit)

Dimensions and Weight

17.0 inches wide
5.9 inches high (including feet)
16.7 inches deep (to tips of connectors)
Weight 40 lbs

Finish

Brushed aluminum with black anodize

200~seven

Power output

200 watts continuous, per channel, into eight ohms, from 20 Hz to 20 kHz with no more than 0.5% T.H.D.

Power at clipping, min:

400 watts per channel into four ohms.

800 watts per channel into two ohms (time limited basis).

Hum and Noise

-115 dB, A-Weighted

Maximum output current

80 amperes peak to peak per channel

Maximum output voltage

40 Vrms

Output impedance Front Left and Right channels

Voltage source: Approx. zero ohms
Current source: Approx. one ohm

RCA Input impedance

24 k Ω

Input sensitivity for rated output

Unbalanced: 1.34 Vrms

Balanced: 0.67 Vrms

XLR Input impedance

10 k Ω , each leg balanced to ground

Female XLR

Pin 1 is ground

Pin 2 is positive (hot)

Pin 3 is negative (cold)

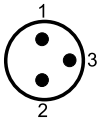

12 VDC Trigger Inputs

Input voltage range 5 -18 VDC

Impedance: approx 600 Ω
(20 mA @ 12 V)

Removable terminal block, and dual 1/8" minijacks for daisy-chaining.

Power Consumption

45W	At idle
280W	Typical (1/8th power)
1800W	Absolute Max (Fuse Limit)

Dimensions and Weight

17.0 inches wide
5.9 inches high (including feet)
16.7 inches deep (to tips of connectors)
Weight 34 lbs

Finish

Brushed aluminum with black anodizing

© 2004 Sunfire Corporation. All rights reserved. Sunfire Corporation reserves the right to improve its products at any time. Therefore, specifications are subject to change without notice.

Manual part # : 913-115-00 Rev A



Limited Warranty

Sunfire Corporation is proud of its products which have been built with care using advanced technology and premium component parts. Your unit has been crafted to perform properly for many years. Sunfire Corporation offers the following Warranty to you, the owner of a new Sunfire product:

The Sunfire Corporation Warranty for the Cinema Grand Amplifier is in effect for FIVE years from the date of original retail purchase. The Sunfire Corporation Warranty covers defects in materials and workmanship. The following, however, are excluded:

- a) Damage caused during shipment.
- b) Damage caused by accident, misuse, abuse of operation contrary to the instructions specified in the Sunfire Corporation user's manual.
- c) Units where the serial number has been defaced, modified or removed.
- d) Damage resulting from modification or attempted repair by any person not authorized in writing by Sunfire Corporation.
- e) Units purchased from unauthorized dealers.

The Sunfire Corporation Warranty extends to the original owner or subsequent owner(s) during the five year warranty period, so long as the original dated purchase receipt is presented whenever warranty service is required.

All implied warranties, including warranties or merchantability and fitness for particular purposes, are limited in duration to the five year length of this Warranty, unless otherwise provided by state law.

Sunfire Corporation's liability is limited to the repair or replacement, at our option, of any defective product and shall not in any event include property or any other incidental or consequential damages which may result from the failure of this product.

Some states do not allow limitations on how long an implied warranty lasts and/or do not allow the exclusion or limitation of incidental or consequential damages, so the above limitations or exclusions may not apply to you.

This Warranty gives you specific legal rights, and you may also have other rights which vary from state to state. We suggest that you attach your purchase receipt to this Warranty and keep these in a safe place. Thank you for your choice of a Sunfire Corporation product.

Service Assistance

We suggest that you read the Limited Warranty completely to fully understand your Warranty/Service coverage.

If your Sunfire Corporation product ever requires service, write to us or call:

Sunfire Corporation
Technical Services Department
P.O. Box 1589
Snohomish, WA 98291
Tel (425) 335-4748
Fax (425) 335-4746

You will be directed to an authorized Sunfire Corporation Service Station or receive instructions to ship the unit to the factory. Please save the original shipping carton and packing materials in case shipping is required. Please do not ship Parcel Post.

NOTE: Before sending in your unit for repair, you must call Sunfire for return authorization.

Include a complete description of the problem, indicating how you have it connected, the associated equipment in your system and a copy of your purchase receipt. Initial shipping costs are not paid by Sunfire Corporation; return ground shipping costs will be prepaid if repairs were covered by the scope of this Warranty.

Bob Carver's
Sunfire

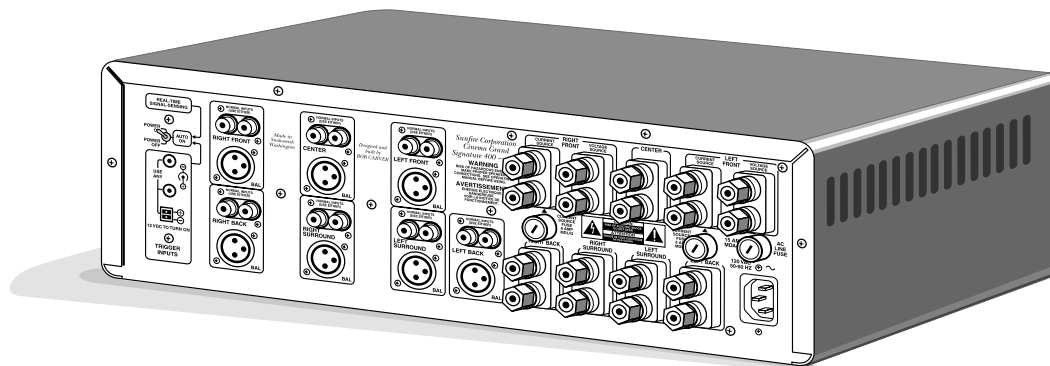

Cinema Grand

*Signature 400 ~ seven
and 200 ~ seven*

*Sunfire Corporation
P.O. Box 1589
Snohomish
WA 98291*

seven

Manual part number : 913-115-00 Rev A

Free Manuals Download Website

<http://myh66.com>

<http://usermanuals.us>

<http://www.somanuals.com>

<http://www.4manuals.cc>

<http://www.manual-lib.com>

<http://www.404manual.com>

<http://www.luxmanual.com>

<http://aubethermostatmanual.com>

Golf course search by state

<http://golfingnear.com>

Email search by domain

<http://emailbydomain.com>

Auto manuals search

<http://auto.somanuals.com>

TV manuals search

<http://tv.somanuals.com>