



NexStar[®] HX4

Quad 3.5" SATA to USB 3.0 & eSATA
External Hard Drive Enclosure w/ Fan



USB 3.0 & eSATA

MORE to STORE



MUSIC GAME PHOTO MOVIE

USER'S MANUAL

Package Contents:

Quad 3.5" SATA to USB 3.0 & eSATA External Hard Drive Enclosure w/ Fan

- ① NexStar HX4 Enclosure
- ② USB 3.0 Cable
- ③ eSATA Cable
- ④ Power Adapter
- ⑤ User's Manual

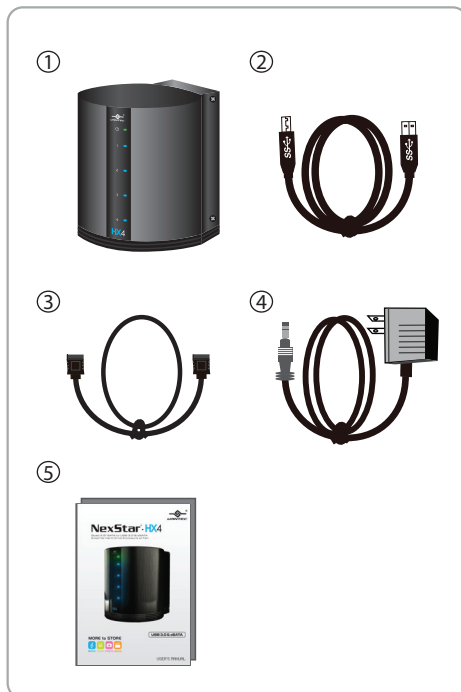

TRADEMARKS

MS-DOS, Microsoft, Windows NT/2000/XP/Vista/7 are trademarks of Microsoft Corporation.

Apple, Macintosh and Mac are trademarks of Apple Computer.

NexStar is a registered trademark of Vantec Thermal Technologies.

*All other third-party brands and names are the property of their respective owners.

Table of Contents:

1. Introduction	02
2. Specifications/Features	03
3. System Requirements	04
4. Parts Layout	05
5. Installation	06
6. Disconnecting the NexStar HX4	09
7. Hardware Formatting Guide	10
8. Warranty	13
10. Contact	13

1.Introduction:

Introducing the NexStar HX4 – a quad 3.5" SATA to USB 3.0 & eSATA External Hard Drive Enclosure designed to keep all your hard drive safe and cool. This enclosure features a hard aluminum shell that effectively draws away the heat while an active controlled 80mm fan on top exhausts the hot air from the enclosure ensuring your hard drive is protected and cooled. Integrated with USB 3.0 & eSATA technology; transfer files to and from your computer at blazing fast speeds. Backup, transfer, copy your data quick and easily with the Vantec NexStar HX4 enclosure.



2. Specifications/Features:

Quad 3.5" SATA to USB 3.0 & eSATA External Hard Drive Enclosure w/ Fan

Features:

- Aluminum Casing Cools Down Your Hard Drive
- Vents To Intake Cool Air
- Maximum Transfer Rates Up to 5 Gbps w/USB 3.0
- Maximum Transfer Rates Up to 3Gbps w/eSATA
- Active Large 80mm Fan To Exhaust Heat
- Easily Add Storage to Any System with USB 2.0, 3.0 or eSATA
- Backwards-Compatible with USB 2.0 or 1.1
- Hot-Swappable: Plug & Play Without Rebooting
- Attractive LED Indicates Power & HDD Activity

Specifications:

- Model: NST-640SU3-BK
- Device Support: SATA I/II Hard Drives
- Device Size: 3.5"
- Internal Interface: SATA
- External Interface: USB 3.0 & eSATA
- HDD Capacity: Up To 12TB*
- Power Supply: AC Adapter
- Fan: 80mm
- Material: Aluminum & Plastic
- Dimension: 209 x 170 x 181 mm

*Check our website www.vantecusa.com for any updates

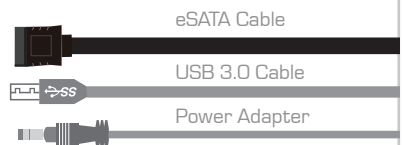

3.System Requirements:



Microsoft Windows XP/Vista/7

1. For USB 2.0 speeds, the system must support USB 2.0 specifications
2. For USB 3.0 speeds, the system must support USB 3.0 specifications
3. For eSATA Speeds, the System Must Support eSATA Specifications
4. Port Multiplier Is Required For eSATA



Mac OS 10.4 & greater

1. For USB 2.0 speeds, the system must support USB 2.0 specifications
2. For USB 3.0 speeds, the system must support USB 3.0 specifications
3. For eSATA Speeds, the System Must Support eSATA Specifications
4. Port Multiplier Is Required For eSATA

4.Parts Layout:

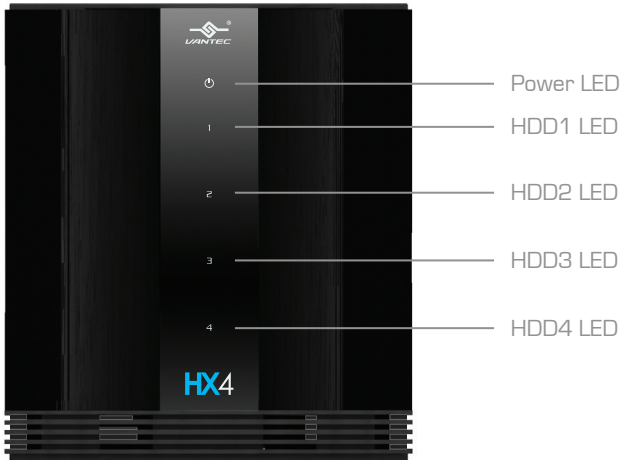

Parts Layout

5. Installation:

Quad 3.5" SATA to USB 3.0 & eSATA External Hard Drive Enclosure w/ Fan

5.1. Hardware Installation:

Installing the hard drive:

(1) Push lock to the left to unlock the HDD tray. (figure 5.1-A)



(figure 5.1-A)

(2) Take out the HDD tray
(figure 5.1-B)



(figure 5.1-B)

(3) Carefully install the hard drive into the tray. Be sure the fasten the screws firmly to the tray.

(figure 5.1-C)

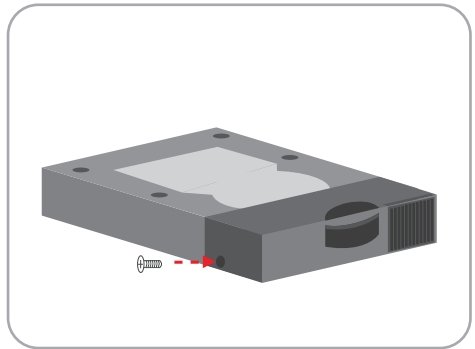

(figure 5.1-C)

(4) Reinsert the HDD tray into the case. (figure 5.1-D)



(figure 5.1-D)

(5) Push lock to the right to lock the HDD tray. (figure 5.1-E)

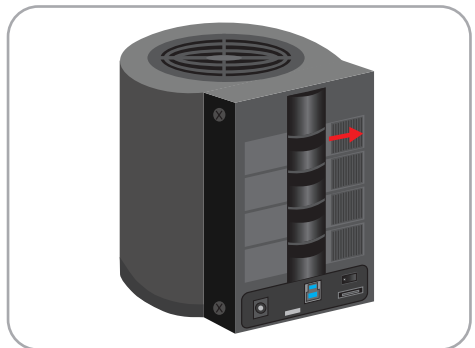

(figure 5.1-E)

Installation

Connecting the NexStar to your computer:

USB 3.0

- (1) Connect the type (B) USB connector to the NexStar and the type (A) USB connector to an available USB port on your system.
- (2) Connect the power cable to the NexStar and plug the cable into an available outlet. Turn on the NexStar via the power switch
- (3) Your operating system should detect the NexStar and automatically install the necessary drivers.
- (4) Once your operating system finishes setting up the NexStar, it will mount your hard drive. On Mac OS systems, the new volume should appear on desktop. On a Windows PC, the new volume will appear under My Computer.
- (5) Your NexStar External Hard Drive is now ready for use.

NOTE:

For new hard drives, you will need to initialize and partition your hard drive before it will appear in Windows Explorer or on your Mac desktop. Please refer to your hard drive manufacturer's documentation or read the "Creating a New Partition" section of this manual.

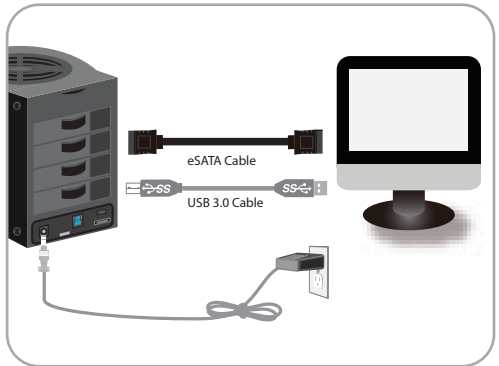

eSATA

- (1) Connect the eSATA to the NexStar and to an available eSATA port on your system.
- (2) Connect the power cable to the NexStar and plug the cable into an available outlet.
- (3) Turn on the NexStar via the power switch.
- (4) Your operating system should detect the NexStar and automatically install the necessary drivers. Once your operating system finishes setting up the NexStar, it will mount your hard drive. On Mac OS systems, the new volume should appear on desktop. On a Windows PC, the new volume will appear under My Computer.
- (5) Your NexStar External Hard Drive is now ready for use.

NOTE:

If you can see the USB icon in the system tray, but there is no any disk appear in your computer, please confirm your hard disk is partitioned.

6. Disconnecting the NexStar HX4:

Quad 3.5" SATA to USB 3.0 & eSATA External Hard Drive Enclosure w/ Fan



Microsoft Windows XP/Vista/7:

Make sure all operations using the hard drive within the NexStar has ceased.

Close any windows and programs pertaining to the NexStar

Double click the green "Safely Remove Hardware" icon in the system tray and select [Safely Remove USB Mass Storage Device]. Select the device you wish to remove and click on [Stop]. The system should prompt, "It is now safe to remove the USB device." If not, wait for any programs still using the device to finish and try again.

You may now safely turn off and disconnect the NexStar.

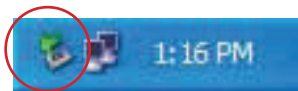

Mac OS:

Make sure all operations using the hard drive within the NexStar has ceased.

Close any windows and programs pertaining to the NexStar

From the Desktop, drag the NexStar hard drive to the trash.

You may now safely turn off and disconnect the NexStar.



⚠ WARNING:

NEVER remove the NexStar while the hard drive is in use. Doing so may corrupt the data on the hard drive or damage the hard drive, NexStar and the computer.

7.Hard Drive Formatting Guide

Quad 3.5" SATA to USB 3.0 & eSATA External Hard Drive Enclosure w/ Fan

- You may format your Hard Drive by using the USB connection.
- Please make sure your External Enclosure is turned on and connected to the PC before formatting the Hard Drive.

In order to use a disk volume larger than 2 TB's, you will need an operating system that supports GUID Partitioning Table. Windows 7, Windows Vista, Windows XP 64bit, Mac 10.4, and Mac 10.5 all have this capability through the GPT. The GUID partitioning scheme has the ability to partition both internal and external drives far beyond 2 TB's in size.

STEP1: Right-click "My Computer" and select "Manage".

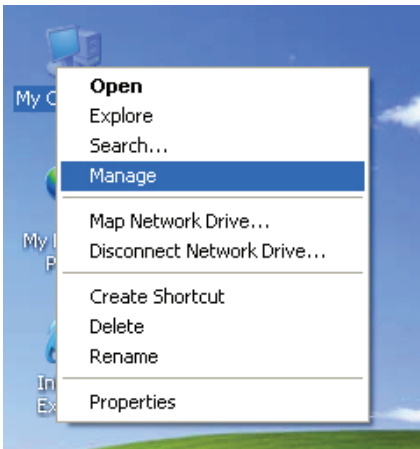

STEP2: Select "Disk Management" and you will see your Hard Drive shown as "Unallocated" (Disk number may vary)

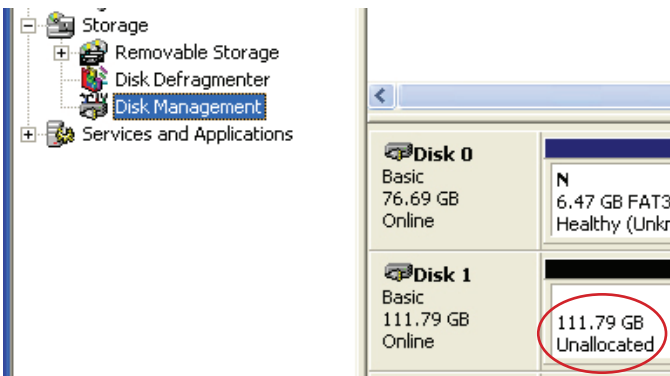

STEP3: Right-click on the “Unallocated” box and select “New Partition”.
(Disk number may vary)

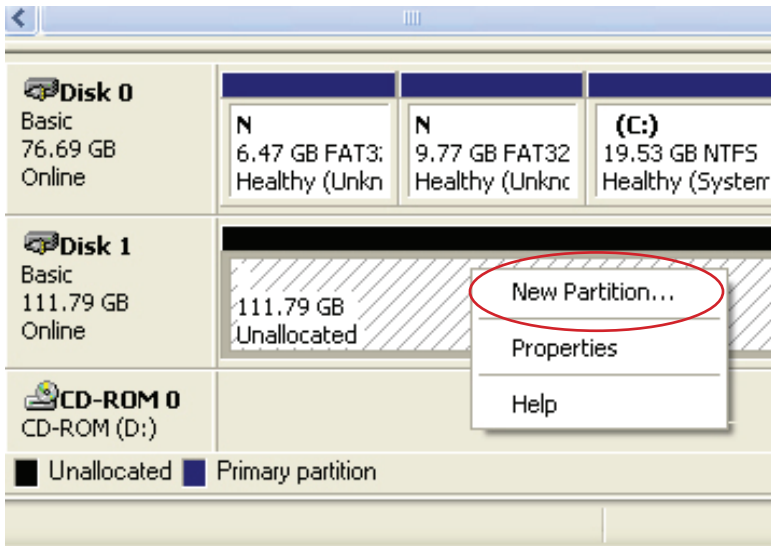

STEP4: The “New Partition Wizard” will appear. Please follow the “New Partition Wizard” step by step instructions to complete the Hard Drive formatting procedure

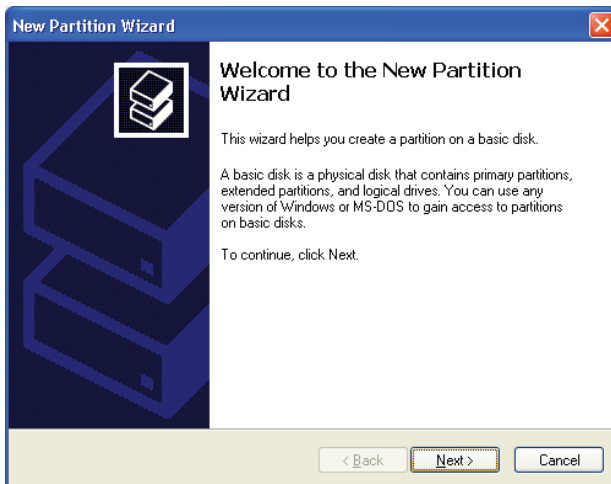

STEP5: Once the Hard Drive formatting procedure is completed, the Hard Drive will be recognized as a "New Volume" (New Volume drive letter may vary i.e. "New Volume (Z:)")

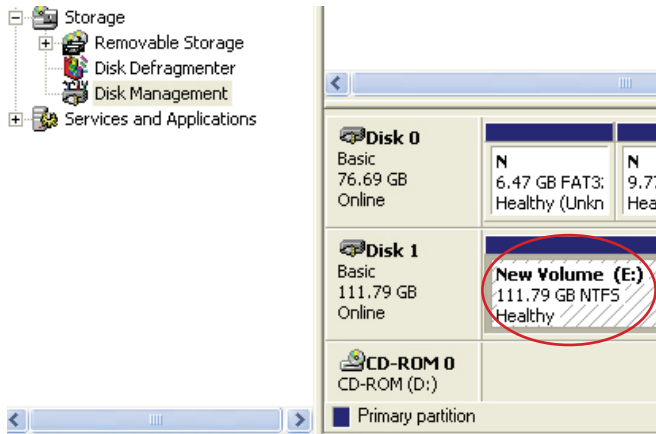

STEP6: Double-click "My Computer". You will see "New Volume" appear on your PC (Drive letter may vary i.e. "New Volume (Z:)")

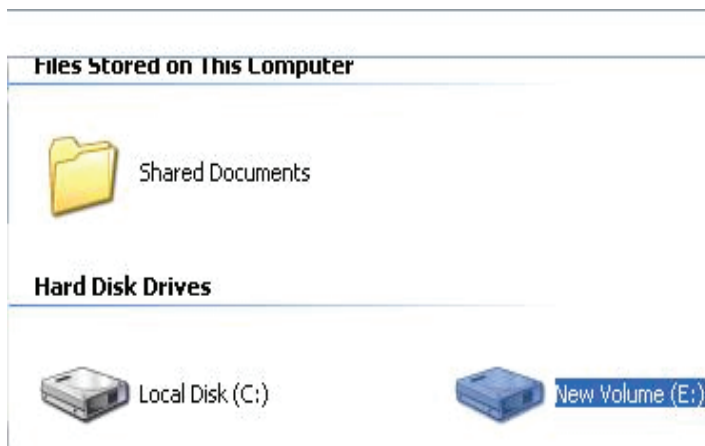

This will conclude the Hard Drive Formatting guide.

8.Warranty:

The NexStar HX comes with a 1 year limited warranty (90 day parts) . If your unit should become defective within that time frame, please go to www.vantecusa.com for information on how to receive warranty exchange or repair. Cosmetic defects and missing parts are not covered under this warranty. Please check the contents of the unit to make sure you received all parts. Also, check for any cosmetic flaws. If any parts are missing or if there are cosmetic defects, please contact the retailer from which you purchased the unit immediately and ask for a replacement.

9.Contact:

Vantec Thermal Technologies

www.vantecusa.com

Copyright © 2011 Vantec Thermal Technologies. All Right Reserved.
All Registered Trademarks Belong To Their Respective Companies.

Warranty/Contact

Free Manuals Download Website

<http://myh66.com>

<http://usermanuals.us>

<http://www.somanuals.com>

<http://www.4manuals.cc>

<http://www.manual-lib.com>

<http://www.404manual.com>

<http://www.luxmanual.com>

<http://aubethermostatmanual.com>

Golf course search by state

<http://golfingnear.com>

Email search by domain

<http://emailbydomain.com>

Auto manuals search

<http://auto.somanuals.com>

TV manuals search

<http://tv.somanuals.com>