



Your Reliable Partner

# SI7 Series

(SI7, SI7-G)

---

*Socket 478 System Board*

*User's Manual*

4200-0346-02

Rev. 1.00

---

---

## **Copyright and Warranty Notice**

The information in this document is subject to change without notice and does not represent a commitment on part of the vendor, who assumes no liability or responsibility for any errors that may appear in this manual.

No warranty or representation, either expressed or implied, is made with respect to the quality, accuracy or fitness for any particular part of this document. In no event shall the manufacturer be liable for direct, indirect, special, incidental or consequential damages arising from any defect or error in this manual or product.

Product names appearing in this manual are for identification purpose only and trademarks and product names or brand names appearing in this document are the property of their respective owners.

This document contains materials protected under International Copyright Laws. All rights reserved. No part of this manual may be reproduced, transmitted or transcribed without the expressed written permission of the manufacturer and authors of this manual.

If you do not properly set the motherboard settings, causing the motherboard to malfunction or fail, we cannot guarantee any responsibility.

---

---

# Table Of Contents

---

SI7 系列快速安裝指引 .....	1
SI7 シリーズのクイックインストールガイド .....	3
SI7-Serie Schnellinstallationsanleitung .....	5
Série SI7 Guide d'Installation Rapide.....	7
Краткое руководство по установке SI7 серия .....	9
Guida all'installazione veloce Scheda madre serie SI7 .....	11
<b>Chapter 1. Introduction .....</b>	<b>1-1</b>
1-1. Features & Specifications .....	1-1
1-2. Layout Diagram .....	1-3
<b>Chapter 2. Hardware Setup.....</b>	<b>2-1</b>
2-1. Install The Motherboard.....	2-1
2-2. Install Pentium® 4 CPU and Heatsink Supporting-Base.....	2-2
2-3. Install System Memory .....	2-3
2-4. Connectors, Headers and Switches .....	2-5
(1). ATX Power Input Connectors [ATXPWR1, ATX12V1] .....	2-5
(2). FAN Connectors [CPUFAN1, SYSFAN1, AUXFAN1] .....	2-6
(3). CMOS Memory Clearing Header [CCMOS1] .....	2-7
(4). Front Panel Audio Connection Header [FP-AUDIO1] .....	2-8
(5). Additional USB Port Headers [FP-USB1, FP-USB2] .....	2-9
(6). Additional IEEE1394 Port Headers [FP-1394-1, FP-1394-2] .....	2-10
(7). Front Panel Switches & Indicators Headers [FP-IO1] .....	2-11
(8). System Management Bus Header [SMB1] .....	2-12
(9). Internal Audio Connectors [CD1, AUX1] .....	2-12
(10). Accelerated Graphics Port Slot [AGP1] .....	2-13
(11). Floppy Disk Drive Connector [FDC1] .....	2-14
(12). IDE Connectors [IDE1, IDE2].....	2-15
(13). Serial ATA Connectors [SATA1, SATA2].....	2-16
(14). POST Code Display [U32] .....	2-17
(15). Onboard Switches [FORWARD, BACK, PS_ON, RESET].....	2-20
(16). Status Indicators [D17, D14, D15, D18].....	2-21
(17). Back Panel Connectors [KM1, LPT1, COM1, COM2, OPT-OUT1, AUDIO1, AUDIO2, LAN, USB1].....	2-22

---

<b>Chapter 3. BIOS Setup</b> .....	<b>3-1</b>
3-1. SoftMenu Setup Features .....	3-2
3-2. Standard CMOS Features.....	3-4
3-3. Advanced BIOS Features.....	3-6
3-4. Advanced Chipset Features.....	3-8
3-5. Power Management Features .....	3-10
3-6. PnP/PCI Configurations .....	3-13
3-7. Integrated Peripherals .....	3-16
3-8. PC Health Status .....	3-21
3-9. Set Password .....	3-22
3-10. Load Optimized Defaults .....	3-22
3-11. Load Fail-Safe Defaults .....	3-22
3-12. Save & Exit Setup .....	3-22
3-13. Exit Without Saving.....	3-22
<i>Appendix A. Install SiS Chipset Driver</i> .....	<i>A-1</i>
<i>Appendix B. Install SiS IDE Driver</i> .....	<i>B-1</i>
<i>Appendix C. Install Audio Driver</i> .....	<i>C-1</i>
<i>Appendix D. Install LAN Driver</i> .....	<i>D-1</i>
<i>Appendix E. Install SiS USB 2.0 Driver</i> .....	<i>E-1</i>
<i>Appendix F. Install Serial ATA RAID Driver</i> .....	<i>F-1</i>
<i>Appendix G. BIOS Update Guide</i> .....	<i>G-1</i>
<i>Appendix H. Hardware Monitoring (The Winbond Hardware Doctor Utility)</i> ..	<i>H-1</i>
<i>Appendix I. Installation Guide for Suspend to RAM</i> .....	<i>I-1</i>
<i>Appendix J. Troubleshooting (Need Assistance?)</i> .....	<i>J-1</i>
<i>Appendix K. How to Get Technical Support</i> .....	<i>K-1</i>

## SI7 系列快速安裝指引

如您要瞭解此主機板更詳細的資訊，請參閱我們的完整版使用手冊，裡面會有詳盡的說明。此快速安裝手冊是給有經驗的系統組裝者使用，如果這是您第一次嘗試來組裝您的電腦系統，我們建議您先去閱讀完整版的使用手冊，或是詢問技術人員來幫助您組裝您的電腦系統（完整版的使用手冊已包覆在隨本主機板所附的驅動程式與應用光碟之中）。

### 處理器的安裝

本主機板提供零出力 (Zero Insertion Force, ZIF) 式 Socket 478，以方便安裝 Intel® Pentium® 4 CPU。您所購買的 CPU 應已配備一組散熱套件及散熱片，如果沒有，請購買專為 Pentium® 4 Socket 478 設計的散熱套件及散熱片。

1. 請找出 Socket 478 的位置，然後將散熱套件支座固定在主機板上。

**注意：**若果您使用專為 Pentium® 4 設計的底座，請注意底座上的金屬螺栓或墊片（若已安裝的話）。請確定金屬螺栓或墊片不會碰到印刷電路板上的電線或零件。

2. 請將 CPU 插座桿拉出至插座旁，然後將插座桿以 90 度角向上拉。請以正確的方向插入 CPU，由於只能朝著一個固定的方向插入 CPU，因此如果遇到阻礙時，切勿勉強用力。最後壓住 CPU，並且閉上插座桿。
3. 請將散熱裝置的正面向著 CPU 放入，直至完全蓋住 CPU 為止。
4. 將散熱裝置的支罩蓋在散熱裝置上。請確定支罩的每邊四個鎖扣都已鎖入鎖孔。
5. 將支罩兩側的固定夾往下壓，以夾緊支座。壓固定夾時，請注意壓按的方向。
6. 現在散熱支罩及支座應該已互相緊扣，而散熱裝置亦已裝妥在支罩內。

**注意：**請記得設定正確的處理器外頻和倍頻數值。

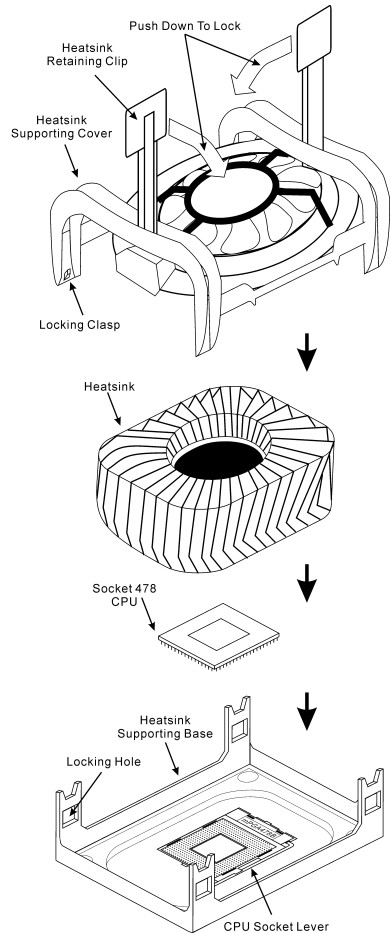

## 將主機板安裝到機殼上

當您將處理器安裝到主機板上之後，您就可以開始將主機板固定到電腦機殼裡去。首先；請您先將主機板固定到電腦機殼。大多數的電腦機殼底座都有許多的固定孔位，請將主機板上的固定孔位與機殼底座上的固定孔位對準。如果孔能對準並且有螺絲孔，就表示可使用銅柱來固定主機板。另外；您可以使用塑膠墊片來讓螺絲與主機板的 PCB 表層隔離（絕緣）。

## 安裝系統記憶體

本主機板提供 2 組 232 腳的 RIMM 插座可供記憶體擴充，可支援 RIMM 的最小記憶體大小為 128MB，而最大的記憶體大小則為 2GB。

將 RIMM 記憶體模組插入 RIMM 插槽。請注意記憶體模組的楔子是如何對應到 RIMM 插槽上的卡榫之上。此種設計可確保 RIMM 記憶體模組僅能由一個方向插到 RIMM 插槽之上。當您將 RIMM 記憶體模組完全插入 RIMM 插槽時，模組退出（固定）夾應該會將 RIMM 記憶體模組自兩側卡緊並緊緊地固定住記憶體模組。

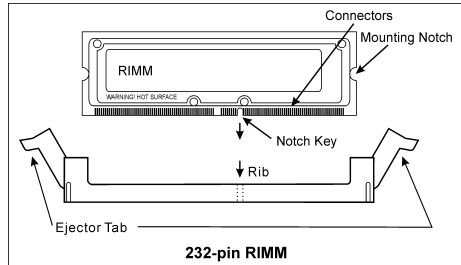

## 連接器、連接頭以及附加卡的安裝

在任何一部電腦機殼的裡面，都必需連接一些纜線與插頭。這些纜線與插頭通常都是一對一的連接至主機板的連接埠上，您必需注意任何一條纜線的連接方向。如果可能的話，請一併注意連接埠第一根針腳的位置。您將會安裝一些特殊功能的附加卡到主機板上，像是 SCSI 卡或是 AGP 顯示卡等等。當您將它們安裝到主機板上適當的插槽之後，請以螺絲將這些附加卡與機殼背板牢牢地固定好，避免有鬆動的情況發生。

如您想要瞭解相關且更為詳細的資訊，請參閱我們的完整版使用手冊，裡面會有詳盡的說明。

## 將電源供應器的電源線連接頭與主機板上的 ATX12V 電源接頭連接起來

請將電源供應器的 ATX 電源接頭確實地壓入主機板上的 ATX12V 電源接頭，並確定連接妥當。

## BIOS 的設定

當您將所有的硬體安裝完畢以後，就可以開啓電腦的電源並進入 BIOS 的選項。如您想要瞭解相關且更為詳細的資訊，請參閱我們的完整版使用手冊，裡面會有詳盡的說明。

## SI7 シリーズのクイックインストールガイド

このマザーボードの詳細については、ユーザーズマニュアルの完全版を参照してください。このクイックインストールガイドは、経験あるシステム構築者向けに書かれました。今回初めてコンピュータシステムをセットアップする方は、まず完全版のマニュアルをお読みになるか、専門技術者に連絡してコンピュータシステムのセットアップを行うようお勧めします(完全な利用者マニュアルはこのマザーボードによって詰められて来たドライバとユーティリティの CD の拾い読みによって利用できる)。

### プロセッサの取り付け

このマザーボードは ZIF (ゼロインサージョンフォース) Socket 478 を提供して Intel® Pentium® 4 CPU をインストールします。お買い上げになった CPU には、ヒートシンクと冷却ファンのキットが付属しています。付属していない場合、Pentium® 4 Socket 478 向けに特別に設計されたキットをお求めください。

1. Socket 478 を設置します。ヒートシンクをマザーボード上のサポート台に固定してください。

**注意:** Pentium® 4 向けに特別に設計されたシャーシをお使いの場合、金属スタッドやスペーサがすでにインストールされている場合、それらの場所に注意してください。金属スタッドやスペーサがプリント基板線や PCB の部品に触れないように気をつけてください。

2. CPU のソケットレバーをソケットから横方向に引いて、90 度上に持ち上げます。CPU を正しい方向に挿入します。CPU を挿入する際、余分な力を入れないでください。1 方向にだけ適合します。CPU を下に押しながら、ソケットレバーをクローズします。
3. ヒートシンクの面が CPU を完全に覆うまで、CPU の上に下ろします。
4. ヒートシンクのサポートカバーをヒートシンクに置きます。サポートカバーの各面の 4 本の留め金がすべて固定穴に届いていることを確認してください。
5. サポートカバーの両側の支持クリップを下に押し、サポート台と共に固定します。クリップを下に押しときに方向に注意してください。
6. ヒートシンクのサポートカバーと台は、ヒートシンクの内側でお互いにしっかりと固定されている必要があります。

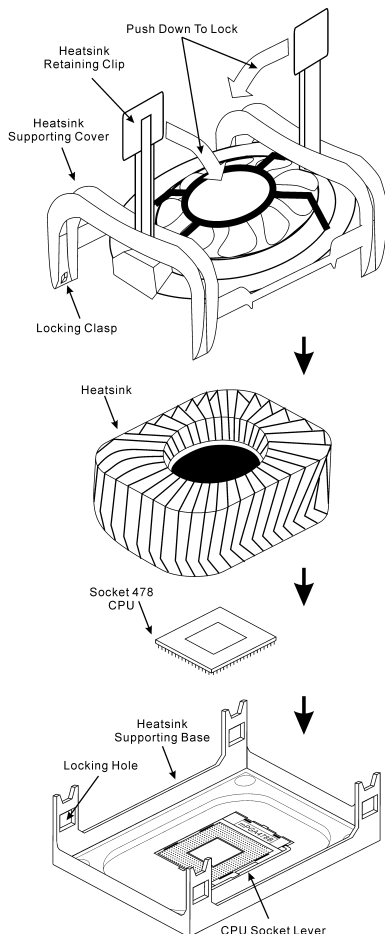

**注意：** プロセッサに対して、正しいバス周波数とマルチプルに設定することを忘れないでください。

### マザーボードをシャーシに取り付ける

マザーボードにプロセッサを取り付けた後、シャーシにマザーボードを固定することができるようになります。まず、シャーシにマザーボードを固定する必要があります。ほとんどのコンピュータシャーシには、多くの取り付け穴の付いた台が付属しており、それを使用することでマザーボードをしっかりと取り付けたり、同時にショートを避けることができます。シャーシに付属する飾りボタンかスペーサーを使用してマザーボードを固定します。

### システムメモリの取り付け

このマザーボードでは、2つの232ピンRIMMスロットメモリ拡張を提供します。最小メモリは128MBで、最大メモリは2GB RIMMです。

RIMMを図に示すように拡張スロットに差し込みます。モジュールがソケットにどのように固定されているか注意してください。これにより、RIMMモジュールに差し込む方法が1つしかないことを確認できます。RIMMモジュールをRIMMソケットにしっかりと押し込み、モジュールがRIMMソケットに完全に差し込まれていることを確認します。

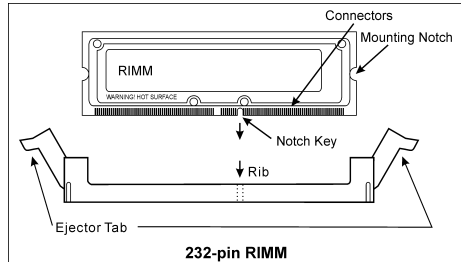

### コネクタ、ヘッド、スイッチおよびアダプタ

コンピュータのケース内部には、複数のケーブルやプラグを接続できます。これらのケーブルやプラグは、通常マザーボードにあるコネクタに1つずつ接続されます。ケーブルの接続方向には十分な注意を払い、また必要に応じ、コネクタの第1ピンの位置にも注目する必要があります。SCSIアダプタ、AGPアダプタのような特殊なニーズ向けには、それに対応したアダプタを取り付けてください。アダプタをマザーボードのスロットに取り付けたら、ネジでシャーシの背面パネルに固定してください。

詳細については、ユーザズマニュアルの完全版を参照してください。

### 電源コネクタを ATX12V 電源コネクタに差し込む

電源装置から出ている電源ブロックコネクタをこの ATX12V 電源に接続します。コネクタが十分奥まで装着されていることをご確認ください。

### BIOS のセットアップ

ハードウェアの取り付けが完了したら、コンピュータの電源をオンにし、BIOS Setup アイテムに移動して、プロセッサのパラメータをセットアップします。詳細については、ユーザズマニュアルの完全版を参照してください。



## SI7-Serie Schnellinstallationsanleitung

Beziehen Sie sich bitte für detaillierte Informationen über diese Hauptplatine auf die vollständige Version des Benutzerbuchs. Diese Schnellinstallationsanleitung ist für erfahrene Systemaufbauer gedacht. Ist es Ihr erster Versuch ein Computersystem aufzubauen, dann empfehlen wir Ihnen zuerst das vollständige Benutzerhandbuch zu lesen oder einen Techniker zum Aufbauen des Systems zu Hilfe zu holen (A complete user's manual is available via browsing the Driver & Utilities CD that came packed with this motherboard.).

### Installieren des Prozessors

Dieses Motherboard verfügt über einen ZIF (Zero Insertion Force) Sockel 478 zur Installation eines Intel® Pentium® 4 CPU. Ihre CPU sollte über ein Kühlblech und einen Lüfter verfügen. Wenn dies nicht der Fall ist, kaufen Sie bitte diese Teile speziell für den Pentium® 4 Sockel 478.

1. Finden Sie den Socket 478. Bringen Sie die Basis des Kühlblechs am Motherboard an.

**Achtung:** Wenn Sie ein speziell für den Pentium® 4 entworfenes Gehäuse verwenden, achten Sie bitte auf die Lage der Metallbolzen oder Abstandhalter, falls diese schon im Gehäuse angebracht sind. Achten Sie darauf, diese Metallbolzen bzw. Abstandhalter nicht in Kontakt mit den gedruckten Schaltkreisen oder Teile auf dem PCB kommen zu lassen.

2. Ziehen Sie den CPU-Sockelhebel seitlich vom Sockel weg und dann nach im 90°-Winkel nach oben. Setzen Sie die CPU in der korrekten Ausrichtung ein. Wenden Sie beim Einsetzen der CPU keine Gewalt an; sie passt nur in eine Richtung in den Sockel. Schließen Sie den Sockelhebel wieder, während Sie die CPU nach unten gedrückt halten.
3. Setzen Sie das Kühlblech mit der Vorderseite nach unten auf die CPU, bis es die CPU komplett abdeckt.
4. Setzen Sie die Kühlblechabdeckung auf das Kühlblech. Achten Sie darauf, dass die vier Verschlüsse auf jeder Seite der Kühlblechabdeckung völlig in den Verschlusslöchern sitzen.
5. Drücken Sie die Halteklammern an beiden Seiten der Halteklammern, bis sie mit der Basis verriegelt sind. Achten Sie beim Herunterdrücken der Klammern auf die Richtung.
6. Kühlblechabdeckung und -basis sollten nun fest miteinander das Kühlblech umschließen.

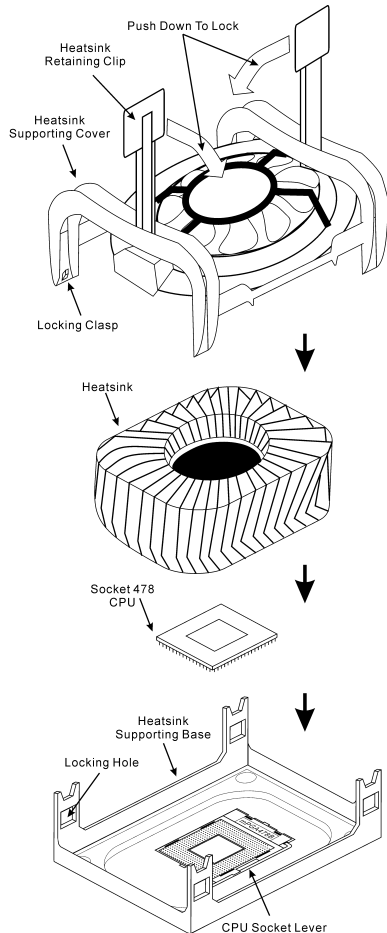

**Achtung:** Vergessen Sie nicht, die korrekte Busfrequenz und Multiplikator für Ihren Prozessor einzustellen.

### **Installieren der Hauptplatine im Gehäuse**

Nach der Installation des Prozessors können Sie anfangen die Hauptplatine im Computergehäuse zu befestigen. Die meisten Gehäuse haben eine Bodenplatte, auf der sich eine Reihe von Befestigungslöcher befinden, mit deren Hilfe Sie die Hauptplatine sicher verankern können und zugleich Kurzschlüsse verhindern. Verwenden Sie entweder die Dübeln oder die Abstandhalter, um die Hauptplatine auf der Bodenplatte des Gehäuses zu befestigen.

### **Installieren des Arbeitsspeichers**

Diese Hauptplatine bietet 2 232-polige RIMM-Steckplätze an. Sie können minimal 128MB und maximal 2GB RIMM einbauen.

Stecken Sie das RIMM-Modul in den Speichersteckplatz ein, wie in der Abbildung dargestellt. Achten Sie darauf, wie die Kerbe des Moduls in den Steckplatz passt. So ist sichergestellt, dass das RIMM-Modul nur in eine Richtung in den Steckplatz eingesteckt werden kann. Drücken Sie das RIMM-Modul fest in den RIMM-Steckplatz, bis es komplett und fest darin sitzt.

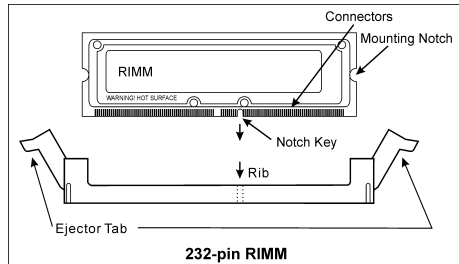

### **Anschlüsse, Sockel, Schalter und Adapter**

Im Inneren des Gehäuses findet man in jedem Computer viele Kabel und Stecker, die angeschlossen werden müssen. Diese Kabel und Stecker werden normalerweise einzeln mit den Anschlüssen auf der Hauptplatine verbunden. Sie müssen genau auf die Anschlussorientierung der Kabel achten und, wenn vorhanden, sich die Position des ersten Pols des Anschlusses merken. Wenn Sie Adapter wie z.B. SCSI-Adapter, AGP-Adapter usw. installieren, befestigen Sie bitte die Adapter immer mit Hilfe der Schrauben auf die Rückseite des Computergehäuses.

Für detaillierte Informationen beziehen Sie sich bitte auf das vollständige Benutzerhandbuch.

### **Verbinden der Netzstecker mit dem ATX12V-Anschluss**

Denken Sie daran, den Anschluss des ATX-Netzteils fest in das Ende mit dem ATX12V-Anschluss zu drücken, um eine feste Verbindung zu garantieren.

### **BIOS-Setup**

Schalten Sie nach der vervollständigten Hardwareinstallation den Computer ein und gehen zur Option im BIOS, um die Prozessorparameter einzustellen. Für detaillierte Informationen beziehen Sie sich bitte auf das vollständige Benutzerhandbuch.

## Série SI7 Guide d'Installation Rapide

Pour des informations relatives à cette carte mère plus détaillées, veuillez vous référer à notre version complète du manuel utilisateur. Ce guide d'installation rapide est créé pour les assembleurs système expérimentés. S'il s'agit de votre premier essai pour installer un ordinateur, nous vous suggérons de lire d'abord le manuel en version complète ou de demander l'aide d'un technicien pour vous aider à configurer le système ordinateur (A complete user's manual is available via browsing the Driver & Utilities CD that came packed with this motherboard).

### Installer le Processeur

Cette carte mère fournit un support ZIF (Zero Insertion Force) Socket 478 permettant d'installer le Microprocesseur Intel® Pentium® 4. Le microprocesseur que vous achetez doit être muni d'un système de refroidissement avec dissipateur thermique et ventilateur. Dans le cas contraire, veuillez en acheter un, conçu spécialement pour les microprocesseurs Pentium® 4 Socket 478.

1. Placez le Socket 478. Fixez la base support du dissipateur thermique sur la carte mère.

**Attention:** Si vous utilisez un châssis conçu spécialement pour Pentium® 4, veuillez faire attention à l'emplacement des clous ou spacers métalliques si ceux-ci sont déjà installés sur le châssis. Faites attention de ne pas laisser les talons (studs) ou entretoises(spacers) métalliques en contact avec des fils ou des parties de circuit imprimé se trouvant sur le PCB.

2. Tirez de côté le levier de l'emplacement du CPU et tirez-le vers le haut à 90 degrés. Insérez le Microprocesseur en respectant une bonne orientation. Ne pas utiliser une force excessive en insérant le CPU; il s'installe uniquement dans une position. Fermez le levier d'emplacement en maintenant le Microprocesseur en place.
3. Mettez le dissipateur thermique face au microprocesseur jusqu'à ce qu'il le couvre complètement.
4. Mettez le couvercle support du dissipateur thermique sur le dissipateur thermique. Assurez-vous que les quatre verrous situés sur chaque côté du couvercle support vont bien dans les trous de verrouillage.
5. Poussez les attaches de maintenance se trouvant de chaque côté du couvercle support pour le rendre solidaire de la base support. Faites à la direction en poussant les attaches.

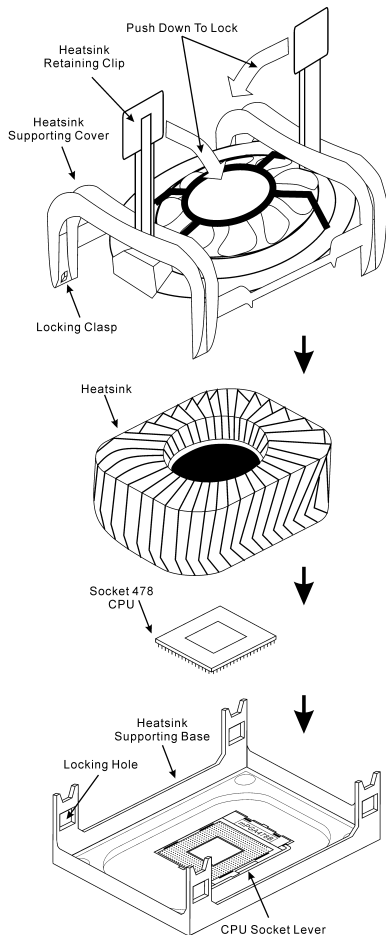

6. Le couvercle support et la base du dissipateur thermique doivent maintenant être fermement fixés l'un à l'autre fermement avec le dissipateur thermique à l'intérieur.

**Attention:** N'oubliez pas de régler une fréquence de Bus et un coefficient multiplicateur corrects pour votre processeur.

### **Installer la Carte Mre dans le Châssis**

Une fois que vous aurez installé le processeur sur la carte mère, vous pourrez commencer à fixer la carte mère sur le châssis. Tout d'abord, vous avez besoin de fixer la carte mère sur le châssis. La plupart des châssis d'ordinateur possèdent une base sur laquelle il y a nombreux trous de montage permettant à la carte mère d'être fixée fermement, et en même temps d'éviter les court-circuits. Utilisez les talons ou les entretoises fixés sur le châssis pour fixer la carte mère.

### **Installer la Mémoire Système**

Cette carte mère dispose de 2 emplacements RIMM 232-broches pour les extensions mémoire. La mémoire minimum est de 128MB et la mémoire maximum est de 2GB RIMM.

Insérez le module RIMM dans l'emplacement d'extension comme illustré dans le schéma. Notez comment le module est verrouillé dans l'emplacement. Ceci assure qu'il n'y qu'une manière d'insérer le module RIMM. Pressez fermement le module RIMM dans l'emplacement RIMM; assurez-vous que le module est installé complètement dans l'emplacement RIMM.

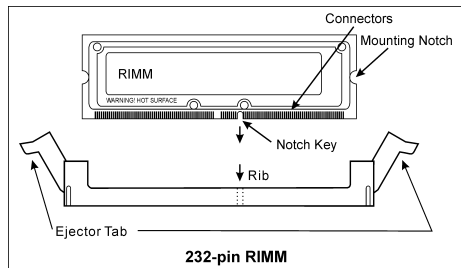

### **Connecteurs, Socles de connexion, Interrupteurs et Adaptateurs**

A l'intérieur du boîtier de n'importe quel ordinateur il y a plusieurs câbles et prises qui doivent être connectés. Ces câbles et prises sont habituellement connectés les uns après les autres aux connecteurs situés sur la carte mère. Vous avez besoin de faire attention au sens de connexion des câbles et, s'il y a lieu, remarquez la position de la première broche du connecteur. Vous installerez certains adaptateurs pour des besoins spéciaux, tels adaptateurs SCSI, adaptateurs AGP, etc. Lorsque vous les installez dans les emplacements situés sur la carte mère, veuillez les fixer sur le panneau arrière du châssis à l'aide des vis.

Pour les informations détaillées, veuillez vous référer au manuel utilisateur en version complète.

### **Brancher les connecteurs d'alimentation dans les connecteurs ATX12V**

Souvenez-vous que vous devez pousser le connecteur de votre alimentation fermement dans le connecteur ATX12V pour assurer une bonne connexion.

### **Configuration du BIOS**

Une fois le matériel installé complètement, démarrez l'ordinateur et allez sur l'item dans le BIOS pour configurer les paramètres du processeur. Pour les informations détaillées, veuillez vous référer à la version complète du manuel utilisateur.

## Краткое руководство по установке SI7 серия

Более подробные сведения о материнской плате приведены в руководстве пользователя. Краткое руководство по установке предназначено для опытных специалистов. Если вы собираете компьютер впервые, ознакомьтесь сперва с руководством пользователя или попросите техника помочь в настройке компьютерной системы.

### Установка процессора

На этой системной плате используется гнездо ZIP (с нулевым усилием установки) типа 'Socket 478' для процессора Intel® Pentium® 4. В комплект приобретаемого процессора должны входить радиатор и вентилятор. В противном случае следует приобрести радиатор и вентилятор, предназначенные для процессора Pentium® 4 с разъемом 'Socket 478'.

1. Найдите на плате гнездо 'Socket 478'. Зафиксируйте крепежное основание радиатора на системной плате.

**Внимание:** При использовании корпуса специально предназначенного для Pentium® 4 обратите внимание на расположение металлических вставок или распорок, если они уже установлены в корпус. Не допускайте контакта металлических вставок или распорок с проводниками или деталями печатной платы.

2. Сместите рычаг гнезда процессора в сторону от гнезда, а затем поверните его вверх на 90 градусов. Вставьте процессор, ориентируя его надлежащим образом. Устанавливая процессор, не прикладывайте чрезмерных усилий. Его установка возможна только в одном положении. Прижав процессор сверху, опустите рычаг гнезда.
3. Поместите радиатор плоской стороной на процессор так, чтобы процессор был полностью закрыт.
4. Поместите прижимную крышку радиатора на радиатор. Все четыре фиксатора по обеим сторонам прижимной крышки должны находиться на уровне крепежных отверстий.
5. Прижмите вниз фиксирующие зажимы по обеим сторонам прижимной крышки до их фиксации в крепежном основании. Следите за направлением, в котором Вы прижимаете зажимы.
6. Крышка и основание должны быть надежно скреплены, фиксируя радиатор.

**Внимание:** Не забудьте установить для процессора надлежащую частоту шины и множитель.

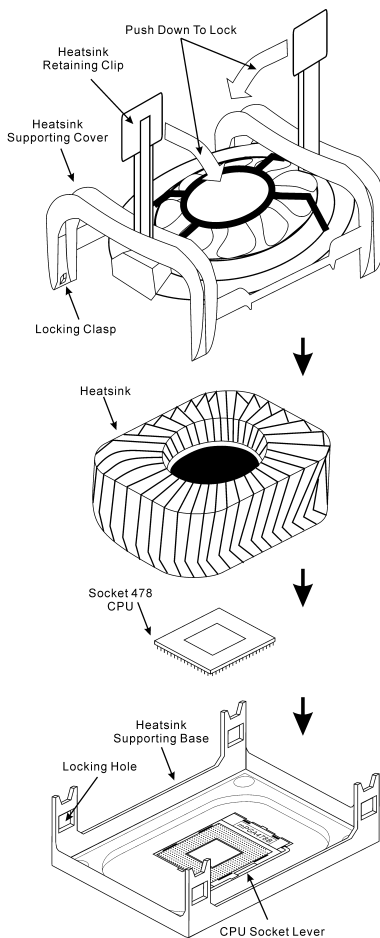

### **Установка материнской платы в корпус**

После установки процессора на материнскую плату можно начинать установку материнской платы в корпус. Большая часть корпусов оборудована основанием, в котором проделаны монтажные отверстия, которые позволяют надежно закрепить материнскую плату и предотвратить короткие замыкания. Для крепления материнской платы к основанию используются винты и прокладки.

### **Установка модулей памяти**

На плате имеется 2 232-контактных гнезда расширения RIMM для памяти. Минимальный объем памяти равен 128 Мбайт, максимальный объем равен 2 Гбайт RIMM.

Установите модуль памяти RIMM в гнездо расширения, как показано на рисунке. Обратите внимание, что модуль фиксируется в гнезде. Таким образом, гарантируется единственно возможный способ установки модуля RIMM. Вставьте модуль RIMM в гнездо RIMM; и убедитесь, что модуль надежно установлен в гнездо RIMM.

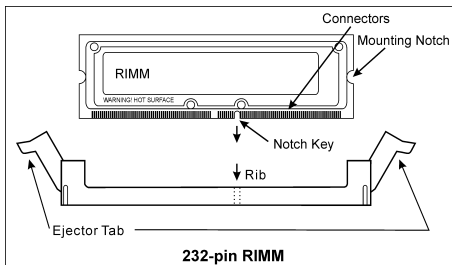

### **Разъемы, переключатели и адаптеры**

Внутри корпуса компьютера необходимо расположены несколько кабелей и вилок, которые необходимо подключить. Обычно эти кабели подключаются к разъемам, расположенным на материнской плате. При подключении любого кабеля необходимо обращать внимание на расположение первого контакта разъема. Для особых целей могут потребоваться специальные адаптеры, например, адаптер SCSI, адаптер AGP и т.п.. При установке адаптеров в гнезда материнской платы закрепите их на задней панели с помощью винтов.

За более подробной информацией обращайтесь к полному руководству пользователя.

### **Подключение кабелей питания к разъемам ATX12V**

Обратите внимание, разъем блока питания ATX необходимо вставить в разъем ATX12V до упора, чтобы обеспечить надежное соединение.

### **Настройка BIOS**

По окончании установки аппаратуры включите питание и перейдите в меню BIOS Setup, чтобы настроить параметры процессора. За более подробной информацией обращайтесь к руководству пользователя.

## Guida all'installazione veloce Scheda madre serie SI7

Per maggiori e dettagliate informazioni su questa scheda madre si prega di fare riferimento alla versione integrale del Manuale utente. Questa guida all'installazione veloce è intesa per costruttori esperti di sistemi. Se questa è la prima volta che si cerca di installare un sistema, si consiglia di leggere, innanzi tutto, la versione integrale del manuale oppure di chiedere aiuto ad un tecnico per l'installazione.

### Installazione del processore

Questa scheda madre fornisce una presa "Socket 478" ZIF (Zero Insertion Force – forza d'inserimento zero) per installare il processore Intel® Pentium® 4. Il processore acquistato dovrebbe essere fornito di dispersore di calore e ventolina per il raffreddamento. In caso contrario acquistare un dispersore di calore specifico per la presa Socket 478 Pentium®.

1. Localizzare la presa Socket 478. Fissare la base di supporto dispersore di calore sulla scheda madre.

**Attenzione:** Se si impiega un telaio progettato specificatamente per il processore Pentium® 4, prestare attenzione all'ubicazione delle borchie in metallo o degli spaziatori, nel caso in cui siano già installati sul telaio. Assicurarsi di non permettere alle borchie in metallo od agli spaziatori di entrare in contatto con il cavo o con le parti del circuito stampato.

2. Tirare di lato la leva della presa del processore allontanandola dalla presa; poi sollevarla di 90 gradi. Inserire il processore con il corretto orientamento. Non sforzare per inserire il processore poiché si adatta solamente in un dato orientamento. Chiudere la leva della presa mentre si trattiene il processore.
3. Mettere il dispersore di calore a faccia in giù sul processore finché lo copre completamente.
4. Mettere il coperchio di supporto del dispersore di calore sul dispersore di calore. Assicurarsi che tutti quattro i fermagli, su ciascun lato del coperchio di supporto, si inseriscano nei fori di bloccaggio.
5. Spingere verso il basso i fermagli di bloccaggio su ciascun lato del coperchio di supporto in modo da fissarlo alla base di supporto. Prestare attenzione alla direzione in cui si spingono i fermagli.
6. Il coperchio di supporto e la base del dispersore di calore dovrebbero ora essere fissate saldamente l'uno all'altra, contenendo al loro interno il dispersore di calore.

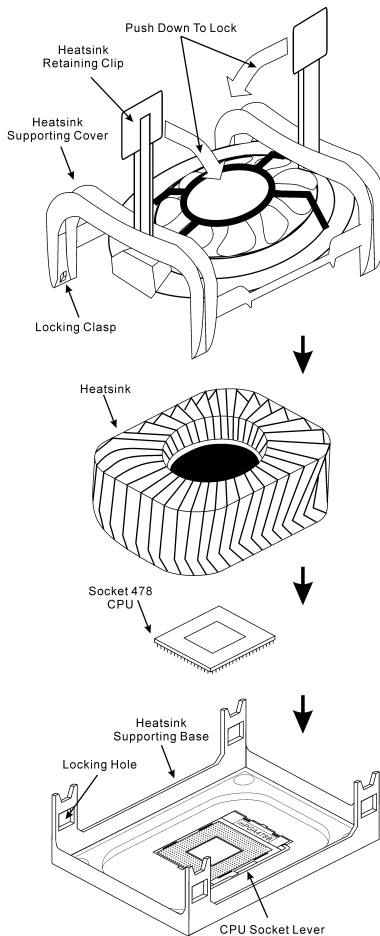

**Attenzione:** Non dimenticare di impostare la corretta frequenza BUS e multiplier per il processore.

### **Installazione della scheda madre sul telaio**

Dopo avere installato il processore sulla scheda madre si può iniziare a fissare la scheda madre sul telaio. Innanzi tutto è necessario fissare la scheda madre al telaio. La maggior parte dei telai ha una base sulla quale sono presenti diversi fori di montaggio che permettono di fissare in modo accurato la scheda madre e, allo stesso tempo, di prevenire corto circuiti. Impiegare le borchie o gli spaziatori attaccati al telaio per fissare la scheda madre.

### **Installazione della memoria di sistema**

Questa scheda madre fornisce 2 slot d'espansione di memoria RIMM da 232 pin. La memoria minima è di 128MB, quella massima è di 2GB RIMM.

Inserire il modulo RIMM nello slot d'espansione come mostrato nell'illustrazione- Notare come il modulo è imperniato nella presa. Ciò assicura che ci sia un unico modo per collegare il modulo RIMM. Premere con fermezza il modulo RIMM nello slot RIMM, assicurandosi che il modulo sia inserito completamente nello slot RIMM.

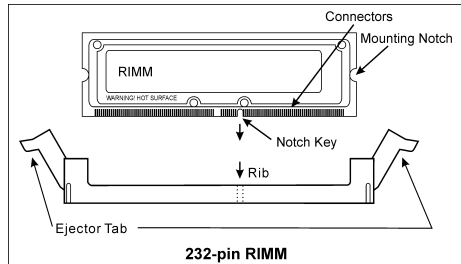

### **Connettori, collettori, interruttori ed adattatori**

All'interno della copertura di ogni computer ci sono diversi cavi e prese che devono essere collegati. Questi cavi e prese sono solitamente collegati uno ad uno ai connettori situati sulla scheda madre. E' necessario prestare particolare attenzione a qualunque orientamento del collegamento che possono avere i cavi e, se necessario, notare la posizione del primo pin del connettore. Si installeranno alcuni adattatori per particolari necessità quali l'adattatore SCSI, AGP, eccetera. Quando si installano gli adattatori sugli slot della scheda madre, si ricorda di fissarli con le viti anche sul pannello posteriore del telaio.

Per informazioni dettagliate si prega di fare riferimento alla versione integrale del Manuale utente.

### **Collegamento dei connettori d'alimentazione ai connettori ATX12V**

Ricordarsi che è necessario spingere con fermezza fino in fondo il connettore della sorgente d'alimentazione ATX al connettore ATX12V, assicurando così un buon collegamento.

### **Impostazione BIOS**

Quando l'hardware è stato installato completamente, accendere il computer ed andare alla voce BIOS per impostare i parametri del processore. Per informazioni dettagliate si prega di fare riferimento alla versione integrale del Manuale utente.



## Chapter 1. Introduction

---

### 1-1. Features & Specifications

---

#### 1. CPU

- Supports Intel® Pentium® 4 socket 478 processor with 400MHz/533MHz System Data Bus
- Supports Intel® Hyper-Threading Technology

#### 2. Chipset

- SiS R658 + SiS 963
- Supports Hi-Speed Universal Serial Bus (USB 2.0)
- Supports Ultra ATA/133/100/66/33 mode

#### 3. Memory

- Supports 2x 32-bit RIMM PC1200/PC1066/PC800 Direct RDRAM (2GB MAX)
- Supports configurable ECC function

#### 4. AGP

- Accelerated Graphics Port connector supports AGP 8X/4X Interface (0.8V/1.5V)

#### 5. LAN

- Onboard Broadcom Gigabit PCI Ethernet Controller (For SI7-G)
- Onboard 10/100M PCI Fast Ethernet Controller (For SI7)

#### 6. Serial ATA 150

- Onboard Silicon Image Serial ATA PCI Controller
- Support 2 ports SATA 150 (1.5G bps)

#### 7. Media XP (Optional)

- Supports card reader function for Memory Stick, Secure Digital and Type I/II CompactFlash
- Supports Wireless Remote Control and S/PDIF Out / Mic In / Headphone Out / USB 2.0 / IEEE 1394

#### 8. USB 2.0

- 6x USB 2.0 ports support 480 Mb/s data transfer rate

#### 9. IEEE 1394

- 2x IEEE 1394 ports support 400/200/100 Mb/s data transfer rate

#### 10. Audio

- Onboard RealTek ALC650 6-Channel AC 97 CODEC
- Professional digital audio interface supports 24-bit S/PDIF Out

#### 11. System BIOS

- SoftMenu™ Technology to set CPU parameters
- Supports Plug-and-Play (PNP)

- Supports Advanced Configuration Power Interface (ACPI)
- Supports Desktop Management Interface (DMI)
- AMI BIOS

## 12. Internal I/O Connectors

- 1x AGP slot
- 5x PCI slots
- 1x Floppy port supports up to 2.88MB
- 2x Ultra ATA/133/100/66/33 connectors
- 2x Serial ATA 150 connectors
- 2x USB headers
- 2x IEEE 1394 headers
- 1x CD-IN, 1x AUX-IN header

## 13. Back Panel I/O

- 1x PS/2 Keyboard, 1x PS/2 mouse
- 2x Serial port connectors, 1x Parallel port connector
- 1x S/PDIF Out connector
- AUDIO1 connector (Rear-Left / Rear-Right, Center/Subwoofer)
- AUDIO2 connector (Mic-In, Line-In, Front-Left/Front-Right)
- 2x USB, 1x RJ-45 LAN Connector

## 14. Miscellaneous

- ATX form factor
- Hardware Monitoring – including Fan Speed, Voltages, CPU and system temperature
- Supports Wake Up by LAN, Modem Ring, RTC Alarm, Keyboard and Mouse Power On
- Supports STR (Suspend to RAM)
- Onboard debug card design with 7-segment display

## 15. Order Information

Model	Features
SI7	SATA, 10/100M LAN
SI7-G	SATA, Gigabit LAN

- \* **Supports Wake On LAN, Modem, but your ATX power supply 5V standby power must be able to provide at least a 720mA current capacity. Otherwise, the functions may not work normally.**
- \* **This motherboard supports the standard bus speeds of 133/100/66MHz that are used by specific PCI, processor and chipset specifications. Exceeding these standard bus speeds is not guaranteed due to the specific component specifications.**
- \* **The Serial ATA controller only supports Ultra DMA/ATA100 or higher hard drive. Do not use hard drives under this specification, or it won't work.**
- \* **Specifications and information contained herein are subject to change without notice.**

# 1-2. Layout Diagram

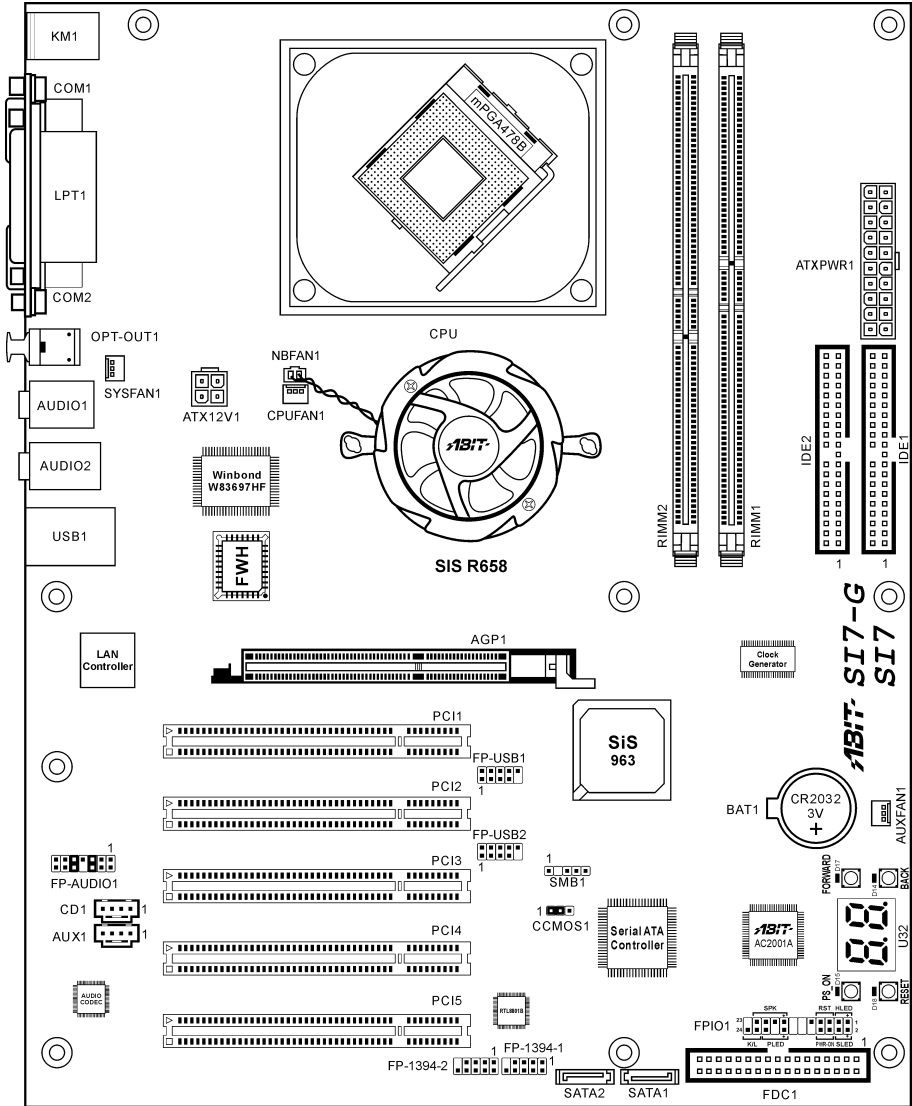



## Chapter 2. Hardware Setup

**Before the Installation:** Turn off the power supply switch (fully turn off the +5V standby power), or disconnect the power cord before installing or unplugging any connectors or add-on cards. Failing to do so may cause the motherboard components or add-on cards to malfunction or damaged.

### 2-1. Install The Motherboard

Most computer chassis have a base with many mounting holes to allow motherboard to be securely attached on and at the same time, prevented from short circuits. There are two ways to attach the motherboard to the chassis base:

1. Use with studs
2. Or use with spacers

In principle, the best way to attach the board is to use with studs. Only if you are unable to do this should you attach the board with spacers. Line up the holes on the board with the mounting holes on the chassis. If the holes line up and there are only screw holes, you can attach the board with studs. If the holes line up and there are only slots, you can only attach with spacers. Take the tip of the spacers and insert them into the slots. After doing this to all the slots, you can slide the board into position aligned with slots. After the board has been positioned, check to make sure everything is OK before putting the chassis back on.

**ATTENTION:** To prevent shorting the PCB circuit, please REMOVE the metal studs or spacers if they are already fastened on the chassis base and are without mounting-holes on the motherboard to align with.

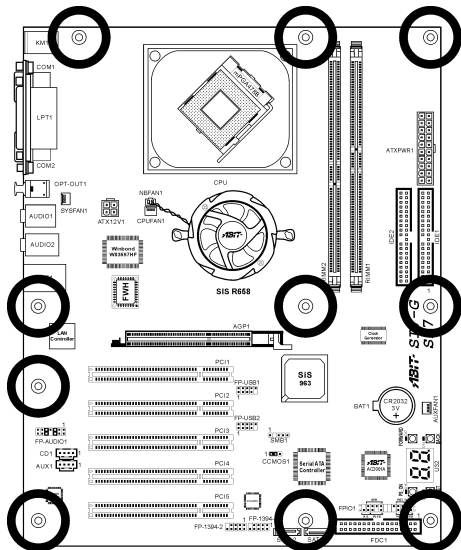
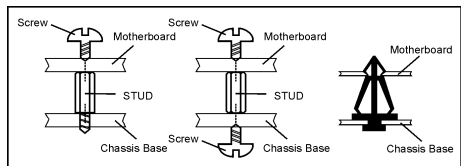

## 2-2. Install Pentium® 4 CPU and Heatsink Supporting-Base

This motherboard provides a ZIF (Zero Insertion Force) Socket 478 to install Intel® Pentium® 4 CPU. The CPU you bought should have a kit of heatsink and cooling fan along with. If that's not the case, buy one specially designed for Pentium® 4 Socket 478.

1. Locate the Socket 478. Fasten the heatsink supporting-base onto the motherboard.

**ATTENTION:** If you are using chassis specially designed for Pentium® 4, please pay attention to the location of metal studs or spacers if they are already installed on the chassis. Be careful not let the metal studs or spacers contact the printed circuit wire or parts on the PCB.

2. Pull the CPU socket lever sideways away from the socket and then upwards to 90 degree. Insert the CPU with the correct orientation. Do not use extra force to insert CPU; it only fit in one orientation. Closing down the socket lever while holding down the CPU.
3. Put the heatsink faces down onto the CPU until it completely covers the CPU.
4. Put the heatsink supporting-cover onto the heatsink. Make sure all the four locking clasp reach in the locking holes.
5. Push down the retaining clip at both sides of the supporting cover to lock up together with the supporting base. Watch out the direction for pushing down the clip.
6. The heatsink supporting cover and base should now firmly locking up with each other with the heatsink inside.

**ATTENTION:** Do not forget to set the correct bus frequency and multiple for your processor.

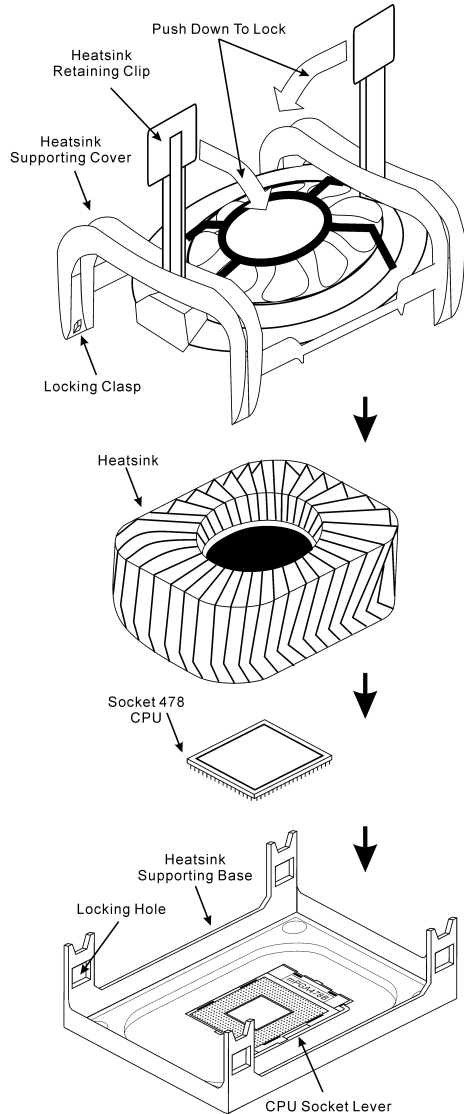

## 2-3. Install System Memory

This motherboard provides two 232-pin 32-bit RIMM (Rambus Inline Memory Modules) slots for PC1200/PC1066/PC800 Direct RDRAM.

**ATTENTION:** The PC1066 RIMM modules require CPU of 533MHz FSB only. Do not use PC1066 modules with CPU of 400MHz FSB.

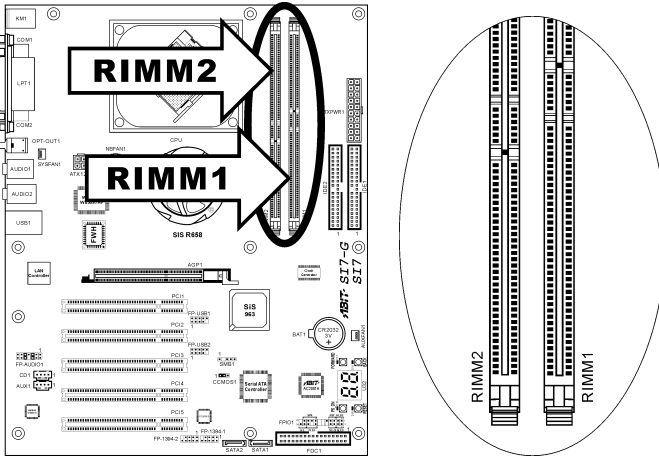

Table 2-1. Valid Memory Configurations

Bank	Memory Module	Total Memory
Bank 0, 1 (RIMM1)	128, 256, 512MB, 1GB	128MB ~ 1GB
Bank 2, 3 (RIMM2)	128, 256, 512MB, 1GB	128MB ~ 1GB
<b>Total System Memory</b>		128MB ~ 2GB

**NOTE:** RIMM modules are limited to a total combination of 24 chip devices only.

The RIMM slots must be fully installed with RIMM modules to avoid breaking the signal lines. To assure the electrical integrity of the Rambus interface when installing only one RIMM module, a C-RIMM is therefore necessary to complete the signal lines.



The diagram below shows the possible combination of RDRAM installation.

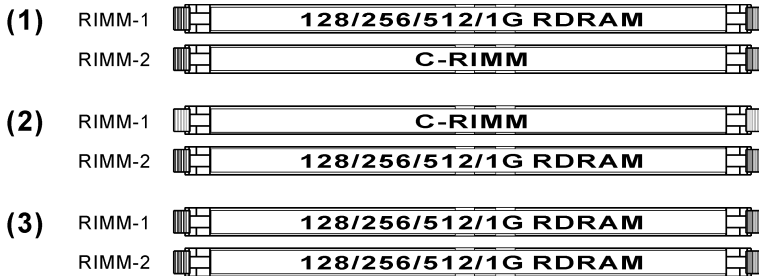

**NOTE:** No hardware or BIOS setup required after adding or removing memory modules.

**ATTENTION:** Static electricity can damage the electronic components of the computer or optional boards. Before starting these procedures, ensure that you are discharged of static electricity by touching a grounded metal object briefly.

Power off the computer and unplug the AC power cord before installing or removing memory modules.

1. Locate the RIMM slot on the board.
2. Hold two edges of the RIMM module carefully, keep away of touching its connectors.
3. Align the notch key on the module with the rib on the slot.
4. Firmly press the module into the slots until the ejector tabs at both sides of the slot automatically snaps into the mounting notch. Do not force the RIMM module in with extra force as the RIMM module only fit in one direction.

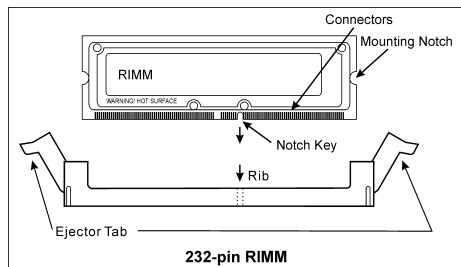

5. To remove the RIMM modules, push the two ejector tabs on the slot outward simultaneously, and then pull out the RIMM module.

**WARNING:** RIMM modules become extremely hot during operation. Don't touch the heat spreader before it cools down.



## 2-4. Connectors, Headers and Switches

Here we will show you all of the connectors, headers and switches, and how to connect them. Please read the entire section for necessary information before attempting to finish all the hardware installation inside the computer chassis. A complete enlarged layout diagram is shown in Chapter 1 for all the position of connectors and headers on the board that you may refer to.

**WARNING:** Always power off the computer and unplug the AC power cord before adding or removing any peripheral or component. Failing to do so may cause severe damage to your motherboard and/or peripherals. Plug in the AC power cord only after you have carefully checked everything.

### (1). ATX Power Input Connectors [ATXPWR1, ATX12V1]

The Pentium 4 requires a power supplier different from the regular one. It's a newly designed ATX12V power with 300W, 20A +5VDC capacity at least for heavily loaded system, and 720mA +5VSB at least for supporting Wake-On-LAN feature.

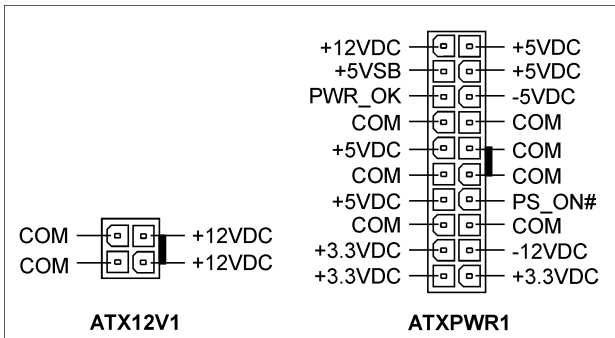
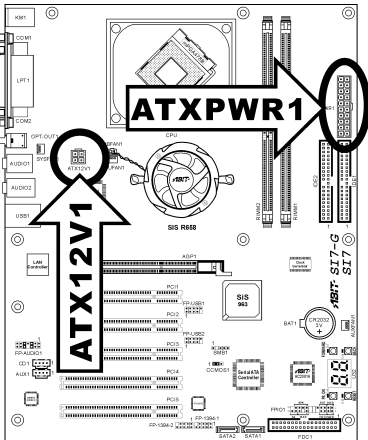

## (2). FAN Connectors [CPUFAN1, SYSFAN1, AUXFAN1]

These 3-pin connectors each provide power to the cooling fans installed in your system.

The CPU must be kept cool by using a powerful fan with heatsink. The system is capable of monitoring the speed of the CPU fan.

- **CPUFAN1:** CPU Fan
- **SYSFAN1:** System Fan
- **AUXFAN1:** Auxiliary Fan

**WARNING:** These fan connectors are not jumpers. DO NOT place jumper caps on these connectors.

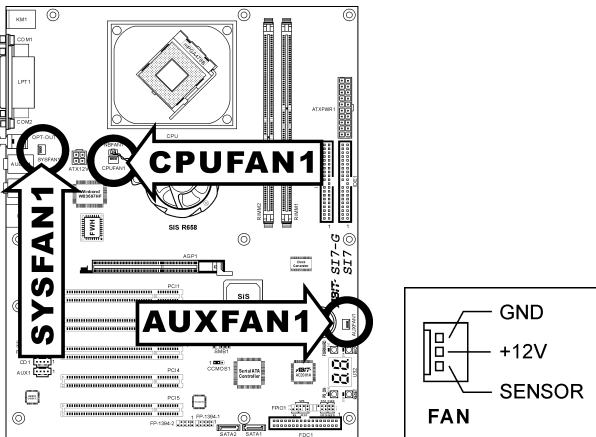

**(3). CMOS Memory Clearing Header [CCMOS1]**

This header uses a jumper cap to clear the CMOS memory.

- Pin 1-2 shorted (default): Normal operation.
- Pin 2-3 shorted: Clear CMOS memory.

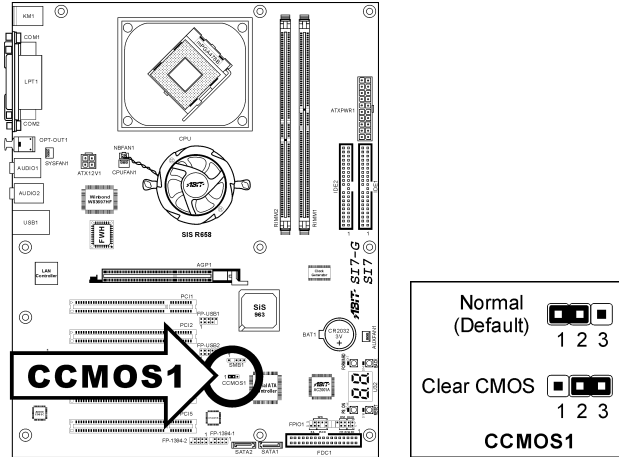

**WARNING:** Turn the power off first (including the +5V standby power) before clearing the CMOS memory. Failing to do so may cause your system to work abnormally or malfunction.

#### (4). **Front Panel Audio Connection Header [FP-AUDIO1]**

This header provides the connection to audio connector at front panel (with optional ABIT Media XP).

- To use the audio connector at front panel, remove all the jumpers on this header, and then connect to front panel by the extension cable provided with the chassis.
- To use the audio connector at rear panel, disconnect the extension cable, attach the jumpers back at pin 5-6, and pin 9-10 (default setting).

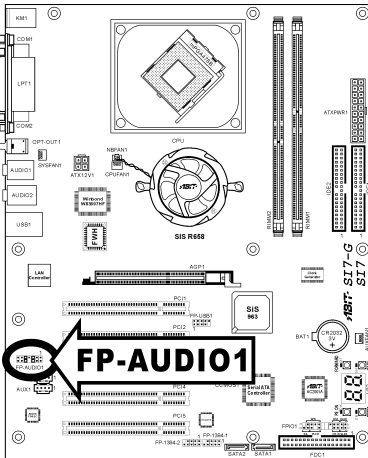

Pin	Pin Assignment	Pin	Pin Assignment
1	Audio Mic.	2	Ground
3	Audio Mic. Bias	4	VCC
5	Speaker Out Right Channel	6	Speaker Out Right Channel Return
7	X	8	NC
9	Speaker Out Left Channel	10	Speaker Out Left Channel Return
11	Ground	12	S/PDIF In
13	VCC	14	S/PDIF Out

**(5). Additional USB Port Headers [FP-USB1, FP-USB2]**

These headers each provide 2 additional USB 2.0 ports connection through an USB cable designed for USB 2.0 specifications.

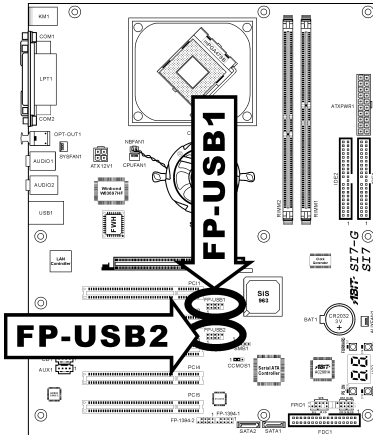

	Pin	Pin Assignment	Pin	Pin Assignment
<p><b>FP-USB1</b> <b>FP-USB2</b></p>	1	VCC	2	VCC
	3	Data0 -	4	Data1 -
	5	Data0 +	6	Data1 +
	7	Ground	8	Ground
	9	NC	10	NC

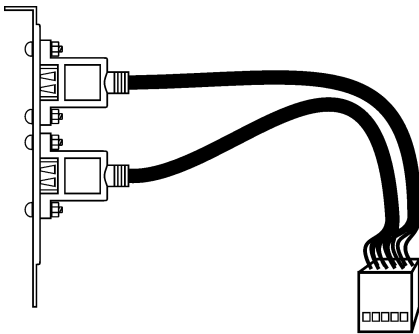

USB Header

**(6). Additional IEEE1394 Port Headers [FP-1394-1, FP-1394-2]**

These headers each provide 1 additional IEEE1394 port connection through an extension cable and bracket.

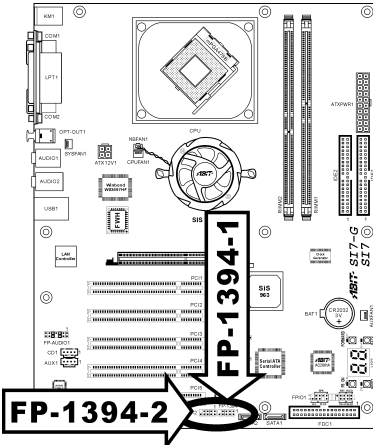

9 7 5 3 1  10 8 6 4 2 <b>FP-1394-1</b> <b>FP-1394-2</b>	Pin	Pin Assignment	Pin	Pin Assignment
	1	TPA0 +	2	TPA0 -
	3	GND	4	GND
	5	TPB0 +	6	TPB0 -
	7	+12V	8	+12V
	9	NC	10	GND

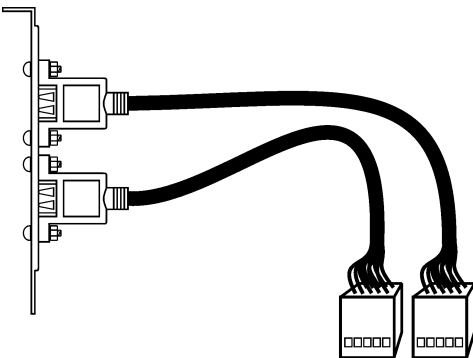

IEEE1394 Header

**(7). Front Panel Switches & Indicators Headers [FPIO1]**

This header is used for connecting switches and LED indicators on the chassis front panel.

Watch the power LED pin position and orientation. The mark “+” align to the pin in the figure below stands for positive polarity for the LED connection. Please pay attention to connect these headers. A wrong orientation will only cause the LED not lighting, but a wrong connection of the switches could cause system malfunction.

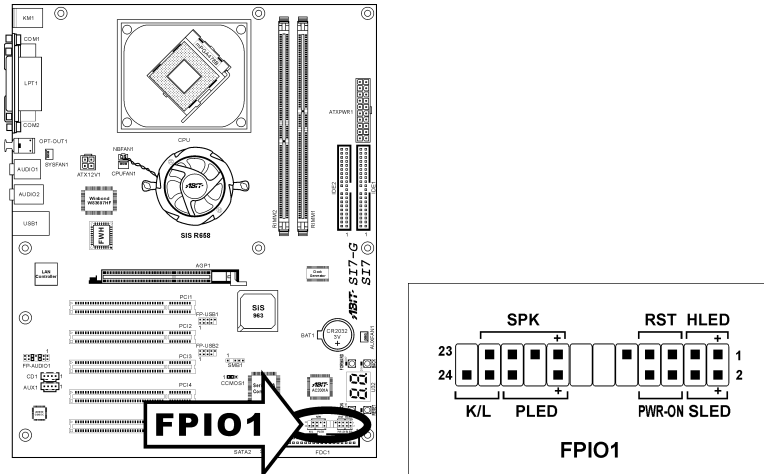

- **HLED (Pin 1, 3):**  
Connects to the HDD LED cable of chassis front panel.
- **RST (Pin 5, 7):**  
Connects to the Reset Switch cable of chassis front panel.
- **SPK (Pin 15, 17, 19, 21):**  
Connects to the System Speaker cable of chassis.
- **SLED (Pin 2, 4):**  
Connects to the Suspend LED cable (if there is one) of chassis front panel.
- **PWR-ON (Pin 6, 8):**  
Connects to the Power Switch cable of chassis front panel.
- **PLED (Pin 16, 18, 20):**  
Connects to the Power LED cable of chassis front panel.
- **K/L (Pin 22, 24):**  
Connects to the Keylock cable (if there is one) of chassis front panel.

**(8). System Management Bus Header [SMB1]**

This header is reserved for system management bus (SM bus). The SM bus is a specific implementation of an I<sup>2</sup>C bus. I<sup>2</sup>C is a multi-master bus, which means that multiple chips can be connected to the same bus and each one can act as a master by initiating a data transfer. If more than one master simultaneously tries to control the bus, an arbitration procedure decides which master gets priority.

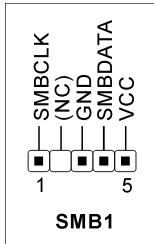
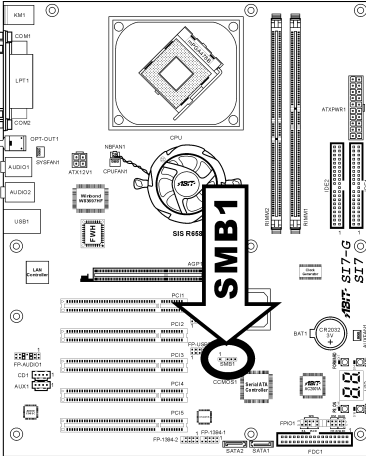

**(9). Internal Audio Connectors [CD1, AUX1]**

These connectors connect to the audio output of internal CD-ROM drive or add-on card.

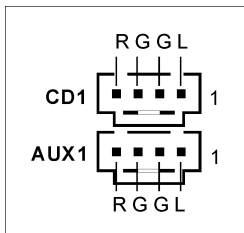
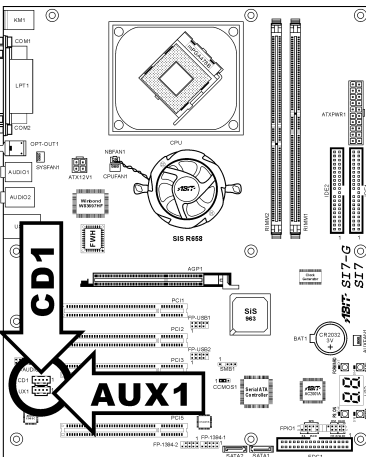



**(10). Accelerated Graphics Port Slot [AGP1]**

This slot supports an optional AGP graphics card up to AGP 4X/8X mode. Please refer to our Web site for more information on graphics cards.

**ATTENTION:** This motherboard does not support 3.3V AGP cards. Use only 1.5V or 0.8V AGP cards.

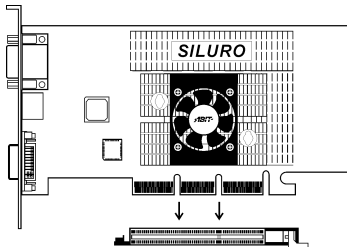
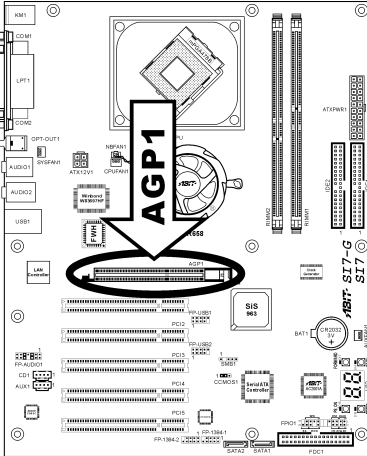

**(11). Floppy Disk Drive Connector [FDC1]**

This connector supports two standard floppy disk drives via a 34-pin 34-conductor ribbon cable.

Connecting the Floppy Disk Drive Cable:

1. Install one end of the ribbon cable into the FDC1 connector. The colored edge of the ribbon cable should be aligned with pin-1 of FDC1 connector.
2. Install the other end(s) of ribbon cable into the disk drive connector(s). The colored edge of the ribbon cable should be also aligned with pin-1 of disk drive connector. The endmost connector should be attached to the drive designated as Drive A.

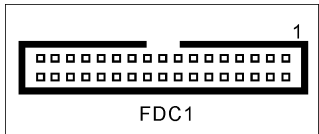
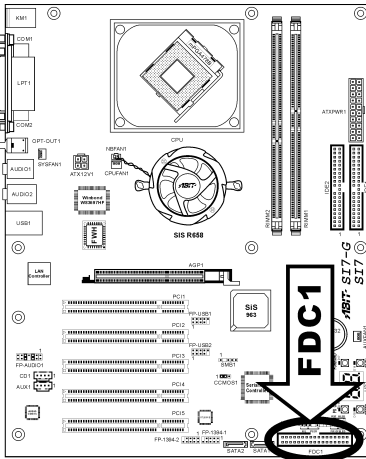

**(12). IDE Connectors [IDE1, IDE2]**

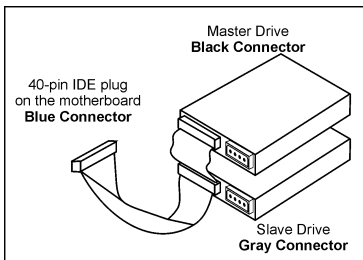
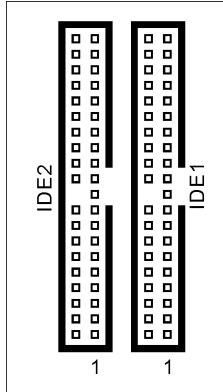
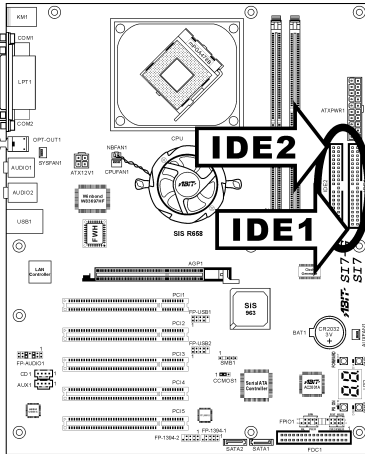

This motherboard provides two IDE ports to connect up to four IDE drives at Ultra ATA/100 mode by Ultra ATA/66 ribbon cables. Each cable has 40-pin 80-conductor and three connectors, providing two hard drives connection with motherboard. Connect the single end (blue connector) at the longer length of ribbon cable to the IDE port on motherboard, and the other two ends (gray and black connector) at the shorter length of the ribbon cable to the connectors on hard drives.

If you want to connect two hard drives together through one IDE channel, you must configure the second drive to Slave mode after the first Master drive. Please refer to the drives' documentation for jumper settings. The first drive connected to IDE1 is usually referred to as "Primary Master", and the second drive as "Primary Slave". The first drive connected to IDE2 is referred to as "Secondary Master" and the second drive as "Secondary Slave".

Keep away from connecting one legacy slow speed drive, like CD-ROM, together with another hard drive on the same IDE channel; this will drop your integral system performance.

**(13). Serial ATA Connectors [SATA1, SATA2]**

These two connectors are provided to attach one serial ATA device at each channel through Serial ATA cable. It is also possible to connect legacy IDE hard disk through an optional SERILLEL Converter.

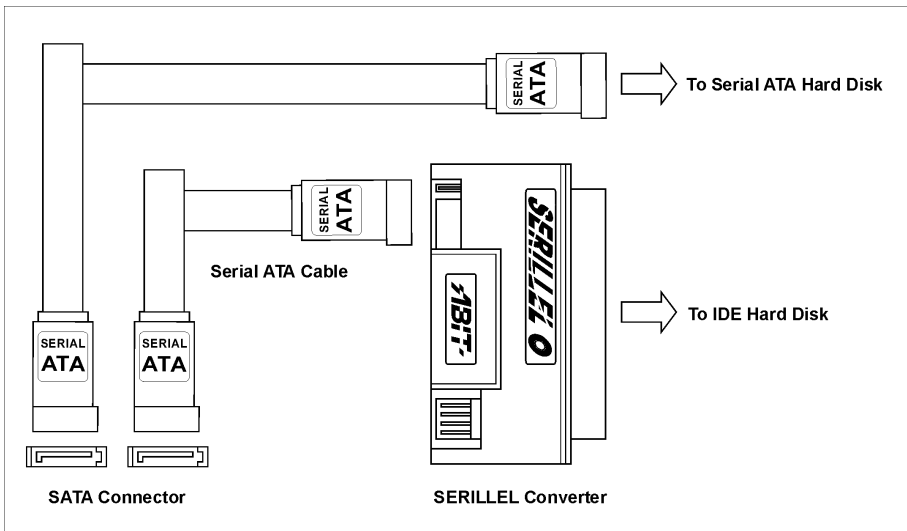
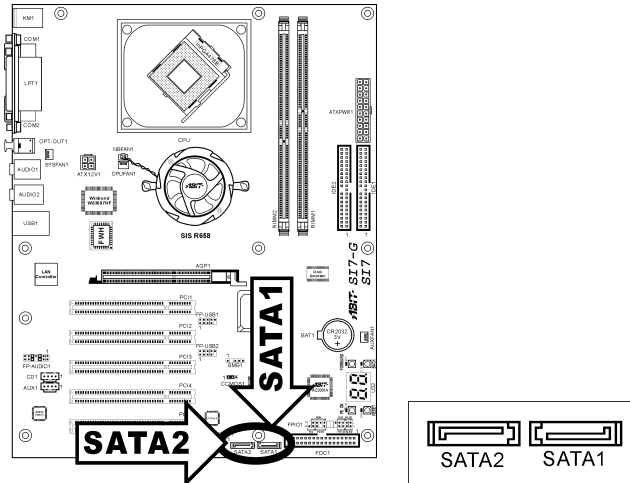

**(14). POST Code Display [U32]**

This is an LED device to display the “POST” Code, the acronym of **Power On Self Test**. The computer will execute the POST action whenever you power on the computer. The POST process is controlled by the BIOS. It is used to detect the status of the computer’s main components and peripherals. Each POST Code corresponds to different checkpoints that are also defined by the BIOS in advance. For example, “memory presence test” is an important checkpoint and its POST Code is “C1”. When the BIOS execute any POST item, it will write the corresponding POST Code into the address 80h. If the POST passes, the BIOS will process the next POST item and write the next POST Code into the address 80h. If the POST fails, we can check the POST Code in address 80h to find out where the problem lies.

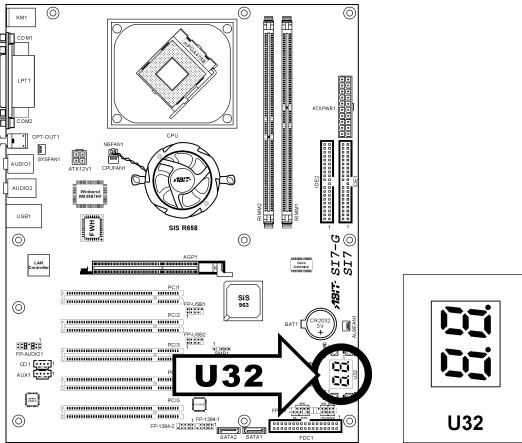

The following table shows the POST Code in detail:

POST Code	Description
CF	Test CMOS R/W functionality
C0	Early chipset initialization: -Disable shadow RAM -Disable L2 cache (socket 7 or below) -Program basic chipset registers
C1	Detect memory -Auto-detection of DRAM size, type and ECC -Auto-detection of L2 cache (socket 7 or below)
C3	Expand compressed BIOS code to DRAM
C5	Call chipset hook to copy BIOS back to E000 & F000 shadow RAM
01	Expand the Xgroup codes locating in physical address 1000:0
03	Initial Superio_Early_Init switch
05	1. Blank out screen 2. Clear CMOS error flag
07	1. Clear 8042 interface 2. Initialize 8042 self-test
08	1. Test special keyboard controller for Winbond 977 series Super I/O chips 2. Enable keyboard interface

0A	<ol style="list-style-type: none"> <li>1. Disable PS/2 mouse interface (optional)</li> <li>2. Auto detect ports for keyboard &amp; mouse followed by a port &amp; interface swap (optional)</li> <li>3. Reset keyboard for Winbond 977 series Super I/O chips</li> </ol>
0E	Test F000h segment shadow to see whether it is R/W-able or not. If test fails, keep beeping the speaker
10	Auto detect flash type to load appropriate flash R/W codes into the run time area in F000 for ESCD & DMI support
12	Use walking 1's algorithm to check out interface in CMOS circuitry. Also set real-time clock power status, and then check for override
14	Program chipset default values into chipset. Chipset default values are MODBINable by OEM customers
16	Initial Early Init Onboard Generator switch
18	Detect CPU information including brand, SMI type (Cyrix or Intel) and CPU level (586 or 686)
1B	Initial interrupts vector table. If no special specified, all H/W interrupts are directed to SPURIOUS INT HDLR & S/W interrupts to SPURIOUS soft HDLR
1D	Initial EARLY PM INIT switch
1F	Load keyboard matrix (notebook platform)
21	HPM initialization (notebook platform)
23	<ol style="list-style-type: none"> <li>1. Check validity of RTC value: e.g. a value of 5Ah is an invalid value for RTC minute</li> <li>2. Load CMOS settings into BIOS stack. If CMOS checksum fails, use default value instead</li> <li>3. Prepare BIOS resource map for PCI &amp; PnP use. If ESCD is valid, take into consideration of the ESCD's legacy information</li> <li>4. Onboard clock generator initialization. Disable respective clock resource to empty PCI &amp; DIMM slots</li> <li>5. Early PCI initialization: <ul style="list-style-type: none"> <li>-Enumerate PCI bus number</li> <li>-Assign memory &amp; I/O resource</li> <li>-Search for a valid VGA device &amp; VGA BIOS, and put it into C000:0</li> </ul> </li> </ol>
27	Initialize INT 09 buffer
29	<ol style="list-style-type: none"> <li>1. Program CPU internal MTRR (P6 &amp; PII) for 0~640K memory address</li> <li>2. Initialize the APIC for Pentium class CPU</li> <li>3. Program early chipset according to CMOS setup. Example: onboard IDE controller</li> <li>4. Measure CPU speed</li> <li>5. Invoke video BIOS</li> </ol>
2D	<ol style="list-style-type: none"> <li>1. Initialize multi-language</li> <li>2. Put information on screen display, including Award title, CPU type, CPU speed ...</li> </ol>
33	Reset keyboard except Winbond 977 series Super I/O chips
3C	Test 8254
3E	Test 8259 interrupt mask bits for channel 1
40	Test 8259 interrupt mask bits for channel 2
43	Test 8259 functionality
47	Initialize EISA slot
49	<ol style="list-style-type: none"> <li>1. Calculate total memory by testing the last double word of each 64K page</li> <li>2. Program writes allocation for AMD K5 CPU</li> </ol>

4E	<ol style="list-style-type: none"> <li>1. Program MTRR of M1 CPU</li> <li>2. Initialize L2 cache for P6 class CPU &amp; program CPU with proper cacheable range</li> <li>3. Initialize the APIC for P6 class CPU</li> <li>4. On MP platform, adjust the cacheable range to smaller one in case the cacheable ranges between each CPU are not identical</li> </ol>
50	Initialize USB
52	Test all memory (clear all extended memory to 0)
55	Display number of processors (multi-processor platform)
57	Display PnP logo Early ISA PnP initialization -Assign CSN to every ISA PnP device
59	Initialize the combined Trend Anti-Virus code
5B	(Optional Feature) Show message for entering AWDFLASH.EXE from FDD (optional)
5D	<ol style="list-style-type: none"> <li>1. Initialize Init_Onboard_Super_IO switch</li> <li>2. Initialize Init_Onboard_AUDIO switch</li> </ol>
60	Okay to enter Setup utility; i.e. not until this POST stage can users enter the CMOS setup utility
65	Initialize PS/2 Mouse
67	Prepare memory size information for function call: INT 15h ax=E820h
69	Turn on L2 cache
6B	Program chipset registers according to items described in Setup & Auto-configuration table
6D	<ol style="list-style-type: none"> <li>1. Assign resources to all ISA PnP devices</li> <li>2. Auto assign ports to onboard COM ports if the corresponding item in Setup is set to "AUTO"</li> </ol>
6F	<ol style="list-style-type: none"> <li>1. Initialize floppy controller</li> <li>2. Set up floppy related fields in 40:hardware</li> </ol>
73	(Optional Feature) Enter AWDFLASH.EXE if: -AWDFLASH is found in floppy drive -ALT+F2 is pressed
75	Detect & install all IDE devices: HDD, LS120, ZIP, CDROM ...
77	Detect serial ports & parallel ports.
7A	Detect & install co-processor
7F	Switch back to text mode if full screen logo is supported -If errors occur, report errors & wait for keys -If no errors occur or F1 key is pressed to continue: Clear EPA or customization logo
82	<ol style="list-style-type: none"> <li>1. Call chipset power management hook</li> <li>2. Recover the text font used by EPA logo (not for full screen logo)</li> <li>3. If password is set, ask for password</li> </ol>
83	Save all data in stack back to CMOS
84	Initialize ISA PnP boot devices
85	<ol style="list-style-type: none"> <li>1. USB final Initialization</li> <li>2. NET PC: Build SYSID structure</li> <li>3. Switch screen back to text mode</li> <li>4. Set up ACPI table at top of memory</li> <li>5. Invoke ISA adapter ROMs</li> <li>6. Assign IRQs to PCI devices</li> <li>7. Initialize APM</li> <li>8. Clear noise of IRQs</li> </ol>
93	Read HDD boot sector information for Trend Anti-Virus code

94	<ol style="list-style-type: none"> <li>1. Enable L2 cache</li> <li>2. Program boot up speed</li> <li>3. Chipset final initialization</li> <li>4. Power management final initialization</li> <li>5. Clear screen &amp; display summary table</li> <li>6. Program K6 write allocation</li> <li>7. Program P6 class write combining</li> </ol>
95	<ol style="list-style-type: none"> <li>1. Program daylight saving</li> <li>2. Update keyboard LED &amp; typematic rate</li> </ol>
96	<ol style="list-style-type: none"> <li>1. Build MP table</li> <li>2. Build &amp; update ESCD</li> <li>3. Set CMOS century to 20h or 19h</li> <li>4. Load CMOS time into DOS timer tick</li> <li>5. Build MSIRQ routing table</li> </ol>
FF	Boot attempt (INT 19h)

**(15). Onboard Switches [FORWARD, BACK, PS\_ON, RESET]**

- **FORWARD:** Move forward to next code layer of the POST Code Displayer.
- **BACK:** Move backward to previous code layer of the POST Code Displayer.
- **PS\_ON:** Power on the system.
- **RESET:** Reset the system.

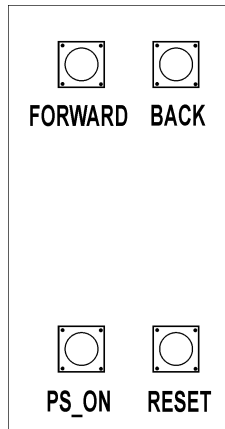
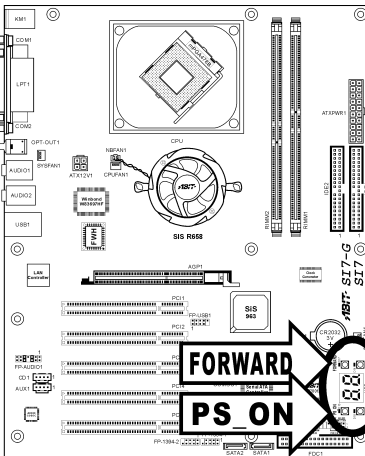



**(16). Status Indicators [D17, D14, D15, D18]**

- **D17 (FORWARD):** This LED lights up when moving forward to next code layer of the POST Code Displayer.
- **D14 (BACK):** This LED lights up moving backward to previous code layer of the POST Code Displayer.
- **D15 (VCC):** This LED lights up when the system power is on.
- **D18 (5VSB):** This LED lights up when the power supply is connected with power source.

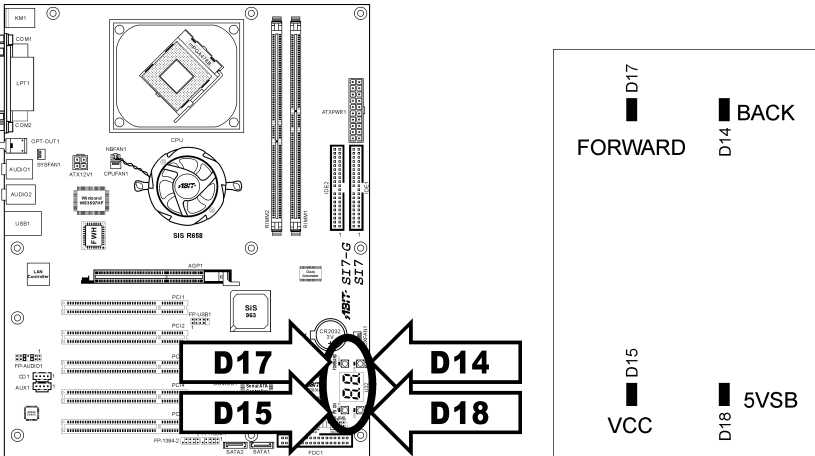

(17). **Back Panel Connectors [KM1, LPT1, COM1, COM2, OPT-OUT1, AUDIO1, AUDIO2, LAN, USB1]**

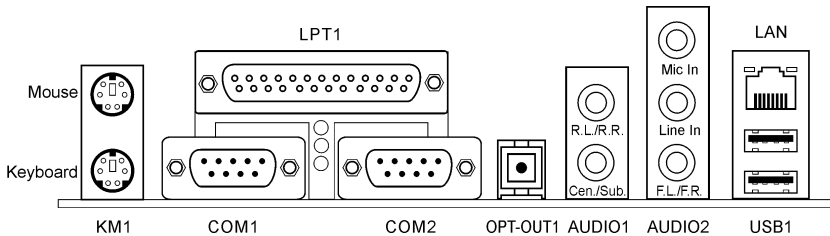

- **Mouse:** Connects to PS/2 mouse.
- **Keyboard:** Connects to PS/2 keyboard.
- **LPT1:** Connects to printer or other devices that support this communication protocol.
- **COM1/COM2:** Connects to external modem, mouse or other devices that support this communication protocol.
- **OPT-OUT1:** This connector provides an S/PDIF Out connection through optical fiber to digital multimedia devices.
- **AUDIO1:**  
**R.L./R.R. (Rear Left / Rear Right):** Connects to the rear left and rear right channel in the 5.1 channel audio system.  
**Cen./Sub. (Center / Subwoofer):** Connects to the center and subwoofer channel in the 5.1 channel audio system.
- **AUDIO2:**  
**Mic In:** Connects to the plug from external microphone.  
**Line In:** Connects to the line out from external audio sources.  
**F.L./F.R. (Front Left / Front Right):** Connects to the front left and front right channel in the 5.1-channel or regular 2-channel audio system.
- **LAN:** Connects to Local Area Network.
- **USB1:** Connects to USB devices such as scanner, digital speakers, monitor, mouse, keyboard, hub, digital camera, joystick etc.

## Chapter 3. BIOS Setup

This motherboard provides a programmable EEPROM that you can update the BIOS utility. The BIOS (Basic Input/Output System) is a program that deals with the basic level of communication between processor and peripherals. Use the BIOS Setup program only when installing motherboard, reconfiguring system, or prompted to “Run Setup”. This chapter explains the Setup Utility of BIOS utility.

After powering up the system, the BIOS message appears on the screen, the memory count begins, and then the following message appears on the screen:

**Press DEL to run setup**

If this message disappears before you respond, restart the system by pressing <Ctrl> + <Alt> + <Del> keys, or by pressing the Reset button on computer chassis. Only when it failed by these two methods can you restart the system by powering it off and then back on.

After pressing <Del> key, the main menu screen appears.

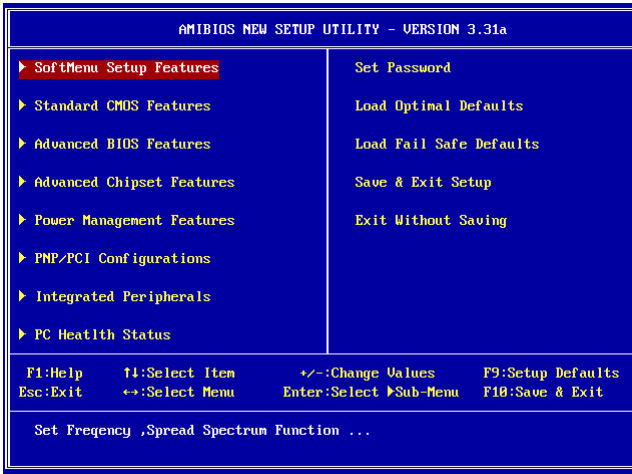

**NOTE:** In order to increase system stability and performance, our engineering staffs are constantly improving the BIOS menu. The BIOS setup screens and descriptions illustrated in this manual are for your reference only, may not completely match what you see on your screen.

## 3-1. SoftMenu Setup Features

The SoftMenu utility is ABIT's exclusive and ultimate solution in programming the CPU operating speed. All the parameters regarding CPU FSB speed, multiplier factor, the AGP & PCI clock, and even the CPU core voltage are all available at your fingertips.

SoftMenu Setup Features		[ Setup Help ]
Processor Type	Intel(R) Pentium(R) 4 Family CPU	Select to run the CPU at factory default frequency or by user define.
Processor Speed	2266MHz	
Cache Size	512KB	
CPU Operating Speed	2266 MHz (133x17)	
CPU Front Side Bus Frequency	133 MHz	
CPU Ratio Selection	CPU locked	
Estimated new CPU clock	2266 MHz	
CPU FSB/xMREF/AGP/PCI ratio	4:4:2:1	
Fixed AGP/PCI frequency	Disabled	
xMREF/RDRAM Ratio	1:8	
New FSB/RDRAM/AGP/PCI clock	133/1864/67/33	
CPU core voltage	1.500v	
RDRAM voltage	2.5v	
AGP slot voltage	1.5v	
F1:Help    F11:Select Item    +/-:Change Values    F9:Setup Defaults		
Esc:Previous Menu    Enter:Select    Sub-Menu    F10:Save & Exit		

### Processor Type:

This item displays the CPU model name, for example: Intel Pentium (R) 4.

### Processor Speed:

This item displays the processor speed.

### Cache Size:

This item displays the L2 cache size of your CPU.

### CPU Operating Speed:

This item displays the CPU operating speed according to your CPU in the format of [FSB] x [multiplier]. You can also select the [User Define] option to enter the manual option.

### User Define:

**WARNING:** The wrong settings of the multiplier and external clock in certain circumstances may cause CPU damage. Setting the working frequency higher than the PCI chipset or processor specs may cause abnormal memory module functioning, system hangs, hard disk drive data lose, abnormal functioning of the VGA card, or abnormal functioning with other add-on cards. Using non-specification settings for your CPU is not the intention of this explanation. These should be used for engineering testing, not for normal applications.

---

There will be no guaranty for the settings beyond specification, any damage of any component on this motherboard or peripherals result therein is not our responsibility.

---

**CPU Front Side Bus Frequency:**

This item selects the FSB frequency for your CPU. The FSB speed above the CPU's standard bus speed is supported but not guaranteed due to its specifications limit.

---

**CPU Ratio Selection:**

This item selects the multiplier factors for your CPU if it is not locked.

---

**Estimated new CPU clock:**

This item displays the frequency sum up from the previous item [CPU Front Side Bus Frequency] and [CPU Ratio Selection].

---

**CPU FSB/2xMREF/AGP/PCI ratio:**

This item selects the ratio for your system components' operation frequency. The estimated new operation frequency for each component will be shown below dynamically. Please keep in mind that you should try to adjust the ratio so that your AGP clock is around 66MHz and your PCI clock is around 33MHz, otherwise, you may encounter abnormal system behavior.

---

**Fixed AGP/PCI frequency:**

This option allows you to keep your AGP & PCI clock at some fixed frequency to improve system stability.

---

**2xMREF/RDRAM ratio:**

This item displays the ratio of 2xMREF and DRAM. The DRAM frequency can be got by [2xMREF] x [the ratio].

---

**New FSB/DRAM/AGP/PCI clock:**

This item displays the frequency sum up from the previous item [CPU FSB/2xMREF/AGP/PCI], [Fixed AGP/PCI frequency], and [2xMREF/RDRAM ratio].

---

**CPU core voltage:**

This item selects the core voltage supplied to your CPU. DO NOT raise it too high or it will cause damage to your valuable CPU.

---

**RDRAM voltage:**

This item selects the voltage supplied to your RDRAM slot. DO NOT raise it too high or it will cause damage to your valuable RDRAM.

---

**AGP slot voltage:**

This item selects the voltage supplied to your AGP slot. Select the correct voltage for your VGA card according to its type.

---

## 3-2. Standard CMOS Features

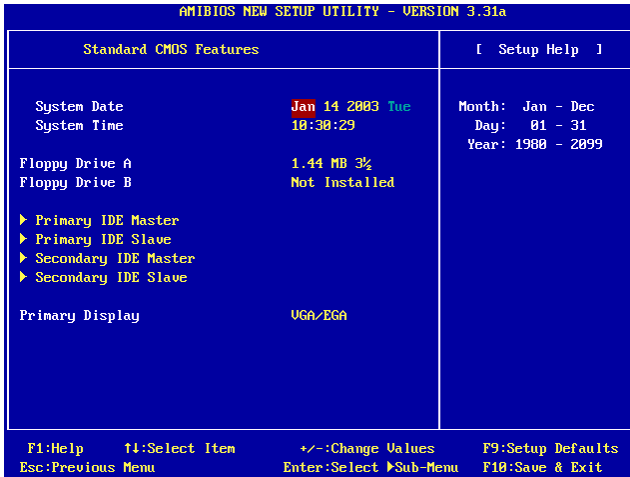

### **System Date:**

This item sets the date you specify (usually the current date) in the format of [Month], [Date], and [Year].

### **System Time:**

This item sets the time you specify (usually the current time) in the format of [Hour], [Minute], and [Second].

### **Floppy Driver A / Floppy Driver B:**

This item sets the type of floppy drives (usually only Drive A) installed.

**IDE Primary Master/Slave and IDE Secondary Master/Slave:**

Click <Enter> key to enter its submenu:

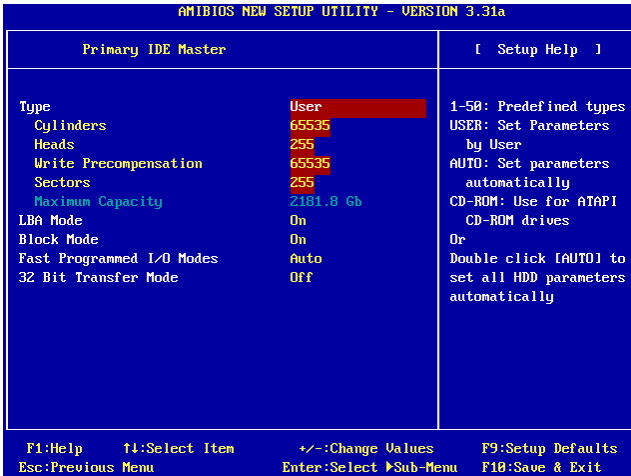

**Type:**

This item selects the type of your hard disk drives (HDD). Leave this option to its default [AUTO] settings to set all HDD parameters automatically.

**NOTE:** A newly purchased IDE HDD must be first formatted.

※ **Cylinders:**

This item configures the numbers of cylinders.

※ **Heads:**

This item configures the numbers of read/write heads.

※ **Write Precompensation:**

This item displays the number of cylinders at which to change the write timing.

※ **Sectors:**

This item configures the numbers of sectors per track.

※ **Maximum Capacity:**

This item displays the drive's maximum capacity as calculated by the BIOS based on the drive information you entered.

**LBA (Logical Block Addressing) mode:**

This option allows you to select [On] for a hard disk larger than 512 MB capacity under DOS and Windows environment. Select [Off] only when under Netware and UNIX environment.

**Block Mode:**

This option allows you to select [On] for a hard disk using block mode. The system BIOS will check the hard disk drive for the maximum block size the system can transfer. The block size will depend on the type of hard disk drive. Select [Off] to use standard mode.

**Fast Programmed I/O Modes:**

This option allows you to select the PIO mode. Select [Auto] will enhance the hard disk performance by optimizing the hard disk timing.

**32 Bit Transfer Mode:**

This option allows you to select [On] to enable 32bit access to maximize the IDE hard disk data transfer rate.

**Primary Display:**

This option allows you to select the type video adapter used for the primary system monitor.

### 3-3. Advanced BIOS Features

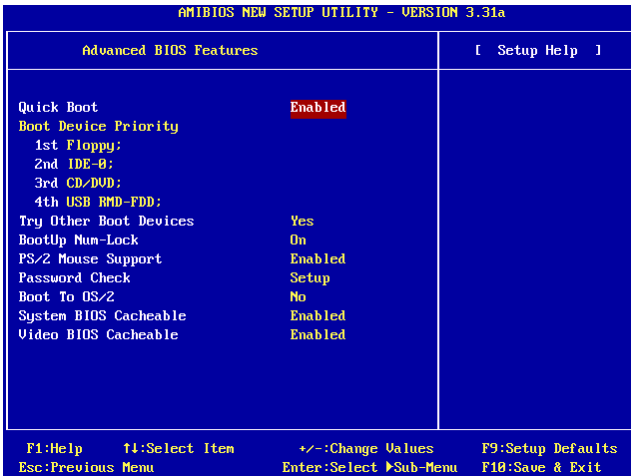
**Quick Boot:**

This item speeds up the POST (Power On Self Test) after powering on the system. Leave this option to its default [Enabled] setting to allow the BIOS shorten or skip some check items during POST.



---

---

### How to use the Quick Boot function?

---

When you start to get in the boot sequence, press <F6> key one time, then you can see the “**Select First Boot Device**” menu show up. Choose the first boot device you want then press <Enter> key to continue the boot sequence.

---

#### **Boot Device Priority:**

This item selects the booting priority. The BIOS will boot the operating system according to the sequence of the drive selected.

---

#### **Try Other Boot Other Devices:**

When set to [Enabled], this item boots your system from devices other than those selected in the [Boot Device Priority] option.

---

#### **BootUp Num-Lock:**

This item determines the default state of the numeric keypad at system booting up.

- **[On]:** The numeric keypad functions as number keys.
  - **[Off]:** The numeric keypad functions as arrow keys.
- 

#### **PS/2 Mouse Support:**

This item selects to support the PS/2 mouse or not.

- **[Enabled]:** Allow the system to use a PS/2 mouse.
  - **[Disabled]:** This option will prevent the PS/2 mouse port from using system resources and will prevent the port from being active. Use this setting if installing a serial mouse.
- 

#### **Password Check:**

This item determines when the system will prompt for password - every time the system boots or only when enters the BIOS setup.

- **[Setup]:** The password is required only when accessing the BIOS Setup.
- **[Always]:** The password is required each time the computer boots up.

**NOTE:** Don't forget your password. If you forget the password, you will have to open the computer case and clear all information in the CMOS before you can start up the system. But by doing this, you will have to reset all previously set options.

---

#### **Boot To OS/2:**

This item modifies the OS/2 boot up settings.

- **[No]:** This option allows the system to boot up into non-OS/2 environments. This is the default setting and should not be changed unless OS/2 is the main operating system and more than 64 MB of system memory is installed.
  - **[Yes]:** This option allows the system to boot up to an OS/2 environment when more than 64 MB of system memory is installed.
- 
-

**System BIOS Cacheable:**

Enabling the System BIOS cache will allow accesses to the system BIOS ROM addressed at F0000H-FFFFFH, if the cache controller is enabled. The larger the range of the Cache RAM, the higher the efficiency of the system will be.

**Video BIOS Cacheable:**

Enabling the Video BIOS cache will allow access to the video BIOS addressed at C0000H to C7FFFH to be cached, if the cache controller is enabled. The larger the range of the Cache RAM, the faster the video performance will be.

### 3-4. Advanced Chipset Features

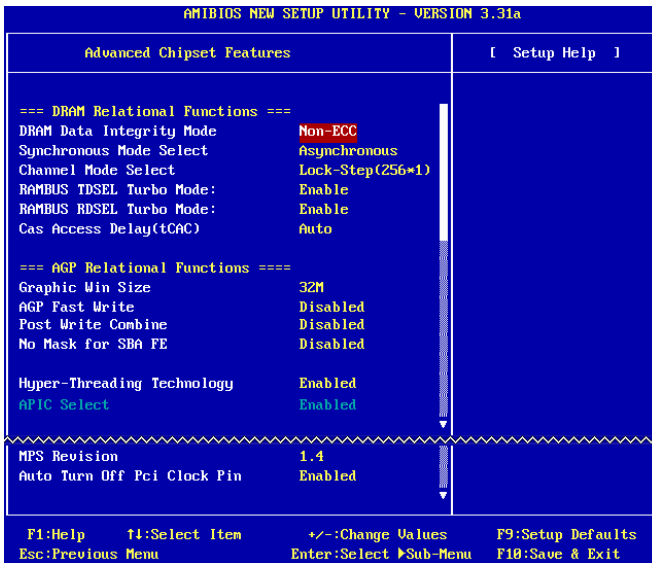
**DRAM Data Integrity Mode:**

This item selects the type of DRAM in your system. ECC is "Error Checking and Correction". Choose the ECC option only when your memory is ECC type.

**Synchronous Mode Select:**

This item selects the Synchronous mode of the signal between CPU and RAM for system performance. Choose [Asynchronous] mode only when compatibility issue occurs.

**Channel Mode Select:**

This item selects the RDRAM channel mode.

---

**RAMBUS TDSEL Turbo Mode:**

Leave this item to its default setting.

---

**RAMBUS RDSEL Turbo Mode:**

Leave this item to its default setting.

---

**Cas Access Delay(tCAC):**

Leave this item to its default setting.

---

**Graphic Win Size:**

This item specifies the amount of system memory that can be used by AGP card.

---

**AGP Fast Write:**

If your AGP card supports this “Fast Write” function, this option will increase your system performance by selecting [Enabled], but it may also decrease system compatibility.

---

**AGP Capability:**

This item selects the proper AGP data transfer rate for your AGP card.

---

**Post Write Combine:**

While as the AGP command is usually executed one by one, this item selects executing the AGP command together. Choose [Enabled] only when compatibility issue occurs.

---

**No Mask for SBA FE:**

This item selects masking the AGP calibrating signal for certain VGA cards. Choose [Enabled] only when compatibility issue occurs.

---

**Hyper-Threading Technology**

Leave this item to its default setting to enable the simultaneous multi-threaded (SMT) processor so as to make one physical processor looks like two logical processors to the OS and applications.

This option is for CPU with Hyper-Threading Technology only. For more information on “Hyper-Threading Technology”, please visit Intel Web site at

<http://www.intel.com/homepage/land/hyperthreading.htm> , <http://www.intel.com/design/chipsets/ht/>.

---

**APIC Select:**

- **[Enabled]:** The APIC (Advanced Programmable Interrupt Controller) mode will expand available IRQs resources for the system.
- **[Disabled]:** The system will use the default PCI IRQs for all devices, and will not increase the number of PCI IRQs.

**NOTE:** Assume you enable this item first before installing Windows® 2000 or Windows® XP operating system, disabling this item and then reboot the system will cause the system hang. You have to change this option to [Enabled] to make your system back to normal.

✱ **MPS Revision:**

This option specifies which version of MPS (Multi-Processor Specification) this motherboard will use. Select [1.1] when using an older operating system for dual processor executing.

**Auto Turn Off Pci Clock Pin:**

This item turns off the PCI clock that is not in use. Leave this option to its default settings.

## 3-5. Power Management Features

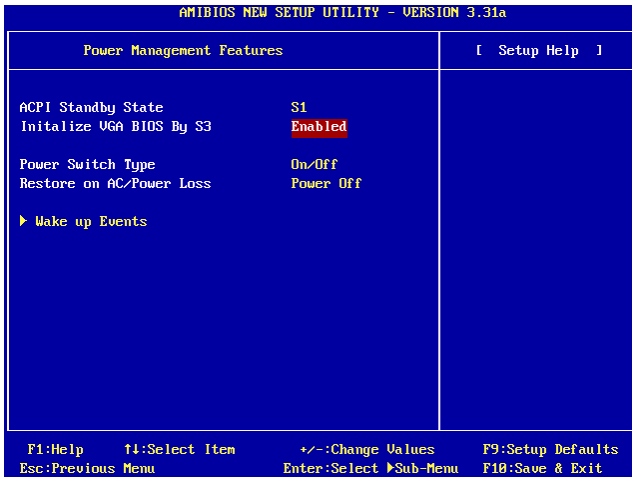

**ACPI Standby State:**

This item selects the type of Suspend mode.

- **[S1(POS)]:** Enables the Power On Suspend function.
- **[S3(STR)]:** Enables the Suspend to RAM function.
- **[Auto]:** Automatically select the type of suspend mode.

**Initialize VGA BIOS By S3:**

When set to [Enabled], this item allows the system to initialize VGA BIOS after woke up from S3 state. Leave this item to its default settings to let the display screen back to normal after woke up from S3 state.

**Power Switch Type:**

This item selects the function type of power switch.

- **[On/Off]:** Power on and power off the system.

- **[Suspend]:** Suspending the system.

**Restore on AC/Power loss:**

This item sets the system power state when it recovers from AC power loss.

- **[Power Off]:** The system turns off when power returns.
- **[Power On]:** The system turns on when power returns.
- **[Last State]:** The system returns to the previous power state.

**Wake Up Events:**

Click <Enter> key to enter its submenu:

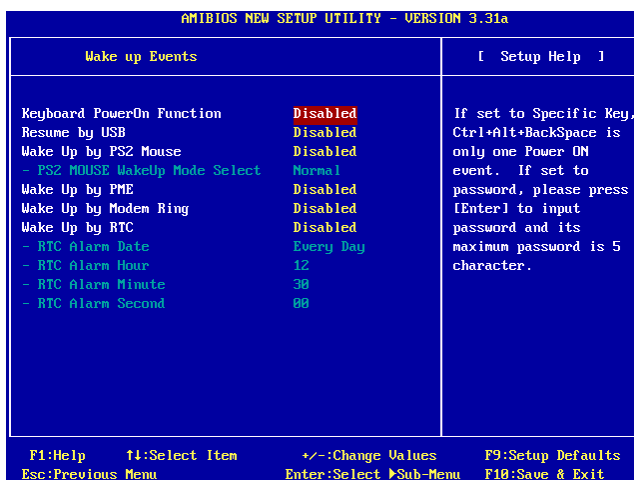

**Keyboard PowerOn Function:**

This item selects the wake-up method by keyboard.

- **[Disabled]:** Disable the keyboard power-on function.
- **[Any Key]:** Allows the keyboard power-on function by any keypad.
- **[Specific Key]:** Allows the keyboard power-on function only by <Ctrl> + <Alt> + <Back Space> key.
- **[Password]:** Allows the keyboard power-on function by a password of 5-character length.

**Resume by USB:**

When set to [Enabled], any event occurring at USB port will awaken the system that has been powered down.

---

**Wake Up by PS2 Mouse:**

When set to [Enabled], any event occurring at PS/2 mouse port will awaken the system that has been powered down.

**\* PS2 MOUSE Wakeup Mode Select:**

This item selects the mode to awaken the system by PS/2 mouse.

- **[Normal]:** Any movement of the mouse will affect.
  - **[Only Button]:** Only by pushing the mouse buttons will affect.
- 

**Wake Up by PME:**

When set to [Enabled], any event occurring at LAN port will awaken the system that has been powered down.

---

**Wake Up by Modem Ring:**

When set to [Enabled], any event occurring by modem ring will awaken the system that has been powered down.

---

**Wake Up by RTC:**

When set to [Enabled], you can set the date, hour, minute and second you want for RTC (Real-Time Clock) to awaken the system from suspend mode.

**\* RTC Alarm Date:**

Select the date for RTC alarm.

**\* RTC Alarm Hour:**

Select the hour for RTC alarm.

**\* RTC Alarm Minute:**

Select the minute for RTC alarm.

**\* RTC Alarm Second:**

Select the second for RTC alarm.

## 3-6. PnP/PCI Configurations

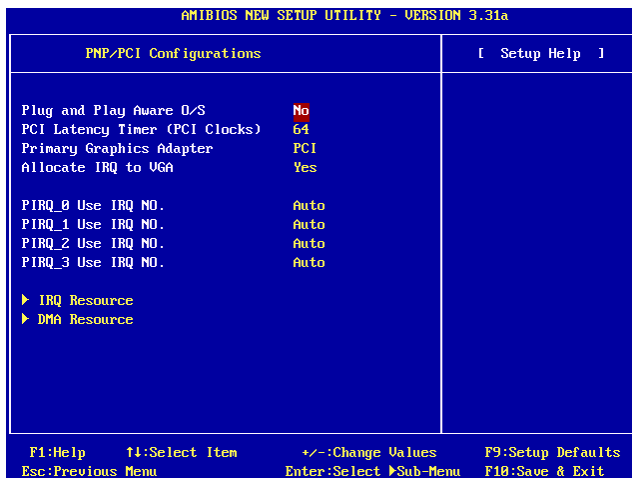

### Plug and Play Aware O/S:

This item allows you to use a PnP operating system to configure the PCI bus slots instead of the BIOS. When set to [Yes], the interrupts may be reassigned by the BIOS. If you installed a non-PnP OS, or if you want to prevent re assigning of interrupt settings, keep the default setting [No].

### PCI Latency Timer (PCI Clocks):

This item controls how long each PCI device can hold the bus before another takes over. When set to higher values, every PCI device can conduct transactions for a longer time and thus improve the effective PCI bandwidth. For better PCI performance, you should set the item to higher values.

### Primary Graphics Adapter:

This item selects whether to initialize the AGP or PCI first when the system boots.

- **[AGP]:** When the system boots, it will first initialize the AGP.
- **[PCI]:** When the system boots, it will first initialize PCI.

### Allocate IRQ to VGA:

This item assigns an IRQ for the VGA card installed.

- **[Yes]:** Automatically assign an IRQ for the VGA card installed.
- **[No]:** The IRQ that was previously occupied by the VGA card will be available for new device.

**PIRQ 0 Use IRQ No. ~ PIRQ 3 Use IRQ No.:**

This item specifies the IRQ number manually or automatically for the devices installed on PCI slots.

For the relations between the hardware layout of PIRQ, INT# (PCI slot IRQ signals) and devices, please refer to the table below:

Signals	PIRQ_0 Assignment	PIRQ_1 Assignment	PIRQ_2 Assignment	PIRQ_3 Assignment
AGP	INT A	INT B		
PCI-1	INT A	INT B	INT C	INT D
PCI-2	INT B	INT D	INT C	INT A
PCI-3	INT B	INT A	INT D	INT C
PCI-4	INT D	INT A	INT B	INT C
PCI-5	INT C	INT D	INT A	INT B
LAN				INT A
SATA			INT A	

**NOTE:**

- PCI slot 1 shares IRQ signals with AGP slot.
- PCI slot 2 shares IRQ signals with PCI slot 3.
- PCI slot 4 shares IRQ signals with LAN.
- PCI slot 5 shares IRQ signals with SATA.
- If you want to install two PCI cards into those PCI slots that share IRQ with one another at the same time, you must make sure that your OS and PCI devices' driver supports the IRQ sharing function.



※ **IRQ Resources:**

This item modifies the IRQ settings.

- **[PCI/PnP]:** This setting allows the specified IRQ to be used by a PCI/PnP device.
- **[Reserve]:** This setting allows the specified IRQ to be used by a legacy ISA device.

AMIBIOS NEW SETUP UTILITY - VERSION 3.31a		[ Setup Help ]
IRQ Resource		
IRQ3	PCI/PnP	
IRQ4	PCI/PnP	
IRQ5	PCI/PnP	
IRQ7	PCI/PnP	
IRQ10	PCI/PnP	
IRQ11	PCI/PnP	
IRQ14	PCI/PnP	
IRQ15	PCI/PnP	

F1:Help    ↑:Select Item    +/-:Change Values    F9:Setup Defaults  
 Esc:Previous Menu    Enter:Select Sub-Menu    F10:Save & Exit

※ **DMA Resources:**

This item modifies the DMA settings.

- **[PnP]:** This setting allows the specified DMA to be used by a PCI/PnP device.
- **[Reserve]:** This setting allows the specified DMA to be used by a legacy ISA device.

AMIBIOS NEW SETUP UTILITY - VERSION 3.31a		[ Setup Help ]
DMA Resource		
DMA Channel 0	PnP	
DMA Channel 1	PnP	
DMA Channel 3	PnP	
DMA Channel 5	PnP	
DMA Channel 6	PnP	
DMA Channel 7	PnP	

F1:Help    ↑:Select Item    +/-:Change Values    F9:Setup Defaults  
 Esc:Previous Menu    Enter:Select Sub-Menu    F10:Save & Exit

## 3-7. Integrated Peripherals

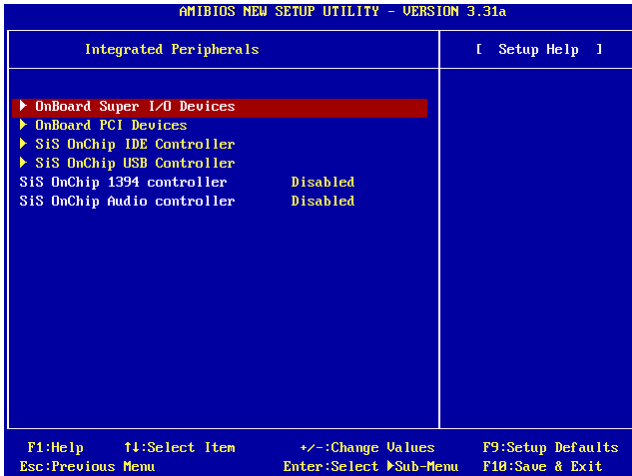

### OnBoard Super I/O Devices:

Click <Enter> key to enter its submenu:

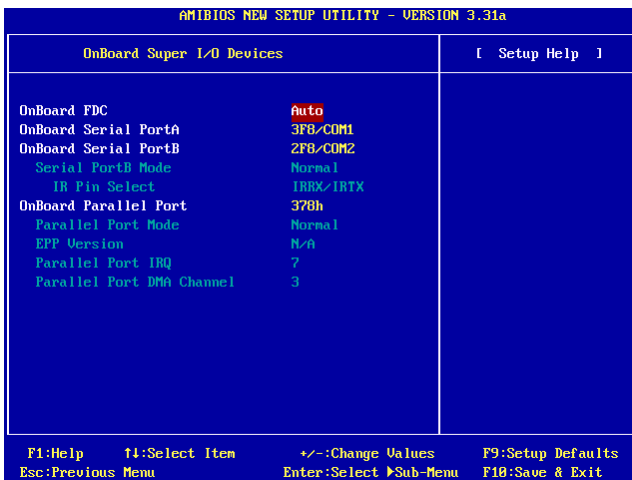

### OnBoard FDC:

- **[Enabled]:** Enables the onboard floppy disk controller.
- **[Disabled]:** Disables the onboard floppy disk controller.

---

**Onboard Serial PortA / Onboard Serial PortB:**

This item determines which I/O addresses the onboard Serial Port A & B controller will access.

- **[Auto]:** The system automatically select an I/O address for the onboard Serial Port A & B.
- **[3F8/COM1, 2F8/COM2, 3E8/COM3, 2E8/COM4]:** Allows you to manually select an I/O address for the onboard Serial Port A & B.
- **[Disabled]:** Disables the onboard Serial Port A and/or B.

※ **Serial PortB Mode:**

This item sets the operation mode for Serial Port B.

※ **IR Pin Select:**

This item selects the pin headers for IR device.

- **[IRRX/IRTX]:** Select this option when using an internal IR module connected to the onboard IR header.
- **[SINB/SOUTB]:** Select this option when connecting an IR adapter to COM B.

---

**Onboard Parallel Port:**

This item specifies the I/O address used by the parallel port.

- **[Disabled]:** This option prevents the parallel port from accessing any system resources. When the value of this option is set to *Disabled*, the printer port becomes unavailable.
- **[378]:** This option allows the parallel port to use 378 as its I/O port address. The majority of parallel ports on computer systems use IRQ7 and I/O Port 378H as the standard setting.
- **[278]:** This option allows the parallel port to use 278 as its I/O port address.
- **[3BC]:** This option allows the parallel port to use 3BC as its I/O port address.

※ **Parallel Port Mode:**

This item specifies the parallel port mode.

- **[Normal]:** Allows the standard parallel port mode to be used.
- **[SPP]:** (Standard Parallel Port) Allows bi-directional parallel port operation at normal speed.
- **[EPP]:** (Enhanced Parallel Port) Allows bi-directional parallel port operation at maximum speed.
- **[ECP]:** (Extended Capabilities Port) Allows bi-directional parallel port operation at a speed faster than the normal mode's data transfer rate.

※ **EPP Version:**

This item selects the EPP version for the parallel port when the mode selected for the parallel port mode is EPP.

※ **Parallel Port IRQ:**

This item specifies the IRQ used by the parallel port.

- **[5]:** This option allows the serial port to use Interrupt 5.

- [7]: This option allows the serial port to use Interrupt 7. The majority of parallel ports on computer systems use IRQ7 and I/O Port 378H as the standard setting.

\* **Parallel Port DMA Channel:**

This item selects a DMA channel for the parallel port.

---

**OnBoard PCI Devices:**

Click <Enter> key to enter its submenu:

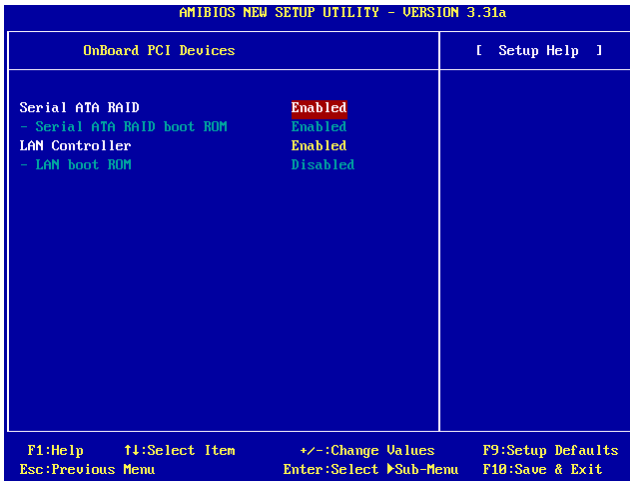

---

**Serial ATA RAID**

This item selects the onboard Serial ATA controller. When set to [Enabled], two additional channels will be provided for adding high performance devices to system.

\* **Serial ATA RAID boot ROM**

This item enables or disables the Boot ROM on Serial ATA controller.

---

**LAN Controller**

This option enables or disables the LAN controller.

\* **LAN boot ROM**

This item enables or disables the Boot ROM on LAN controller.

**SiS OnChip IDE Controller:**

Click <Enter> key to enter its submenu:

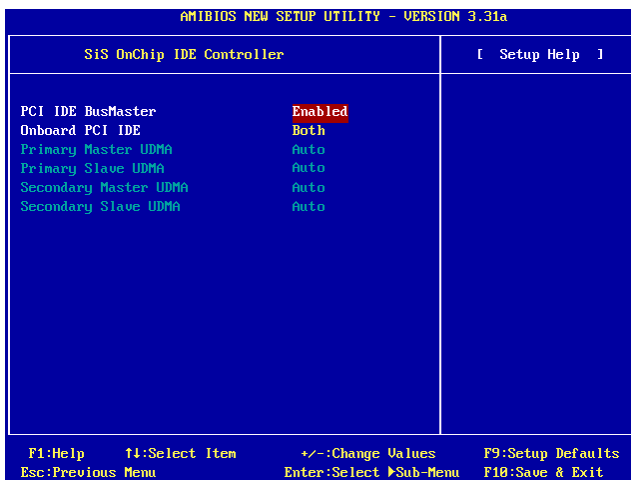
**PCI IDE BusMaster:**

This item decides whether the IDE controller on the PCI local bus has the bus mastering capability.

**Onboard PCI IDE:**

This item allows you disable all onboard PCI IDE devices, or enable one of them.

\* **Primary Master/Slave UDMA, Secondary Master/Slave UDMA:**

These fields set the Ultra DMA in use.

- **[Auto]:** The BIOS will automatically select the best available option after checking your hard drive or CD-ROM.
- **[Disabled]:** The BIOS will not detect these categories.

**SiS OnChip USB Controller:**

Click <Enter> key to enter its submenu:

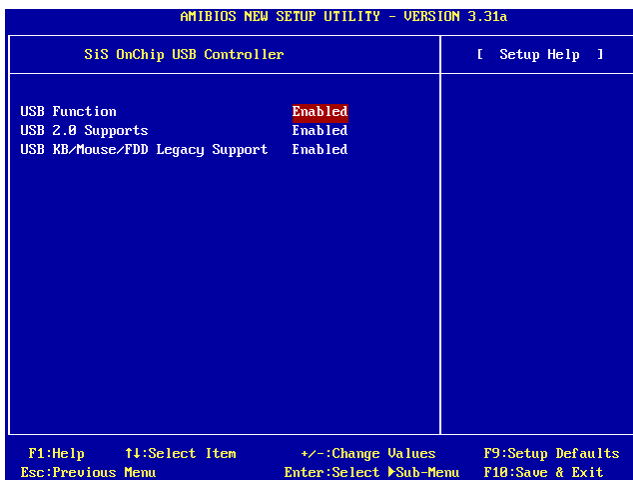
**USB Function:**

This option enables or disables the USB function.

**USB 2.0 Supports:**

This option enables or disables the USB 2.0 function. When set to [Disabled], the USB port will be running at USB 1.1 Specification.

**USB KB/Mouse/FDD Legacy Support:**

This option enables or disables the USB support in DOS environment.

**SiS OnChip 1394 Controller:**

This option enables or disables the onchip IEEE1394 controller.

**SiS OnChip Audio Controller:**

This option enables or disables the onchip audio controller.

### 3-8. PC Health Status

You can set the warning temperature for your computer system, and you can check the fan speeds and power supply voltages of your computer system. The features are useful for monitoring all the important parameters within your computer system. We call it the *PC Health Status*.

AMIBIOS NEW SETUP UTILITY - VERSION 3.31a	
PC Health Status	[ Setup Help ]
Fan Fail Warning	CPU FAN
CPU Warning Temperature	Disabled
--= System Hardware Monitor =--	
Vcore	1.000 V
Vcc3	3.488 V
Vcc	5.107 V
+12V	12.430 V
Vddq	0.464 V
Vddr	0.000 V
VBAT	2.544 V
SYSTEM Fan Speed	0 RPM
CPU Fan Speed	1205 RPM
SYSTEM Temperature	-46°C/-114°F
CPU Temperature	35°C/95°F
F1:Help    F11:Select Item    +/-:Change Values    F9:Setup Defaults Esc:Previous Menu    Enter:Select Sub-Menu    F10:Save & Exit	

#### FAN Fail Warning:

This item selects which fan will be monitored for fan fail warning.

#### CPU Warning Temperature:

This item selects the temperature you want the system to send out a warning message to PC speaker.

#### All Voltages, Fans Speed and Thermal Monitoring:

These unchangeable items list the current status of the CPU and environment temperatures, fan speeds, and system power voltage.

**NOTE:** The hardware monitoring features for temperatures, fans and voltages will occupy the I/O address from 294H to 297H. If you have a network adapter, sound card or other add-on cards that might use those I/O addresses, please adjust your add-on card I/O address to avoid using these addresses.

### **3-9. Set Password**

---

This option protects the BIOS configuration or restricts access to the computer itself.

### **3-10. Load Optimized Defaults**

---

This option loads the BIOS default values that are factory settings for optimal-performance system operations.

### **3-11. Load Fail-Safe Defaults**

---

This option loads the BIOS default values for the most stable, minimal-performance system operations.

### **3-12. Save & Exit Setup**

---

This option saves your selections and exits the BIOS setup menu.

### **3-13. Exit Without Saving**

---

This option exits the BIOS setup menu without saving any change.



## Appendix A. Install SiS Chipset Driver

**NOTE:** Please install this SiS Chipset driver first after having installed the Windows operating system.

The installation procedures and screen shots in this section are based on Windows XP operating system. For those of other OS, please follow its on-screen instruction.

Insert the Driver & Utility CD into CD-ROM drive, it should execute the installation program automatically. If not, double-click the execution file at the main directory of this CD to enter the installation menu.

After entering the installation menu, move your cursor to [Driver] tab. Click [SiS Chipset Driver]. The following screen appears.



1. Click [Next].

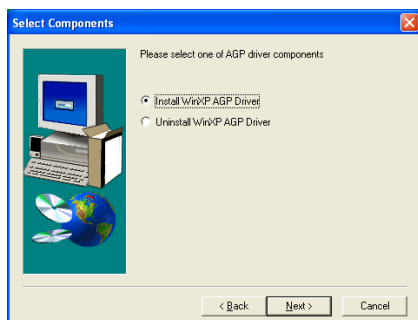

2. Click [Next].



3. Choose [Yes, I want to restart my computer now.], and click [Finish] to complete setup.



## Appendix B. Install SiS IDE Driver

The installation procedures and screen shots in this section are based on Windows XP operating system. For those of other OS, please follow its on-screen instruction.

Insert the Driver & Utility CD into CD-ROM drive, it should execute the installation program automatically. If not, double-click the execution file at the main directory of this CD to enter the installation menu.

After entering the installation menu, move your cursor to [Driver] tab. Click [SiS IDE Driver]. The following screen appears.

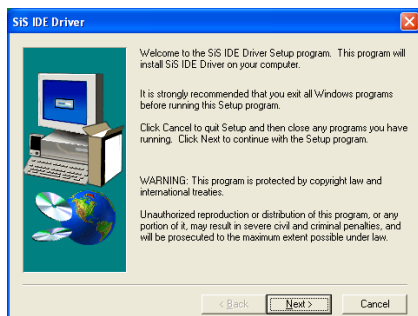

1. Click [Next].

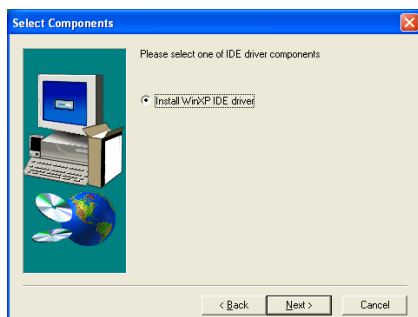

2. Click [Next].



3. Choose [Yes, I want to restart my computer now.], and click [Finish] to complete setup.



## Appendix C. Install Audio Driver

The installation procedures and screen shots in this section are based on Windows XP operating system. For those of other OS, please follow its on-screen instruction.

Insert the Driver & Utility CD into CD-ROM drive, it should execute the installation program automatically. If not, double-click the execution file at the main directory of this CD to enter the installation menu.

After entering the installation menu, move your cursor to [Driver] tab. Click [RealTek Audio Driver]. The following screen appears.

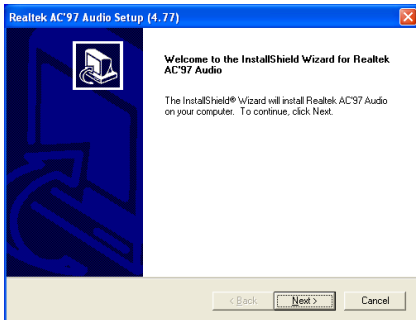

1. Click [Next].

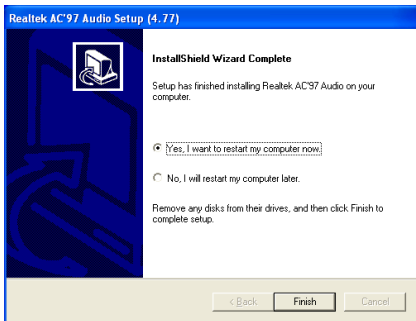

2. Choose [Yes, I want to restart my computer now.], and click [Finish] to complete setup.

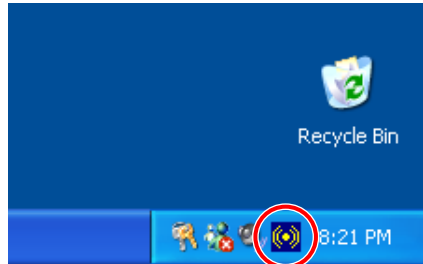

3. After the system restarted, a shortcut icon appears at the right corner of Windows task bar.

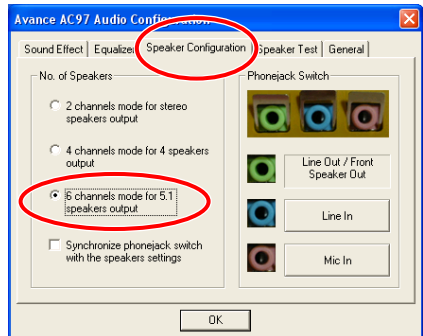

4. In this Speaker Configuration tab, select [6 channels mode for 5.1 speakers output] to enable 6-channel audio system.

**Note:** To keep a normal operation of 5.1 speakers output, please do not change the settings of “Line In” and “Mic In” in this menu.



5. To run the [AvRack] control panel, click [Start] → [All Programs] → [Avance Sound Manager] → [AvRack].



6. The AvRack control panel with Recorder, Equalizer, and Playist window appears.

## Appendix D. Install LAN Driver

The installation procedures and screen shots in this section are based on Windows XP operating system. For those of other OS, please follow its on-screen instruction.

Insert the Driver & Utility CD into CD-ROM drive, it should execute the installation program automatically. If not, double-click the execution file at the main directory of this CD to enter the installation menu.

### For SI7:

After entering the installation menu, move your cursor to [Driver] tab. Click [Broadcom 10/100 LAN Driver]. The following screen appears.

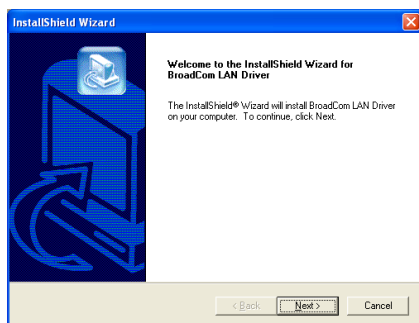

1. Click [Next].

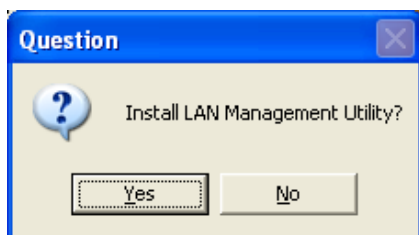

2. Click [Yes].

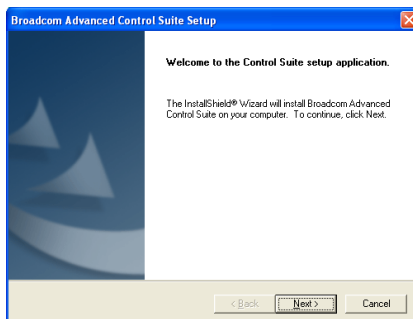

3. Click [Next].

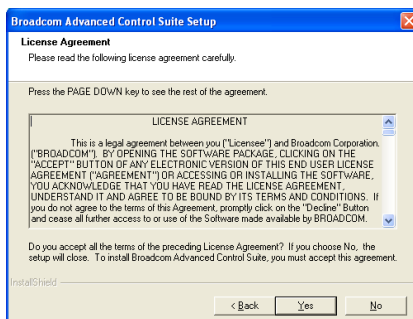

4. Click [Yes].

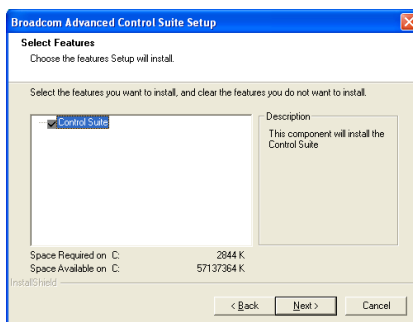

5. Click [Next].



6. Click [OK].



7. Choose [Yes, I want to restart my computer now.], and click [Finish] to complete setup.

**Note:** In order to enable the WOL (Wake-up LAN) function for **SI7** and **SI7-G** model in Windows 2000 and Windows XP, it is necessary to change the value of the “Wake Up Capabilities” property into “Magic Frame”. Please refer to the following two steps:

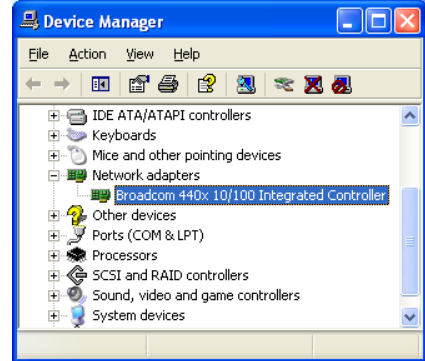

1. After finished the driver installation, check the [Network adapters] in the [Device Manager]. You will find the [Broadcom 440x 10/100 Integrated Controller] is successfully installed.

Select [Broadcom 440x 10/100 Integrated Controller]. Right click your mouse to enter its properties.

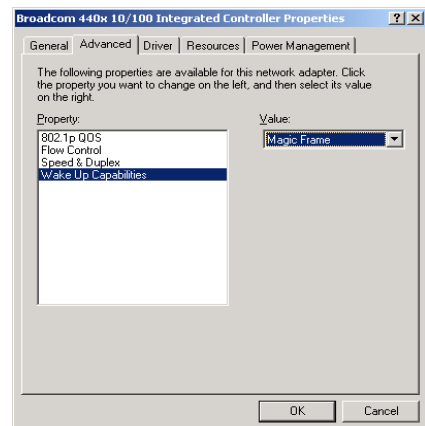

2. Select [Advanced] tab. Move your cursor to select the [Wake Up Capabilities] property option and then set the value option to [Magic Frame]. Click [OK] and restart your computer to complete setup.



## For SI7-G:

After entering the installation menu, move your cursor to [Driver] tab. Click [Broadcom Gigabit LAN Driver]. The following screen appears.

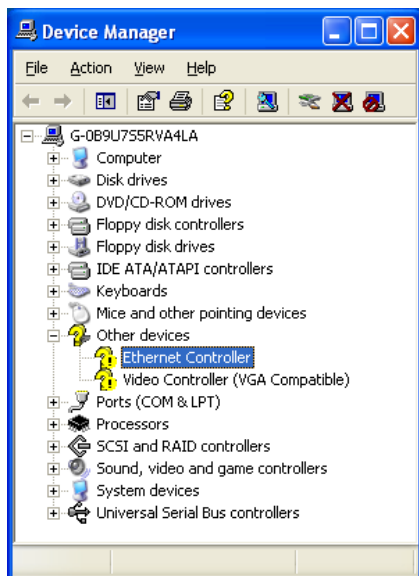

1. Check [Device Manager]. Click [Ethernet Controller].

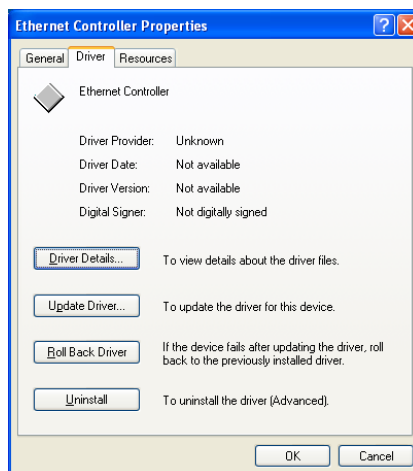

2. Select [Driver] tab in the [Ethernet Controller Properties]. Click [Update Driver].

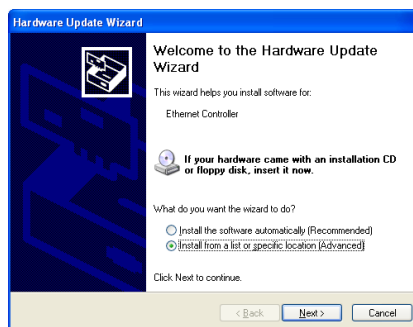

3. Check [Install from a list or specific location], and then click [Next].

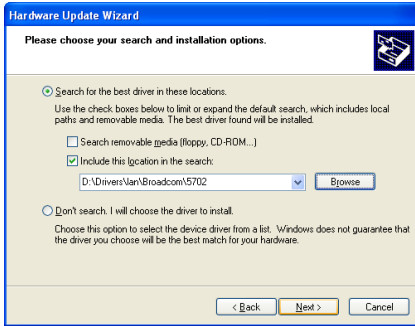

4. Check [Include this location in the search]. Click [Browse] button to locate the driver or type in the path [D:\Drivers\lan\Broadcom\5702]. D: is the CD-ROM drive. Click [Next] to continue.

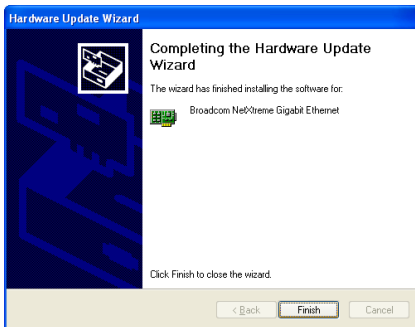

5. Click [Finish].

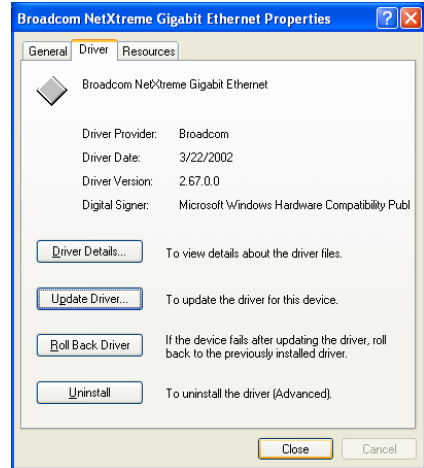

6. Back to the [Ethernet Controller Properties]. Click [Close] to finish driver update.

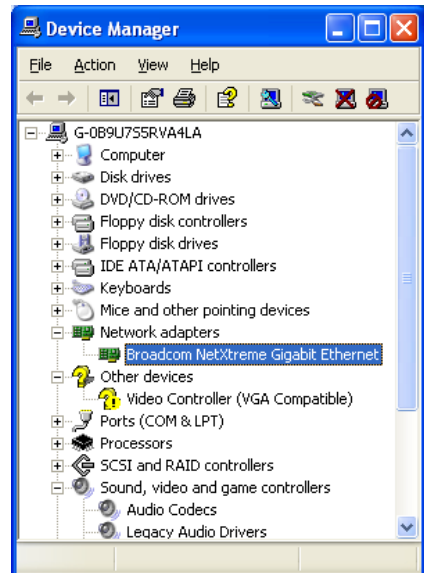

7. Check [Device Manager] again. [Broadcom NetXtreme Gigabit Ethernet] is successfully upgraded.

---

## Appendix E. Install SiS USB 2.0 Driver

---

### For Windows XP:

1. Make sure your system is connected to Internet.
2. Link to Microsoft Windows XP SP1 download page at <http://www.microsoft.com/WindowsXP/pro/downloads/servicepacks/sp1/default.asp>.
3. Click [Network Installation] in “Installing SP1 on Multiple Computers” column. (You can choose [Express Installation] in “Installing SP1 on Your Computer” column, if you don’t want to download full SP1 file.)
4. Select your language and click [Go] button.
5. Click [SP1 Network Installation (32-Bit)] to start downloading Windows XP SP1.
6. After download finished, execute the SP1 file to update your Windows.
7. After Windows update finish, click [Start] → [Control Panel].
8. Double click [System].
9. Select [Hardware] tab and click [Device Manager].
10. Right click on [Universal Serial Bus (USB) Controller] and click [Update Driver...].
11. Click [Next]. The system will search and install USB 2.0 driver automatically.

### For Window 2000:

The installation procedures and screen shots in this section are based on Windows 2000 operating system. For those of other OS, please follow its on-screen instruction.

Insert the Driver & Utility CD into CD-ROM drive, it should execute the installation program automatically. If not, double-click the execution file at the main directory of this CD to enter the installation menu.

After entering the installation menu, move your cursor to [Driver] tab. Click [USB 2.0 Driver]. The following screen appears.

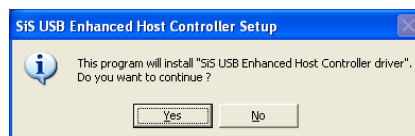

1. Click [Yes].

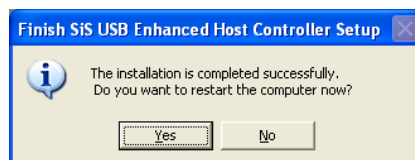

2. Click [Yes].



## Appendix F. Install Serial ATA RAID Driver

The installation procedures and screen shots in this section are based on Windows XP operating system. For those of other OS, please follow its on-screen instruction.

Insert the Driver & Utility CD into CD-ROM drive, it should execute the installation program automatically. If not, double-click the execution file at the main directory of this CD to enter the installation menu.

After entering the installation menu, move your cursor to [Driver] tab. Click [Serial ATA RAID Driver]. The following screen appears.

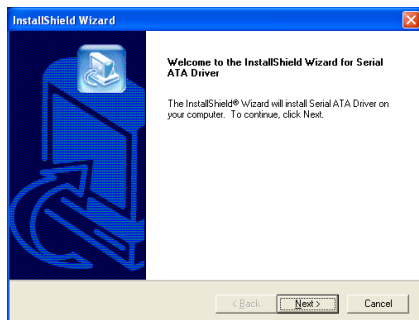

1. Click [Next].



2. Click [Yes].

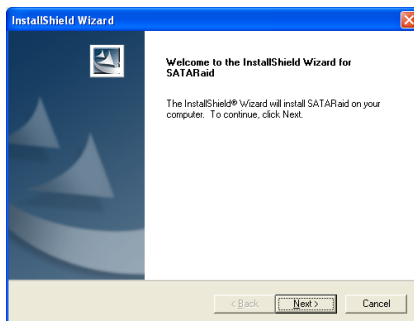

3. Click [Next].

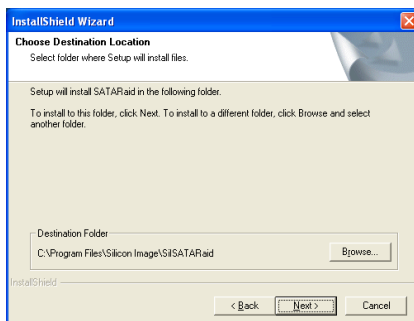

4. Click [Next].

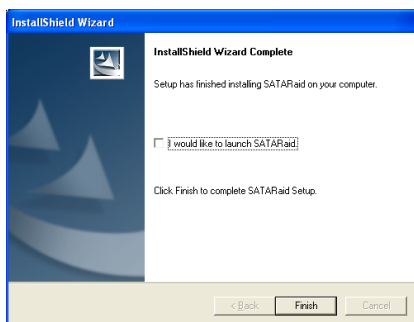

5. Click [Next].

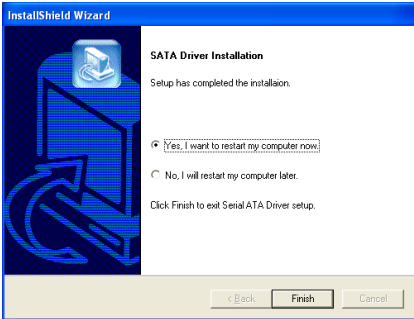

6. Choose [Yes, I want to restart my computer now.], and click [Finish] to complete setup.

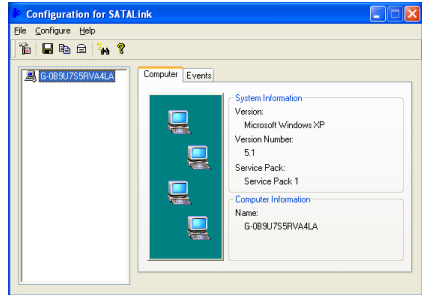

9. This is the SATA Link configuration menu. For more information on how to operate, please refer to the “Help” menu.



7. Check [Device Manager]. [Silicon Image SiI 3112 SATA RAID Controller] is successfully installed.

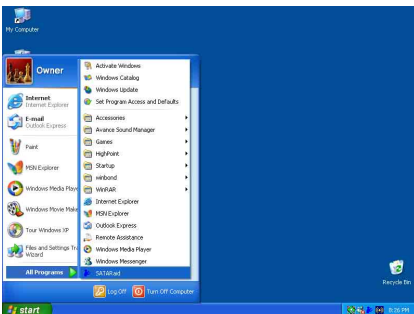

8. To run the [SATA RAID] application, click [Start] → [All Programs] → [SATA RAID].

## BIOS Setup for Serial ATA RAID

The SI7/SI7-G supports Striped (RAID 0) and Mirrored (RAID 1) RAID set. For the striped RAID set, the identical drives can read and write data in parallel to increase performance. The Mirrored RAID set creates a complete backup of your files. Striped and Mirrored RAID set requires 2 hard disks to do so.

## RAID Configuration Utility Menu

### Main Menu

Reboot your system. Press **<CTRL> + <S>** or **<F4>** key while booting up the system to enter the BIOS setting menu. The main menu of BIOS Setting Utility appears as shown below:

RAID Configuration Utility - Silicon Image Inc. Copyright (C) 2002			
Create RAID set Delete RAID set Rebuild Mirrored set Resolve Conflicts			
* 0	PM	Master 33073H3	29312MB
1	SM	Master 33073H3	29312MB
		TL	Select Menu
		ESC	Previous Menu
		Enter	Select
		Ctrl-E	Exit
		*	First HDD

To select the option in this menu, you may:

- Press **<↑ ↓>** (up, down arrow) to choose the option you want to confirm or to modify.
- Press **<Enter>** to confirm the selection.
- Press **<Esc>** to return to previous menu.
- Press **<Ctrl-E>** to exit the RAID configuration utility.

**NOTE:** If you want to create a RAID 0 (striping) array, all the data stored in the hard disks will first be erased! Please backup the hard disk data before starting to create the RAID array.

If you want to create a RAID 1 (mirroring) array, please make sure which hard disk is the source disk and which one is the destination disk. If you make a mistake, you may copy the blank data to the source disk, which will result in both hard disks becoming blank!

### Option 1 Create RAID set

This item allows you to create a RAID array.

After you had selected the function from the main menu, press the **<Enter>** key to enter the sub menu as shown below:

RAID Configuration Utility - Silicon Image Inc. Copyright (C) 2002			
Create RAID set Delete RAID set Rebuild Mirrored set Resolve Conflicts		Striped Mirrored	
* 0	PM	Master 33073H3	29312MB
1	SM	Master 33073H3	29312MB
		TL	Select Menu
		ESC	Previous Menu
		Enter	Select
		Ctrl-E	Exit
		*	First HDD

- **Array Mode:**

This item allows you to select the appropriate RAID mode for the desired array. There are two modes to choose. When you choose a “Striped” or “Mirrored” RAID set, the utility will ask “Are You Sure?” before the Creating RAID process. Press **<Y>** to confirm.

**NOTE:** It is highly recommended to attach hard disks with the same model in reaching the RAID performance.

**Striping (RAID 0):** This item is recommended for **high performance** usage. Requires at least 2 disks.

**Mirror (RAID 1):** This item is recommended for **data security** usage. Requires at least 2 disks.

**Option 2  
Delete RAID set**

This item allows you to remove a RAID Array on this onboard Serial ATA RAID controller.

**NOTE:** After you have made and confirmed this selection, all the data stored in the hard disk will be lost. (The entire partition configuration will be deleted too.)

**Option 3  
Rebuild Mirrored set**

This item allows you to rebuild only “Mirrored” RAID set.

You need to check which hard disk is the source disk and which one is the destination disk when you decide to rebuild mirrored RAID set.

**Option 4  
Resolve Conflicts**

When a RAID set is created, the metadata written to the disk includes drive connection information (Primary Channel, Secondary Channel).

If, after a disk failure, the replacement disk was previously part of a RAID set (or used in another system), it may have conflicting metadata, specifically in reference to the drive connection information. If so, this will prohibit the RAID set from being either created or rebuilt.

In order for the RAID set to function properly, this old metadata must be first overwritten with the new metadata. To resolve this, select “Resolve Conflict”. The correct metadata, including the correct drive connection information; will then be written to the replacement disk.

**NOTE:** For more information on RAID function, please refer to the RAID Management Software enclosed in the CD that came packed with this motherboard.



## Appendix G. BIOS Update Guide

The procedure illustrated here is based on the model SX7-533 as an example; all other models follow the same process.

1. First, find out the model name and version number of this motherboard. You can find a bar-code sticker typed with model name and version number on motherboard PCB.
2. Find out the current BIOS ID. For example, in this case, the current BIOS ID is [89]. If you already have the latest BIOS, no any update action is necessary. If your BIOS is not the latest BIOS, go on to the next step.

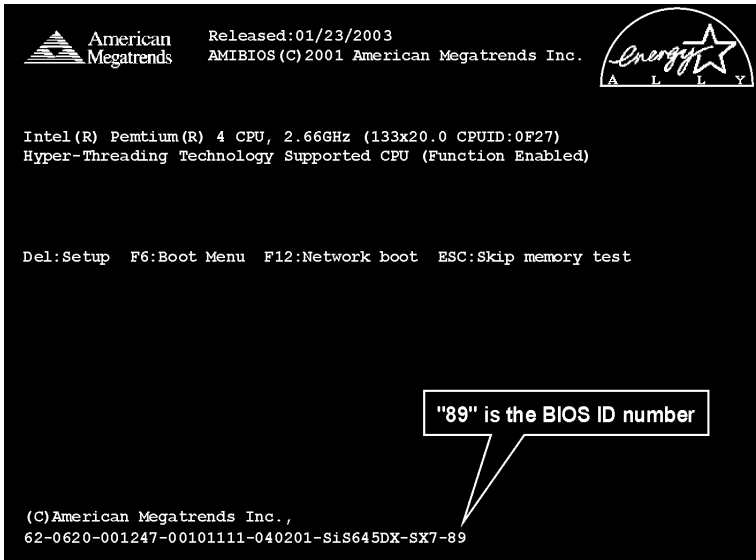

3. Download the correct BIOS file from our Web site.
4. Double click the downloaded file, it will self-extract to [amiflash.exe] and [\*rom] files.
5. Make a bootable floppy disk and copy the necessary files onto it. You may make a floppy disk bootable either in Explorer or in the DOS prompt mode.

```
[c:\]format a: /s
```

After formatting and transferring the system to the floppy disk, copy two files into it. One is the BIOS flash utility [amiflash.exe] and the other is the decompressed BIOS binary [\*rom] file.

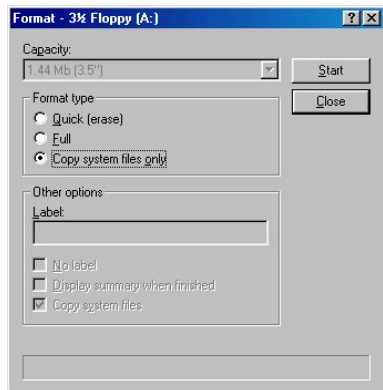

6. Please set the first boot sequence as “**Floppy**” in BIOS and boot off the floppy disk.

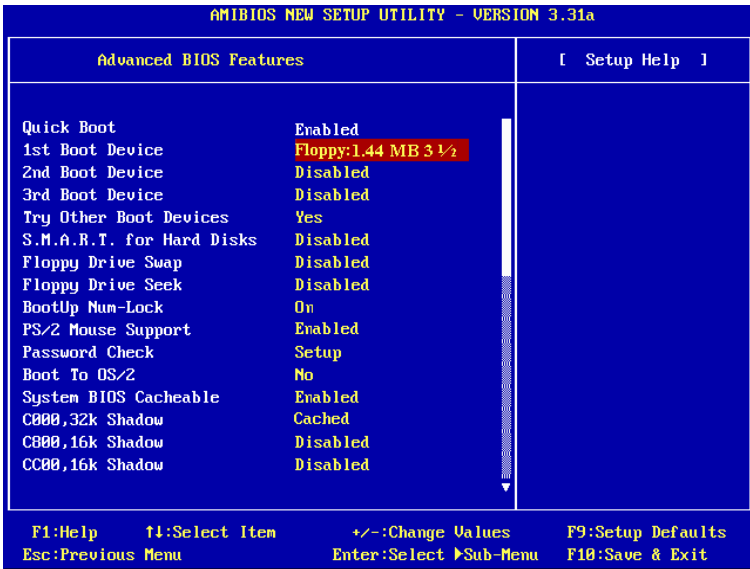

7. Flash the BIOS in pure DOS mode.

```
A:\>amiflash sx7_89.rom
```

8. When the flash process is complete, you can see the completed message that will ask you to restart your system

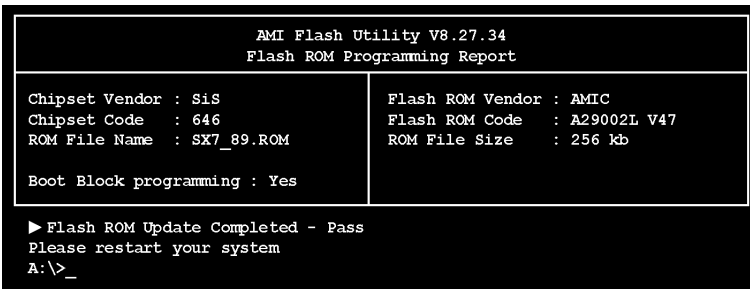

#### Note

- The AMI flash utility cannot be completed under the Windows environment. It must be done in a pure DOS environment.
- You should check which BIOS file is to be used with your motherboard, don't flash with the wrong BIOS file. Otherwise, it may cause system malfunctions.

## Appendix H. Hardware Monitoring (The Winbond Hardware Doctor Utility)

The Winbond Hardware Doctor is a self-diagnostic system for PCs. It protects PC hardware by monitoring several critical items including power supply voltages, CPU & system fan speeds and CPU and system temperatures. These items are important for the system operation. Errors may result in permanent damage to the PC. Once any item is out of its normal range, a warning message pops up reminding you to take proper measures.

The installation procedures and screen shots in this section are based on Windows XP operating system. For those of other OS, please follow its on-screen instruction.

Insert the Driver & Utility CD into CD-ROM drive, it should execute the installation program automatically. If not, double-click the execution file at the main directory of this CD to enter the installation menu.

After entering the installation menu, move your cursor to [Hardware Doctor] tab. Click [Hardware Doctor]. The following screen appears.

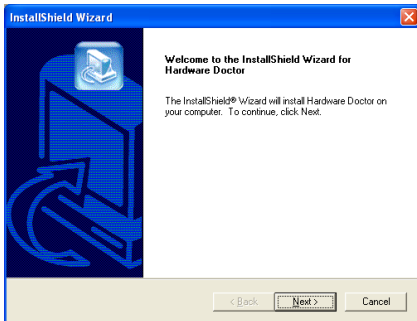

1. Click [Next].

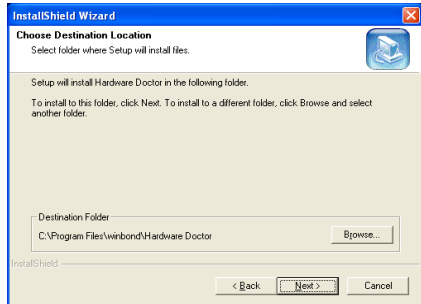

2. Click [Next].

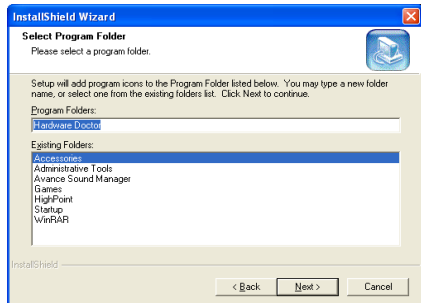

3. Click [Next].

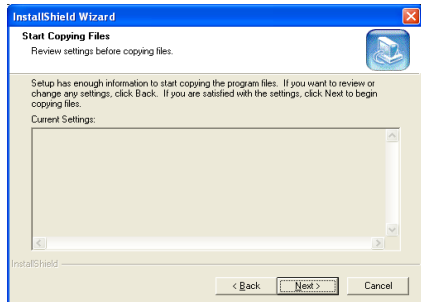

4. Click [Next].

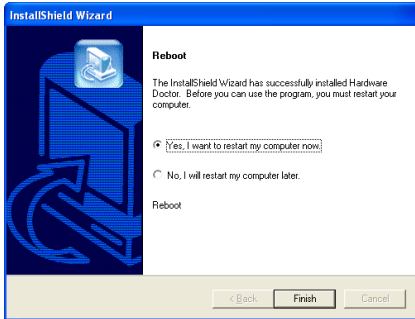

5. Choose [Yes, I want to restart my computer now.] and click [Finish] to complete setup.

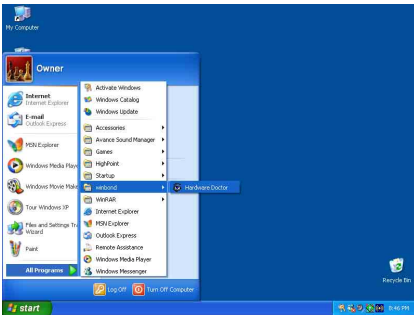

6. Execute the Hardware Doctor by entering the Windows Menu [Start] → [Programs] → [Winbond] → [Hardware Doctor].

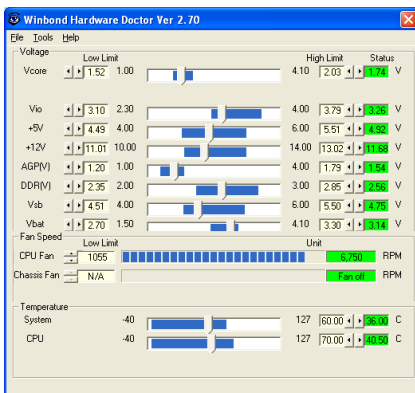

7. This screen appears. Hardware Doctor shows you the status of Voltage, Fan Speed, and Temperature readings as well. If any reading is critical or over its limitation, the reading turns

red. Also, a pop-up window appears warning you the system has a problem!



8. This is the warning message window:

**Ignore:** You can ignore the warning message of the item, but it will pop up again when an error of the same item reoccurs.

**Disable:** The chosen item will be no longer monitored thereafter, unless you activate it in the “**Configuration**” page.

**Shutdown:** Choosing this button will shutdown the computer.

**Help:** You can read more information and self-diagnose simple problems.

If the warning message pops up due to the wrong warning limit, you can adjust it in the “**Configuration**” option. For example, if you set the temperature high limit to 40°C, you will easily exceed the “proper” temperature.

Pay attention to two things when you want to make any change to the “**Configuration**” option. Firstly, you have to make sure your new setting is in the proper range. Secondly, after you finished the configuration, you have to save it. Otherwise, the program will start with the default value next time.

If you encounter any problem or have any question about the software settings and adjustments, please use the Winbond hardware doctor on-line help. It should give you enough information to answer your questions.

## Appendix I. Installation Guide for Suspend to RAM

Suspend To RAM (STR) is a cost-effective, optimal implementation of the ACPI 1.0 specification. The ACPI specification defines the S3 sleep state, in which all system context is lost except system memory. CPU, cache, and chip set context are lost in this state. Hardware maintains memory context and restores some CPU and L2 configuration context.

The STR function enables a PC to achieve the S3 state during idle periods, then quick “wake up” and retrieve the last “state” of the system before it went to sleep. When idle, STR-enabled systems consume only a small fraction of the power used for full operation. Instead of shutting down the system to save power when not in use and then having to reboot later, users can let the STR function take over and not have to worry about using power to run all the electronics, fans and disks. When needed, a PC with STR function can restore all applications and features to an operational state within a few seconds.

The following description will tell you how to install the STR function and to use it.

After the operating system had been installed successfully, reboot your computer, you can see these ACPI items show up in the “*Device Manager*” menu by entering *Start* → *Settings* → *Control Panel* → *System* → *System Properties* → *Hardware*:

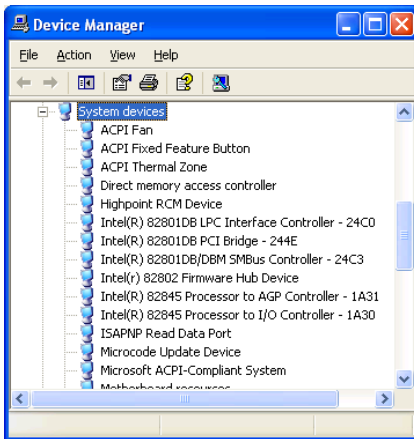

## How to use the STR function:

There are two ways to put your system into STR mode:

**Method 1:** Select [Stand by] in the [Turn Off Computer...] area.



1. Click [Start] in the Windows Tools Bar, and then select [Turn Off Computer...]

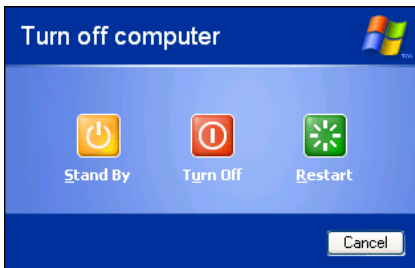

2. Click [Stand by].

**Method 2:** Define the chassis's [Power] button to initiate STR sleep Mode



1. Open [Control Panel], and then enter [Power Options].

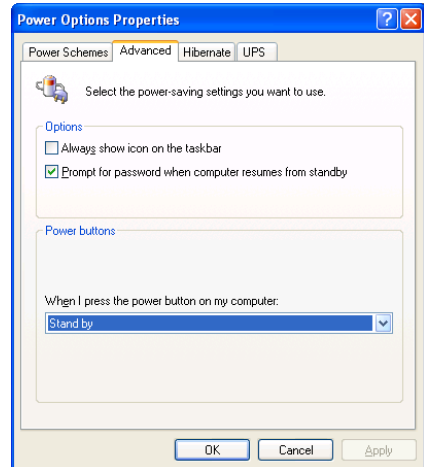

2. Select [Advanced] tab. Set the [Power Buttons] option to [Stand by].

Restart your computer to put these settings into effect. Now you will only need to press the [Power] button on the front panel of the chassis when you want to put your computer into STR sleep mode.

---

## Appendix J. Troubleshooting (Need Assistance?)

---

### Motherboard Troubleshooting:

#### Q & A:

**Q: Do I need to clear the CMOS before I use a new motherboard to assemble my new computer system?**

A: Yes, we highly recommend that you clear the CMOS before installing a new motherboard. Please move the CMOS jumper from its default 1-2 position to 2-3 for a few seconds, and then back. When you boot up your system for the first time, follow the instructions in the user's manual to load the optimized defaults.

**Q: If my systems hang when I update the BIOS or set the wrong CPU parameters, what should I do?**

A: Whenever you update the BIOS or if the system hangs due to wrong CPU parameters setting, always clear CMOS jumper before booting up again.

**Q: Why the system failed to boot up and nothing was displayed on the screen after I did some over-clocking or non-standard settings inside the BIOS? Is the motherboard dead? Do I need to return it to where I bought from or go through an RMA process?**

A: It should not cause hardware or permanent damage to motherboard when BIOS settings were changed from default to over-clocking or non-standard status.

We suggest the following three troubleshooting methods to discharge CMOS data, recover the hardware default status, and then make the motherboard working again. No need to bother returning the motherboard to where you bought from or go through an RMA process.

**Step 1.** Switch off the power supply unit and then switch it on again after one minute. If there is no power switch on the power supply unit, disconnect its power cord for one minute and then connect it back.

Press and hold the <Insert> key on the keyboard, press the power-on button to boot up system. If it works, loose the <Insert> key and hit <Del> key to enter the BIOS setup page to do the correct settings.

If the situation remains the same, repeat the procedures in Step 1 for three times, or try Step 2.

**Step 2.** Switch off the power supply unit or disconnect the power cord. Open the chassis cover. Locate the CCMOS jumper near the button battery. Change the jumper position from default 1-2 to 2-3 for one minute to discharge the CMOS data, and then put it back to default 1-2 position.

Close the chassis and switch on the power supply unit or plug in the power cord. Press the power-on button to boot up system. If it works, hit <Del> key to enter the BIOS setup page to do the correct settings.

If the situation remains the same, try Step 3.

**Step 3.** The same procedure as Step 2, but in the meantime of discharging the CMOS data, pull out ATX power connectors from motherboard and remove the button battery during CMOS discharging.

**Q: How can I get a quick response to my request for technical support?**

A: Be sure to follow the guidelines as stated in the “Technical Support Form” section of this manual.

If you have a problem during operation, in order to help our technical support personnel quickly determine the problem with your motherboard and give you the answers you need, before filling in the technical support form, eliminate any peripheral that is not related to the problem, and indicate it on the form. Fax this form to your dealer or to the company where you bought the hardware in order to benefit from our technical support. (You can refer to the examples given below)

**Example 1:**

With a system including: motherboard (with CPU, DRAM, COAST...) HDD, CD-ROM, FDD, VGA CARD, MPEG CARD, SCSI CARD, SOUND CARD, etc. After the system is assembled, if you cannot boot up, check the key components of the system using the procedure described below. First remove all interface cards except the VGA card and try to reboot.

**If you still cannot boot up:** Try installing another brand/model VGA card and see if the system will start. If it still does not start, note the VGA card model, motherboard model, Bios identification number, CPU on the technical support form (refer to main instructions), and describe the problem in the problem description space provided.

**If you can boot up:** Insert the interface cards you have removed back into the system, one by one and try to start the system each time you insert a card, until the system will not start. Keep the VGA card and the interface card that caused the problem inserted on the motherboard, remove any other cards or peripheral, and start again. If you still cannot start, note the information related to both cards in the add-on Card space provided, and don't forget to indicate the motherboard model, version, BIOS identification number, CPU (refer to main instructions), and give a description of the problem.

**Example 2:**

With a system including the motherboard (with CPU, DRAM, COAST...) HDD, CD-ROM, FDD, VGA CARD, LAN CARD, MPEG CARD, SCSI CARD, SOUND CARD, after assembly and after having installed the Sound Card Driver, when you restart the system, when it runs the Sound Card Driver, it resets automatically. This problem may be due to the Sound Card Driver. During the Starting DOS... procedure, press SHIFT (BY-PASS) key, to skip CONFIG.SYS and AUTOEXEC.BAT; edit CONFIG.SYS with a text editor, and in function the line that loads the Sound Card Driver, add a remark REM, in order to disable the Sound Card Driver. See the example below.

```
CONFIG.SYS:
DEVICE=C:\DOS\HIMEM.SYS
DEVICE=C:\DOS\EMM386.EXE HIGHSCAN
DOS=HIGH, UMB
FILES=40
BUFFERS=36
REM DEVICEHIGH=C:\PLUGPLAY\DWCFMG.MSYS
LASTDRIVE=Z
```

Restart the system. If the system starts and does not reset, you can be sure that the problem is due to the Sound Card Driver. Write down the Sound Card model, motherboard model, BIOS identification number on the technical support file (refer to main instructions), and describe the problem in the space provided.

We will show you how to fill the “**Technical Support Form**”.



**Main instructions:**

To fill in this “**Technical Support Form**”, refer to the step-by-step instructions given below:

- 1\* **MODEL:** Note the model number given in your user’s manual.  
Example: SI7/SI7-G.
- 2\* **Motherboard model number (REV):** Note the motherboard model number labeled on the motherboard as “REV:\*.\*\*\*”.  
Example: REV: 1.01
- 3\* **BIOS ID and Part Number:** See the on screen message.
4. **DRIVER REV:** Note the driver version number indicated on the DEVICE DRIVER disk (if any) as “Release \*.\*\*\*”. For example:

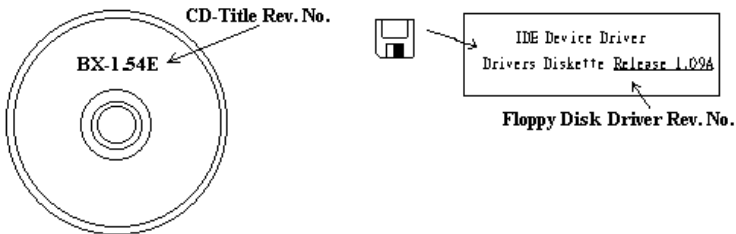

- 5\* **OS/APPLICATION:** Indicate the operating system and applications you are running on the system.  
Example: MS-DOS® 6.22, Windows® 98 SE, Windows® 2000, etc...
- 6\* **CPU:** Indicate the brand and the speed (MHz) of your CPU.  
Example:(A) In the “Brand” space, write “Intel”; in the “Specifications” space, write “Pentium® 4 1.9GHz”.
7. **HDD:** Indicate the brand and specifications of your HDD(s); specify if the HDD is using IDE1 or IDE2. If you know the disk capacity, indicate it and check (“✓”) “”; in case you give no indication, we will consider that your HDD is “IDE1” Master.  
Example: In the “HDD” space, check the box; in the Brand space, write “Seagate”; in the Specifications space, write “ST31621A (1.6GB)”.
8. **CD-ROM Drive:** Indicate the brand and specifications of your CD-ROM drive. Specify if it uses IDE1 or IDE2 , and check (“✓”) “”; in case you give no indication, we will consider that your CD-ROM is “IDE2” Master.  
Example: In the “CD-ROM drive” space, check the box, in the Brand space, write “Mitsumi”, in the Specifications space, write “FX-400D”.
9. **System Memory (DDR SDRAM):** Indicate the brand and specifications (DDR DIMM) of your system memory. Such as Density, Description, Module Components, Module Part Number, CAS Latency, and Speed (MHz).  
For example: In the Brand space, write “**Micron**”; in the Specifications space, write: **Density:** 128MB, **Description:** SS 16 Megx72 2.5V ECC Gold, **Module Components:** (9) 16 Megx 8, **Module Part Number:** MT9VDDT1672AG, **CAS Latency:** 2, **Speed (MHz):** 200 MHz.

Please give us the detailed information of your DDR SDRAM module; it will help us to simulate the problems you met.

- 10. ADD-ON CARD:** Indicate which add-on cards you are *absolutely sure* are related to the problem. If you cannot identify the problem's origin, indicate all the add-on cards inserted into your system.

**NOTE:** Items between the “\*\*” are absolutely necessary.

## RAID Troubleshooting

### Q & A:

**Q: May I use hard drives with different capacity or transfer mode?**

A: In order to get optimized performance, we suggest using hard drives with the same model.

**Q: How to assign a booting device?**

A: You may press <Ctrl> <H> to assign a booting device in RAID BIOS (See Appendix G for detailed information).

**Q: Why can't I see correct capacity in FDISK utility?**

A: It's a well-known issue of Windows® 95/98's FDISK utility. If an IBM 75GB hard disk DTLA 307075 only gets 7768MB in Windows® 95/98's FDISK utility, please contact Microsoft® for a latest version of FDISK utility or download IBM's Disk Manager DiskGo! 2.5 to fix it. For windows® 2000, there is no such a 64GB issue.

<http://www.storage.ibm.com/techsup/hddtech/welcome.htm>

**Q: How to create a striping and mirror array (RAID 0+1)?**

A: You need four HDD drives, every two of them on the same channel/cable build a striping array. Then create a mirror array by these two striping arrays (See Appendix G for detailed information).

1. Press <Ctrl> <H> to setup configuration
2. Choose item 1 to Create RAID.
3. Choose item 1 to set Array Mode as Striping and Mirror (RAID 0+1).
4. Choose item 2 to Select Disk Drives. There are two striping arrays built automatically and you only have to enter twice.
5. Choose item 4 to Start Creation Process.
6. Press <Esc> to finish setting and leave RAID BIOS.

**Q: How to rebuild a mirror array when one of the drives corrupts?**

A: You need to delete previous array setting, duplicate the data, and then rebuild a new array setting (See Appendix G for detailed information).

1. Press <Ctrl> <H> to setup configuration
2. Choose item 2 to Delete Array.
3. Choose item 3 to Rebuild Mirror Array.
4. Choose sub item 1 to Select Source Disk, the one with data on it.
5. Choose sub item 2 to Select Target Disk, the brand new and empty one.
6. Choose sub item 3 to Start Duplication Process.
7. After duplication process completes, press <Esc> to leave RAID BIOS.

**Q: Why I see “NO ROM BASIC SYSTEM HALTED” when booting?**

A: There isn't any activated primary partition in you system. Please use FDISK or any other utilities to create/set one.

**Do & Don't:**

1. **Do** always use the same model drives to achieve best quality and performance. Different firmware has different timing characteristic, thus may somewhat decrease the RAID performance.
2. If you have two drives, do connect them on two different channels as master drive please.
3. When attach drives to the RAID card, do make sure the master/slave jumper settings are correct please. If there is only one drive on one channel/cable, do set it as master or single drive.
4. **Do** always use 80 conductor cables please.
5. **Don't** connect any ATAPI devices (CD-ROM, LS-120, MO, ZIP, removable HD etc.) on the RAID card please.
6. For the best performance result, please do use the Ultra DMA 66/100 Hard Disks.



---

## Appendix K. How to Get Technical Support

---

(From our website) <http://www.abit.com.tw>

(In North America) <http://www.abit-usa.com>

(In Europe) <http://www.abit.nl>

Thank you for choosing ABIT products. ABIT sells all our products through distributors, resellers and system integrators; we have no direct sales to end-users. Before sending email for tech support please check with your resellers or integrators if you need any services, they are the ones who sold you your system and they should know best as to what can be done, how they serve you is a good reference for future purchases.

We appreciate every customer and would like to provide the best service to you. Providing fast service to our customers is our top priority. However we receive many phone calls and a huge amount of email from all over the world. At the present time it is impossible for us to respond to every single inquiry. Therefore it is quite possible that if you send an email to us that you may not receive a response.

We have done many compatibility tests and reliability tests to make sure our products have the best quality and compatibility. In case you need service or technical support, please understand the constraint we have and **always check with the reseller who sold the product to you first.**

To expedite service, we recommend that you follow the procedures outlined below before contacting us. With your help, we can meet our commitment to provide the best service to the **greatest number of ABIT customers:**

- 1. Check the Manual.** It sounds simple but we have taken a lot of care in making a well-written and thorough manual. It is full of information that doesn't only pertain to motherboards. The CD-ROM included with your board will have the manual as well as drivers. If you don't have either one, go to our Program Download Area of the Website or FTP server.
- 2. Download latest BIOS, software or drivers.** Please go to our Program Download area on our Website to check to see if you have the latest BIOS. They are developed over periods of time to fix bugs or incompatibilities. **Also please make sure you have the latest drivers from your peripheral cards makers!**
- 3. Check the ABIT Technical Terms Guide and FAQ on our Website.** We are trying to expand and make the FAQs more helpful and information rich. Let us know if you have any suggestions. For hot topics check out our HOT FAQ!

4. **Internet Newsgroups.** They are a great source of information and many people there can offer help. ABIT's Internet News group, [alt.comp.periphs.mainboard.abit](http://alt.comp.periphs.mainboard.abit), is an ideal forum for the public to exchange information and discuss experiences they have had with ABIT products. Many times you will see that your question has already been asked before. This is a public Internet news group and it is reserved for free discussions. Here is a list of some of the more popular ones:

[alt.comp.periphs.mainboard.abit](http://alt.comp.periphs.mainboard.abit)  
[comp.sys.ibm.pc.hardware.chips](http://comp.sys.ibm.pc.hardware.chips)  
[alt.comp.hardware.overclocking](http://alt.comp.hardware.overclocking)  
[alt.comp.hardware.homebuilt](http://alt.comp.hardware.homebuilt)  
[alt.comp.hardware.pc-homebuilt](http://alt.comp.hardware.pc-homebuilt)

5. **Ask your reseller.** Your ABIT authorized distributor should be able to provide the fastest solution to your technical problem. We sell our products through distributors who sell to resellers and stores. Your reseller should be very familiar with your system configuration and should be able to solve your problem much more efficiently than we could. After all, your reseller regards you as an important customer who may purchase more products and who can urge your friends to buy from him or her as well. They integrated and sold the system to you. They should know best what your system configuration is and your problem. They should have reasonable return or refund policies. How they serve you is also a good reference for your next purchase.
6. **Contacting ABIT.** If you feel that you need to contact ABIT directly you can send email to the ABIT technical support department. First, please contact the support team for the branch office closest to you. They will be more familiar with local conditions and problems and will have better insight as to which resellers offer what products and services. Due to the huge number of emails coming in every day and other reasons, such as the time required for problem reproduction, we will not be able to reply to every email. Please understand that we are selling through distribution channels and don't have the resources to serve every end-user. However, we will try to do our best to help every customer. Please also remember that for many of our technical support team English is a second language, you will have a better chance of getting a helpful answer if your question can be understood in the first place. Be sure to use very, simple, concise language that clearly states the problem, avoid rambling or flowery language and always list your system components. Here is the contact information for our branch offices:

**North America and South America:**

**ABIT Computer (U.S.A.) Corporation**

45531 Northport Loop West,  
Fremont, California 94538, U.S.A.

Tel: 1-510-623-0500

Fax: 1-510-623-1092

[sales@abit-usa.com](mailto:sales@abit-usa.com)

[technical@abit-usa.com](mailto:technical@abit-usa.com)

**Germany, Benelux (Belgium, Netherlands, Luxembourg), Denmark, Norway, Sweden, Finland, and Switzerland:**

**AMOR Computer B.V. (ABIT's European Office)**

Van Coehoornstraat 7,  
5916 PH Venlo, The Netherlands

Tel: 31-77-3204428

Fax: 31-77-3204420

[sales@abit.nl](mailto:sales@abit.nl)

[technical@abit.nl](mailto:technical@abit.nl)

**Japan:**

**ABIT Computer (Japan) Co. Ltd.**

Fax: 81-3-5396-5110

<http://www.abit4u.jp>

**Russia:**

**ABIT Computer (Russia) Corporation Ltd.**

Fax: 7 (095) 937 8237

<http://www.abit.ru>

**U.K. and Ireland:**

**ABIT Computer (U.K.) Corporation Ltd.**

Unit 3, 24-26 Boulton Road,  
Stevenage, Herts SG1 4QX, U.K.

Tel: 44-1438-228888

Fax: 44-1438-226333

[sales@abitcomputer.co.uk](mailto:sales@abitcomputer.co.uk)

[technical@abitcomputer.co.uk](mailto:technical@abitcomputer.co.uk)

**Austria, Czech, Romania, Bulgaria, Yugoslavia, Slovakia, Slovenia, Croatia, Bosnia and Serbia:**

**Asguard Computer Ges.m.b.H**

Schmalbachstrasse 5,  
A-2201 Gerasdorf/wien, Austria

Tel: 43-1-7346709

Fax: 43-1-7346713

[asguard@asguard.at](mailto:asguard@asguard.at)

**Shanghai:**

**ABIT Computer (Shanghai) Co. Ltd.**

Tel: 86-21-6235-1829

Fax: 86-21-6235-1832

<http://www.abit.com.cn>

**France:**

**ABIT Computer France SARL**

4, Place La Defense,  
92974 Paris La Defense cedex, France

Fax: 33-1-5858-0047

<http://www.abit.com.tw>

**All other territories not covered above please contact Taiwan Head Office:**

When contacting our headquarters please Note we are located in Taiwan and we are 8+ GMT time. In addition, we have holidays that may be different from those in your country.

**ABIT Computer Corporation**

No.323, YangGuang St., Neihsu, Taipei, 114, Taiwan

Tel: 886-2-8751-8888

Fax: 886-2-8751-3381

[sales@abit.com.tw](mailto:sales@abit.com.tw)

[market@abit.com.tw](mailto:market@abit.com.tw)

[technical@abit.com.tw](mailto:technical@abit.com.tw)

<http://www.abit.com.tw>

7. **RMA Service.** If your system has been working but it just stopped, but you have not installed any new software or hardware recently, it is likely that you have a defective component. Please contact the reseller from whom you bought the product. You should be able to get RMA service there.
8. **Reporting Compatibility Problems to ABIT.** Because of tremendous number of email messages we receive every day, we are forced to give greater weight to certain types of messages than to others. For this reason, any compatibility problem that is reported to us, giving detailed system configuration information and error symptoms will receive the highest priority. For the other questions, we regret that we may not be able to reply directly. But your questions may be posted to the Internet news group in order that a larger number of users can have the benefit of the information. Please check the news group from time to time.
9. The information listed below are some **chipset vendors' WEB site addresses** for your reference:

HighPoint Technology Inc.'s WEB site: <http://www.highpoint-tech.com/>

Intel's WEB site: <http://www.intel.com/>

Silicon Image's WEB site: <http://www.siimage.com/>

SiS' WEB site: <http://www.sis.com.tw/>

VIA's WEB site: <http://www.via.com.tw/>

**Thank You**

**ABIT Computer Corporation**

**<http://www.abit.com.tw>**



## Free Manuals Download Website

<http://myh66.com>

<http://usermanuals.us>

<http://www.somanuals.com>

<http://www.4manuals.cc>

<http://www.manual-lib.com>

<http://www.404manual.com>

<http://www.luxmanual.com>

<http://aubethermostatmanual.com>

Golf course search by state

<http://golfingnear.com>

Email search by domain

<http://emailbydomain.com>

Auto manuals search

<http://auto.somanuals.com>

TV manuals search

<http://tv.somanuals.com>